

V2
FINAL
FOR PRINT

DX-WBRDVD1_11-0150_MAN_V1.fm Page 1 Monday, April 4, 2011 1:08 PM

DYNE X TM ● ● ●

Wireless Blu-ray Disc Player

DX-WBRDVD1/DX-WBRDVD1-CA

USER GUIDE

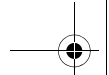

Wireless Blu-ray Disc Player DX-WBRDVD1/DX-WBRDVD1-CA

Contents

Important safety instructions.....	3
Introduction.....	5
Features	5
Setting up your player.....	11
Using your player	17
Using the Settings menu.....	24
Upgrading your player's firmware	43
Maintaining	45
FAQ (frequently asked questions).....	47
Troubleshooting	47
Specifications.....	51
Legal notices	53
One-year limited warranty.....	57

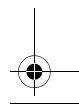
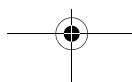
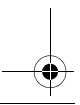
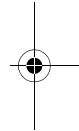
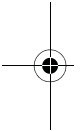



CAUTION
RISK OF ELECTRIC SHOCK
DO NOT OPEN



The lightning flash with arrowhead symbol within an equilateral triangle is intended to alert you to the presence of uninsulated dangerous voltage within your player's enclosure that may be of sufficient magnitude to constitute a risk of electric shock to persons.



The exclamation point within an equilateral triangle is intended to alert you to the presence of important operating and maintenance (servicing) instructions in the literature that came with your player.



This symbol is the symbol for CLASS II (Double Insulation).

Warning:

- Your player employs a laser system.
- Use of controls, adjustments, or the performance of procedures other than those specified may result in hazardous radiation exposure.
- Visible laser radiation is present when open and interlocks defeated. Do not stare into the beam.



Disposal of your old appliance:

1. When this crossed-out wheeled bin symbol is attached to a product, it means the product is covered by the European Directive 2002/96/EC.
2. All electrical and electronic products should be disposed of separately from the municipal waste stream via designated collection facilities appointed by the government or the local authorities.
3. The correct disposal of your old appliance will help prevent potential negative consequences for the environment and human health.
4. For more detailed information about disposal of your old appliance, please contact your city office, waste disposal service, or the shop where you purchased the product.

Important safety instructions

- 1 Read these instructions.
- 2 Keep these instructions.



- 3 Heed all warnings.
- 4 Follow all instructions.
- 5 Do not use this apparatus near water.
- 6 Clean only with a dry cloth.
- 7 Do not block any ventilation openings. Install in accordance with the manufacturer's instructions.
- 8 Do not install near any heat sources such as radiators, heat registers, stoves, or other apparatus (including amplifiers) that produce heat.
- 9 Do not defeat the safety purpose of the polarized or grounding-type plug. A polarized plug has two blades with one wider than the other. A grounding type plug has two blades and a third grounding prong. The wide blade or the third prong are provided for your safety. If the provided plug does not fit into your outlet, consult an electrician for replacement of the obsolete outlet.
- 10 Protect the power cord from being walked on or pinched particularly at plugs, convenience receptacles, and the point where they exit from the apparatus.
- 11 Only use attachments/accessories specified by the manufacturer.
- 12 Use only with the cart, stand, tripod, bracket, or table specified by the manufacturer, or sold with the apparatus. When a cart is used, use caution when moving the cart/apparatus combination to avoid injury from tip-over.
- 13 Unplug this apparatus during lightning storms or when unused for long periods of time.
- 14 Refer all servicing to qualified service personnel. Servicing is required when the apparatus has been damaged in any way, such as power-supply cord or plug is damaged, liquid has been spilled or objects have fallen into the apparatus, the apparatus has been exposed to rain or moisture, does not operate normally, or has been dropped.
- 15 To reduce the risk of fire or electric shock, do not expose this device to rain, moisture, dripping, or splashing, and no objects filled with liquids, such as vases, shall be placed on it.
- 16 An apparatus with a three-prong, grounding-type plug is a Class I apparatus, which needs to be grounded to prevent possible electric shock. Make sure that you connect this Class I device to a grounding-type, three-prong outlet.
- 17 The wall plug is the disconnecting device. The plug must remain readily operable.
- 18 Keep a minimum distance of 4 inches (10cm) around the apparatus for sufficient ventilation.
- 19 Do not install this equipment in a confined space such as book case or similar unit. The ventilation should not be impeded by covering the ventilation openings with items such as newspaper, table-cloths, or curtains.
- 20 Batteries should not be exposed to excessive heat such as sunshine, fire, or the like.



Caution: *Danger of explosion if battery is incorrectly replaced. Replace only with the same or equivalent type.*



Introduction

Congratulations on your purchase of a high-quality Dynex product. Your Wireless Blu-ray Disc Player represents the state of the art in Blu-ray Disc player design and is designed for reliable and trouble-free performance.











Features

- Full high-definition video playback at up to 1080p resolution for an amazing viewing experience.
- Upconversion of standard definition DVDs for enhanced picture quality at up to 1080p over an HDMI connection.
- Rich multi-channel surround sound.
- Easy and simple HDTV connection using a single HDMI cable (cable not included).
- Multiple outputs for connecting your home theater system or amplifier.
- PIP functionality that lets you display primary and secondary video at the same time (if available on the Blu-ray Disc).
- Pop-up menu display without interrupting playback (if available on the Blu-ray Disc).
- HDMI 1080p/fps output (Blu-ray Disc only) that provides smooth playback of video with a frame rate of 24 frames per second (TV must be connected with an HDMI cable and be compatible with 1080p 24 frame).
- WiFi wireless connectivity for ease of connection.
- Deep Color: This BD player is capable of sending “deep” (36-bit) color over HDMI if the TV supports it. Please consult the owner's manual of your TV for more information.
- This player supports inLink, which takes advantage of HDMI's two-way communications to allow for single remote control of any CEC-enabled devices connected with HDMI.

Package contents

- Wireless Blu-ray Disc player
- Remote control
- AAA batteries (2)
- User Guide
- Quick Setup Guide

Playable discs

Disc type	Logo	Disc type	Logo
Blu-ray Disc		DVD+R	
DVD-video (DVD-ROM)		CD-R	
Audio CDs (CDDA)		CD-RW	
DVD-RAM		MP3	MP3
DVD-RW		WMA	
DVD+RW		MPEG4	MPEG4
DVD-R		JPEG	
BD-R	N/A	BD-RE	N/A

Notes:

- Writeable DVD discs (DVD-RW, DVD-R) must be finalized, VR-mode only.
- This Blu-ray disc player supports discs that are compatible with DVD-RAM Standard Version 2.0.
- Playback may not work for some types of discs, or when specific operations, such as angle change and aspect ratio adjustment, are being performed. Information about the disc is written in detail on the box.
- Do not allow the disc to become dirty or scratched. Fingerprints, dirt, dust, scratches, or deposits of cigarette smoke on the recording surface may make it impossible to use the disc for playback.
- CD-R/-RW, DVD-RAM/RW/-R recorded with UDF or ISO9660 format can be played back.
- Windows Media Audio (WMA) files must be written to the disc with a .wma file extension in order to be recognized and played back correctly.
- JPEG picture files must be written to the disc with a .jpeg or .jpg file extension in order to be recognized and played back correctly.

About Blu-ray Discs

The massive storage capacity of a Blu-ray Disc allows a higher standard of picture and audio quality and a wealth of special effects and enhanced features not available on DVDs.

Java



Your player features Java support so you can get the most out of the latest Blu-ray Discs. When a Blu-ray Disc loads, explore the title menu to enjoy such features as interactive menus and BD-Live.

HDMI

HDMI is the only domestic medium capable of transmitting the huge volumes of data required by the high picture resolutions and advanced digital audio codecs that make Blu-ray such an exciting medium.

Playing Blu-ray Discs

Playing Blu-ray Discs are a lot like playing DVDs, except Blu-ray Discs have a higher level of interactivity.

Most of the standard features of DVD playback work the same with Blu-ray Disc playback. The two most common exceptions are:

- **Resume play**—Not available on Blu-ray discs
- **A-B repeat** (playback loop)—Not available on some Blu-ray Discs

Warning: This device emits radio-frequencies, maintain a minimum distance of 8 inches (20cm) from the device while using it.

Front

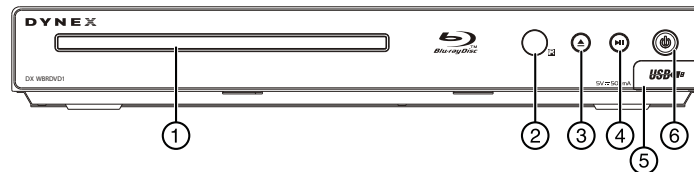

#	Item	Description
①	Disc tray	Insert a disc with the label side up into this tray. To open or close the tray, press ▲ (open/close).
②	Remote control sensor	Receives signals from the remote control. Do not block.
③	▲ (open/close)	Press to open or close the disc tray.

#	Item	Description
④	▶ (play/pause)	Press to start or pause playback.
⑤	USB port	Plug a USB flash drive into this port.
⑥	⏻ (standby/on)	Press to turn on your player or put your player in standby mode. When your player is in standby mode, power is still entering your player. To disconnect power, unplug the power cord.

Back

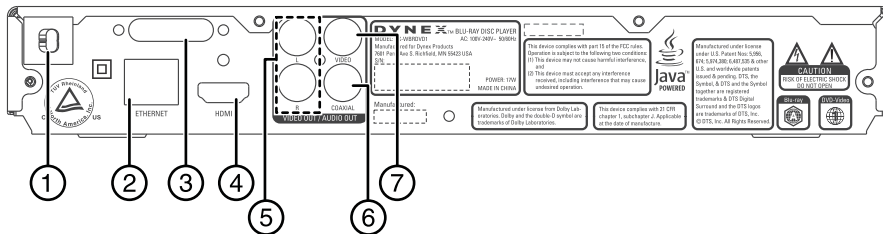

#	Item	Description
①	Power connector	Plug the power cord into a power outlet.
②	ETHERNET jack	Connect an ethernet cable to this jack and to a broadband Internet jack to access BD-Live information or run connected applications.
③	WIFI antenna	Connects the player wirelessly to your wireless network.
④	HDMI OUT	Connect a TV to this jack using an HDMI cable. An HDMI cable carries both video and audio.
⑤	AUDIO OUT L/R	Connect the audio for a composite TV to these jacks.
⑥	COAXIAL DIGITAL OUT	Connect a coaxial digital amplifier to this jack to play the sound through the amplifier's speakers.
⑦	VIDEO OUT	Connect a TV to this jack and to the AUDIO OUT L/R jacks using a composite video cable (provided).

Remote control

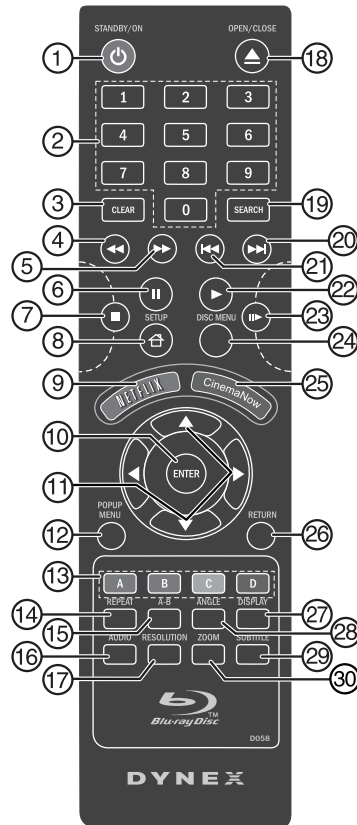

#	Item	Description
①	⏻ STANDBY/ON	Press to turn on your player or put your player in standby mode. When your player is in standby mode, power is still entering your player. To disconnect power, unplug the power cord.
②	Number buttons	In playback mode, press SEARCH , then press the number buttons to enter a title, chapter, track, or time. In menu mode, press to enter numbers.
③	CLEAR	Press to clear an input error.
④	⏮ (fast reverse)	Press to fast reverse. Each time you press this button, the fast-reverse speed increases from Fast x 2, Fast x 4, Fast x 8, Fast x 16, Fast x 32, Fast x 64, Fast x 128. Press ▶ (play) to resume normal playback.

#	Item	Description
⑤	▶▶ (fast forward)	Press to fast forward. Each time you press this button, the fast-forward speed increases from Fast x 2, Fast x 4, Fast x 8, Fast x 16, Fast x 32, Fast x 64, Fast x 128. Press ▶ (play) to resume normal playback.
⑥	⏸ (pause)	Press to pause playback.
⑦	■ (stop)	Press to stop playback. To resume playback, press ◀ ▶ ▲ or ▼ to select DVD/BD-ROM , then press ENTER . Depending on the disc, playback starts where it stopped or at the beginning of the disc. If you press ■ (stop) twice, playback stops completely. To start playback again, press ▶ (play).
⑧	🏠 /SETUP	Press to stop disc playback and enter the home screen. When accessing Connected applications, such as Cinemanow, Pandora, Netflix, or Napster, pressing HOME/SETUP stops the application and returns you to the home screen.
⑨	NETFLIX	Press to access the Netflix application when connected to the Internet.
⑩	ENTER	Press to confirm selection in a menu.
⑪	◀▶▲▼	If a disc menu opens when playing a Blu-ray Disc or DVD, press to select a menu option, then press ENTER . During media file browsing, press to select a file on the popup menu. When a menu is open, press to select an option.
⑫	POPOP MENU	During Blu-ray Disc playback, press to open a menu that lets you control Blu-ray Disc playback. During DVD playback, press to open the DVD menu (if available). For more information, see "Using a disc popup menu" on page 24.
⑬	A (red), B (green), C (yellow), D (blue)	When playing a Blu-ray Disc that has a Java™ application, press to control playback. For more information, see the documentation that came with the Blu-ray Disc.
⑭	REPEAT	Press to repeat the current title, chapter, track, or repeat all. For more information, see "Repeating a title, chapter, or CD track" on page 23.
⑮	A-B	Press to create a playback loop. For more information, see "Creating a playback loop on a DVD or audio CD" on page 23.
⑯	AUDIO	Press to select the audio mode. For more information, see "Selecting the audio mode" on page 24.
⑰	RESOLUTION	Press to select the video resolution. For more information, see "Selecting the video output resolution" on page 27.
⑱	⏏ OPEN/CLOSE	Press to open or close the disc tray.
⑲	SEARCH	Press to search for a title, chapter, or specific time on a disc. For more information, see "Searching for a title, chapter, or elapsed time" on page 23.

#	Item	Description
⑳	▶▶ (next)	Press to go to the next title, chapter, or track.
㉑	◀◀ (previous)	Press to go to the previous title, chapter, or track.
㉒	▶ (play)	Press to begin playback.
㉓	▶ (step)	Press to advance one frame at a time. Press ▶ (play) to resume normal playback.
㉔	DISC MENU	During DVD playback, press to open the DVD root menu where you can select DVD playback options. (This button is valid for DVDs that have a multi-layer menu.)
㉕	CinemaNow	Press to access the CinemaNow application when connected to the Internet.
㉖	RETURN	Press to return to the previous menu.
㉗	DISPLAY	Press to display disc information.
㉘	ANGLE	Press to select a viewing angle if multiple angles are available on the disc. For more information, see "Selecting a viewing angle" on page 24.
㉙	SUBTITLE	Press to select a subtitle language or to turn subtitles off.
㉚	ZOOM	Press to zoom in on a video. Each time you press this button, the magnification level changes. This button is only used for DVD discs.

Setting up your player

Installing remote control batteries

To install remote control batteries:

- 1 Remove the battery compartment cover.

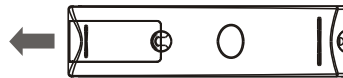

- 2 Insert two AAA batteries into the battery compartment. Make sure that the + and – symbols on the batteries match the + and – symbols in the battery compartment.

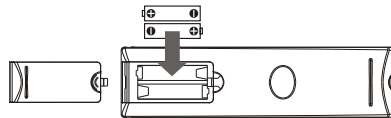

3 Replace the battery compartment cover.

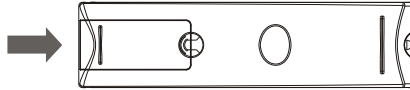
**Notes:**

- Make sure that you insert the batteries correctly.
- Do not heat, open, or short-circuit batteries.
- Do not throw batteries into a fire.
- Do not mix different types of batteries or mix old and new batteries.
- Do not try to recharge non-rechargeable batteries.
- If the remote control does not function correctly or if the operating range becomes reduced, replace the batteries.

Connecting a TV using an HDMI cable (best)

To connect a TV using an HDMI cable:

- Connect an HDMI cable to the **HDMI** jack on the back of your player and to the **HDMI IN** jack on the TV.

**Notes:**

- Only the HDMI is capable of 1080p video output and the highest definition audio codecs.
- An HDMI cable carries both video and audio. If you want to use TV speakers, you do not need to make an audio connection if you are using an HDMI cable. If you want to use an HDMI-capable audio receiver, connect an HDMI cable between your player and the HDMI input on the receiver.

Connecting a TV using an A/V cable (good)

To connect a TV using an AV cable:

- Connect an A/V cable to the **VIDEO OUT** and **AUDIO OUT L/R** jacks on the back of your player and to the **VIDEO IN** and **AUDIO IN L/R** jack on the TV. Jacks and cable connectors are usually color-coded. Make sure that you match the colors.

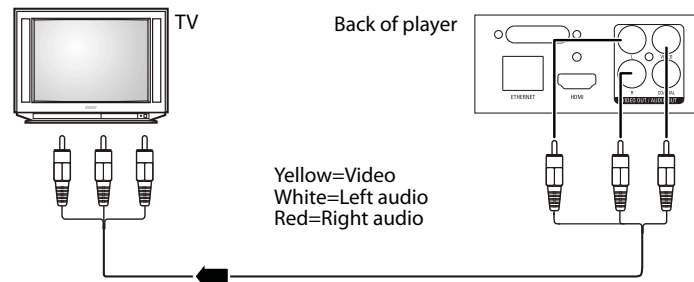

Note: The A/V cable can only send standard-definition video (480i) to your TV.

Connecting audio to an amplifier or home theater system

To connect audio to a digital amplifier or home theater system:

- Connect a digital coaxial cable from the **COAXIAL DIGITAL OUT** jack on the back of your player to the **COAXIAL DIGITAL IN** jack on the receiver.

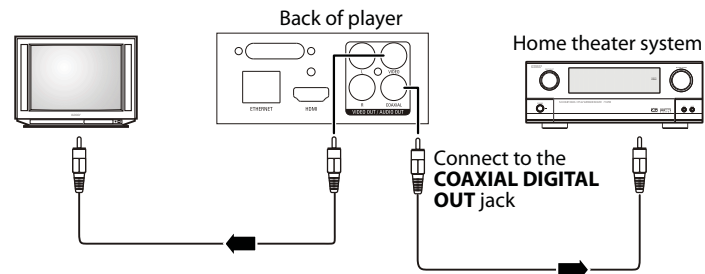

Navigating the on screen menus

- 1 Press **ENTER** or **▶** to open the menus.
- 2 Press **◀** or **RETURN** to close the menus.
- 3 Press **▲** or **▼** to select the desired menu item.

Connecting to your home network

Note: This player can be connected to your wired network using the Ethernet port on the back of your player or by using a wireless network.

Connecting using a wireless network

One connection option is to use an access point or a wireless router as shown in the example below.

The network configuration and connection method may vary depending on the equipment in use and the network environment. This player is equipped with an IEEE 802.11n wireless module, which also supports the 802.11b/g standards. For the best wireless performance, we recommend using a IEEE 802.11n certified Wi-Fi network (access point or wireless router).

To connect to the Internet with a wireless network:

- 1 Set up your access point or wireless router (if not already set up).

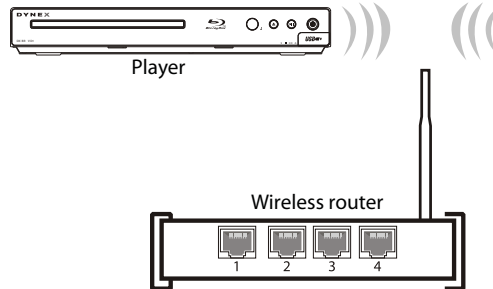

- 2 Press **ENTER**. The *Settings* menu opens.
- 3 Press **▲** or **▼** to select **Network**.
- 4 Press **ENTER**. The *Wireless Settings* screen opens.

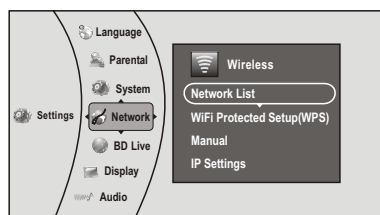

- 5 Press **▲** or **▼** to select **Network List**, then press **ENTER**. The *Network List* screen opens, showing a list of available wireless networks.

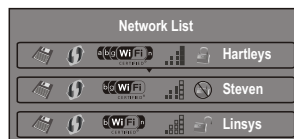

- 6 Press **▲** or **▼** to select the wireless network you want your player to connect to, then press **ENTER**. A *Network Setup* screen opens with the following options:
 - **Connect**—Connect to this network.
 - **Disconnect**—Disconnect from this network.
 - **Delete**—Delete the current network.
 - **WPS Pin**—Create a random PIN number password.
- 7 If your network does not use encryption, press **▲** or **▼** to select **Connect**, then press **ENTER**. If the wireless network is working, you should see a checkmark and a connected message on the TV. If the message does not appear, repeat the steps above.
- 8 Press **◀** to go to the previous menu.

If your network uses encryption:

- 1 Press **▲** or **▼** to select the **Password** field, then press **ENTER**. An on-screen keyboard opens.
- 2 Press **▲** **▼** **◀** or **▶** to select the first letter in the password, then press **ENTER**. Repeat this step to enter the rest of the password. If you make a mistake, use the **Clear** key to delete the character.
- 3 After you enter the password, select the red **Done** in the upper left-hand corner of the keyboard, then press **ENTER** to close the keyboard.
- 4 Press **▲** or **▼** to select **Connect**, then press **ENTER**. If the wireless network is working, you should see a checkmark and a connected message on the TV. If the message does not appear, repeat the steps above.
To connect to a wireless network using Wi-Fi Protected Setup (WPS), see “Setting up WiFi protection (WPS)” on page 41.
- 5 Press **◀** to go to the previous menu.

Connecting using a wired network

Another connection option is to use a wired router as shown in the example below.

To connect to the ethernet with a wired network:

- 1 Connect a network cable to the **INTERNET** jack on the back of your player and into a wired router using a commercially available LAN or Ethernet cable (Cat 5 or better, with RJ45 connectors).

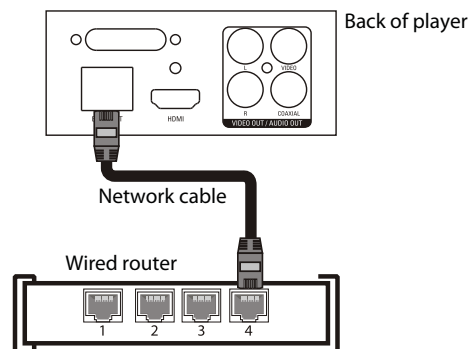

Using a wired network provides the best performance, because the attached devices connect directly to the network and are not subject to radio frequency interference.

Notes:

- When plugging or unplugging the LAN cable, hold the plug portion of the cable. When unplugging, do not pull on the LAN cable but unplug while pressing down on the lock.
- Do not connect a modular phone cable to the LAN port.
- Since there are various connection configurations, follow the specifications of your telecommunication carrier or Internet service provider.

2 Press **ENTER**. The **Settings** menu opens.

3 Press **▲** or **▼** to select **Network**.

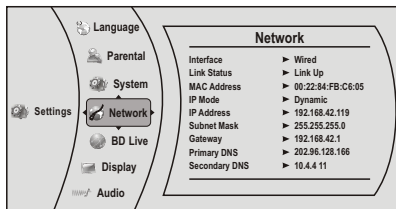

4 If the network connection is active, **Link Up** appears next to **Link Status**. If the network connection is not active, **Link Down** appears next to **Link Status**. Press **ENTER**.

5 Select **IP Mode**, then press **ENTER**.

6 Press **▲** or **▼** to select an IP mode. You can select:

- **Dynamic**—Uses DHCP to automatically obtain an IP address.
- **Manual**—Lets you manually configure network settings, such as IP address, subnet mask, and gateway settings. If you select Manual, the following screen opens. Enter the IP information here.

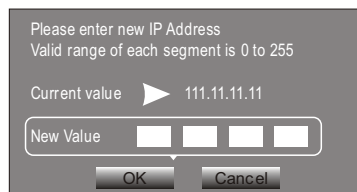

7 Press **◀** to go to the previous menu.









To make changes to your network connection, see “Changing the Network settings” on page 39.

Using your player

Note: Unless otherwise noted, all tasks in this section are based on using the remote control.

Playing a Blu-ray Disc or DVD















To play a Blu-ray Disc or DVD:

- 1 Press .
- 2 Turn on the TV, then select the input setting on the TV that matches the connection method you used to connect your player.
- 3 Press  to open the disc tray.
- 4 Place a disc on the disc tray with the label facing up, then press  to close the disc tray. It may take a few seconds for the disc to load.
- 5 If a Blu-ray Disc or DVD menu opens, press    or  to select **PLAY**, then press **ENTER**.
- 6 To eject the disc, press .

Controlling Blu-ray Disc or DVD playback

Note: If  appears on the screen, the current action is not permitted by the disc or your player. For example, many discs do not let you fast-forward through the warning information at the beginning of the disc.

To control Blu-ray Disc or DVD playback:

- Press  (play) to start playback.
- Press  (pause) to pause playback. The sound is muted when your player is in pause mode. To resume normal playback, press  (play) again.
- Press  (stop) to stop playback, press  (play) to start playback again. Depending on the disc, playback starts where it stopped or at the beginning of the disc. If you press  (stop) twice, playback stops completely and playback starts at the beginning of the disc when you resume playback.
- Press  to fast-forward. Each time you press this button, the fast-forward speed changes in the following sequence: Fast x 2, x 4, x 8, x 16, x 32, x 64, x 128. Press  (play) to resume normal playback.
- Press  to fast-reverse. Each time you press this button, the fast-reverse speed changes in the following sequence: Fast x 2, x 4, x 8, x 16, x 32, x 64, x 128. Press  (play) to resume normal playback.
- Press  to go to the previous chapter within two seconds after the current chapter starts. To go to the beginning of the chapter, press  any time after the first two seconds of the chapter have been played.
- Press  to go to the next chapter.
- Press  (step) to play one frame at a time. Each time you press this button, the video advances one frame. Press  (play) to resume normal playback.



Using connected applications

Your player is equipped with the capability to watch movies over the Internet (for example, from Netflix or CinemaNow), or to listen to Pandora Internet radio or Napster. Before being able to use these Internet services, you must first:

1. Have connected the player to the Internet, and passed the Network Test. See "Connecting using a wireless network" on page 14.
2. Have a valid account to these services.

You should contact the partner company (not Dynex) if you experience an issue using one of these applications.

Note: A particular connected service may not be available in the country in which you live. Consult the streaming services support page to see if service is currently available in your country. To stay up-to-date on future connected service options for your Dynex Blu-ray player, visit www.dynexproducts.com.

Watching movies with CinemaNow (application available in US only)

Note: CinemaNow is coming to the Canada market in a future release.

With CinemaNow on your Blu-ray player, you can rent some of your favorite movies from the comfort of your couch. All you need is your Dynex remote.

Once you have a CinemaNow account from CinemaNow.com, grab some popcorn and enjoy the show.

To set up your CinemaNow account:

- 1 First set up your CinemaNow account through your PC. Go to www.cinemanow.com/activate to get an activation PIN.
- 2 Click **Activate a New Device**, then sign in again with your user name/password.
- 3 Enter any name in the **Name Your Device** section, then click **Continue**.
You now have been provided with a valid activation number to enter into the activation field within the Cinemanow application on your Blu-ray player.
- 4 Once you have successfully established an Internet connection on your Blu-ray player, select the **Cinemanow** application using your remote control, then press **ENTER**.
- 5 Select the **Settings** tab at the bottom of the screen, then press **ENTER**.
- 6 Select **Activate** and enter your activation code. You can now rent movies using Cinemanow.
- 7 To exit CinemaNow, press **Home/Setup**.

Watching movies with Netflix (application available in US and Canada markets)

Once your player is connected to the Internet, follow the steps below to register your player with Netflix.

Note: Users must have a valid Netflix account in order to stream Netflix movies to this player.

With Netflix on your Blu-ray player, if you have a Netflix unlimited plan, you can instantly watch thousands movies and TV episodes streamed from Netflix to your Blu-ray player. Just add shows to your Netflix Instant Queue, and start watching.

To watch movies with Netflix:

- 1 Press **▲** or **▼** to select **Netflix**, then press **ENTER** to register your player with your Netflix account. Follow the directions on the screen. You will be provided with an activation code.
- 2 If you already have an existing Netflix account, log in to your account on your PC. Click on the **Your Account & Help** link in the upper right corner of the screen.
- 3 In the **WATCHING INSTANTLY ON YOUR TV OR COMPUTER** section, click **Activate a Netflix Ready Device** and enter the activation code from Step 1.
- OR -
- 4 If you do not have an existing Netflix account, go to [http://www.netflix.com/Dynex-\(US\)](http://www.netflix.com/Dynex-(US)) or [http://www.netflix.ca/Dynex-\(Canada\)](http://www.netflix.ca/Dynex-(Canada)) to start your free trial and enter the activation code from Step 1 into the **Dynex code** field on screen.
- 5 After setting up your account and activating your Blu-ray player, browse to **Instant** under the **Your Queue** tab and add movies to queue.
- 6 To exit Netflix, press **⇧/Setup**.

Listening to music with Pandora (application available in US market)

Pandora on your Blu-ray player lets you choose exactly the music you want to hear and creates personal Internet radio stations that play it for you. Just enter a song title or band name that represents the kind of music you want to hear, and Pandora will start a unique "Pandora station" that plays music similar to it. Add variety by entering other titles and bands to your station, and even more variety by creating multiple Pandora stations (up to 100!).

For existing Pandora customers:

- 1 Press **▲** or **▼** to select **Pandora**.
- 2 Select **I have a Pandora account** from the options, then sign in with your account information.

For new Pandora customers:

- 1 Press **▲** or **▼** to select **Pandora**.
- 2 Select **I am new to Pandora** from the options. You will receive an activation code.
- 3 On your PC, go to www.pandora.com/Dynex and enter the activation code from Step 2, then click **Activate**.
- 4 Click **Create a Pandora Account** and follow the on-screen instructions.
- 5 To exit Pandora, press **⇧/Setup**.

To create a new Pandora account using a PC:

- Go to <http://www.pandora.com/> to create a new account.

Listening to music with Napster (application available in US market)

Listen to what you want, when you want with Napster, the ultimate online jukebox. Access instantly your choice of over 11 million songs—anytime, anywhere. Kick back with ad-free radio stations, recommendations, and Billboard® charts back to 1955. Create your own playlists for a customized listening experience.

For existing Napster customers:

- 1 Press **▲** or **▼** to select **Napster**, then press **ENTER**.

2 Select **Sign In** from the options, then sign in with your account information.

For new Napster customers:

- 1 Press **▲** or **▼** to select **Napster**, then press **ENTER**.
- 2 Select **Sign Up** from the options. You will receive an activation code.
- 3 On your computer, go to www.napster.com/activate and enter the activation code from Step 2, then click **Continue**. Follow the on-screen instructions.
- 4 To exit Napster, press **⇧/Setup**.

Using BD-Live

Some BD discs contain additional features that are made available to players that are connected to the Internet and have an additional USB memory stick added.

These additional features may include things like:

- The ability to download new movie trailers.
- Additional commentary by actors and directors.
- Multiperson game play and chat.

In order to access BD-Live functions, the player must be properly configured for BD-Live Internet access and it must be equipped with an additional USB memory stick.

Setting up your player for BD-Live Internet access

To set up your player up for BD-Live Internet Access:

- 1 Press **ENTER**. The *Settings* menu opens.
- 2 Press **▲** or **▼** to select **BD-Live**. The *BD-Live* menu opens.
- 3 Press **▲** or **▼** to select **BD-Live Internet Access**, then press **ENTER**. Make sure that either **Limit Access** or **Always Allow Access** is checked.
- 4 Insert a USB memory stick. The USB stick must be at least 1 GB and be formatted as FAT32.
- 5 If there is not at least 1 GB of free space on your player, try to select **Clear BD Storage** from the *BD-Live* menu.
- 6 Press **◀** to go to the previous menu.
- 7 Press **▲** or **▼** to select **Network**, then press **ENTER**.
- 8 Configure your Internet connection as described in "Connecting using a wireless network" on page 14.

Notes:

- Your player must pass the network test (see "Using the network test" on page 42) or you are not connected to the Internet and cannot access BD-Live content on the web.
- The Broadcom Reference system only supports the connection of USB memory in order to fulfill the BD 2.0 1GByte memory requirement. Any externally connected drive becomes the default storage for BD-Live content, and the internal storage is ignored.
- You must have the BD-Live disc in the player to play any related (already downloaded) content.

- Some BD-Live content could expire and will not play. The user occasionally needs to manually delete the contents in storage in order to free space. This can be done from the BD player's main setup menu, under the "BD-Live" submenu item. (Select "Erase Blu-ray storage")
- Instead of a clock, time and expiration of content is managed by the BD-Live server on the Internet.

Displaying Blu-ray Disc or DVD information

Note: The information displayed for discs other than Blu-ray Discs will be different.

To display Blu-ray Disc or DVD information:

- Press **DISPLAY**. Your player displays information about the Disc, such as type of disc, current elapsed time in title, total amount of time in title, current chapter, and total number of chapters.
- Press **DISPLAY** again to close the display.

Playing files on a data disc or USB memory stick

When you insert a data disc or USB memory stick containing picture, music, or video files into your player, icons are added to the menu to indicate that video, music, or picture files are available for playback.

- In the *Main* menu, Press **▲** or **▼** to select **Media**, then press **ENTER**. The following screen opens.

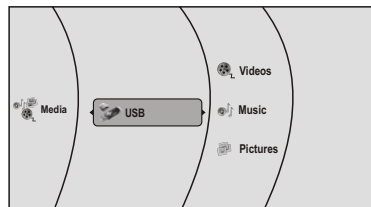

Viewing photographs

Your player can display digital photograph files that are on a USB memory stick or that have been burned onto a CD, DVD+/-R, DVD+/-R(W), or Blu-ray Disc.

To view photographs:

- 1 Insert a disc or a USB memory stick containing photographs into your Blu-ray player.
- 2 Press **▲** or **▼** to select **Pictures**, then press **ENTER**. The *Picture* menu opens.
 - Select **Start Slide Show** to view the pictures in the current folder one by one.
 - Select **Settings** to set the slide show effects and slide show delay time.
 - Select **Main Menu** to return to the *Main* menu.
 - To view a single file, select the files from the right panel, then press **ENTER**.
 - Select *Previous folder/Media* menu to return to the previous folder.

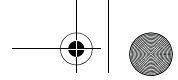

To play audio or video files:

- 1 Press **▲** or **▼** to select **Music** or **Videos**, then press **ENTER**. A menu opens.
- 2 Press **▲** or **▼** to select **Play Files**, then press **ENTER**. The files in the current folder will be played.
 - If you are playing music files and want to view JPG picture files at the same time, press **RETURN**, then press **▲** or **▼** to select **Browse Pictures**, then press **ENTER**. Select the JPG files you want to view.
 - If you want to see information about the file that is playing, press **▲** or **▼** to select **Now Playing**, then press **ENTER**. The following display appears.



	Random play indicator
	Repeat indicator
	Play indicator

Playing an audio CD

To play an audio CD:

- 1 Press **⏻**.
- 2 Press **▲** to open the disc tray.
- 3 Place a CD on the disc tray with the label facing up, then press **▲** to close the disc tray. It may take a few seconds for the CD to load.
- 4 To eject the CD, press **▲**.

Controlling audio CD playback

To control audio CD playback:

- Press **▶** (play) to start playback.
- Press **⏸** (pause) to pause playback. The sound is muted when your player is in pause mode. To resume normal playback, press **▶** (play) again.
- Press **■** (stop) to stop playback completely. Press **▶** (play) to start playback again. Playback starts at the beginning of the CD.
- Press **⏩** to fast-forward. Press **▶** (play) to resume normal playback.
- Press **⏮** to fast reverse. Press **▶** (play) to resume normal playback.
- Within two seconds of starting playback, press **⏮** to go to the previous track. After two seconds of starting playback, press **⏮** to go to the beginning of the current track. Press **⏩** to go to the next track.
- Press **SEARCH** to select a track, enter the track number immediately with the number buttons, then press **ENTER**.

Or,

Enter the track number by pressing the appropriate number buttons.

Searching for a title, chapter, or elapsed time

To search for a title, chapter, or elapsed time:

- 1 During playback, press **SEARCH** one or more times to select a search mode.
 - One press selects **Goto Title** --- mode.
 - Two presses selects **Goto Chapter** --- mode.
 - Three presses selects **Goto Time** --:--:-- mode.
- 2 Press the number buttons to enter the title number, chapter number, or time, then press **ENTER**. Your player goes to the title, chapter, or time you entered.

Repeating a title, chapter, or CD track

To repeat a title, chapter, or CD track:

- To repeat a title or chapter, press **REPEAT** one or more times to select a repeat mode. You can select **Off**, **Repeat Title**, **Repeat Chapter**, **Repeat track**, **Repeat all**, or **Random on**.

Creating a playback loop on a DVD or audio CD

Note: Blu-ray Discs do not normally support playback loops.

To create a playback loop:

- 1 Play the disc until you reach the point where you want the loop to start, then press **A-B**.
- 2 Play the disc until you reach the point where you want the loop to stop, then press **A-B**. Your player plays the loop you created repeatedly.
- 3 Press **A-B** to cancel the loop and return to normal playback.

Using PIP (Picture In Picture) mode

Some Blu-ray Discs are compatible with Picture In Picture (PIP) mode. In PIP mode, the primary video is displayed on the full screen, and the secondary video is displayed in a small window.

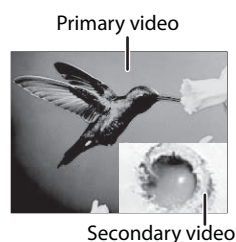

See the documentation that came with the disc for playback instructions.

To use PIP mode:

- 1 Use the menu on the Blu-ray disc to turn PIP on or off.

- 2 If PIP mode is on, press **AUDIO** to turn the audio for the video in the PIP window on or off.
- 3 If PIP mode is on, press **SUBTITLE** to turn the subtitle for the video in the PIP window on or off.

Using a disc popup menu

To use a disc popup menu:

- 1 During Blu-ray or DVD playback, press **POPUP MENU**. The Blu-ray popup menu or DVD disc menu opens.
- 2 Press **▲ ▼ ◀ ▶** to select an option, then press **ENTER**.

Selecting the audio mode

To select the audio mode:

- 1 Press **AUDIO**. Your player displays audio channel information, such as "01/03 Eng Dolby Digital." "01" indicates the currently selected audio channel. "03" indicates the total number of audio channels. "Eng" (English) indicates the audio language. "Dolby Digital" describes the currently selected audio format.
- 2 Press **▶** to select an audio mode.

Selecting a viewing angle

Note: Not all discs are recorded with multiple viewing angles and not all scenes on a disc have multiple viewing angles.

To select the viewing angle:

- During playback, press **ANGLE**. Your player displays "Angle X of X." The first "X" indicates the current viewing angle, and the second "X" indicates the total number of viewing angles.

Using the Settings menu

The settings menu is displayed on the screen automatically under No Disc or Stop situations.

To use the Settings menus:

- 1 Press **ENTER** on the remote control. The *Settings* menu opens.

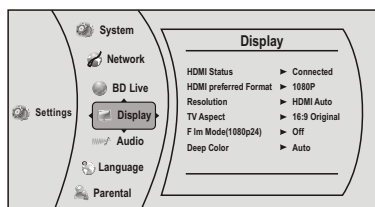

- 2 Press **▲** or **▼** to select an option, then press **ENTER** to open the sub-menu.
- 3 Press **◀** or **RETURN** to go to the previous menu.

Changing the Language settings

Selecting the on-screen menu language

To select the on-screen menu language:

- 1 Press **ENTER**. The *Settings* menu opens.
- 2 Press **▲** or **▼** to select **Language**. The *Language* menu opens.

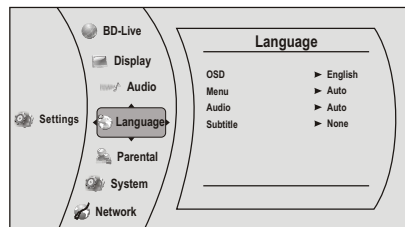

- 3 Press **▶** to select **OSD**, then press **ENTER**.
- 4 Press **▲** or **▼** to select the language you want, then press **ENTER**. You can select **English**, **French**, or **Spanish**.
- 5 Press **◀** to go to the previous menu.

Selecting the disc menu language

To select the disc menu language:

- 1 Press **ENTER**. The *Settings* menu opens.
- 2 Press **▲** or **▼** to select **Language**. The *Language* menu opens.

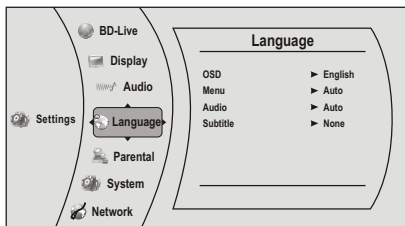

- 3 Press **▶**, then press **▼** to select **Menu**, then press **ENTER**.
- 4 Press **▲** or **▼** to select the language you want, then press **ENTER**.
Notes: Not all languages are available on all discs. Most discs only have one menu language.
- 5 Press **◀** to go to the previous menu.

Selecting the audio language

To select the audio language:

- 1 Press **ENTER**. The *Settings* menu opens.
- 2 Press **▲** or **▼** to select **Language**. The *Language* menu opens.

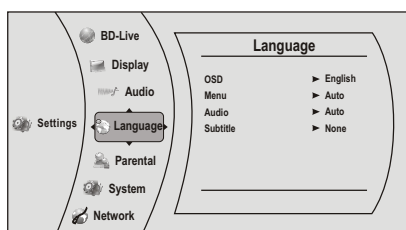

- 3 Press **▶**, then press **▼** to select **Audio**, then press **ENTER**.
- 4 Press **▲** or **▼** to select the language you want, then press **ENTER**.

Notes:

- Not all languages are available on all discs.
- Some discs do not let you select the audio language using your player's menu. Instead, you have to select the audio language from the disc setup menu (the menu that appears after you insert the disc).

- 5 Press **◀** to go to the previous menu.

Selecting the subtitle language

To select the subtitle language:

- 1 Press **ENTER**. The *Settings* menu opens.
- 2 Press **▲** or **▼** to select **Language**. The *Language* menu opens.

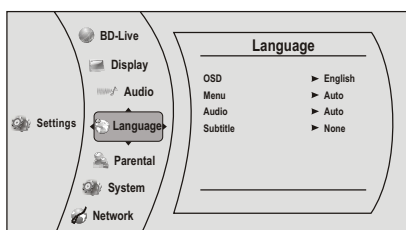

- 3 Press **▶**, then press **▼** to select **Subtitle**, then press **ENTER**.
- 4 Press **▲** or **▼** to select the language you want, then press **ENTER**.

Notes:

- Not all languages are available on all discs.
- Some discs do not let you select the subtitle language from your player. Instead, you have to select the subtitle language from the disc setup menu (the menu that appears after you insert the disc).

You can also select the subtitle language from the Subtitle menu in the on-screen menu.

Changing the Display settings

Determining whether an HDMI TV is connected

To determine whether an HDMI TV is connected:

- 1 Press **ENTER**. The *Settings* menu opens.

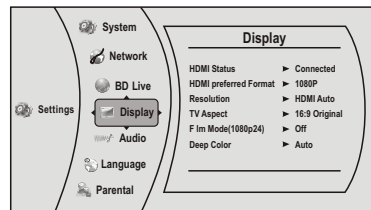

- 2 The *Display Preview* menu opens.
If an HDMI TV is connected, **Connected** appears. If an HDMI TV is not connected **Disconnected** appears
- 3 Press **◀** to go to the previous menu.

Automatically determining the best HDMI resolution

To automatically determine the best HDMI resolution:

- 1 Press **ENTER**. The *Settings* menu opens.

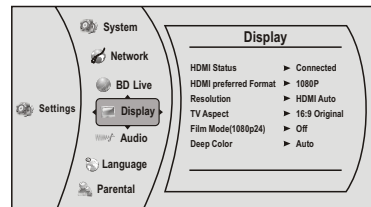

- 2 The *Display Preview* menu opens. Your player displays the best HDMI format for the connected TV.
- 3 Press **◀** to go to the previous menu.

Selecting the video output resolution

To select the video output resolution:

- 1 Press **ENTER**. The *Settings* menu opens.

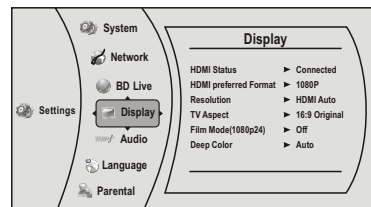

- 2 Press **ENTER**.

- 3 Press **▲** or **▼** to select **Resolution**, then press **ENTER**.
- 4 Press **▲** or **▼** to select the resolution you want, then press **ENTER**.

TV type	Resolution
If your TV is a high-definition TV (HDTV) connected to the HDMI jack on your player and you want your player to set the output resolution based on information exchanged between the TV and your player over the HDMI cable	HDMI Auto
If the TV is a high-definition TV (HDTV) capable of 1080p (any frame rate) connected to the HDMI jack on your player	1080p (HDMI)
If your TV is a high-definition TV (HDTV) capable of 1080i only	1080i
If your TV is a high-definition TV (HDTV) capable of 720p only	720p
If your TV is an enhanced-definition TV (EDTV)	480p
If your TV is a standard-definition NTSC TV (American or Asian SD TV)	480i

Notes:

- Selecting a resolution the TV does not support could result in an unstable picture or loss of the picture. See the documentation that came with the TV to find the resolutions the TV supports.
- Only the HDMI output on your player supports 1080p video output at any frame rate. If the TV is connected to the component output, the video output is limited to 1080i or lower.

- 5 Press **◀** to go to the previous menu.

Selecting the TV aspect ratio**To select the TV aspect ratio:**

- 1 Press **ENTER**. The **Settings** menu opens.

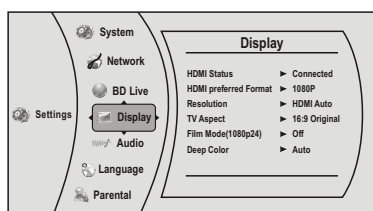

- 2 Press **ENTER**.
- 3 Press **▼** to select **TV Aspect**, then press **ENTER**.
- 4 Press **▲** or **▼** to select the aspect ratio you want, then press **ENTER**. You can select **16:9 Original**, or **16:9 wide**, **4:3 Pan & Scan**, **4:3 Letter Box**.

Notes:

- If your TV has a rectangular (16:9) aspect ratio, choose one of the 16:9 aspect ratios. If your TV has a square (4:3) aspect ratio, choose one of the 4:3 aspect ratios.

- Setting your player for one of the 16:9 settings when connected to a 4:3 TV may produce a picture that does not correctly fit on the screen.

- 5 Press **◀** to go to the previous menu.

Turning film mode on or off

Movies are recorded on film at a rate of 24 pictures (frames) per second. Many of the movies on Blu-ray Discs are placed on the discs at this frame rate. If your TV supports 24 frames per second, but you would prefer viewing the video at a higher frame rate, you should turn off **Film Mode**.

To turn film mode on or off:

- 1 Press **ENTER**. The **Settings** menu opens.

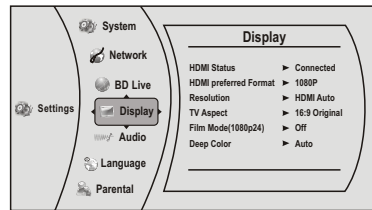

- 2 Press **ENTER**.
- 3 Press **▼** to select **Film Mode (1080p24)**, then press **ENTER**.
- 4 Press **▲** or **▼** to select **Auto** or **Off**. **Off** selects a 60 frames/second output format. When the Film mode is set to **Auto**, the output format goes to 24p automatically, if it's supported.
- 5 Press **◀** to go to the previous menu.

Selecting Deep Color

Select **24 bits**, **30 bits**, or **36 bits**.

Note: Your player is capable of sending deep (up to 36-bit) color over HDMI, if your TV supports it. This expands the colors displayed from millions to billions, which is much more vivid than the previous.

To select Deep Color:

- 1 Press **ENTER**. The **Settings** menu opens.

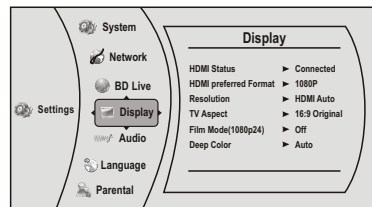

- 2 Press **ENTER**.
- 3 Press **▼** to select **Deep Color**, then press **ENTER**.

- 4 Press **▲** or **▼** to select **Auto** or **Off**. If **Deep Color** is set to **Auto**, and the player is connected to TV via HDMI cable, the player first tries to set the color depth to 36 bits, if the 36 bits is not supported by the TV, it tries to set the color depth to 30 bits, if the 30 bits is not supported by the TV, the player sets the color depth to 24 bits. If **Deep Color** is set to **Off**, the player sets the color depth to 24 bits.
- 5 Press **◀** to go to the previous menu.

Changing the Audio settings

Selecting the PCM downsampling rate

If your player is connected to an audio receiver or TV with a coaxial cable, select the highest PCM sampling rate the amplifier supports.

To select the PCM downsampling rate:

- 1 Press **ENTER**. The *Settings* menu opens.
- 2 Press **▲** or **▼** to select **Audio**. The *Audio* menu opens.

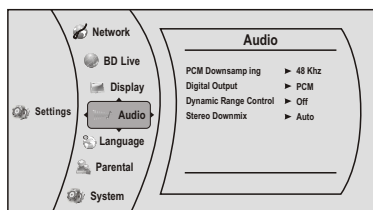

- 3 Press **▶** to select **PCM Downsampling**, then press **ENTER**.
- 4 Press **▲** or **▼** one or more times to select the PCM downsampling rate you want. You can select **48KHz**, **96KHz**, or **Off**.

If you **do not** have a surround sound receiver connected to your player through the digital audio jack, select 48kHz. Otherwise, select the highest sampling rate the receiver supports. See the documentation that came with the receiver.

Note: Setting the coaxial audio output's PCM downsampling sampling rate too high may result in unpredictable audio playback. If you are not sure, set the rate to 48kHz.

- 5 Press **◀** to go to the previous menu.

Selecting the digital audio output mode

To select the digital audio output mode:

- 1 Press **ENTER**. The *Settings* menu opens.

