



<b>Prüfbericht - Nr.: 17019992 001</b>		<b>Seite 1 von 130</b>	
<i>Test Report No.:</i>		<i>Page 1 of 130</i>	
<b>Auftraggeber:</b>	Desay A&V Science and Technology Co., Ltd.		
<i>Client:</i>	Desay 3rd Industry Zone, Chenjiang Town, Huizhou City, Guandong, P.R. China		
<b>Gegenstand der Prüfung:</b>	Blu-ray Disc Player		
<i>Test item:</i>			
<b>Bezeichnung:</b>	DX-WBRDVD1	<b>Serien-Nr.:</b>	n.a.
<i>Identification:</i>	DX-WBRDVD1-CA	<i>Serial No.:</i>	
<b>Wareneingangs-Nr.:</b>	163074378	<b>Eingangsdatum:</b>	2011-03-01
<i>Receipt No.:</i>		<i>Date of receipt:</i>	
<b>Prüfört:</b>	Neutron Engineering Inc.		
<i>Testing location:</i>	No. 3. Jinshagang 1st Road, ShiXia, DaLang Town, Dong Guan, China		
	FCC Registration No.: 319330		
	Industry Canada Test Site No.: 4428B-1		
<b>Prüfgrundlage:</b>	FCC CFR47 Part 15: Subpart C Section 15.247		
<i>Test specification:</i>	FCC CFR47 Part 15: Subpart C Section 15.207		
	FCC CFR47 Part 15: Subpart C Section 15.209		
	RSS-210 Issue 8 December 2010		
	RSS-Gen Issue 3 December 2010		
<b>Prüfergebnis:</b>	<b>Der Prüfgegenstand entspricht oben genannter Prüfgrundlage(n).</b>		
<i>Test Result:</i>	<i>The test item passed the test specification(s).</i>		
<b>Prüflaboratorium:</b>	TÜV Rheinland (Shenzhen) Co., Ltd.		
<i>Testing Laboratory:</i>			
<b>geprüft/ tested by:</b>	<b>kontrolliert/ reviewed by:</b>		
			
2011-04-26	Sam Lin/ Project Manager	2011-04-28	Shawn Peng/Manager
<b>Datum</b>	<b>Name/Stellung</b>	<b>Unterschrift</b>	<b>Datum</b>
<i>Date</i>	<i>Name/Position</i>	<i>Signature</i>	<i>Date</i>
<b>Sonstiges/ Other Aspects:</b>			
<b>Abkürzungen:</b>	<i>P(ass)</i> = entspricht Prüfgrundlage	<b>Abbreviations:</b>	<i>P(ass)</i> = passed
	<i>F(ail)</i> = entspricht nicht Prüfgrundlage		<i>F(ail)</i> = failed
	<i>NIA</i> = nicht anwendbar		<i>NIA</i> = not applicable
	<i>NIT</i> = nicht getestet		<i>NIT</i> = not tested
<b>Dieser Prüfbericht bezieht sich nur auf das o.g. Prüfmuster und darf ohne Genehmigung der Prüfstelle nicht auszugsweise vervielfältigt werden. Dieser Bericht berechtigt nicht zur Verwendung eines Prüfzeichens.</b>			
<i>This test report relates to the a. m. test sample. Without permission of the test center this test report is not permitted to be duplicated in extracts. This test report does not entitle to carry any safety mark on this or similar products.</i>			

## Contents

<b>1. SUMMARY OF TEST RESULTS .....</b>	<b>4</b>
<b>1.1. TEST FACILITY .....</b>	<b>5</b>
<b>1.2. MEASUREMENT UNCERTAINTY .....</b>	<b>5</b>
<b>2. GENERAL INFORMATION .....</b>	<b>6</b>
<b>2.1. GENERAL DESCRIPTION OF EUT .....</b>	<b>6</b>
<b>2.2. DESCRIPTION OF TEST MODES.....</b>	<b>7</b>
<b>2.3. TABLE OF PARAMETERS OF TEXT SOFTWARE SETTING.....</b>	<b>9</b>
<b>2.4. BLOCK DIGRAM SHOWING THE CONFIGURATION OF SYSTEM TESTED .....</b>	<b>9</b>
<b>2.5. DESCRIPTION OF SUPPORT UNITS (RADIATED MODE) .....</b>	<b>10</b>
<b>3. . EMC EMISSION TEST.....</b>	<b>11</b>
<b>3.1. CONDUCTED EMISSION MEASUREMENT .....</b>	<b>11</b>
3.1.1. <i>POWER LINE CONDUCTED EMISSION LIMITS .....</i>	<i>11</i>
3.1.2. <i>MEASUREMENT INSTRUMENTS LIST AND SETTING .....</i>	<i>11</i>
3.1.3. <i>TEST PROCEDURE .....</i>	<i>12</i>
3.1.4. <i>DEVIATION FROM TEST STANDARD .....</i>	<i>12</i>
3.1.5. <i>TEST SETUP .....</i>	<i>13</i>
3.1.6. <i>EUT OPERATING CONDITIONS .....</i>	<i>13</i>
3.1.7. <i>TEST RESULTS.....</i>	<i>13</i>
<b>3.2. RADIATED EMISSION MEASUREMENT .....</b>	<b>20</b>
3.2.1. <i>Radiated Emission Limits .....</i>	<i>20</i>
3.2.2. <i>MEASUREMENT INSTRUMENTS LIST ANS SETTING .....</i>	<i>21</i>
3.2.3. <i>TEST PROCEDURE .....</i>	<i>23</i>
3.2.4. <i>DEVIATION FROM TEST STANDARD .....</i>	<i>23</i>
3.2.5. <i>TEST SETUP .....</i>	<i>24</i>
3.2.6. <i>EUT OPERATING CONDITIONS .....</i>	<i>25</i>
3.2.7. <i>TEST RESULTS (BELOW 30MHz).....</i>	<i>25</i>
3.2.8. <i>TEST RESULTS (Between 30 – 1000 MHz).....</i>	<i>26</i>
3.2.9. <i>TEST RESULTS (Above 1000 MHz) .....</i>	<i>31</i>
<b>4. BANDWIDTH TEST .....</b>	<b>81</b>
<b>4.1. APPLIED PROCEDURES / LIMIT .....</b>	<b>81</b>
4.1.1. <i>MEASUREMENT INSTRUMENTS LIST.....</i>	<i>81</i>
4.1.2. <i>TEST PROCEDURE .....</i>	<i>81</i>
4.1.3. <i>DEVIATION FROM STANDARD .....</i>	<i>81</i>
4.1.4. <i>TEST SETUP .....</i>	<i>82</i>
4.1.5. <i>EUT OPERATION CONDITIONS .....</i>	<i>82</i>
4.1.6. <i>TEST RESULTS.....</i>	<i>82</i>
<b>5. PEAK OUTPUT POWER TEST .....</b>	<b>91</b>

## Contents

<b>5.1. APPLIED PROCEDURES / LIMIT</b> .....	<b>91</b>
5.1.1. MEASUREMENT INSTRUMENTS LIST .....	91
5.1.2. TEST PROCEDURE .....	91
5.1.3. DEVIATION FROM STANDARD .....	91
5.1.4. TEST SETUP .....	92
5.1.5. EUT OPERATION CONDITIONS .....	92
5.1.6. TEST RESULTS .....	93
<b>6. ANTENNA CONDUCTED SPURIOUS EMISSION</b> .....	<b>96</b>
<b>6.1. APPLIED PROCEDURES / LIMIT</b> .....	<b>96</b>
6.1.1. MEASUREMENT INSTRUMENTS LIST .....	96
6.1.2. TEST PROCEDURE .....	96
6.1.3. DEVIATION FROM STANDARD .....	97
6.1.4. TEST SETUP .....	97
6.1.5. EUT OPERATION CONDITIONS .....	97
6.1.6. TEST RESULTS .....	97
<b>7. POWER SPECTRAL DENSITY TEST</b> .....	<b>117</b>
<b>7.1. APPLIED PROCEDURES / LIMIT</b> .....	<b>117</b>
7.1.1. MEASUREMENT INSTRUMENTS LIST .....	117
7.1.2. TEST PROCEDURE .....	117
7.1.3. DEVIATION FROM STANDARD .....	117
7.1.4. TEST SETUP .....	118
7.1.5. EUT OPERATION CONDITIONS .....	118
7.1.6. TEST RESULTS .....	119
<b>8. EUT TEST PHOTO</b> .....	<b>127</b>

## 1. SUMMARY OF TEST RESULTS

Test procedures according to the technical standards:

FCC Part15 (15.247) , Subpart C/ RSS-210				
Standard	Section	Test Item	Judgment	Remark
RSS-GEN 7.2.2	15.207	Conducted Emission	PASS	
RSS-210 A8.5	15.247 (c)	Antenna conducted Spurious Emission	PASS	
RSS-210 A8.2(a)	15.247 (a)(2)	6dB Bandwidth	PASS	
RSS-210 A8.4(4)	15.247 (b)	Peak Output Power	PASS	
RSS-210 A8.2(b)	15.247 (d)	Power Spectral Density	PASS	
-	15.203	Antenna Requirement	PASS	
RSS-210 Annex 8 (A8.5)	15.247(c)	Transmitter Radiated Emissions FCC Limit: Table 15.209 RSS-210 Limit: Table 3	PASS	
RSS-Gen 7.2.3	Note(1)	Receiver Radiated Emissions RSS-210 Limit: Table 3	PASS	

NOTE:

(1) "N/A" denotes test is not applicable in this Test Report

## 1.1. TEST FACILITY

Neutron Engineering Inc.

No.3, Jinshagang 1st Road, ShiXia, Dalang Town, Dong Guan, China

Neutron's test firm number for FCC 319330

Neutron's test firm number for IC 4428B-1

The test facilities used to collect the test data in this report is **DG-C01/DG-CB03** at the location of No.3,Jinshagang 1st Road, ShiXia, Dalang Town, Dong Guan, China.523792

## 1.2. MEASUREMENT UNCERTAINTY

Where relevant, the following measurement uncertainty levels have been estimated for tests performed on the EUT as specified in CISPR 16-4-2:

The reported uncertainty of measurement  $y \pm U$ , where expanded uncertainty  $U$  is based on a standard uncertainty multiplied by a coverage factor of  $k=2$ , providing a level of confidence of approximately **95 %**.

### A. Conducted Measurement :

Test Site	Method	Measurement Frequency Range	U, (dB)	NOTE
DG-C01	CISPR	150 KHz ~ 30MHz	1.94	

### B. Radiated Measurement :

Test Site	Method	Measurement Frequency Range	Ant. H / V	U, (dB)	NOTE
DG-CB03	CISPR	30MHz ~ 200MHz	V	3.82	
		30MHz ~ 200MHz	H	3.60	
		200MHz ~ 1,000MHz	V	3.86	
		200MHz ~ 1,000MHz	H	3.94	

## 2. GENERAL INFORMATION

### 2.1. GENERAL DESCRIPTION OF EUT

Equipment	BLU-RAY Disc Player	
Model Name	DX-WBRDVD1;DX-WBRDVD1-CA	
Model Difference	Only different model name for different market Model DX-WBRDVD1 is for US market Model DX-WBRDVD1-CA is for Canada market	
Product Description	The EUT is a BLU-RAY Disc Player with WiFi feature.	
	Operation Frequency:	2412~2462 MHz
	Modulation Type:	802.11b:CCK, DQPSK, DBPSK 802.11g:OFDM 802.11n:OFDM
	Bit Rate of Transmitter	802.11b:11/5.5/2/1 Mbps 802.11g:54/48/36/24/18/12/9/6 Mbps Draft 802.11n:up to 300Mbps
	Number of Channel	11 CH, Please see Note 1.
	Conducted Peak Output Power	802.11b: 18.26dBm 802.11g: 22.25 dBm 802.11n(20MHz): 22.63 dBm 802.11n(40MHz): 18.05 dBm
	Antenna	Integrated PCB printed antenna, 1.53dBi for Antenna 0 and 1.49dBi for Antenna 1
	More details of EUT technical specification please refer to the User's Manual.	
Power Source	AC 100V ~ 240V, 50/60Hz	
Connecting I/O Port(s)	Please refer to the User's Manual	

Note:

1. CH 01 – CH 11 for 802.11b, 802.11g, 802.11n(20MHz)  
 CH 03 – CH 09 for 802.11n(40MHz)

Channel	Frequency (MHz)	Channel	Frequency (MHz)	Channel	Frequency (MHz)	Channel	Frequency (MHz)
01	2412	04	2427	07	2442	10	2457
02	2417	05	2432	08	2447	11	2462
03	2422	06	2437	09	2452		

## 2.2. DESCRIPTION OF TEST MODES

To investigate the maximum EMI emission characteristics generates from EUT, the test system was pre-scanning tested base on the consideration of following EUT operation mode or test configuration mode which possible have effect on EMI emission level. Each of these EUT operation mode(s) or test configuration mode(s) mentioned above was evaluated respectively.

Pretest Mode	Description
Mode 1	TX B MODE CHANNEL 01//06/11
Mode 2	TX G MODE CHANNEL 01/06/11
Mode 3	TX N-20MHZ MODE CHANNEL 01/06/11
Mode 4	TX N-40MHZ MODE CHANNEL 03/06/09
Mode 5	RX Mode
Mode 6	DVD PLAY
Mode 7	Connect Internet via Ethernet port
Mode 8	Transmitting+Receiving

The EUT system operated these modes were found to be the worst case during the pre-scanning test as Following:

For Conducted Test	
Final Test Mode	Description
Mode 6	DVD PLAY
Mode 7	Connect Internet via Ethernet port
Mode 8	Transmitting+Receiving

For Radiated Test	
Final Test Mode	Description
Mode 1	TX B MODE CHANNEL 01//06/11
Mode 2	TX G MODE CHANNEL 01/06/11
Mode 3	TX N-20MHZ MODE CHANNEL 01/06/11
Mode 4	TX N-40MHZ MODE CHANNEL 03/06/09
Mode 5	RX Mode

**Note:**

- (1) The measurements are performed at the highest, middle, lowest available channels.  
(2) 802.11b mode: DBPSK (1Mbps)  
802.11g mode: OFDM (6Mbps)  
802.11n HT20 mode : MCS0 (6.6Mbps)  
802.11n HT40 mode : MCS0 (13.5Mbps)  
For radiated emission tests, the highest output powers were set for final test.

For Other Test Item	
Final Test Mode	Description
Mode 1	TX B MODE CHANNEL 01//06/11, Ant 0
Mode 2	TX G MODE CHANNEL 01/06/11, Ant 0
Mode 3	TX N-20MHZ MODE CHANNEL 01/06/11, Ant 0
Mode 4	TX N-40MHZ MODE CHANNEL 03/06/09, Ant 0

**Note:**

- (1) Preliminary tests were performed in different data rate and antenna port to find the worst radiated emission.  
(2) Investigation has been done on all the possible configurations for searching the worst cases.



## 2.3. TABLE OF PARAMETERS OF TEXT SOFTWARE SETTING

During testing channel & power controlling software provided by the customer was used to control the operating channel as well as the output power level. The RF output power selection is for the setting of RF output power expected by the customer and is going to be fixed on the firmware of the final end product power parameters of WLAN

Test software Version	Kirin-5.100.68.36		
Frequency	2412 MHz	2437 MHz	2462 MHz
IEEE 802.11b DSSS (dBm)	16	16	16
IEEE 802.11g OFDM (dBm)	14	14	14

Test software Version	Kirin-5.100.68.36		
Frequency (MHz)	2412 MHz	2437 MHz	2462 MHz
IEEE 802.11n (20MHz) (dBm)	12	12	12
Frequency (MHz)	2422 MHz	2437 MHz	2452 MHz
IEEE 802.11n (40MHz) (dBm)	11	11	11

## 2.4. BLOCK DIGRAM SHOWING THE CONFIGURATION OF SYSTEM TESTED

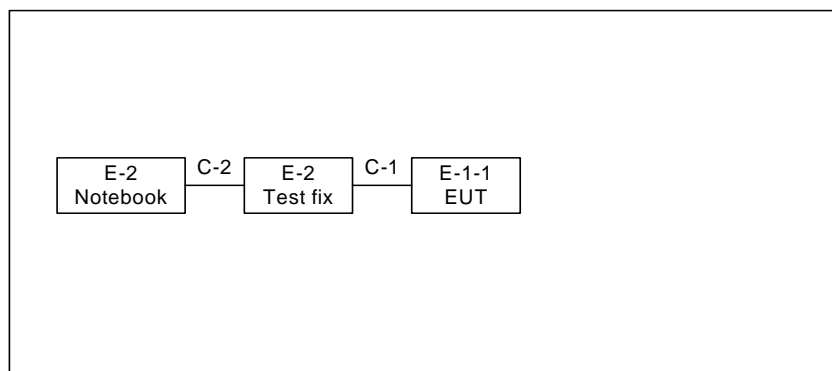

C-1: Control Cable  
 C-2: USB Cable

## 2.5. DESCRIPTION OF SUPPORT UNITS (RADIATED MODE)

The EUT has been tested as an independent unit together with other necessary accessories or support units. The following support units or accessories were used to form a representative test configuration during the tests.

Item	Equipment	Mfr/Brand	Model/Type No.	FCC ID	Series No.	Note
E-1	BLU-RAY Disc Player	N/A	DX-WBRDVD1	N/A	N/A	EUT
E-2	Test fix	N/A	N/A	N/A	N/A	
E-3	Notebook	Dell	Inspiron 1420	N/A	FRPN62X	

Item	Shielded Type	Ferrite Core	Length	Note
C-1	NO	NO	0.15M	
C-2	YES	NO	0.15M	

Note:

- (1) The support equipment was authorized by Declaration of Confirmation.
- (2) For detachable type I/O cable should be specified the length in 『Length』 column.

## 3.. EMC EMISSION TEST

### 3.1. CONDUCTED EMISSION MEASUREMENT

#### 3.1.1. POWER LINE CONDUCTED EMISSION LIMITS

(Frequency Range 150KHz-30MHz)

FREQUENCY (MHz)	Class A (dBuV)		Class B (dBuV)		Standard
	Quasi-peak	Average	Quasi-peak	Average	
0.15 -0.5	79.00	66.00	66 - 56 *	56 - 46 *	CISPR
0.50 -5.0	73.00	60.00	56.00	46.00	CISPR
5.0 -30.0	73.00	60.00	60.00	50.00	CISPR

0.15 -0.5	79.00	66.00	66 - 56 *	56 - 46 *	FCC
0.50 -5.0	73.00	60.00	56.00	46.00	FCC
5.0 -30.0	73.00	60.00	60.00	50.00	FCC

Note:

- (1) The tighter limit applies at the band edges.
- (2) The limit of " \* " marked band means the limitation decreases linearly with the logarithm of the frequency in the range.

#### 3.1.2. MEASUREMENT INSTRUMENTS LIST AND SETTING

Item	Kind of Equipment	Manufacturer	Type No.	Serial No.	Calibrated until
1	LISN	EMCO	3816/2	00052765	May.26.2011
2	LISN	Rolf Heine	NNB-2-16Z	99044	May.26.2011
3	50Ω Terminator	SHX	TF2-3G-A	08122901	May.26.2011
4	Transient Limiter	Agilent	11947A	3107A03668	May.26.2011

5	Test Cable	N/A	C-06_C03	N/A	Nov.15.2011
6	Test Receiver	R&S	ESCI	100382	May.26.2011

Remark: " N/A" denotes No Model Name. , Serial No. or No Calibration specified.

The following table is the setting of the receiver

Receiver Parameters	Setting
Attenuation	10 dB
Start Frequency	0.15 MHz
Stop Frequency	30 MHz
IF Bandwidth	9 kHz

### 3.1.3. TEST PROCEDURE

- a. The EUT was placed 0.8 meters from the horizontal ground plane with EUT being connected to the power mains through a line impedance stabilization network (LISN). All other support equipments powered from additional LISN(s). The LISN provide 50 Ohm/ 50uH of coupling impedance for the measuring instrument.
- b. Interconnecting cables that hang closer than 40 cm to the ground plane shall be folded back and forth in the center forming a bundle 30 to 40 cm long.
- c. I/O cables that are not connected to a peripheral shall be bundled in the center. The end of the cable may be terminated, if required, using the correct terminating impedance. The overall length shall not exceed 1 m.
- d. LISN at least 80 cm from nearest part of EUT chassis.
- e. For the actual test configuration, please refer to the related Item –EUT Test Photos.

### 3.1.4. DEVIATION FROM TEST STANDARD

No deviation

### 3.1.5. TEST SETUP

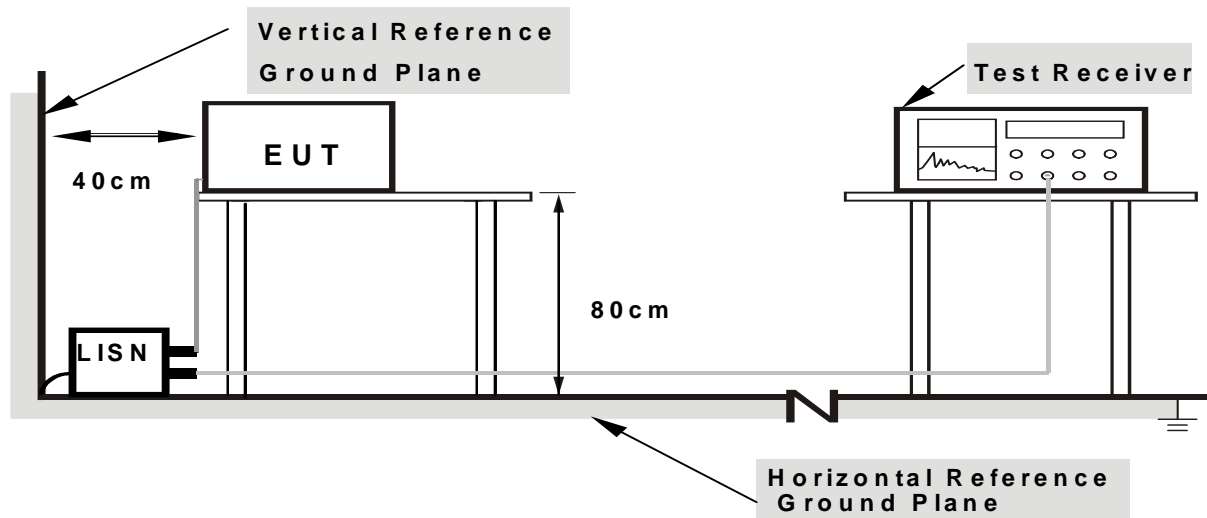

- Note:**
1. Support units were connected to second LISN.
  2. Both of LISNs (AMN) are 80 cm from EUT and at least 80 from other units and other metal planes

### 3.1.6. EUT OPERATING CONDITIONS

The EUT was configured for testing in a typical fashion (as a customer would normally use it). The EUT has been programmed to continuously transmit during test. This operating condition was tested and used to collect the included data.

The EUT was programmed to be in continuously transmitting mode.

### 3.1.7. TEST RESULTS

EUT:	BLU-RAY Disc Player	Model Name. :	DX-WBRDVD1
Temperature:	25 °C	Relative Humidity :	53 %
Pressure:	1010hPa	Test Power :	AC 120V/60Hz
Test Mode :	DVD PLAY		

Freq. (MHz)	Terminal L/N	Measured(dBuV)		Limits(dBuV)		Margin (dB)	Note
		QP-Mode	AV-Mode	QP-Mode	AV-Mode		
0.16	Line	58.02	37.59	65.58	55.58	-7.56	(QP)
0.19	Line	55.51	31.99	64.25	54.25	-8.74	(QP)
0.38	Line	44.93	*	58.27	48.27	-13.34	(QP)
0.51	Line	43.46	*	56.00	46.00	-12.54	(QP)
1.96	Line	45.15	33.10	56.00	46.00	-10.85	(QP)
9.84	Line	51.94	42.26	60.00	50.00	-7.74	(AV)

**Remark**

- (1) All readings are QP Mode value unless otherwise stated AVG in column of 『Note』 . If the QP Mode Measured value compliance with the QP Limits and lower than AVG Limits, the EUT shall be deemed to meet both QP & AVG Limits and then only QP Mode was measured, but AVG Mode didn't perform. In this case, a “ \* ” marked in AVG Mode column of Interference Voltage Measured.
- (2) Measuring frequency range from 150KHz to 30MHz.

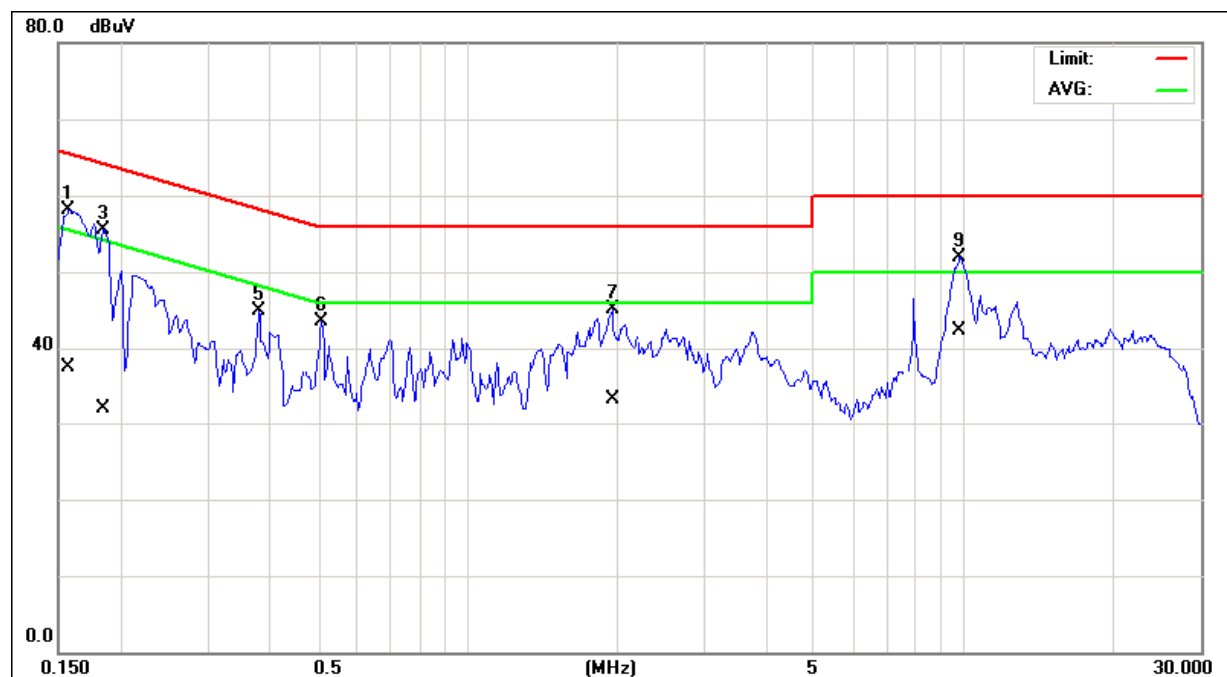

EUT:	BLU-RAY Disc Player	Model Name. :	DX-WBRDVD1
Temperature:	25 °C	Relative Humidity :	53 %
Pressure:	1010hPa	Test Power :	AC 120V/60Hz
Test Mode :	DVD PLAY		

Freq. (MHz)	Terminal L/N	Measured(dBuV)		Limits(dBuV)		Margin (dB)	Note
		QP-Mode	AV-Mode	QP-Mode	AV-Mode		
0.16	Neutral	58.37	38.98	65.58	55.58	-7.21	(QP)
0.19	Neutral	56.11	35.28	64.25	54.25	-8.14	(QP)
0.40	Neutral	43.36	*	57.94	47.94	-14.58	(QP)
2.00	Neutral	44.43	34.60	56.00	46.00	-11.40	(AV)
2.58	Neutral	43.68	*	56.00	46.00	-12.32	(QP)
9.84	Neutral	52.24	42.87	60.00	50.00	-7.13	(AV)

**Remark**

- (1) All readings are QP Mode value unless otherwise stated AVG in column of 『Note』 . If the QP Mode Measured value compliance with the QP Limits and lower than AVG Limits, the EUT shall be deemed to meet both QP & AVG Limits and then only QP Mode was measured, but AVG Mode didn't perform. In this case, a " \* " marked in AVG Mode column of Interference Voltage Measured.
- (2) Measuring frequency range from 150KHz to 30MHz.

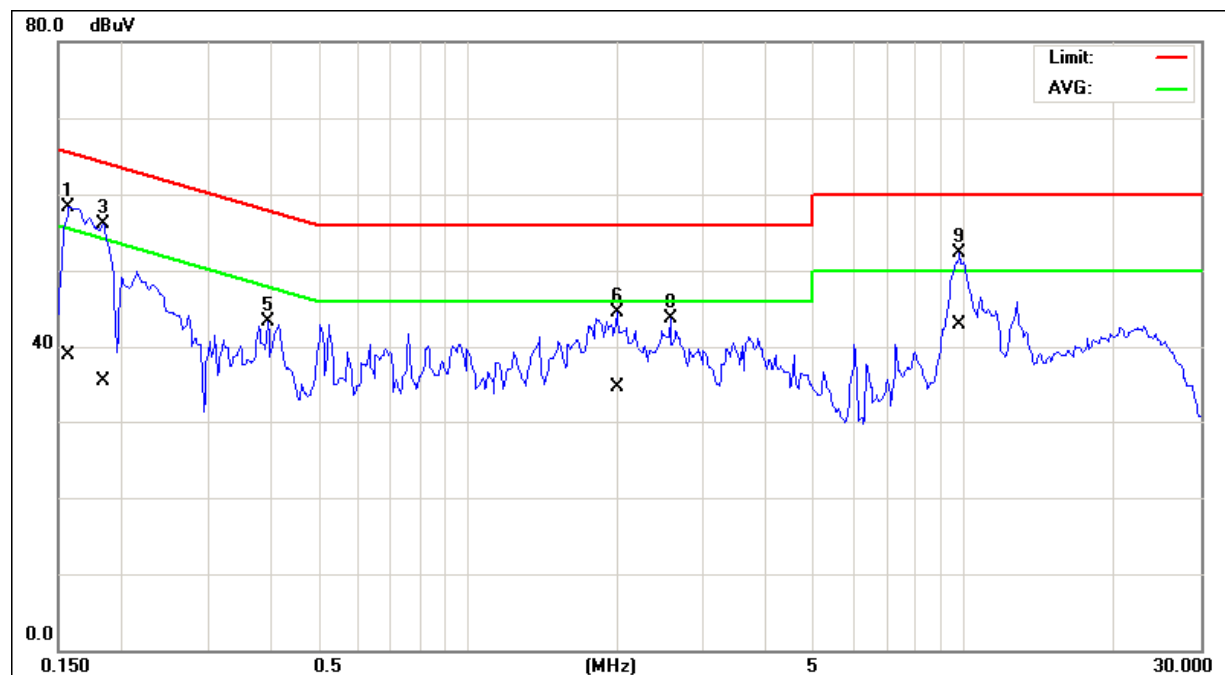

EUT:	BLU-RAY Disc Player	Model Name. :	DX-WBRDVD1
Temperature:	25 °C	Relative Humidity :	53 %
Pressure:	1010hPa	Test Power :	AC 120V/60Hz
Test Mode :	Connect Internet via Ethernet port		

Freq. (MHz)	Terminal L/N	Measured(dBuV)		Limits(dBuV)		Margin (dB)	Note
		QP-Mode	AV-Mode	QP-Mode	AV-Mode		
0.15	Line	55.19	35.72	65.78	55.78	-10.59	(QP)
0.21	Line	44.41	*	63.11	53.11	-18.70	(QP)
0.70	Line	37.49	*	56.00	46.00	-18.51	(QP)
1.40	Line	39.28	*	56.00	46.00	-16.72	(QP)
3.76	Line	42.66	*	56.00	46.00	-13.34	(QP)
9.84	Line	49.94	36.71	60.00	50.00	-10.06	(QP)

**Remark**

- (1) All readings are QP Mode value unless otherwise stated AVG in column of 『Note』 . If the QP Mode Measured value compliance with the QP Limits and lower than AVG Limits, the EUT shall be deemed to meet both QP & AVG Limits and then only QP Mode was measured, but AVG Mode didn't perform. In this case, a " \* " marked in AVG Mode column of Interference Voltage Measured.
- (2) Measuring frequency range from 150KHz to 30MHz.

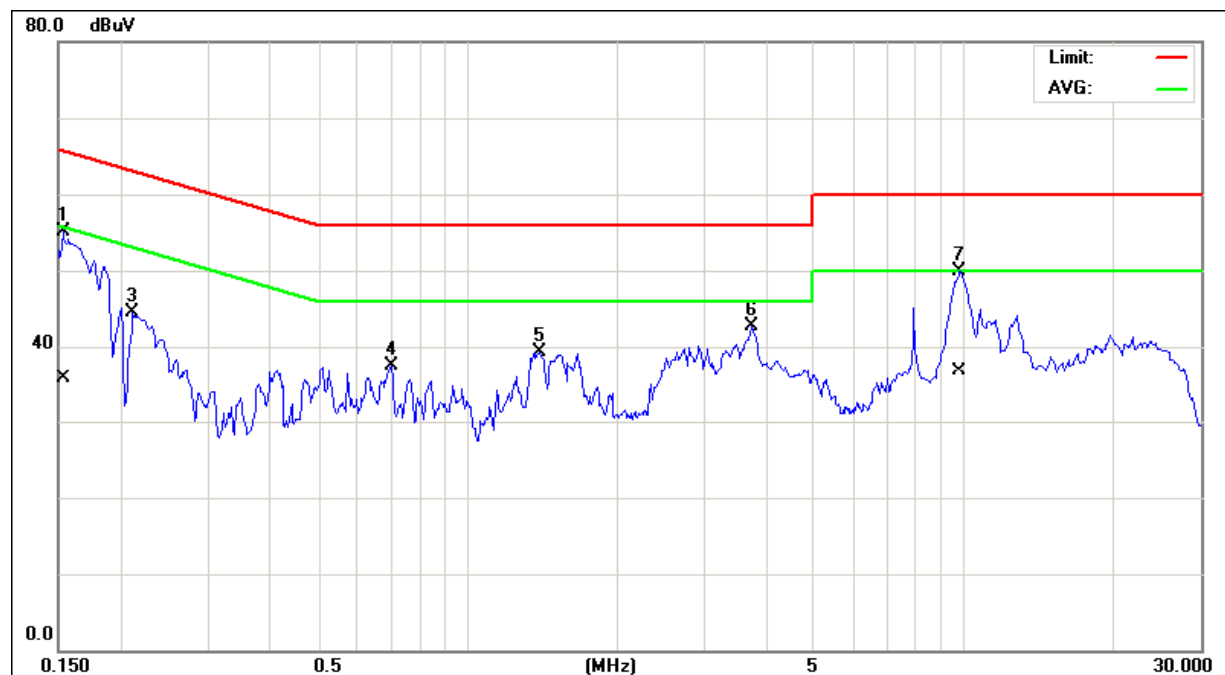



EUT:	BLU-RAY Disc Player	Model Name. :	DX-WBRDVD1
Temperature:	25 °C	Relative Humidity :	53 %
Pressure:	1010hPa	Test Power :	AC 120V/60Hz
Test Mode :	Connect Internet via Ethernet port		

Freq. (MHz)	Terminal L/N	Measured(dBuV)		Limits(dBuV)		Margin (dB)	Note
		QP-Mode	AV-Mode	QP-Mode	AV-Mode		
0.17	Neutral	55.05	36.06	65.18	55.18	-10.13	(QP)
0.22	Neutral	46.41	*	62.96	52.96	-16.55	(QP)
0.40	Neutral	41.86	*	57.94	47.94	-16.08	(QP)
0.83	Neutral	39.69	*	56.00	46.00	-16.31	(QP)
1.81	Neutral	41.15	*	56.00	46.00	-14.85	(QP)
10.80	Neutral	46.44	*	60.00	50.00	-13.56	(QP)

**Remark**

- (1) All readings are QP Mode value unless otherwise stated AVG in column of 『Note』 . If the QP Mode Measured value compliance with the QP Limits and lower than AVG Limits, the EUT shall be deemed to meet both QP & AVG Limits and then only QP Mode was measured, but AVG Mode didn't perform. In this case, a " \* " marked in AVG Mode column of Interference Voltage Measured.
- (2) Measuring frequency range from 150KHz to 30MHz.

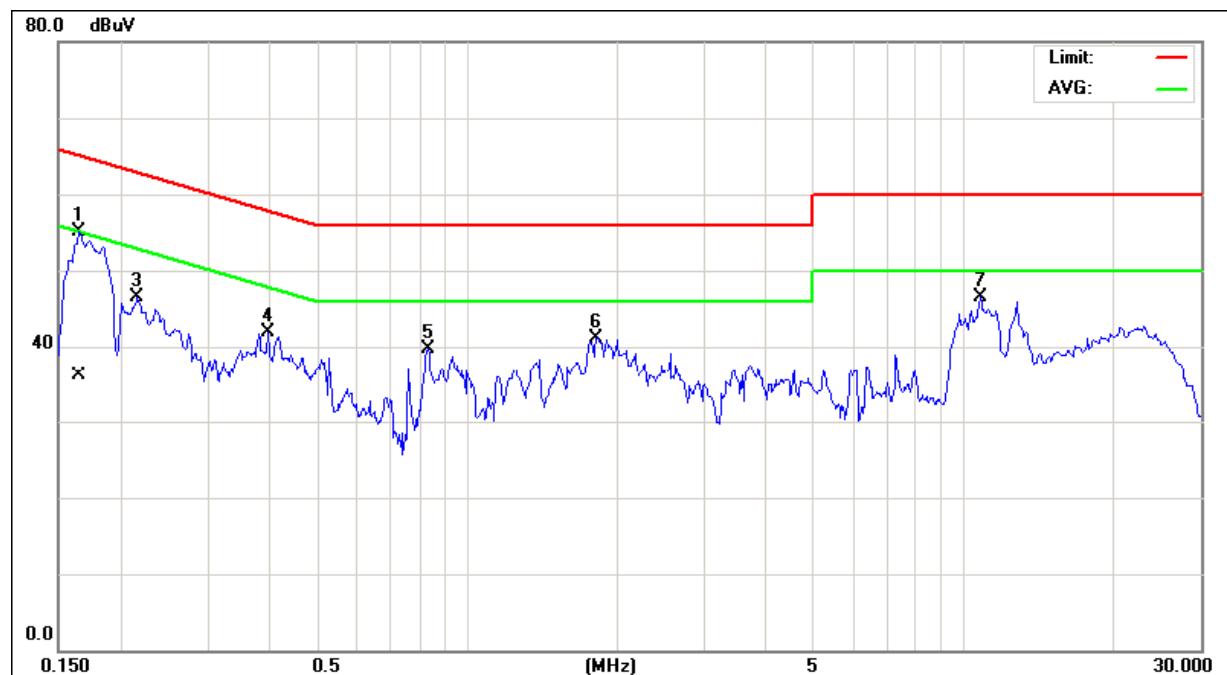

EUT:	BLU-RAY Disc Player	Model Name. :	DX-WBRDVD1
Temperature:	25 °C	Relative Humidity :	53 %
Pressure:	1010hPa	Test Power :	AC 120V/60Hz
Test Mode :	Transmitting+Receiving		

Freq. (MHz)	Terminal L/N	Measured(dBuV)		Limits(dBuV)		Margin (dB)	Note
		QP-Mode	AV-Mode	QP-Mode	AV-Mode		
0.16	Line	57.02	39.81	65.58	55.58	-8.56	(QP)
0.38	Line	40.93	*	58.27	48.27	-17.34	(QP)
0.97	Line	37.32	*	56.00	46.00	-18.68	(QP)
1.96	Line	40.65	*	56.00	46.00	-15.35	(QP)
2.52	Line	40.95	*	56.00	46.00	-15.05	(QP)
12.81	Line	46.53	*	60.00	50.00	-13.47	(QP)

**Remark**

- (1) All readings are QP Mode value unless otherwise stated AVG in column of 『Note』 . If the QP Mode Measured value compliance with the QP Limits and lower than AVG Limits, the EUT shall be deemed to meet both QP & AVG Limits and then only QP Mode was measured, but AVG Mode didn't perform. In this case, a " \* " marked in AVG Mode column of Interference Voltage Measured.
- (2) Measuring frequency range from 150KHz to 30MHz.

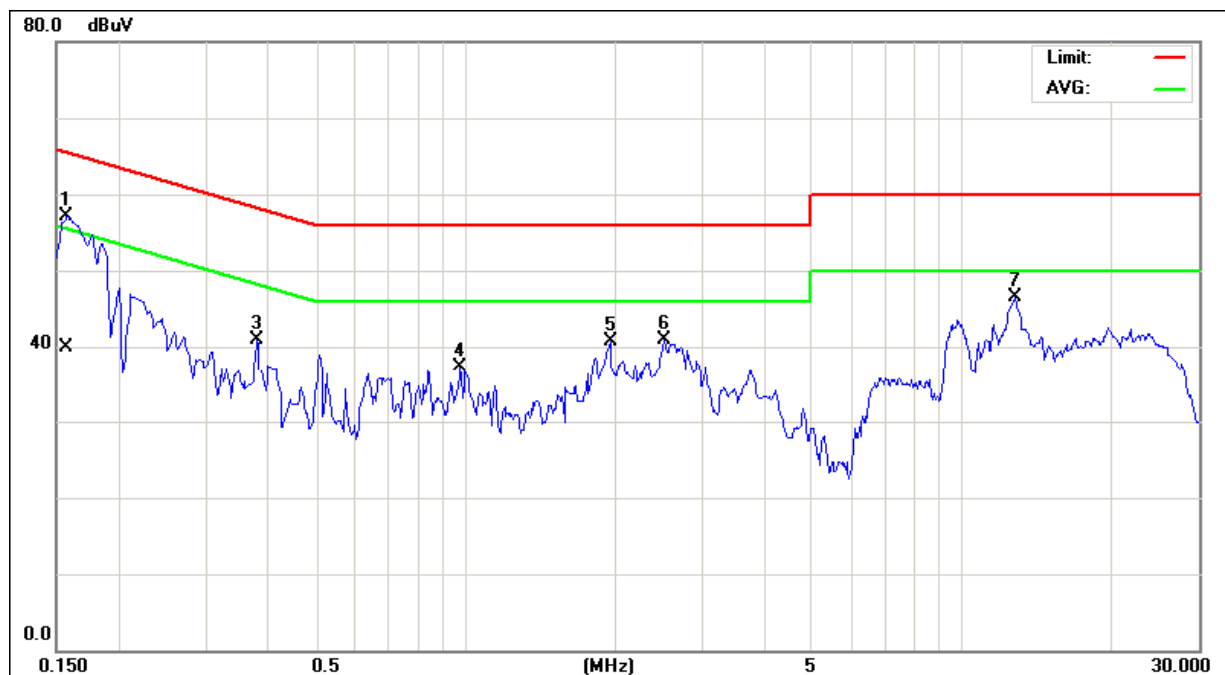

EUT:	BLU-RAY Disc Player	Model Name. :	DX-WBRDVD1
Temperature:	25 °C	Relative Humidity :	53 %
Pressure:	1010hPa	Test Power :	AC 120V/60Hz
Test Mode :	Transmitting+Receiving		

Freq. (MHz)	Terminal L/N	Measured(dBuV)		Limits(dBuV)		Margin (dB)	Note
		QP-Mode	AV-Mode	QP-Mode	AV-Mode		
0.16	Neutral	54.37	36.61	65.58	55.58	-11.21	(QP)
0.38	Neutral	38.71	*	58.27	48.27	-19.56	(QP)
0.63	Neutral	41.25	*	56.00	46.00	-14.75	(QP)
2.00	Neutral	41.43	*	56.00	46.00	-14.57	(QP)
9.84	Neutral	45.24	*	60.00	50.00	-14.76	(QP)
23.11	Neutral	42.64	*	60.00	50.00	-17.36	(QP)

**Remark**

- (1) All readings are QP Mode value unless otherwise stated AVG in column of 『Note』 . If the QP Mode Measured value compliance with the QP Limits and lower than AVG Limits, the EUT shall be deemed to meet both QP & AVG Limits and then only QP Mode was measured, but AVG Mode didn't perform. In this case, a " \* " marked in AVG Mode column of Interference Voltage Measured.
- (2) Measuring frequency range from 150KHz to 30MHz.

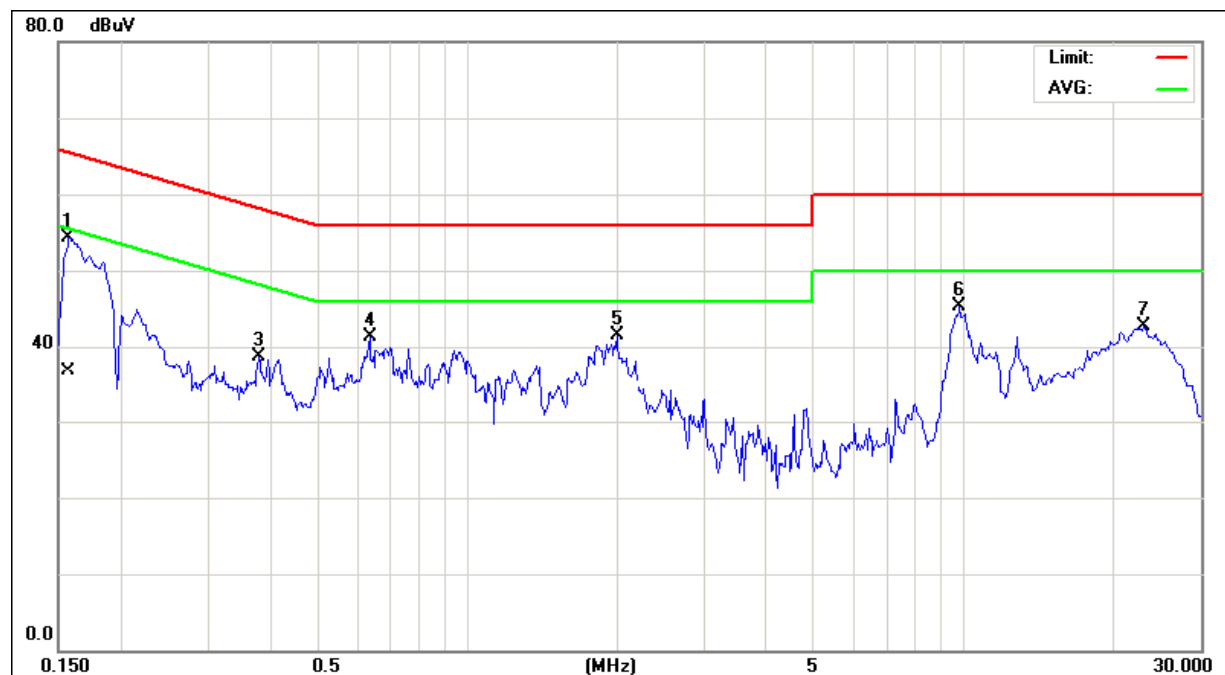

## 3.2. RADIATED EMISSION MEASUREMENT

### 3.2.1. Radiated Emission Limits

(Frequency Range 9KHz-1000MHz)

20dBc in any 100 kHz bandwidth outside the operating frequency band. In case the emission fall within the restricted band specified on 15.205(a), then the 15.209(a) limit in the table below has to be followed.

Frequencies (MHz)	Field Strength (micorvolts/meter)	Measurement Distance (meters)
0.009~0.490	2400/F(KHz)	300
0.490~1.705	24000/F(KHz)	30
1.705~30.0	30	30
30~88	100	3
88~216	150	3
216~960	200	3
Above 960	500	3

#### LIMITS OF RADIATED EMISSION MEASUREMENT (Above 1000MHz)

FREQUENCY (MHz)	(dBuV/m) (at 3m)	
	PEAK	AVERAGE
Above 1000	74	54

Notes:

- (1) The limit for radiated test was performed according to FCC PART 15C.
- (2) The tighter limit applies at the band edges.
- (3) Emission level (dBuV/m)=20log Emission level (uV/m).

**FREQUENCY RANGE OF RADIATED MEASUREMENT (For unintentional radiators)**

Highest frequency generated or Upper frequency of measurement used in the device or on which the device operates or tunes (MHz)	Range (MHz)
Below 1.705	30
1.705 – 108	1000
108 – 500	2000
500 – 1000	5000
Above 1000	5 <sup>th</sup> harmonic of the highest frequency or 40 GHz, whichever is lower

**3.2.2. MEASUREMENT INSTRUMENTS LIST AND SETTING**

Item	Kind of Equipment	Manufacturer	Type No.	Serial No.	Calibrated until
1	Triple Loop Antenna	R&S	HFH2-Z2	830749/020	May.27.2011
2	Bi-log Antenna	Schwarzbeck	VULB9160	9160-3232	May.26.2011
3	Horn Antenna	ETS	3115	00075789	May.12.2011
4	Broad-Band Horn Antenna	Schwarzbeck	BBHA 9170	9170340	Dec.15.2011
5	Amplifier	HP	8447D	2944A09673	May.26.2011
6	Amplifier	Agilent	8449B	3008A02274	May.26.2011
7	Amplifier	EMC	EMC265404 5	980039	Aug.12.2011
8	Test Receiver	R&S	ESCI	100895	May.26.2011
9	Spectrum Analyzer	R&S	FSP 40	100185	Nov.26.2011
10	Test Cable	N/A	C-01_CB03	N/A	Jul.05.2011
11	Test Cable	HUBER+SUHNER	SUCOFLEX_ 8m	313794/4	Apr.11.2012
12	Controller	CT	SC100	N/A	N/A

Remark: " N/A" denotes No Model Name / Serial No. and No Calibration specified.

Spectrum Parameter	Setting
Attenuation	Auto
Start Frequency	1000 MHz
Stop Frequency	10th carrier harmonic
RB / VB  (Emission in restricted band)	1MHz / 1MHz for Peak, 1 MHz / 10Hz for Average

Receiver Parameter	Setting
Attenuation	Auto

Start ~ Stop Frequency	9kHz~150kHz / RB 200Hz for QP
Start ~ Stop Frequency	150kHz~30MHz / RB 9kHz for QP
Start ~ Stop Frequency	30MHz~1000MHz / RB 120kHz for QP

### 3.2.3. TEST PROCEDURE

- a. The measuring distance of at 3 m shall be used for measurements at frequency up to 1GHz. For frequencies above 1GHz, any suitable measuring distance may be used.
- b. The EUT was placed on the top of a rotating table 0.8 meters above the ground at a 3 meter semi-anechoic chamber. The table was rotated 360 degrees to determine the position of the highest radiation.
- c. The height of the equipment or of the substitution antenna shall be 0.8 m; the height of the test antenna shall vary between 1 m to 4 m. Both horizontal and vertical polarizations of the antenna are set to make the measurement.
- d. The initial step in collecting conducted emission data is a spectrum analyzer peak detector mode pre-scanning the measurement frequency range. Significant peaks are then marked and then Quasi Peak detector mode re-measured.
- e. If the Peak Mode measured value compliance with and lower than Quasi Peak Mode Limit, the EUT shall be deemed to meet QP Limits and then no additional QP Mode measurement performed.
- f. For the actual test configuration, please refer to the related Item –EUT Test Photos.

### 3.2.4. DEVIATION FROM TEST STANDARD

No deviation

### 3.2.5. TEST SETUP

(A) Radiated Emission Test Set-Up Frequency Below 1 GHz

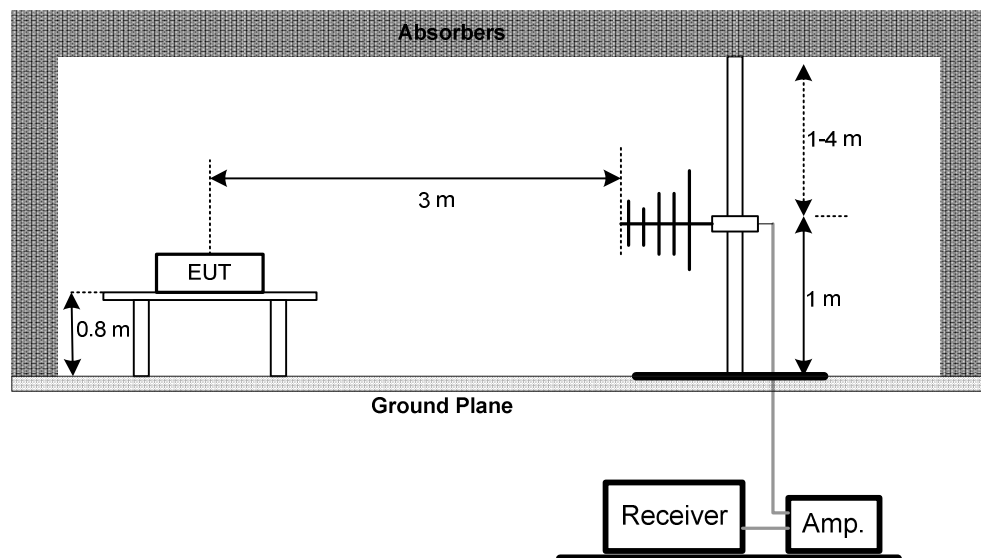

(B) Radiated Emission Test Set-Up Frequency Above 1 GHz

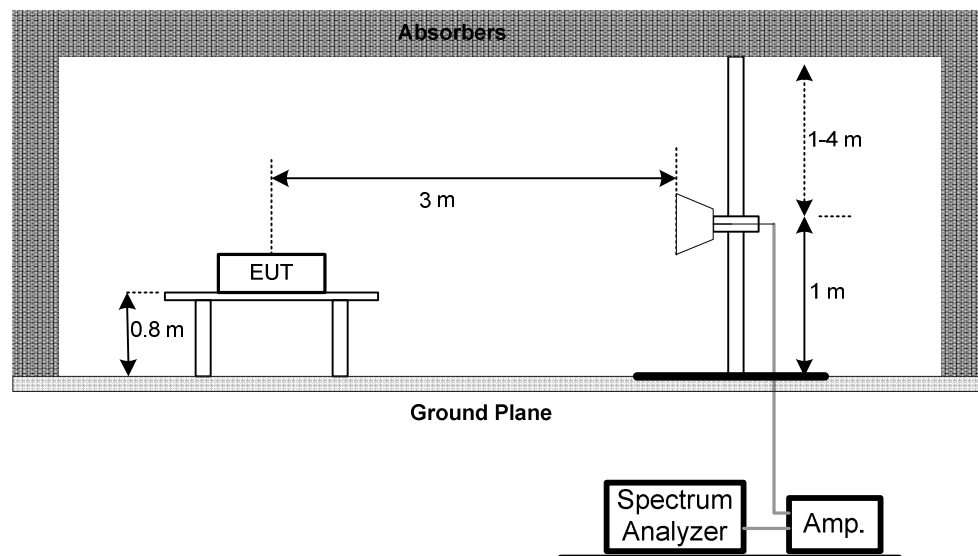



(C) For radiated emissions below 30MHz

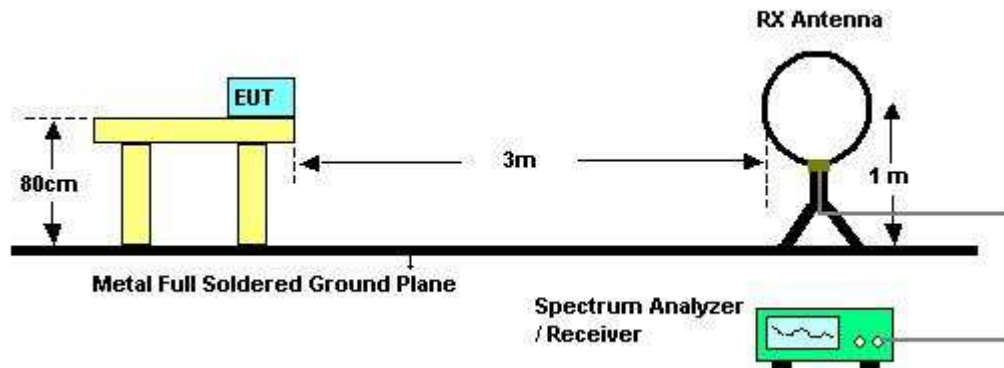

### 3.2.6. EUT OPERATING CONDITIONS

The EUT tested system was configured as the statements of 4.1.6 Unless otherwise a special operating condition is specified in the follows during the testing.

### 3.2.7. TEST RESULTS (BELOW 30MHz)

EUT:	BLU-RAY Disc Player	Model Name :	DX-WBRDVD1
Temperature:	23°C	Relative Humidity:	58 %
Pressure:	1011 hPa	Test Power :	AC 120V/60Hz
Test Mode :	TX Mode		

Freq. (MHz)	Ant. 0°/90°	Reading(RA) (dBuV)	Corr. Factor(CF) (dB)	Measured(FS) (dBuV/m)	Limits(QP) (dBuV/m)	Margin (dB)	Note
0.96	0°	65.01	19.76	45.25	67.96	-22.71	PK
2.51	0°	63.54	19.19	44.35	69.54	-25.19	PK
4.18	0°	62.18	18.86	43.32	69.54	-26.22	PK
12.08	0°	64.19	17.92	46.27	69.54	-23.27	PK
16.35	0°	65.22	17.91	47.31	69.54	-22.23	PK
25.77	0°	63.29	16.11	47.18	69.54	-22.36	PK

Freq. (MHz)	Ant. 0°/90°	Reading(RA) (dBuV)	Corr.Factor(CF) (dB)	Measured(FS) (dBuV/m)	Limits(QP) (dBuV/m)	Margin (dB)	Note
0.85	90°	67.18	20.20	46.98	69.02	-22.04	PK
2.17	90°	60.29	19.40	40.89	69.54	-28.65	PK
5.26	90°	65.42	18.18	47.24	69.54	-22.30	PK
10.88	90°	63.15	17.85	45.30	69.54	-24.24	PK
14.95	90°	64.84	18.10	46.74	69.54	-22.80	PK
20.24	90°	63.19	17.34	45.85	69.54	-23.69	PK

Remark :

- (1) The amplitude of spurious emissions which are attenuated by more than 20 dB below the permissible value has no need to be reported
- (2) Distance extrapolation factor = 40 log (specific distance / test distance) (dB)
- (3) Limit line = specific limits (dBuV) + distance extrapolation factor

### 3.2.8. TEST RESULTS (Between 30 – 1000 MHz)

EUT:	BLU-RAY Disc Player	Model Name :	DX-WBRDVD1
Temperature:	23 °C	Relative Humidity:	51 %
Pressure:	1010 hPa	Test Voltage :	AC 120V/60Hz
Test Mode :	TX B MODE 2412MHz		

Freq. (MHz)	Ant. H/V	Reading(RA) (dBuV)	Corr.Factor(CF) (dB)	Measured(FS) (dBuV/m)	Limits(QP) (dBuV/m)	Margin (dB)	Note
46.71	V	45.50	-17.09	28.41	40.00	- 11.59	
100.35	V	48.66	-18.41	30.25	43.50	- 13.25	
128.49	V	49.77	-18.15	31.62	43.50	- 11.88	
212.45	V	43.29	-16.20	27.09	43.50	- 16.41	
338.64	V	43.95	-11.12	32.83	46.00	- 13.17	
521.37	V	38.50	-6.56	31.94	46.00	- 14.06	

Remark :

- (1) Reading in which marked as QP or Peak means measurements by using are Quasi-Peak Mode or Peak Mode with Detector BW=120KHz ; SPA setting in RBW=120KHz, VBW =120KHz, Swp. Time = 0.3 sec./MHz
- (2) All readings are Peak unless otherwise stated QP in column of 『Note』 . Peak denotes that the Peak reading compliance with the QP Limits and then QP Mode measurement didn't perform
- (3) Measuring frequency range from 30MHz to 1000MHz
- (4) If the peak scan value lower limit more than 20dB, then this signal data does not show in table

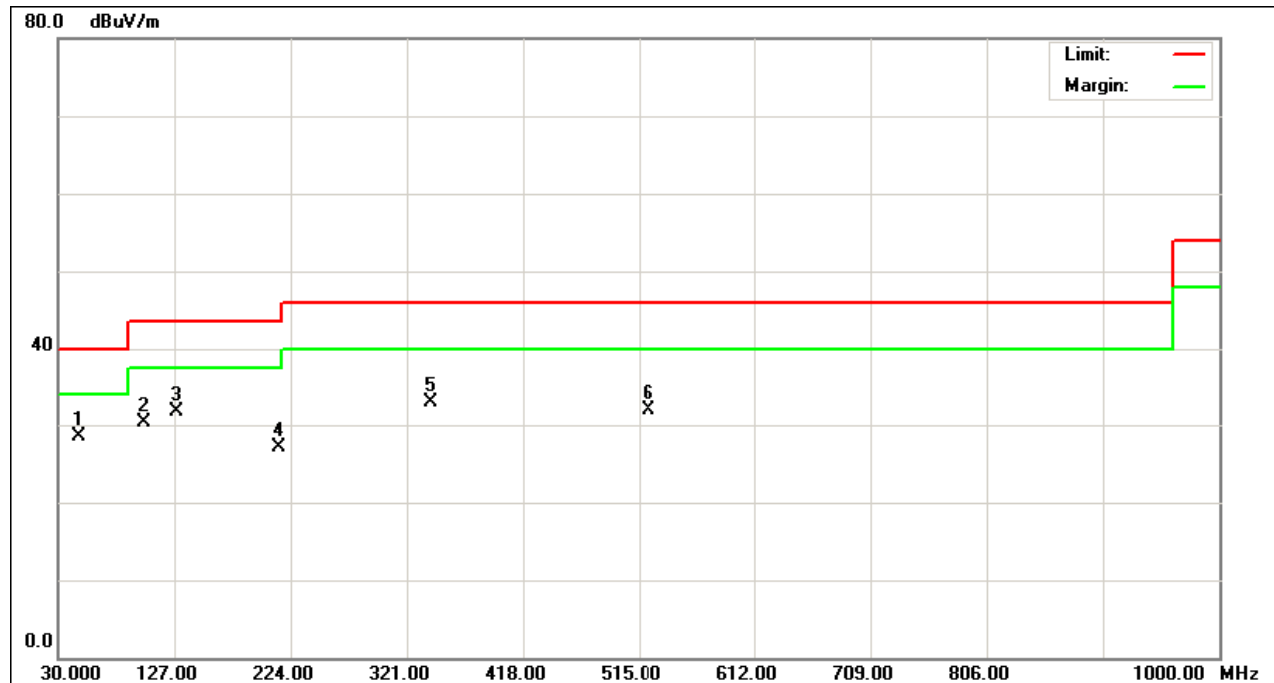

EUT:	BLU-RAY Disc Player	Model Name :	DX-WBRDVD1
Temperature:	23 °C	Relative Humidity:	51 %
Pressure:	1010 hPa	Test Voltage :	AC 120V/60Hz
Test Mode :	TX B MODE 2412MHz		

Freq. (MHz)	Ant. H/V	Reading(RA) (dBuV)	Corr.Factor(CF) (dB)	Measured(FS) (dBuV/m)	Limits(QP) (dBuV/m)	Margin (dB)	Note
35.18	H	44.05	-16.91	27.14	40.00	- 12.86	
88.94	H	51.27	-19.08	32.19	43.50	- 11.31	
212.57	H	44.76	-16.19	28.57	43.50	- 14.93	
324.77	H	42.95	-11.46	31.49	46.00	- 14.51	
352.81	H	43.62	-10.74	32.88	46.00	- 13.12	
528.47	H	40.23	-6.29	33.94	46.00	- 12.06	

**Remark :**

- (1) Reading in which marked as QP or Peak means measurements by using are Quasi-Peak Mode or Peak Mode with Detector BW=120KHz ; SPA setting in RBW=120KHz, VBW =120KHz, Swp. Time = 0.3 sec./MHz
- (2) All readings are Peak unless otherwise stated QP in column of 『Note』 . Peak denotes that the Peak reading compliance with the QP Limits and then QP Mode measurement didn't perform
- (3) Measuring frequency range from 30MHz to 1000MHz
- (4) If the peak scan value lower limit more than 20dB, then this signal data does not show in table

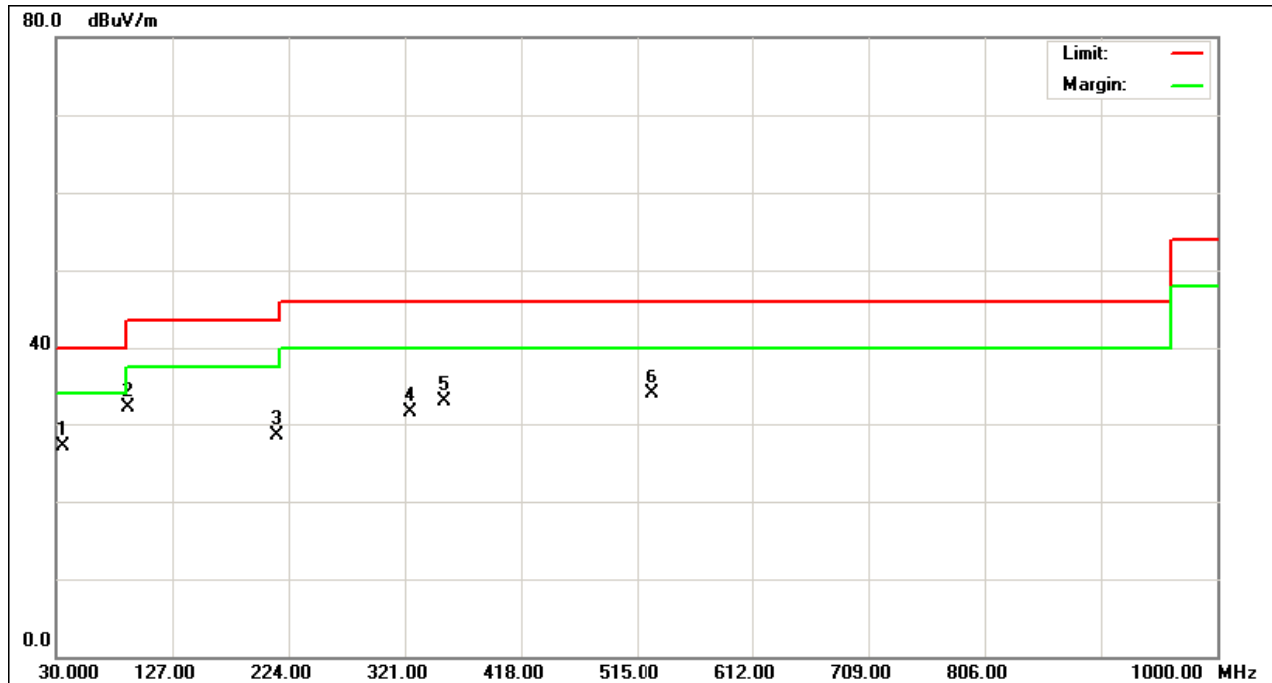

EUT:	BLU-RAY Disc Player	Model Name :	DX-WBRDVD1
Temperature:	23 °C	Relative Humidity:	51 %
Pressure:	1010 hPa	Test Voltage :	AC 120V/60Hz
Test Mode :	RX Mode		

Freq. (MHz)	Ant. H/V	Reading(RA) (dBuV)	Corr.Factor(CF) (dB)	Measured(FS) (dBuV/m)	Limits(QP) (dBuV/m)	Margin (dB)	Note
65.23	V	45.60	-17.64	27.96	40.00	- 12.04	
124.75	V	48.37	-18.20	30.17	43.50	- 13.33	
184.69	V	48.33	-16.81	31.52	43.50	- 11.98	
361.04	V	39.18	-10.44	28.74	46.00	- 17.26	
424.81	V	41.71	-8.57	33.14	46.00	- 12.86	
521.69	V	40.70	-6.55	34.15	46.00	- 11.85	

**Remark :**

- (1) Reading in which marked as QP or Peak means measurements by using are Quasi-Peak Mode or Peak Mode with Detector BW=120KHz ; SPA setting in RBW=120KHz, VBW =120KHz, Swp. Time = 0.3 sec./MHz
- (2) All readings are Peak unless otherwise stated QP in column of 『Note』 . Peak denotes that the Peak reading compliance with the QP Limits and then QP Mode measurement didn't perform
- (3) Measuring frequency range from 30MHz to 1000MHz
- (4) If the peak scan value lower limit more than 20dB, then this signal data does not show in table

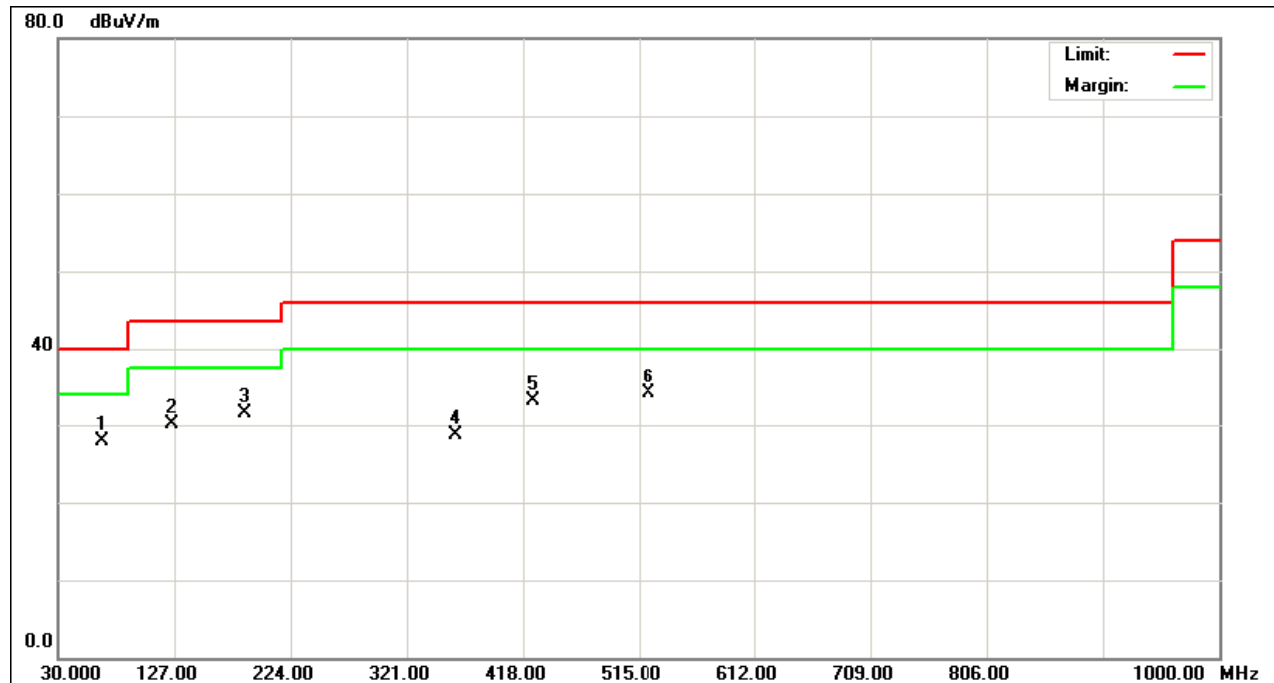

EUT:	BLU-RAY Disc Player	Model Name :	DX-WBRDVD1
Temperature:	23 °C	Relative Humidity :	51 %
Pressure:	1010 hPa	Test Voltage :	AC 120V/60Hz
Test Mode :	RX Mode		

Freq. (MHz)	Ant. H/V	Reading(RA) (dBuV)	Corr.Factor(CF) (dB)	Measured(FS) (dBuV/m)	Limits(QP) (dBuV/m)	Margin (dB)	Note
35.48	H	45.98	-16.92	29.06	40.00	- 10.94	
182.09	H	45.60	-16.86	28.74	43.50	- 14.76	
212.65	H	48.26	-16.18	32.08	43.50	- 11.42	
324.71	H	44.64	-11.47	33.17	46.00	- 12.83	
331.79	H	44.13	-11.28	32.85	46.00	- 13.15	
583.64	H	38.89	-4.67	34.22	46.00	- 11.78	

**Remark :**

- (1) Reading in which marked as QP or Peak means measurements by using are Quasi-Peak Mode or Peak Mode with Detector BW=120KHz ; SPA setting in RBW=120KHz, VBW =120KHz, Swp. Time = 0.3 sec./MHz
- (2) All readings are Peak unless otherwise stated QP in column of 『Note』 . Peak denotes that the Peak reading compliance with the QP Limits and then QP Mode measurement didn't perform
- (3) Measuring frequency range from 30MHz to 1000MHz
- (4) If the peak scan value lower limit more than 20dB, then this signal data does not show in table

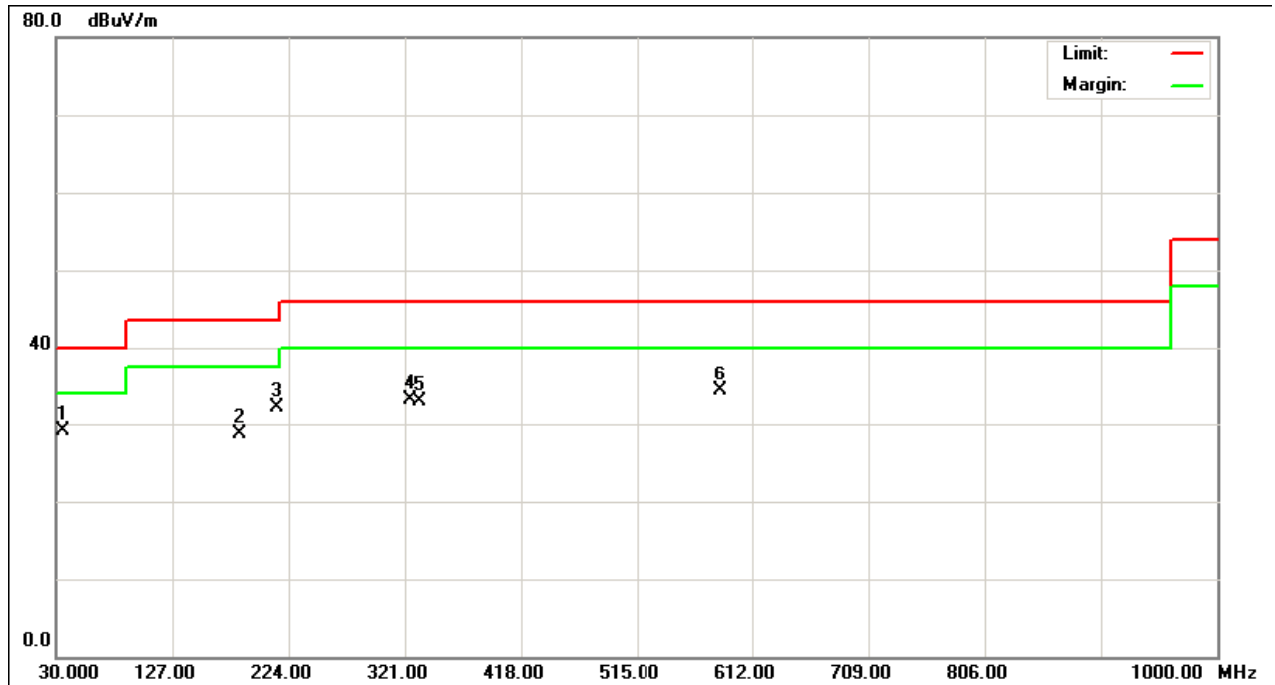

### 3.2.9. TEST RESULTS (Above 1000 MHz)

EUT:	BLU-RAY Disc Player	Model Name :	DX-WBRDVD1
Temperature:	20 °C	Relative Humidity:	53 %
Pressure:	1010 hPa	Test Voltage :	AC 120V/60Hz
Test Mode :	TX B MODE 2412MHz		

Freq.	Ant.Pol.	Reading		Ant./CF	Act.		Limit		Note
		Peak	AV		Peak	AV	Peak	AV	
(MHz)	H/V	(dBuV)	(dBuV)	CF(dB)	(dBuV/m)	(dBuV/m)	(dBuV/m)	(dBuV/m)	
2390.00	V	25.58	15.67	31.54	57.12	47.21	74.00	54.00	X/E
<b>2411.00</b>	<b>V</b>	<b>76.68</b>	<b>72.39</b>	<b>31.57</b>	<b>108.25</b>	<b>103.96</b>			<b>X/F</b>
4824.22	V	49.96	42.52	6.00	55.96	48.52	74.00	54.00	X/H

Remark :

- (1) All readings are Peak unless otherwise stated QP in column of 『Note』 . Peak denotes that the Peak reading compliance with the QP Limits and then QP Mode measurement didn't perform
- (2) Measuring frequency range from 30MHz to 1000MHz or the 10th harmonic of highest fundamental frequency. "F" denotes fundamental frequency; "H" denotes spurious frequency. "E" denotes band edge frequency. (This judgment method includes the Band Edge Requirement.)
- (3) Radiated emissions measured in frequency range above 1000MHz were made with an instrument using Peak detector mode and AV detector mode of the emission
- (4) Data of measurement within this frequency range shown " \* " in the table above means the reading of emissions are attenuated more than 20dB below the permissible limits or the field strength is too small to be measured.
- (5) A preamp and high pass filter were used for this test in order to provide sufficient measurement sensitivity
- (6) EUT Orthogonal Axis :  
 "X" - denotes Laid on Table ; "Y" - denotes Vertical Stand ; "Z" - denotes Side Stand
- (7) During the measurements above 1 GHz it is taken care of that the EUT is always within the 3 dB cone of radiation BW of the used antenna

TX CH01 (Above 1000 MHz, Vertical)

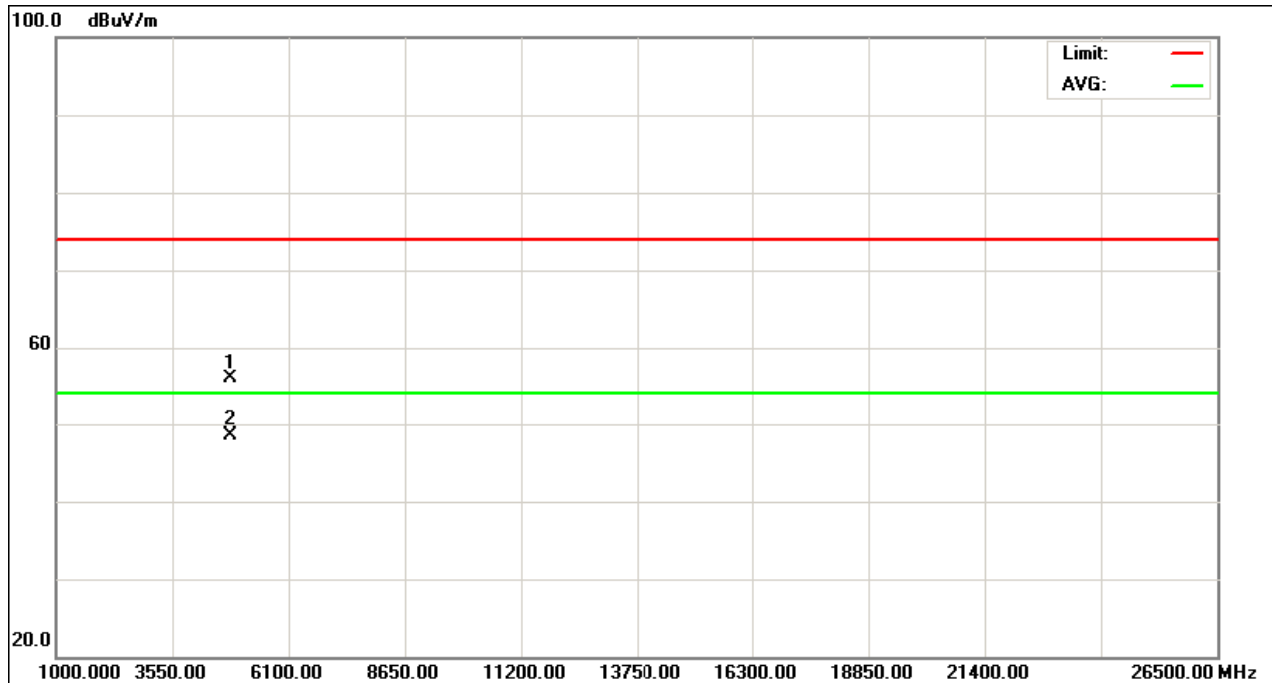
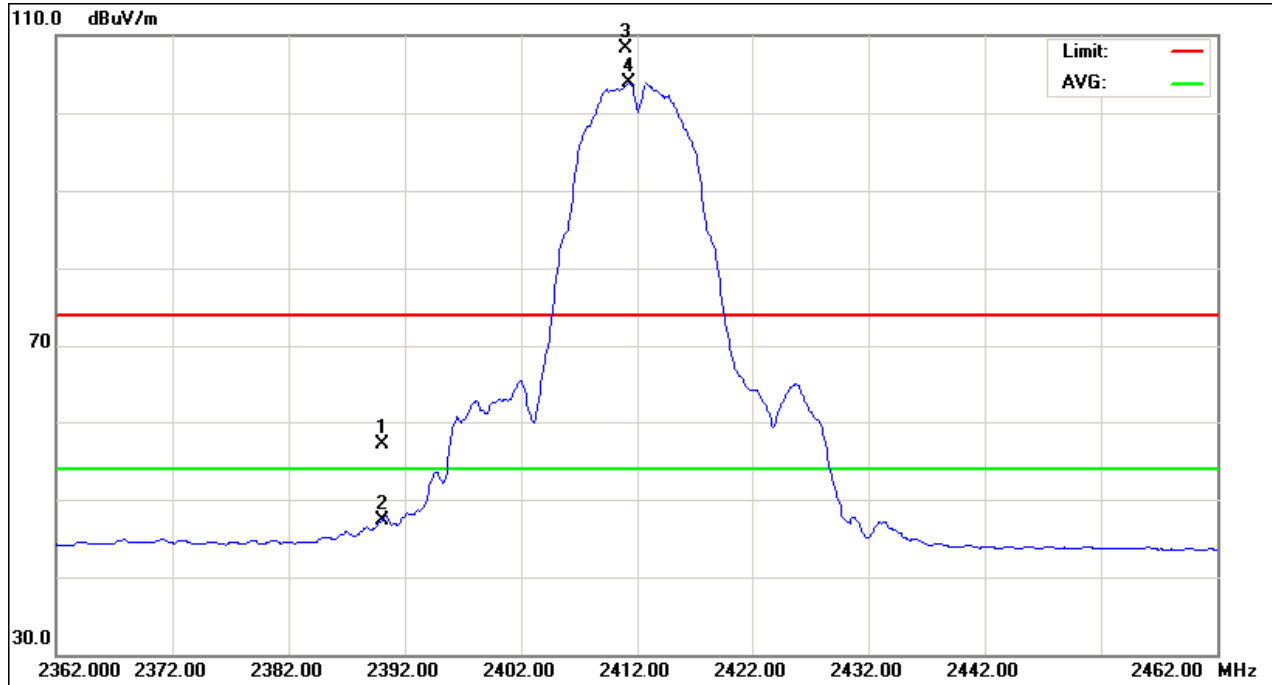



EUT:	BLU-RAY Disc Player	Model Name :	DX-WBRDVD1
Temperature:	20 °C	Relative Humidity:	53 %
Pressure:	1010 hPa	Test Voltage :	AC 120V/60Hz
Test Mode :	TX B MODE 2412MHz		

Freq.	Ant.Pol.	Reading		Ant./CF	Act.		Limit		Note
		Peak	AV		Peak	AV	Peak	AV	
(MHz)	H/V	(dBuV)	(dBuV)	CF(dB)	(dBuV/m)	(dBuV/m)	(dBuV/m)	(dBuV/m)	
2390.00	H	27.91	17.64	31.54	59.45	49.18	74.00	54.00	X/E
<b>2411.10</b>	<b>H</b>	<b>76.83</b>	<b>72.61</b>	<b>31.57</b>	<b>108.40</b>	<b>104.18</b>			<b>X/F</b>
4824.15	H	46.85	39.95	6.00	52.85	45.95	74.00	54.00	X/H

**Remark :**

- (1) All readings are Peak unless otherwise stated QP in column of 『Note』 . Peak denotes that the Peak reading compliance with the QP Limits and then QP Mode measurement didn't perform .
- (2) Measuring frequency range from 30MHz to 1000MHz or the 10th harmonic of highest fundamental frequency. "F" denotes fundamental frequency; "H" denotes spurious frequency. "E" denotes band edge frequency. (This judgment method includes the Band Edge Requirement.)
- (3) Radiated emissions measured in frequency range above 1000MHz were made with an instrument using Peak detector mode and AV detector mode of the emission .
- (4) Data of measurement within this frequency range shown " \* " in the table above means the reading of emissions are attenuated more than 20dB below the permissible limits or the field strength is too small to be measured.
- (5) A preamp and high pass filter were used for this test in order to provide sufficient measurement sensitivity.
- (6) EUT Orthogonal Axis :  
"X" - denotes Laid on Table ; "Y" - denotes Vertical Stand ; "Z" - denotes Side Stand
- (7) During the measurements above 1 GHz it is taken care of that the EUT is always within the 3 dB cone of radiation BW of the used antenna

TX CH01 (Above 1000 MHz, Horizontal)

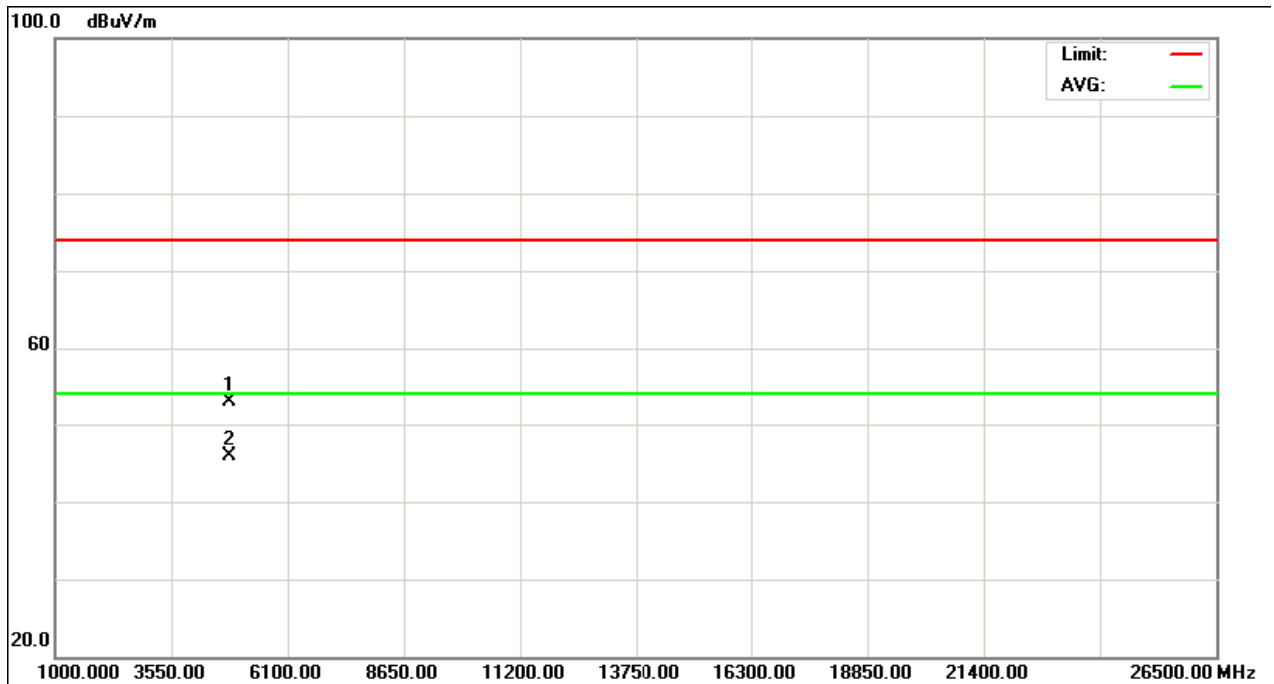
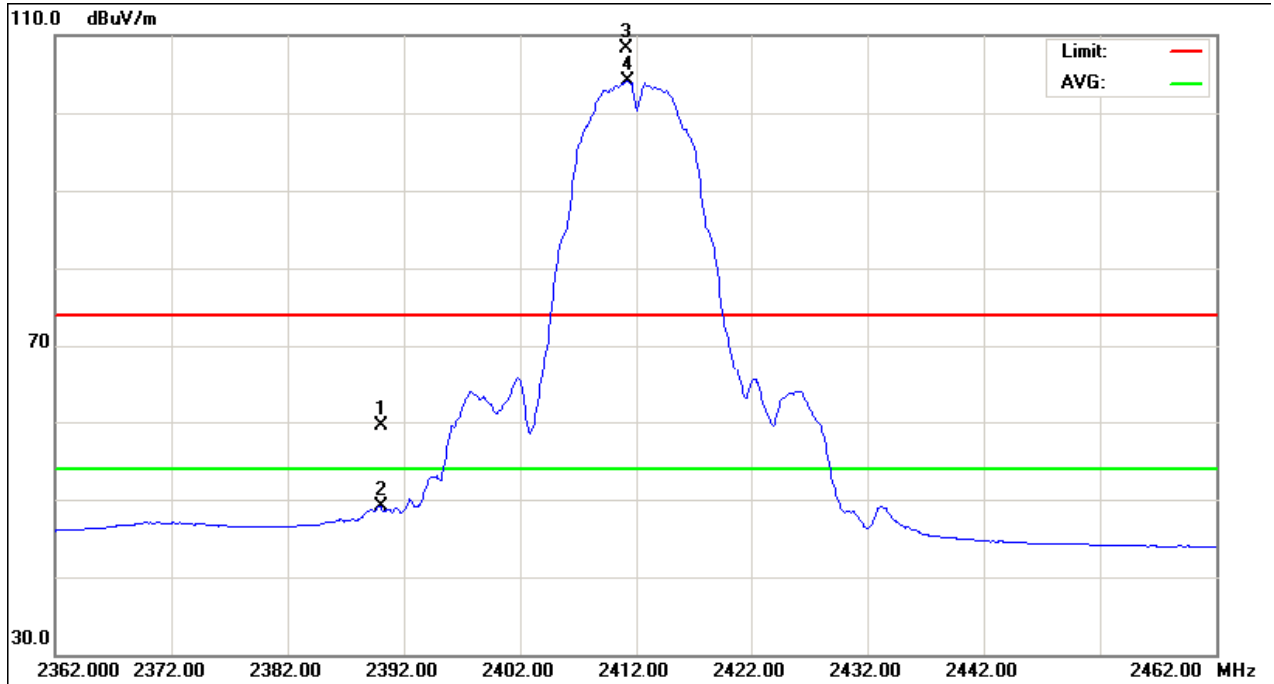

EUT:	BLU-RAY Disc Player	Model Name :	DX-WBRDVD1
Temperature:	20 °C	Relative Humidity:	53 %
Pressure:	1010 hPa	Test Voltage :	AC 120V/60Hz
Test Mode :	TX B MODE 2437MHz		

Freq.	Ant.Pol.	Reading		Ant./CF	Act.		Limit		Note
		Peak	AV		Peak	AV	Peak	AV	
(MHz)	H/V	(dBuV)	(dBuV)	CF(dB)	(dBuV/m)	(dBuV/m)	(dBuV/m)	(dBuV/m)	
<b>2436.00</b>	<b>V</b>	<b>73.85</b>	<b>69.86</b>	<b>31.62</b>	<b>105.47</b>	<b>101.48</b>			<b>X/F</b>
4875.98	V	47.39	40.84	6.15	53.54	46.99	74.00	54.00	X/H

**Remark :**

- (1) All readings are Peak unless otherwise stated QP in column of 『Note』 . Peak denotes that the Peak reading compliance with the QP Limits and then QP Mode measurement didn't perform
- (2) Measuring frequency range from 30MHz to 1000MHz or the 10th harmonic of highest fundamental frequency. "F" denotes fundamental frequency; "H" denotes spurious frequency. "E" denotes band edge frequency. (This judgment method includes the Band Edge Requirement.)
- (3) Radiated emissions measured in frequency range above 1000MHz were made with an instrument using Peak detector mode and AV detector mode of the emission
- (4) Data of measurement within this frequency range shown " \* " in the table above means the reading of emissions are attenuated more than 20dB below the permissible limits or the field strength is too small to be measured.
- (5) A preamp and high pass filter were used for this test in order to provide sufficient measurement sensitivity.
- (6) EUT Orthogonal Axis :  
"X" - denotes Laid on Table ; "Y" - denotes Vertical Stand ; "Z" - denotes Side Stand
- (7) During the measurements above 1 GHz it is taken care of that the EUT is always within the 3 dB cone of radiation BW of the used antenna

TX CH06 (Above 1000 MHz, Vertical)

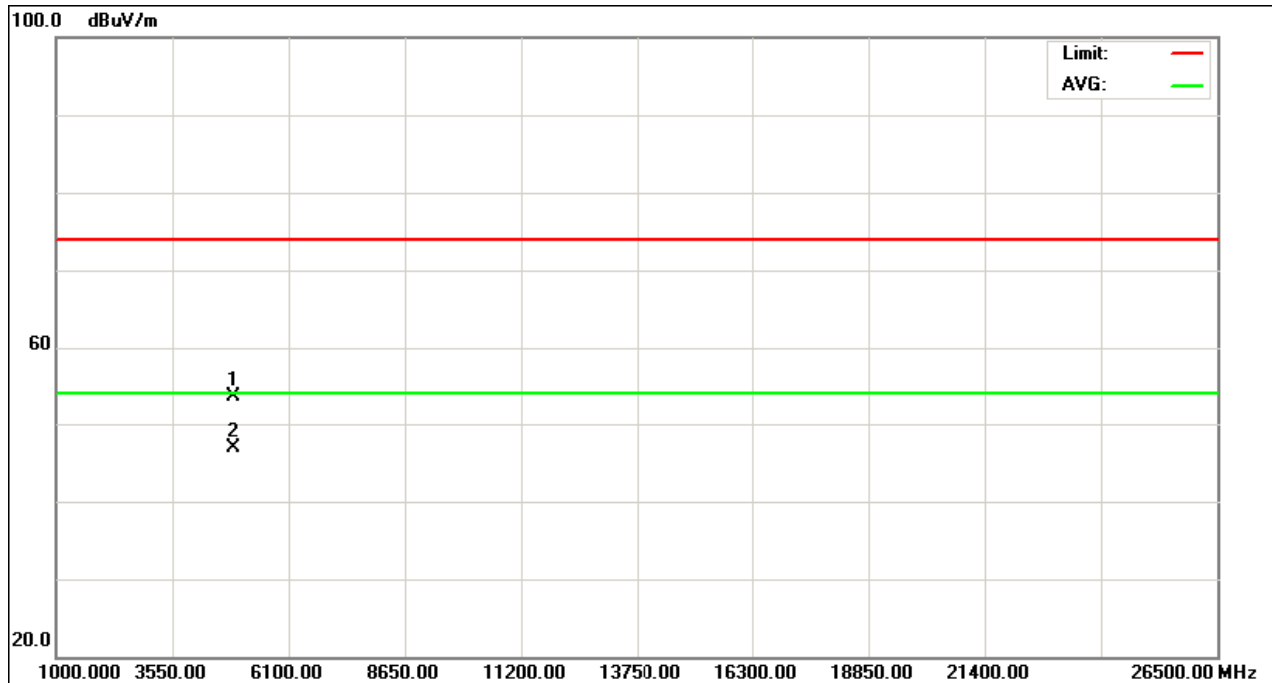
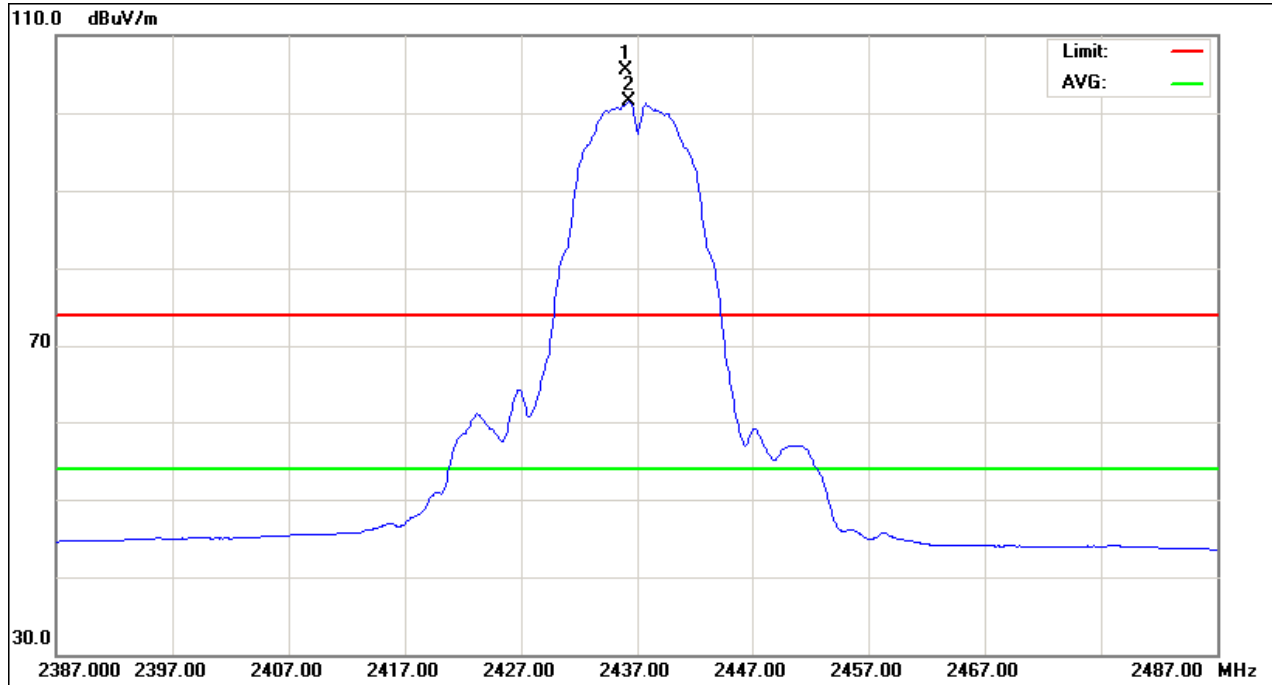

EUT:	BLU-RAY Disc Player	Model Name :	DX-WBRDVD1
Temperature:	20 °C	Relative Humidity:	53 %
Pressure:	1010 hPa	Test Voltage :	AC 120V/60Hz
Test Mode :	TX B MODE 2437MHz		

Freq.	Ant.Pol.	Reading		Ant./CF	Act.		Limit		Note
		Peak	AV		Peak	AV	Peak	AV	
(MHz)	H/V	(dBuV)	(dBuV)	CF(dB)	(dBuV/m)	(dBuV/m)	(dBuV/m)	(dBuV/m)	
<b>2436.30</b>	<b>H</b>	<b>75.15</b>	<b>71.03</b>	<b>31.62</b>	<b>106.77</b>	<b>102.65</b>			<b>X/F</b>
4875.88	H	47.99	41.37	6.15	54.14	47.52	74.00	54.00	X/H

**Remark :**

- (1) All readings are Peak unless otherwise stated QP in column of 『Note』 . Peak denotes that the Peak reading compliance with the QP Limits and then QP Mode measurement didn't perform
- (2) Measuring frequency range from 30MHz to 1000MHz or the 10th harmonic of highest fundamental frequency. "F" denotes fundamental frequency; "H" denotes spurious frequency. "E" denotes band edge frequency. (This judgment method includes the Band Edge Requirement.)
- (3) Radiated emissions measured in frequency range above 1000MHz were made with an instrument using Peak detector mode and AV detector mode of the emission
- (4) Data of measurement within this frequency range shown " \* " in the table above means the reading of emissions are attenuated more than 20dB below the permissible limits or the field strength is too small to be measured.
- (5) A preamp and high pass filter were used for this test in order to provide sufficient measurement sensitivity.
- (6) EUT Orthogonal Axis :  
 "X" - denotes Laid on Table ; "Y" - denotes Vertical Stand ; "Z" - denotes Side Stand
- (7) During the measurements above 1 GHz it is taken care of that the EUT is always within the 3 dB cone of radiation BW of the used antenna

TX CH06 (Above 1000 MHz, Horizontal)

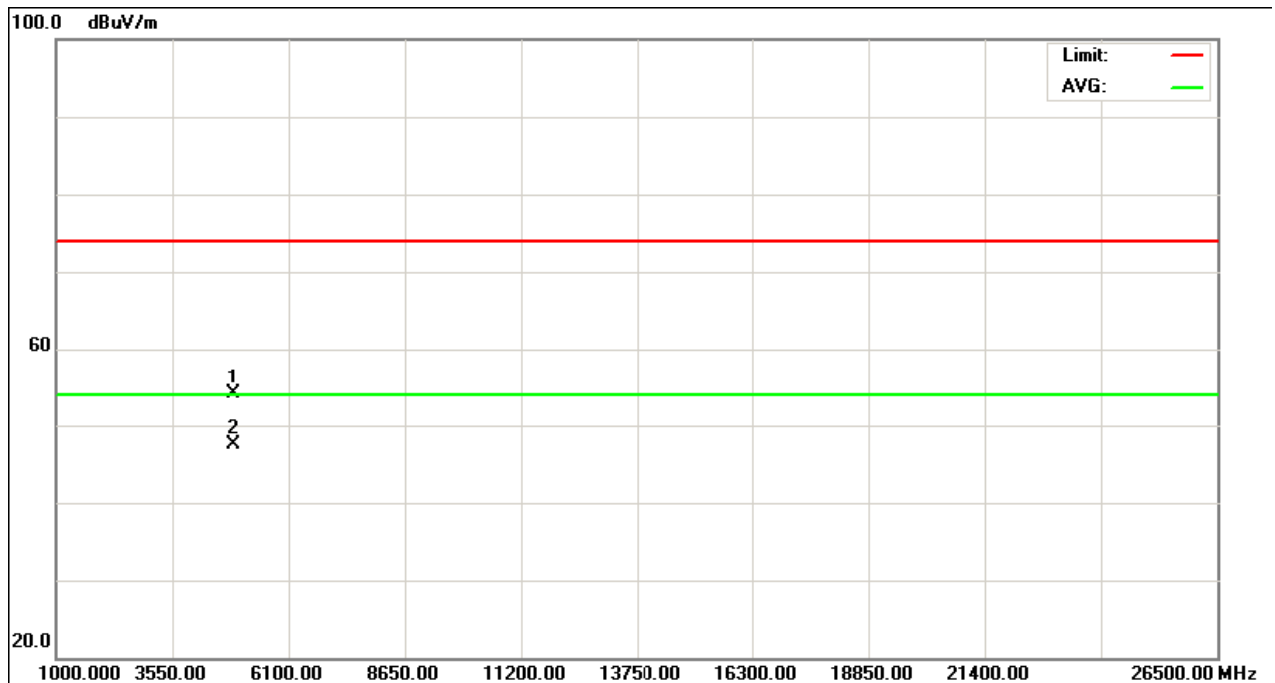
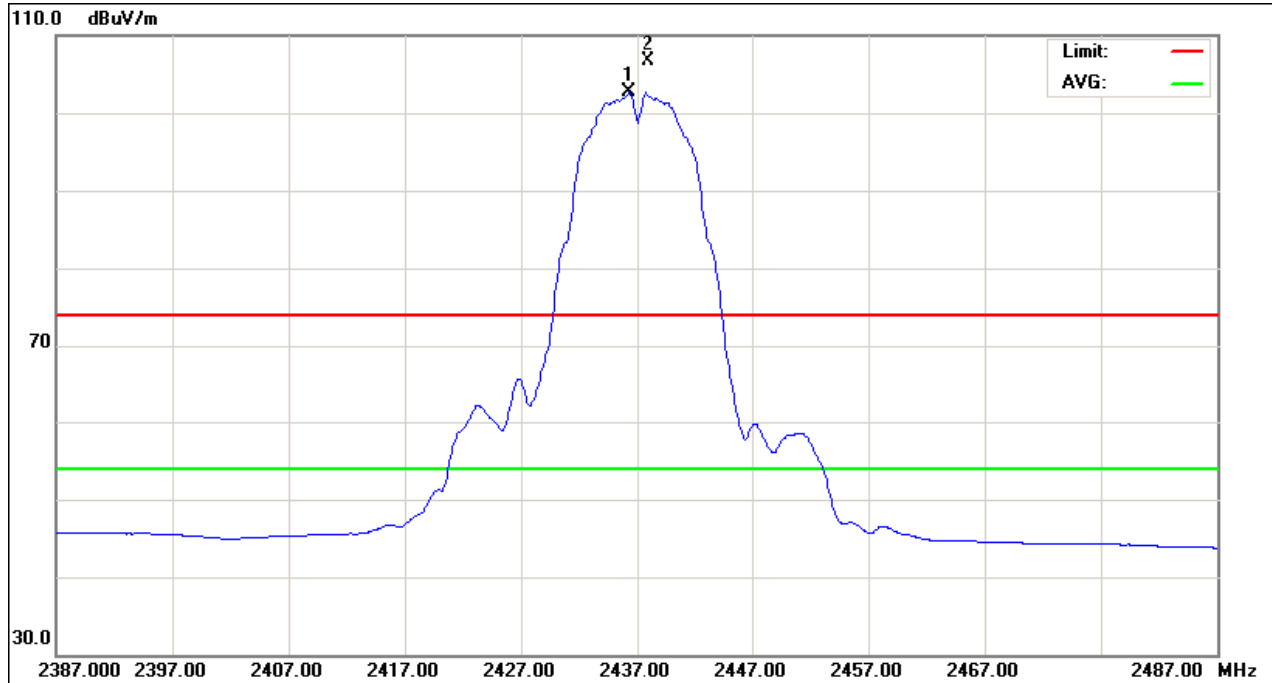

EUT:	BLU-RAY Disc Player	Model Name :	DX-WBRDVD1
Temperature:	20 °C	Relative Humidity:	53 %
Pressure:	1010 hPa	Test Voltage :	AC 120V/60Hz
Test Mode :	TX B MODE 2462MHz		

Freq.	Ant.Pol.	Reading		Ant./CF	Act.		Limit		Note
		Peak	AV		Peak	AV	Peak	AV	
(MHz)	H/V	(dBuV)	(dBuV)	CF(dB)	(dBuV/m)	(dBuV/m)	(dBuV/m)	(dBuV/m)	
<b>2463.10</b>	<b>V</b>	<b>72.98</b>	<b>68.89</b>	<b>31.65</b>	<b>104.64</b>	<b>100.54</b>			<b>X/F</b>
2483.50	V	23.93	13.47	31.70	55.63	45.17	74.00	54.00	X/E
4924.26	V	49.06	40.85	6.30	55.36	47.15	74.00	54.00	X/H

**Remark :**

- (1) All readings are Peak unless otherwise stated QP in column of 『Note』 . Peak denotes that the Peak reading compliance with the QP Limits and then QP Mode measurement didn't perform
- (2) Measuring frequency range from 30MHz to 1000MHz or the 10th harmonic of highest fundamental frequency. "F" denotes fundamental frequency; "H" denotes spurious frequency. "E" denotes band edge frequency. (This judgment method includes the Band Edge Requirement.)
- (3) Radiated emissions measured in frequency range above 1000MHz were made with an instrument using Peak detector mode and AV detector mode of the emission
- (4) Data of measurement within this frequency range shown " \* " in the table above means the reading of emissions are attenuated more than 20dB below the permissible limits or the field strength is too small to be measured.
- (5) A preamp and high pass filter were used for this test in order to provide sufficient measurement sensitivity.
- (6) EUT Orthogonal Axis :  
 "X" - denotes Laid on Table ; "Y" - denotes Vertical Stand ; "Z" - denotes Side Stand
- (7) During the measurements above 1 GHz it is taken care of that the EUT is always within the 3 dB cone of radiation BW of the used antenna

TX CH11 (Above 1000 MHz, Vertical)

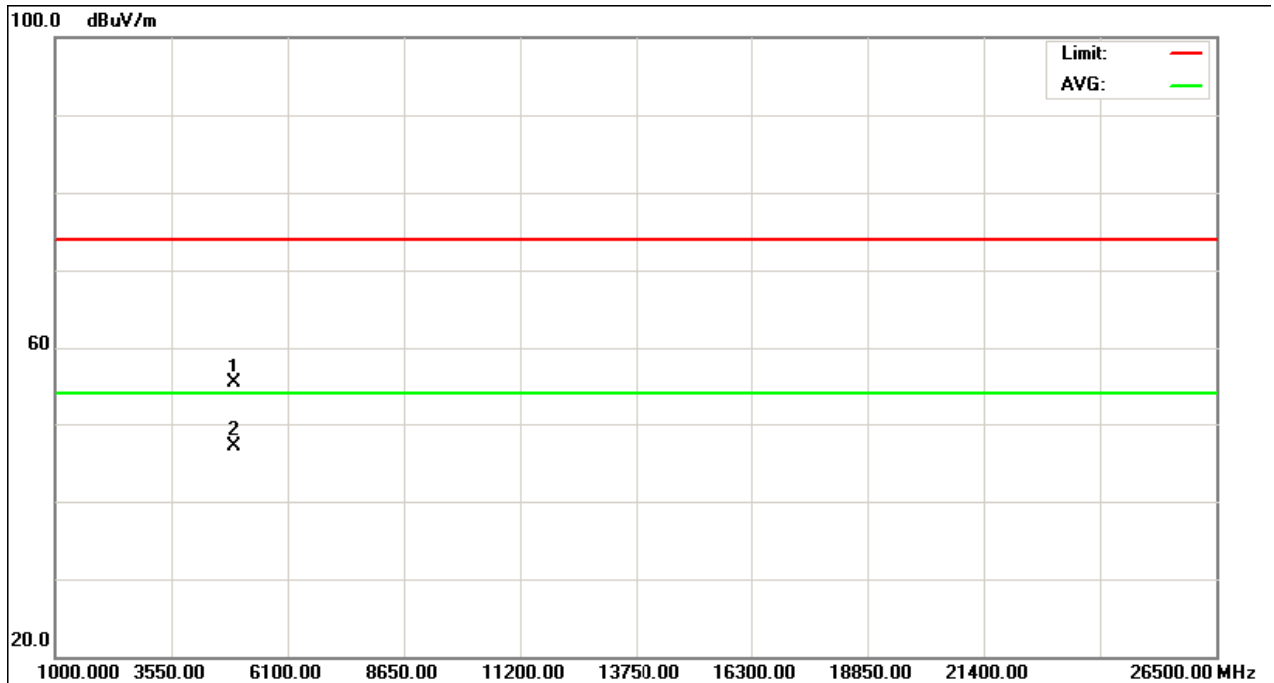
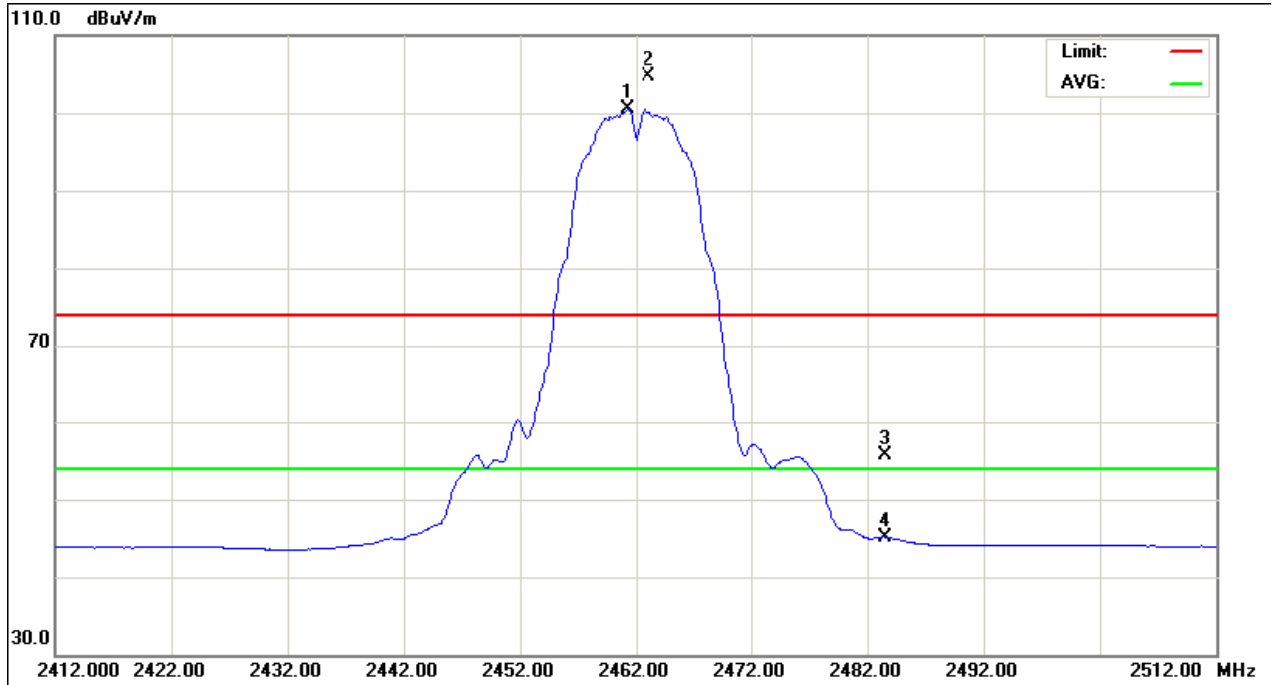



EUT:	BLU-RAY Disc Player	Model Name :	DX-WBRDVD1
Temperature:	20 °C	Relative Humidity:	51 %
Pressure:	1010 hPa	Test Voltage :	AC 120V/60Hz
Test Mode :	TX B MODE 2462MHz		

Freq.	Ant.Pol.	Reading		Ant./CF	Act.		Limit		Note
		Peak	AV		Peak	AV	Peak	AV	
(MHz)	H/V	(dBuV)	(dBuV)	CF(dB)	(dBuV/m)	(dBuV/m)	(dBuV/m)	(dBuV/m)	
<b>2461.00</b>	<b>H</b>	<b>74.13</b>	<b>70.17</b>	<b>31.65</b>	<b>105.78</b>	<b>101.82</b>			<b>X/F</b>
2483.50	H	23.18	13.51	31.70	54.88	45.21	74.00	54.00	X/E
4924.13	H	45.66	39.54	6.30	51.96	45.84	74.00	54.00	X/H

**Remark :**

- (1) All readings are Peak unless otherwise stated QP in column of 『Note』 . Peak denotes that the Peak reading compliance with the QP Limits and then QP Mode measurement didn't perform
- (2) Measuring frequency range from 30MHz to 1000MHz or the 10th harmonic of highest fundamental frequency. "F" denotes fundamental frequency; "H" denotes spurious frequency. "E" denotes band edge frequency. (This judgment method includes the Band Edge Requirement.)
- (3) Radiated emissions measured in frequency range above 1000MHz were made with an instrument using Peak detector mode and AV detector mode of the emission
- (4) Data of measurement within this frequency range shown " \* " in the table above means the reading of emissions are attenuated more than 20dB below the permissible limits or the field strength is too small to be measured.
- (5) A preamp and high pass filter were used for this test in order to provide sufficient measurement sensitivity.
- (6) EUT Orthogonal Axis :  
 "X" - denotes Laid on Table ; "Y" - denotes Vertical Stand ; "Z" - denotes Side Stand
- (7) During the measurements above 1 GHz it is taken care of that the EUT is always within the 3 dB cone of radiation BW of the used antenna

TX CH11 (Above 1000 MHz, Horizontal)

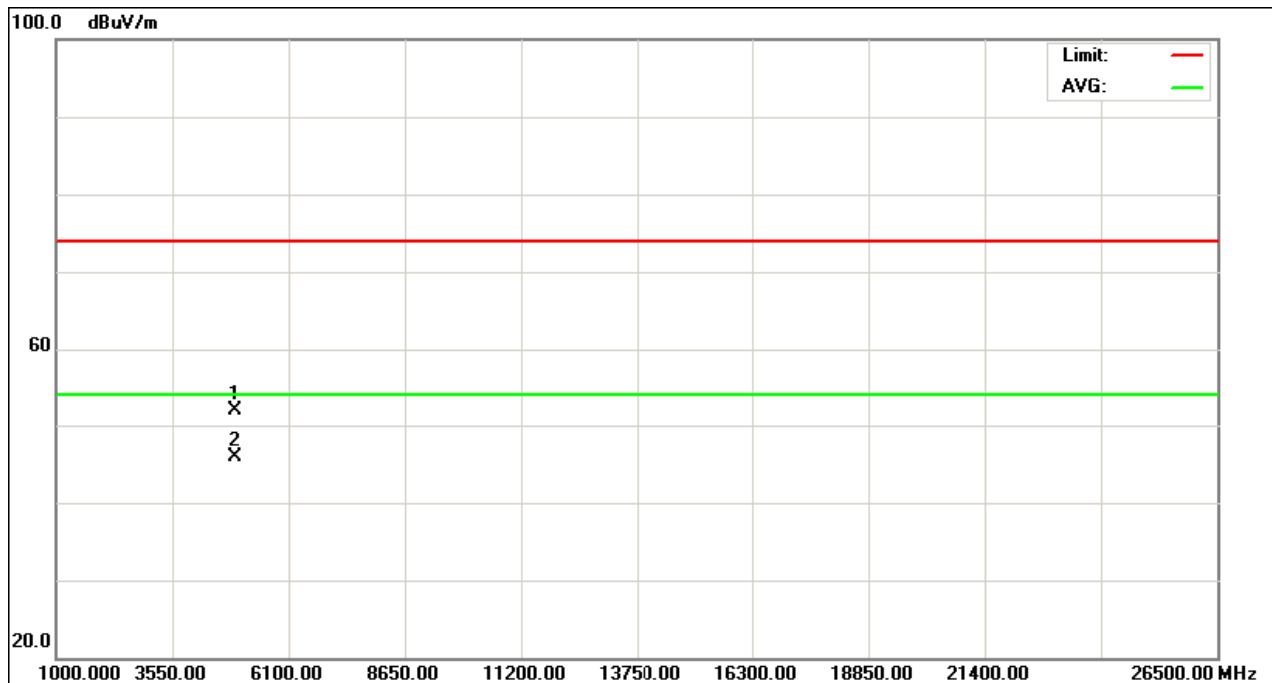
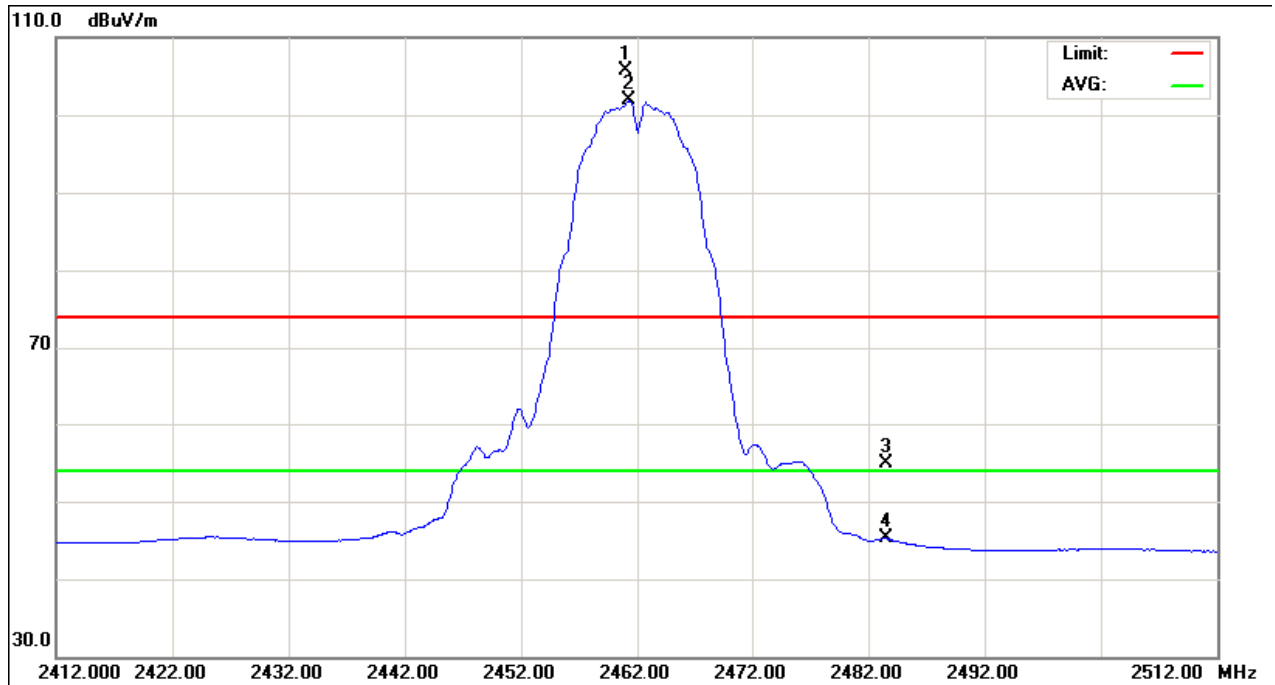

EUT:	BLU-RAY Disc Player	Model Name :	DX-WBRDVD1
Temperature:	20 °C	Relative Humidity:	53 %
Pressure:	1010 hPa	Test Voltage :	AC 120V/60Hz
Test Mode :	TX G MODE 2412MHz		

Freq. (MHz)	Ant.Pol. H/V	Reading		Ant./CF CF(dB)	Act.		Limit		Note
		Peak (dBuV)	AV (dBuV)		Peak (dBuV/m)	AV (dBuV/m)	Peak (dBuV/m)	AV (dBuV/m)	
2390.00	V	40.00	17.05	31.54	71.54	48.59	74.00	54.00	X/E
<b>2411.20</b>	<b>V</b>	<b>67.97</b>	<b>57.09</b>	<b>31.57</b>	<b>99.54</b>	<b>88.66</b>			<b>X/F</b>
4824.07	V	45.06	39.81	6.00	51.06	45.81	74.00	54.00	X/H

**Remark :**

- (1) All readings are Peak unless otherwise stated QP in column of 『Note』 . Peak denotes that the Peak reading compliance with the QP Limits and then QP Mode measurement didn't perform
- (2) Measuring frequency range from 30MHz to 1000MHz or the 10th harmonic of highest fundamental frequency. "F" denotes fundamental frequency; "H" denotes spurious frequency. "E" denotes band edge frequency. (This judgment method includes the Band Edge Requirement.)
- (3) Radiated emissions measured in frequency range above 1000MHz were made with an instrument using Peak detector mode and AV detector mode of the emission
- (4) Data of measurement within this frequency range shown " \* " in the table above means the reading of emissions are attenuated more than 20dB below the permissible limits or the field strength is too small to be measured.
- (5) A preamp and high pass filter were used for this test in order to provide sufficient measurement sensitivity.
- (6) EUT Orthogonal Axis :  
"X" - denotes Laid on Table ; "Y" - denotes Vertical Stand ; "Z" - denotes Side Stand
- (7) During the measurements above 1 GHz it is taken care of that the EUT is always within the 3 dB cone of radiation BW of the used antenna

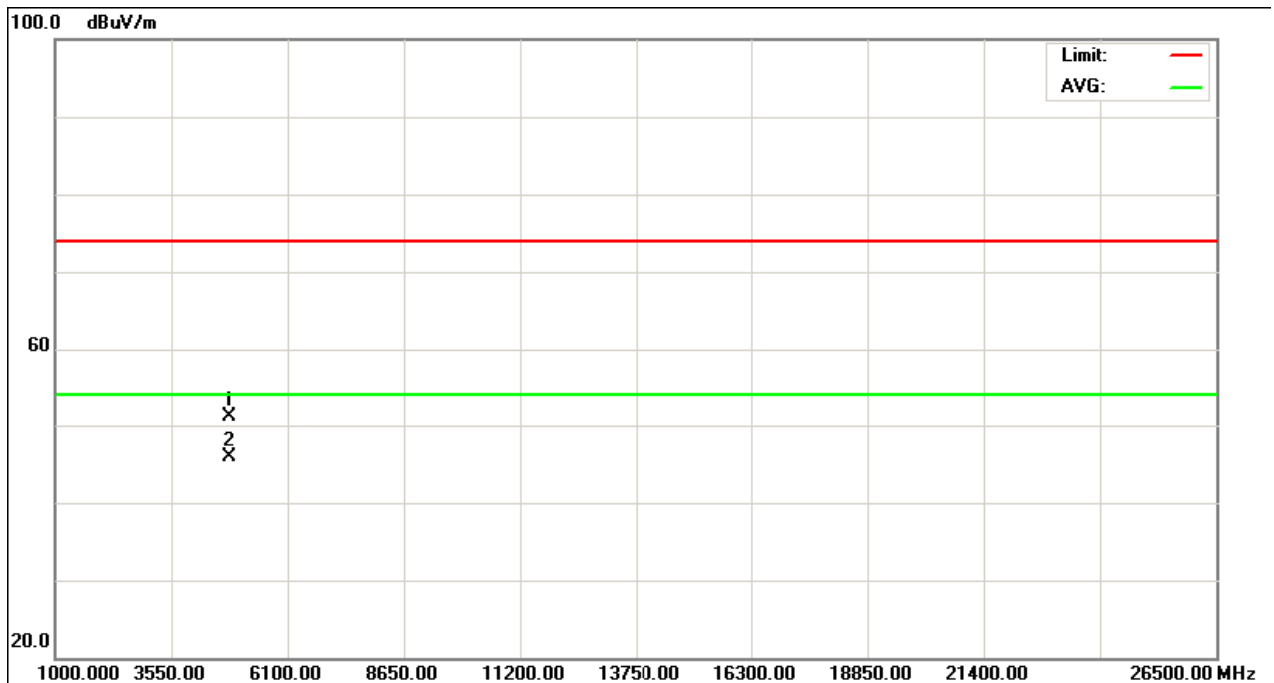
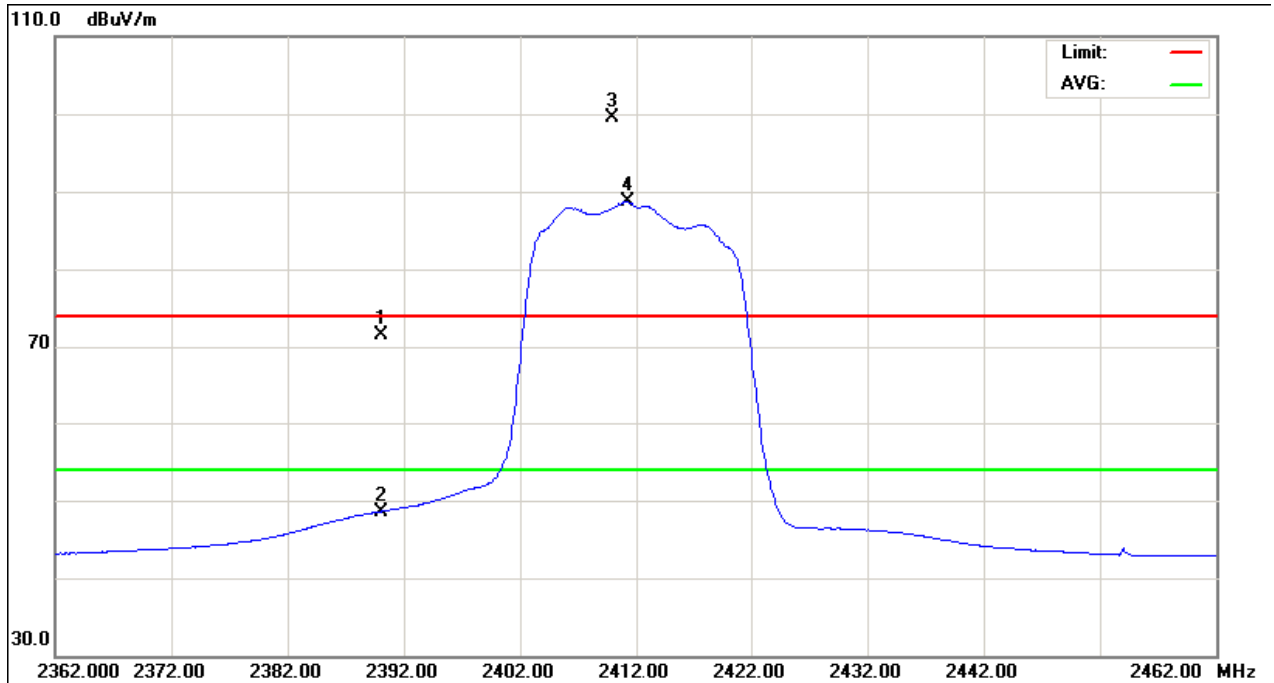
**TX CH01 (Above 1000 MHz, Vertical)**

EUT:	BLU-RAY Disc Player	Model Name :	DX-WBRDVD1
Temperature:	20 °C	Relative Humidity:	53 %
Pressure:	1010 hPa	Test Voltage :	AC 120V/60Hz
Test Mode :	TX G MODE 2412MHz		

Freq. (MHz)	Ant.Pol. H/V	Reading		Ant./CF CF(dB)	Act.		Limit		Note
		Peak (dBuV)	AV (dBuV)		Peak (dBuV/m)	AV (dBuV/m)	Peak (dBuV/m)	AV (dBuV/m)	
2390.00	H	35.65	21.87	31.54	67.19	53.41	74.00	54.00	X/E
<b>2411.00</b>	<b>H</b>	<b>75.48</b>	<b>62.48</b>	<b>31.57</b>	<b>107.05</b>	<b>94.05</b>			<b>X/F</b>
4824.07	H	43.71	36.29	6.00	49.71	42.29	74.00	54.00	X/H

**Remark :**

- (1) All readings are Peak unless otherwise stated QP in column of 『Note』 . Peak denotes that the Peak reading compliance with the QP Limits and then QP Mode measurement didn't perform .
- (2) Measuring frequency range from 30MHz to 1000MHz or the 10th harmonic of highest fundamental frequency. "F" denotes fundamental frequency; "H" denotes spurious frequency. "E" denotes band edge frequency. (This judgment method includes the Band Edge Requirement.)
- (3) Radiated emissions measured in frequency range above 1000MHz were made with an instrument using Peak detector mode and AV detector mode of the emission .
- (4) Data of measurement within this frequency range shown " \* " in the table above means the reading of emissions are attenuated more than 20dB below the permissible limits or the field strength is too small to be measured.
- (5) A preamp and high pass filter were used for this test in order to provide sufficient measurement sensitivity.
- (6) EUT Orthogonal Axis :  
 "X" - denotes Laid on Table ; "Y" - denotes Vertical Stand ; "Z" - denotes Side Stand
- (7) During the measurements above 1 GHz it is taken care of that the EUT is always within the 3 dB cone of radiation BW of the used antenna

TX CH01 (Above 1000 MHz, Horizontal)

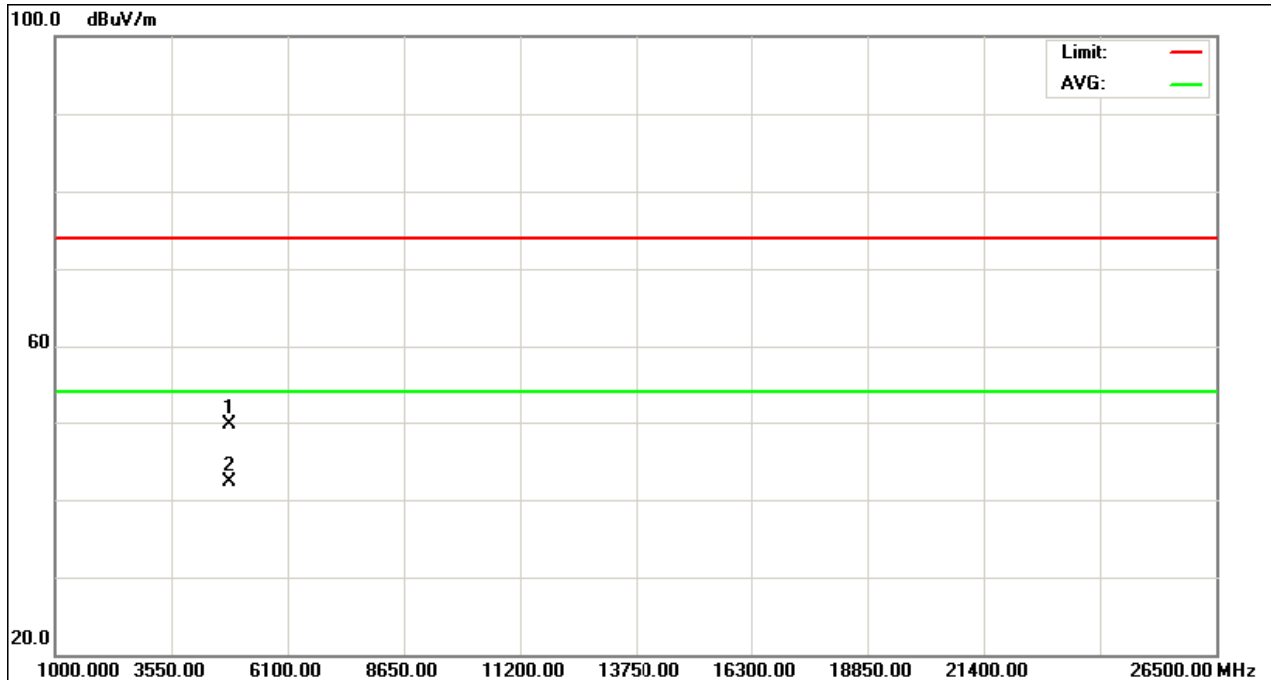
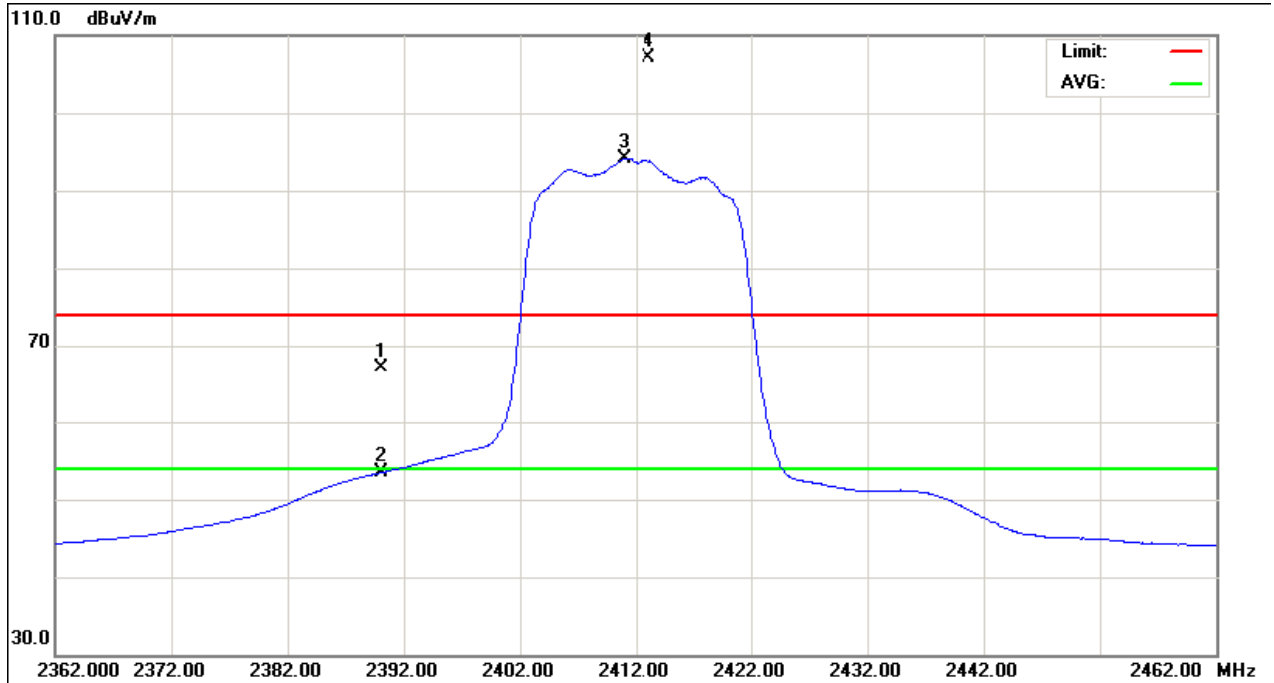

EUT:	BLU-RAY Disc Player	Model Name :	DX-WBRDVD1
Temperature:	20 °C	Relative Humidity:	53 %
Pressure:	1010 hPa	Test Voltage :	AC 120V/60Hz
Test Mode :	TX G MODE 2437MHz		

Freq.	Ant.Pol.	Reading		Ant./CF	Act.		Limit		Note
		Peak	AV		Peak	AV	Peak	AV	
(MHz)	H/V	(dBuV)	(dBuV)	CF(dB)	(dBuV/m)	(dBuV/m)	(dBuV/m)	(dBuV/m)	
<b>2435.00</b>	<b>V</b>	<b>67.21</b>	<b>54.97</b>	<b>31.62</b>	<b>98.83</b>	<b>86.59</b>			<b>X/F</b>
4876.57	V	44.52	37.54	6.15	50.67	43.69	74.00	54.00	X/H

**Remark :**

- (1) All readings are Peak unless otherwise stated QP in column of 『Note』 . Peak denotes that the Peak reading compliance with the QP Limits and then QP Mode measurement didn't perform
- (2) Measuring frequency range from 30MHz to 1000MHz or the 10th harmonic of highest fundamental frequency. "F" denotes fundamental frequency; "H" denotes spurious frequency. "E" denotes band edge frequency. (This judgment method includes the Band Edge Requirement.)
- (3) Radiated emissions measured in frequency range above 1000MHz were made with an instrument using Peak detector mode and AV detector mode of the emission
- (4) Data of measurement within this frequency range shown " \* " in the table above means the reading of emissions are attenuated more than 20dB below the permissible limits or the field strength is too small to be measured.
- (5) A preamp and high pass filter were used for this test in order to provide sufficient measurement sensitivity.
- (6) EUT Orthogonal Axis :  
 "X" - denotes Laid on Table ; "Y" - denotes Vertical Stand ; "Z" - denotes Side Stand
- (7) During the measurements above 1 GHz it is taken care of that the EUT is always within the 3 dB cone of radiation BW of the used antenna

TX CH06 (Above 1000 MHz, Vertical)

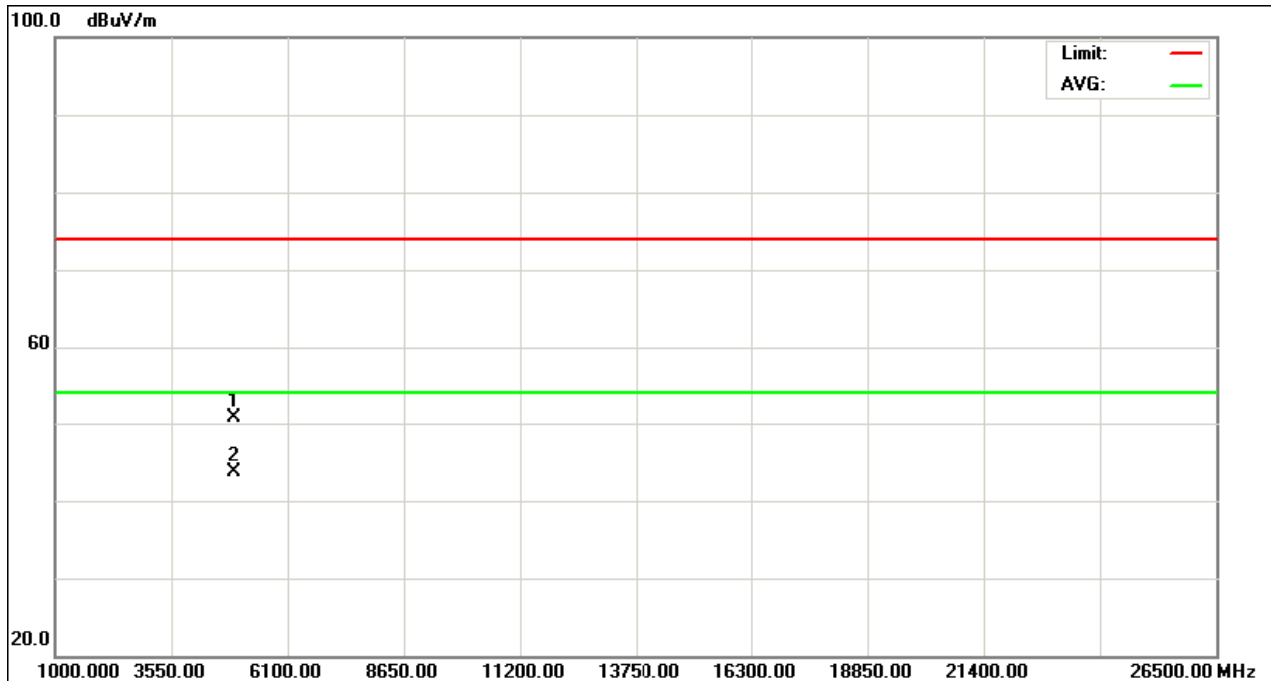
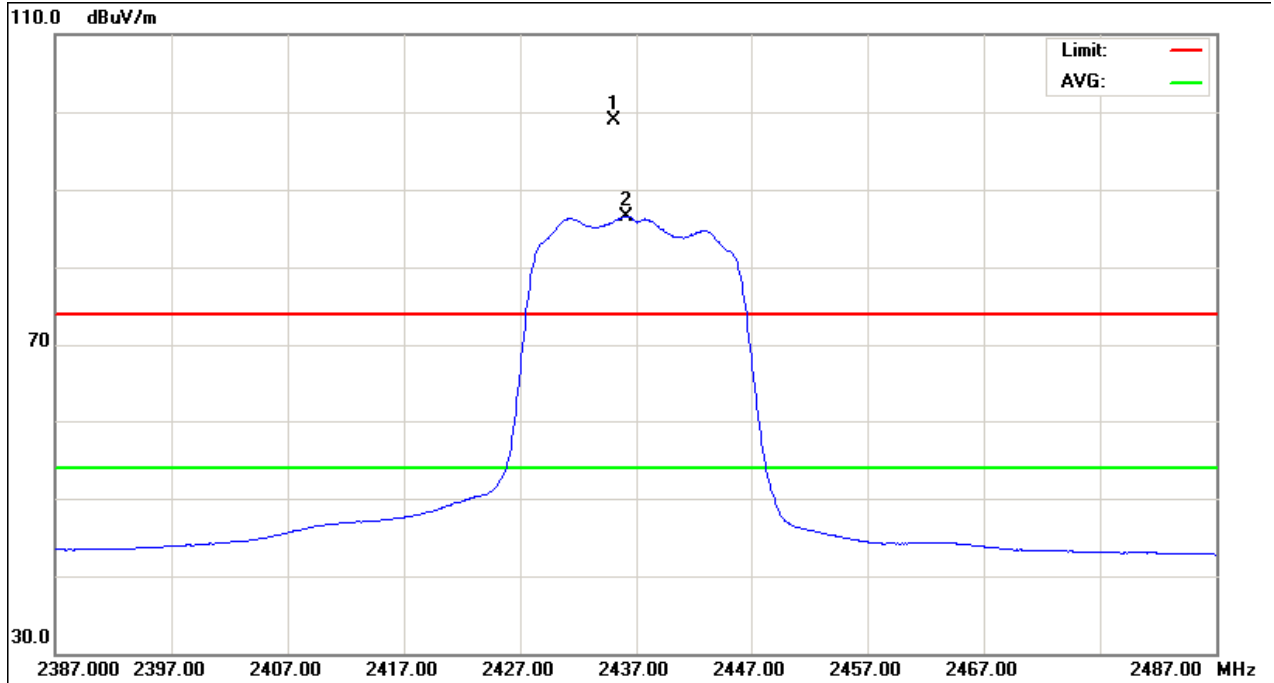



EUT:	BLU-RAY Disc Player	Model Name :	DX-WBRDVD1
Temperature:	20 °C	Relative Humidity:	53 %
Pressure:	1010 hPa	Test Voltage :	AC 120V/60Hz
Test Mode :	TX G MODE 2437MHz		

Freq. (MHz)	Ant.Pol. H/V	Reading		Ant./CF CF(dB)	Act.		Limit		Note
		Peak (dBuV)	AV (dBuV)		Peak (dBuV/m)	AV (dBuV/m)	Peak (dBuV/m)	AV (dBuV/m)	
<b>2436.20</b>	<b>H</b>	<b>76.89</b>	<b>63.48</b>	<b>31.62</b>	<b>108.51</b>	<b>95.10</b>			<b>X/F</b>
4876.57	H	43.72	34.86	6.15	49.87	41.01	74.00	54.00	X/H

## Remark :

- (1) All readings are Peak unless otherwise stated QP in column of 『Note』 . Peak denotes that the Peak reading compliance with the QP Limits and then QP Mode measurement didn't perform
- (2) Measuring frequency range from 30MHz to 1000MHz or the 10th harmonic of highest fundamental frequency. "F" denotes fundamental frequency; "H" denotes spurious frequency. "E" denotes band edge frequency. (This judgment method includes the Band Edge Requirement.)
- (3) Radiated emissions measured in frequency range above 1000MHz were made with an instrument using Peak detector mode and AV detector mode of the emission
- (4) Data of measurement within this frequency range shown " \* " in the table above means the reading of emissions are attenuated more than 20dB below the permissible limits or the field strength is too small to be measured.
- (5) A preamp and high pass filter were used for this test in order to provide sufficient measurement sensitivity.
- (6) EUT Orthogonal Axis :  
 "X" - denotes Laid on Table ; "Y" - denotes Vertical Stand ; "Z" - denotes Side Stand
- (7) During the measurements above 1 GHz it is taken care of that the EUT is always within the 3 dB cone of radiation BW of the used antenna

TX CH06 (Above 1000 MHz, Horizontal)

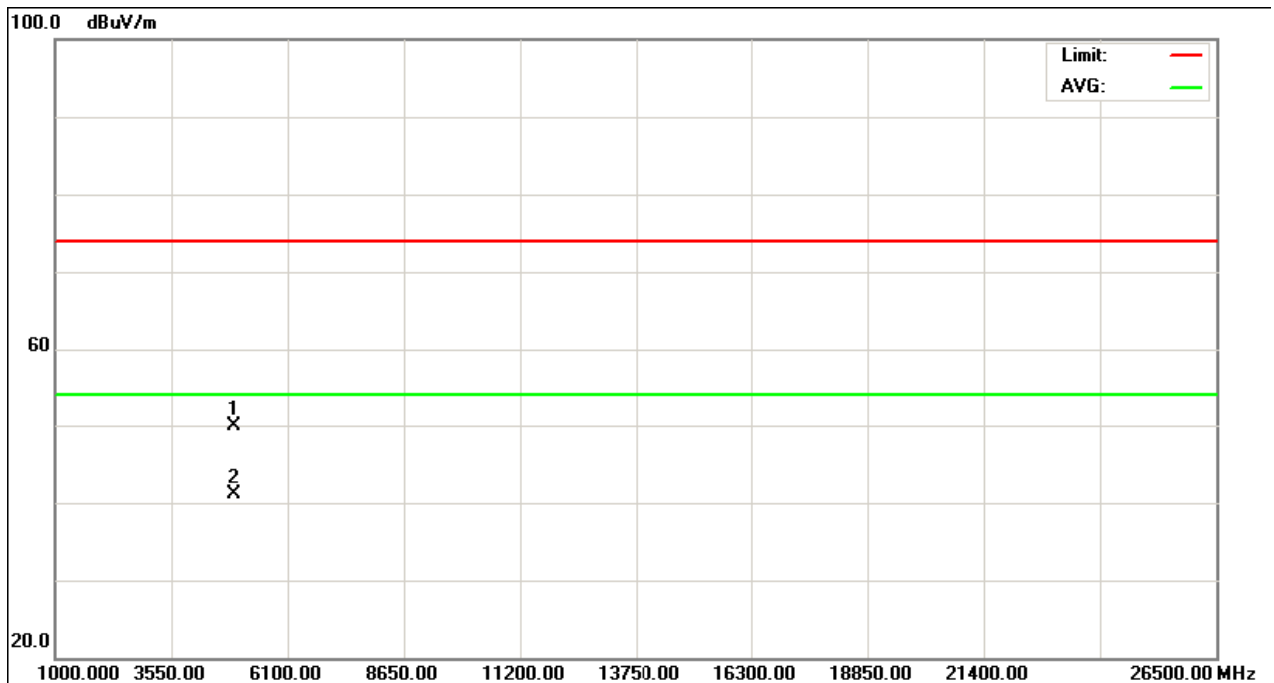
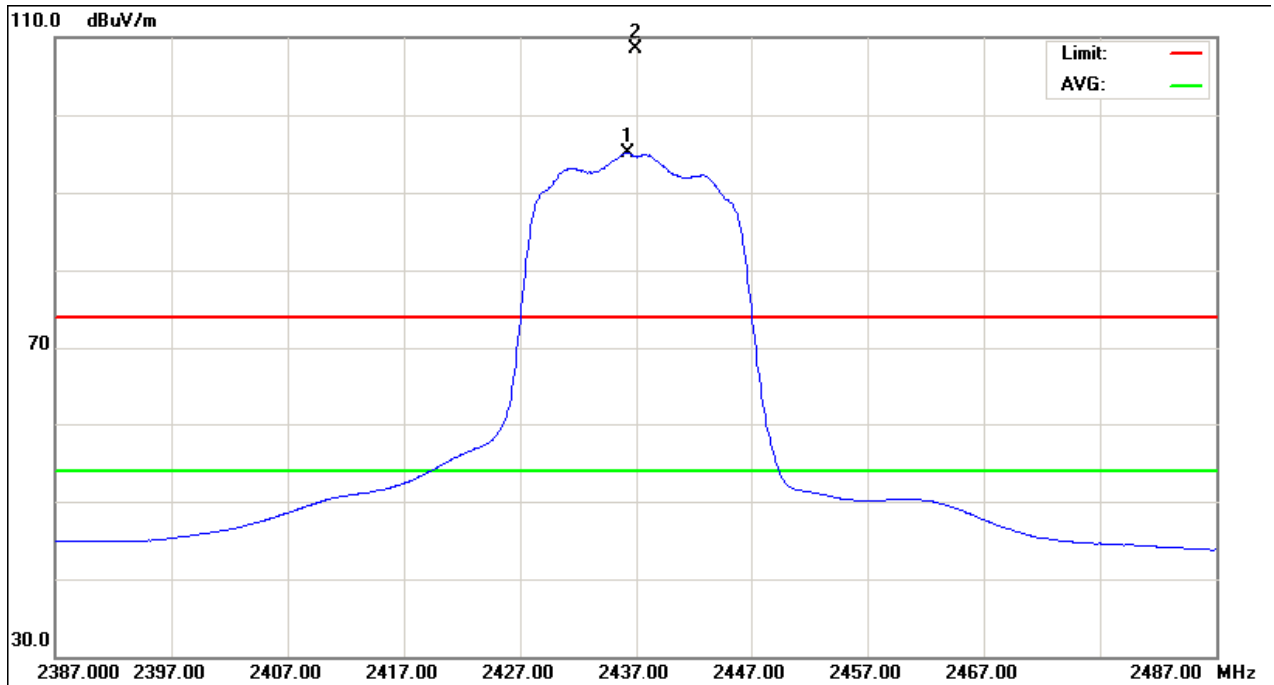

EUT:	BLU-RAY Disc Player	Model Name :	DX-WBRDVD1
Temperature:	20 °C	Relative Humidity:	53 %
Pressure:	1010 hPa	Test Voltage :	AC 120V/60Hz
Test Mode :	TX G MODE 2462MHz		

Freq.	Ant.Pol.	Reading		Ant./CF	Act.		Limit		Note
		Peak	AV		Peak	AV	Peak	AV	
(MHz)	H/V	(dBuV)	(dBuV)	CF(dB)	(dBuV/m)	(dBuV/m)	(dBuV/m)	(dBuV/m)	
<b>2463.00</b>	<b>V</b>	<b>70.26</b>	<b>57.33</b>	<b>31.66</b>	<b>101.92</b>	<b>88.99</b>			<b>X/F</b>
2483.50	V	26.42	15.46	31.70	58.12	47.16	74.00	54.00	X/E
4924.07	V	45.52	38.68	6.30	51.82	44.98	74.00	54.00	X/H

## Remark :

- (1) All readings are Peak unless otherwise stated QP in column of 『Note』 . Peak denotes that the Peak reading compliance with the QP Limits and then QP Mode measurement didn't perform
- (2) Measuring frequency range from 30MHz to 1000MHz or the 10th harmonic of highest fundamental frequency. "F" denotes fundamental frequency; "H" denotes spurious frequency. "E" denotes band edge frequency. (This judgment method includes the Band Edge Requirement.)
- (3) Radiated emissions measured in frequency range above 1000MHz were made with an instrument using Peak detector mode and AV detector mode of the emission
- (4) Data of measurement within this frequency range shown " \* " in the table above means the reading of emissions are attenuated more than 20dB below the permissible limits or the field strength is too small to be measured.
- (5) A preamp and high pass filter were used for this test in order to provide sufficient measurement sensitivity.
- (6) EUT Orthogonal Axis :  
 "X" - denotes Laid on Table ; "Y" - denotes Vertical Stand ; "Z" - denotes Side Stand
- (7) During the measurements above 1 GHz it is taken care of that the EUT is always within the 3 dB cone of radiation BW of the used antenna

TX CH11 (Above 1000 MHz, Vertical)

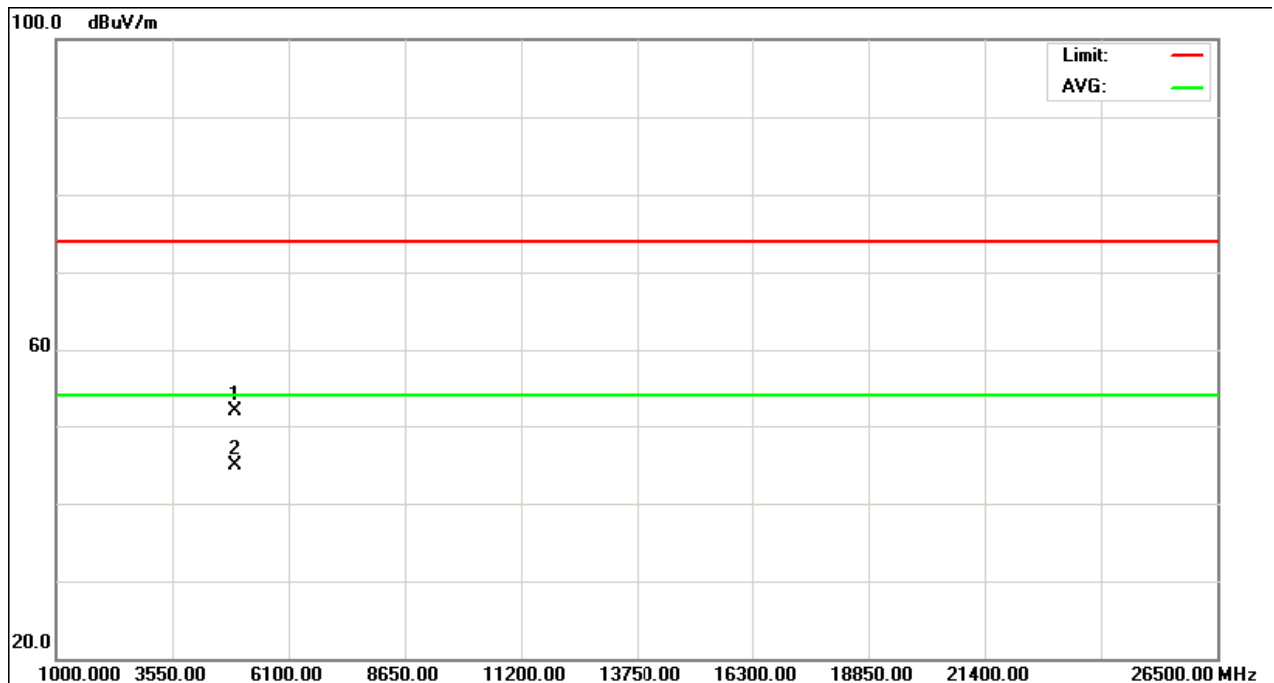
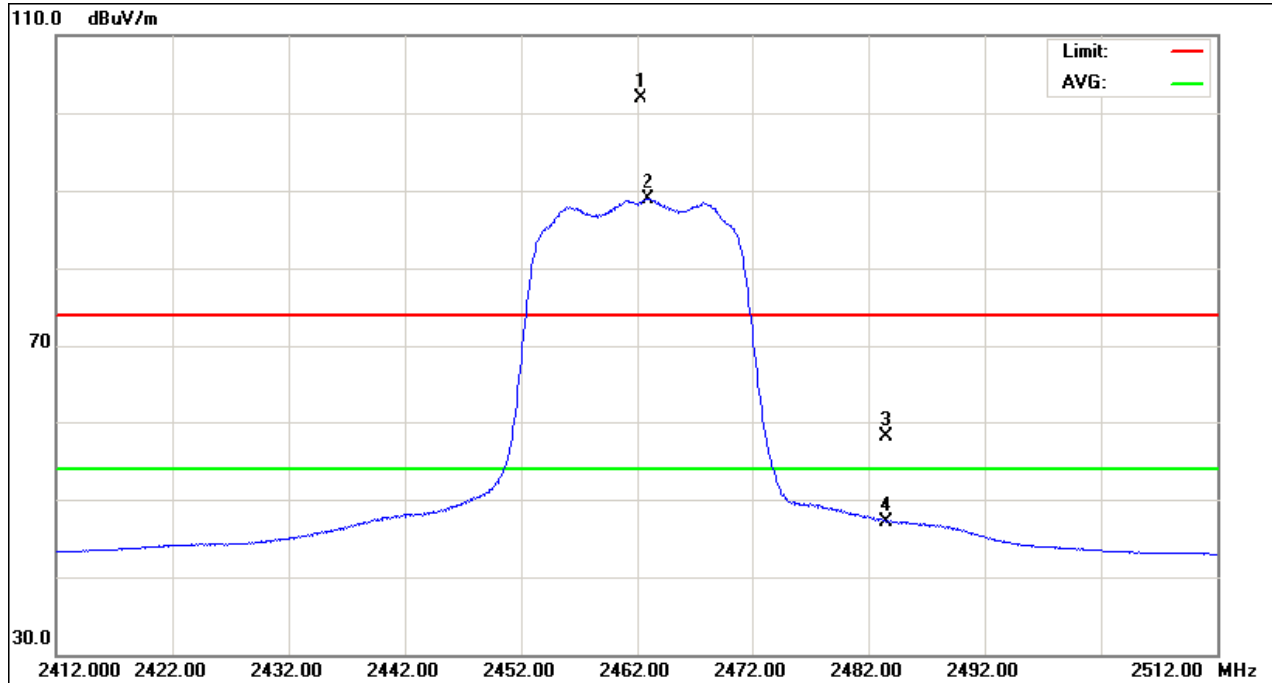

EUT:	BLU-RAY Disc Player	Model Name :	DX-WBRDVD1
Temperature:	20 °C	Relative Humidity:	53 %
Pressure:	1010 hPa	Test Voltage :	AC 120V/60Hz
Test Mode :	TX G MODE 2462MHz		

Freq.	Ant.Pol.	Reading		Ant./CF	Act.		Limit		Note
		Peak	AV		Peak	AV	Peak	AV	
(MHz)	H/V	(dBuV)	(dBuV)	CF(dB)	(dBuV/m)	(dBuV/m)	(dBuV/m)	(dBuV/m)	
<b>2462.00</b>	<b>H</b>	<b>77.41</b>	<b>62.27</b>	<b>31.66</b>	<b>109.07</b>	<b>93.93</b>			<b>X/F</b>
2483.50	H	31.66	18.06	31.70	63.36	49.76	74.00	54.00	X/E
4924.07	H	43.43	34.99	6.30	49.73	41.29	74.00	54.00	X/H

**Remark :**

- (1) All readings are Peak unless otherwise stated QP in column of 『Note』 . Peak denotes that the Peak reading compliance with the QP Limits and then QP Mode measurement didn't perform
- (2) Measuring frequency range from 30MHz to 1000MHz or the 10th harmonic of highest fundamental frequency. "F" denotes fundamental frequency; "H" denotes spurious frequency. "E" denotes band edge frequency. (This judgment method includes the Band Edge Requirement.)
- (3) Radiated emissions measured in frequency range above 1000MHz were made with an instrument using Peak detector mode and AV detector mode of the emission
- (4) Data of measurement within this frequency range shown " \* " in the table above means the reading of emissions are attenuated more than 20dB below the permissible limits or the field strength is too small to be measured.
- (5) A preamp and high pass filter were used for this test in order to provide sufficient measurement sensitivity.
- (6) EUT Orthogonal Axis :  
 "X" - denotes Laid on Table ; "Y" - denotes Vertical Stand ; "Z" - denotes Side Stand
- (7) During the measurements above 1 GHz it is taken care of that the EUT is always within the 3 dB cone of radiation BW of the used antenna

TX CH11 (Above 1000 MHz, Horizontal)

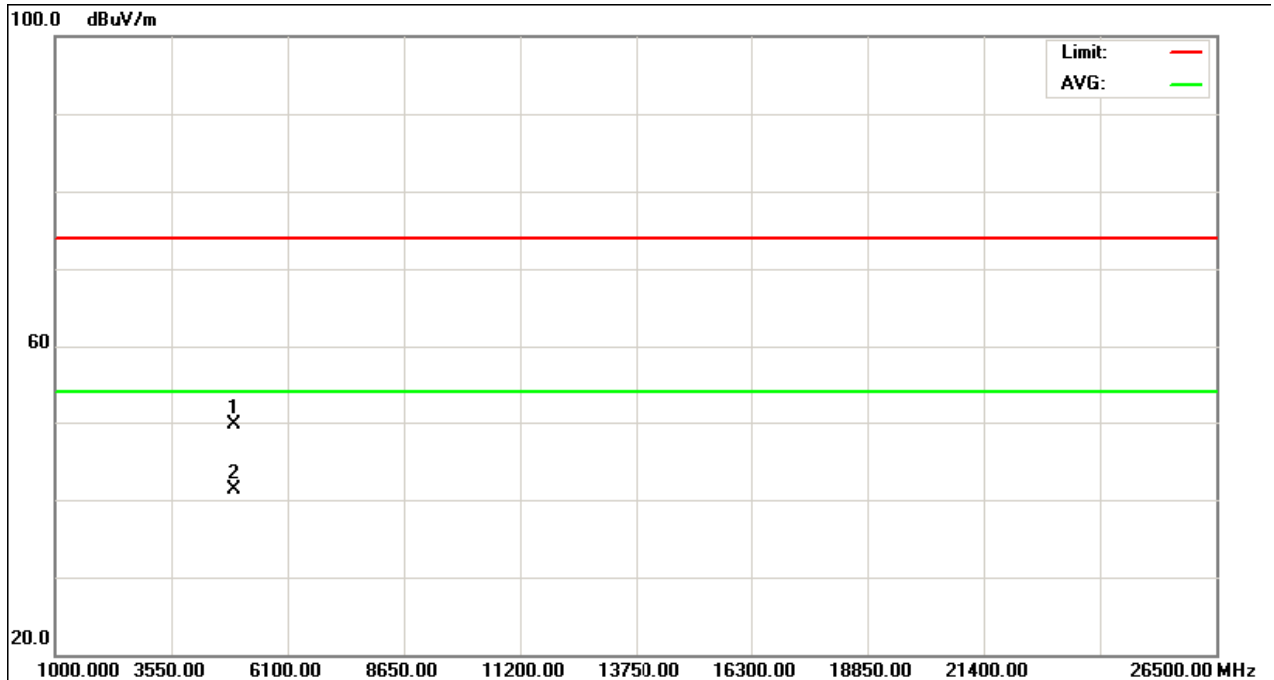
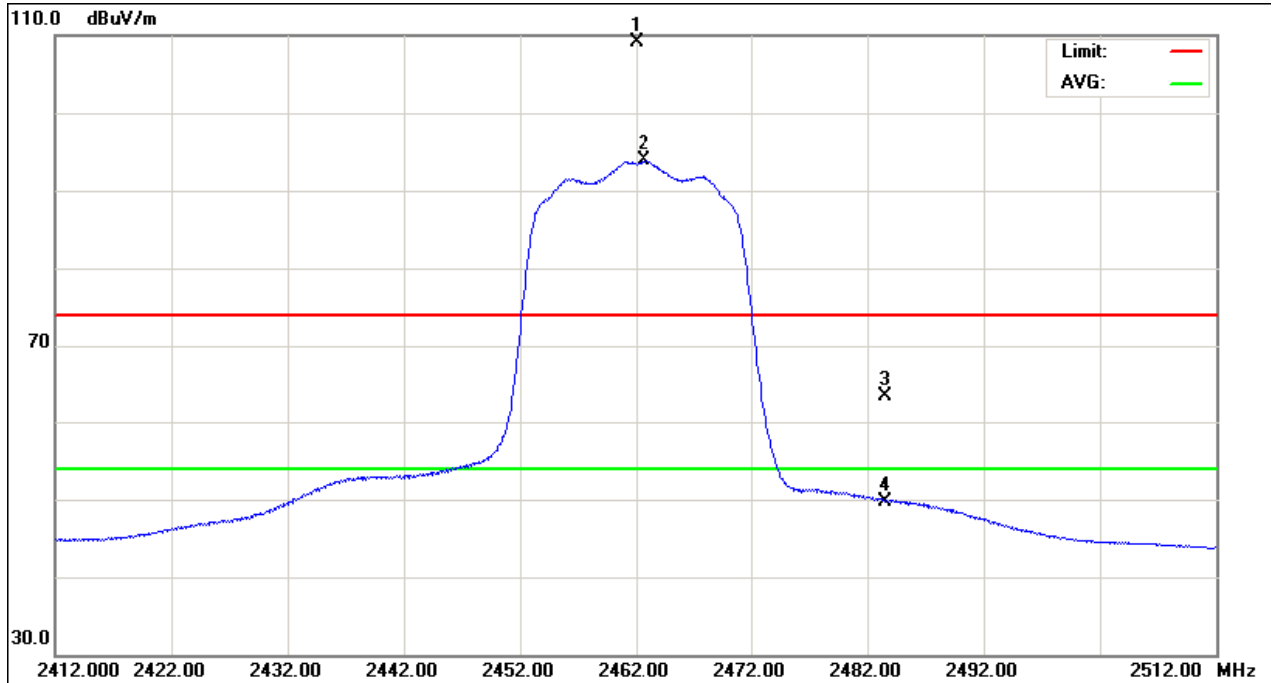

EUT:	BLU-RAY Disc Player	Model Name :	DX-WBRDVD1
Temperature:	20 °C	Relative Humidity:	53 %
Pressure:	1010 hPa	Test Voltage :	AC 120V/60Hz
Test Mode :	TX N-20M MODE 2412MHz		

Freq.	Ant.Pol.	Reading		Ant./CF	Act.		Limit		Note
		Peak	AV		Peak	AV	Peak	AV	
(MHz)	H/V	(dBuV)	(dBuV)	CF(dB)	(dBuV/m)	(dBuV/m)	(dBuV/m)	(dBuV/m)	
2390.00	V	29.27	16.87	31.61	60.88	48.48	74.00	54.00	X/E
<b>2412.80</b>	<b>V</b>	<b>74.02</b>	<b>61.08</b>	<b>31.58</b>	<b>105.60</b>	<b>92.66</b>			<b>X/F</b>
4824.21	V	43.28	36.85	6.00	49.28	42.85	74.00	54.00	X/H

**Remark :**

- (1) All readings are Peak unless otherwise stated QP in column of 『Note』 . Peak denotes that the Peak reading compliance with the QP Limits and then QP Mode measurement didn't perform
- (2) Measuring frequency range from 30MHz to 1000MHz or the 10th harmonic of highest fundamental frequency. "F" denotes fundamental frequency; "H" denotes spurious frequency. "E" denotes band edge frequency. (This judgment method includes the Band Edge Requirement.)
- (3) Radiated emissions measured in frequency range above 1000MHz were made with an instrument using Peak detector mode and AV detector mode of the emission
- (4) Data of measurement within this frequency range shown " \* " in the table above means the reading of emissions are attenuated more than 20dB below the permissible limits or the field strength is too small to be measured.
- (5) A preamp and high pass filter were used for this test in order to provide sufficient measurement sensitivity.
- (6) EUT Orthogonal Axis :  
 "X" - denotes Laid on Table ; "Y" - denotes Vertical Stand ; "Z" - denotes Side Stand
- (7) During the measurements above 1 GHz it is taken care of that the EUT is always within the 3 dB cone of radiation BW of the used antenna

TX CH01 (Above 1000 MHz, Vertical)

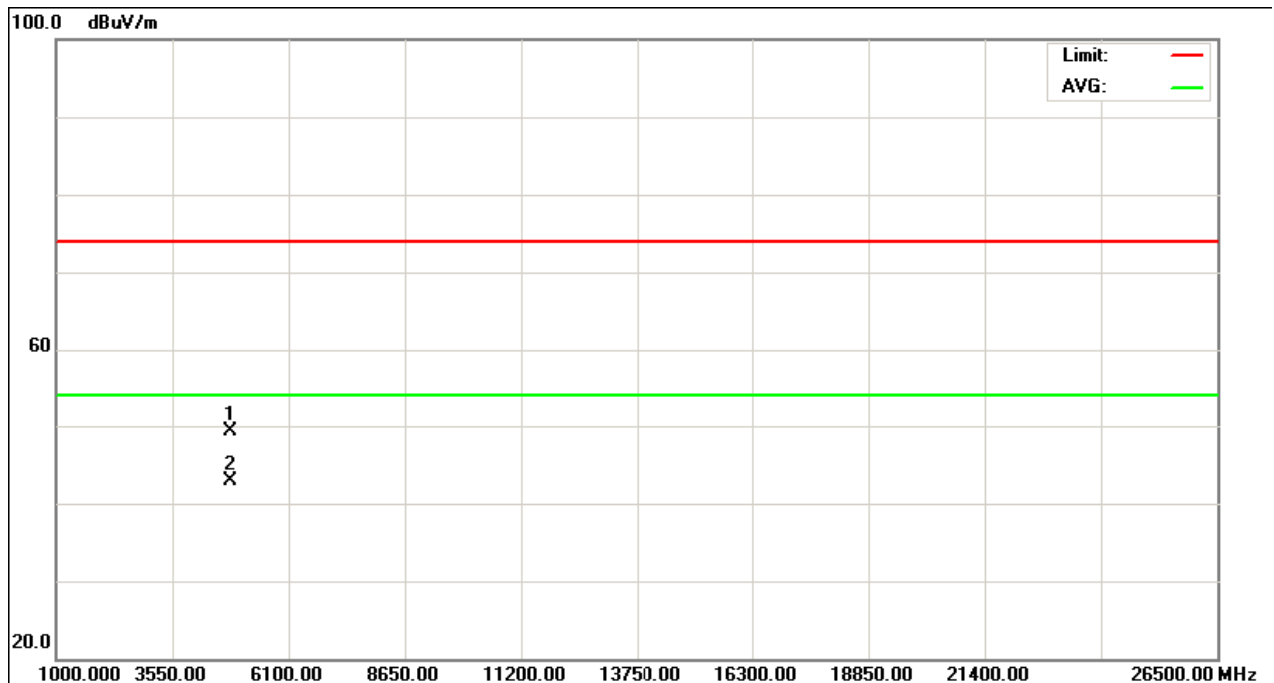
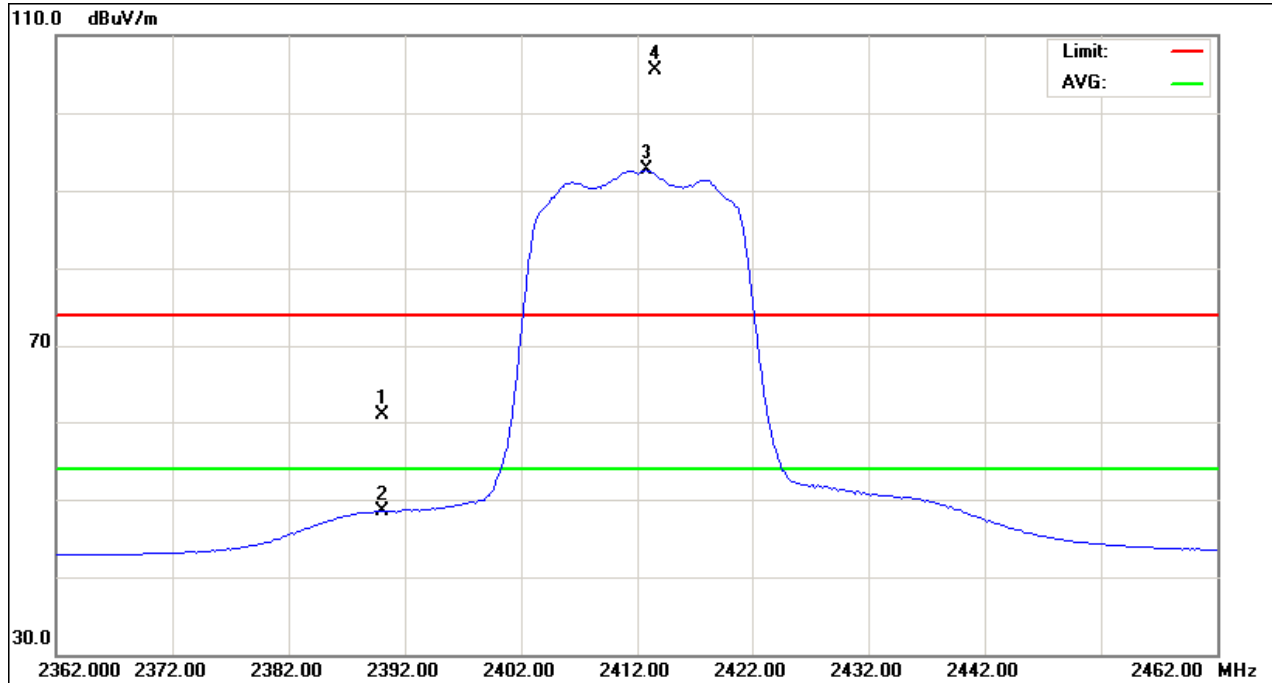



EUT:	BLU-RAY Disc Player	Model Name :	DX-WBRDVD1
Temperature:	20 °C	Relative Humidity:	53 %
Pressure:	1010 hPa	Test Voltage :	AC 120V/60Hz
Test Mode :	TX N-20M MODE 2412MHz		

Freq.	Ant.Pol.	Reading		Ant./CF	Act.		Limit		Note
		Peak	AV		Peak	AV	Peak	AV	
(MHz)	H/V	(dBuV)	(dBuV)	CF(dB)	(dBuV/m)	(dBuV/m)	(dBuV/m)	(dBuV/m)	
2390.00	H	29.28	18.11	31.61	60.89	49.72	74.00	54.00	X/E
<b>2412.60</b>	<b>H</b>	<b>74.93</b>	<b>62.31</b>	<b>31.59</b>	<b>106.52</b>	<b>93.89</b>			<b>X/F</b>
4824.14	H	41.96	34.85	6.00	47.96	40.85	74.00	54.00	X/H

**Remark :**

- (1) All readings are Peak unless otherwise stated QP in column of 『Note』 . Peak denotes that the Peak reading compliance with the QP Limits and then QP Mode measurement didn't perform
- (2) Measuring frequency range from 30MHz to 1000MHz or the 10th harmonic of highest fundamental frequency. "F" denotes fundamental frequency; "H" denotes spurious frequency. "E" denotes band edge frequency. (This judgment method includes the Band Edge Requirement.)
- (3) Radiated emissions measured in frequency range above 1000MHz were made with an instrument using Peak detector mode and AV detector mode of the emission
- (4) Data of measurement within this frequency range shown " \* " in the table above means the reading of emissions are attenuated more than 20dB below the permissible limits or the field strength is too small to be measured.
- (5) A preamp and high pass filter were used for this test in order to provide sufficient measurement sensitivity.
- (6) EUT Orthogonal Axis :  
 "X" - denotes Laid on Table ; "Y" - denotes Vertical Stand ; "Z" - denotes Side Stand
- (7) During the measurements above 1 GHz it is taken care of that the EUT is always within the 3 dB cone of radiation BW of the used antenna

TX CH01 (Above 1000 MHz, Horizontal)

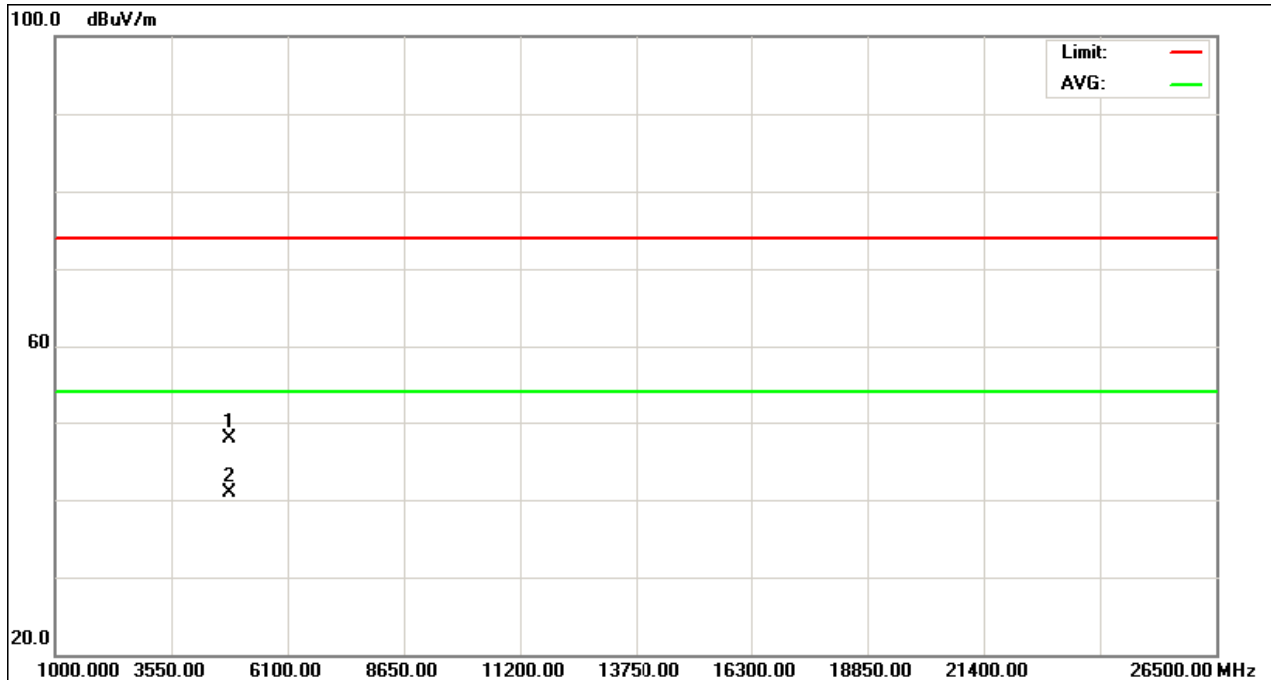
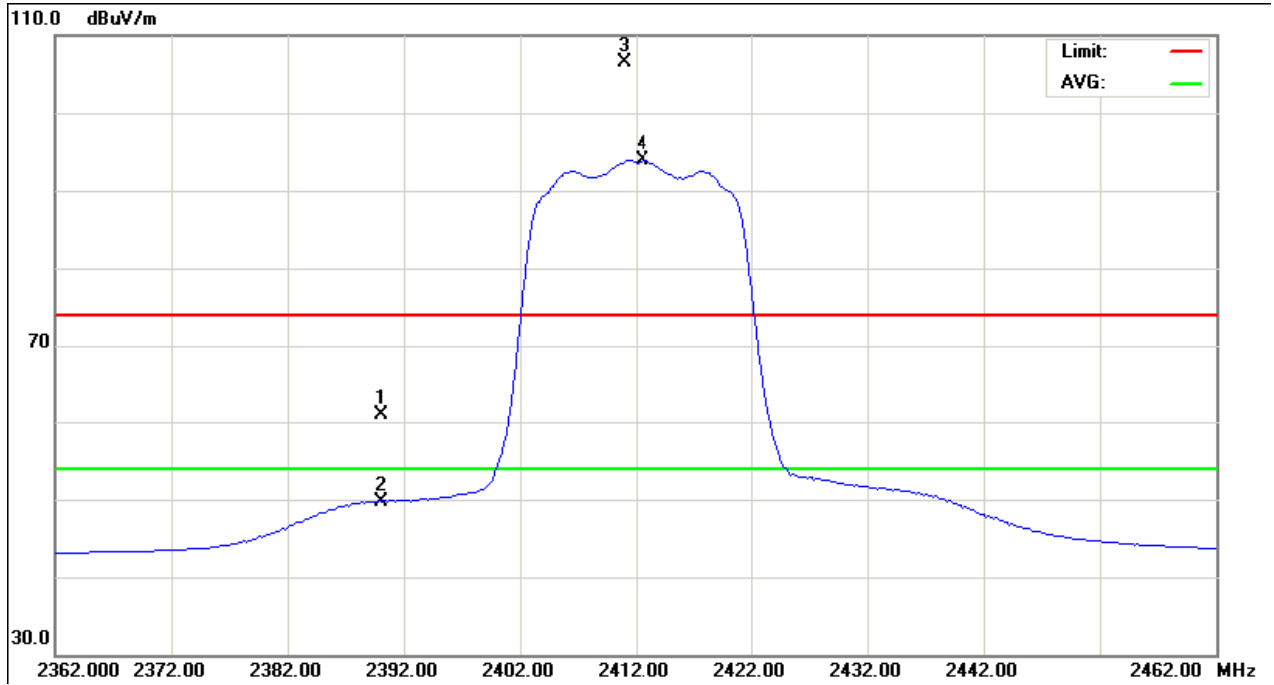

EUT:	BLU-RAY Disc Player	Model Name :	DX-WBRDVD1
Temperature:	20 °C	Relative Humidity:	53 %
Pressure:	1010 hPa	Test Voltage :	AC 120V/60Hz
Test Mode :	TX N-20M MODE 2437MHz		

Freq.	Ant.Pol.	Reading		Ant./CF	Act.		Limit		Note
		Peak	AV		Peak	AV	Peak	AV	
(MHz)	H/V	(dBuV)	(dBuV)	CF(dB)	(dBuV/m)	(dBuV/m)	(dBuV/m)	(dBuV/m)	
<b>2436.40</b>	<b>V</b>	<b>75.21</b>	<b>62.14</b>	<b>31.56</b>	<b>106.77</b>	<b>93.70</b>			<b>X/F</b>
4876.73	V	43.37	35.11	6.15	49.52	41.26	74.00	54.00	X/H

**Remark :**

- (1) All readings are Peak unless otherwise stated QP in column of 『Note』 . Peak denotes that the Peak reading compliance with the QP Limits and then QP Mode measurement didn't perform
- (2) Measuring frequency range from 30MHz to 1000MHz or the 10th harmonic of highest fundamental frequency. "F" denotes fundamental frequency; "H" denotes spurious frequency. "E" denotes band edge frequency. (This judgment method includes the Band Edge Requirement.)
- (3) Radiated emissions measured in frequency range above 1000MHz were made with an instrument using Peak detector mode and AV detector mode of the emission
- (4) Data of measurement within this frequency range shown " \* " in the table above means the reading of emissions are attenuated more than 20dB below the permissible limits or the field strength is too small to be measured.
- (5) A preamp and high pass filter were used for this test in order to provide sufficient measurement sensitivity.
- (6) EUT Orthogonal Axis :  
"X" - denotes Laid on Table ; "Y" - denotes Vertical Stand ; "Z" - denotes Side Stand
- (7) During the measurements above 1 GHz it is taken care of that the EUT is always within the 3 dB cone of radiation BW of the used antenna

TX CH06 (Above 1000 MHz, Vertical)

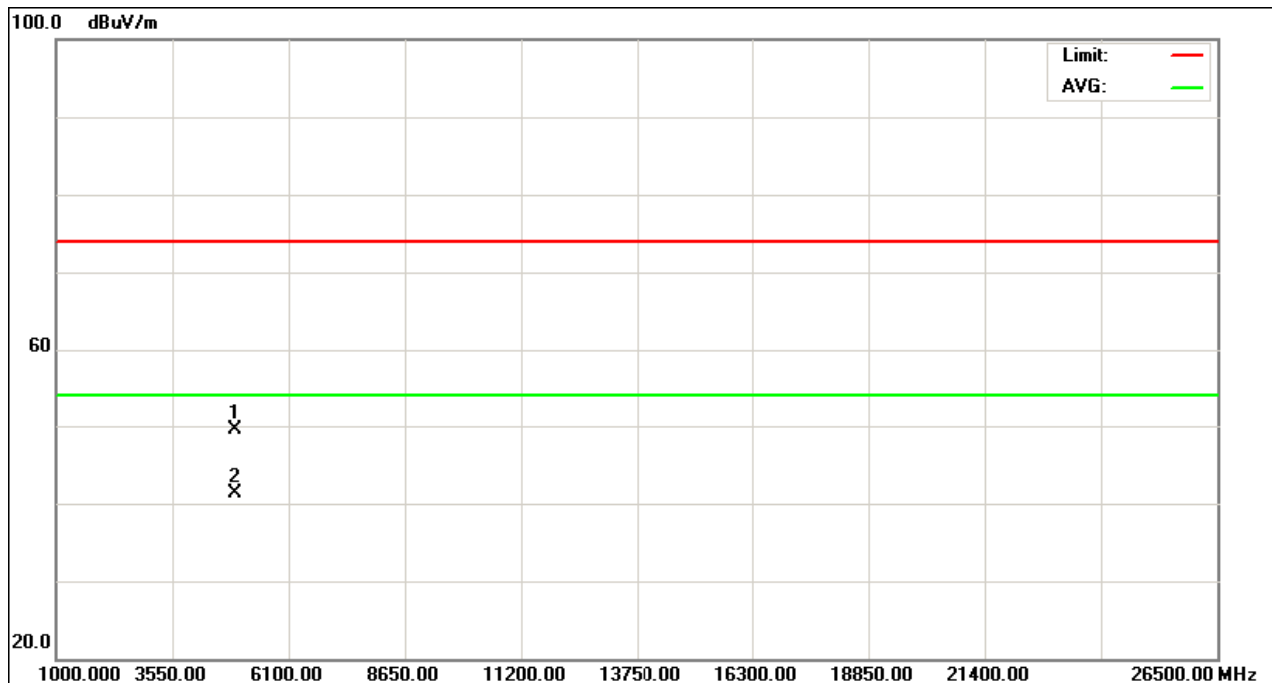
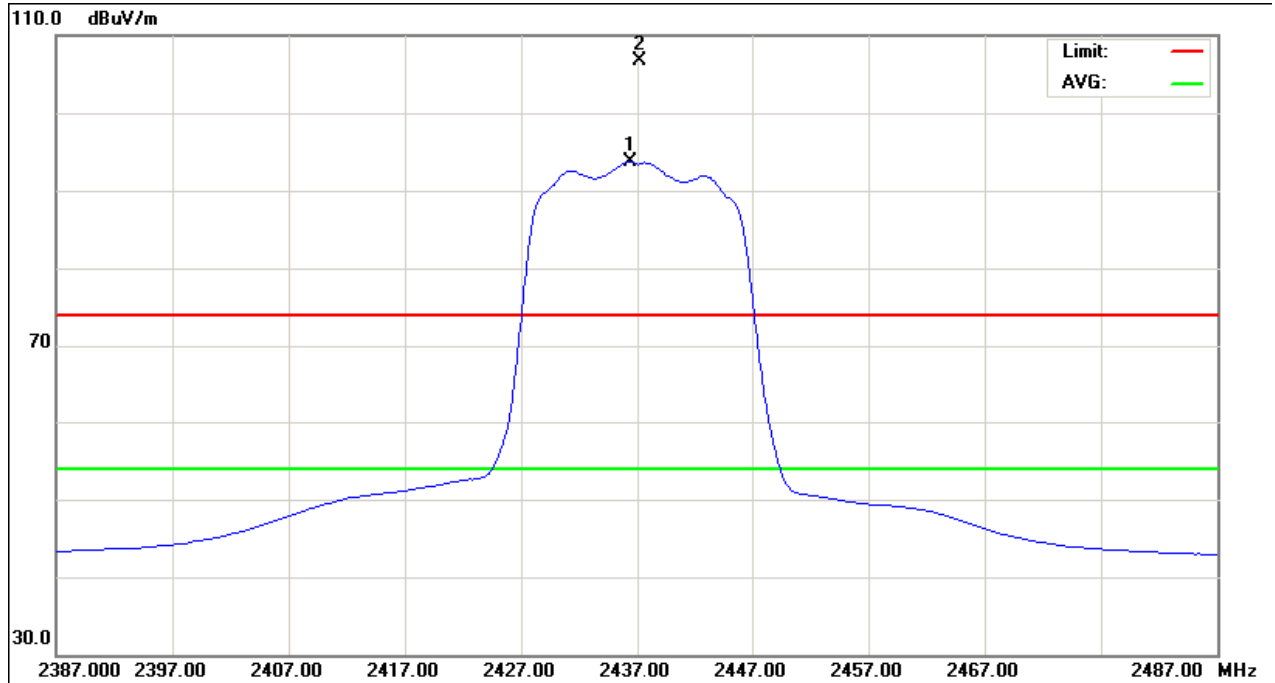

EUT:	BLU-RAY Disc Player	Model Name :	DX-WBRDVD1
Temperature:	20 °C	Relative Humidity:	53 %
Pressure:	1010 hPa	Test Voltage :	AC 120V/60Hz
Test Mode :	TX N-20M MODE 2437MHz		

Freq.	Ant.Pol.	Reading		Ant./CF	Act.		Limit		Note
		Peak	AV		Peak	AV	Peak	AV	
(MHz)	H/V	(dBuV)	(dBuV)	CF(dB)	(dBuV/m)	(dBuV/m)	(dBuV/m)	(dBuV/m)	
<b>2436.00</b>	<b>H</b>	<b>76.94</b>	<b>63.25</b>	<b>31.56</b>	<b>108.50</b>	<b>94.81</b>			<b>X/F</b>
4876.29	H	42.00	34.36	6.15	48.15	40.51	74.00	54.00	X/H

**Remark :**

- (1) All readings are Peak unless otherwise stated QP in column of 『Note』 . Peak denotes that the Peak reading compliance with the QP Limits and then QP Mode measurement didn't perform
- (2) Measuring frequency range from 30MHz to 1000MHz or the 10th harmonic of highest fundamental frequency. "F" denotes fundamental frequency; "H" denotes spurious frequency. "E" denotes band edge frequency. (This judgment method includes the Band Edge Requirement.)
- (3) Radiated emissions measured in frequency range above 1000MHz were made with an instrument using Peak detector mode and AV detector mode of the emission
- (4) Data of measurement within this frequency range shown " \* " in the table above means the reading of emissions are attenuated more than 20dB below the permissible limits or the field strength is too small to be measured.
- (5) A preamp and high pass filter were used for this test in order to provide sufficient measurement sensitivity.
- (6) EUT Orthogonal Axis :  
"X" - denotes Laid on Table ; "Y" - denotes Vertical Stand ; "Z" - denotes Side Stand
- (7) During the measurements above 1 GHz it is taken care of that the EUT is always within the 3 dB cone of radiation BW of the used antenna

TX CH06 (Above 1000 MHz, Horizontal)

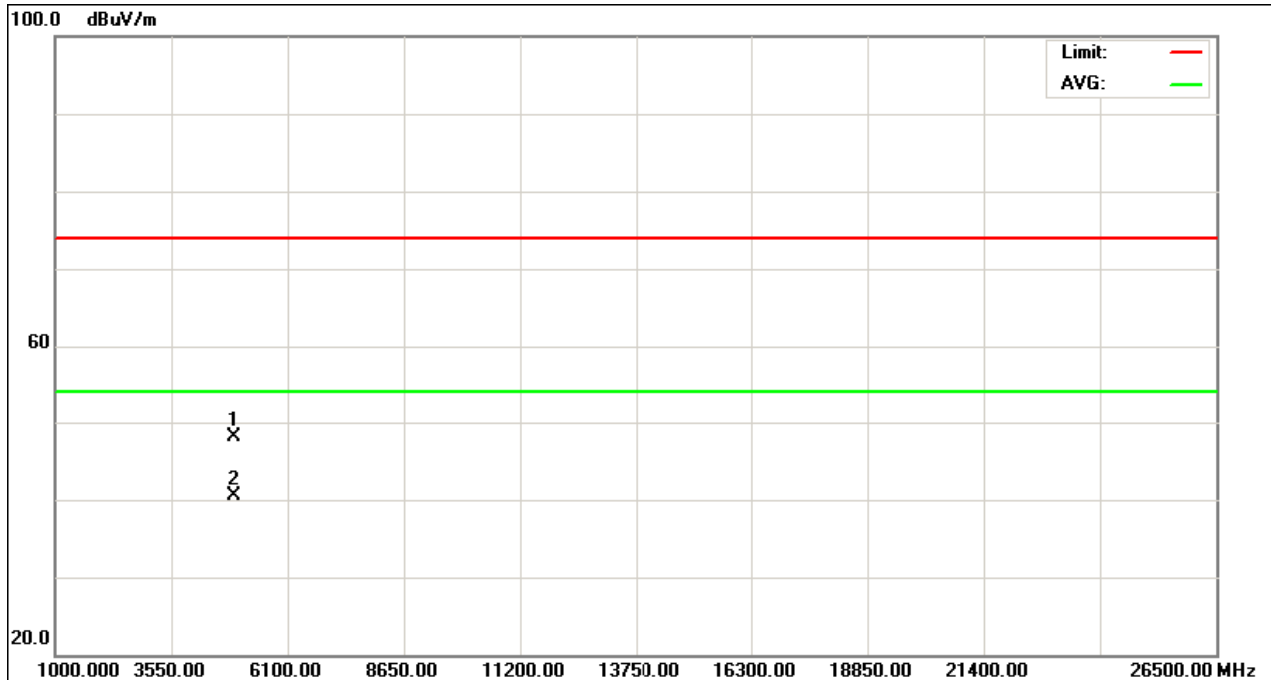
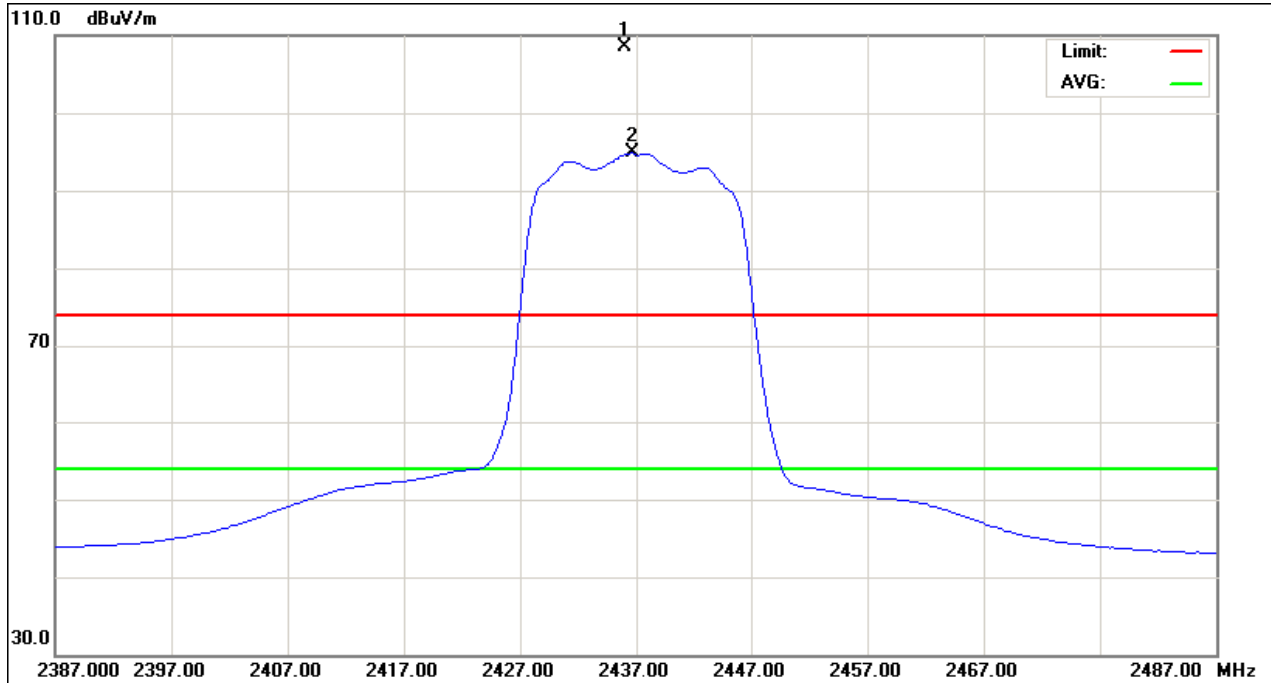

EUT:	BLU-RAY Disc Player	Model Name :	DX-WBRDVD1
Temperature:	20 °C	Relative Humidity:	53 %
Pressure:	1010 hPa	Test Voltage :	AC 120V/60Hz
Test Mode :	TX N-20M MODE 2462MHz		

Freq.	Ant.Pol.	Reading		Ant./CF	Act.		Limit		Note
		Peak	AV		Peak	AV	Peak	AV	
(MHz)	H/V	(dBuV)	(dBuV)	CF(dB)	(dBuV/m)	(dBuV/m)	(dBuV/m)	(dBuV/m)	
<b>2460.40</b>	<b>V</b>	<b>73.57</b>	<b>61.33</b>	<b>31.53</b>	<b>105.10</b>	<b>92.86</b>			<b>X/F</b>
2483.50	V	30.51	18.26	31.50	62.01	49.76	74.00	54.00	X/E
4923.84	V	42.46	34.46	6.30	48.76	40.76	74.00	54.00	X/H

**Remark :**

- (1) All readings are Peak unless otherwise stated QP in column of 『Note』 . Peak denotes that the Peak reading compliance with the QP Limits and then QP Mode measurement didn't perform
- (2) Measuring frequency range from 30MHz to 1000MHz or the 10th harmonic of highest fundamental frequency. "F" denotes fundamental frequency; "H" denotes spurious frequency. "E" denotes band edge frequency. (This judgment method includes the Band Edge Requirement.)
- (3) Radiated emissions measured in frequency range above 1000MHz were made with an instrument using Peak detector mode and AV detector mode of the emission
- (4) Data of measurement within this frequency range shown " \* " in the table above means the reading of emissions are attenuated more than 20dB below the permissible limits or the field strength is too small to be measured.
- (5) A preamp and high pass filter were used for this test in order to provide sufficient measurement sensitivity.
- (6) EUT Orthogonal Axis :  
 "X" - denotes Laid on Table ; "Y" - denotes Vertical Stand ; "Z" - denotes Side Stand
- (7) During the measurements above 1 GHz it is taken care of that the EUT is always within the 3 dB cone of radiation BW of the used antenna

TX CH11 (Above 1000 MHz, Vertical)

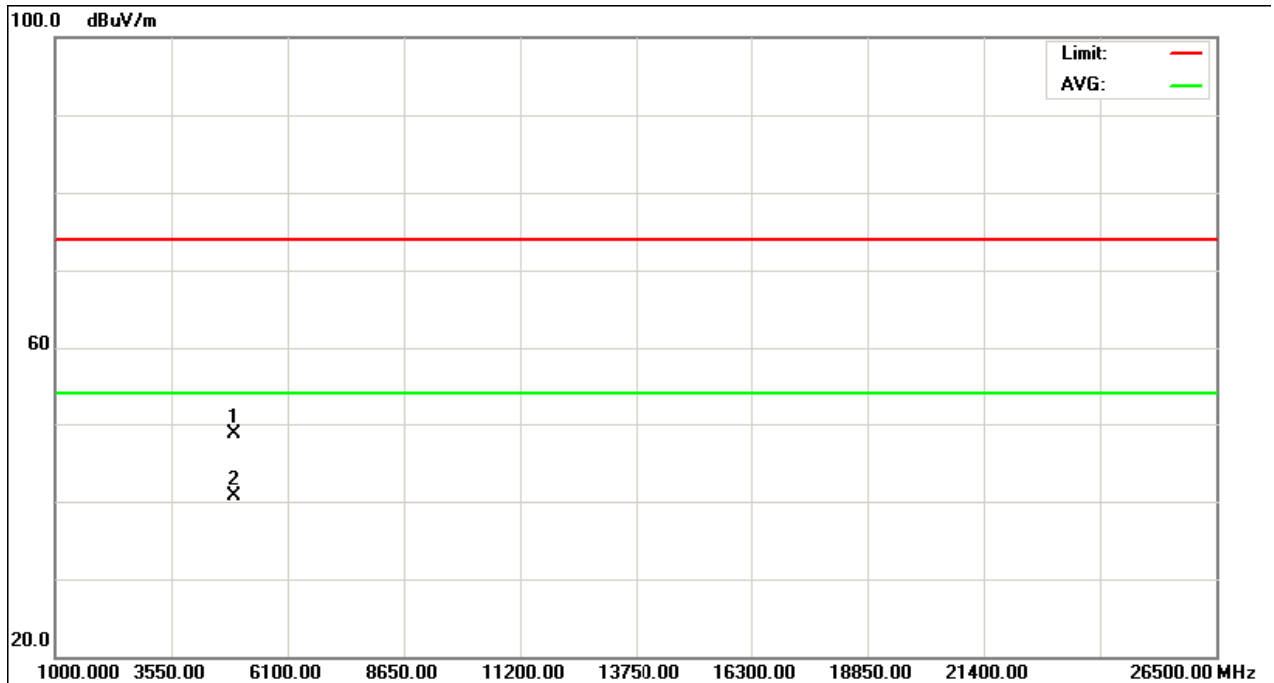
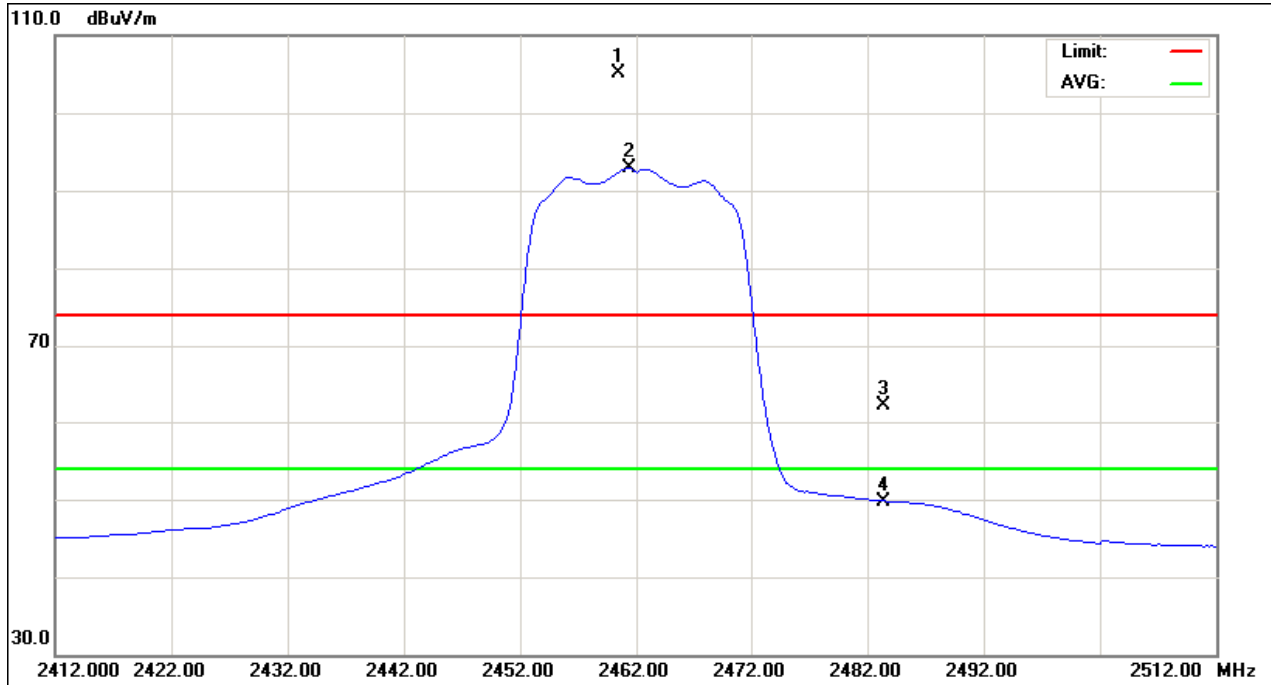



EUT:	BLU-RAY Disc Player	Model Name :	DX-WBRDVD1
Temperature:	20 °C	Relative Humidity:	53 %
Pressure:	1010 hPa	Test Voltage :	AC 120V/60Hz
Test Mode :	TX N-20M MODE 2462MHz		

Freq.	Ant.Pol.	Reading		Ant./CF	Act.		Limit		Note
		Peak	AV		Peak	AV	Peak	AV	
(MHz)	H/V	(dBuV)	(dBuV)	CF(dB)	(dBuV/m)	(dBuV/m)	(dBuV/m)	(dBuV/m)	
<b>2461.20</b>	<b>H</b>	<b>75.18</b>	<b>62.58</b>	<b>31.52</b>	<b>106.70</b>	<b>94.11</b>			<b>X/F</b>
2483.50	H	30.37	19.37	31.50	61.87	50.87	74.00	54.00	X/E
4923.74	H	43.22	33.71	6.30	49.52	40.01	74.00	54.00	X/H

**Remark :**

- (1) All readings are Peak unless otherwise stated QP in column of 『Note』 . Peak denotes that the Peak reading compliance with the QP Limits and then QP Mode measurement didn't perform
- (2) Measuring frequency range from 30MHz to 1000MHz or the 10th harmonic of highest fundamental frequency. "F" denotes fundamental frequency; "H" denotes spurious frequency. "E" denotes band edge frequency. (This judgment method includes the Band Edge Requirement.)
- (3) Radiated emissions measured in frequency range above 1000MHz were made with an instrument using Peak detector mode and AV detector mode of the emission
- (4) Data of measurement within this frequency range shown " \* " in the table above means the reading of emissions are attenuated more than 20dB below the permissible limits or the field strength is too small to be measured.
- (5) A preamp and high pass filter were used for this test in order to provide sufficient measurement sensitivity.
- (6) EUT Orthogonal Axis :  
"X" - denotes Laid on Table ; "Y" - denotes Vertical Stand ; "Z" - denotes Side Stand
- (7) During the measurements above 1 GHz it is taken care of that the EUT is always within the 3 dB cone of radiation BW of the used antenna

TX CH11 (Above 1000 MHz, Horizontal)

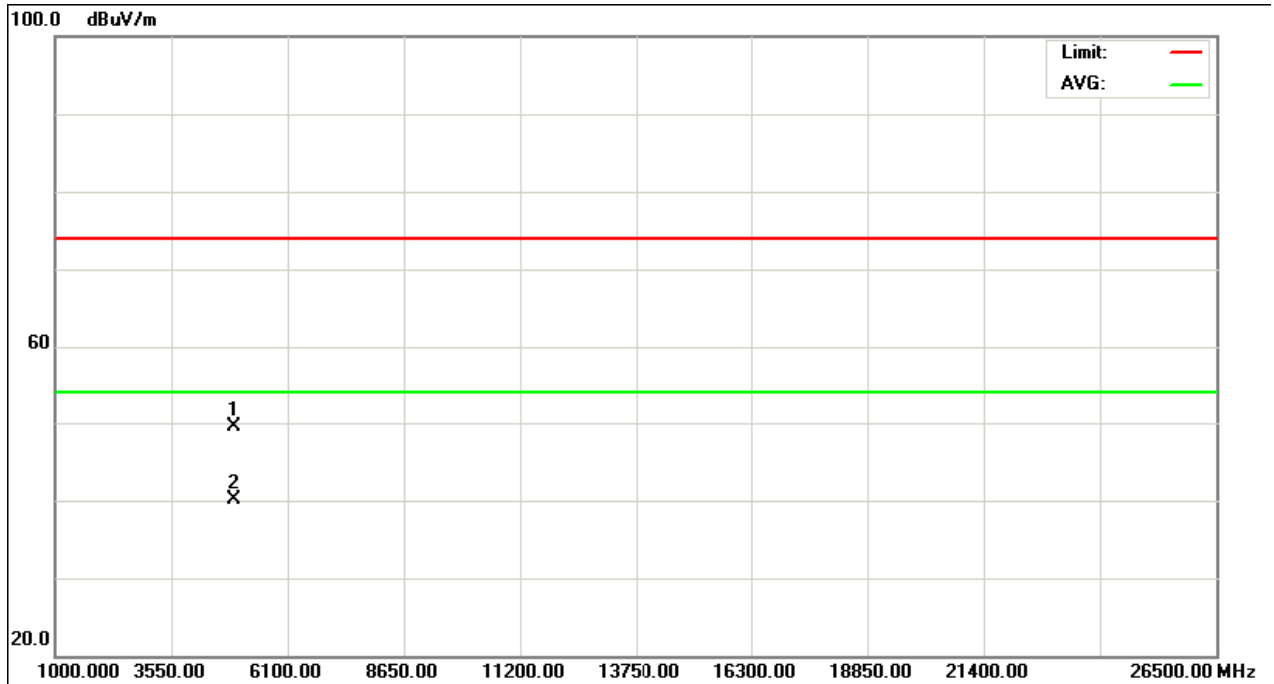
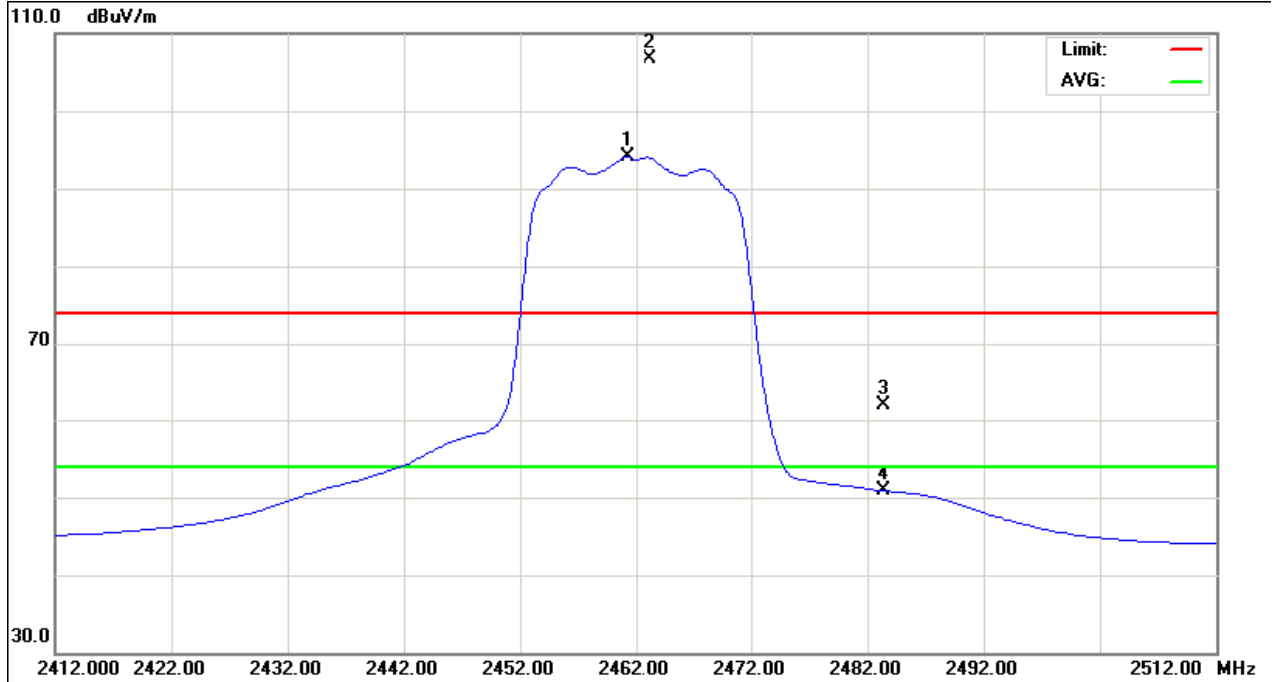

EUT:	BLU-RAY Disc Player	Model Name :	DX-WBRDVD1
Temperature:	20 °C	Relative Humidity:	53 %
Pressure:	1010 hPa	Test Voltage :	AC 120V/60Hz
Test Mode :	TX N-40M MODE 2422MHz		

Freq.	Ant.Pol.	Reading		Ant./CF	Act.		Limit		Note
		Peak	AV		Peak	AV	Peak	AV	
(MHz)	H/V	(dBuV)	(dBuV)	CF(dB)	(dBuV/m)	(dBuV/m)	(dBuV/m)	(dBuV/m)	
2390.00	V	29.97	16.78	31.61	61.58	48.39	74.00	54.00	X/E
<b>2420.20</b>	<b>V</b>	<b>72.02</b>	<b>50.04</b>	<b>31.58</b>	<b>103.60</b>	<b>81.62</b>			<b>X/F</b>
4844.21	V	43.22	34.36	6.06	49.28	40.42	74.00	54.00	X/H

**Remark :**

- (1) All readings are Peak unless otherwise stated QP in column of 『Note』 . Peak denotes that the Peak reading compliance with the QP Limits and then QP Mode measurement didn't perform
- (2) Measuring frequency range from 30MHz to 1000MHz or the 10th harmonic of highest fundamental frequency. "F" denotes fundamental frequency; "H" denotes spurious frequency. "E" denotes band edge frequency. (This judgment method includes the Band Edge Requirement.)
- (3) Radiated emissions measured in frequency range above 1000MHz were made with an instrument using Peak detector mode and AV detector mode of the emission
- (4) Data of measurement within this frequency range shown " \* " in the table above means the reading of emissions are attenuated more than 20dB below the permissible limits or the field strength is too small to be measured.
- (5) A preamp and high pass filter were used for this test in order to provide sufficient measurement sensitivity.
- (6) EUT Orthogonal Axis :  
"X" - denotes Laid on Table ; "Y" - denotes Vertical Stand ; "Z" - denotes Side Stand
- (7) During the measurements above 1 GHz it is taken care of that the EUT is always within the 3 dB cone of radiation BW of the used antenna

TX CH03 (Above 1000 MHz, Vertical)

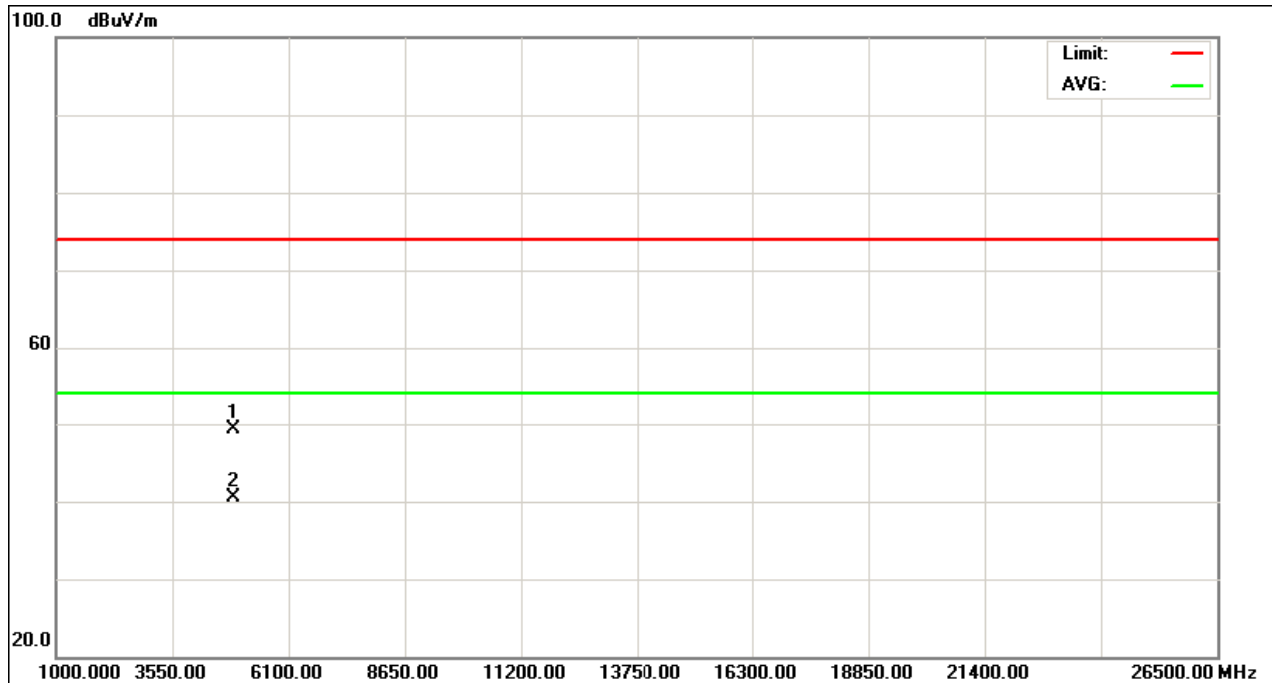
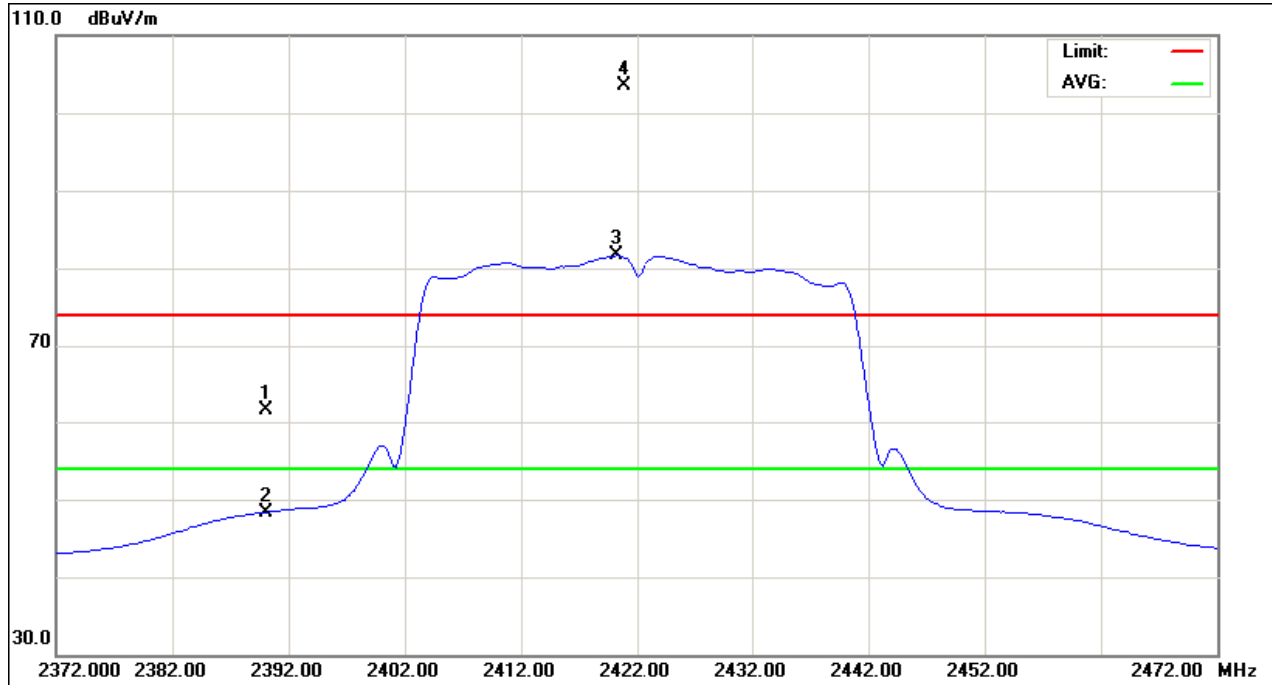

EUT:	BLU-RAY Disc Player	Model Name :	DX-WBRDVD1
Temperature:	20 °C	Relative Humidity:	53 %
Pressure:	1010 hPa	Test Voltage :	AC 120V/60Hz
Test Mode :	TX N-40M MODE 2422MHz		

Freq.	Ant.Pol.	Reading		Ant./CF	Act.		Limit		Note
		Peak	AV		Peak	AV	Peak	AV	
(MHz)	H/V	(dBuV)	(dBuV)	CF(dB)	(dBuV/m)	(dBuV/m)	(dBuV/m)	(dBuV/m)	
2390.00	H	33.43	19.14	31.61	65.04	50.74	74.00	54.00	X/E
<b>2420.20</b>	<b>H</b>	<b>74.67</b>	<b>51.96</b>	<b>31.58</b>	<b>106.25</b>	<b>83.54</b>			<b>X/F</b>
4824.14	H	41.96	32.79	6.00	47.96	38.85	74.00	54.00	X/H

**Remark :**

- (1) All readings are Peak unless otherwise stated QP in column of 『Note』 . Peak denotes that the Peak reading compliance with the QP Limits and then QP Mode measurement didn't perform
- (2) Measuring frequency range from 30MHz to 1000MHz or the 10th harmonic of highest fundamental frequency. "F" denotes fundamental frequency; "H" denotes spurious frequency. "E" denotes band edge frequency. (This judgment method includes the Band Edge Requirement.)
- (3) Radiated emissions measured in frequency range above 1000MHz were made with an instrument using Peak detector mode and AV detector mode of the emission
- (4) Data of measurement within this frequency range shown " \* " in the table above means the reading of emissions are attenuated more than 20dB below the permissible limits or the field strength is too small to be measured.
- (5) A preamp and high pass filter were used for this test in order to provide sufficient measurement sensitivity.
- (6) EUT Orthogonal Axis :  
 "X" - denotes Laid on Table ; "Y" - denotes Vertical Stand ; "Z" - denotes Side Stand
- (7) During the measurements above 1 GHz it is taken care of that the EUT is always within the 3 dB cone of radiation BW of the used antenna

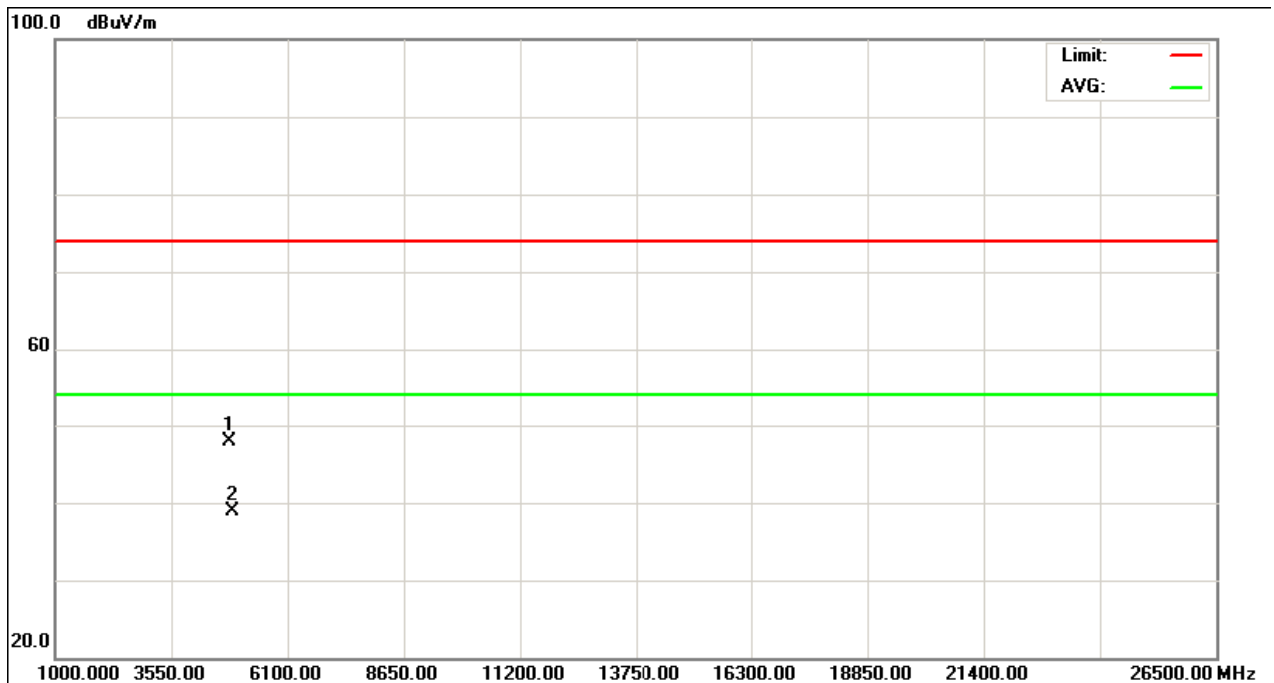
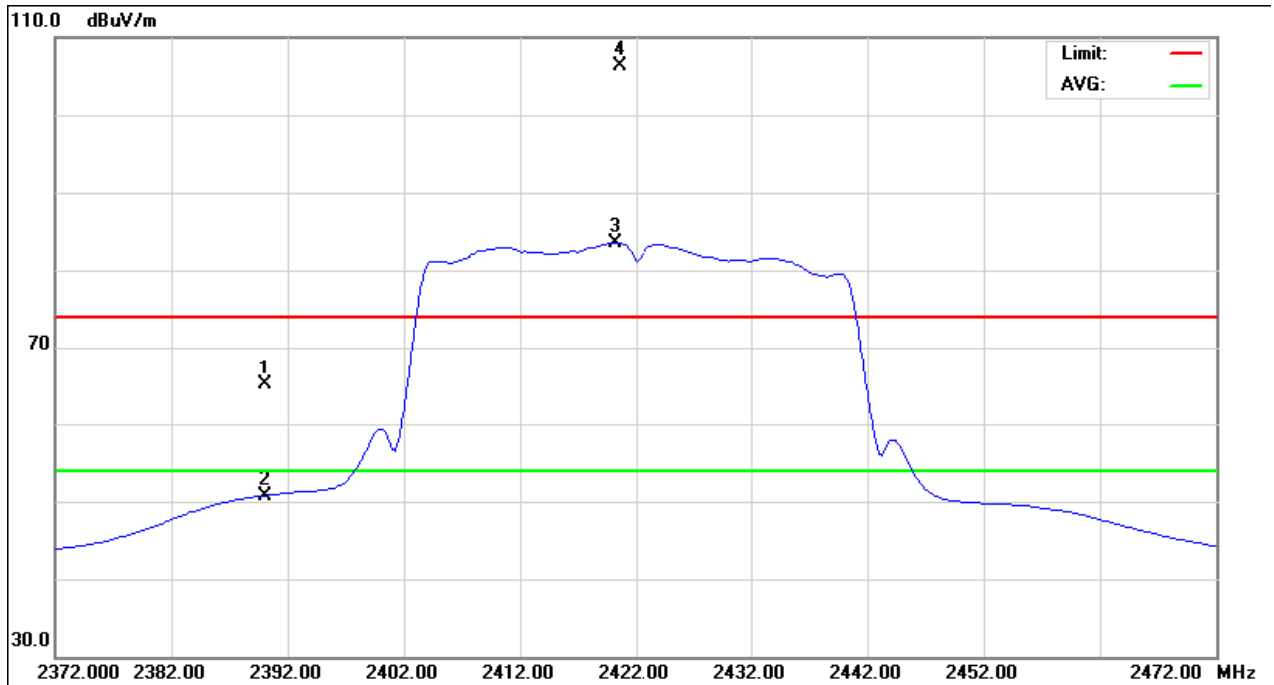
**TX CH03 (Above 1000 MHz, Horizontal)**

EUT:	BLU-RAY Disc Player	Model Name :	DX-WBRDVD1
Temperature:	20 °C	Relative Humidity:	53 %
Pressure:	1010 hPa	Test Voltage :	AC 120V/60Hz
Test Mode :	TX N-40M MODE 2437MHz		

Freq. (MHz)	Ant.Pol. H/V	Reading		Ant./CF CF(dB)	Act.		Limit		Note
		Peak (dBuV)	AV (dBuV)		Peak (dBuV/m)	AV (dBuV/m)	Peak (dBuV/m)	AV (dBuV/m)	
<b>2434.60</b>	<b>V</b>	<b>73.35</b>	<b>50.53</b>	<b>31.56</b>	<b>104.91</b>	<b>82.08</b>			<b>X/F</b>
4876.73	V	43.37	35.11	6.15	49.52	41.26	74.00	54.00	X/H

## Remark :

- (1) All readings are Peak unless otherwise stated QP in column of 『Note』 . Peak denotes that the Peak reading compliance with the QP Limits and then QP Mode measurement didn't perform
- (2) Measuring frequency range from 30MHz to 1000MHz or the 10th harmonic of highest fundamental frequency. "F" denotes fundamental frequency; "H" denotes spurious frequency. "E" denotes band edge frequency. (This judgment method includes the Band Edge Requirement.)
- (3) Radiated emissions measured in frequency range above 1000MHz were made with an instrument using Peak detector mode and AV detector mode of the emission
- (4) Data of measurement within this frequency range shown " \* " in the table above means the reading of emissions are attenuated more than 20dB below the permissible limits or the field strength is too small to be measured.
- (5) A preamp and high pass filter were used for this test in order to provide sufficient measurement sensitivity.
- (6) EUT Orthogonal Axis :  
 "X" - denotes Laid on Table ; "Y" - denotes Vertical Stand ; "Z" - denotes Side Stand
- (7) During the measurements above 1 GHz it is taken care of that the EUT is always within the 3 dB cone of radiation BW of the used antenna

TX CH06 (Above 1000 MHz, Vertical)

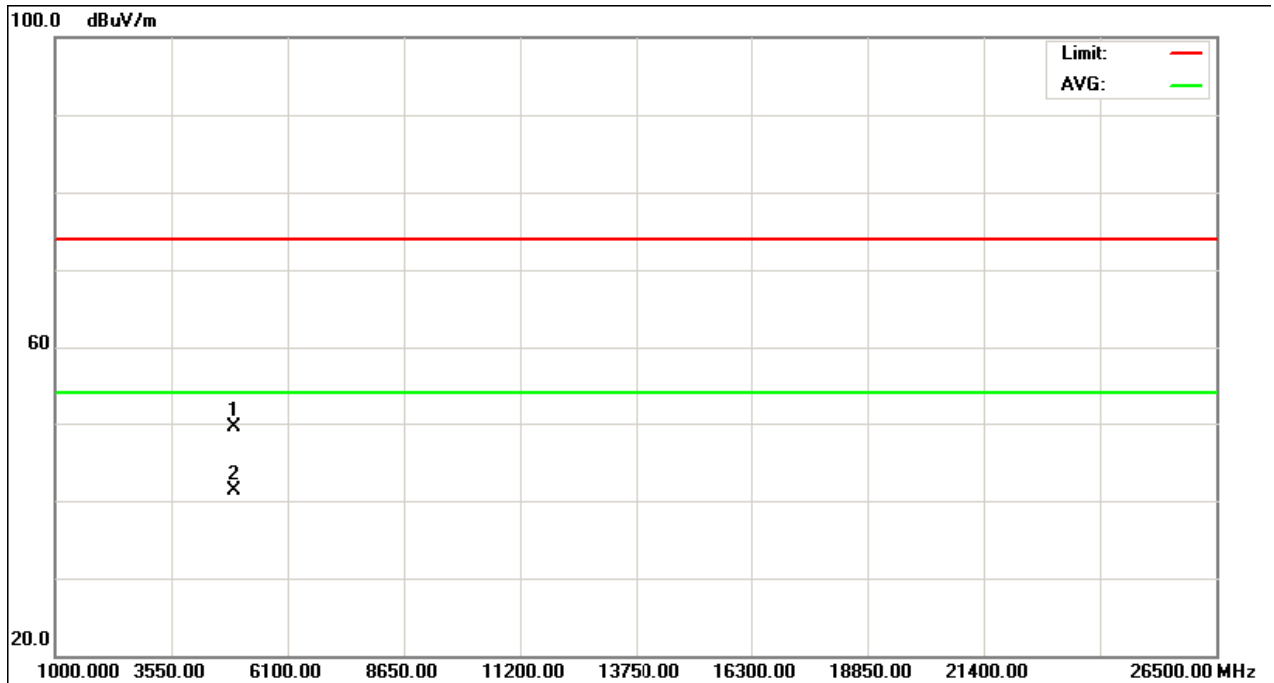
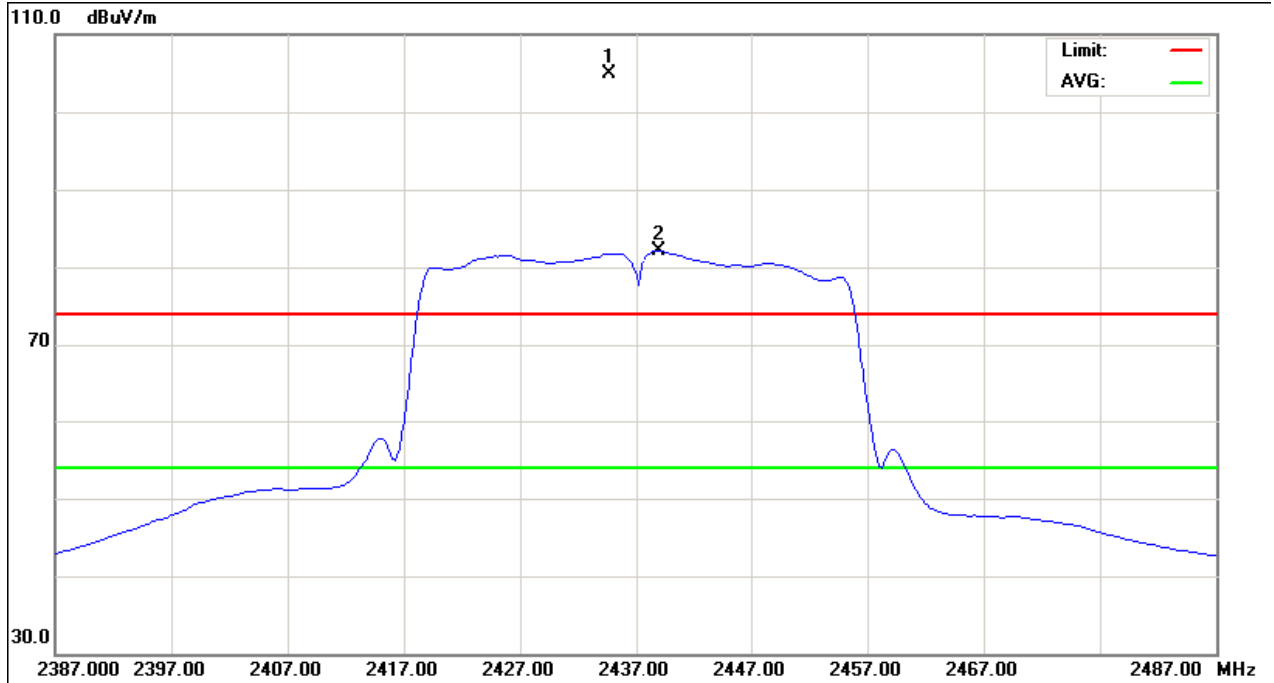



**Prüfbericht - Nr.: 17019992 001**  
*Test Report No.*
**Seite 73 von 130**  
*Page 73 of 130*

EUT:	BLU-RAY Disc Player	Model Name :	DX-WBRDVD1
Temperature:	20 °C	Relative Humidity:	53 %
Pressure:	1010 hPa	Test Voltage :	AC 120V/60Hz
Test Mode :	TX N-40M MODE 2437MHz		

Freq. (MHz)	Ant.Pol. H/V	Reading		Ant./CF CF(dB)	Act.		Limit		Note
		Peak (dBuV)	AV (dBuV)		Peak (dBuV/m)	AV (dBuV/m)	Peak (dBuV/m)	AV (dBuV/m)	
<b>2434.40</b>	<b>H</b>	<b>74.16</b>	<b>51.62</b>	<b>31.56</b>	<b>105.72</b>	<b>83.17</b>			<b>X/F</b>
4876.29	H	40.00	31.36	6.15	46.15	37.51	74.00	54.00	X/H

**Remark :**

- (1) All readings are Peak unless otherwise stated QP in column of 『Note』 . Peak denotes that the Peak reading compliance with the QP Limits and then QP Mode measurement didn't perform
- (2) Measuring frequency range from 30MHz to 1000MHz or the 10th harmonic of highest fundamental frequency. "F" denotes fundamental frequency; "H" denotes spurious frequency. "E" denotes band edge frequency. (This judgment method includes the Band Edge Requirement.)
- (3) Radiated emissions measured in frequency range above 1000MHz were made with an instrument using Peak detector mode and AV detector mode of the emission
- (4) Data of measurement within this frequency range shown " \* " in the table above means the reading of emissions are attenuated more than 20dB below the permissible limits or the field strength is too small to be measured.
- (5) A preamp and high pass filter were used for this test in order to provide sufficient measurement sensitivity.
- (6) EUT Orthogonal Axis :  
 "X" - denotes Laid on Table ; "Y" - denotes Vertical Stand ; "Z" - denotes Side Stand
- (7) During the measurements above 1 GHz it is taken care of that the EUT is always within the 3 dB cone of radiation BW of the used antenna

TX CH06 (Above 1000 MHz, Horizontal)

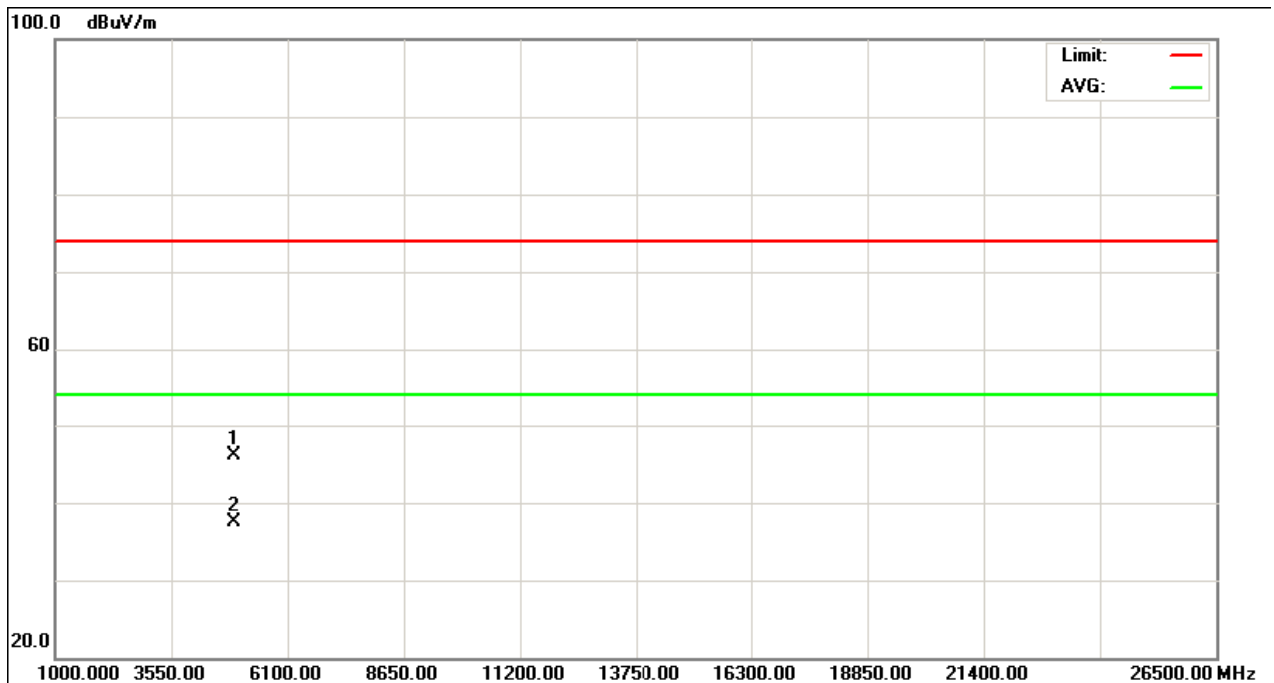
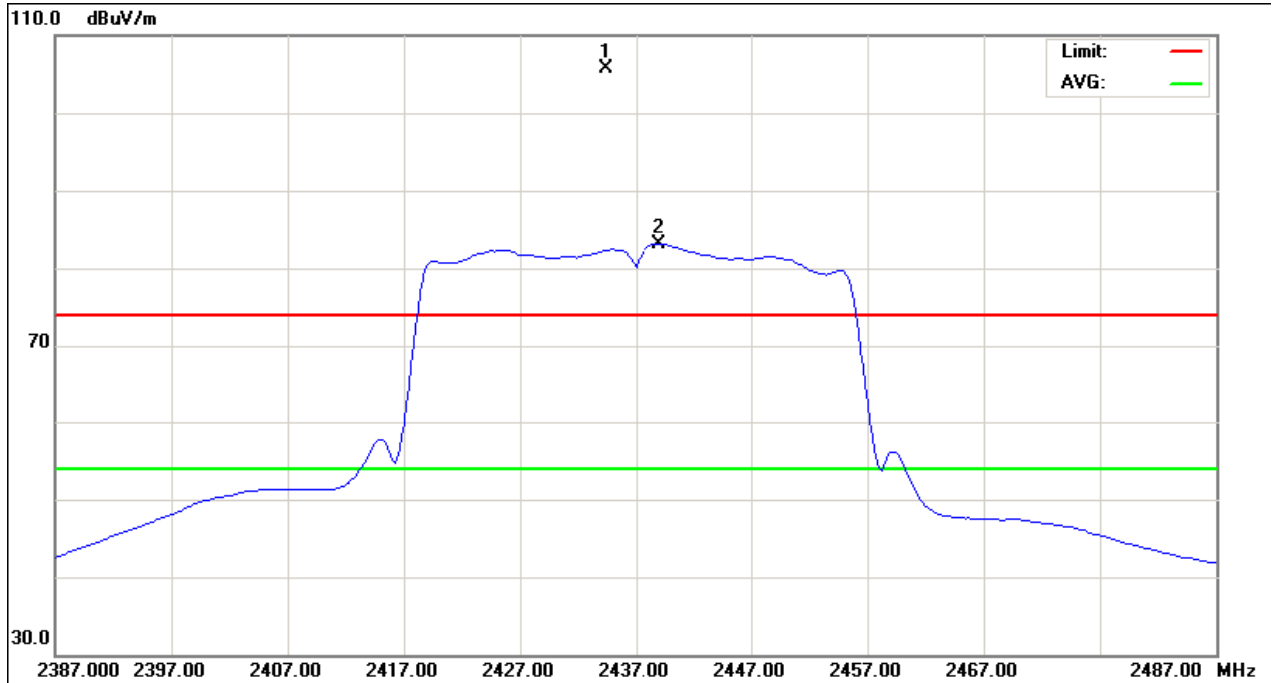

EUT:	BLU-RAY Disc Player	Model Name :	DX-WBRDVD1
Temperature:	20 °C	Relative Humidity:	53 %
Pressure:	1010 hPa	Test Voltage :	AC 120V/60Hz
Test Mode :	TX N-40M MODE 2452MHz		

Freq.	Ant.Pol.	Reading		Ant./CF	Act.		Limit		Note
		Peak	AV		Peak	AV	Peak	AV	
(MHz)	H/V	(dBuV)	(dBuV)	CF(dB)	(dBuV/m)	(dBuV/m)	(dBuV/m)	(dBuV/m)	
<b>2451.00</b>	<b>V</b>	<b>69.57</b>	<b>50.88</b>	<b>31.54</b>	<b>101.11</b>	<b>82.41</b>			<b>X/F</b>
2483.50	V	28.13	16.51	31.50	59.63	48.01	74.00	54.00	X/E
4903.84	V	40.53	33.14	6.23	46.76	39.37	74.00	54.00	X/H

**Remark :**

- (1) All readings are Peak unless otherwise stated QP in column of 『Note』 . Peak denotes that the Peak reading compliance with the QP Limits and then QP Mode measurement didn't perform
- (2) Measuring frequency range from 30MHz to 1000MHz or the 10th harmonic of highest fundamental frequency. "F" denotes fundamental frequency; "H" denotes spurious frequency. "E" denotes band edge frequency. (This judgment method includes the Band Edge Requirement.)
- (3) Radiated emissions measured in frequency range above 1000MHz were made with an instrument using Peak detector mode and AV detector mode of the emission
- (4) Data of measurement within this frequency range shown " \* " in the table above means the reading of emissions are attenuated more than 20dB below the permissible limits or the field strength is too small to be measured.
- (5) A preamp and high pass filter were used for this test in order to provide sufficient measurement sensitivity.
- (6) EUT Orthogonal Axis :  
 "X" - denotes Laid on Table ; "Y" - denotes Vertical Stand ; "Z" - denotes Side Stand
- (7) During the measurements above 1 GHz it is taken care of that the EUT is always within the 3 dB cone of radiation BW of the used antenna

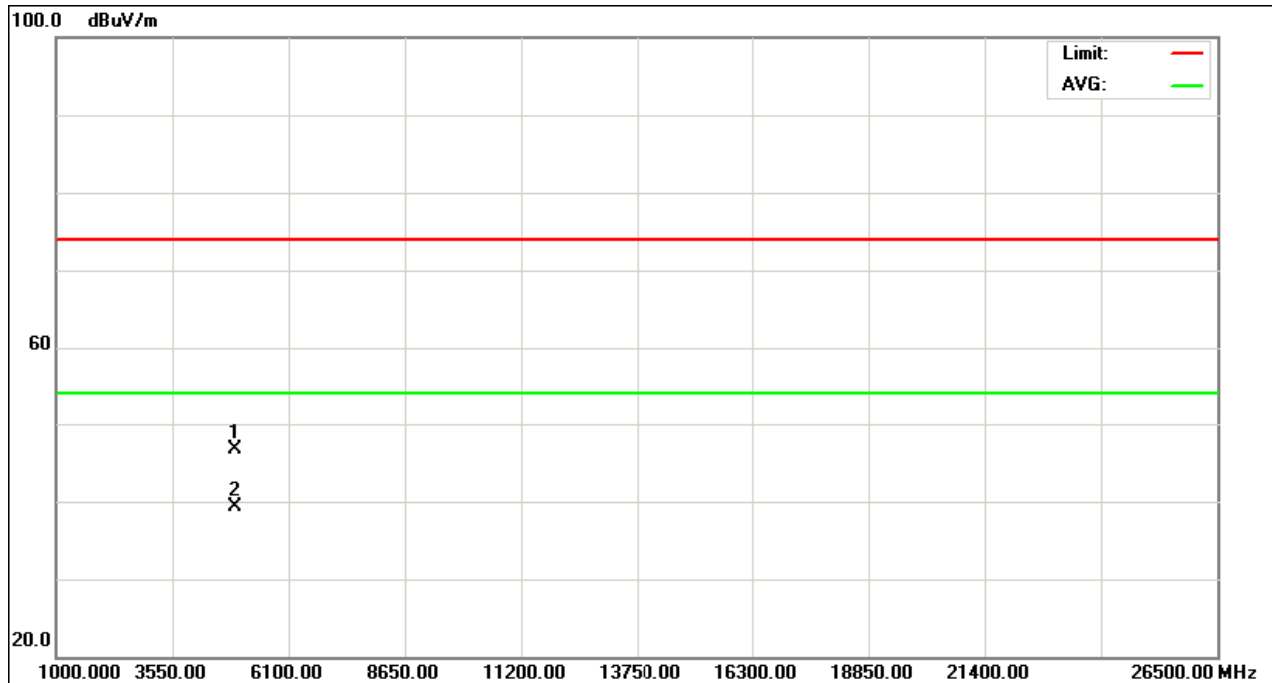
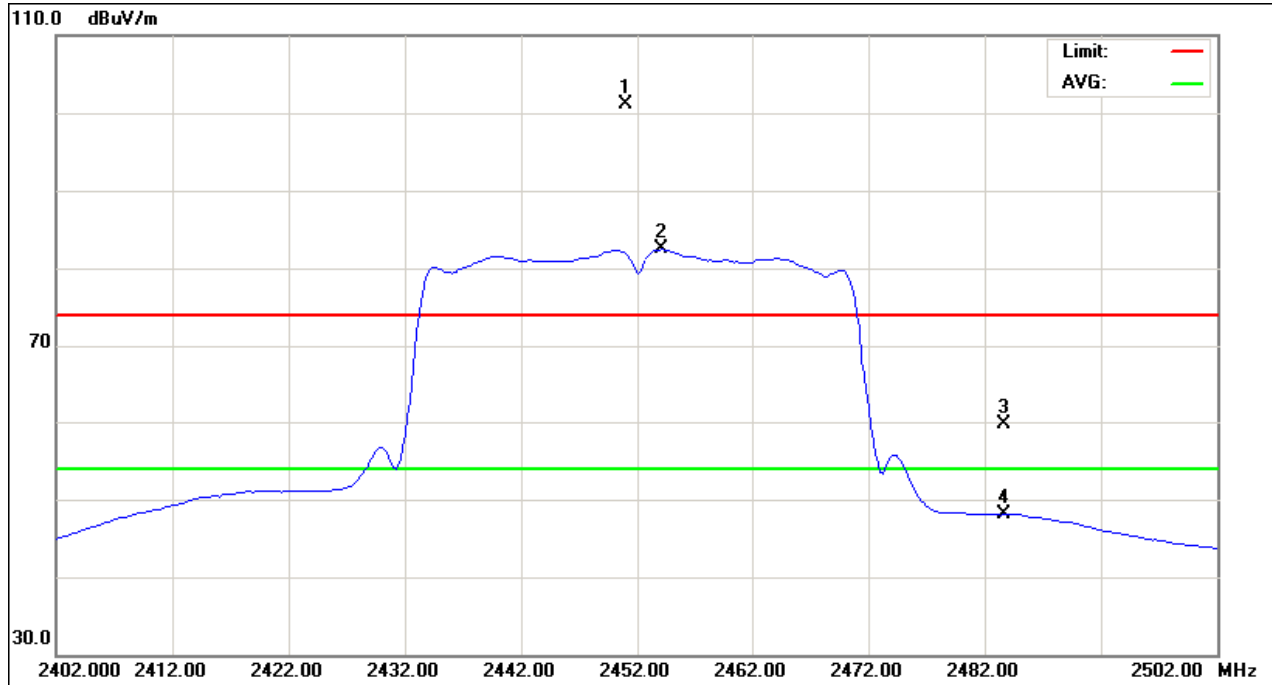
**TX CH09 (Above 1000 MHz, Vertical)**

EUT:	BLU-RAY Disc Player	Model Name :	DX-WBRDVD1
Temperature:	20 °C	Relative Humidity:	53 %
Pressure:	1010 hPa	Test Voltage :	AC 120V/60Hz
Test Mode :	TX N-40M MODE 2452MHz		

Freq.	Ant.Pol.	Reading		Ant./CF	Act.		Limit		Note
		Peak	AV		Peak	AV	Peak	AV	
(MHz)	H/V	(dBuV)	(dBuV)	CF(dB)	(dBuV/m)	(dBuV/m)	(dBuV/m)	(dBuV/m)	
<b>2450.00</b>	<b>H</b>	<b>70.36</b>	<b>51.86</b>	<b>31.54</b>	<b>101.90</b>	<b>83.40</b>			<b>X/F</b>
2483.50	H	31.32	16.38	31.50	62.82	47.88	74.00	54.00	X/E
4903.74	H	39.29	30.78	6.23	45.52	37.01	74.00	54.00	X/H

**Remark :**

- (1) All readings are Peak unless otherwise stated QP in column of 『Note』 . Peak denotes that the Peak reading compliance with the QP Limits and then QP Mode measurement didn't perform
- (2) Measuring frequency range from 30MHz to 1000MHz or the 10th harmonic of highest fundamental frequency. "F" denotes fundamental frequency; "H" denotes spurious frequency. "E" denotes band edge frequency. (This judgment method includes the Band Edge Requirement.)
- (3) Radiated emissions measured in frequency range above 1000MHz were made with an instrument using Peak detector mode and AV detector mode of the emission .
- (4) Data of measurement within this frequency range shown " \* " in the table above means the reading of emissions are attenuated more than 20dB below the permissible limits or the field strength is too small to be measured.
- (5) A preamp and high pass filter were used for this test in order to provide sufficient measurement sensitivity.
- (6) EUT Orthogonal Axis :  
 "X" - denotes Laid on Table ; "Y" - denotes Vertical Stand ; "Z" - denotes Side Stand
- (7) During the measurements above 1 GHz it is taken care of that the EUT is always within the 3 dB cone of radiation BW of the used antenna

TX CH09 (Above 1000 MHz, Horizontal)

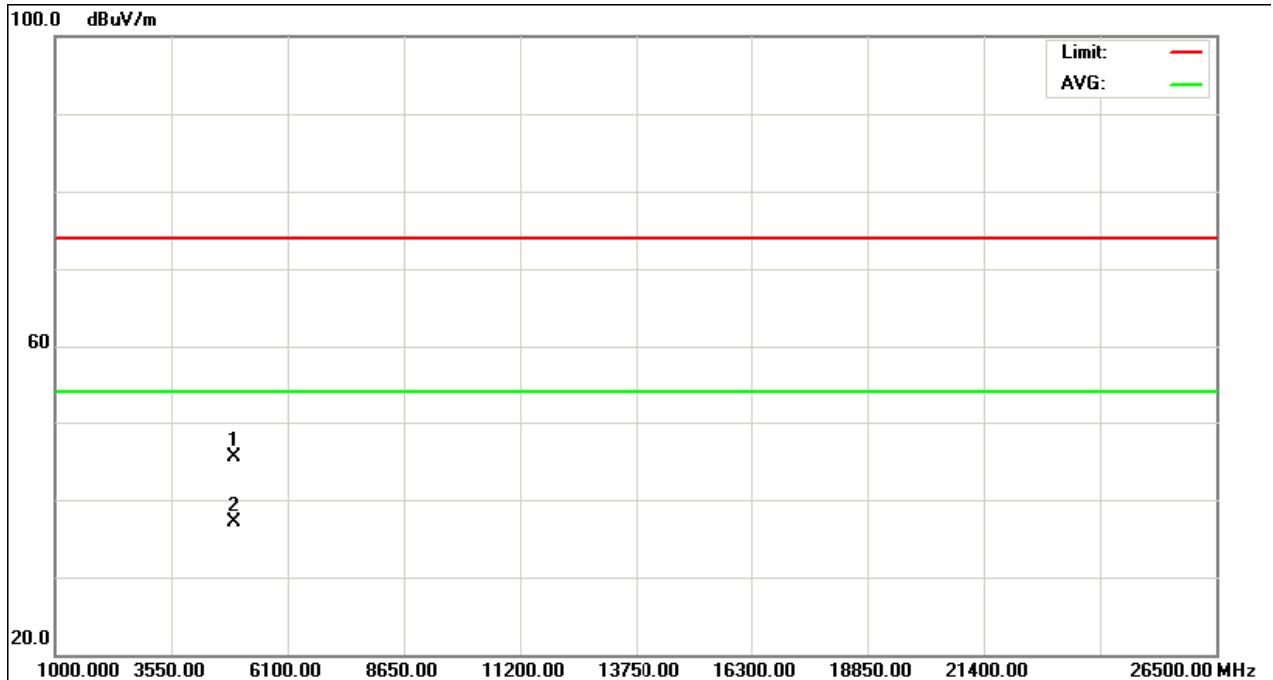
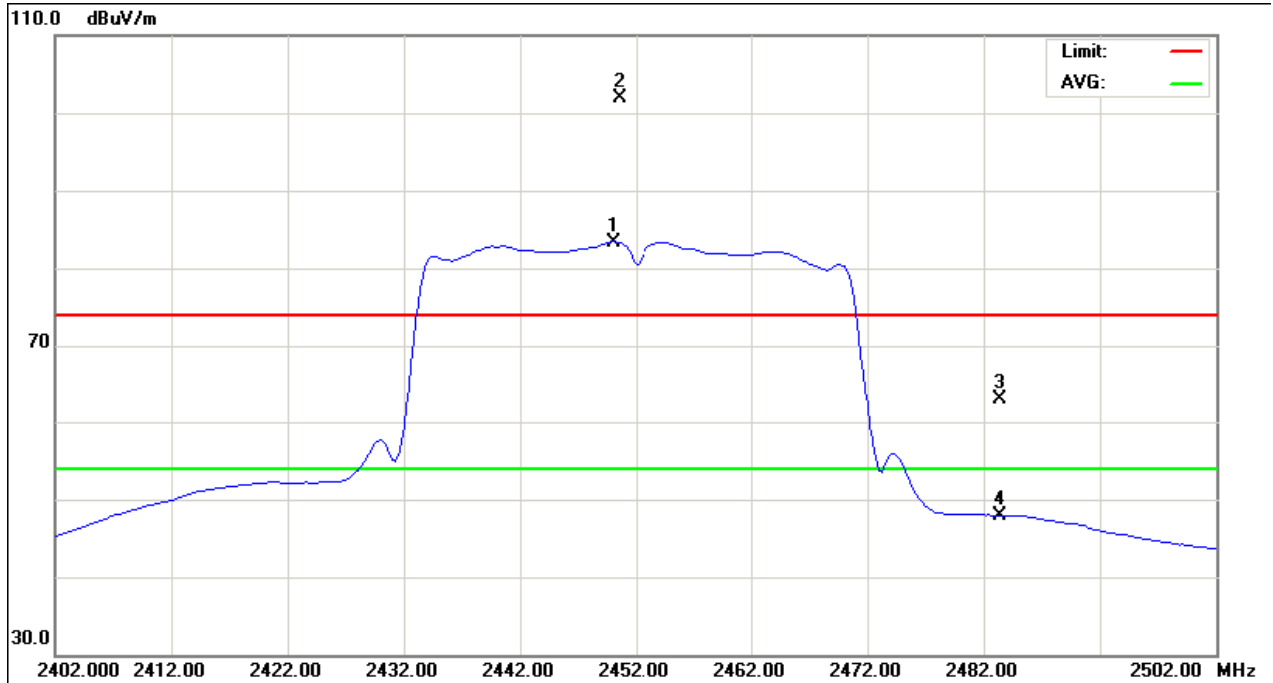

EUT:	BLU-RAY Disc Player	Model Name :	DX-WBRDVD1
Temperature:	23 °C	Relative Humidity:	54%
Pressure:	1010 hPa	Test Voltage :	AC 120V/60Hz
Test Mode :	RX Mode		

Freq. (MHz)	Ant.Pol. H/V	Reading		Ant./CF CF(dB)	Act.		Limit		Note
		Peak (dBuV)	AV (dBuV)		Peak (dBuV/m)	AV (dBuV/m)	Peak (dBuV/m)	AV (dBuV/m)	
1608.14	V	50.84	41.20	-3.71	47.13	37.49	74.00	54.00	X/H

**Remark :**

- (1) All readings are Peak unless otherwise stated QP in column of 『Note』 . Peak denotes that the Peak reading compliance with the QP Limits and then QP Mode measurement didn't perform
- (2) Measuring frequency range from 1000MHz to 6000MHz or the 10th harmonic of highest fundamental frequency. "F" denotes fundamental frequency; "H" denotes spurious frequency. "E" denotes band edge frequency. (This judgment method includes the Band Edge Requirement.)
- (3) Radiated emissions measured in frequency range above 1000MHz were made with an instrument using Peak detector mode and AV detector mode of the emission
- (4) Data of measurement within this frequency range shown " \* " in the table above means the reading of emissions are attenuated more than 20dB below the permissible limits or the field strength is too small to be measured.
- (5) A preamp and high pass filter were used for this test in order to provide sufficient measurement sensitivity.
- (6) EUT Orthogonal Axis :  
 "X" - denotes Laid on Table ; "Y" - denotes Vertical Stand ; "Z" - denotes Side Stand

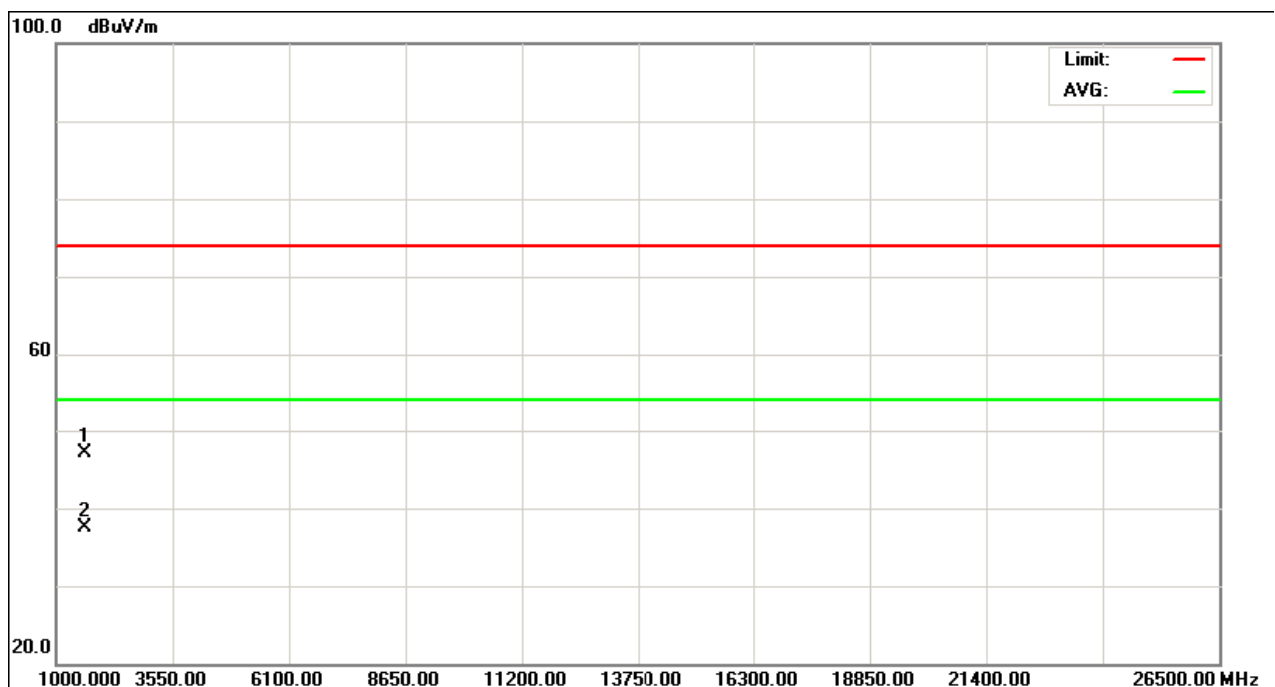

EUT:	BLU-RAY Disc Player	Model Name :	DX-WBRDVD1
Temperature:	23 °C	Relative Humidity:	54%
Pressure:	1010 hPa	Test Power :	AC 120V/60Hz
Test Mode :	RX Mode		

Freq. (MHz)	Ant.Pol. H/V	Reading		Ant./CF CF(dB)	Act.		Limit		Note
		Peak (dBuV)	AV (dBuV)		Peak (dBuV/m)	AV (dBuV/m)	Peak (dBuV/m)	AV (dBuV/m)	
1608.14	H	52.78	43.93	-3.71	49.07	40.22	74.00	54.00	X/H

**Remark :**

- (1) All readings are Peak unless otherwise stated QP in column of 『Note』 . Peak denotes that the Peak reading compliance with the QP Limits and then QP Mode measurement didn't perform
- (2) Measuring frequency range from 1000MHz to 6000MHz or the 10th harmonic of highest fundamental frequency. "F" denotes fundamental frequency; "H" denotes spurious frequency. "E" denotes band edge frequency. (This judgment method includes the Band Edge Requirement.)
- (3) Radiated emissions measured in frequency range above 1000MHz were made with an instrument using Peak detector mode and AV detector mode of the emission
- (4) Data of measurement within this frequency range shown " \* " in the table above means the reading of emissions are attenuated more than 20dB below the permissible limits or the field strength is too small to be measured.
- (5) A preamp and high pass filter were used for this test in order to provide sufficient measurement sensitivity.
- (6) EUT Orthogonal Axis :  
 "X" - denotes Laid on Table ; "Y" - denotes Vertical Stand ; "Z" - denotes Side Stand

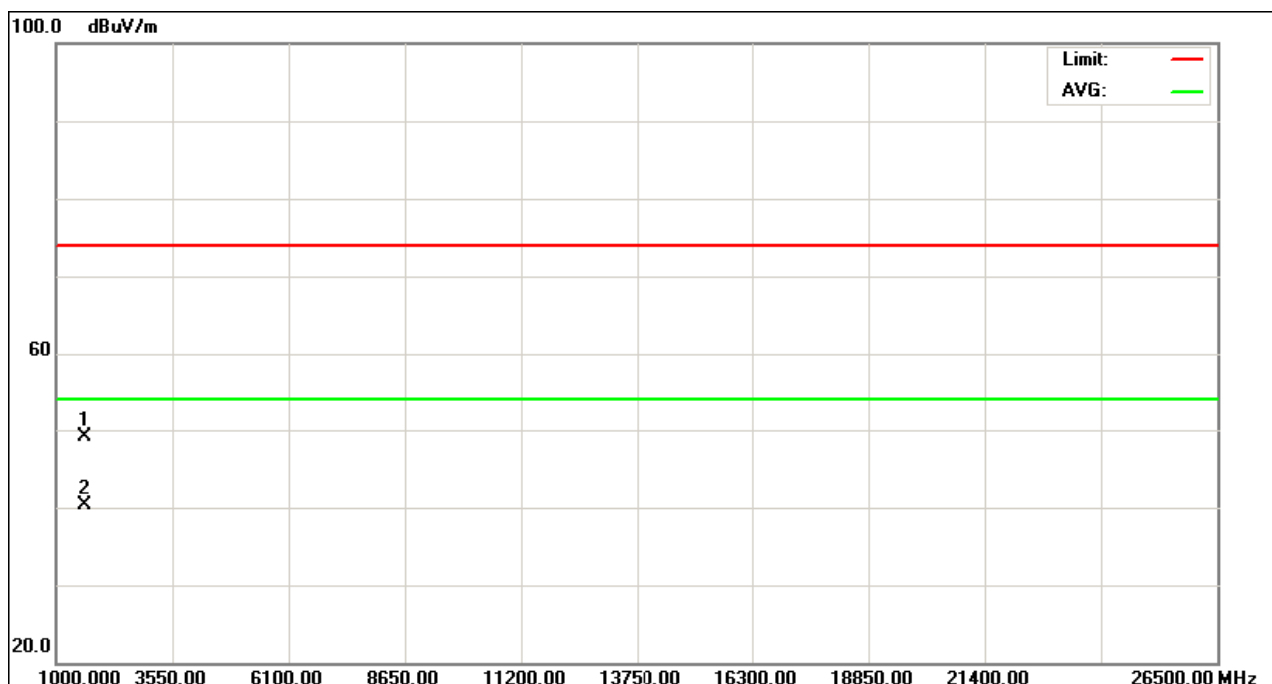



## 4. BANDWIDTH TEST

### 4.1. APPLIED PROCEDURES / LIMIT

FCC Part15 (15.247) , Subpart C/ RSS-210				
Section	Test Item	Limit	Frequency Range (MHz)	Result
15.247(a)(2)	Bandwidth	$\geq 500\text{KHz}$ (6dB bandwidth)	2400-2483.5	PASS

#### 4.1.1. MEASUREMENT INSTRUMENTS LIST

Item	Kind of Equipment	Manufacturer	Type No.	Serial No.	Calibrated until
1	Spectrum Analyzer	R&S	FSP_40	100129	Jan. 04, 2012

Remark: " N/A" denotes No Model Name. , Serial No. or No Calibration specified.

#### 4.1.2. TEST PROCEDURE

- a. The EUT was directly connected to the spectrum analyzer and antenna output port as show in the block diagram below,
- b. Spectrum Setting : RBW= 100KHz, VBW=100KHz, Sweep time = 5 ms.

#### 4.1.3. DEVIATION FROM STANDARD

No deviation.

#### 4.1.4. TEST SETUP

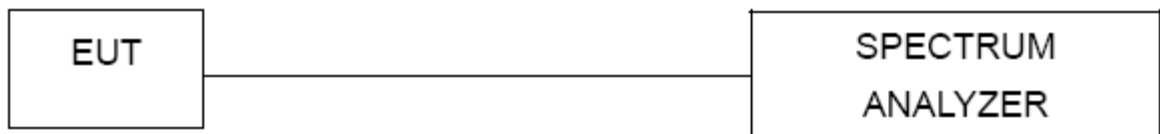

#### 4.1.5. EUT OPERATION CONDITIONS

The EUT tested system was configured as the statements of 4.1.6 Unless otherwise a special operating condition is specified in the follows during the testing.

#### 4.1.6. TEST RESULTS

EUT:	BLU-RAY Disc Player	Model Name. :	DX-WBRDVD1
Temperature:	24 °C	Relative Humidity:	60 %
Pressure:	1016 hPa	Test Voltage :	AC 120V/60Hz
Test Mode :	TX B MODE /CH01, CH06, CH11		

Test Channel	Frequency (MHz)	Bandwidth (MHz)	99% Bandwidth (MHz)	LIMIT (MHz)
CH01	2412	8.20	10.5	>=500KHz
CH06	2437	8.70	10.2	>=500KHz
CH11	2462	8.10	10.1	>=500KHz

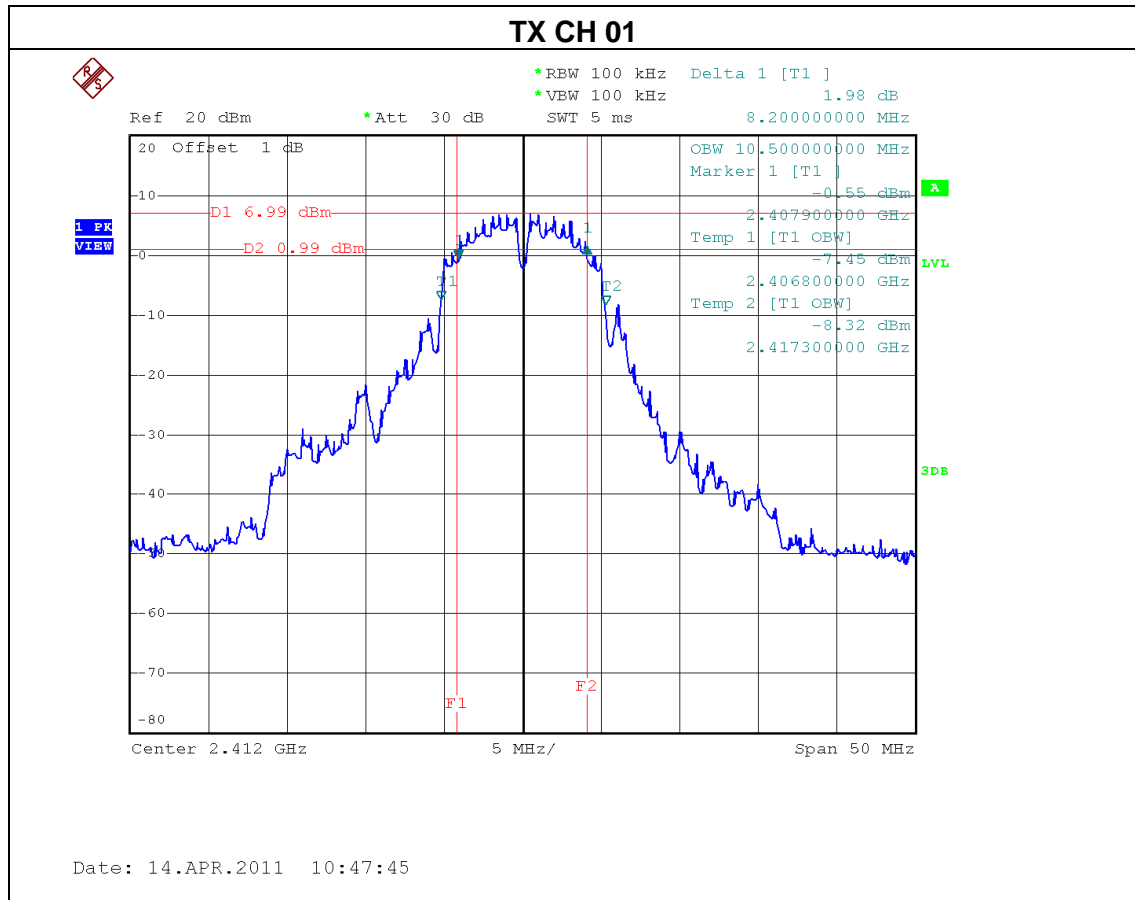

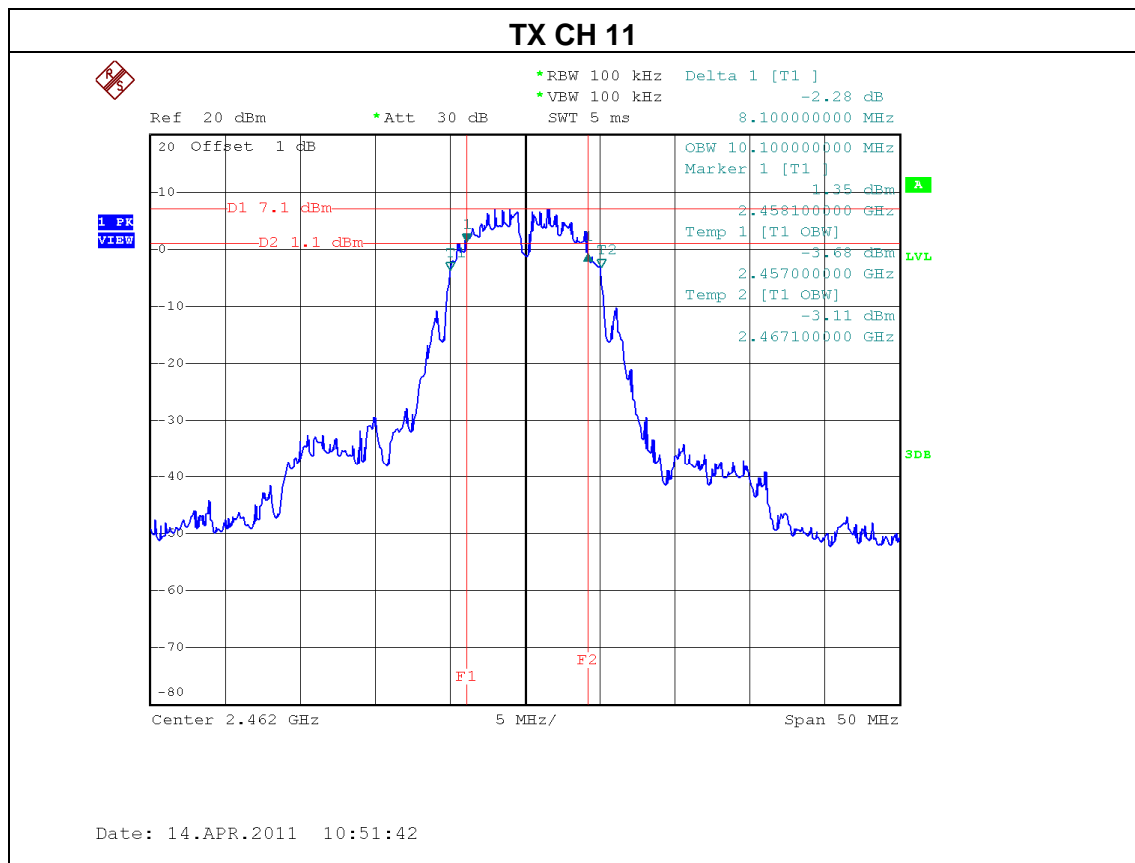
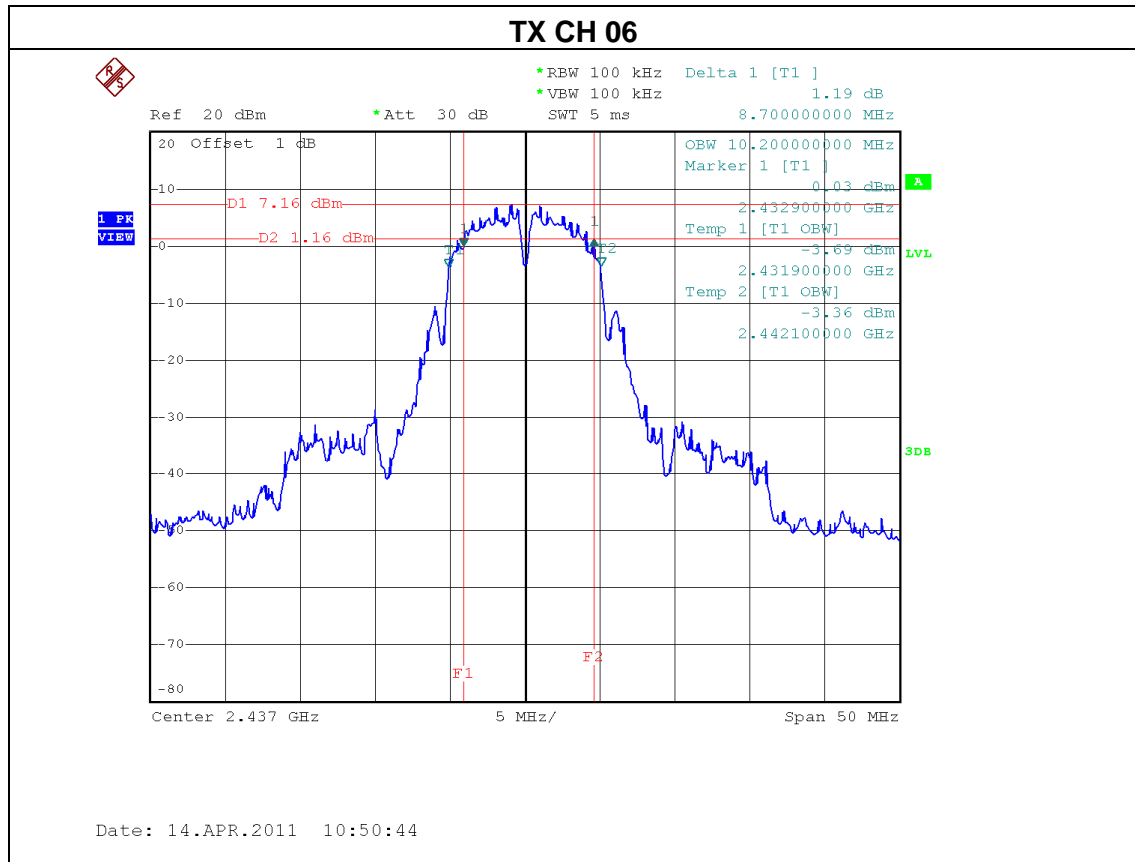

EUT:	BLU-RAY Disc Player	Model Name. :	DX-WBRDVD1
Temperature:	24 °C	Relative Humidity:	60 %
Pressure:	1016 hPa	Test Voltage :	AC 120V/60Hz
Test Mode :	TX G MODE /CH01, CH06, CH11		

Test Channel	Frequency (MHz)	Bandwidth (MHz)	99% Bandwidth (MHz)	LIMIT (MHz)
CH01	2412	16.40	16.40	>=500KHz
CH06	2437	16.40	16.30	>=500KHz
CH11	2462	16.50	16.30	>=500KHz

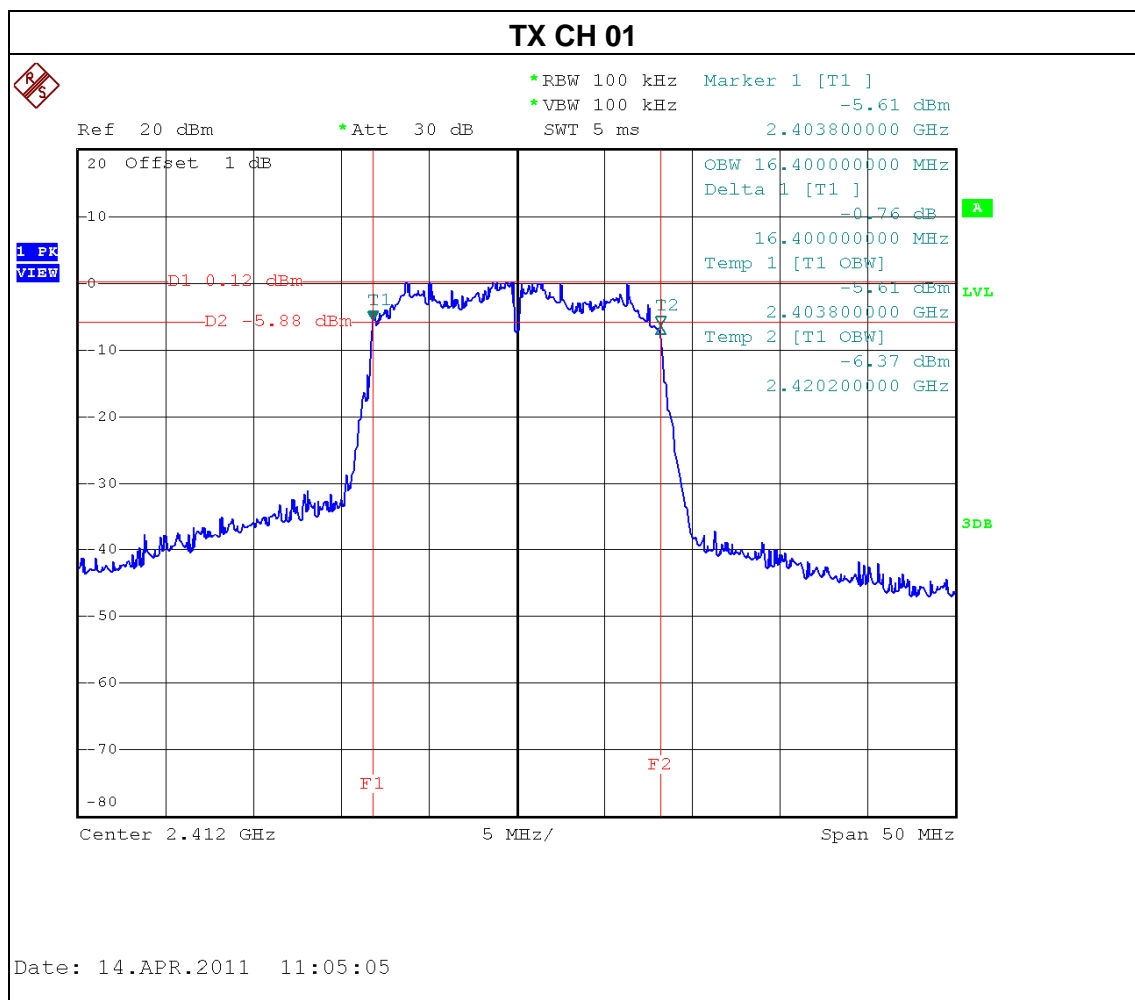

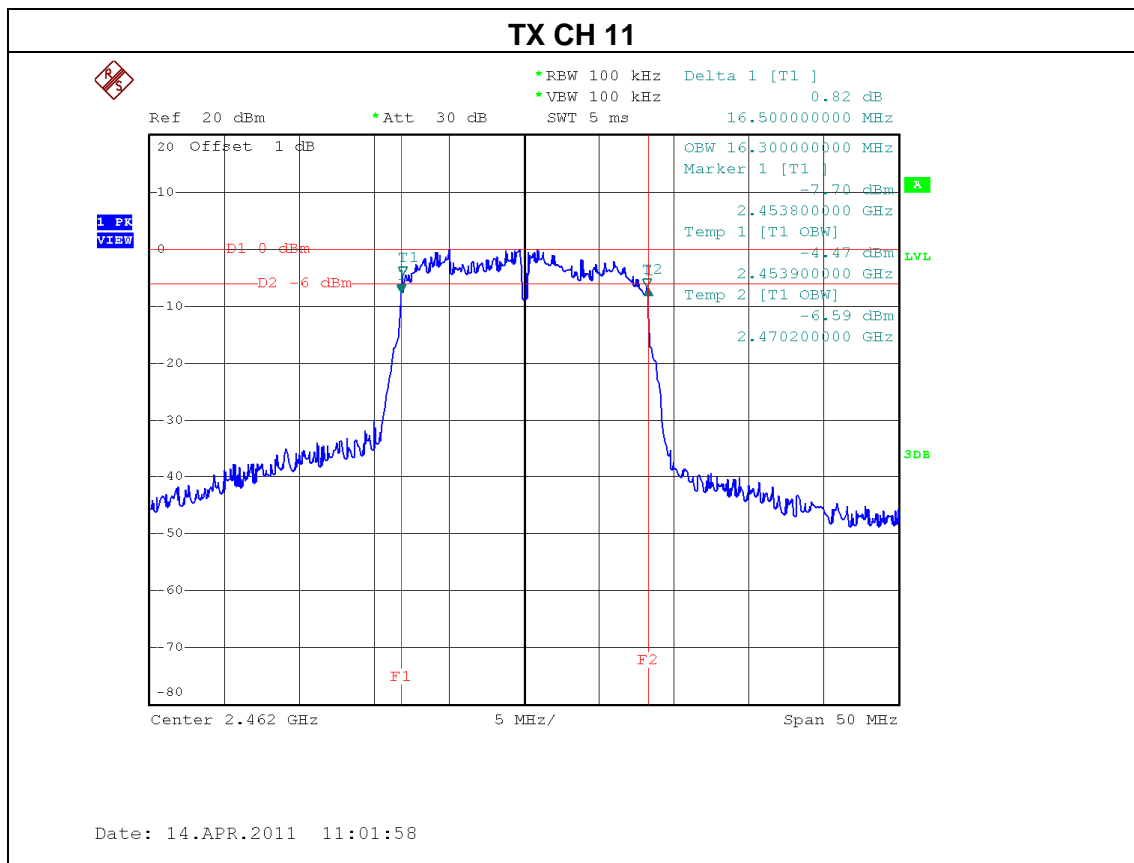
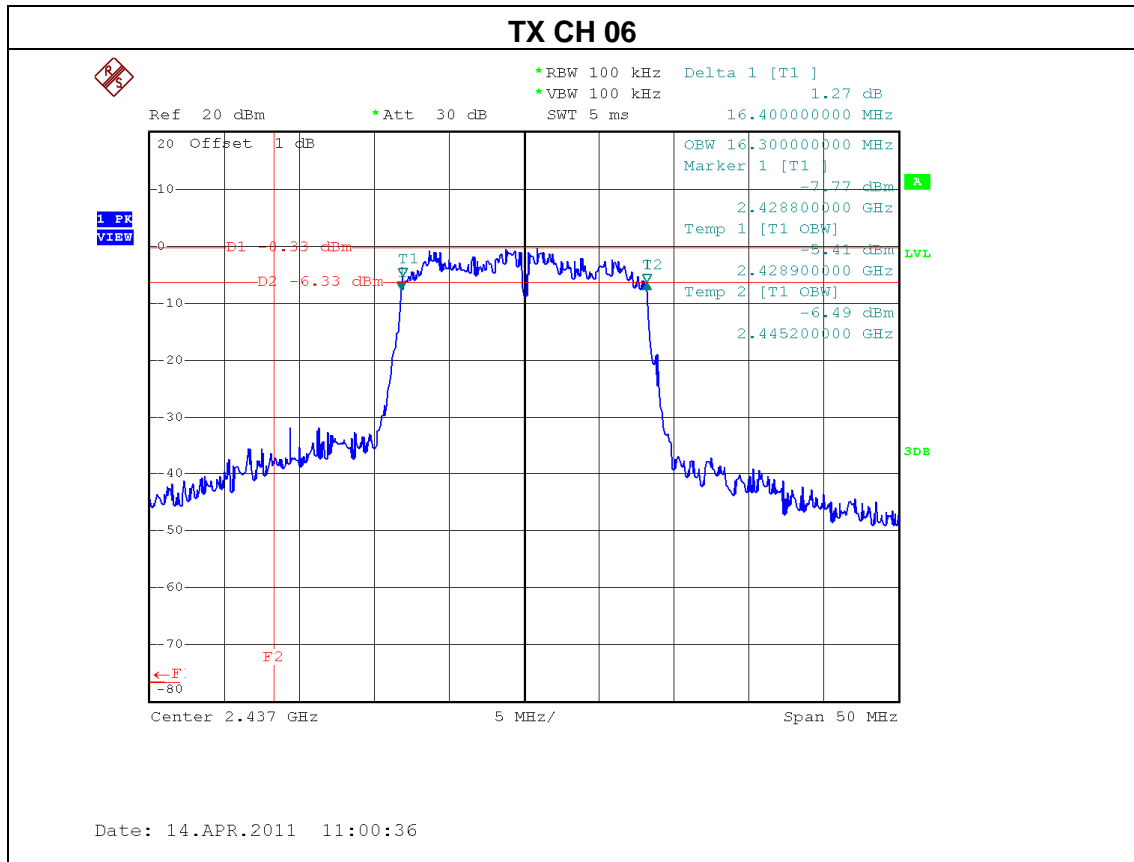

EUT:	BLU-RAY Disc Player	Model Name. :	DX-WBRDVD1
Temperature:	24 °C	Relative Humidity:	60 %
Pressure:	1016 hPa	Test Voltage :	AC 120V/60Hz
Test Mode :	TX N MODE -20MHz/ CH01, CH06, CH11		

Test Channel	Frequency (MHz)	Bandwidth (MHz)	99% Bandwidth (MHz)	LIMIT (MHz)
CH01	2412	17.70	17.60	>=500KHz
CH06	2437	17.70	17.60	>=500KHz
CH11	2462	17.70	17.60	>=500KHz

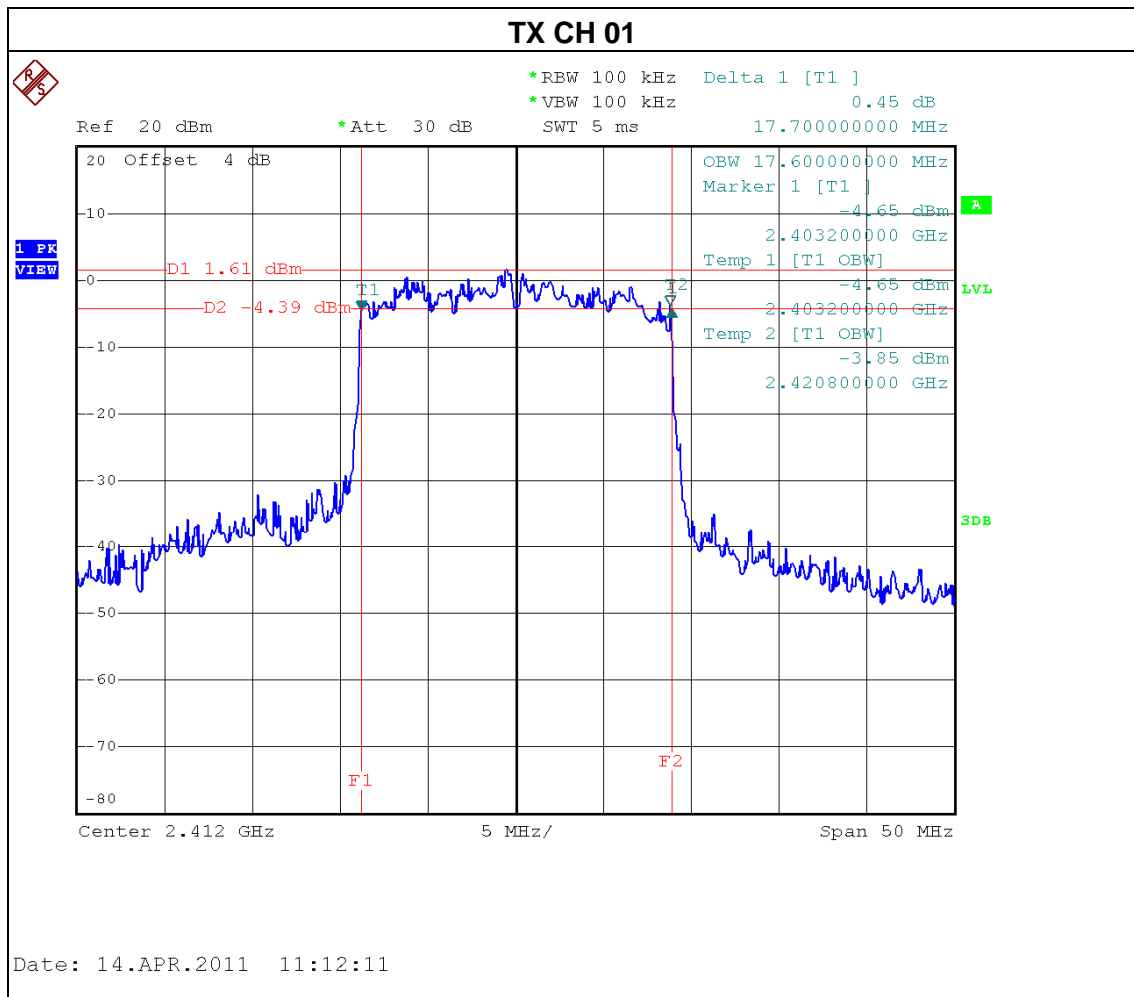

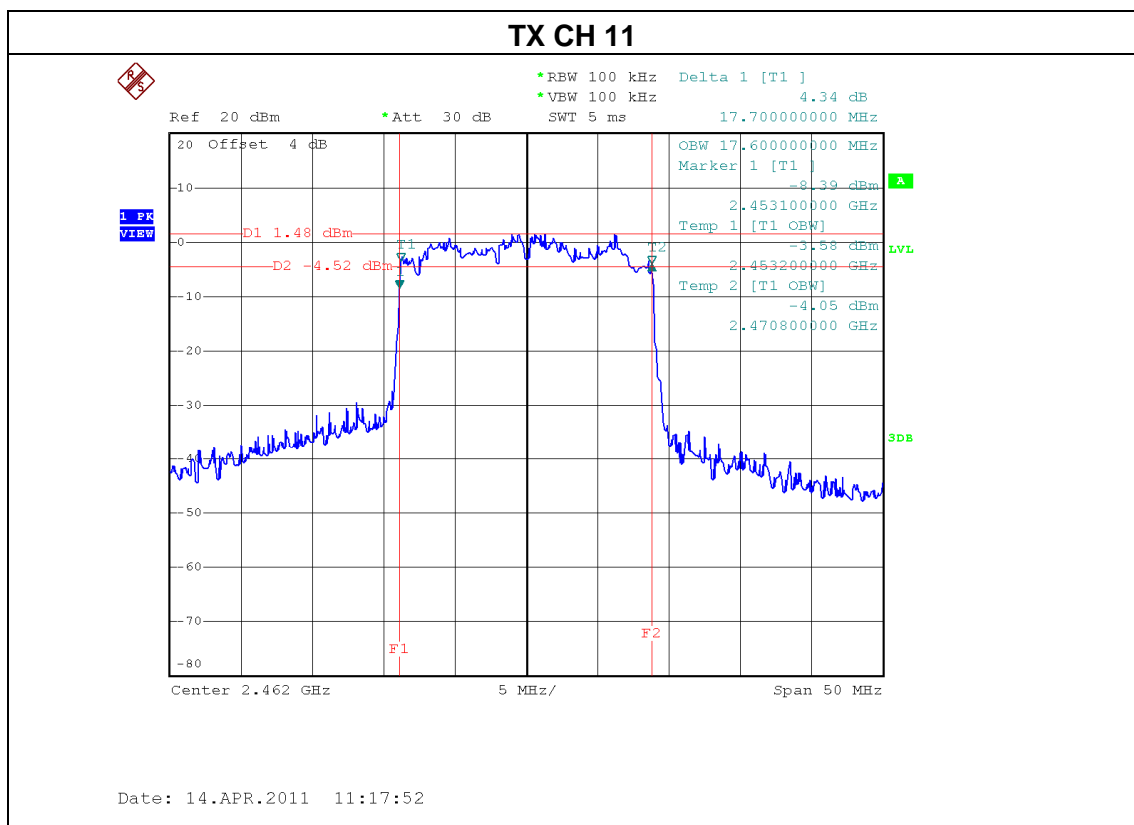
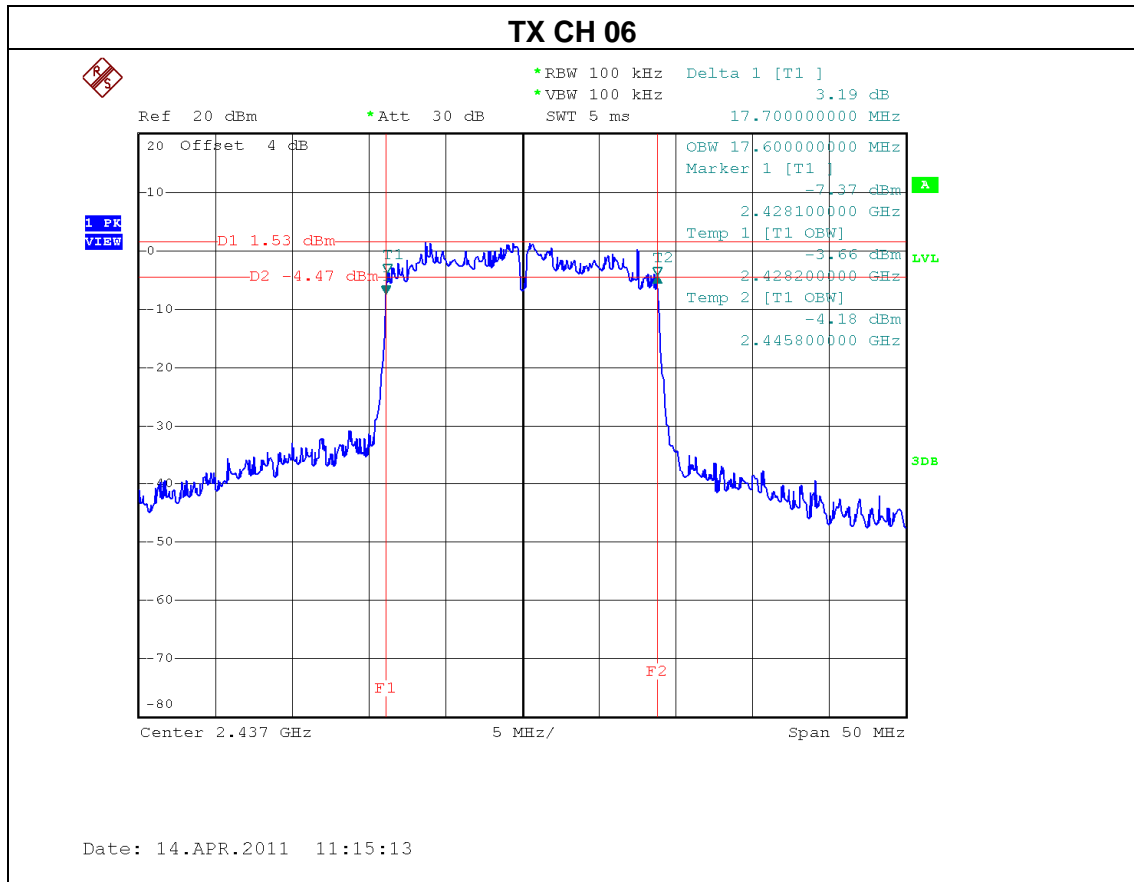



EUT:	BLU-RAY Disc Player	Model Name. :	DX-WBRDVD1
Temperature:	24 °C	Relative Humidity:	60 %
Pressure:	1016 hPa	Test Voltage :	AC 120V/60Hz
Test Mode :	TX N MODE -40MHz/ CH03, CH06, CH09		

Test Channel	Frequency (MHz)	Bandwidth (MHz)	99% Bandwidth (MHz)	LIMIT (MHz)
CH03	2422	36.40	36.40	>=500KHz
CH06	2437	36.00	36.40	>=500KHz
CH09	2452	36.40	36.40	>=500KHz

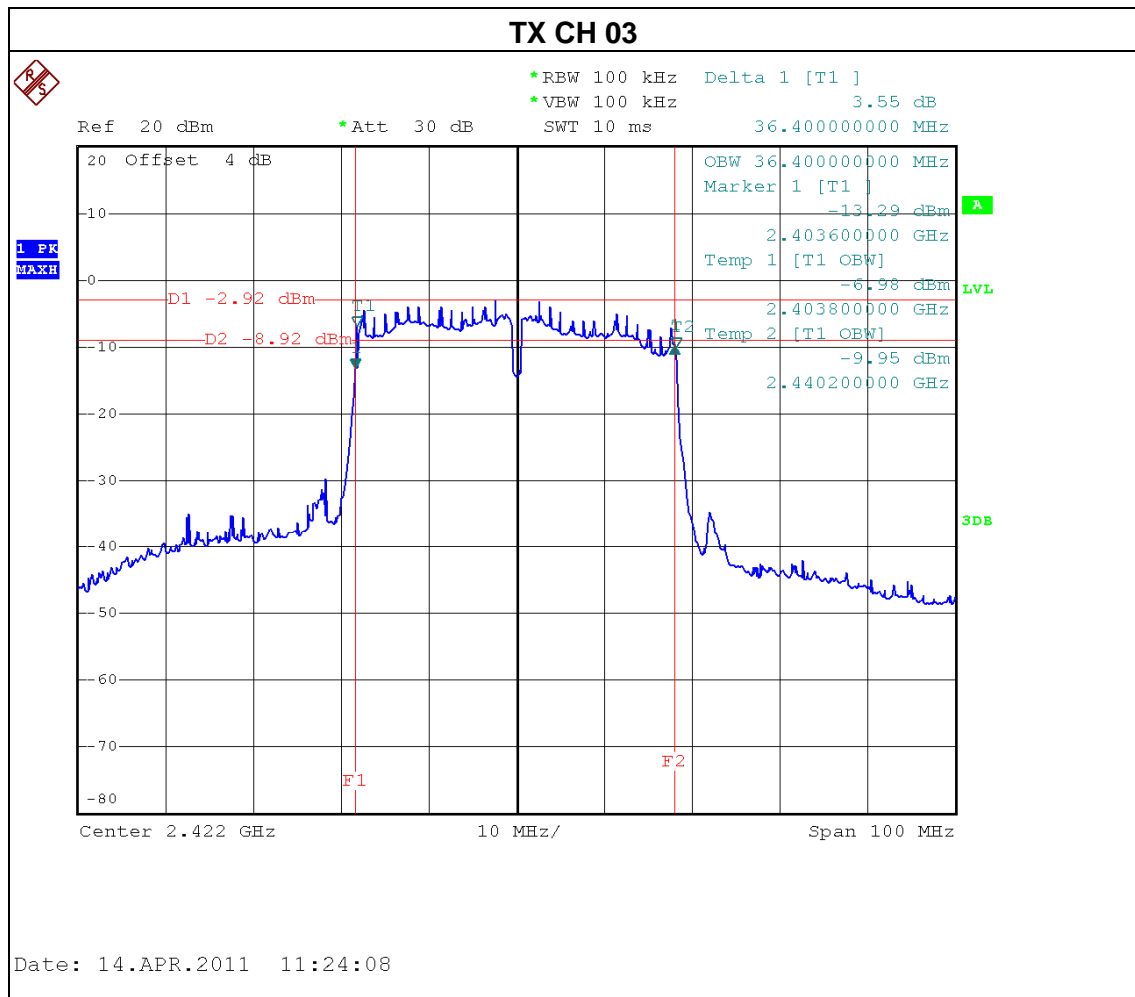

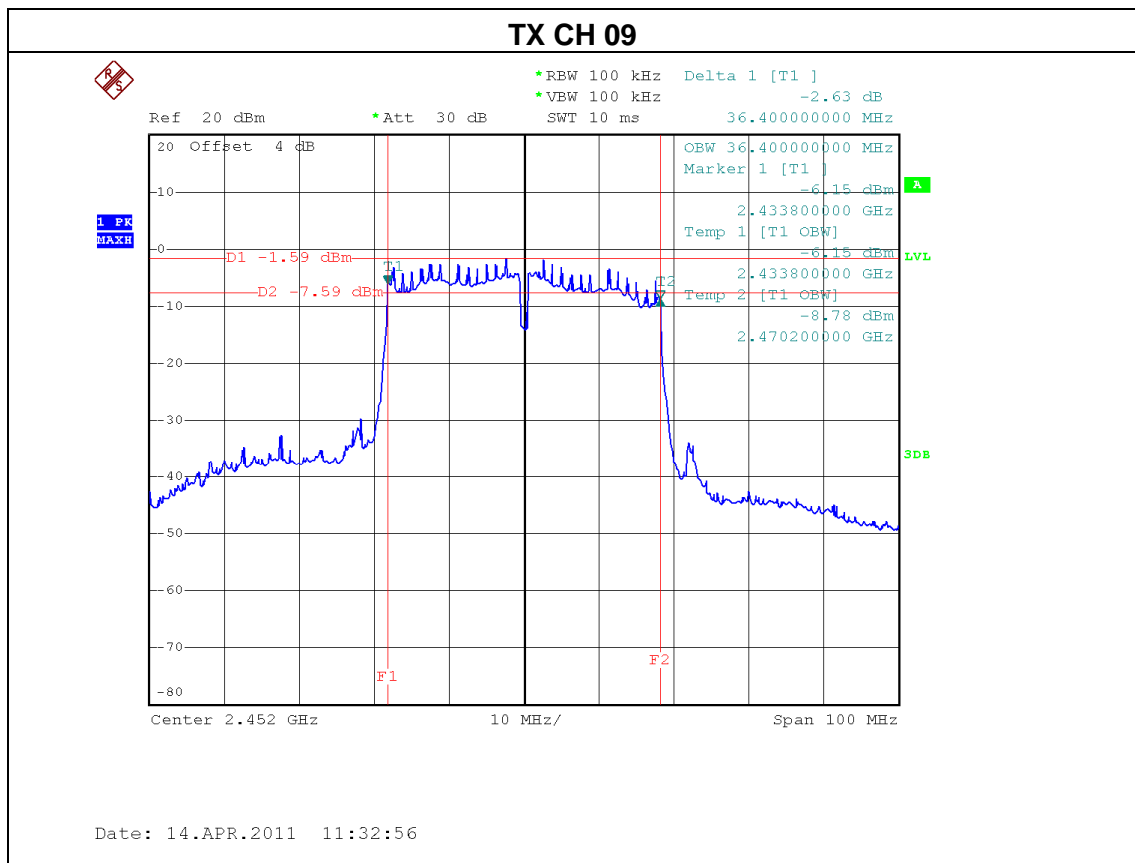
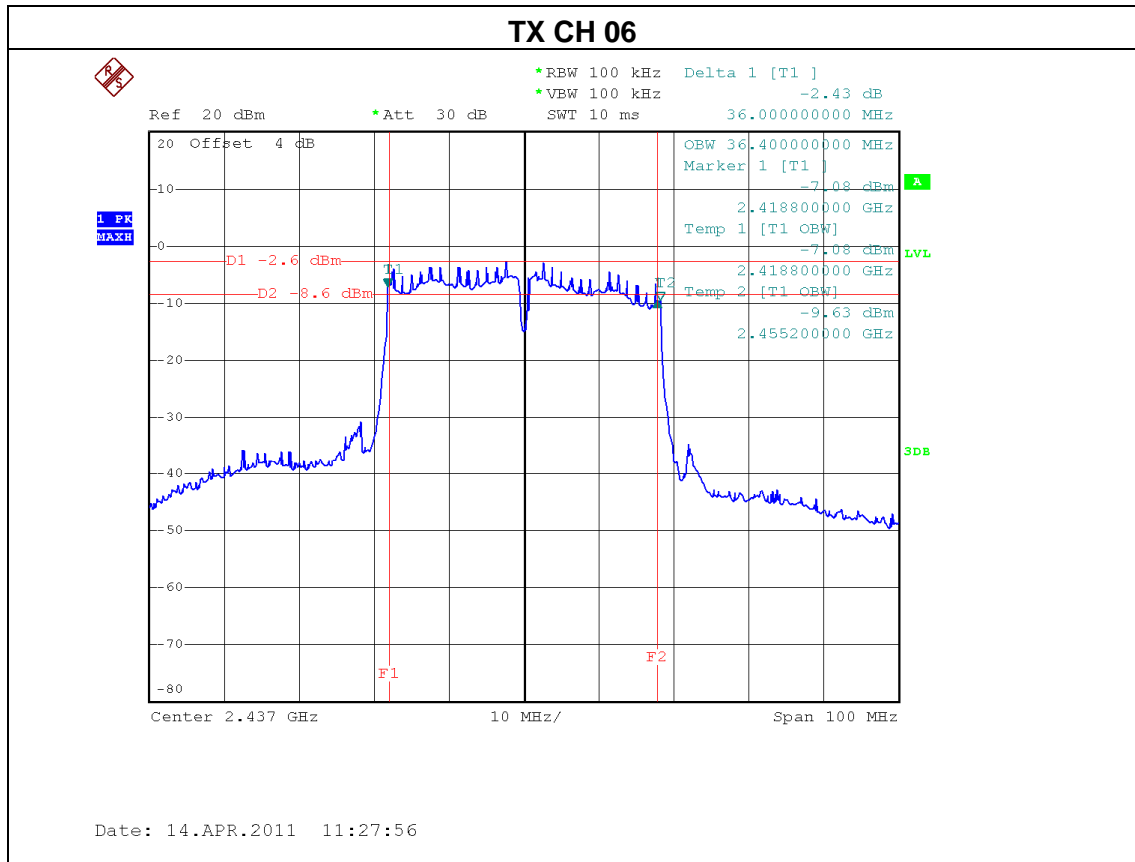

## 5. PEAK OUTPUT POWER TEST

### 5.1. APPLIED PROCEDURES / LIMIT

FCC Part15 (15.247) , Subpart C/ RSS-210				
Section	Test Item	Limit	Frequency Range (MHz)	Result
15.247(b)(3)	Maximum Output Power	1 watt or 30dBm	2400-2483.5	PASS

#### 5.1.1. MEASUREMENT INSTRUMENTS LIST

Item	Kind of Equipment	Manufacturer	Type No.	Serial No.	Calibrated until
1	Power Meter	Anritsu	ML2487A	6K00004714	Feb. 09, 2012
2	Power Meter Sensor	Anritsu	MA2491A	34138	Feb. 09, 2012

Remark: " N/A" denotes No Model Name. , Serial No. or No Calibration specified.

#### 5.1.2. TEST PROCEDURE

- a. The EUT was directly connected to the spectrum analyzer and antenna output port as show in the block diagram below,

#### 5.1.3. DEVIATION FROM STANDARD

No deviation.

#### 5.1.4. TEST SETUP



#### 5.1.5. EUT OPERATION CONDITIONS

The EUT tested system was configured as the statements of 4.1.6 Unless otherwise a special operating condition is specified in the follows during the testing.

### 5.1.6. TEST RESULTS

EUT:	BLU-RAY Disc Player	Model Name :	DX-WBRDVD1
Temperature:	24 °C	Relative Humidity:	60 %
Pressure:	1016 hPa	Test Voltage :	AC 120V/60Hz
Test Mode :	TX B MODE /CH01, CH06, CH11		

**Peak Output Power**

Test Channel	Frequency (MHz)	Peak Output Power (dBm)	LIMIT (dBm)	LIMIT (W)
CH01	2412 MHz	18.26	30	1
CH06	2437 MHz	18.24	30	1
CH11	2462 MHz	18.06	30	1

**Average Output Power limit: None; for reporting purposes only**

Test Channel	Frequency (MHz)	Avg Output Power (dBm)	LIMIT (dBm)	LIMIT (W)
CH01	2412 MHz	15.23	None	None
CH06	2437 MHz	15.35	None	None
CH11	2462 MHz	15.27	None	None

EUT:	BLU-RAY Disc Player	Model Name :	DX-WBRDVD1
Temperature:	24 °C	Relative Humidity:	60 %
Pressure:	1016 hPa	Test Voltage :	AC 120V/60Hz
Test Mode :	TX G MODE /CH01, CH06, CH11		

**Peak Output Power**

Test Channel	Frequency (MHz)	Peak Output Power (dBm)	LIMIT (dBm)	LIMIT (W)
CH01	2412 MHz	22.03	30	1
CH06	2437 MHz	22.12	30	1
CH11	2462 MHz	22.25	30	1

**Average Output Power limit: None; for reporting purposes only**

Test Channel	Frequency (MHz)	Avg Output Power (dBm)	LIMIT (dBm)	LIMIT (W)
CH01	2412 MHz	14.05	None	None
CH06	2437 MHz	14.17	None	None
CH11	2462 MHz	14.15	None	None

EUT:	BLU-RAY Disc Player	Model Name :	DX-WBRDVD1
Temperature:	24 °C	Relative Humidity:	60 %
Pressure:	1016 hPa	Test Voltage :	AC 120V/60Hz
Test Mode :	TX N-20M MODE /CH01, CH06, CH11		

**Peak Output Power**

SISO mode:

Test Channel	Frequency (MHz)	Peak Output Power (dBm) /ANT 0	LIMIT (dBm)	LIMIT (W)
CH01	2412 MHz	22.52	30	1
CH06	2437 MHz	22.61	30	1
CH11	2462 MHz	22.63	30	1

CDD mode:

Test Channel	Frequency (MHz)	Peak Output Power (dBm)			LIMIT (dBm)	LIMIT (W)
		ANT 0	ANT 1	Total		
CH01	2412 MHz	19.23	19.02	22.13	30	1
CH06	2437 MHz	18.97	18.76	21.87	30	1
CH11	2462 MHz	19.12	18.98	22.06	30	1

**Average Output Power limit: None; for reporting purposes only**

SISO mode:

Test Channel	Frequency (MHz)	Avg Output Power (dBm)/ ANT 0	LIMIT (dBm)	LIMIT (W)
CH01	2412 MHz	14.30	None	None
CH06	2437 MHz	14.37	None	None
CH11	2462 MHz	14.44	None	None

CDD mode:

Test Channel	Frequency (MHz)	Avg Output Power (dBm)			LIMIT (dBm)	LIMIT (W)
		ANT 0	ANT 1	Total		
CH01	2412 MHz	11.35	11.13	14.25	30	1
CH06	2437 MHz	11.14	11.01	14.08	30	1
CH11	2462 MHz	11.28	11.02	14.16	30	1

EUT:	BLU-RAY Disc Player	Model Name :	DX-WBRDVD1
Temperature:	24 °C	Relative Humidity:	60 %
Pressure:	1016 hPa	Test Voltage :	AC 120V/60Hz
Test Mode :	TX N-40M MODE /CH03, CH06, CH09		

**Peak Output Power**

SISO mode:

Test Channel	Frequency (MHz)	Peak Output Power (dBm) / ANT 0	LIMIT (dBm)	LIMIT (W)
CH03	2422 MHz	18.05	30	1
CH06	2437 MHz	17.96	30	1
CH09	2452 MHz	18.01	30	1

CDD mode:

Test Channel	Frequency (MHz)	Peak Output Power (dBm)			LIMIT (dBm)	LIMIT (W)
		ANT 0	ANT 1	Total		
CH03	2422 MHz	15.02	14.87	17.95	30	1
CH06	2437 MHz	14.78	14.65	17.72	30	1
CH09	2452 MHz	15.12	14.79	17.96	30	1

**Average Output Power limit: None; for reporting purposes only**

SISO mode:

Test Channel	Frequency (MHz)	Avg Output Power (dBm) / ANT 0	LIMIT (dBm)	LIMIT (W)
CH03	2422 MHz	11.44	None	None
CH06	2437 MHz	11.39	None	None
CH09	2452 MHz	11.41	None	None

CDD mode:

Test Channel	Frequency (MHz)	Avg Output Power (dBm)			LIMIT (dBm)	LIMIT (W)
		ANT 0	ANT 1	Total		
CH03	2422 MHz	8.24	8.06	11.16	30	1
CH06	2437 MHz	8.01	7.98	11.00	30	1
CH09	2452 MHz	8.31	8.11	11.22	30	1

## 6. ANTENNA CONDUCTED SPURIOUS EMISSION

### 6.1. APPLIED PROCEDURES / LIMIT

20dBc in any 100 kHz bandwidth outside the operating frequency band. In case the emission fall within the restricted band specified on 15.205(a), then the 15.209(a) limit in the table below has to be followed.

Frequencies (MHz)	Field Strength (micровolts/meter)	Measurement Distance (meters)
0.009~0.490	2400/F(KHz)	300
0.490~1.705	24000/F(KHz)	30
1.705~30.0	30	30
30~88	100	3
88~216	150	3
216~960	200	3
Above 960	500	3

#### 6.1.1. MEASUREMENT INSTRUMENTS LIST

Item	Kind of Equipment	Manufacturer	Type No.	Serial No.	Calibrated until
1	Spectrum Analyzer	R&S	FSP_40	100129	Jan. 04, 2012

Remark: " N/A" denotes No Model Name. , Serial No. or No Calibration specified.

#### 6.1.2. TEST PROCEDURE

- a. The EUT was directly connected to the spectrum analyzer and antenna output port as show in the block diagram below,
- b. Spectrum Setting : RBW= 100KHz, VBW=100KHz, Sweep time = 10 ms.



### 6.1.3. DEVIATION FROM STANDARD

No deviation.

### 6.1.4. TEST SETUP



### 6.1.5. EUT OPERATION CONDITIONS

The EUT tested system was configured as the statements of 4.1.6 Unless otherwise a special operating condition is specified in the follows during the testing.  
 Due to clause 5.1.6, the EUT operated SISO mode were found to be the worst case. Following tests were applied to SISO mode at ANT 0 and no emissions more than 20dB below limit were found. Since all peak output power in CDD mode are below the value of SISO mode, hence compliance is archived as well.

### 6.1.6. TEST RESULTS

EUT:	BLU-RAY Disc Player	Model Name :	DX-WBRDVD1
Temperature:	24 °C	Relative Humidity:	60 %
Pressure:	1016 hPa	Test Voltage :	AC 120V/60Hz
Test Mode :	TX B MODE /CH01, CH06 , CH11		

**Channel of Worst Data: CH01**

The max. radio frequency power in any 100kHz bandwidth outside the frequency band		The max. radio frequency power in any 100 kHz bandwidth within the frequency band.	
FREQUENCY(MHz)	POWER(dBm)	FREQUENCY(MHz)	POWER(dBm)
2382.40	-46.35	2492.60	-47.65

**Result**

In any 100kHz bandwidth outside the frequency band, the radio frequency power is at least 20dB below that in the 100kHz bandwidth within the band that contains the highest level of the desired power.

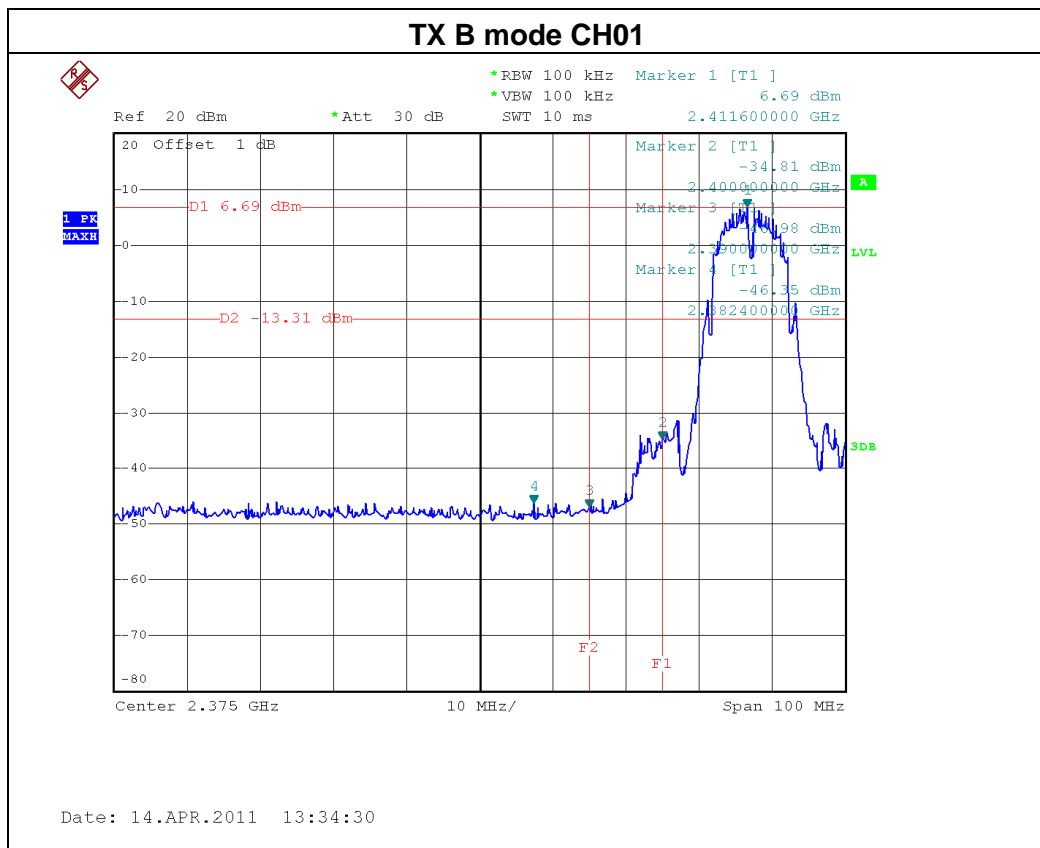

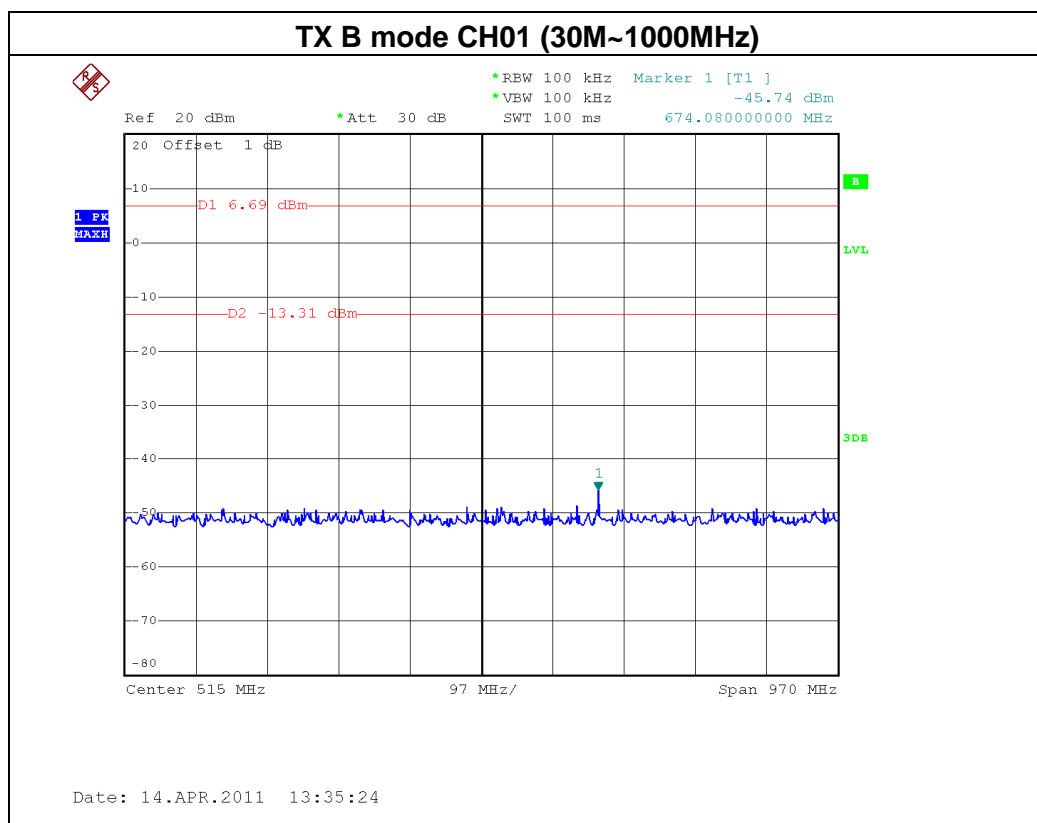
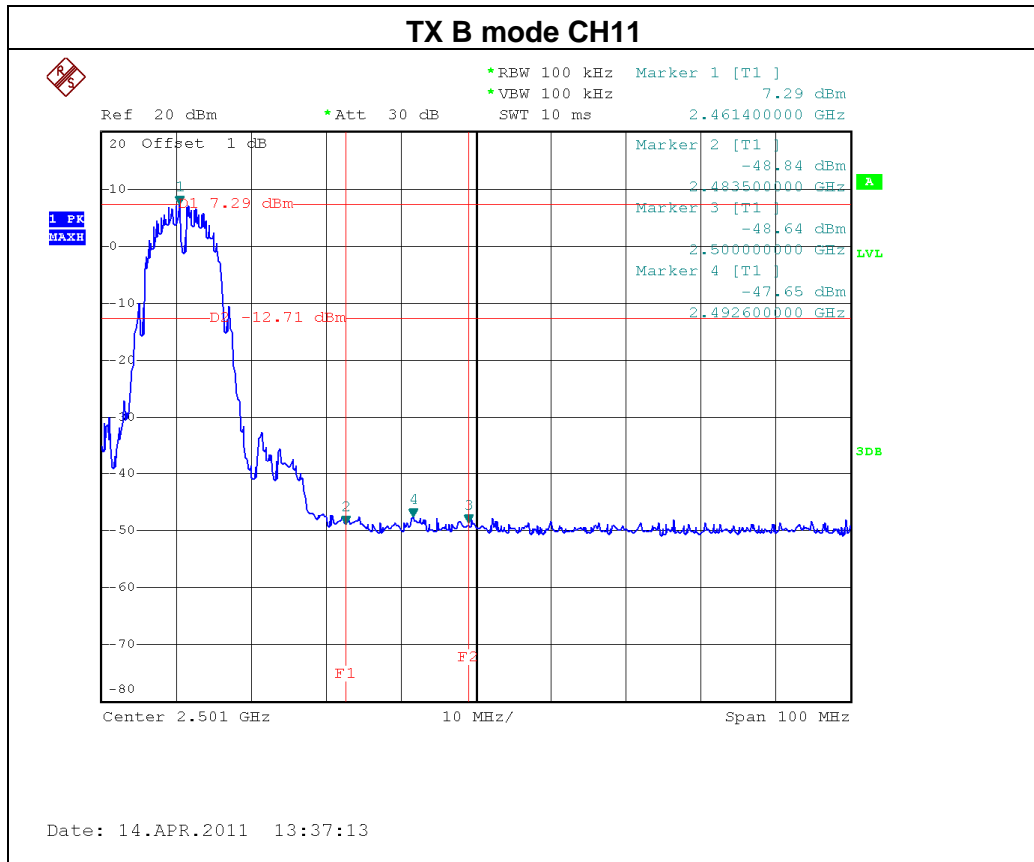

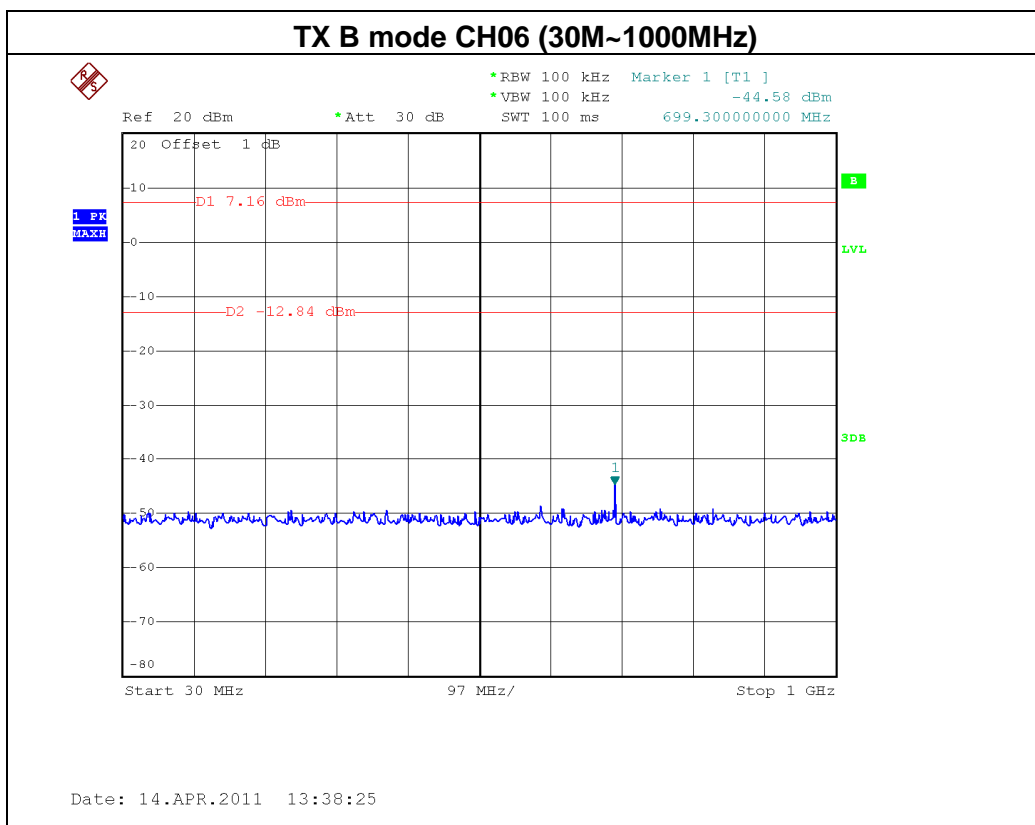
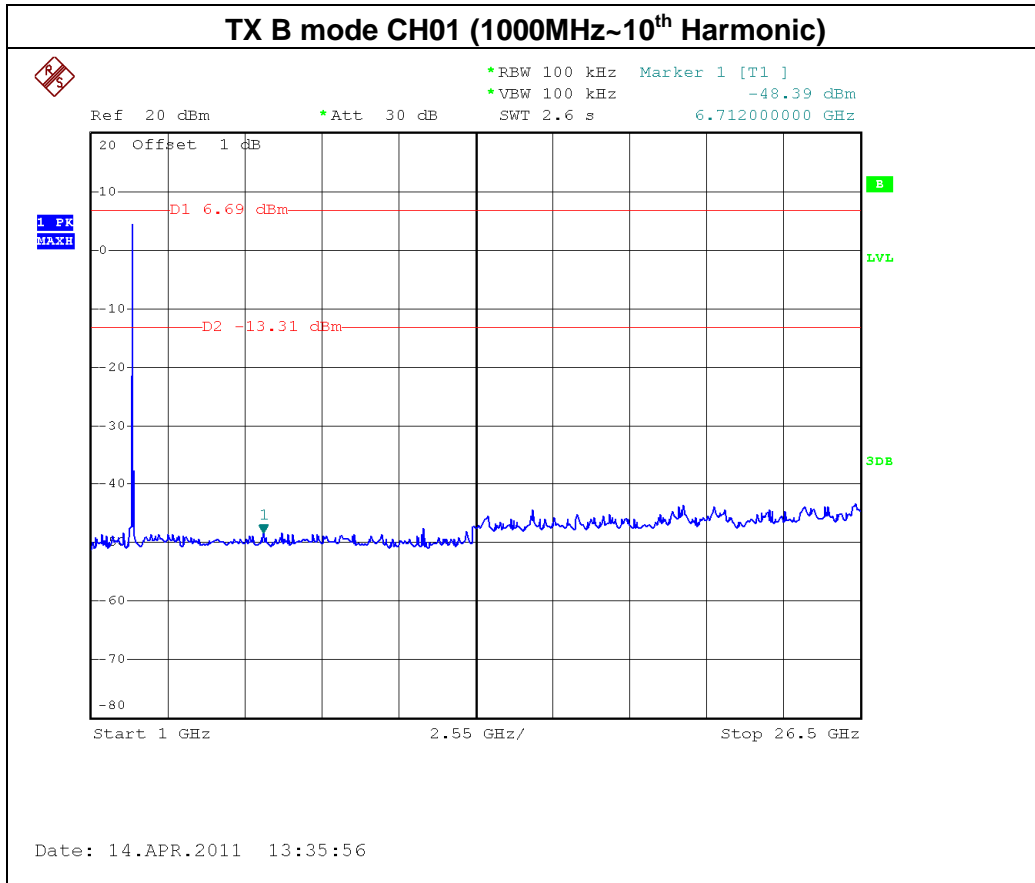

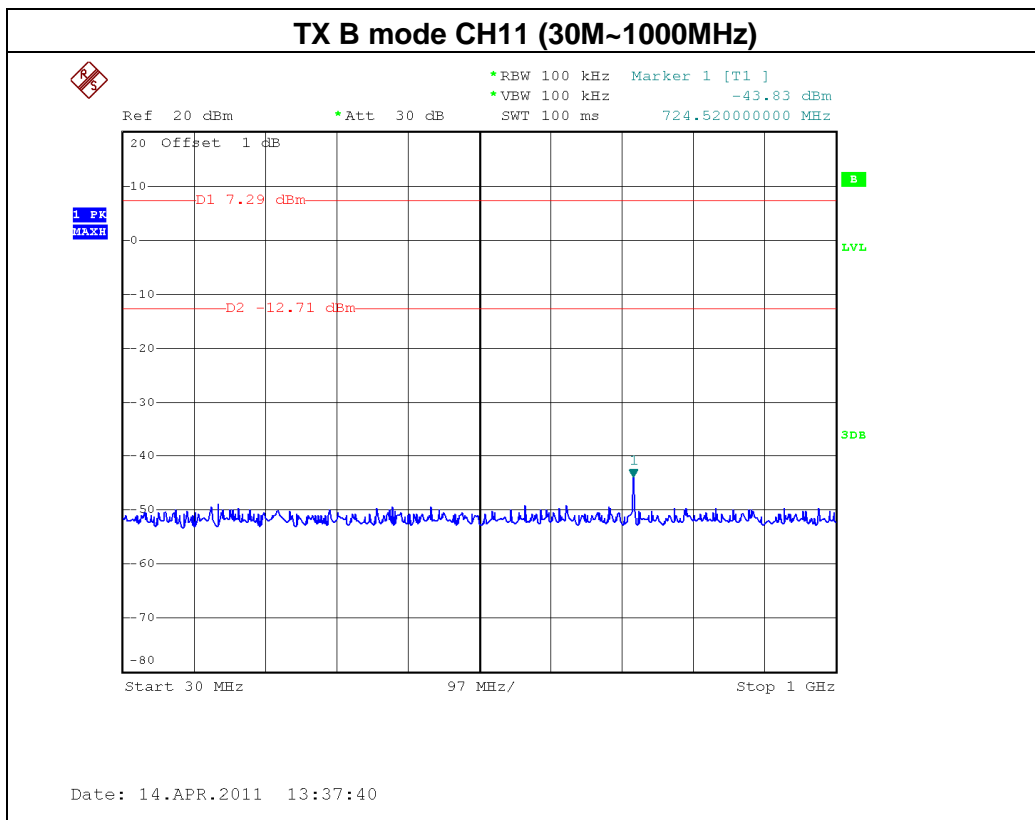
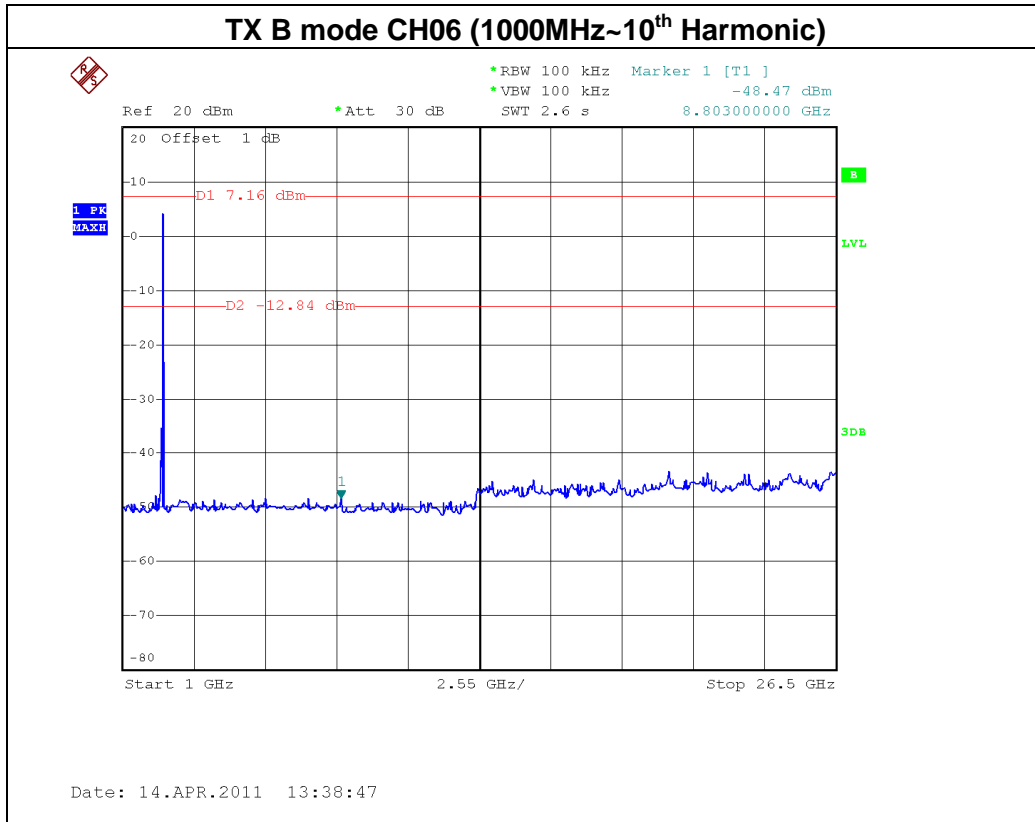

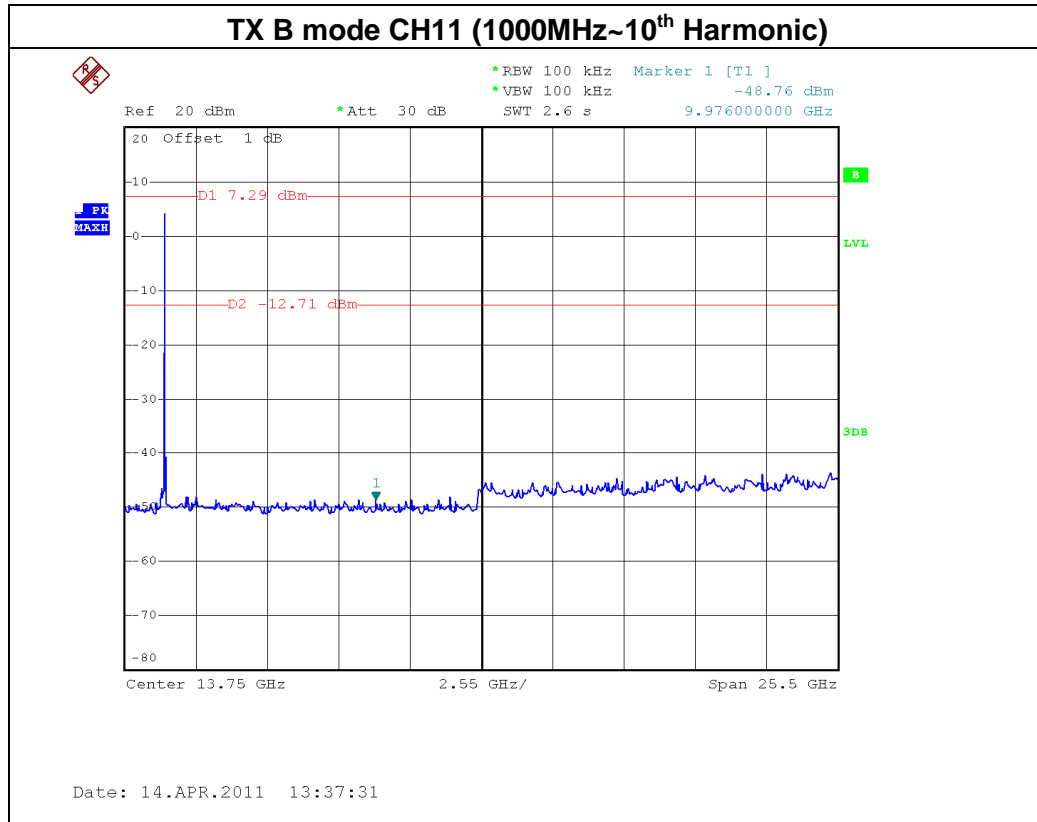

EUT:	BLU-RAY Disc Player	Model Name :	DX-WBRDVD1
Temperature:	24 °C	Relative Humidity:	60 %
Pressure:	1016 hPa	Test Voltage :	AC 120V/60Hz
Test Mode :	TX G MODE / CH01, CH06 , CH11		

Channel of Worst Data: CH01			
The max. radio frequency power in any 100kHz bandwidth outside the frequency band		The max. radio frequency power in any 100 kHz bandwidth within the frequency band.	
FREQUENCY(MHz)	POWER(dBm)	FREQUENCY(MHz)	POWER(dBm)
2390.00	-37.43	2487.20	-40.89
Result			
In any 100kHz bandwidth outside the frequency band, the radio frequency power is at least 20dB below that in the 100kHz bandwidth within the band that contains the highest level of the desired power.			

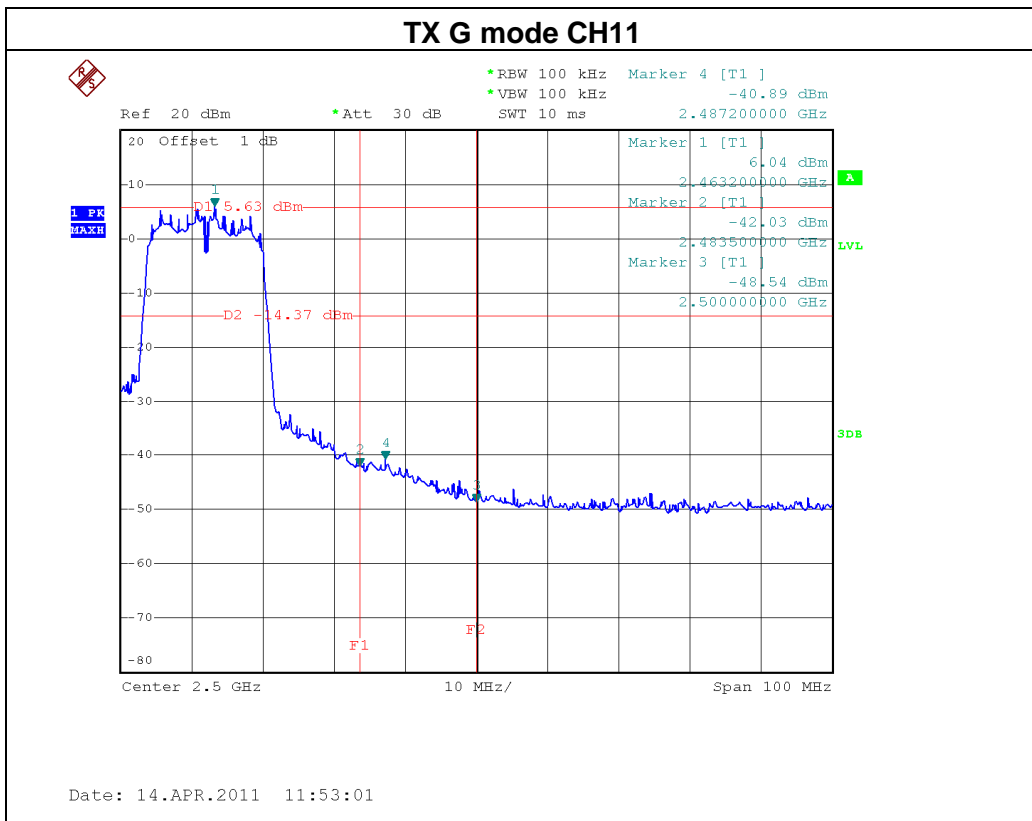
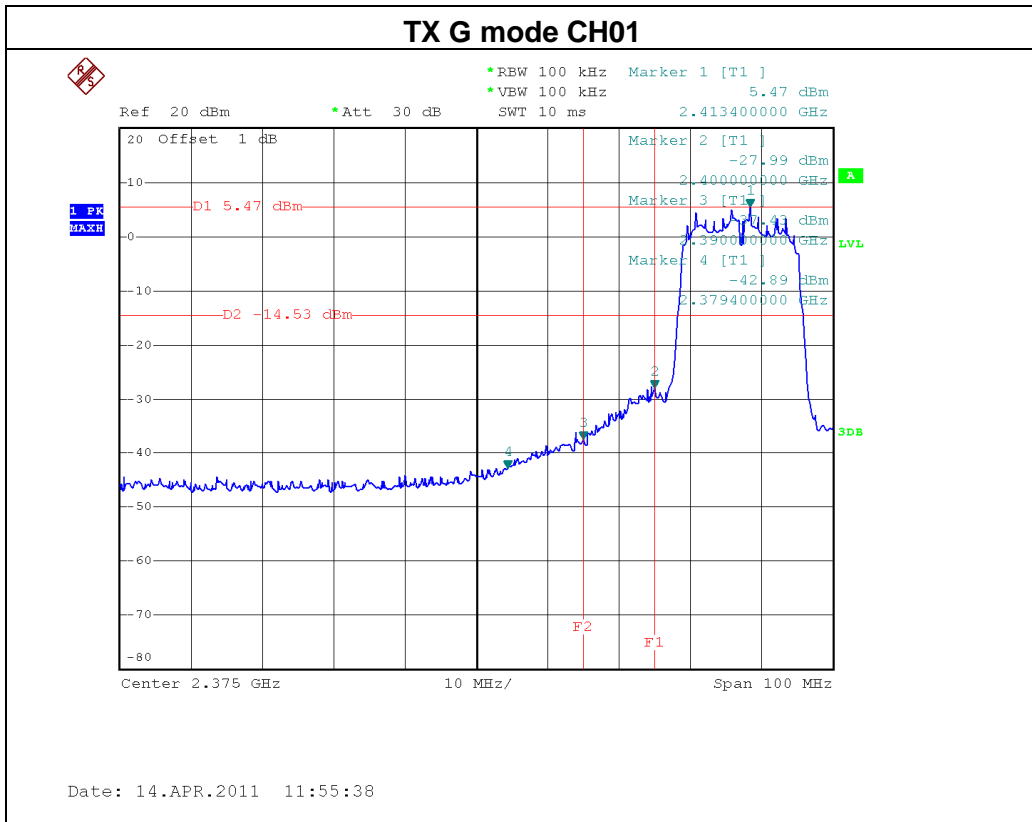

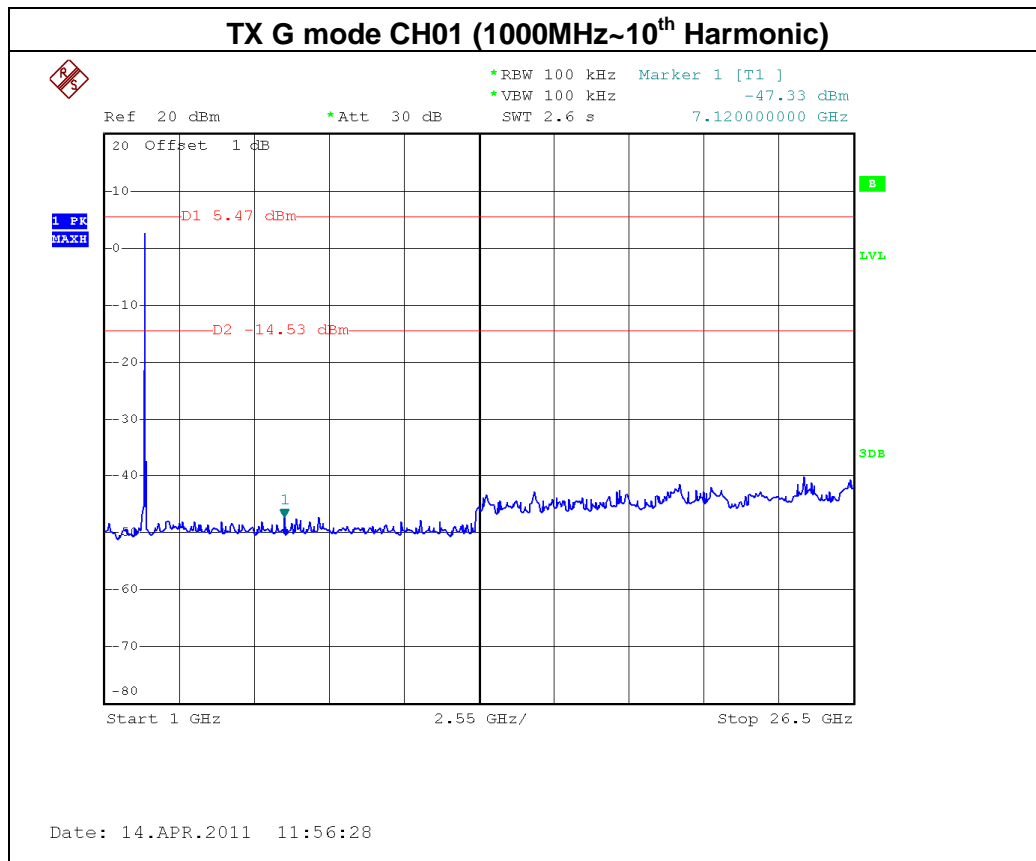
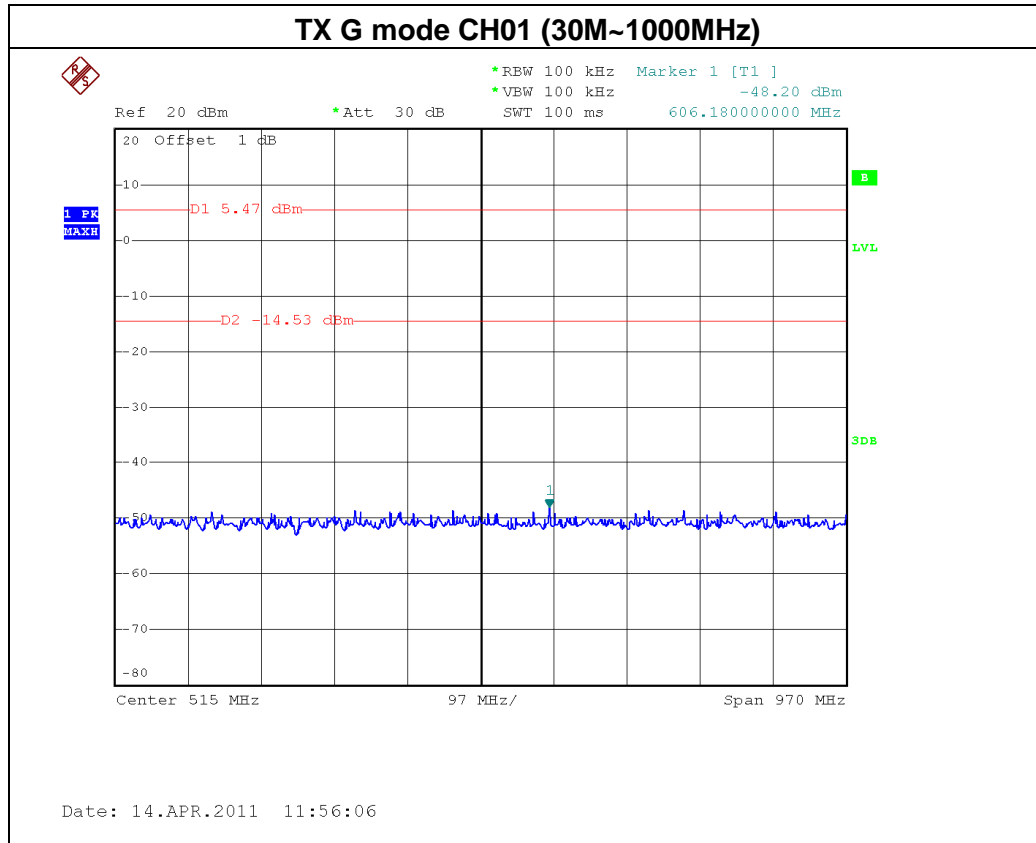



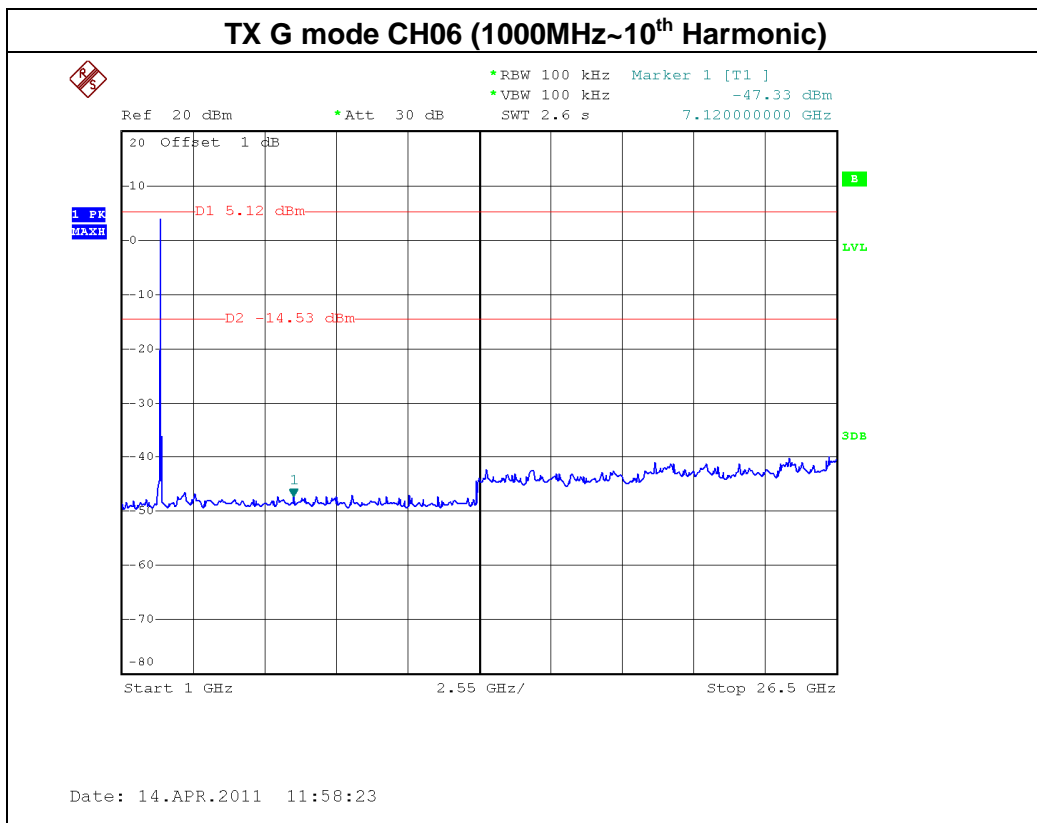
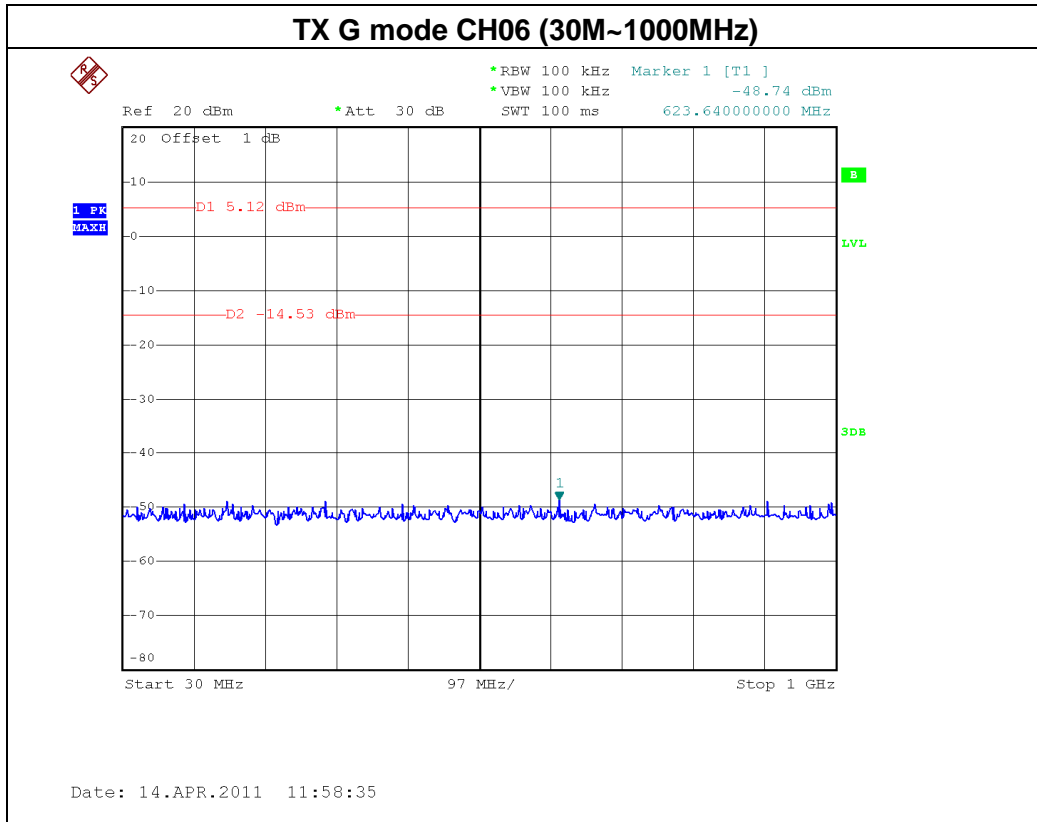

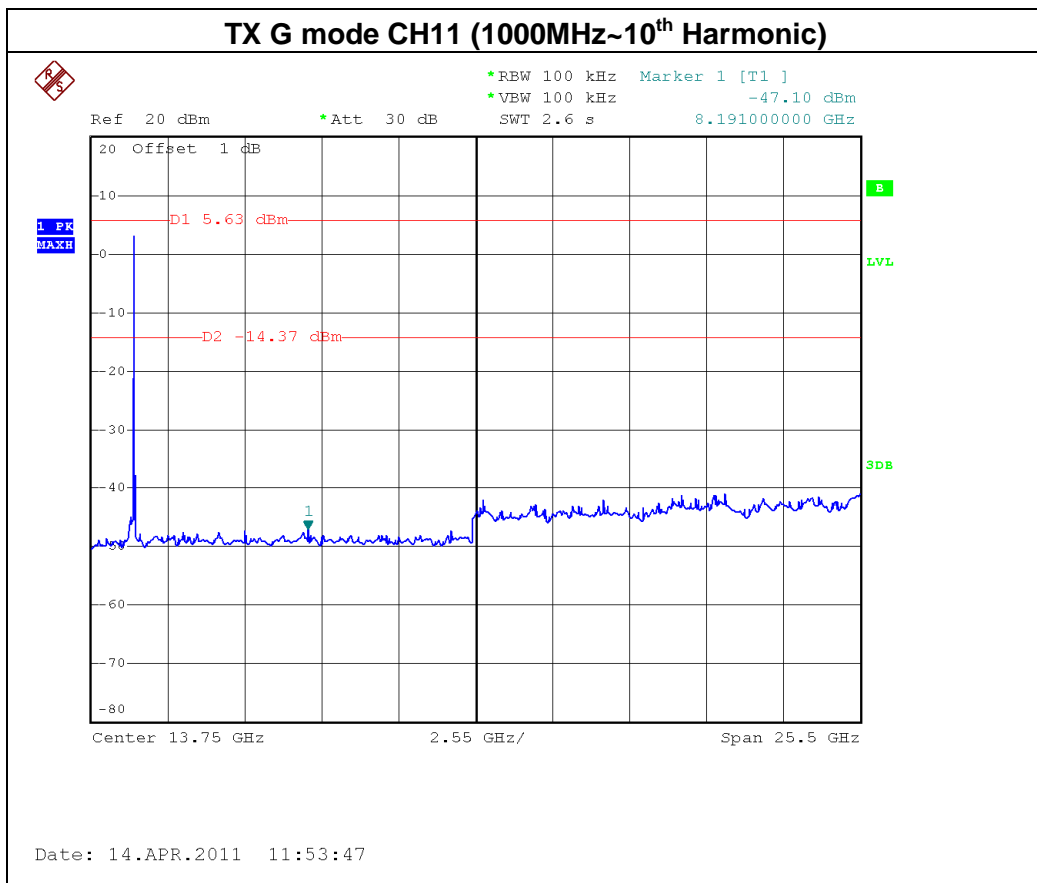
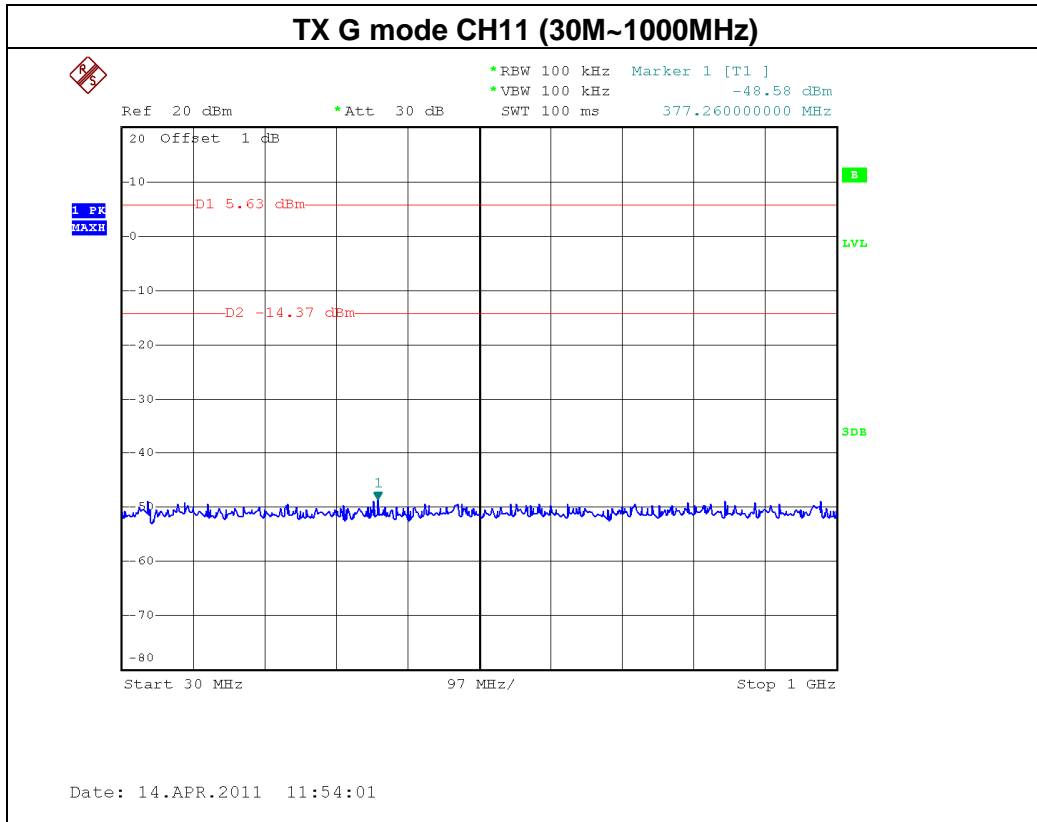

EUT:	BLU-RAY Disc Player	Model Name :	DX-WBRDVD1
Temperature:	24 °C	Relative Humidity :	60 %
Pressure:	1016 hPa	Test Voltage :	AC 120V/60Hz
Test Mode :	TX N-20M MODE / CH01, CH06 , CH11		

**Channel of Worst Data: CH01**

The max. radio frequency power in any 100kHz bandwidth outside the frequency band		The max. radio frequency power in any 100 kHz bandwidth within the frequency band.	
FREQUENCY(MHz)	POWER(dBm)	FREQUENCY(MHz)	POWER(dBm)
2390.00	-38.02	2487.00	-43.14

**Result**

In any 100kHz bandwidth outside the frequency band, the radio frequency power is at least 20dB below that in the 100kHz bandwidth within the band that contains the highest level of the desired power.

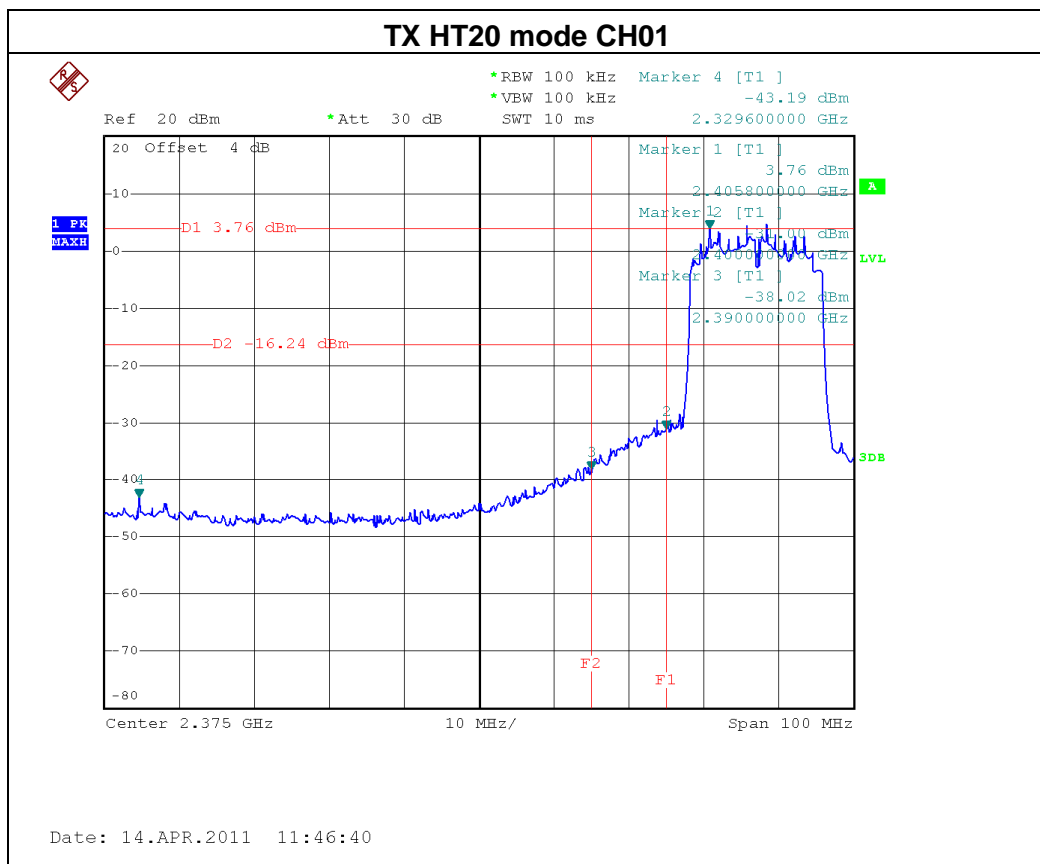

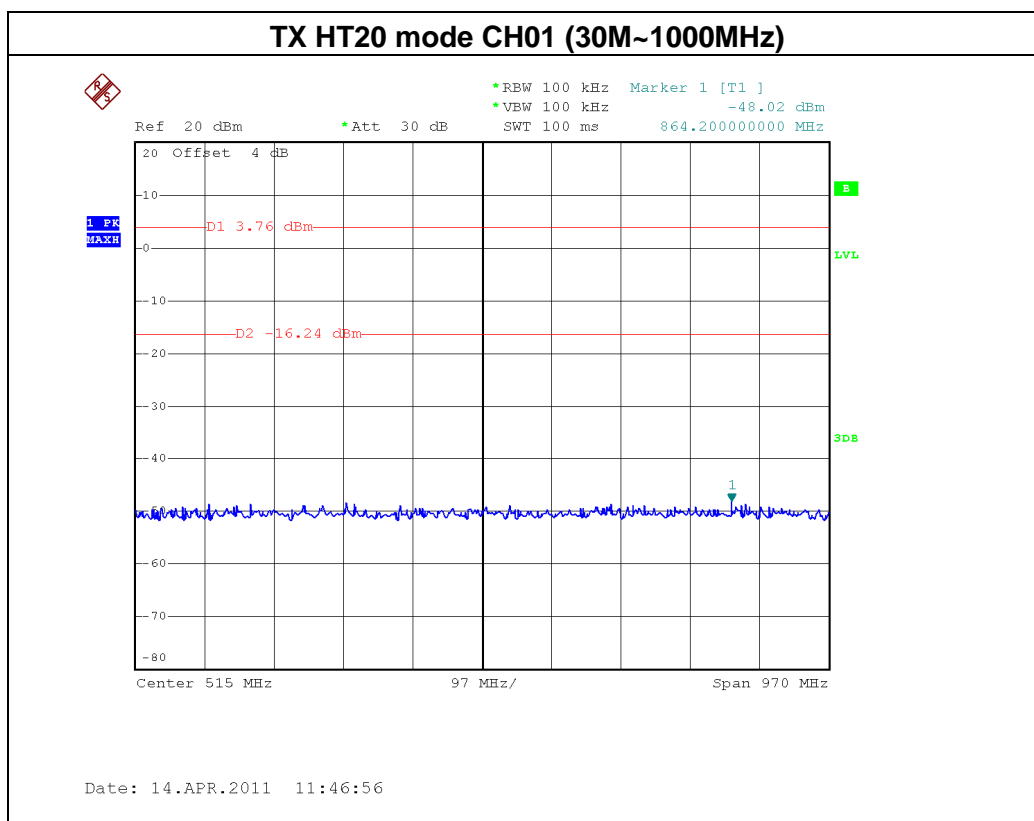
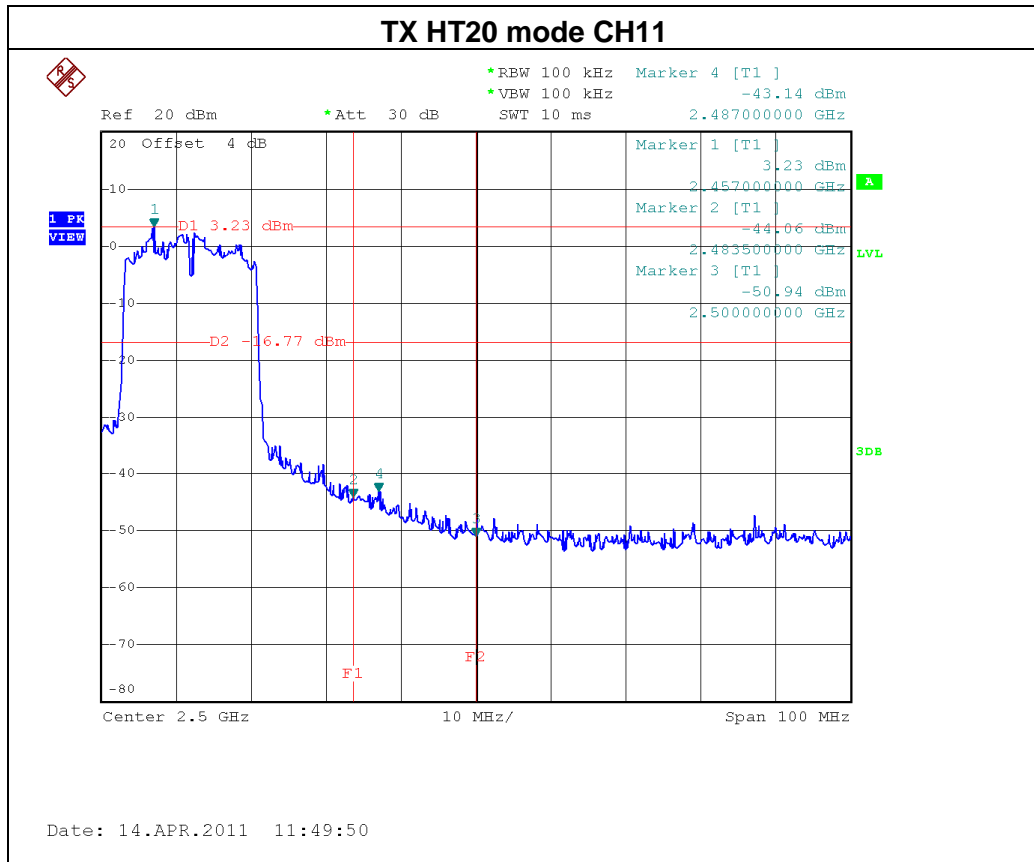

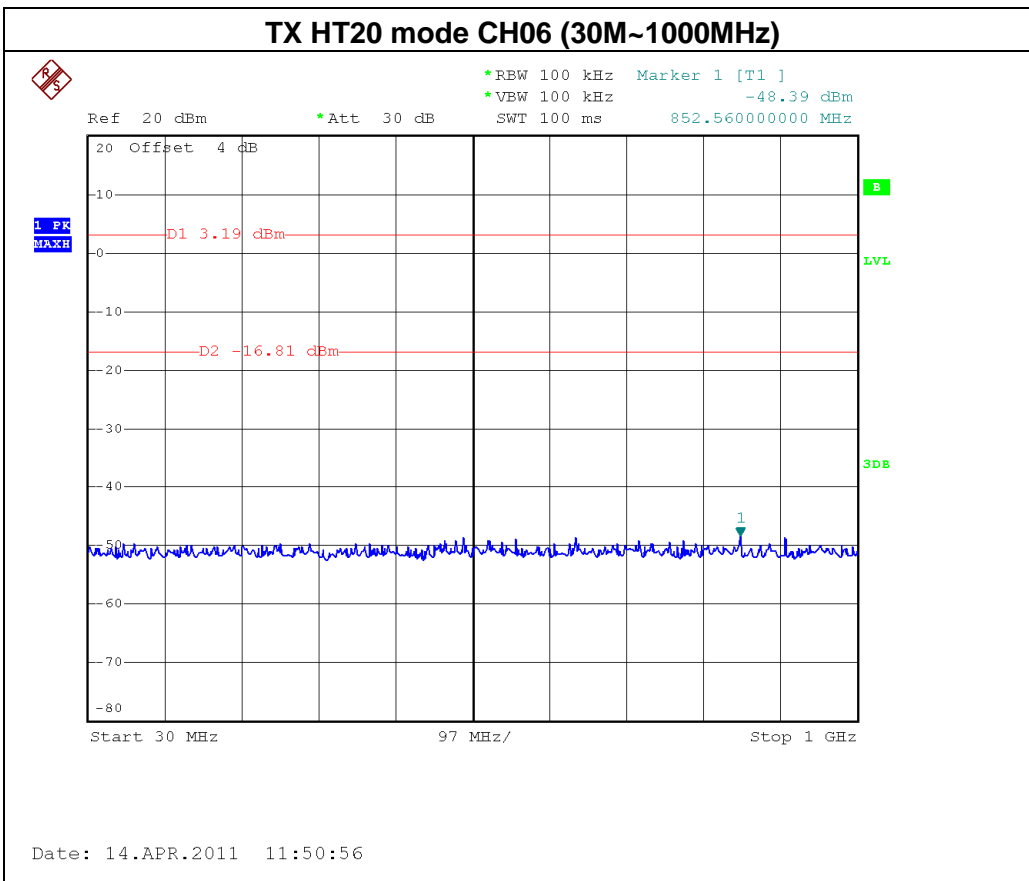
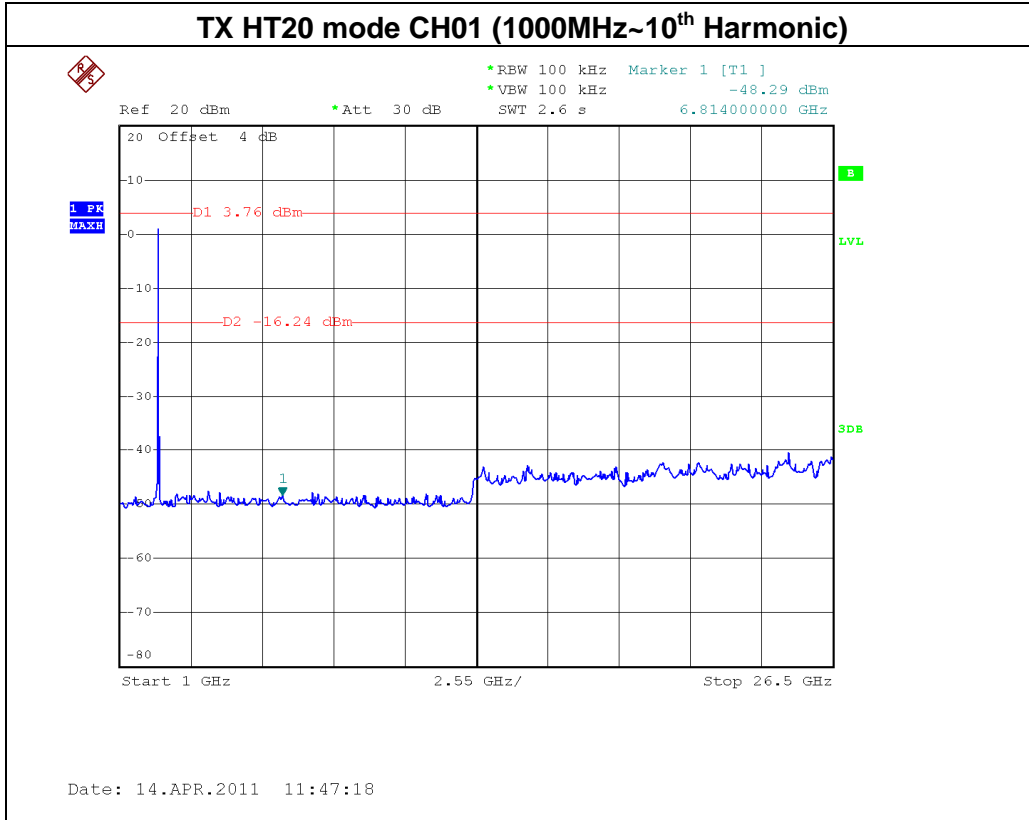

TX HT20 mode CH06 (1000MHz~10<sup>th</sup> Harmonic)

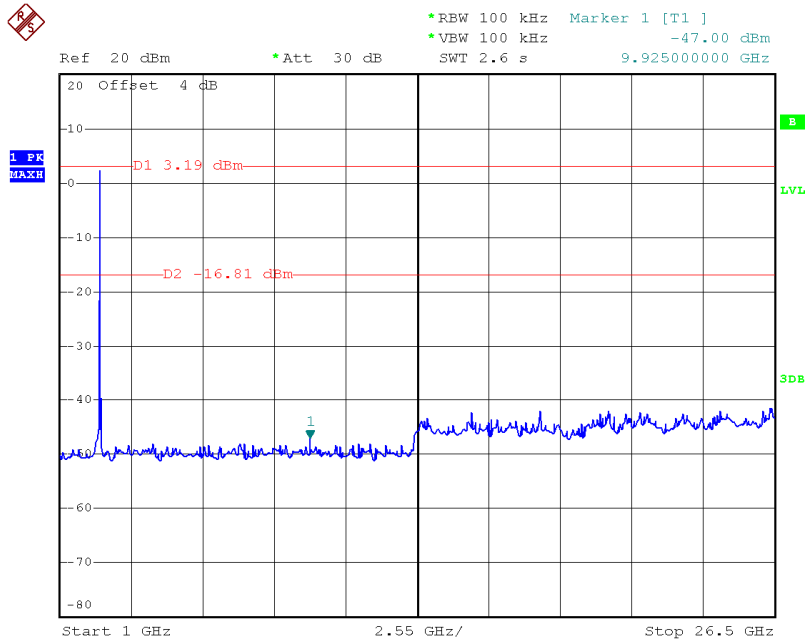

Date: 14.APR.2011 11:51:10

TX HT20 mode CH11 (30M~1000MHz)

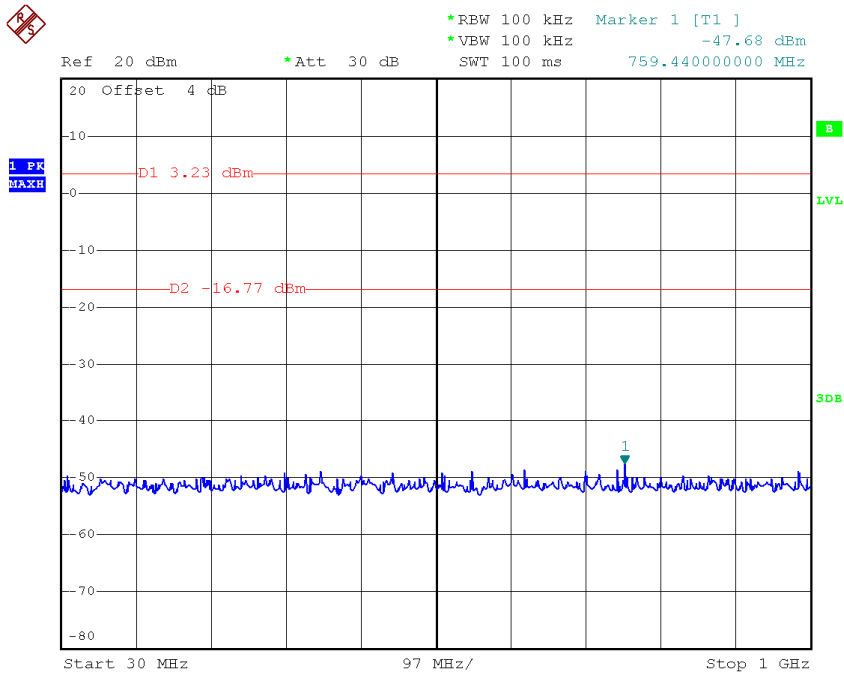

Date: 14.APR.2011 11:50:33

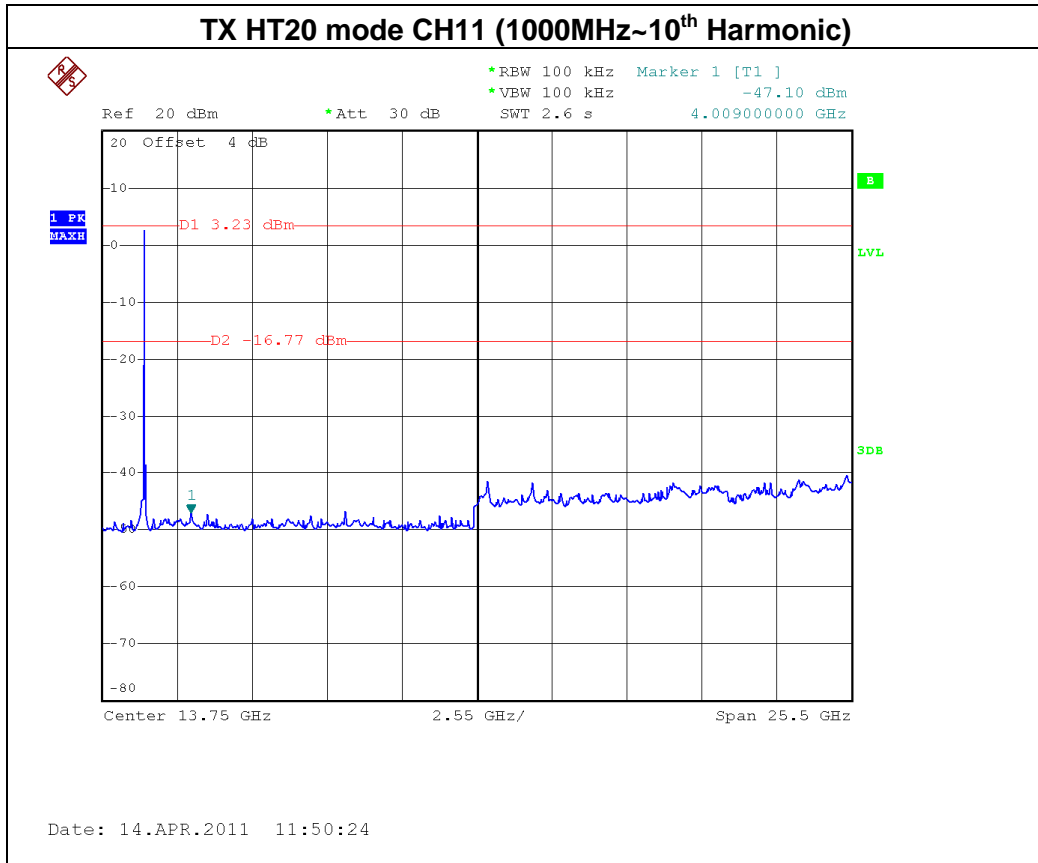

EUT:	BLU-RAY Disc Player	Model Name :	DX-WBRDVD1
Temperature:	24 °C	Relative Humidity :	60 %
Pressure:	1016 hPa	Test Voltage :	AC 120V/60Hz
Test Mode :	TX N-40M MODE /CH03, CH06, CH09		

**Channel of Worst Data: CH03**

The max. radio frequency power in any 100kHz bandwidth outside the frequency band		The max. radio frequency power in any 100 kHz bandwidth within the frequency band.	
FREQUENCY(MHz)	POWER(dBm)	FREQUENCY(MHz)	POWER(dBm)
2384.60	-35.81	2484.60	-42.77

**Result**

In any 100kHz bandwidth outside the frequency band, the radio frequency power is at least 20dB below that in the 100kHz bandwidth within the band that contains the highest level of the desired power.

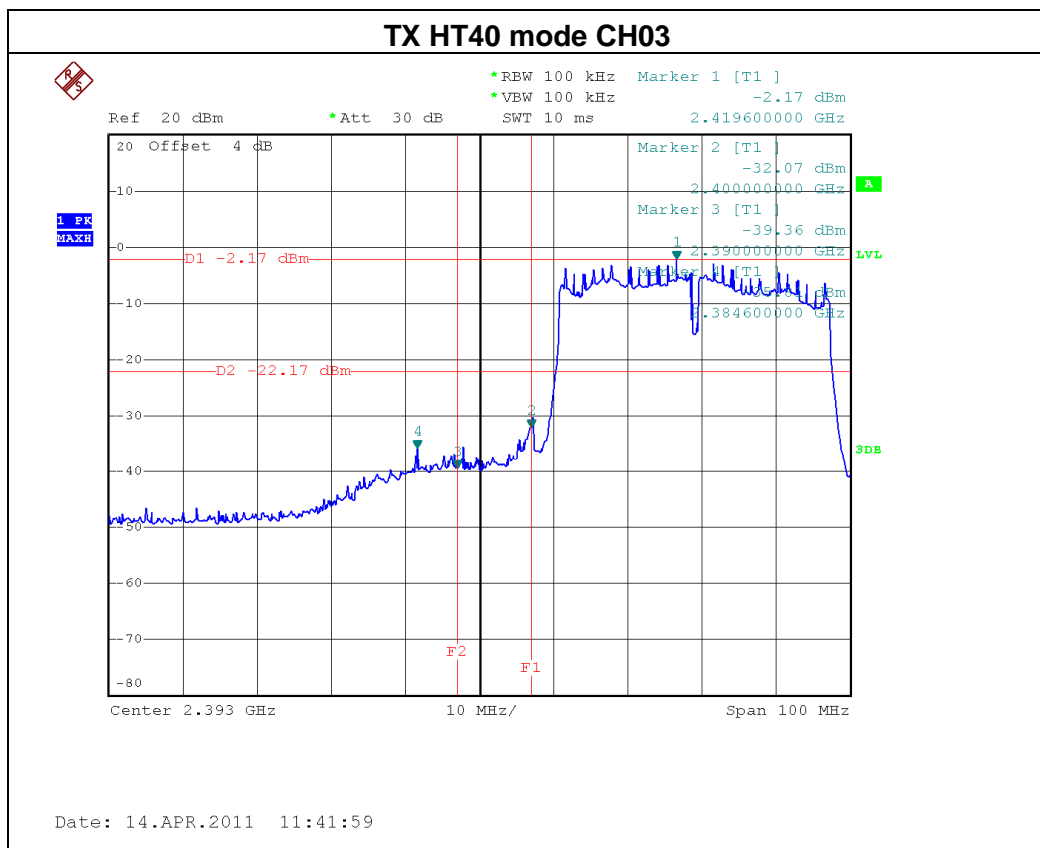









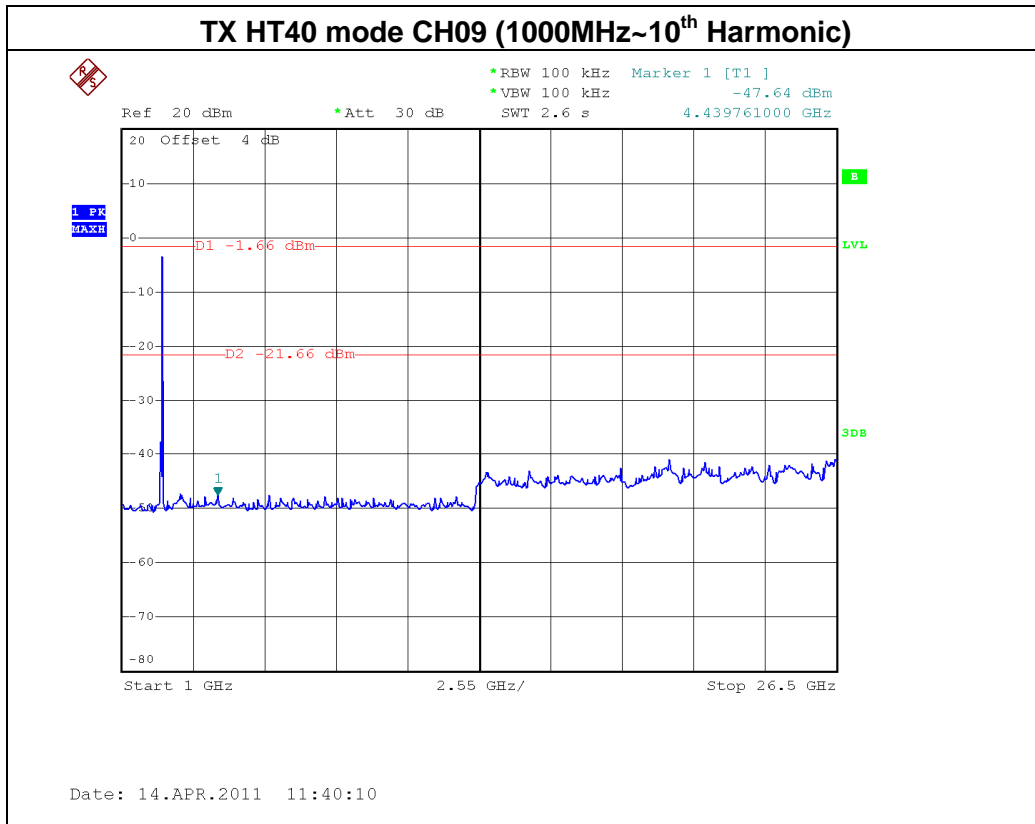

## 7. POWER SPECTRAL DENSITY TEST

### 7.1. APPLIED PROCEDURES / LIMIT

FCC Part15 (15.247) , Subpart C/ RSS-210				
Section	Test Item	Limit	Frequency Range (MHz)	Result
15.247(e)	Power Spectral Density	8 dBm (in any 3KHz)	2400-2483.5	PASS

#### 7.1.1. MEASUREMENT INSTRUMENTS LIST

Item	Kind of Equipment	Manufacturer	Type No.	Serial No.	Calibrated until
1	Spectrum Analyzer	R&S	FSP_40	100129	Jan. 04, 2012

Remark: " N/A" denotes No Model Name. , Serial No. or No Calibration specified.

#### 7.1.2. TEST PROCEDURE

- a. The EUT was directly connected to the spectrum analyzer and antenna output port as show in the block diagram below,
- b. Spectrum Setting : RBW=3KHz, VBW=30 KHz, Sweep time = 500s.

#### 7.1.3. DEVIATION FROM STANDARD

No deviation.

#### 7.1.4. TEST SETUP

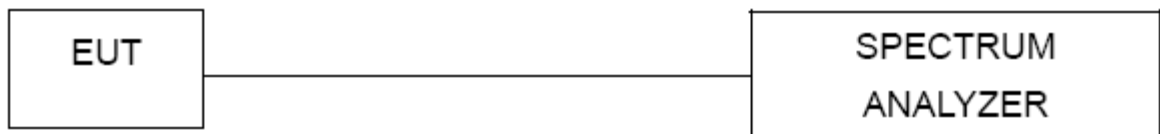

#### 7.1.5. EUT OPERATION CONDITIONS

The EUT tested system was configured as the statements of 7.1.6 Unless otherwise a special operating condition is specified in the follows during the testing.

### 7.1.6. TEST RESULTS

EUT:	BLU-RAY Disc Player	Model Name :	DX-WBRDVD1
Temperature:	24 °C	Relative Humidity:	60 %
Pressure:	1016 hPa	Test Voltage :	AC 120V/60Hz
Test Mode :	TX B MODE /CH01, CH06, CH11		

Test Channel	Frequency (MHz)	Power Density (dBm)	LIMIT (dBm)
CH01	2412 MHz	-4.51	8
CH06	2437 MHz	-5.63	8
CH11	2462 MHz	-5.54	8

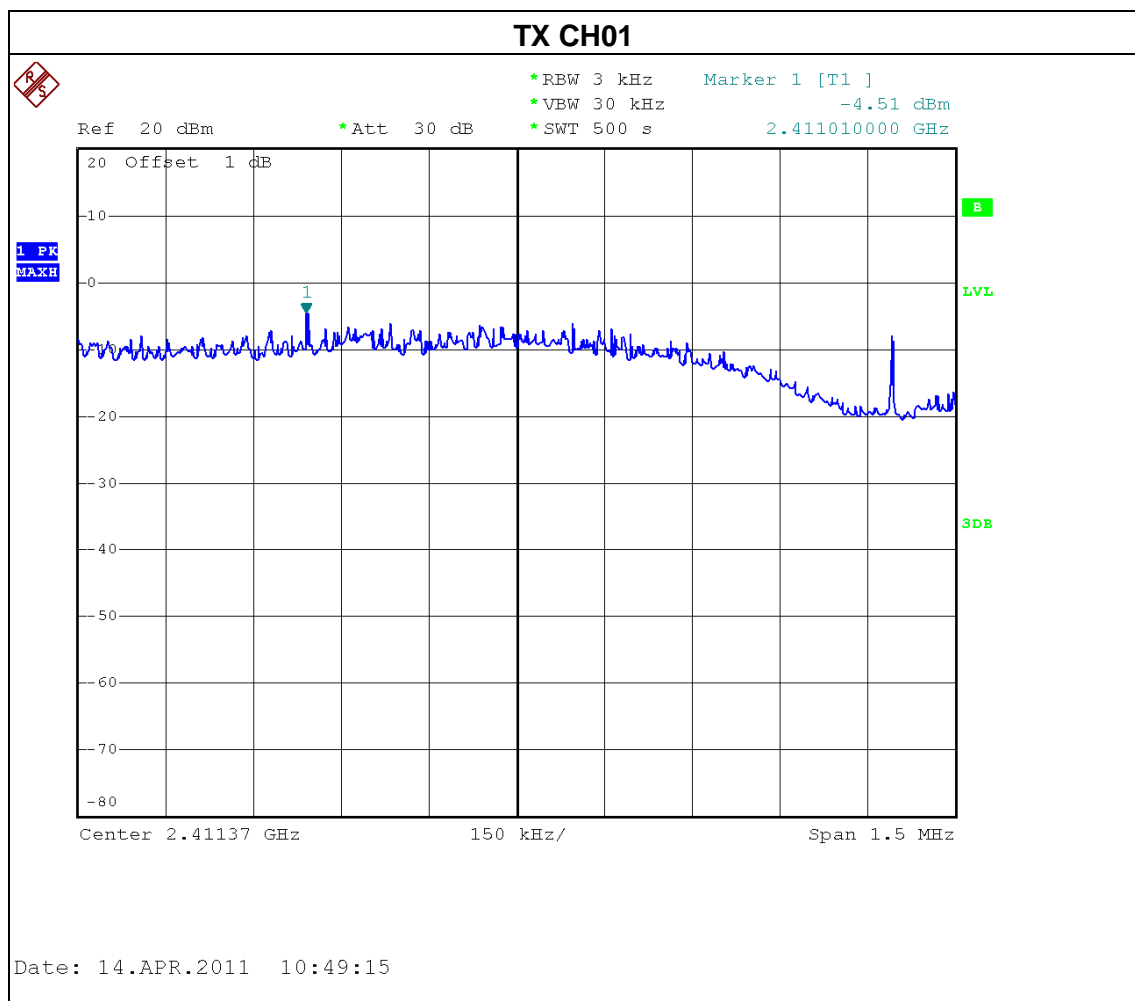

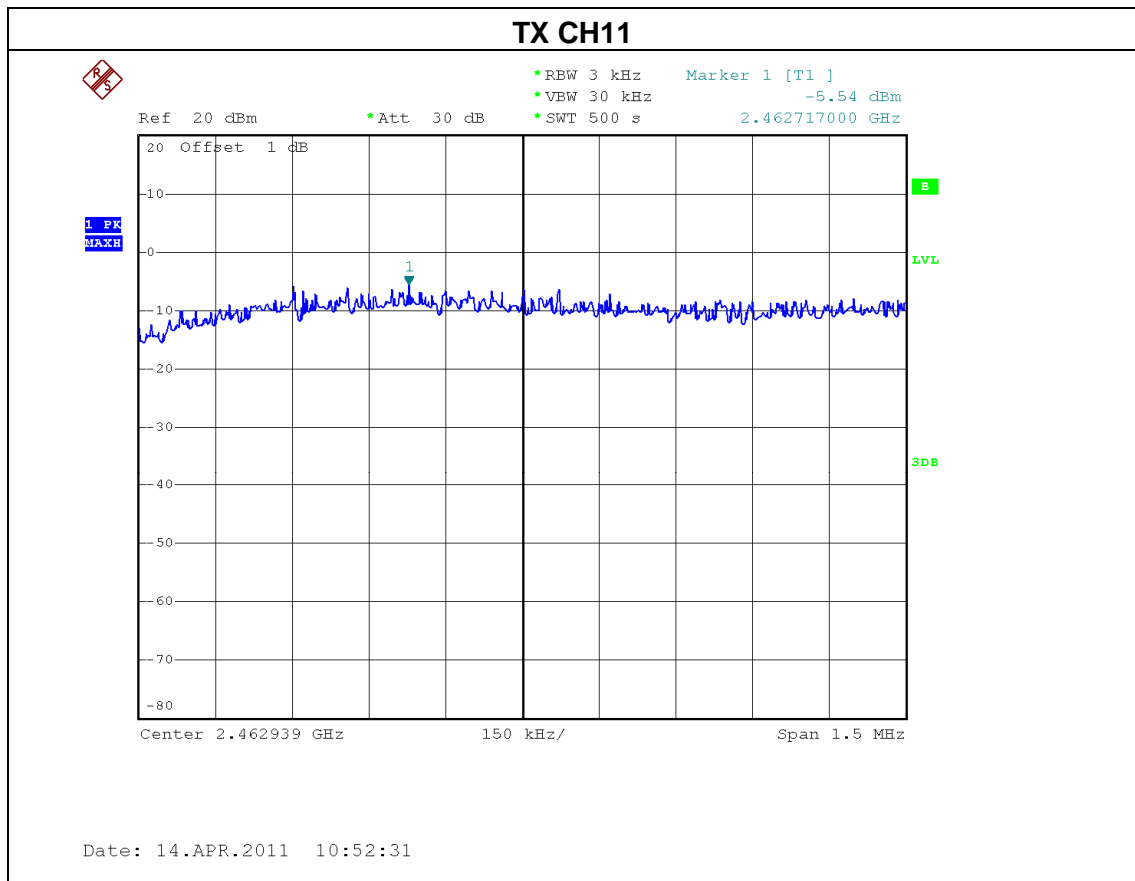
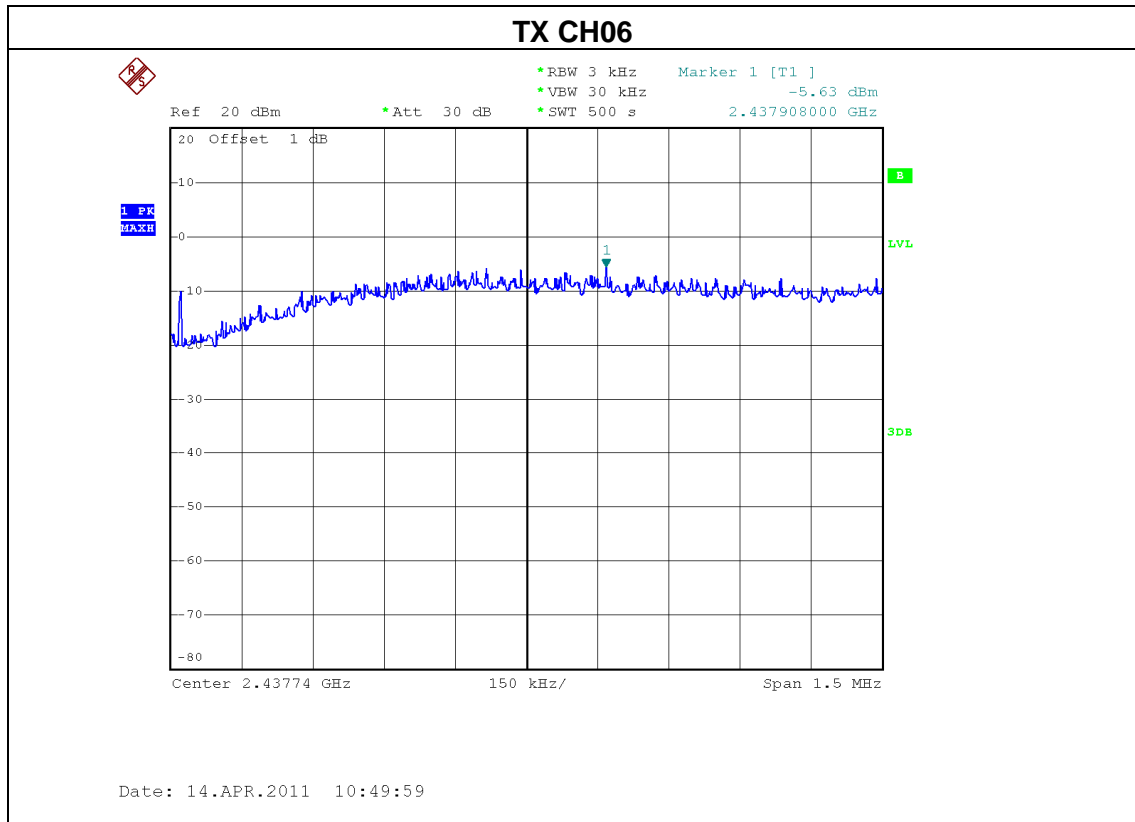



EUT:	BLU-RAY Disc Player	Model Name :	DX-WBRDVD1
Temperature:	24 °C	Relative Humidity:	60 %
Pressure:	1016 hPa	Test Voltage :	AC 120V/60Hz
Test Mode :	TX G MODE /CH01, CH06, CH11		

Test Channel	Frequency (MHz)	Power Density (dBm)	LIMIT (dBm)
CH01	2412 MHz	-11.48	8
CH06	2437 MHz	-10.83	8
CH11	2462 MHz	-10.77	8

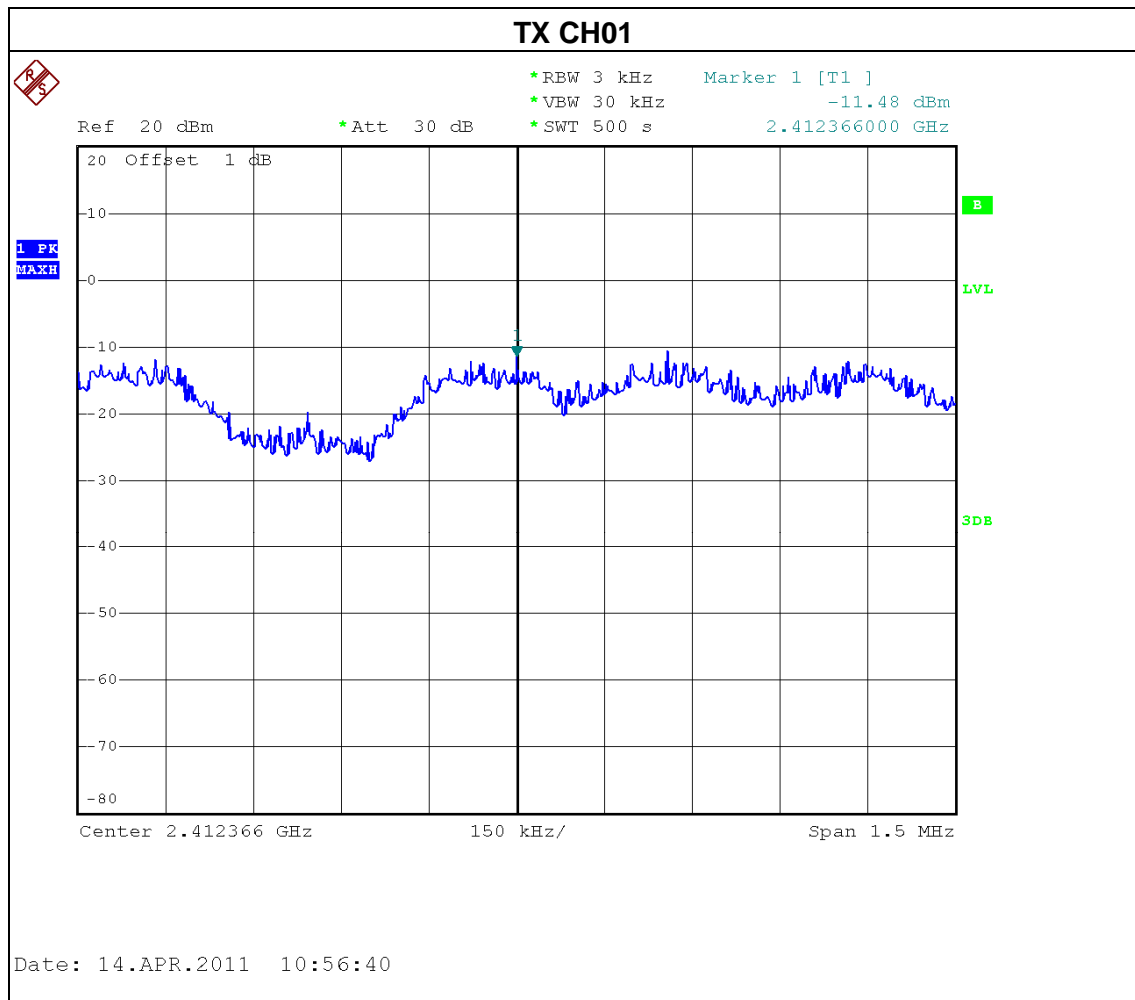



EUT:	BLU-RAY Disc Player	Model Name :	DX-WBRDVD1
Temperature:	24 °C	Relative Humidity:	60 %
Pressure:	1016 hPa	Test Voltage :	AC 120V/60Hz
Test Mode :	TX N MODE-20MHz /CH01, CH06, CH11		

Test Channel	Frequency (MHz)	Power Density (dBm)	LIMIT (dBm)
CH01	2412 MHz	-8.55	8
CH06	2437 MHz	-9.10	8
CH11	2462 MHz	-8.85	8

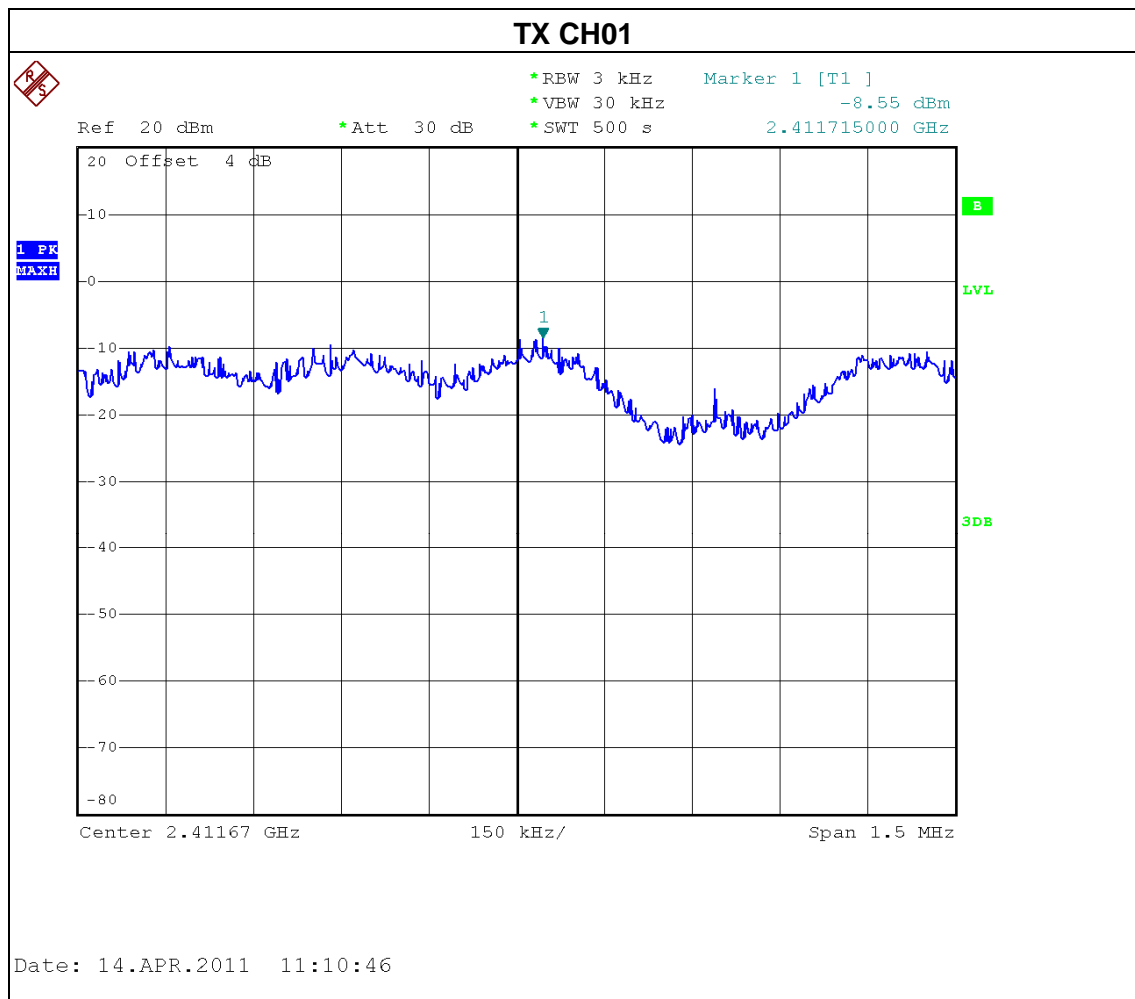

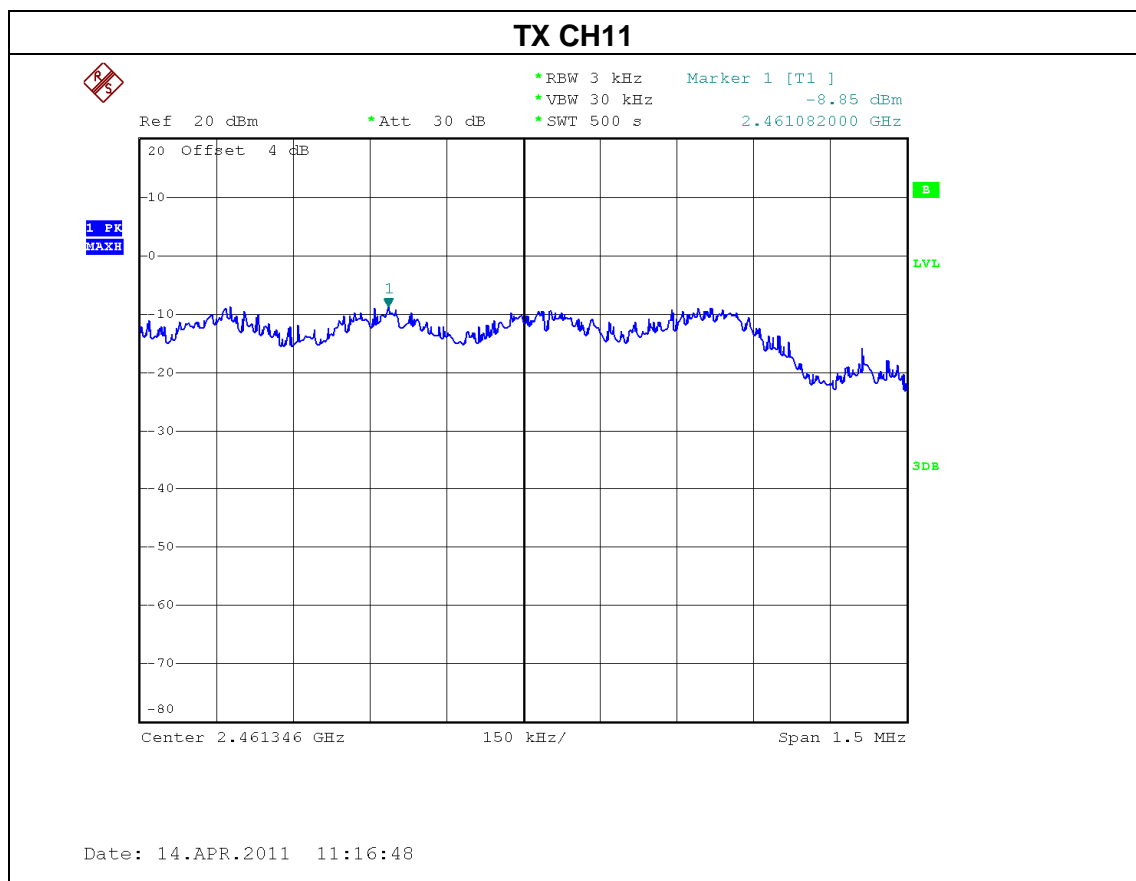
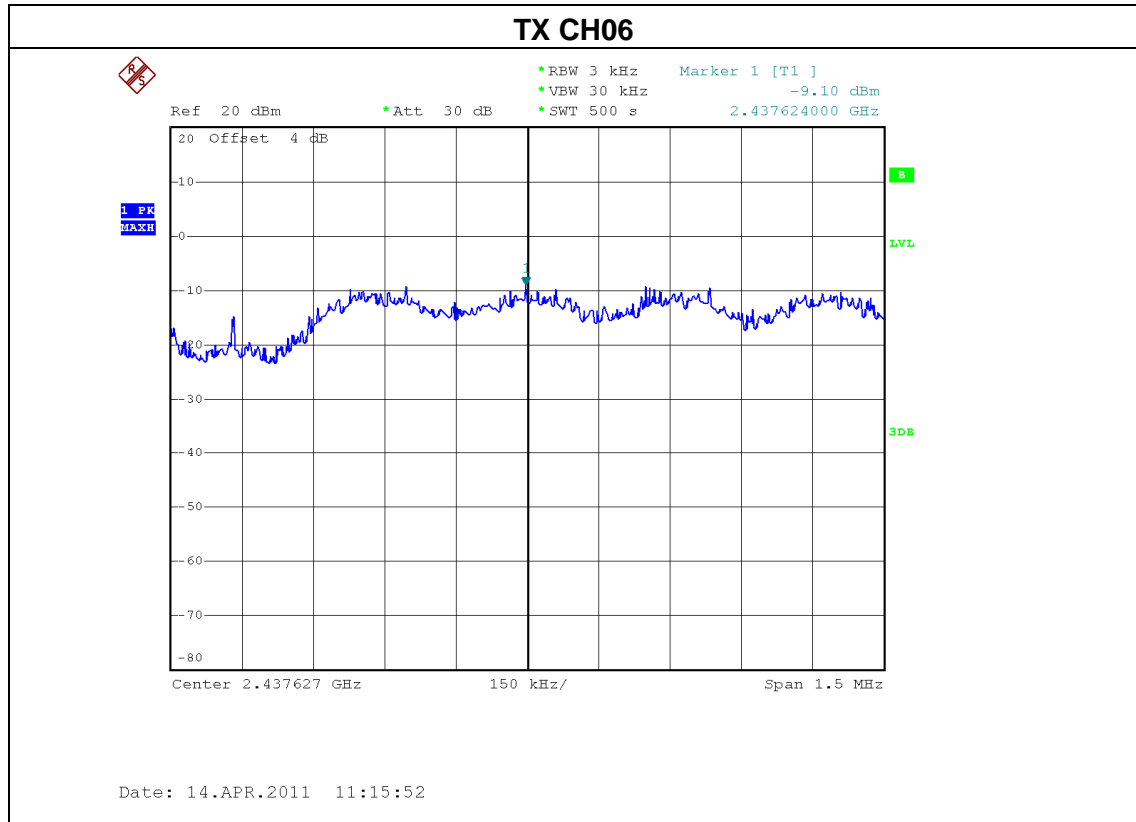

EUT:	BLU-RAY Disc Player	Model Name :	DX-WBRDVD1
Temperature:	24 °C	Relative Humidity :	60 %
Pressure:	1016 hPa	Test Voltage :	AC 120V/60Hz
Test Mode :	TX N MODE-40MHz /CH03, CH06, CH09		

Test Channel	Frequency (MHz)	Power Density (dBm)	LIMIT (dBm)
CH03	2422 MHz	-17.06	8
CH06	2437 MHz	-18.25	8
CH09	2452 MHz	-14.20	8

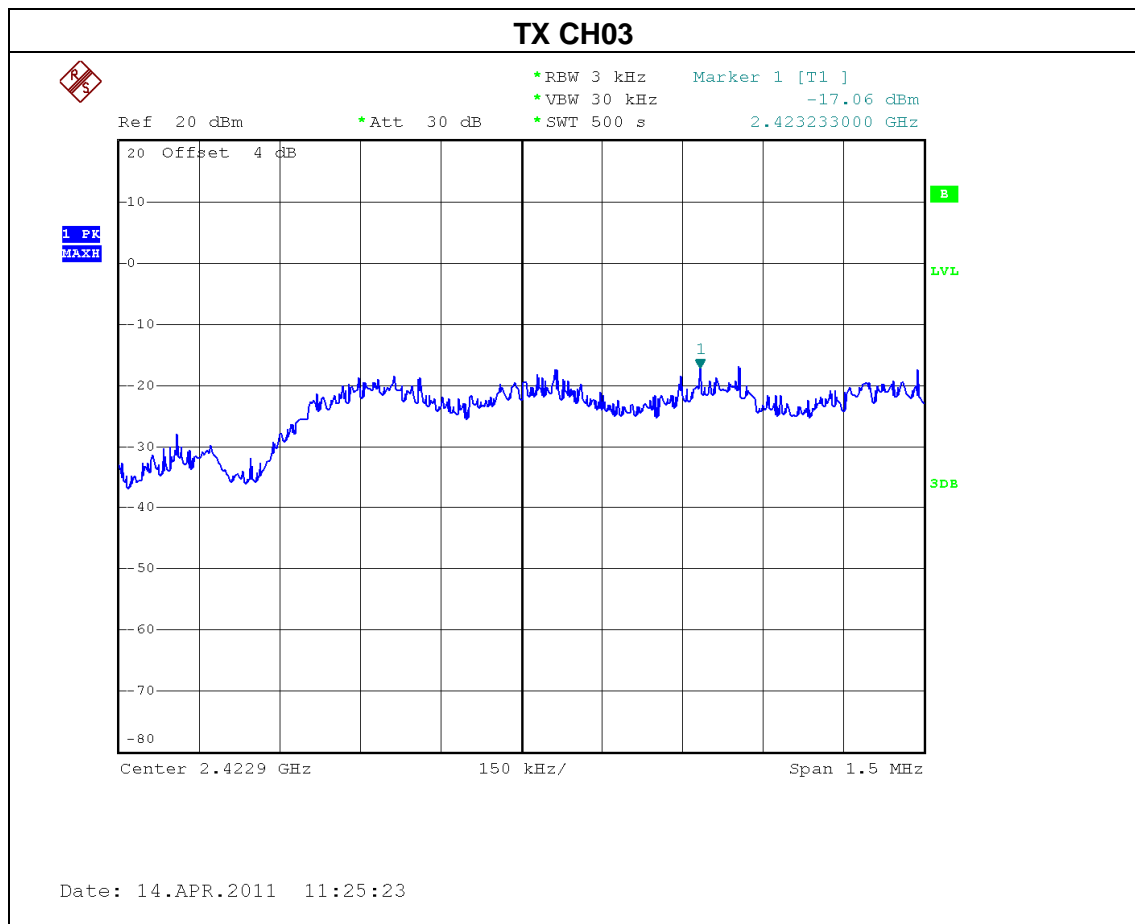



## 8. EUT TEST PHOTO

### Conducted Measurement Photos



Radiated Measurement Photos

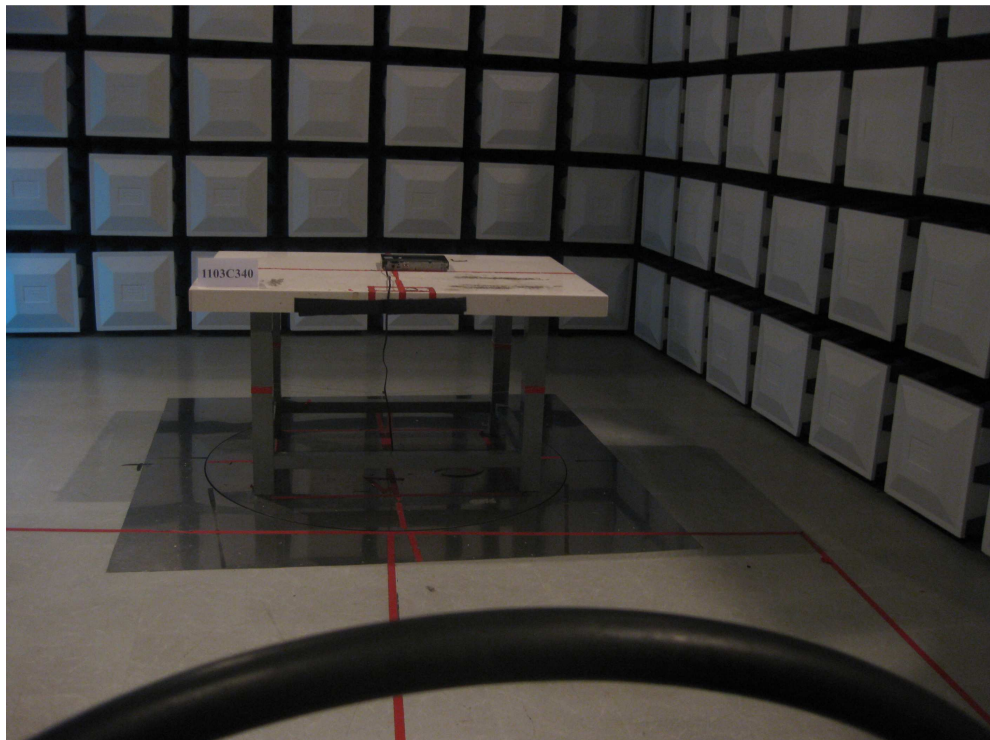
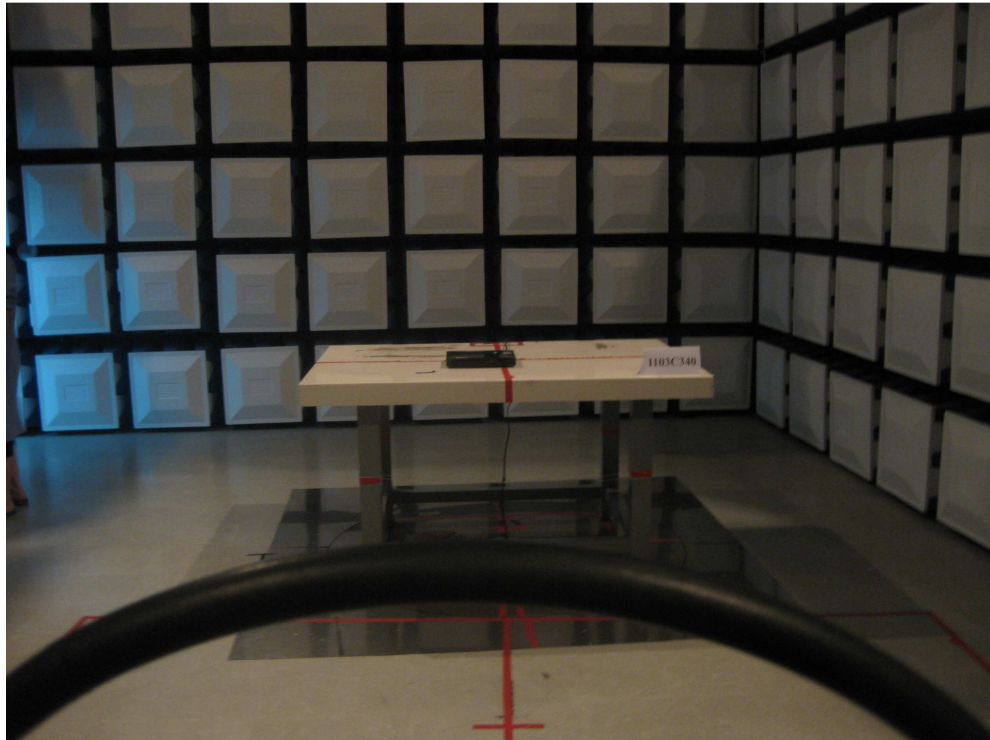



**Radiated Measurement Photos**

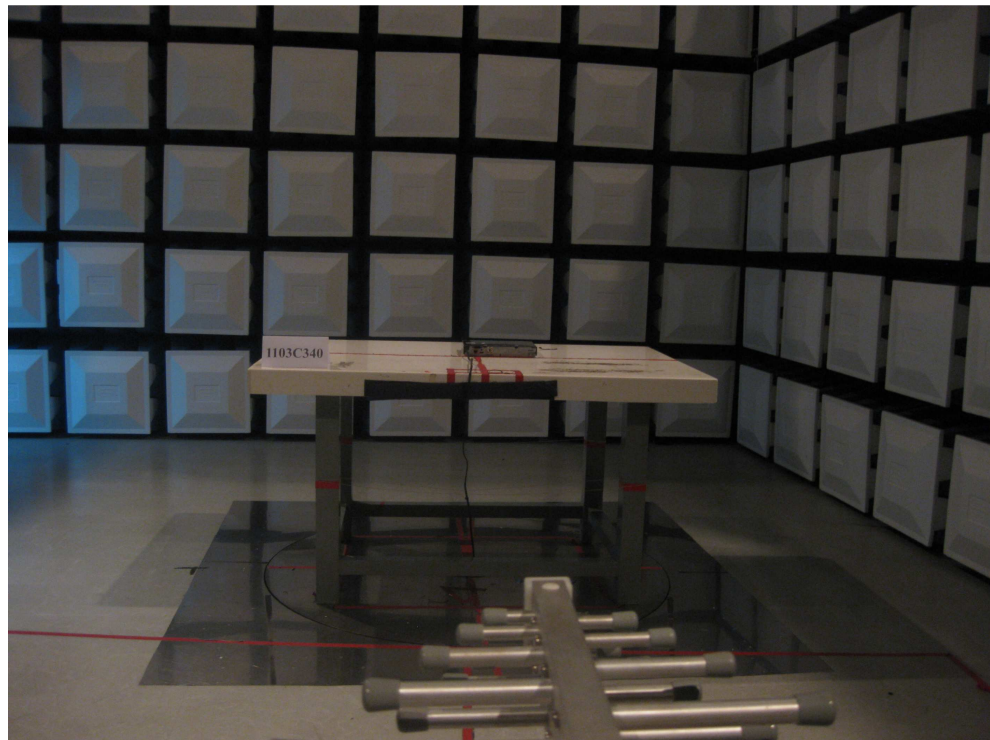

**Radiated Measurement Photos**

