



FCC 47 CFR PART 15 SUBPART C

TEST REPORT

For

4CH 2.4GHz FHSS RADIO SYSTEM

MODEL: KT-24

Brand : KYOSHO

Test Report Number:

SZ110304B03-RP

Prepared for

SHANGHAI MERIT TECHNOLOGY CORP.

**1058 TAOGAN RD., SHESHAN TOWN SONGJIANG DISTRICT,
SHANGHAI, CHINA**

Prepared by

Compliance Certification Services (Shenzhen) Inc.

**No.10-1,Mingkeda Logistics Park, NO.18, Huanguan south Rd.,
Guan lan Town, Baoan District, Shenzhen China**

TEL: 86-755-28055000

FAX: 86-755-28055221

Issued Date: March 24, 2011



Note: *This report shall not be reproduced except in full, without the written approval of Compliance Certification Services Inc. This document may be altered or revised by Compliance Certification Services Inc. personnel only, and shall be noted in the revision section of the document. The client should not use it to claim product endorsement by TAF, A2LA, NVLAP, NIST or any government agencies. The test result of this report relate only to the tested sample identified in this report.*



Revision History

Rev.	Issue No.	Revisions	Effect Page	Revised By
00	SZ110304B03-RP	Initial Issue	ALL	Vincent Yao



TABLE OF CONTENTS

1. TEST RESULT CERTIFICATION 4
2. EUT DESCRIPTION 5
3. TEST METHODOLOGY 6
3.1 DESCRIPTION OF TEST MODES 6
4. FACILITIES AND ACCREDITATIONS 7
4.1 FACILITIES 7
4.2 ACCREDITATIONS 7
4.3 MEASUREMENT UNCERTAINTY 7
5. SETUP OF EQUIPMENT UNDER TEST 8
5.1 SETUP CONFIGURATION OF EUT 8
5.2 SUPPORT EQUIPMENT 8
6. FCC PART 15.247 REQUIREMENTS 9
6.1 20DB BANDWIDTH 9
6.2 PEAK POWER 12
6.3 PWER POWER SPECTRAL DENSITY 14
6.4 BAND EDGES MEASUREMENT 15
6.5 FREQUENCY SEPARATION 21
6.6 NUMBER OF HOPPING FREQUENCY 23
6.7 TIME OF OCCUPANCY (DWELL TIME) 25
6.8 SPURIOUS EMISSIONS 28
6.9 POWERLINE CONDUCTED EMISSIONS 40



1. TEST RESULT CERTIFICATION

Product:	4CH 2.4GHz FHSS RADIO SYSTEM
Model:	KT-24
Brand:	KYOSHO
Tested:	March 4~24, 2011
Applicant:	SHANGHAI MERIT TECHNOLOGY CORP. 1058 TAOGAN RD., SHESHAN TOWN SONGJIANG DISTRICT, SHANGHAI, CHINA
Manufacturer:	SHANGHAI MERIT TECHNOLOGY CORP. 1058 TAOGAN RD., SHESHAN TOWN SONGJIANG DISTRICT, SHANGHAI, CHINA

APPLICABLE STANDARDS	
STANDARD	TEST RESULT
FCC 47 CFR Part 15 Subpart C	No non-compliance noted

We hereby certify that:

The above equipment was tested by Compliance Certification Services Inc. The test data, data evaluation, test procedures, and equipment configurations shown in this report were made in accordance with the procedures given in ANSI C63.4: 2003 and the energy emitted by the sample EUT tested as described in this report is in compliance with conducted and radiated emission limits of FCC Rules Part 15.207, 15.209 and 15.247.

The test results of this report relate only to the tested sample EUT identified in this report.

Approved by:

Reviewed by:

Vincent Yao
 Manager
 Compliance Certification Service Inc.

Aven Zhou
 Supervisor of Report Dept.
 Compliance Certification Service Inc.



2. EUT DESCRIPTION

Product	4CH 2.4GHz FHSS RADIO SYSTEM
Model Number	KT-24
Trade Name	KYOSHO
Model Discrepancy	N/A
Identify Number	SZ110304B03-RP
Power Supply	DC 6V (supplied from 1.5V*4cell "AA" alkaline battery)
Frequency Range	2415~2455MHz
Received Date	March 23, 2011
Transmit Power	2.42dBm
Modulation Technique	FHSS
Number of Channels	41 Channels
Antenna Specification	Dipole Antenna :2.0dBi (Max)
Temperature Range	0°C ~ +55°C

Note: This submittal(s) (test report) is intended for FCC ID: XJ6TXT7HFMR filing to comply with Section 15.207, 15.209 and 15.247 of the FCC Part 15, Subpart C Rules.



3. TEST METHODOLOGY

3.1 DESCRIPTION OF TEST MODES

The EUT has been tested under operating condition.

Test program used to control the EUT for staying in continuous transmitting and receiving mode is programmed.

The following test mode(s) were scanned during the preliminary test below 1G:

Test Item	Test mode	Worse mode
Conducted Emission	Not applicable since the EUT supplied by the battery.	
Radiated Emission	Mode 1: Normal Link	■

Above 1G, Channel Low (2415MHz) · Mid (2435MHz) and High (2455MHz) were chosen for full testing.



4. FACILITIES AND ACCREDITATIONS

4.1 FACILITIES

All measurement facilities used to collect the measurement data are located at

No.10-1,Mingkeda Logistics Park, NO.18, Huanguan south Rd., Guan lan Town, Baoan District, Shenzhen China

The sites are constructed in conformance with the requirements of ANSI C63.4:2003, ANSI C63.7 and CISPR Publication 22. All receiving equipment conforms to CISPR Publication 16-1, "Radio Interference Measuring Apparatus and Measurement Methods."

4.2 ACCREDITATIONS

Our laboratories are accredited and approved by the following accreditation body according to ISO/IEC 17025.

USA	A2LA
China	CNAS

The measuring facility of laboratories has been authorized or registered by the following approval agencies.

USA	FCC
Japan	VCCI
Canada	INDUSTRY CANADA
Taiwan	BSMI
Norway	Nemko

Copies of granted accreditation certificates are available for downloading from our web site, <http://www.ccsrf.com>

4.3 MEASUREMENT UNCERTAINTY

Where relevant, the following measurement uncertainty levels have been estimated for tests performed on the EUT as specified in CISPR 16-4-2:

Measurement	Frequency	Uncertainty
Conducted emissions	9kHz~30MHz	+/- 3.18dB
Radiated emissions	30MHz ~ 200MHz	+/- 3.79dB
	200MHz ~1000MHz	+/- 3.62dB
	Above 1000MHz	+/- 5.04dB

This uncertainty represents an expanded uncertainty expressed at approximately the 95% confidence level using a coverage factor of k=2.

The measured result is above (below) the specification limit by a margin less than the measurement uncertainty; it is therefore not possible to state compliance based on the 95% level of confidence. However, the result indicates that compliance (non-compliance) is more probable than non-compliance) with the specification limit.



5. SETUP OF EQUIPMENT UNDER TEST

5.1 SETUP CONFIGURATION OF EUT

See test photographs attached in Appendix 1 for the actual connections between EUT and support equipment.

5.2 SUPPORT EQUIPMENT

No.	Equipment	Model No.	Serial No.	FCC ID	Trade Name	Data Cable	Power Cord
1	Remote controller	N/A	N/A	N/A	N/A	N/A	N/A
2	Toy plane	N/A	N/A	N/A	N/A	N/A	N/A

Notes:

1. All the equipment/cables were placed in the worst-case configuration to maximize the emission during the test.
2. Grounding was established in accordance with the manufacturer's requirements and conditions for the intended use.



6. FCC PART 15.247 REQUIREMENTS

6.1 20DB BANDWIDTH

None; for reporting purpose only.

MEASUREMENT EQUIPMENT USED

Name of Equipment	Manufacturer	Model	Serial Number	Last Calibration	Due Calibration
Spectrum Analyzer	Agilent	E4446A	US44300399	03/21/2011	03/21/2012

Remark: Each piece of equipment is scheduled for calibration once a year.

TEST CONFIGURATION

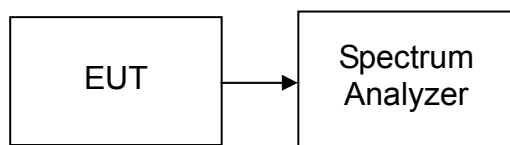

TEST PROCEDURE

1. Place the EUT on the table and set it in the transmitting mode.
2. Remove the antenna from the EUT, then connect a low loss RF cable from antenna port to the spectrum analyzer.
3. Set the spectrum analyzer as RBW=30kHz, VBW=30kHz, Span=3MHz, Sweep = auto.
4. Mark the peak frequency and 20dB (upper and lower) frequency.
5. Repeat until all the test channels are investigated.

TEST RESULTS

No non-compliance noted



Test plot

20dB Bandwidth (CH Low)

Agilent 07:10:49 Mar 11, 2011

R T

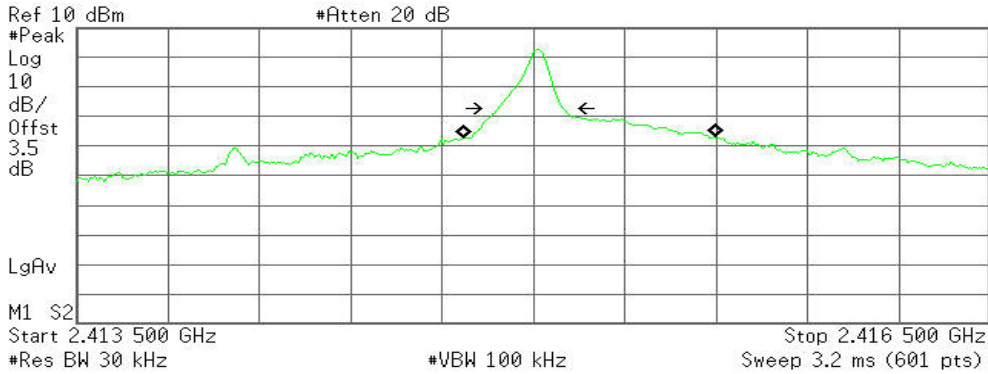

Occupied Bandwidth 823.4309 kHz

Occ BW % Pwr 99.00 %
x dB -20.00 dB

Transmit Freq Error 181.722 kHz
x dB Bandwidth 219.865 kHz

20dB Bandwidth (CH Mid)

Agilent 07:15:56 Mar 11, 2011

R T

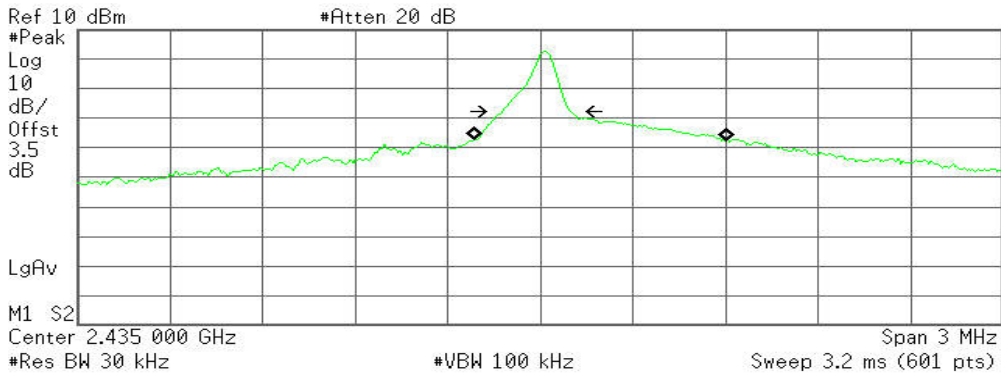

Occupied Bandwidth 819.5253 kHz

Occ BW % Pwr 99.00 %
x dB -20.00 dB

Transmit Freq Error 197.207 kHz
x dB Bandwidth 222.905 kHz



20dB Bandwidth (CH High)

Agilent 07:05:39 Mar 11, 2011

R T



Ref 10 dBm #Atten 20 dB
#Peak Log 10 dB/Offst 3.5 dB
LgAv
M1 S2
Center 2.455 000 GHz Span 3 MHz
#Res BW 30 kHz #VBW 100 kHz Sweep 3.2 ms (601 pts)

Occupied Bandwidth
780.7033 kHz

Occ BW % Pwr 99.00 %
x dB -20.00 dB

Transmit Freq Error 193.235 kHz
x dB Bandwidth 222.652 kHz



6.2 PEAK POWER

LIMIT

The maximum peak output power of the intentional radiator shall not exceed the following:

1. For frequency hopping systems operating in the 2400-2483.5 MHz band employing at least 75 non-overlapping hopping channels, and all frequency hopping systems in the 5725-5850 MHz band: 1 watt. For all other frequency hopping systems in the 2400-2483.5 MHz band: 0.125 watts.
2. Except as shown in paragraphs (b)(3) (i), (ii) and (iii) of this section, if transmitting antennas of directional gain greater than 6dBi are used the peak output power from the intentional radiator shall be reduced below the stated values in paragraphs (b)(1) or (b)(2) of this section, as appropriate, by the amount in dB that the directional gain of the antenna exceeds 6dBi.
3. The conducted output power limit specified in paragraph (b) of this section is based on the use of antennas with directional gains that do not exceed 6 dBi. Except as shown in paragraph (c) of this section, if transmitting antennas of directional gain greater than 6 dBi are used, the conducted output power from the intentional radiator shall be reduced below the stated values in paragraphs (b)(1), (b)(2), and (b)(3) of this section, as appropriate, by the amount in dB that the directional gain of the antenna exceeds 6 dBi.

MEASUREMENT EQUIPMENT USED

Name of Equipment	Manufacturer	Model	Serial Number	Last Calibration	Due Calibration
RF Power Meter & Sensor	Anritsu	ML2487A	6K00001491	06/18/2010	06/18/2011
Spectrum Analyzer	Agilent	E4446A	US44300399	03/21/2011	03/21/2012

Remark: Each piece of equipment is scheduled for calibration once a year.

Test Configuration

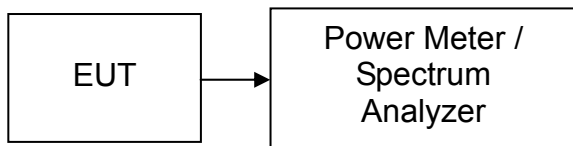

TEST PROCEDURE

The transmitter output is connected to the RF Power Meter. The RF Power Meter is set to the peak power detection.



TEST RESULTS

No non-compliance noted

Test Data

Channel	Frequency (MHz)	Reading Power (dBm)	Factor (dB)	Output Power (dBm)	Output Power (W)	Limit (mW)	Result
Low	2415	-1.08	3.50	2.42	0.00175		Pass
Mid	2435	-1.16	3.50	2.34	0.00171	125	Pass
High	2455	-1.25	3.50	2.25	0.00168		Pass



6.3 PEAK POWER SPECTRAL DENSITY

LIMIT

1. For direct sequence systems, the peak power spectral density conducted from the intentional radiator to the antenna shall not be greater than 8dBm in any 3kHz band during any time interval of continuous transmission.
2. The direct sequence operating of the hybrid system, with the frequency hopping operation turned off, shall comply with the power density requirements of paragraph (d) of this section.

MEASUREMENT EQUIPMENT USED

Name of Equipment	Manufacturer	Model	Serial Number	Last Calibration	Due Calibration
Spectrum Analyzer	Agilent	E4446A	US44300399	03/21/201	03/21/2012

Remark: Each piece of equipment is scheduled for calibration once a year.

TEST CONFIGURATION

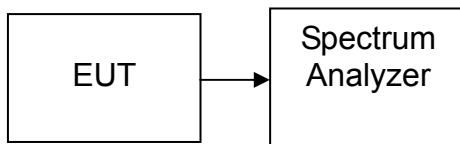

TEST PROCEDURE

1. Place the EUT on the table and set it in transmitting mode.
2. Remove the antenna from the EUT and then connect a low loss RF cable from the antenna port to the spectrum analyzer.
3. Set the spectrum analyzer as RBW = 3kHz, VBW = 10kHz, Span = 300kHz, Sweep=100s
4. Record the max. reading.
5. Repeat the above procedure until the measurements for all frequencies are completed.

TEST RESULTS

Not applicable, Since EUT is the FHSS modulation technique device.



6.4 BAND EDGES MEASUREMENT

LIMIT

According to §15.247(c), in any 100 kHz bandwidth outside the frequency bands in which the spread spectrum intentional radiator is operating, the radio frequency power that is produced by the intentional radiator shall be at least 20dB below that in the 100kHz bandwidth within the band that contains the highest level of the desired power. In addition, radiated emissions which fall in the restricted bands, as defined in §15.205(a), must also comply with the radiated emission limits specified in 15.209(a).

MEASUREMENT EQUIPMENT USED

Radiated Emission Test Site 966 (2)						
Name of Equipment	Manufacturer	Model Number	Serial Number	Last Calibration	Due Calibration	
PSA Series Spectrum Analyzer	Agilent	E4446A	US44300399	03/21/2011	03/21/2012	
Amplifier	MITEQ	AM-1604-3000	1411843	03/21/2011	03/21/2012	
Turn Table	EMCO	2081-1.21	N/A	N.C.R	N.C.R	
Controller	CT	N/A	N/A	N.C.R	N.C.R	
High Noise Amplifier	Agilent	8449B	3008A01838	06/18/2010	06/18/2011	
Site NSA	C&C	N/A	N/A	N.C.R	N.C.R	
Bilog Antenna	SCHAFFNER	CBL6143	5082	06/18/2010	06/18/2011	
Horn Antenna	SCHWARZBECK	BBHA9120D	D286	03/19/2011	03/19/2012	
Signal Generator	Anritsu	MG3694A	#050125	03/21/2011	03/21/2012	
Horn Antenna	TRC	HA0301	N/A	03/19/2011	03/19/2012	
Loop Antenna	A.R.A	PLA-1030/B	1029	03/19/2011	03/19/2012	
Power Sensor	Anritsu	MA2491A	030619	06/18/2010	06/18/2011	
Power Meter	Anritsu	ML2487A	6K00001491	06/18/2010	06/18/2011	
Temp. / Humidity Meter	VICTOR	VC230	N/A	03/30/2010	03/30/2011	

Test Configuration

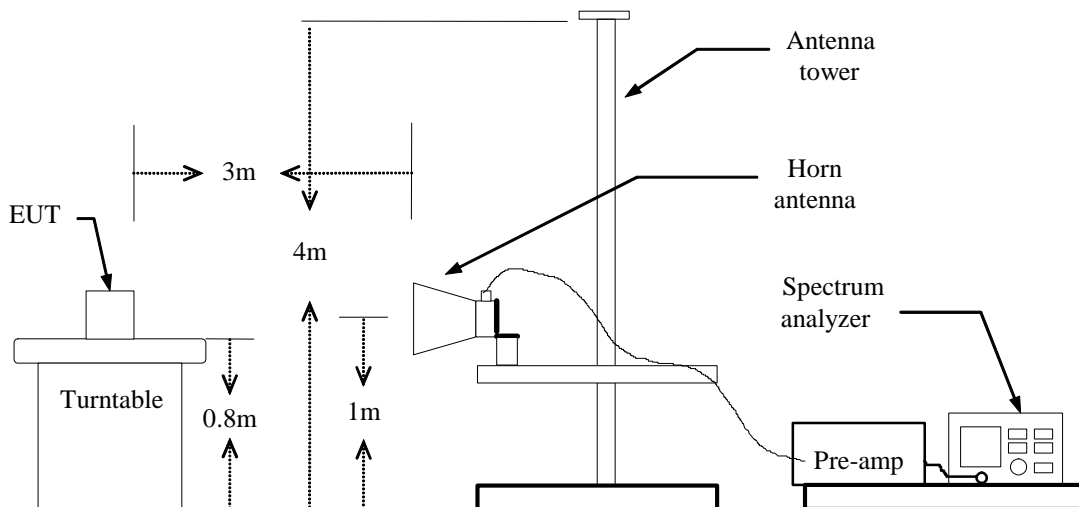



TEST PROCEDURE

1. The EUT is placed on a turntable, which is 0.8m above the ground plane.
2. The turntable shall be rotated for 360 degrees to determine the position of maximum emission level.
3. EUT is set 3m away from the receiving antenna, which is varied from 1m to 4m to find out the highest emission.
4. Set the spectrum analyzer in the following setting in order to capture the lower and upper band-edges of the emission:
 - (a) PEAK: RBW=VBW=1MHz / Sweep=AUTO
 - (b) AVERAGE: RBW=1MHz / VBW=10Hz / Sweep=AUTO
5. Repeat the procedures until all the PEAK and AVERAGE versus POLARIZATION are measured.

TEST RESULTS

Refer to attach spectrum analyzer data chart.



Test Data

Band Edges (CH-Low)

Detector mode: Peak

Polarity: Vertical

Agilent 04:26:10 Feb 23, 2011

R T

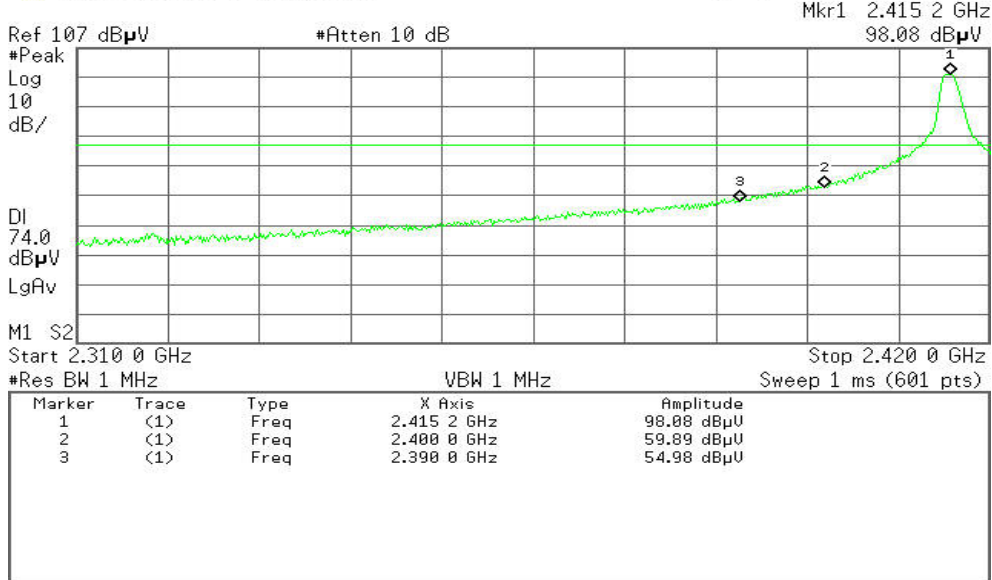

Detector mode: Average

Polarity: Vertical

Agilent 04:27:42 Feb 23, 2011

R T

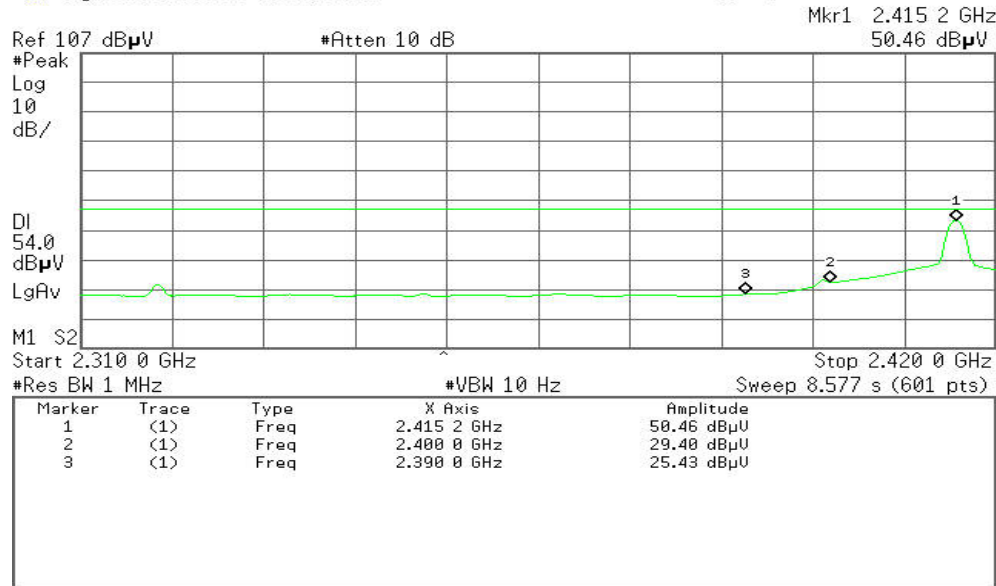



Detector mode: Peak

Polarity: Horizontal

Agilent 06:13:13 Feb 23, 2011

R T

Mkr1 2.415 2 GHz
95.22 dBµV

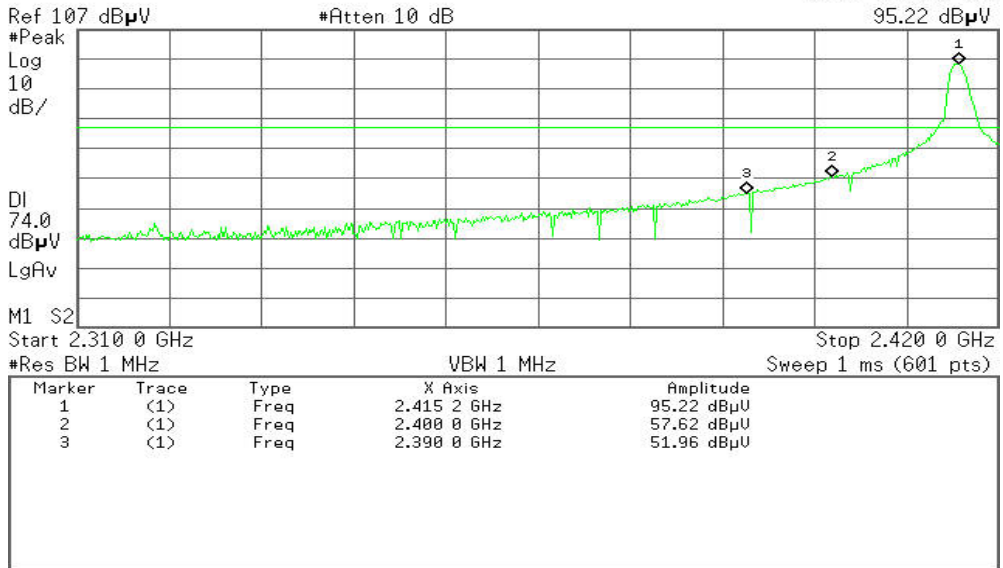

Detector mode: Average

Polarity: Horizontal

Agilent 06:14:04 Feb 23, 2011

R T

Mkr1 2.415 0 GHz
49.34 dBµV

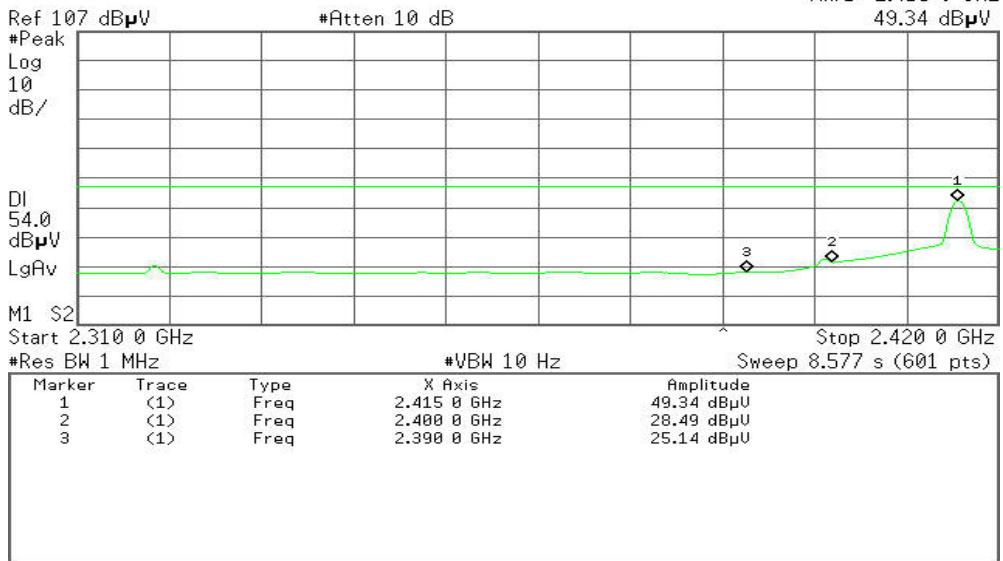



Band Edges (CH-High)

Detector mode: Peak

Polarity: Vertical

Agilent 06:23:23 Feb 23, 2011

R T

Mkr1 2.455 17 GHz
98.83 dBµV

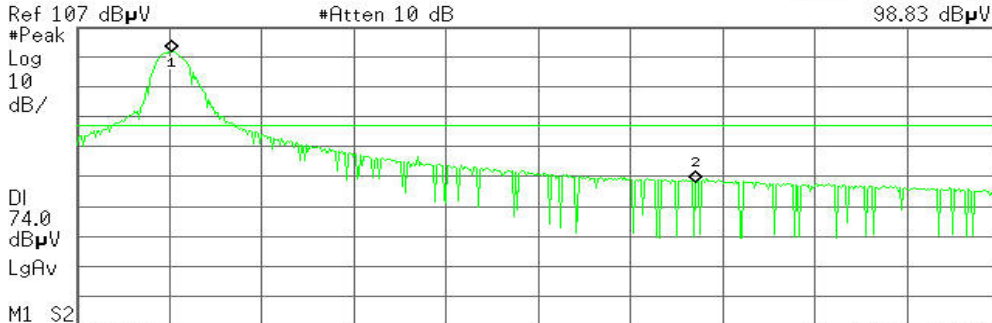

Start 2.450 00 GHz Stop 2.500 00 GHz
#Res BW 1 MHz VBW 1 MHz Sweep 1 ms (601 pts)

Marker	Trace	Type	X Axis	Amplitude
1	(1)	Freq	2.455 17 GHz	98.83 dBµU
2	(1)	Freq	2.483 50 GHz	55.17 dBµU

Detector mode: Average

Polarity: Vertical

Agilent 06:24:05 Feb 23, 2011

R T

Mkr1 2.455 17 GHz
50.56 dBµV

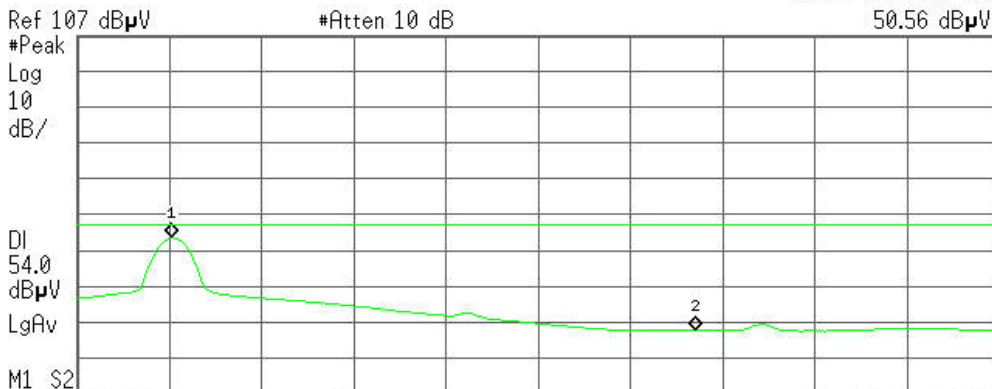

Start 2.450 00 GHz Stop 2.500 00 GHz
#Res BW 1 MHz VBW 10 Hz Sweep 3.899 s (601 pts)

Marker	Trace	Type	X Axis	Amplitude
1	(1)	Freq	2.455 17 GHz	50.56 dBµU
2	(1)	Freq	2.483 50 GHz	24.80 dBµU



Detector mode: Peak

Polarity: Horizontal

Agilent 06:19:49 Feb 23, 2011

R T

Mkr1 2.455 17 GHz
96.62 dBµV

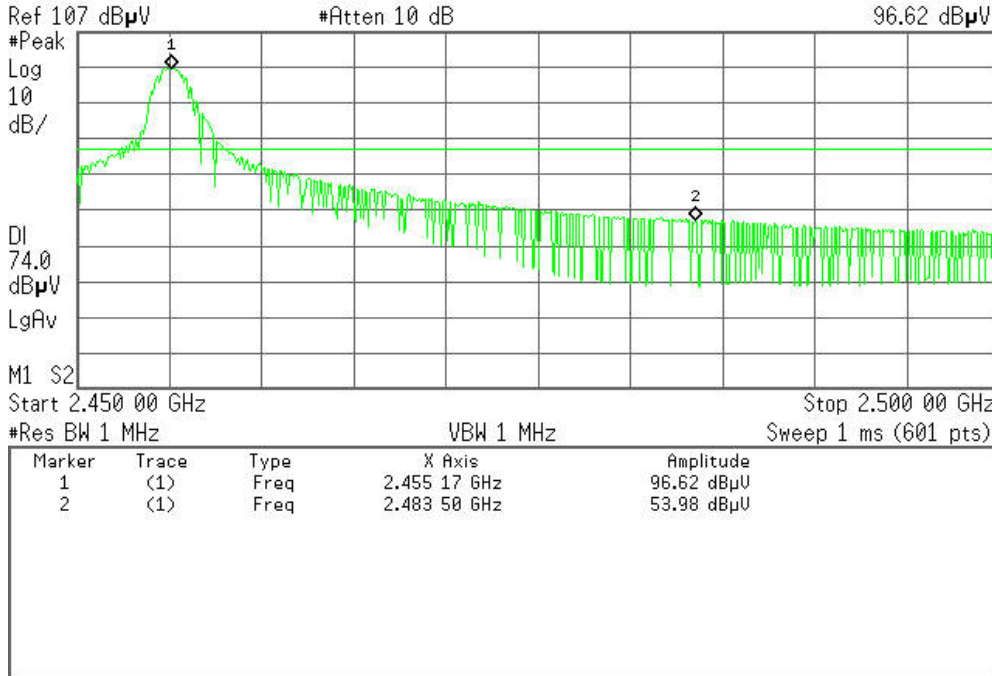

Detector mode: Average

Polarity: Horizontal

Agilent 06:20:26 Feb 23, 2011

R T

Mkr1 2.455 17 GHz
49.95 dBµV

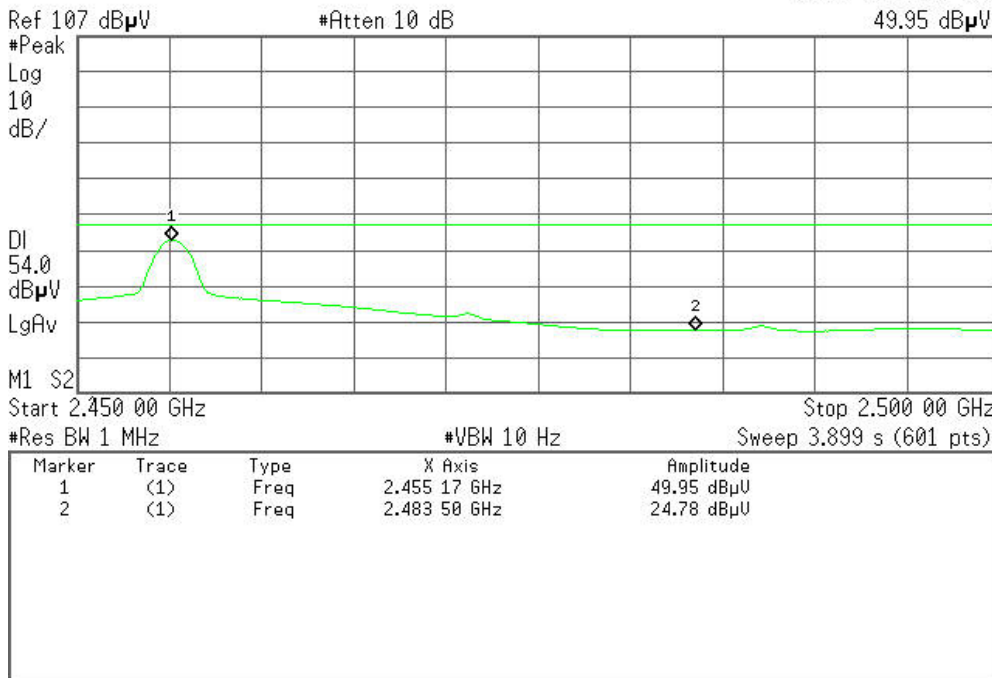



6.5 FREQUENCY SEPARATION

LIMIT

According to §15.247(a)(1), Frequency hopping systems shall have hopping channel carrier frequencies separated by a minimum of 25 kHz or the 20 dB bandwidth of the hopping channel, whichever is greater. Alternatively, frequency hopping systems operating in the 2400-2483.5 MHz band may have hopping channel carrier frequencies that are separated by 25 kHz or two-thirds of the 20 dB bandwidth of the hopping channel, whichever is greater, provided the systems operate with an output power no greater than 125 mW.

MEASUREMENT EQUIPMENT USED

Name of Equipment	Manufacturer	Model	Serial Number	Last Calibration	Due Calibration
Spectrum Analyzer	Agilent	E4446A	US44300399	03/21/2011	03/21/2012
Spectrum Analyzer	R&S	FSP30	1093.4495.30	07/22/2010	07/22/2011

Remark: Each piece of equipment is scheduled for calibration once a year.

Test Configuration

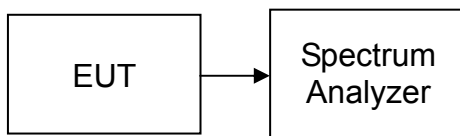

TEST PROCEDURE

1. Place the EUT on the table and set it in transmitting mode.
2. Remove the antenna from the EUT and then connect a low loss RF cable from the antenna port to the spectrum analyzer.
3. Set center frequency of spectrum analyzer = middle of hopping channel.
4. Set the spectrum analyzer as RBW=30kHz, VBW=30kHz, Adjust Span to 3 MHz, Sweep = auto.
5. Max hold. Mark 3 Peaks of hopping channel and record the 3 peaks frequency.

TEST RESULTS

No non-compliance noted

Test Data

FHSS

Channel Separation (MHz)	Two-thirds of the 20 dB Bandwidth (kHz)	Channel Separation Limit	Result
1.033	148.603	> Two-thirds of the 20 dB Bandwidth	Pass



Test Plot

Measurement of Channel Separation

Agilent 19:28:54 Dec 30, 2010

R T

Mkr2 1.033 MHz 0.99 dB

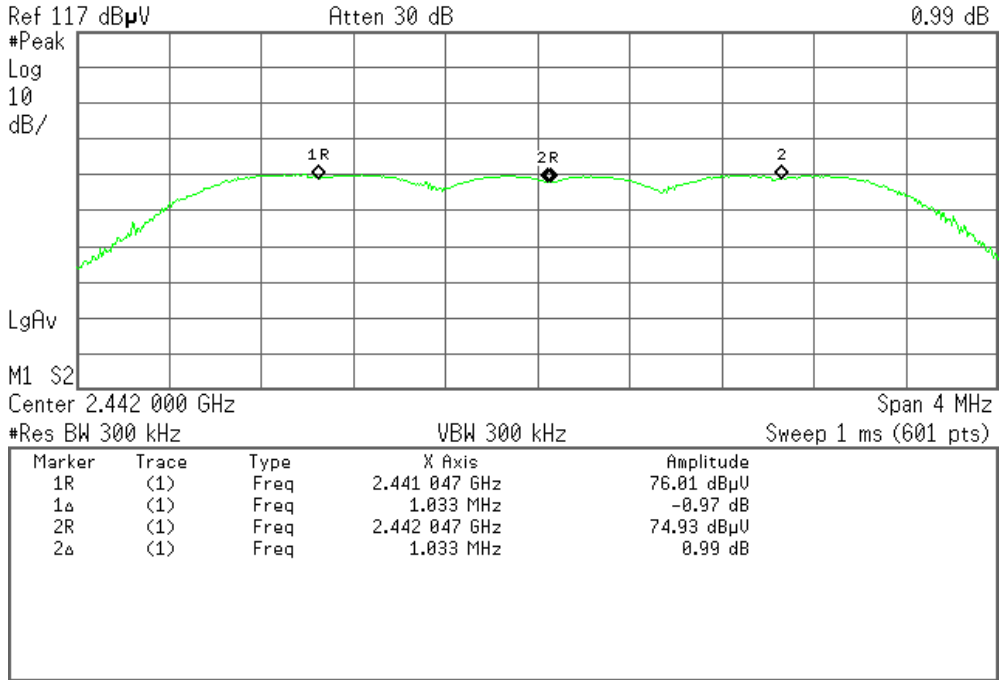

20 dB bandwidth(CH Mid)

Agilent 07:15:56 Mar 11, 2011

R T

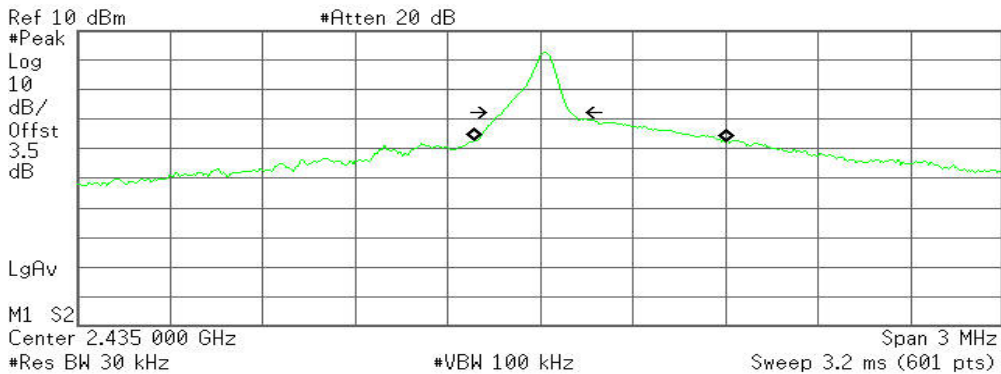

Occupied Bandwidth 819.5253 kHz

Occ BW % Pwr 99.00 % x dB -20.00 dB

Transmit Freq Error 197.207 kHz x dB Bandwidth 222.905 kHz



6.6 NUMBER OF HOPPING FREQUENCY

LIMIT

According to §15.247(a)(1)(ii), Frequency hopping systems operating in the 2400MHz-2483.5 MHz bands shall use at least 15 hopping frequencies.

MEASUREMENT EQUIPMENT USED

Name of Equipment	Manufacturer	Model	Serial Number	Last Calibration	Due Calibration
Spectrum Analyzer	Agilent	E4446A	US44300399	03/21/2011	03/21/2012

Remark: Each piece of equipment is scheduled for calibration once a year.

Test Configuration

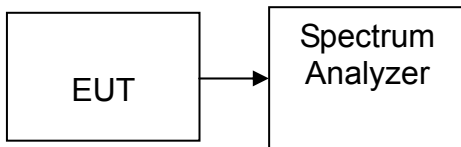

TEST PROCEDURE

1. Place the EUT on the table and set it in transmitting mode.
2. Remove the antenna from the EUT and then connect a low loss RF cable from the antenna port to the spectrum analyzer.
3. Set spectrum analyzer Start=2407.06MHz, Stop = 2441.15MHz, Sweep = 1ms and Start=2442.06MHz, Stop = 2477.06MHz, Sweep = 1ms.
4. Set the spectrum analyzer as RBW, VBW=300kHz,
5. Max hold, view and count how many channel in the band.

TEST RESULTS

No non-compliance noted

Test Data

Result (No. of CH)	Limit (No. of CH)	Result
41	>15	PASS



Test Plot

Channel Number

2.4 GHz – 2.441 GHz

Agilent 07:25:41 Mar 11, 2011

R T

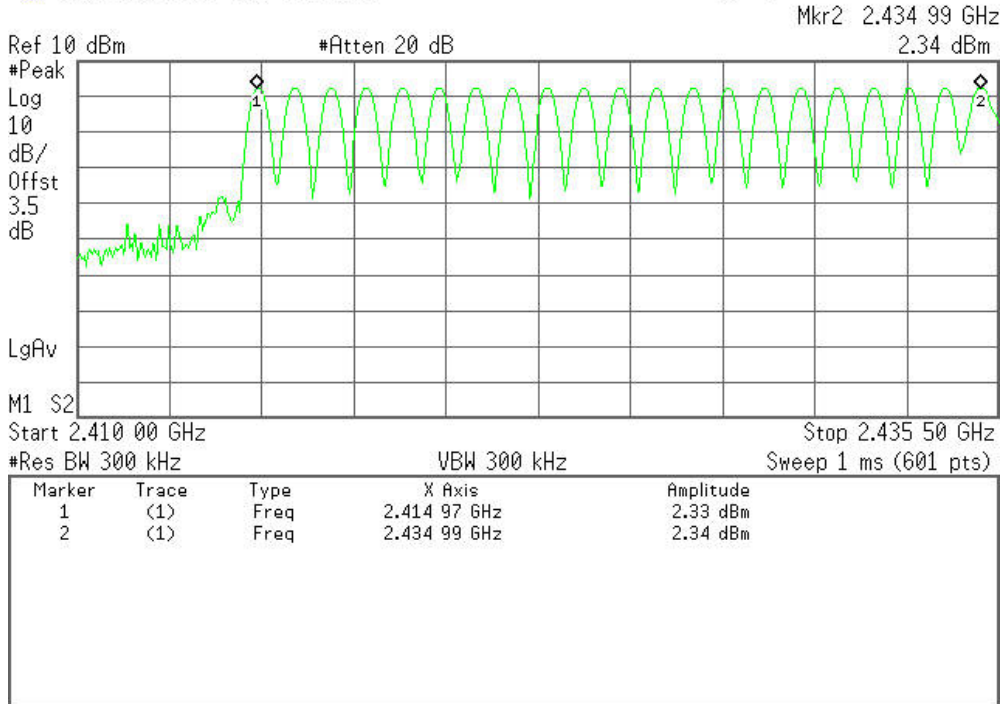

2.441 GHz – 2.4835 GHz

Agilent 07:53:33 Mar 11, 2011

R T

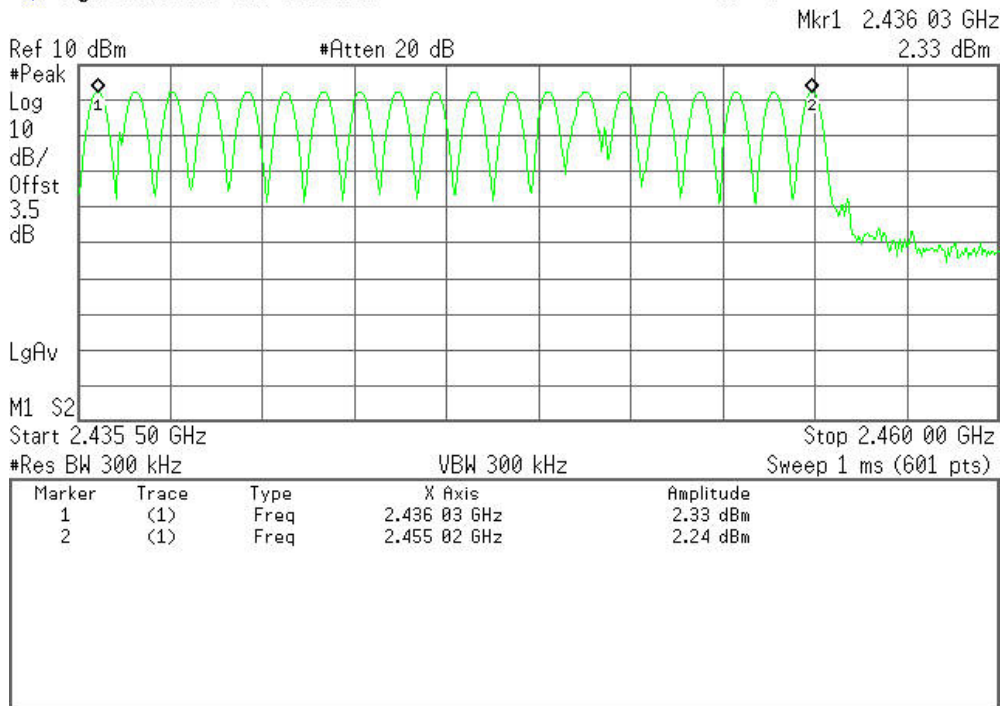



6.7 TIME OF OCCUPANCY (DWELL TIME)

LIMIT

According to §15.247(a)(1)(iii), Frequency hopping systems operating in the 2400MHz-2483.5 MHz bands. The average time of occupancy on any channels shall not greater than 0.4 s within a period 0.4 s multiplied by the number of hopping channels employed.

MEASUREMENT EQUIPMENT USED

Name of Equipment	Manufacturer	Model	Serial Number	Last Calibration	Due Calibration
Spectrum Analyzer	Agilent	E4446A	US44300399	03/21/2011	03/21/2012

Remark: Each piece of equipment is scheduled for calibration once a year.

Test Configuration

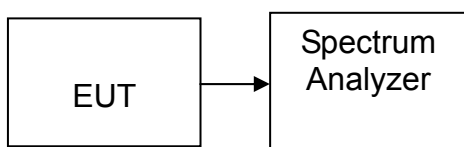

TEST PROCEDURE

1. Place the EUT on the table and set it in transmitting mode.
2. Remove the antenna from the EUT and then connect a low loss RF cable from the antenna port to the spectrum analyzer.
3. Set center frequency of spectrum analyzer = operating frequency.
4. Set the spectrum analyzer as RBW, VBW=1MHz, Span = 0Hz, Sweep = auto.
5. Repeat above procedures until all frequency measured were complete.



TEST RESULTS

No non-compliance noted

Test Plot

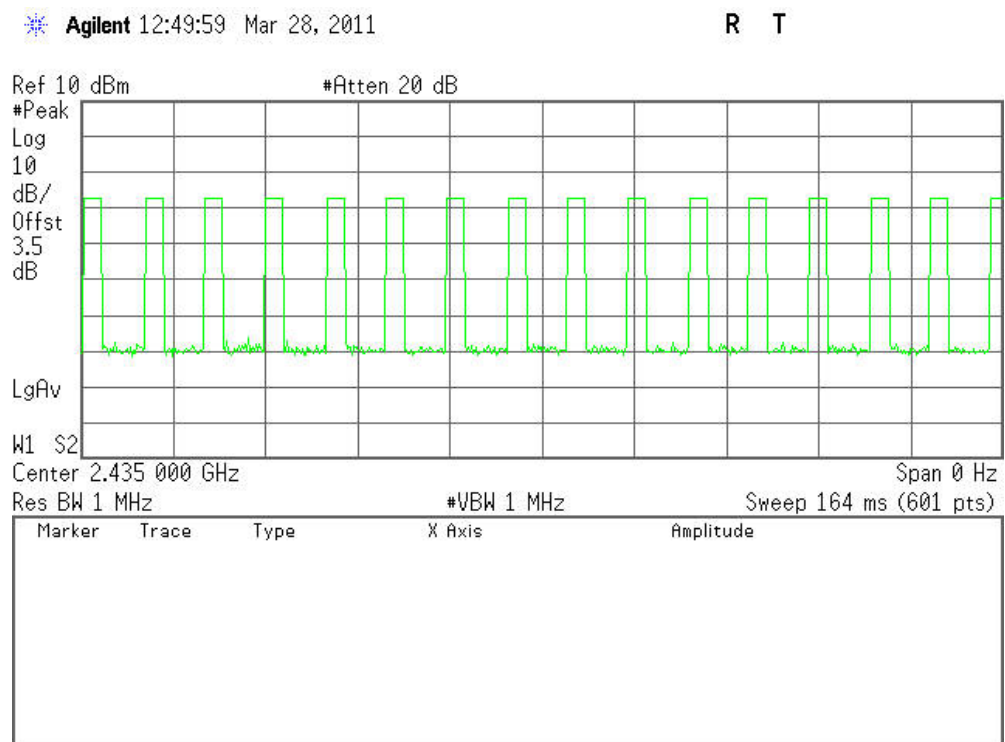
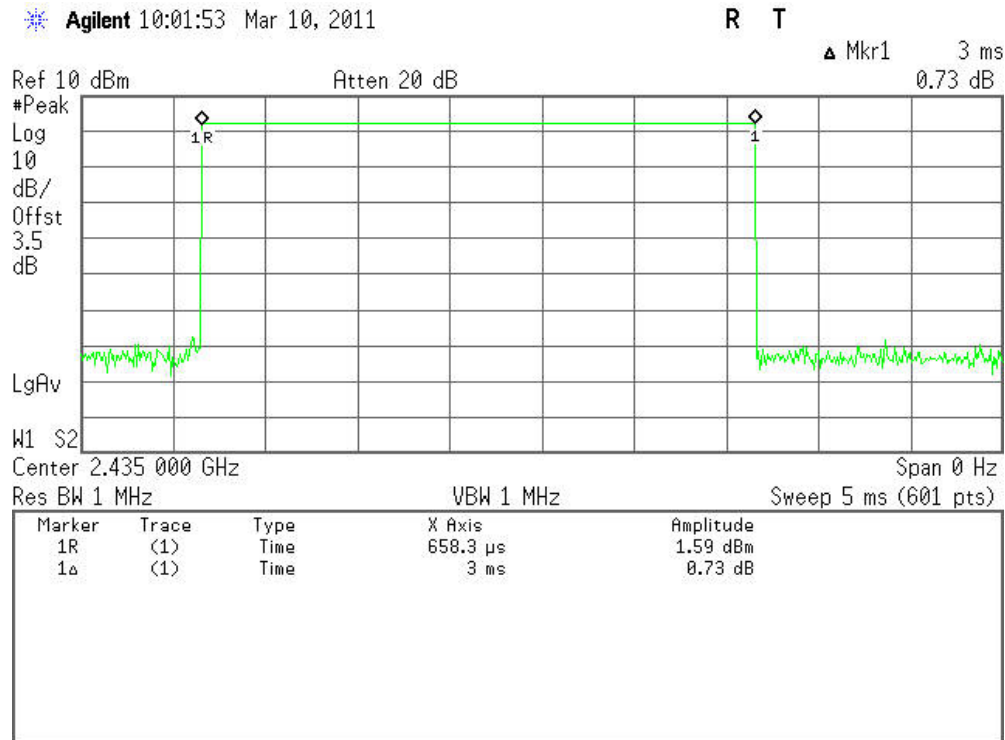



The average time of occupancy in the specified 16.4 second period (41 channel *0.4s) is equal to $16.4 * (\# \text{ of pulse in } 16.4\text{s} / 16.4) * \text{pulse width}$.

Pulse width=3ms

#pulse in 0.164s=16

Time of occupancy= $16.4 * (16 / 0.164) / 41 * 3 = 117\text{ms} \leq 400\text{m}$



6.8 SPURIOUS EMISSIONS

6.8.1. Conducted Measurement

LIMIT

In any 100 kHz bandwidth outside the frequency band in which the spread spectrum or digitally modulated intentional radiator is operating, the radio frequency power that is produced by the intentional radiator shall be at least 20 dB below that in the 100 kHz bandwidth within the band that contains the highest level of the desired power, based on either an RF conducted or a radiated measurement. Attenuation below the general limits specified in Section 15.209(a) is not required. In addition, radiated emissions which fall in the restricted bands, as defined in Section 15.205(a), must also comply with the radiated emission limits specified in Section 15.209(a) (see Section 15.205(c)).

MEASUREMENT EQUIPMENT USED

Name of Equipment	Manufacturer	Model	Serial Number	Last Calibration	Due Calibration
Spectrum Analyzer	Agilent	E4446A	US44300399	03/21/2011	03/21/2012

Remark: Each piece of equipment is scheduled for calibration once a year.

Test Configuration

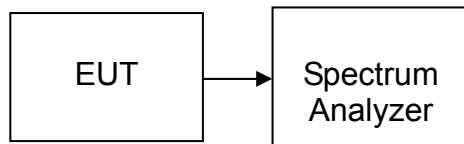

TEST PROCEDURE

Conducted RF measurements of the transmitter output were made to confirm that the EUT antenna port conducted emissions meet the specified limit and to identify any spurious signals that require further investigation or measurements on the radiated emissions site.

The transmitter output is connected to the spectrum analyzer. The resolution bandwidth is set to 100 KHz. The video bandwidth is set to 100 KHz.

Measurements are made over the 30MHz to 26GHz range with the transmitter set to the lowest, middle, and highest channels.

TEST RESULTS

No non-compliance noted



Test Plot

CH Low

Agilent 03:38:24 Mar 12, 2011

R T

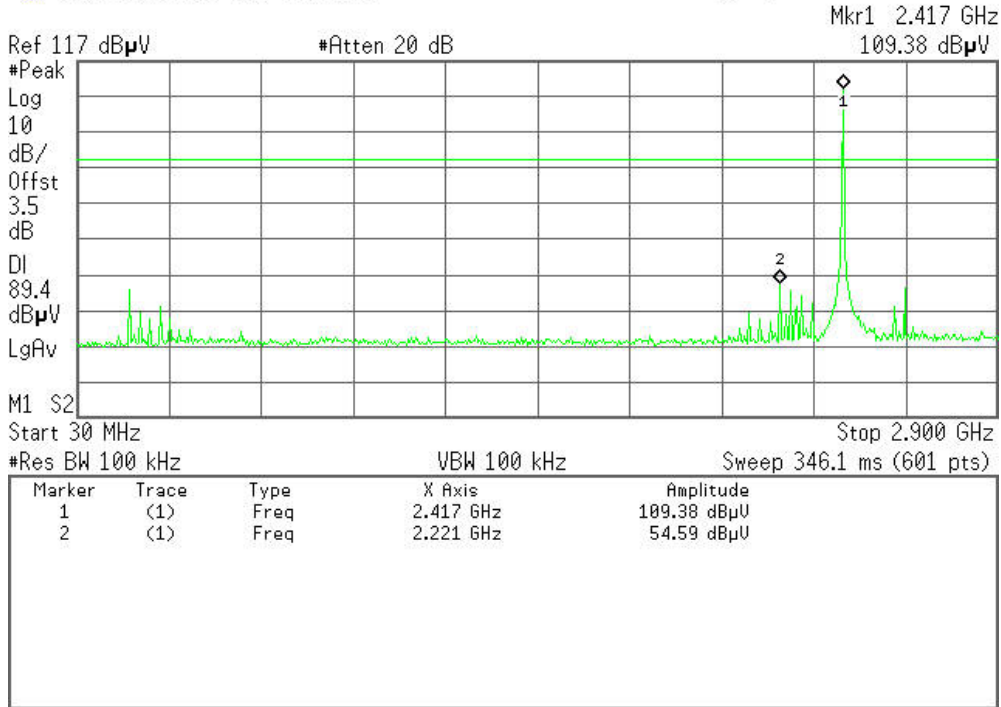

Agilent 03:40:54 Mar 12, 2011

R T

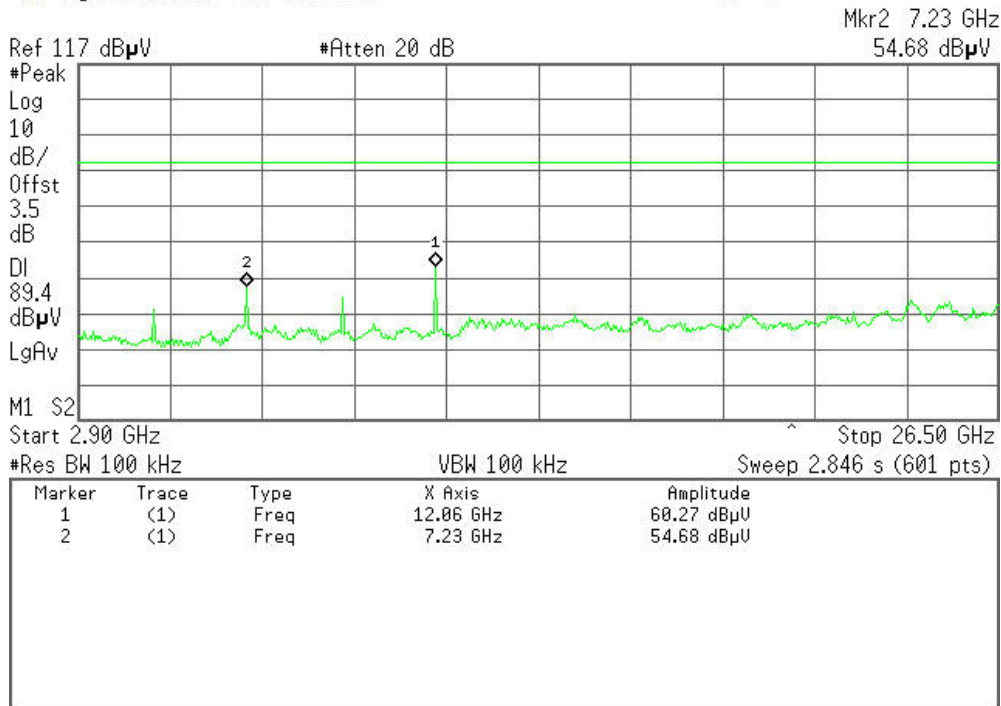



CH Mid

Agilent 03:42:52 Mar 12, 2011

R T

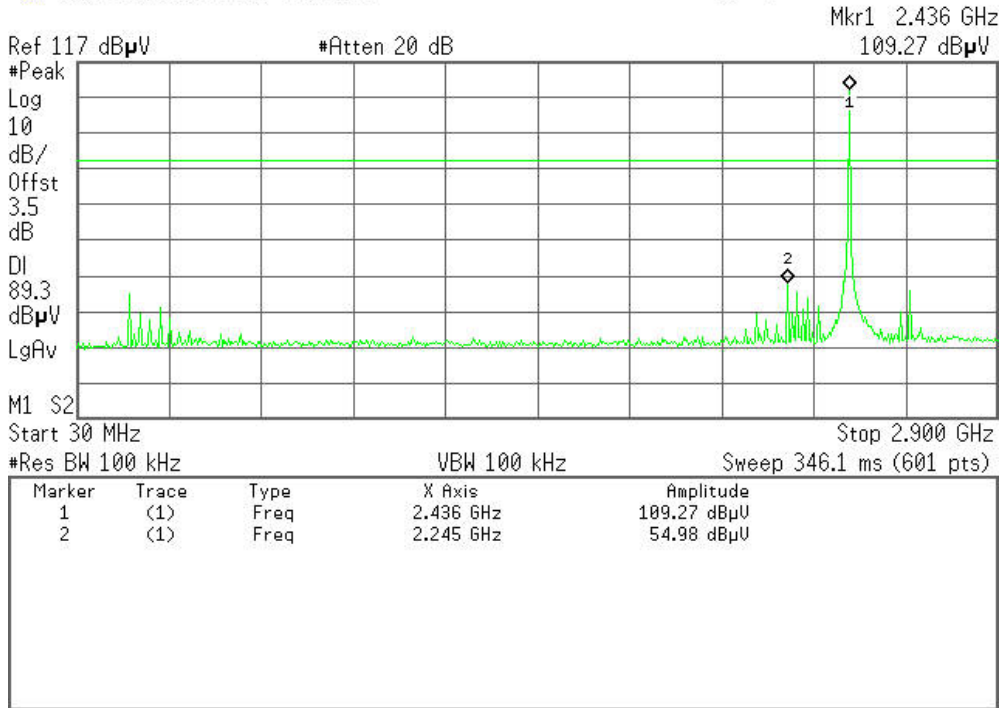

Agilent 03:43:43 Mar 12, 2011

R T

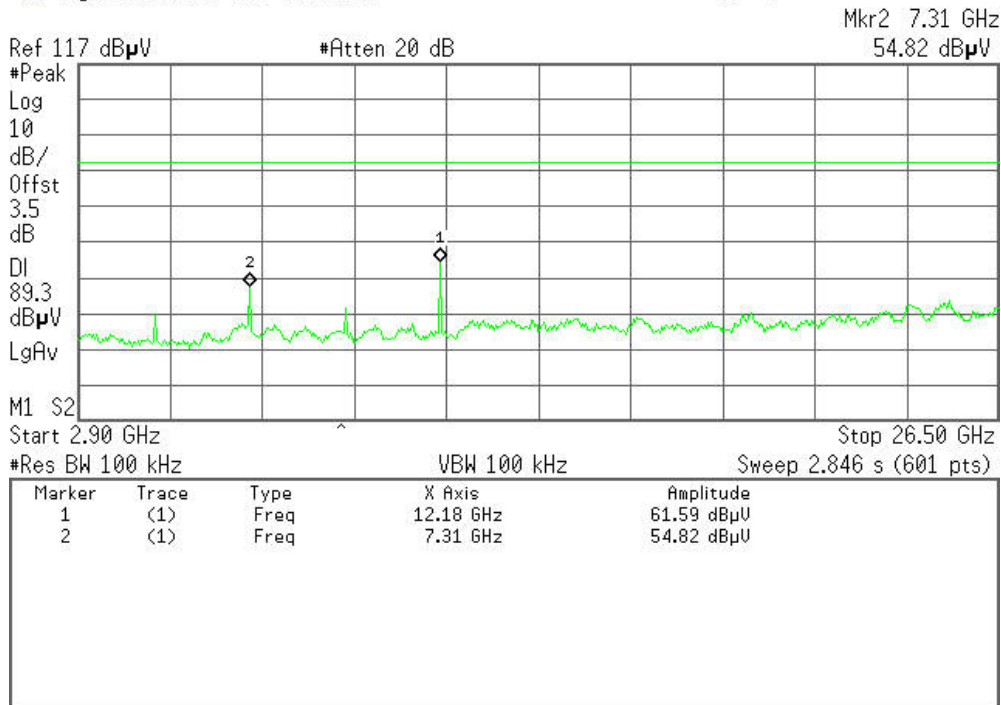



CH High

Agilent 03:29:45 Mar 12, 2011

R T

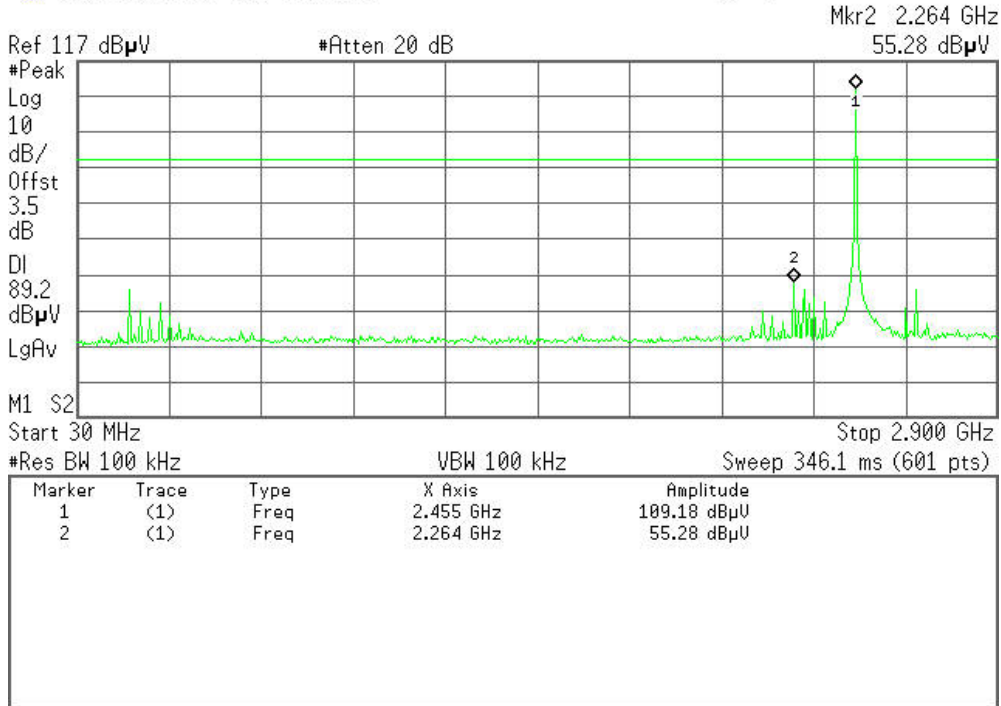

Agilent 03:36:59 Mar 12, 2011

R T

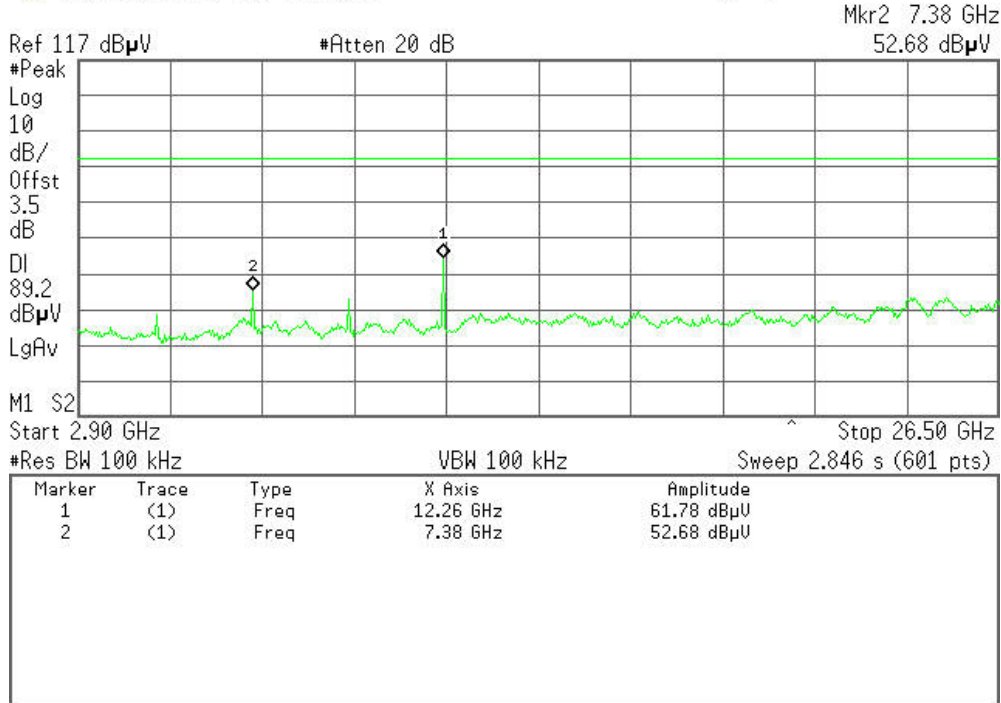



6.8.2. Radiated Emissions

LIMIT

1. Except as provided elsewhere in this Subpart, the emissions from an intentional radiator shall not exceed the field strength levels specified in the following table:

Frequency (MHz)	Field Strength (mV/m)	Measurement Distance (m)
30-88	100*	3
88-216	150*	3
216-960	200*	3
Above 960	500	3

Note: Except as provided in paragraph (g), fundamental emissions from intentional radiators operating under this Section shall not be located in the frequency bands 54-72 MHz, 76-88 MHz, 174-216 MHz or 470-806 MHz. However, operation within these frequency bands is permitted under other sections of this Part, e.g., Sections 15.231 and 15.241.

2. In the above emission table, the tighter limit applies at the band edges.

Frequency (Hz)	Field Strength (μ V/m at 3-meter)	Field Strength (dB μ V/m at 3-meter)
30-88	100	40
88-216	150	43.5
216-960	200	46
Above 960	500	54



MEASUREMENT EQUIPMENT USED

Radiated Emission Test Site 966 (2)						
Name of Equipment	Manufacturer	Model Number	Serial Number	Last Calibration	Due Calibration	
PSA Series Spectrum Analyzer	Agilent	E4446A	US44300399	03/21/2011	03/21/2012	
Amplifier	MITEQ	AM-1604-3000	1411843	03/21/2011	03/21/2012	
Turn Table	EMCO	2081-1.21	N/A	N.C.R	N.C.R	
Controller	CT	N/A	N/A	N.C.R	N.C.R	
High Noise Amplifier	Agilent	8449B	3008A01838	06/18/2010	06/18/2011	
Site NSA	C&C	N/A	N/A	N.C.R	N.C.R	
Bilog Antenna	SCHAFFNER	CBL6143	5082	06/18/2010	06/18/2011	
Horn Antenna	SCHWARZBECK	BBHA9120D	D286	03/19/2011	03/19/2012	
Signal Generator	Anritsu	MG3694A	#050125	03/21/2011	03/21/2012	
Horn Antenna	TRC	HA0301	N/A	03/19/2011	03/19/2012	
Loop Antenna	A.R.A	PLA-1030/B	1029	03/19/2011	03/19/2012	
Power Sensor	Anritsu	MA2491A	030619	06/18/2010	06/18/2011	
Power Meter	Anritsu	ML2487A	6K00001491	06/18/2010	06/18/2011	
Temp. / Humidity Meter	VICTOR	VC230	N/A	03/30/2010	03/30/2011	

Remark: Each piece of equipment is scheduled for calibration once a year.



Test Configuration
Below 30MHz

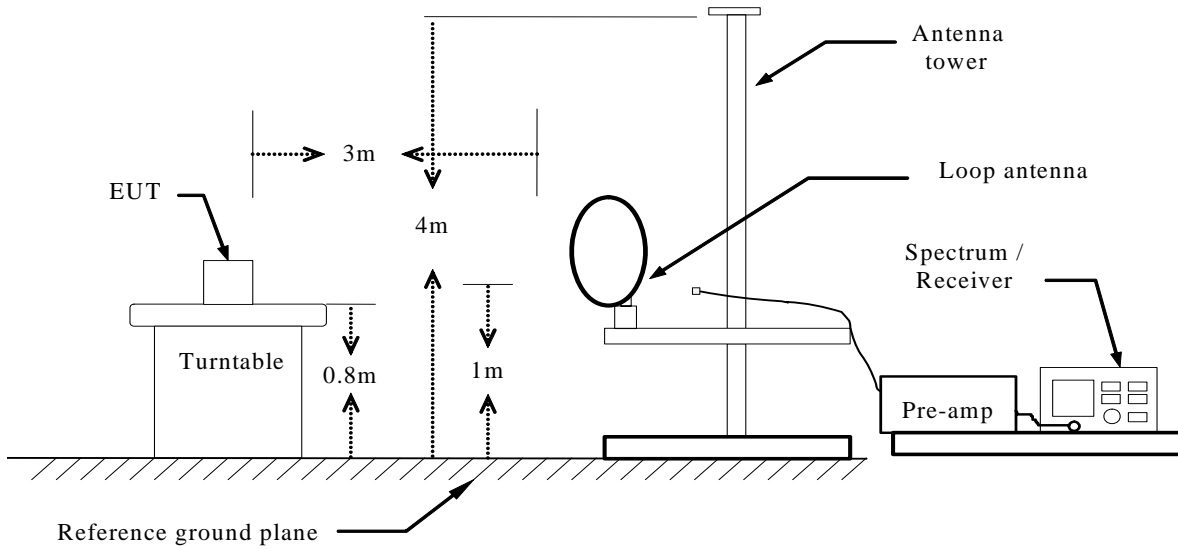

Below 1 GHz

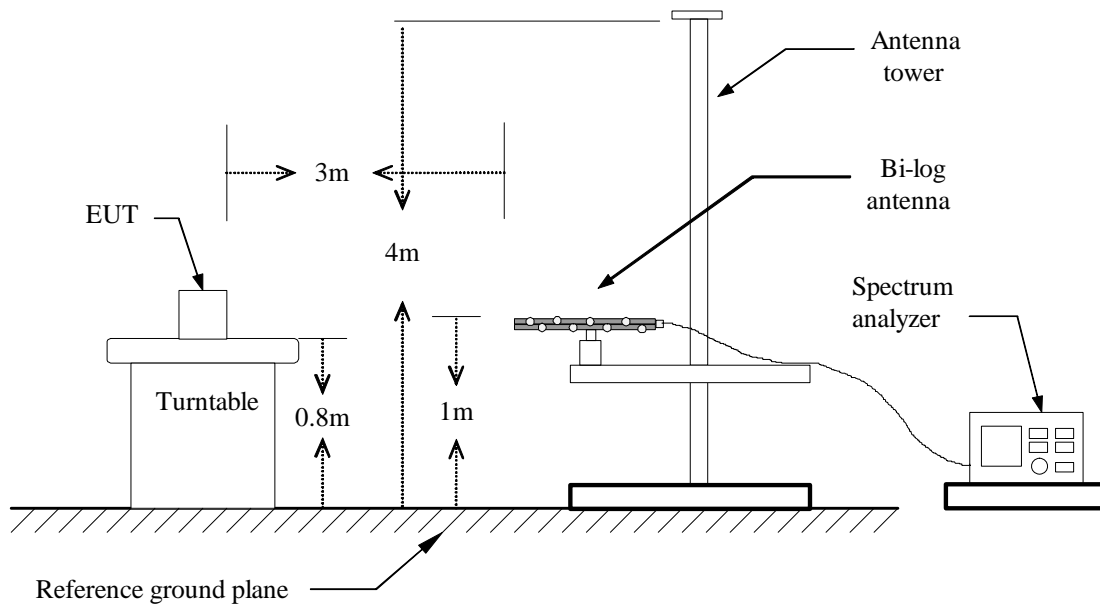



Above 1 GHz

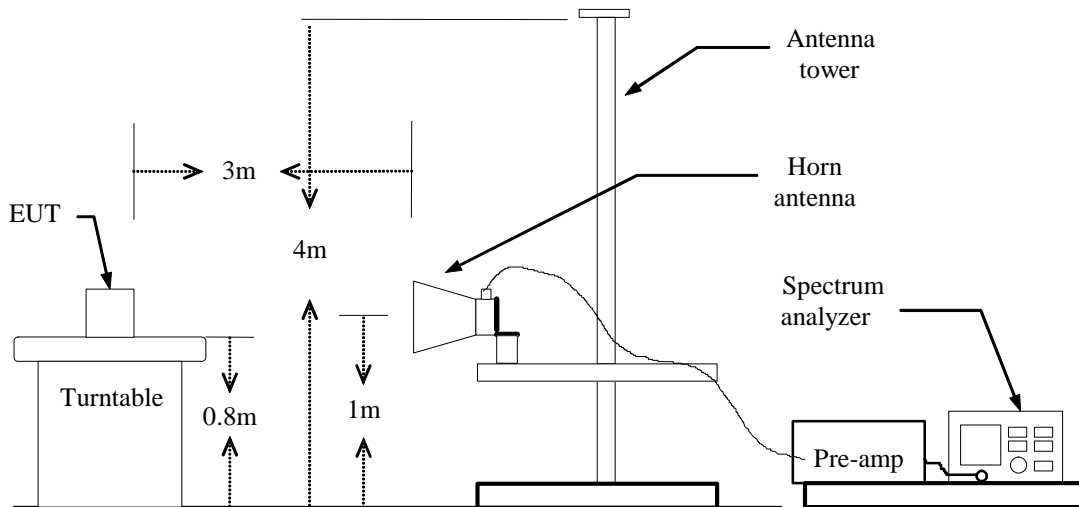

TEST PROCEDURE

1. The EUT is placed on a turntable, which is 0.8m above ground plane.
2. The turntable shall be rotated for 360 degrees to determine the position of maximum emission level.
3. EUT is set 3m away from the receiving antenna, which is varied from 1m to 4m to find out the highest emissions.
4. Maximum procedure was performed on the six highest emissions to ensure EUT compliance.
5. And also, each emission was to be maximized by changing the polarization of receiving antenna both horizontal and vertical.
6. Repeat above procedures until the measurements for all frequencies are complete.



TEST RESULTS

Below 1 GHz

Operation Mode: Normal Link

Test Date: March 23,2011

Temperature: 24°C

Tested by: Sunday Hu

Humidity: 52% RH

Polarity: Ver. / Hor.

Freq. (MHz)	Ant.Pol. H/V	Detector Mode (PK/Q.P)	Reading (dBuV/m)	Factor (dB)	Actual FS (dBuV/m)	Limits 3m (dBuV/m)	Safe Margin (dB)
60.716	V	Peak	50.01	-22.58	27.43	40.00	-12.57
112.450	V	Peak	49.03	-20.83	28.20	43.50	-15.30
144.783	V	Peak	46.02	-20.86	25.16	43.50	-18.34
319.383	V	Peak	41.70	-17.93	23.77	46.00	-22.23
351.716	V	Peak	41.31	-17.05	24.26	46.00	-21.74
742.950	V	Peak	32.15	-10.85	21.30	46.00	-24.70
112.450	H	Peak	43.53	-20.83	22.70	43.50	-20.80
159.333	H	Peak	38.80	-22.11	16.69	43.50	-26.81
319.383	H	Peak	42.75	-17.93	24.82	46.00	-21.18
351.716	H	Peak	40.91	-17.05	23.86	46.00	-22.14
704.150	H	Peak	33.31	-11.36	21.95	46.00	-24.05
833.483	H	Peak	35.57	-9.68	25.89	46.00	-20.11

****Remark:** No emission found between lowest internal used/generated frequency to 30MHz.

Notes:

1. Measuring frequencies from 9kHz to the 1GHz.
2. Radiated emissions measured in frequency range from 30MHz to 1GHz were made with an instrument using Peak/Quasi-peak detector mode.
3. Data of measurement within this frequency range shown " --- " in the table above means the reading of emissions are attenuated more than 20dB below the permissible limits or the field strength is too small to be measured.
4. The IF bandwidth of SPA between 30MHz to 1GHz was 100kHz.
5. Freq(MHz). = Emission frequency in MHz
 Reading (dBuV/m) = Receiver reading
 Corr. Factor (dB) = Antenna factor + Cable loss – Amplifier gain
 Actual FS (dBuV/m) = Reading (dBuV) + Corr. Factor (dB/m)
 Limit (dBuV/m) = Limit stated in standard
 Safe Margin(dB) = Measured (dBuV/m) – Limits (dBuV/m)
 Ant. H/V = Current carrying line of reading
 Detector = Mark Peak Reading or Quasi-peak Reading



Above 1 GHz

Operation Mode: TX(CH Low)
Temperature: 24°C
Humidity: 52% RH

Test Date: March 4, 2011
Tested by: Sunday Hu
Polarity: Ver. / Hor.

Table with 11 columns: Freq. (MHz), Ant. Pol H/V, Peak Reading (dBuV/m), AV Reading (dBuV/m), Ant. / CF (dB), Actual Fs (Peak and AV), Peak Limit (dBuV/m), AV Limit (dBuV/m), Margin (dB), Remark. Rows include frequencies like 3295.000, 4003.333, 5250.000, 7233.333, 9670.000, 12078.333, 2133.333, 3748.333, 4825.000, 6241.666, 7233.333, 12078.333.

Notes:

- 1. Measuring frequencies from 1 GHz to the 10th harmonic of highest fundamental frequency.
2. Measurements above show only up to 6 maximum emissions noted, or would be lesser if no specific emissions from the EUT are recorded (ie: margin>20dB from the applicable limit) and considered that's already beyond the background noise floor.
3. Radiated emissions measured in frequency above 1000MHz were made with an instrument using Peak detector mode and average detector mode of the emission shown in Actual FS column.
4. Spectrum setting:
a. Peak Setting 1GHz - 26GHz, RBW = 1MHz, VBW = 1MHz, Sweep time = 200 ms.
b. AV Setting 1GH z- 26GHz, RBW = 1MHz, VBW = 10Hz, Sweep time = 200 ms.
5. Freq.(MHz) = Emission frequency in MHz
Reading (dBuV/m) =Uncorrected Analyzer / Receiver Reading
Corr. Factor (dB) = Antenna factor + Cable loss - Amplifier gain
Actual FS (dBuV/m) = Reading (dBuV) + Corr. Factor (dB/m)
Limit (dBuV/m) = Limit stated in standard
Margin (dB) = Actual FS (dBuV/m)- Limit (dBuV/m)
Pk = Peak Reading
AV. = Average Reading
Remark = Mark Peak Reading or Quasi-peak Reading



Operation Mode: TX(CH Mid)
Temperature: 24°C
Humidity: 52% RH

Test Date: March 4, 2011
Tested by: Sunday Hu
Polarity: Ver. / Hor.

Table with 11 columns: Freq. (MHz), Ant. Pol H/V, Peak Reading (dBuV/m), AV Reading (dBuV/m), Ant. / CF (dB), Actual Fs (Peak, AV), Peak Limit (dBuV/m), AV Limit (dBuV/m), Margin (dB), Remark. It contains two groups of data rows for frequencies 1736.666 to 12163.333 MHz.

Notes:

- 1. Measuring frequencies from 1 GHz to the 10th harmonic of highest fundamental frequency.
2. Measurements above show only up to 6 maximum emissions noted, or would be lesser if no specific emissions from the EUT are recorded...
3. Radiated emissions measured in frequency above 1000MHz were made with an instrument using Peak detector mode and average detector mode...
4. Spectrum setting:
a. Peak Setting 1GHz - 26GHz, RBW = 1MHz, VBW = 1MHz, Sweep time = 200 ms.
b. AV Setting 1GH z- 26GHz, RBW = 1MHz, VBW = 10Hz, Sweep time = 200 ms.
5. Freq.(MHz) = Emission frequency in MHz
Reading (dBuV/m) =Uncorrected Analyzer / Receiver Reading
Corr. Factor (dB) = Antenna factor + Cable loss - Amplifier gain
Actual FS (dBuV/m) = Reading (dBuV) + Corr. Factor (dB/m)
Limit (dBuV/m) = Limit stated in standard
Margin (dB) = Actual FS (dBuV/m)- Limit (dBuV/m)
Pk = Peak Reading
AV. = Average Reading
Remark = Mark Peak Reading or Quasi-peak Reading



Operation Mode: TX(CH High)

Test Date: March 4, 2011

Temperature: 24 °C

Tested by: Sunday Hu

Humidity: 52% RH

Polarity: Ver. / Hor.

Freq. (MHz)	Ant. Pol H/V	Peak Reading (dBuV/m)	AV Reading (dBuV/m)	Ant. / CL CF (dB)	Actual Fs		Peak Limit (dBuV/m)	AV Limit (dBuV/m)	Margin (dB)	Remark
					Peak (dBuV/m)	AV (dBuV/m)				
1623.333	V	48.25	---	-10.29	37.96	---	74.00	54.00	-36.04	Peak
4116.666	V	46.04	---	-3.20	42.84	---	74.00	54.00	-31.16	Peak
4910.000	V	45.74	---	-0.30	45.44	---	74.00	54.00	-28.56	Peak
6241.666	V	45.07	---	3.79	48.86	---	74.00	54.00	-25.14	Peak
7375.000	V	49.05	37.86	5.41	54.46	43.27	74.00	54.00	-10.73	AVG.
12276.666	V	46.13	34.33	11.77	57.90	46.10	74.00	54.00	-7.90	AVG.
3266.666	H	48.57	---	-5.35	43.22	---	74.00	54.00	-30.78	Peak
4910.000	H	48.13	---	-0.30	47.83	---	74.00	54.00	-26.17	Peak
6071.666	H	45.55	---	3.25	48.80	---	74.00	54.00	-25.20	Peak
6780.000	H	46.00	---	4.29	50.29	---	74.00	54.00	-23.71	Peak
7375.000	H	49.69	38.09	5.41	55.10	43.50	74.00	54.00	-10.50	AVG.
12276.666	H	48.17	35.29	11.77	59.94	47.06	74.00	54.00	-6.94	AVG.

Notes:

- Measuring frequencies from 1 GHz to the 10th harmonic of highest fundamental frequency.
- Measurements above show only up to 6 maximum emissions noted, or would be lesser if no specific emissions from the EUT are recorded (ie: margin>20dB from the applicable limit) and considered that's already beyond the background noise floor.
- Radiated emissions measured in frequency above 1000MHz were made with an instrument using Peak detector mode and average detector mode of the emission shown in Actual FS column.
- Spectrum setting:
 - Peak Setting 1GHz - 26GHz, RBW = 1MHz, VBW = 1MHz, Sweep time = 200 ms.
 - AV Setting 1GH z- 26GHz, RBW = 1MHz, VBW = 10Hz, Sweep time = 200 ms.
- Freq.(MHz) = Emission frequency in MHz

Reading (dBuV/m) =Uncorrected Analyzer / Receiver Reading

Corr. Factor (dB) = Antenna factor + Cable loss – Amplifier gain

Actual FS (dBuV/m) = Reading (dBuV) + Corr. Factor (dB/m)

Limit (dBuV/m) = Limit stated in standard

Margin (dB) = Actual FS (dBuV/m)- Limit (dBuV/m)

Pk = Peak Reading

AV. = Average Reading

Remark = Mark Peak Reading or Quasi-peak Reading



6.9 POWERLINE CONDUCTED EMISSIONS

LIMIT

For an intentional radiator which is designed to be connected to the public utility (AC) power line, the radio frequency voltage that is conducted back onto the AC power line on any frequency or frequencies within the band 150 kHz to 30 MHz shall not exceed 250 microvolts (The limit decreases linearly with the logarithm of the frequency in the range 0.15 MHz to 0.50 MHz). The limits at specific frequency range is listed as follows:

Frequency Range (MHz)	Limits (dBµV)	
	Quasi-peak	Average
0.15 to 0.50	66 to 56	56 to 46
0.50 to 5	56	46
5 to 30	60	50

Compliance with this provision shall be based on the measurement of the radio frequency voltage between each power line (LINE and NEUTRAL) and ground at the power terminals.

MEASUREMENT EQUIPMENT USED

Conducted Emission Test Site					
Name of Equipment	Manufacturer	Model Number	Serial Number	Last Calibration	Due Calibration
ESCI EMI TEST RECEIVE.ESCI	ROHDE&SCHWARZ	ESCI	100783	03/21/2011	03/21/2012
Attenuator	SCHAFFNER	CFL9206	1711	07/14/2010	07/14/2011
LISN	SCHAFFNER	NNB42	2001/001	05/26/2010	05/26/2011
LISN	EMCO	3825/2	8901-1459	03/21/2011	03/21/2012
Current Probe	STODDART AIRCRAFT	91550-1	345-73	03/21/2011	03/21/2012
Temp. / Humidity Meter	VICTOR	VC230	N/A	03/30/2010	03/30/2011

Remark: Each piece of equipment is scheduled for calibration once a year.



Test Configuration

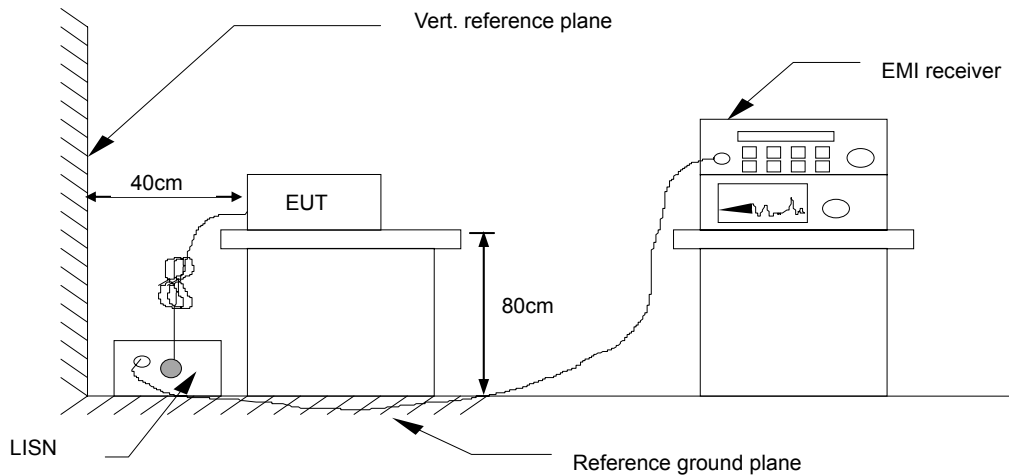

See test photographs attached in Appendix 1 for the actual connections between EUT and support equipment.

TEST PROCEDURE

1. The EUT was placed on a table, which is 0.8m above ground plane.
2. Maximum procedure was performed on the six highest emissions to ensure EUT compliance.
3. Repeat above procedures until all frequency measured were complete.

TEST RESULTS

The initial step in collecting conducted data is a spectrum analyzer peak scan of the measurement range. Significant peaks are then marked as shown on the following data page, and these signals are then quasi-peaked.

Test Data

Not applicable, since the EUT supplied by the battery.