

MERITRC
MT-3D

INSTRUCTION MANUAL



3CH 2.4GHZ FHSS RADIO CONTROL SYSTEM

MT-3D 3-CHANNEL 2.4GHZ RADIO SYSTEM USER'S GUIDE

SERVICE AND SUPPORT

If you have any questions or concerns, we're here to help. If you encounter a problem with your radio control system, please contact us directly.

NO.1058 TAOGAN RD
SHESHAN TOWN
SONGJIANG DISTRICT SHANGHAI

Telephone:+86-21-57793858
Fax:+86-21-57793769
Email:sales@meritrc.com

INTRODUCTION

Congratulations! We appreciate your purchase of the MERITRC MT-3D 2.4GHz radio control system. This Operating Manual is intended to acquaint you with the many unique features of your radio control system. Please read this Operating Manual carefully so that you may obtain maximum success and enjoyment from the operation of your new radio control system. The MT-3D 2.4GHz radio control system has been designed for the utmost in comfort and precise control of all types of model cars and boats. We wish you the best of success and fun with your new purchase.

GENERAL SAFETY

This is a high-output full-range radio control system that should well exceed the range needed for any surface model. For safety, the user should perform a range test at the area of operation to ensure that the radio control system has complete control of the model at the farthest reaches of the operational area. Rather than operating the model, we recommend that the user enlist the help of a fellow modeler to walk the model to the farthest reaches of the track (or for boats, to walk the shore line well in excess of the operational distance of the boat), then test for proper operation.

- 'Safety First' for yourself, for others, and for your equipment. Your model can cause serious damage or injury, so please use caution and courtesy at all times.
- Observe all the rules of the field, track, or lake where you operate your radio control equipment.
- If at any time during the operation of your model, should you feel or observe erratic operation or abnormality, end your operation as quickly and safely as possible. DO NOT operate your model again until you are certain the problem has been corrected. TAKE NO CHANCES.
- Please waterproof the receiver and servos by placing them in a water-tight radio box when operating R/C model boats.
- If you have little to no experience operating R/C models, we recommend you seek the assistance of experienced modelers or your local hobby shop for guidance.
- The Low Voltage Alarm will sound when the transmitter battery voltage drops to 4.2 volts. If this occurs, stop using the transmitter as soon as possible, then replace or recharge the transmitter batteries.

GENERAL SAFETY

This equipment has been tested and found to comply with the limits for a Class B digital device, pursuant to Part 15 of the FCC Rules. These limits are designed to provide reasonable protection against harmful interference in a residential installation. This equipment generates, uses, and can radiate radio frequency energy and, if not installed and used in accordance with the operating instructions, may cause harmful interference to radio communications. However, there is no guarantee that interference will not occur in a particular installation.

If this equipment does cause harmful interference to radio or television reception, which can be determined by turning the equipment off and on, the user is encouraged to try to correct the interference by one or more of the following measures:

- Reorient or relocate the receiving antenna.
- Increase the separation between the equipment and the receiver.
- Connect the equipment into an outlet on a circuit different from that to which the receiver is connected.
- Consult the dealer or an experienced technician for help.

This device complies with Part 15 of the FCC Rules and with RSS-210 of Industry Canada. Operation is subject to the following two conditions:

- 1) This device may not cause harmful interference, and....
- 2) This device must accept any interference received, including

WARNING: Changes or modifications made to this equipment not expressly approved by MERITRC may void the FCC authorization to operate this equipment.

RF Exposure Statement

This transmitter has been tested and meets the FCC RF exposure guidelines when used with the MERITRC accessories supplied or designated for this product, and provided at least 20cm separation between the antenna and the user's body is maintained. Use of other accessories may not ensure compliance with FCC RF exposure guidelines.

MT-3D 3-CHANNEL 2.4GHZ RADIO SYSTEM USER'S GUIDE

SYSTEM FEATURES

- 3-Channel Full-Range 2.4GHz FHSS Digital Proportional Computer Radio for Cars, Trucks and Boats
- 4-Cell Battery Holder for Lighter Weight and Improved Balance
- Easy-to-Read LCD Screen
- 10 Model Memory
- Servo Reversing All Channels
- Dual Rate Steering
- End Point Adjustment All Channels
- Exponential Steering and Throttle
- Anti-Lock (ABS) Braking
- Digital Trim Display
- Servo Sub-Trim Steering and Throttle
- 3-Character Model Naming
- Battery Voltage Monitor
- Battery-Less Memory Retention
- Fail-Safe All Channels
- Low Voltage Alarm

SYSTEM SPECIFICATIONS

Transmitter:

- Model: MT-3D
- Output Power: 100mW
- Nominal Input Voltage: 4.8v ~ 6.0v
- Operating Voltage Range: 4.0v ~ 9.6v
- Dry Weight: 11.64oz (330gr)
- Frequency: 2.4GHz FHSS

Receiver:

- Model: MR-3D
- Nominal Input Voltage: 4.8v ~ 7.4v
- Weight: 0.25oz (7.1gr)
- Dimensions: 1.18 x 1.04 x 0.57in (30.0 x 26.5 x 14.5mm)
- Frequency: 2.4GHz FHSS
- Fail-Safe Support: Yes (All Channels)

FEATURES DESCRIPTIONS

Receiver Antenna Wire: The antenna wire receives the transmitter signal. The antenna wire should be installed through a nylon tube (antenna tube) in the vertical position for the best reception.

Auxiliary Channel 3 Switch: Controls Auxiliary Channel 3 High and Low servo travel.

Battery Compartment: Houses the 4 'AA' Alkaline batteries that power the transmitter.

Bind Button: Used in the process of Binding the transmitter and receiver.

Bind LED: Displays the current status of the transmitter and receiver pair.

LCD Screen: The heart of the programming and display features of the transmitter. All programming and transmitter display functions are shown on the LCD screen.

Programming Keys: The programming keys consist of four different keys - the MENU UP key, the MENU DOWN key, the INCREASE

Steering Dual Rate(D/R): The Dual Rate Keys are used to adjust the Steering Dual Rate quickly and easily during use.

Grip: The Grip is molded in an ergonomic shape for increased comfort, control and feel.

LED Indicator : Indicates that there is Power to the transmitter and Binding .

Power Switch: Turns the transmitter ON and OFF.

Steering Trim Lever (CH1): Used to adjust the center Trim of the Steering servo.

Steering Wheel(CH1): Proportionally operates the model's right and left steering control. The Steering Wheel features a molded grip for increased comfort, control and feel.

Throttle Trigger(CH2): Controls the speed of the model, both forward and backward, or the model's brake.

Throttle Trim Lever (CH2): Used to adjust the center Trim of the Throttle servo.

MT-3D 3-CHANNEL 2.4GHZ RADIO SYSTEM USER'S GUIDE

TRANSMITTER AND RECEIVER DIAGRAMS

Use the diagrams below to familiarize yourself with the different parts of your MT-3D transmitter and MR-3D receiver. Descriptions of these parts can be found in the *Transmitter and Receiver Layout*.

! The transmitter antenna is mounted internally and is located in the front portion of the transmitter. When you're driving your model, hold the transmitter so that it's orientated as close to vertical as possible at all times and try not to 'follow' your model with the transmitter. This provides the best RF signal between the transmitter and the receiver. Do NOT cover the front of the transmitter in any way during use! Doing so can block the RF signal, resulting in the loss of control of your model.

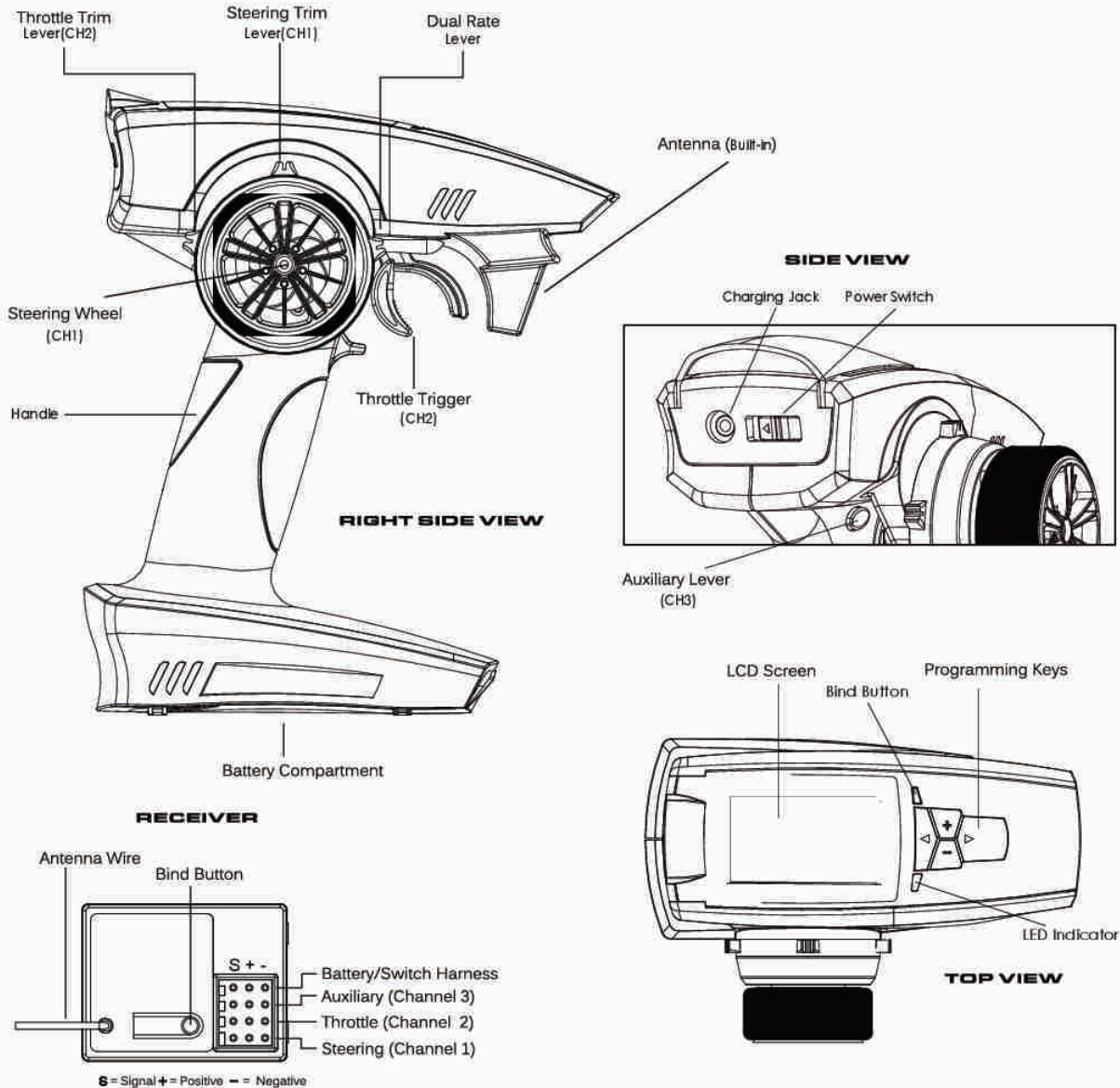

MT-3D 3-CHANNEL 2.4GHZ RADIO SYSTEM USER'S GUIDE

TRANSMITTER LOW VOLTAGE ALARM

The transmitter features a Low Voltage Alarm to warn you when the transmitter batteries need to be replaced or recharged (if using rechargeable batteries). The Low Voltage Alarm will sound when the transmitter batteries reach 4.6 volts. If the Low Voltage Alarm sounds while you are driving, you should stop as soon as it's safe, then replace or recharge the transmitter batteries.

If the Low Voltage Alarm sounds after replacing or recharging the transmitter batteries, there may be a problem with the transmitter.

LCD AND PROGRAMMING KEYS

The transmitter features four Select button keys that are used to facilitate transmitter programming. The programming keys consist of four different keys - the MENU RIGHT key, the MENU LEFT key, the INCREASE key and the DECREASE key. These four keys are used to program the functions of your transmitter, select saved models and change the Modulation Type. This section summarizes the functions of each of the four programming keys, in addition to describing the main areas of the LCD screen.



Model Number: Displays the model that is currently loaded into memory. Up to 10 different models can be stored.



Menu Selections: Displays the available Programming Menus. The currently Active menu will turn on. The information displayed in the Programming Window will vary based on the menu selected.

Programming Window: Displays transmitter programming information. When the transmitter is turned ON, the BATT menu will be selected, the current model number will be shown and the Voltage Monitor will display the transmitter's current voltage.

Voltage Monitor: Displays the current voltage of the transmitter batteries. When the transmitter batteries reach 4.2 volts, the Low Voltage Alarm will sound.

LCD AND PROGRAMMING KEYS

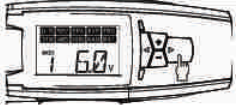
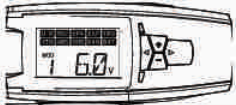
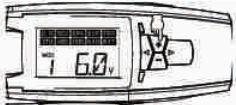
Selecting menus and programming the transmitter is accomplished using the four programming keys.

PROGRAMMING KEY	NAME	FUNCTION
	▶ MENU RIGHT	Cycles down through the list of menus and sub-menu functions you would like to make programming changes to. Press the MENU LEFT and MENU RIGHT keys at the same time to display the Voltage Monitor.
	◀ MENU LEFT	Cycles up through the list of menus and sub-menu functions you would like to make programming changes to. Press the MENU LEFT and MENU RIGHT keys at the same time to display the Voltage Monitor.
	+ INCREASE	Increases Programming Values and used to select models. Press the INCREASE and DECREASE keys at the same time to reset Programming Values to default.
	- DECREASE	Decreases Programming Values and used to select models. Press the INCREASE and DECREASE keys at the same time to reset Programming Values to default.

MT-3D 3-CHANNEL 2.4GHZ RADIO SYSTEM USER'S GUIDE

TRANSMITTER BATTERY INSTALLATION

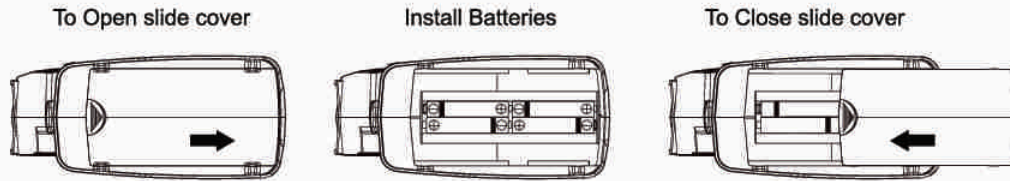

1. Press down on the battery cover and slide in the direction of the arrow to remove.
2. Install 4 AA alkaline cells (or Ni-Cd, or Ni-MH) as indicated inside the battery compartment. Make sure to match the polarity (+ and -) as shown in the battery compartment or the transmitter will not function.
3. Install the battery cover in place and slide to close.

WARNING: Improper installation of transmitter batteries can cause serious damage to your system.

RECEIVER CONNECTIONS AND MOUNTING

Use the diagram below to familiarize yourself with how to connect the switch harness, servos (available separately), and the 4 cell battery holder to your **MR-3D** 3-Channel receiver.

- 1) Install four fresh 'AA' Alkaline batteries into the battery holder, making sure that the polarity is correct. The direction that each battery should be installed is molded into the battery holder (+ Positive and - Negative).

 The **MR-3D** 3-Channel receiver's Nominal Input Voltage is 3.6v~7v, therefore, the receiver can be powered using a 4 or 5 cell Ni-Cd or Ni-MH battery pack (available separately).

- We suggest Binding the transmitter and receiver and setting the Fail Safe position, prior to mounting the receiver in your model.

- The receiver should be mounted as far away from any electrical components as possible.
- Route the antenna wire up through a plastic tube so that it is in the vertical position.
- To protect the receiver from vibration and other damage, we recommend wrapping the receiver in shock absorbing foam rubber when installing it in your model.

 Set your model on a stand so the wheels are off the ground before turning on your radio control system or connecting your motor for the first time.

 The receiver does not feature BEC circuitry. If using an electronic speed control, verify that it features BEC circuitry to drop the receiver voltage between 3.6v~7v.

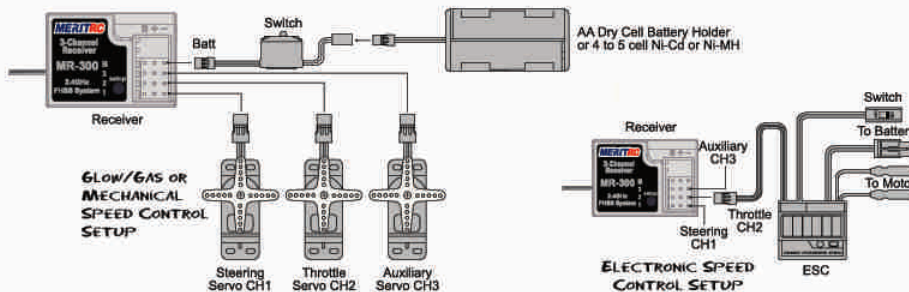
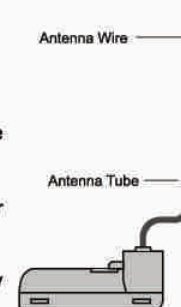

MT-3D 3-CHANNEL 2.4GHZ RADIO SYSTEM USER'S GUIDE

RECEIVER'S ANTENNA INSTALLATION

The wave length of the 2.4GHz is much shorter than that of the conventional frequencies, it is very susceptible to loss of signal which results in a receiving error.

To obtain the best results, please refer to the following instructions;

- 1.The antenna must be kept as straight as possible. Otherwise it will reduce the effective range.
- 2.The antenna should be perpendicular to the model. Larger models can have large metal objects that can attenuate the RF signal. In this case the antennas should be placed at sides of the model. Then the best RF signal condition is obtained at any attitude.
- 3.The antennas must be kept away from conductive materials, such as metal and carbon by at least a half inch. The coaxial part of the antennas does not need to follow these guidelines, but do not bend it in a small radius.
- 4.Keep the antennas away from the motor, ESC, and other noise sources as much as possible.

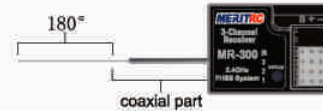

*The main purpose of the photo demonstrates how the antenna should be placed. For actual installation the receiver must be wrapped with a sponge or placed with floating material to protect it from vibration.

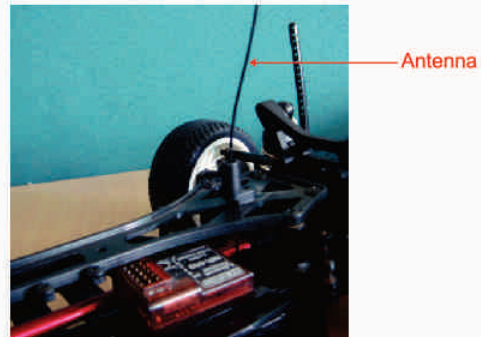

The receiver contains precision electronic parts. It is the most delicate radio component on-board the model and should be protected from vibration, shock and temperature extremes. To protect the receiver, wrap it in R/C foam rubber or other vibration-absorbing material. If appropriate, waterproof the receiver by placing it in a plastic bag and closing the open end with a rubber band before wrapping it in foam. If moisture enters the receiver, intermittent operation or a failure may result. Wrapping the receiver in a plastic bag also protects it from fuel and exhaust residue which, in some models, can work its way into the model.

MT-3D 3-CHANNEL 2.4GHZ RADIO SYSTEM USER'S GUIDE

TRANSMITTER AND RECEIVER BINDING

The Binding function allows you to Bind the transmitter and receiver pair. When new, it is necessary to pair the transmitter and receiver to prevent interference from radio controllers operated by other users. This operation is referred to as 'binding'. Once the binding process is complete, the setting is remembered even when the transmitter and receiver are turned OFF. Therefore, this procedure usually only needs to be done once.

 Before beginning the binding process, connect the switch harness, servos, and the receiver battery to your MR-3D 3-Channel receiver, using the diagram on page 5. Make sure that both the transmitter and the receiver are turned OFF.

- 1) Turn the transmitter ON. The Power Indicator on the transmitter will illuminate solid red.
- 2) Press and hold the receiver setup button, then turn the power switch on the ON position. The receiver LED will flash quickly. Release the setup button after 1 second.



- 3) Press and hold the binding button on the transmitter for 1 second until the LED on the receiver is continuously lit.

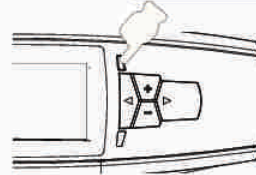

 When the binding process is successful, the Bind LED on the receiver will stay solid red when both the transmitter and receiver are turned ON. If the Bind LED on the receiver is flashing rapidly or not illuminated at all, the transmitter and receiver are not paired. In this case, turn both the transmitter and receiver OFF, then repeat the binding process.

 Under some circumstances, the receiver may not operate after turning the transmitter and receiver ON. If this occurs, perform the binding process again.

FAIL SAFE SETUP

Please note the setup must be based on pair procedure well.

1. Turn the power switch on the transmitter & receiver to the ON position, the LED on transmitter & receiver are continuously lit.
2. Move the steering wheel or throttle trigger to the position where you want the servo to move, press and hold the receiver setup button for 2 second until the red LED on the receiver flash slowly, then press and hold the receiver setup button again within 5 seconds (Note: after 5 seconds F/S setup will reset, you have to start over at step one above) until the receiver LED is continuously lit, that's mean the F/S function has been correctly set.
3. Verify if the failsafe function has been correctly set. Turn off the transmitter, then check if the servos moves to the position that you set.
4. Any new binding (pair procedure) will clear the preset Fail-Safe.

MT-3D 3-CHANNEL 2.4GHZ RADIO SYSTEM USER'S GUIDE

D/R - DUAL RATE

Use this function to adjust the steering travel of your model. If the model understeers while cornering, add steering by pressing the lower side of the D/R button. When the model oversteers, take away steering by pressing the upper side of the D/R button.

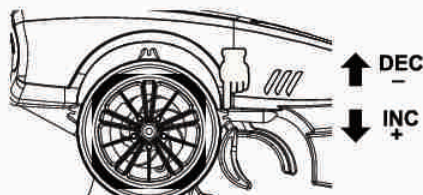

Adjusting the Steering Dual Rate Percentage Value:

- 1) Press the MENU RIGHT or MENU LEFT keys to open the D/R menu. D/R will ON and ST 100% will be displayed.

RANGE	30~100%	
DEFAULT	100%	
INC +	+1%	D/R +Lever
DEC -	-1%	D/R -Lever
INC+DEC	100%	✕ D/R Lever can be operated even from an external menu.

◀+▶ (1)BAT MENU

- 2) Press the + or - keys to change the Steering Dual Rate percentage value. When the Steering Dual Rate percentage value is decreased, steering servo travel is decreased. When the Steering Dual Rate percentage value is increased, steering servo travel is increased.

D/R ST setting range is 30% to 100%. The default setting is 100%.

- 3) Steering Dual Rate can be adjusted at any time while driving using the Dual Rate Switch. D/R press the Dual Rate Switch forward to increase the Steering Dual Rate percentage value and press the Dual Rate Switch backward to decrease the Steering Dual Rate percentage value.



REV - SERVO REVERSING

The Servo Reversing function allows you to switch the direction of servo travel. The Servo Reversing function can be adjusted for the Steering channel, Throttle channel and Auxiliary channel 3.

⚠ When you change the direction of Steering or Throttle servo travel, the servo horn may no longer be centered. If this occurs, use the Servo Sub-Trim function to center the servo horn(s). For more information, see the Servo Sub-Trim section above and on the previous page.

Changing the Servo Reversing Values:

- 1) Press the MENU RIGHT or MENU LEFT keys to open the REV menu. REV will ON and ST NOR will be displayed.
- 2) Press the MENU RIGHT or MENU LEFT keys to choose which channel you would like to change the Servo Reversing value for, then press the INCREASE or DECREASE keys to change the direction of servo travel.

REV setting range is NOR and REV. The default setting for all channels is NOR.

RANGE	NOR、REV
INC +	NOR→REV→NOR→...
DEC -	NOR→REV→NOR→...
INC+DEC	NOR

◀+▶ (1)BAT MENU



MT-3D 3-CHANNEL 2.4GHZ RADIO SYSTEM USER'S GUIDE

EPA - END POINT ADJUSTMENT

The End Point Adjustment function allows you to adjust servo travel in each direction. This makes it possible to balance servo travel in both directions and set the maximum desired amount of servo travel.

The End Point Adjustment function can be adjusted for the Steering channel (Left and Right), the Throttle channel (Forward and Brake) and Auxiliary Channel 3 (High and Low).

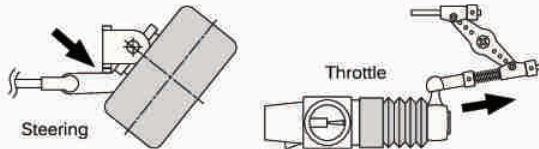

⚠ If you're using an electronic speed control, the Throttle Forward and the Throttle Brake End Point Adjustment percentage values are both generally set to 100%, although the Throttle Forward direction may need to be increased to achieve full power. In some cases the End Point Adjustments can also be set directly via the electronic speed control.

WARNING: End Point Adjustment percentage values should not be increased to the point where your linkages and/or servos bind when moved all the way in either direction. Binding will cause the servos to 'buzz', draining the receiver battery quickly and eventually damaging the servos.

EPA - END POINT ADJUSTMENT

Adjusting the Steering End Point Adjustment Percentage Values:

Your model's turning radius can differ from left to right because of variations in linkage, suspension balance, tire diameter or weight distribution. In such cases, Left Steering servo travel and Right Steering servo travel are adjustable using the End Point Adjustment function.

- 1) Press the MENU RIGHT or MENU LEFT keys to open the EPA menu. EPA will ON and ST L or ST R 100% will be displayed.

RANGE	0-150%
DEFAULT	100%
INC	+1%
DEC	-1%
INC+DEC	100%
◀▶	(1)BAT MENU



- 2) Rotate the steering wheel to the left and release it. ST L should be displayed. Press the + or - keys to increase or decrease the Steering Left End Point Adjustment percentage value. Increasing the percentage value will increase steering servo travel in that direction and decreasing the percentage value will decrease steering servo travel in the that direction.

EPA ST L setting range is 0% to 150%. The default setting is 100%.



- 3) Rotate the steering wheel to the right and release it. ST R should be displayed. Press the + or - keys to increase or decrease the Steering Right End Point Adjustment percentage value. Increasing the percentage value will increase steering servo travel in that direction and decreasing the percentage value will decrease steering servo travel in the that direction.

EPA ST R setting range is 0% to 150%. The default setting is 100%.



MT-3D 3-CHANNEL 2.4GHZ RADIO SYSTEM USER'S GUIDE

Adjusting Throttle End Point Adjustment:

Your model's carburetor may not open completely or it may open too much and cause the throttle servo to bind. If you're using an electronic speed control, the electronic speed control may not command full power or the brake may not engage adequately. In such cases, Throttle Forward servo travel and Throttle Brake servo travel can be independently adjusted using the End Point Adjustment function.

- 1) From within the EPA menu, press the MENU RIGHT or MENU LEFT keys to display TH F or TH B 100%.

RANGE 0-150%
 DEFAULT 100%
 INC + +1%
 DEC - -1%
 INC+DEC 100%

◀▶ (1)BAT MENU



- 2) Pull the throttle trigger and release it. TH F should be displayed. Press the + or - keys to increase or decrease the Throttle Forward End Point Adjustment percentage value. Increasing the percentage value will increase throttle servo travel in that direction and decreasing the percentage value will decrease throttle servo travel in the that direction.



EPA TH F setting range is 0% to 150%. The default setting is 100%.



- 3) Push the throttle trigger and release it. TH B should be displayed. Press the + or - keys to increase or decrease the Throttle Brake End Point Adjustment percentage value. Increasing the percentage value will increase throttle servo travel in that direction and decreasing the percentage value will decrease throttle servo travel in the that direction.



EPA TH B setting range is 0% to 150%. The default setting is 100%.



EPA - END POINT ADJUSTMENT

Adjusting the Auxiliary Channel 3 End Point Adjustment Percentage Values:

Auxiliary Channel 3 can be used for a number of different uses.

- 1) From within the EPA menu, press the MENU UP or MENU DOWN keys to display AUX H or AUX L 100%.

RANGE 0-150%
 DEFAULT 100%
 INC + +1%
 DEC - -1%
 INC+DEC 100%

◀▶ (1)BAT MENU



- 2) Push the Auxiliary Lever down. AUX L or H should be displayed. Press the + or - keys to increase or decrease the Auxiliary Low End Point Adjustment percentage value. Increasing the percentage value will increase auxiliary servo travel in that direction and decreasing the percentage value will decrease auxiliary servo travel in the that direction.



EPA AUX R setting range is 0% to 150%. The default setting is 100%.



MT-3D 3-CHANNEL 2.4GHZ RADIO SYSTEM USER'S GUIDE

EXP - EXPONENTIAL

The Exponential function allows you to vary the amount of servo travel in relation to the movement of the steering wheel and throttle trigger near the Neutral positions to change the way those functions react to control movement. Decreasing the Exponential percentage values will soften the control feel around Neutral and increasing the Exponential percentage values will heighten the control feel around Neutral. Using a lower negative value allows for smoother control. Using a higher positive value may result in more 'twitchy' control response.

The Exponential function can be adjusted for the Steering channel and the Throttle channel.

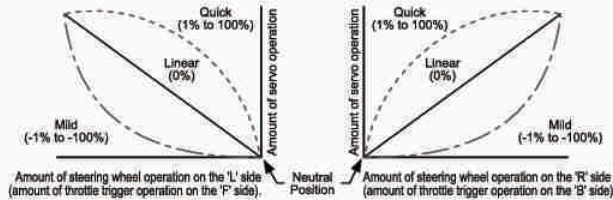

Adjusting the Steering Exponential Percentage Value:

Steering Exponential can be variably adjusted from Mild through Linear to Quick to allow you to set the most effective steering response for your model.

- 1) Press the MENU RIGHT or MENU LEFT keys to open the EXP menu. EXP will ON and ST 0% will be displayed.

RANGE -100--100%
 DEFAULT 0%
 INC + +1%
 DEC - -1%
 INC+DEC 0%
 ◀▶ (1)BAT MENU



Adjusting the Steering Exponential Percentage Value, Continued:

- 2) Press the + or - keys to change the Steering Exponential percentage value. Decreasing the Steering Exponential percentage value will make the steering less sensitive around Neutral and increasing the Steering Exponential percentage value will make the steering more sensitive around Neutral.



EXP ST setting range is -100% (Mild) to 100% (Quick). The default setting is 0% (Linear).

Adjusting the Throttle Exponential Percentage Value:

Throttle Exponential can be variably adjusted from Mild through Linear to Quick. In general, reduce the Exponential percentage value on a slippery track or with a model that has a higher-torque motor or engine to help prevent your model from spinning out during acceleration. Increase the Exponential percentage value on a high-grip track where your model is less likely to spin out, or with a model that has a lower-torque motor or engine.

- 1) From within the EXP menu, press the MENU RIGHT or MENU LEFT keys to display TH 0%.

RANGE -100--100%
 DEFAULT 0%
 INC + +1%
 DEC - -1%
 INC+DEC 0%
 ◀▶ (1)BAT MENU

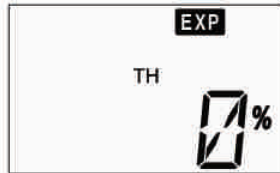

- 2) Press the + or - keys to change the Throttle Exponential percentage value. Decreasing the Throttle Exponential percentage value will make the throttle less sensitive around Neutral and increasing the Throttle Exponential percentage value will make the throttle more sensitive around Neutral.

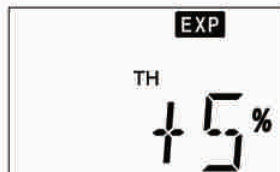

MT-3D 3-CHANNEL 2.4GHZ RADIO SYSTEM USER'S GUIDE

TRM - SERVO TRIM

The Servo Trim function allows you to view the currently programmed Servo Trim value for the steering and throttle channels and, if desired, allows you to change the Trim values from within the TRM menu, using the programming keys.

The transmitter features Digital Trim Memory. Any amount of Steering or Throttle Trim that you set during use by pressing the Trim Switches or using the TRM menu is automatically stored in memory for that specific channel and for that specific Model Number. The Trim values for each model will automatically be loaded when the transmitter is turned ON.

⚠ Before adjusting the Trim values, you should first adjust the servo Sub-Trim values to center the servo horns.

⚠ The Servo Trim function should not be used to center the steering and throttle servos. Use the Servo Sub-Trim function for that. The Servo Trim function is used to make trim adjustments to your model during use. For example, if your models always pulls to the left while driving, apply enough Steering Right Trim to make you model drive straight.

Changing the Steering Servo Trim Values:

- 1) Press the MENU RIGHT or MENU LEFT keys to open the TRM menu. TRM will ON and ST 0 will be displayed.

RANGE L25-0-R25
 DEFAULT 0
 INC + +1(R direction)
 DEC - -1(L direction)
 INC+DEC 0

L 1
 R 25

✳ TRIM LEVEL can be operated even from an external menu.

- 2) Press the + or - keys to adjust the Steering Servo Trim value either Right or Left. The actual direction will differ based on the steering channel's Servo Reversing setting.

TRIM ST setting range is R25 to L25. The default setting is 0.



Changing the Throttle Servo Trim Values:

- 1) From within the TRIM menu, press the MENU UP or MENU DOWN keys to display TH 0.

RANGE B25-0-F25
 DEFAULT 0
 INC + +1(F direction)
 DEC - -1(B direction)
 INC+DEC 0

F 1
 B 25

✳ TRIM KEY can be operated even from an external menu.

- 2) Press the INCREASE or DECREASE keys to adjust the Throttle Servo Trim value either Forward or Brake. The direction will differ based on the throttle channel's Servo Reversing setting.

TRIM TH setting range is F25 to B25. The default setting is 0.

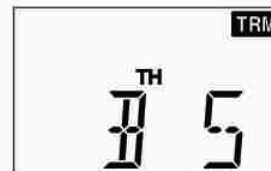

Controlling the Servo Trim Function:

- 1) Steering and Throttle Servo Trim can be adjusted at any time while driving. Trim Switch CH1 controls the Steering Right and Left Servo Trim and Trim Switch CH2 controls the Throttle Forward and Brake Servo Trim. When you press the Trim Switches, the Servo Trim values change in 1° increments.

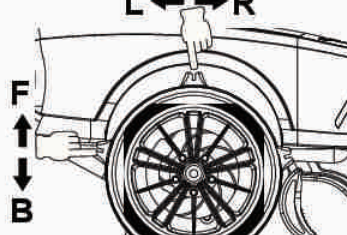

⚠ Each time you press a Trim Switch a single audible tone is heard and the Servo Trim value will be displayed on the LCD screen for approximately 5 seconds, then revert to the last menu you were in.

⚠ Pressing the INCREASE and DECREASE keys at the same time will NOT reset the Servo Trim values to zero, since there is no 'default' Servo Trim setting.

MT-3D 3-CHANNEL 2.4GHZ RADIO SYSTEM USER'S GUIDE

STM - SERVO SUB-TRIM

 After adjusting the Servo Sub-Trim values, use the End Point Adjustment function to set the desired amount of maximum servo travel in both directions.

Changing the Steering Servo Sub-Trim Value:

- 1) Press the MENU RIGHT or MENU LEFT keys to open the STM menu. STM will ON and ST.0 will be displayed.

RANGE L25~0~R25
 DEFAULT 0
 INC + +1(R direction)
 DEC - -1(L direction)
 INC+DEC 0

◀▶ (1)BAT MENU

L 1
R 25



- 2) Press the + or - keys to adjust the Steering Servo Sub-Trim value either Right or Left to center the servo horn (or servo saver). The direction will differ based on the steering channel's Servo Reversing setting.

STM ST setting range is R25 to L25. The default setting is 0.



Changing the Throttle Servo Sub-Trim Value:

- 1) From within the STM menu, press the MENU RIGHT or MENU LEFT keys to display TH.0.

RANGE B25~0~F25
 DEFAULT 0
 INC + +1(F direction)
 DEC - -1(B direction)
 INC+DEC 0

◀▶ (1)BAT MENU

F 1
B 25

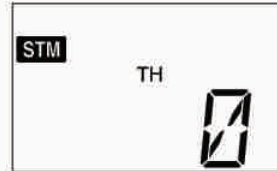

- 2) Press the + or - keys to adjust the Throttle Servo Sub-Trim value either Forward or Brake to center the servo horn (or adjust it's Neutral point). The direction will differ based on the steering channel's Servo Reversing setting.

STM TH setting range is F25 to B25. The default setting is 0.



ABS - ANTI-LOCK BRAKING

The Anti-Lock Braking function makes it possible to achieve stable braking even on a slippery surface. With stable braking, your model is better able to trace an exact line under braking. When the Anti-Lock Braking function is Active, the throttle servo will pulse when you apply brake. Three Pulse Rate values are available to suit your particular model, track conditions and driving style.

 The Anti-Lock Braking function is primarily used on gasoline or glow (nitro) models that feature a throttle servo. It can be used on an electric model that uses an electronic speed control, however, if your electronic speed control features a reverse function, the Anti-Lock Braking function will not operate properly.

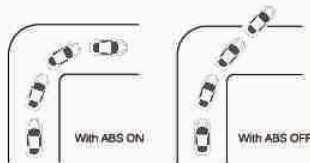

 Use the fastest Pulse Rate value that allows your model's tires to not slip and loose traction under the hardest braking. Be aware that using the Anti-Lock Brake function will never result in your model losing traction under braking. It only improves braking under less than ideal conditions.

Activating the Anti-Lock Braking Function:

- 1) Press the MENU RIGHT or MENU LEFT keys to open the ABS menu. ABS will flash and TH OFF will be displayed.

DEFAULT OFF
 INC+DEC OFF

◀▶ (1)BAT MENU



MT-3D 3-CHANNEL 2.4GHZ RADIO SYSTEM USER'S GUIDE

ABS-ANTI-LOCK BRAKING

Activating the Anti-Lock Braking Function, Continued:

- 2) Press the + or - keys to choose the desired Anti-Lock Braking Pulse Rate value. The Pulse Rate value determines how fast the throttle servo pulsates the brake. Experimentation will be necessary to determine which Pulse Rate value to use.



ABS setting range is OFF, SLW (Slow), MID (Middle) and FST (Fast). The default setting is OFF.

! Due to the nature of the Anti-Lock Braking function, we suggest using a high-quality, strong throttle servo. If your throttle servo is not strong enough, the Anti-Lock Braking function may not operate optimally.

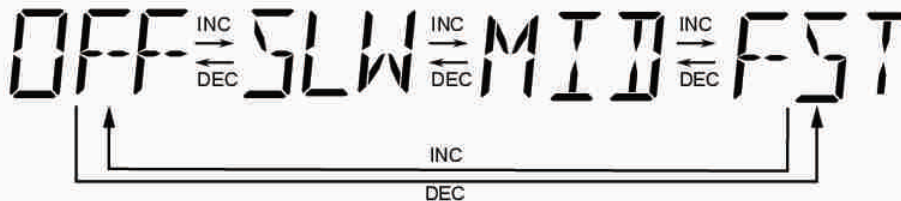

MOD - MODEL SELECT

The Model Select function allows you to store and retrieve Programming Data for any model 0 through 9. If you're using your transmitter with more than one model, use the Model Select function to load the Programming Data for the particular model that you wish to drive. The currently selected Model Number is displayed next to the Voltage Monitor.

WARNING: Model Programming Data changes immediately upon selection. Do not attempt to select a different model when your model's receiver is turned ON under actual operational conditions. You may lose control of your model or the servos may be damaged.

Selecting a Model:

- 1) Press the MENU RIGHT or MENU LEFT keys to open the MOD menu. MOD will ON and MODEL S01 will be displayed.

RANGE MODEL0~MODEL9
INC +1MODEL
DEC -1MODEL
INC+DEC 0

◀+▶ (1)BAT MENU

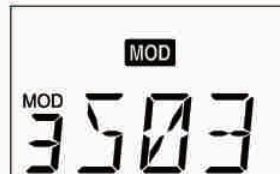
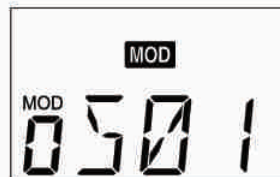

- 2) Press the + or - keys to select the desired Model Number.

MT-3D 3-CHANNEL 2.4GHZ RADIO SYSTEM USER'S GUIDE

NAM - MODEL NAMING

The Model Naming function allows you to name each of the 10 different models. This makes it easy to keep track of multiple models. The Model Name can consist of up to 3 upper-case letters, numbers or symbols, or a combination of all three.

 Before naming your model, use the Model Select function to choose the Model Number you would like to name. For more information, see the *Model Select* section on page 16.

Changing the Model Name:

- 1) Press the MENU RIGHT or LEFT DOWN keys to open the MAM menu. NAM will ON and MODEL S01 will be displayed.
- 2) Turn the steering wheel right or left to select the character you would like to change. The currently selected character will flash.
- 3) Press the INCREASE or DECREASE keys to select the desired character.
- 4) Repeat steps 2 and 3 to change any desired remaining characters.

RANGE	0~9, A~Z, +, -, *, /		
INC	0→1→...→*→/→0...	CURSOR MOVE(LEFT)	L STEERING
DEC	/→*→...→1→0→/...		R STEERING
INC+DEC	0	CURSOR MOVE(RIGHT)	
◀+▶	(1)BAT MENU	✳ MOVE CURSOR ONE BY ONE (RETURN STEERING TO NEUTRAL)	



BLINK SPEED 0.5sec ON,
0.5sec OFF, 0.5sec ON...

BAT - VOLTAGE MONITOR

The Voltage Monitor function displays the transmitter's battery voltage in 0.1 volt increments. The current model number is also displayed.

 A Low Voltage Alarm warns you when the transmitter batteries need to be replaced or recharged (if using rechargeable batteries). The Low Voltage Alarm will sound when the transmitter batteries reach 4.6 volts. If the Low Voltage Alarm sounds while you are driving, you should stop as soon as it's safe, then replace or recharge the transmitter batteries.

Viewing the Transmitter Battery Voltage:

- 1) Press the MENU RIGHT or MENU LEFT keys to open the BATT menu. BAT will flash and the current model number, along with the transmitter batteries' voltage, will be displayed.



 The BATT menu is the transmitter's default menu. Each time the transmitter is turned ON, the BATT menu will be displayed. In addition, the BATT menu can be displayed at any time from within any other menu by pressing the MENU RIGHT and MENU LEFT keys at the same time.

MODULATION TYPE

The transmitter's Modulation Type can be changed to match the receiver you're using.

Changing the Modulation Type:

- 1) With the transmitter OFF, press and HOLD the MENU RIGHT key, then turn the transmitter ON. The current Modulation Type will be displayed.



- 2) Press the + or - keys to change the Modulation Type to one that matches the Modulation Type of your receiver. Choose from the following Modulation Types: FHS, FFHS.

- 3) Turn the transmitter OFF, then turn it back ON.

 FFHS Type are used in France.

FCC INFORMATION

This device complies with Part 15 of the FCC Rules. Operation is subject to the following two conditions:

1. This device may not cause harmful interference, and 2. This device must accept any interference received, including interference that may cause undesired operation.

Note: This equipment has been tested and found to comply with the limits for a Class B digital device, pursuant to part 15 of the FCC Rules. These limits are designed to provide reasonable protection against harmful interference in a residential installation. This equipment generates, uses and can radiate radio frequency energy and, if not installed and used in accordance with the instructions, may cause harmful interference to radio communications. However, there is no guarantee that interference will not occur in a particular installation. If this equipment does cause harmful interference to radio or television reception, which can be determined by turning the equipment off and on, the user is encouraged to try to correct the interference by one or more of the following measures:

- Reorient or relocate the receiving antenna.
- Increase the separation between the equipment and receiver.
- Connect the equipment into an outlet on a circuit different from that to which the receiver is connected.
- Consult the dealer or an experienced radio/TV technician for help.

Caution: Any changes or modifications not expressly approved by the party responsible for compliance could void the user's authority to operate this equipment.

RF Exposure: This equipment complies with FCC radiation exposure limits set forth for an uncontrolled environment. This transmitter must not be colocated or operating in conjunction with any other antenna or transmitter.

NCC Warning Statement

Article 12

Without permission, any company, firm or user shall not alter the frequency, increase the

power, or change the characteristics and functions of the original design of the certified lower power frequency electric machinery.

Article 14

The application of low power frequency electric machineries shall not affect the navigation safety nor interfere a legal communication, if an interference is found, the service will be suspended until improvement is made and the interference no longer exists.

MERITRC

上海美利达电子科技有限公司

SHANGHAI MERIT TECHNOLOGY CORP.

ADD:NO. 1058 TAOGAN RD., SHESHAN TOWN,
SONGJIANG DISTRICT SHANGHAI

TEL : +86-21-57793858

FAX: +86-21-57793769

<http://www.meritrc.com>

E-mail:sales@meritrc.com