



FCC 47 CFR PART 15 SUBPART C

TEST REPORT

For

8CH 2.4GHZ FHSS RADIO CONTROL SYSTEM

Model: MT-800

Brand: MERITRC

Test Report Number:

C150928Z01-RP1

Prepared for

Shanghai Merit Technology Corporation.

1058 Taogan road, Sheshan, Songjiang District, Shanghai, China.

Prepared by

COMPLIANCE CERTIFICATION SERVICES (SHENZHEN) INC.

**No.10-1, Mingkeda Logistics Park, No.18, Huanguan South Rd.,
Guan Lan Town, Baoan District, Shenzhen China**

TEL: 86-755-28055000

FAX: 86-755-28055221

E-Mail: service@ccssz.com

Issued Date: November 11, 2015



Note: This report shall not be reproduced except in full, without the written approval of Compliance Certification Services (Shenzhen) Inc. This document may be altered or revised by Compliance Certification Services (Shenzhen) Inc. personnel only, and shall be noted in the revision section of the document. The client should not use it to claim product endorsement by TAF, A2LA, NVLAP, NIST or any government agencies. The test result of this report relate only to the tested sample identified in this report.



Revision History

Rev.	Issue Data	Revisions	Effect Page	Revised By
00	November 11, 2015	Initial Issue	ALL	Sinphy Xie



TABLE OF CONTENTS

1. TEST RESULT CERTIFICATION4

2. EUT DESCRIPTION.....5

3. TEST METHODOLOGY6

 3.1 DESCRIPTION OF TEST MODES6

4. FACILITIES AND ACCREDITATIONS7

 4.1 FACILITIES7

 4.2 ACCREDITATIONS.....7

 4.3 MEASUREMENT UNCERTAINTY7

5. SETUP OF EQUIPMENT UNDER TEST8

 5.1 SETUP CONFIGURATION OF EUT8

 5.2 SUPPORT EQUIPMENT8

6. FCC PART 15.247 REQUIREMENTS9

 6.1 20DB BANDWIDTH9

 6.2 ANTENNA GAIN12

 6.3 PEAK POWER.....13

 6.4 PEAK POWER SPECTRAL DENSITY15

 6.5 BAND EDGES MEASUREMENT16

 6.6 FREQUENCY SEPARATION24

 6.7 NUMBER OF HOPPING FREQUENCY26

 6.8 TIME OF OCCUPANCY (DWELL TIME).....28

 6.9 SPURIOUS EMISSIONS.....32

 6.10 POWERLINE CONDUCTED EMISSIONS44



1. TEST RESULT CERTIFICATION

Product:	8CH 2.4GHz FHSS RADIO CONTROL SYSTEM
Model:	MT-800
Brand:	MERITRC
Tested:	September 28~ November 11, 2015
Applicant:	Shanghai Merit Technology Corporation. 1058 Taogan road, Sheshan, Songjiang District, Shanghai, China.
Manufacturer:	Shanghai Merit Technology Corporation. 1058 Taogan road, Sheshan, Songjiang District, Shanghai, China.

APPLICABLE STANDARDS	
STANDARD	TEST RESULT
FCC 47 CFR Part 15 Subpart C	No non-compliance noted

We hereby certify that:

The above equipment was tested by Compliance Certification Services (Shenzhen) Inc. The test data, data evaluation, test procedures, and equipment configurations shown in this report were made in accordance with the procedures given in ANSI C63.10:2013 and the energy emitted by the sample EUT tested as described in this report is in compliance with conducted and radiated emission limits of FCC Rules Part 15.207, 15.209 and 15.247.

The test results of this report relate only to the tested sample EUT identified in this report.

Approved by:

Sunday Hu
Supervisor of EMC Dept.
Compliance Certification Service (Shenzhen)
Inc.

Reviewed by:

Ruby Zhang
Supervisor of Report Dept.
Compliance Certification Service (Shenzhen)
Inc.



2. EUT DESCRIPTION

Product	8CH 2.4GHz FHSS RADIO CONTROL SYSTEM
Model Number	MT-800
Brand	MERITRC
Model Discrepancy	N/A
Identify Number	C150928Z01-RP1
Power Supply	DC6V supplied by the battery or DC6V supplied by the adapter
Received Date	September 28, 2015
Frequency Range	2405-2455MHz
Transmit Power	Peak: 17.73dBm Average : 13.67dBm
Modulation Technique	FHSS
Number of Channels	51 Channels
Antenna Specification	Dipole Antenna with 2dBi (Max)
Temperature Range	0°C ~ +60°C
Hardware Version	V1.0
Software Version	V1.0

Note: This submittal(s) (test report) is intended for FCC ID: XJ6MT-800 filing to comply with Section 15.207, 15.209 and 15.247 of the FCC Part 15, Subpart C Rules.



3. TEST METHODOLOGY

3.1 DESCRIPTION OF TEST MODES

The EUT has been tested under operating condition.

Test program used to control the EUT for staying in continuous transmitting and receiving mode is programmed.

The following test mode(s) were scanned during the preliminary test below 1G:

Test Item	Test mode	Worse mode
Conducted Emission	Mode 1: TX	<input checked="" type="checkbox"/>
Radiated Emission	Mode 1: TX	<input checked="" type="checkbox"/>

Above 1G, Channel Low (2405MHz) · Mid (2430MHz) and High (2455MHz) were chosen for full testing for GFSK.



4. FACILITIES AND ACCREDITATIONS

4.1 FACILITIES

All measurement facilities used to collect the measurement data are located at

- No.10-1, Mingkeda Logistics Park, No.18, Huanguan South Rd., Guan Lan Town, Baoan District, Shenzhen, China

The sites are constructed in conformance with the requirements of ANSI C63.10:2013, ANSI C63.7 and CISPR Publication 22. All receiving equipment conforms to CISPR Publication 16-1, "Radio Interference Measuring Apparatus and Measurement Methods."

4.2 ACCREDITATIONS

Our laboratories are accredited and approved by the following accreditation body according to ISO/IEC 17025.

USA	A2LA
China	CNAS

The measuring facility of laboratories has been authorized or registered by the following approval agencies.

USA	FCC
Japan	VCCI(C-3478, R-3135, T-652, G-10624)
Canada	INDUSTRY CANADA

Copies of granted accreditation certificates are available for downloading from our web site, <http://www.ccssz.com>

4.3 MEASUREMENT UNCERTAINTY

Where relevant, the following measurement uncertainty levels have been estimated for tests performed on the EUT as specified in CISPR 16-4-2:

Parameter	Uncertainty
Radiated Emission, 30 to 200 MHz Test Site : 966(2)	+/-3.6880dB
Radiated Emission, 200 to 1000 MHz Test Site : 966(2)	+/-3.6695dB
Radiated Emission, 1 to 8 GHz	+/-5.1782dB
Radiated Emission, 8 to 18 GHz	+/-5.2173dB
Conducted Emissions	+/-3.6836dB
Band Width	178kHz
Peak Output Power MU	+/-1.906dB
Band Edge MU	+/-0.182dB
Channel Separation MU	416.178Hz
Duty Cycle MU	0.054ms
Frequency Stability MU	226Hz

This uncertainty represents an expanded uncertainty expressed at approximately the 95% confidence level using a coverage factor of k=2.

The measured result is above (below) the specification limit by a margin less than the measurement uncertainty; it is therefore not possible to state compliance based on the 95% level of confidence. However, the result indicates that compliance (non-compliance) is more probable than non-compliance) with the specification limit.



5. SETUP OF EQUIPMENT UNDER TEST

5.1 SETUP CONFIGURATION OF EUT

See test photographs attached in Appendix 1 for the actual connections between EUT and support equipment.

5.2 SUPPORT EQUIPMENT

No.	Equipment	Model No.	Serial No.	FCC ID	Brand	Data Cable	Power Cord
1	Adapter	CS12B060100 FG	N/A	N/A	CSEC	N/A	Unshielded 1.5m
2	Battery*4	N/A	N/A	N/A	N/A	N/A	N/A

Notes:

Grounding was established in accordance with the manufacturer's requirements and conditions for the intended use.



6. FCC PART 15.247 REQUIREMENTS

6.1 20DB BANDWIDTH

None; for reporting purpose only.

MEASUREMENT EQUIPMENT USED

Name of Equipment	Manufacturer	Model	Serial Number	Last Calibration	Due Calibration
Spectrum Analyzer	Agilent	E4446A	US44300399	02/28/2015	02/27/2016

Remark: Each piece of equipment is scheduled for calibration once a year.

TEST CONFIGURATION

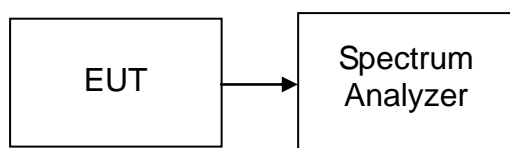

TEST PROCEDURE

1. Place the EUT on the table and set it in the transmitting mode.
2. Remove the antenna from the EUT, then connect a low loss RF cable from antenna port to the spectrum analyzer.
3. Set the spectrum analyzer as RBW=30kHz, VBW=100kHz, Span=3MHz, Sweep = auto.
4. Mark the peak frequency and 20dB (upper and lower) frequency.
5. Repeat until all the test channels are investigated.

TEST RESULTS

No non-compliance noted



Test plot

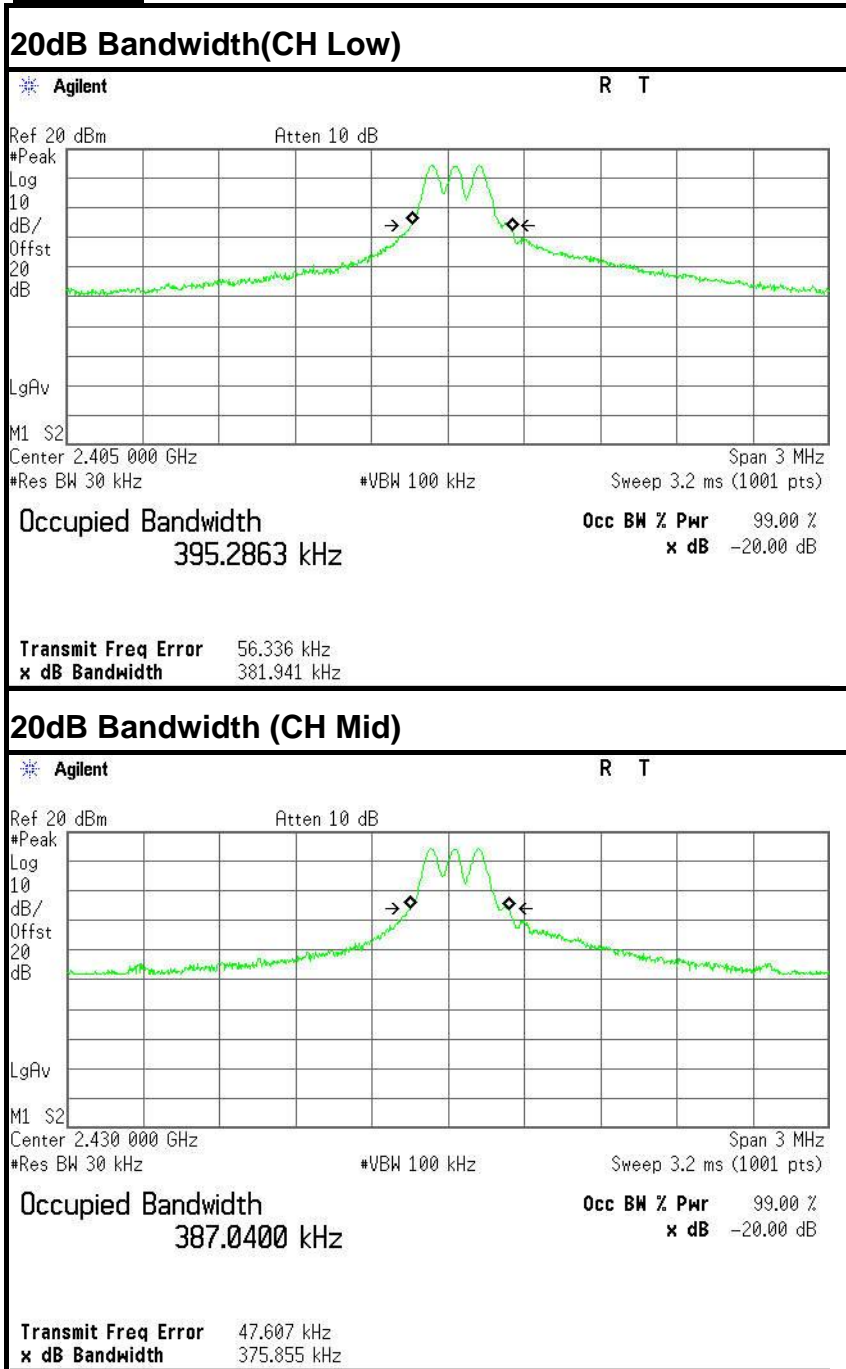



20dB Bandwidth (CH High)

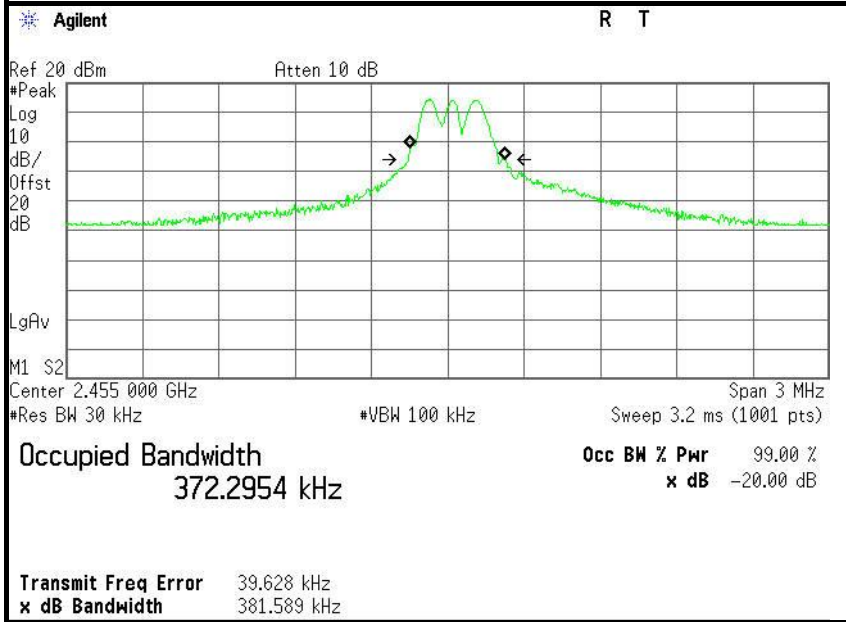



6.2 ANTENNA GAIN

MEASUREMENT

The antenna gain of the complete system is calculated by the difference of radiated power in EIRP and the conducted power of the module. For normal BT devices, the GFSK mode is used.

MEASUREMENT PARAMETERS

Measurement parameter	
Detector	Peak
Sweep time	Auto
Resolution bandwidth	3 MHz
Video bandwidth	3 MHz
Trace-Mode	Max hold

LIMITS

FCC	IC
Antenna Gain	
6 dBi	

TEST RESULTS

GFSK

T _{nom}	V _{nom}	Lowest channel 2405MHz	Middle channel 2430MHz	Highest channel 2455MHz
Conducted power [dBm] Measured with GFSK modulation		17.73	17.48	17.37
Radiated power [dBm] Measured with GFSK modulation		16.62	15.68	14.74
Gain [dBi] Calculated		-1.11	-1.80	-2.63
Measurement uncertainty		± 1.5 dB (cond.) / ± 3 dB (rad.)		



6.3 PEAK POWER

LIMIT

The maximum peak output power of the intentional radiator shall not exceed the following:

1. For frequency hopping systems operating in the 2400-2483.5 MHz band employing at least 75 non-overlapping hopping channels, and all frequency hopping systems in the 5725-5850 MHz band: 1 watt. For all other frequency hopping systems in the 2400-2483.5 MHz band: 0.125 watts.
2. Except as shown in paragraphs (b)(3) (i), (ii) and (iii) of this section, if transmitting antennas of directional gain greater than 6dBi are used the peak output power from the intentional radiator shall be reduced below the stated values in paragraphs (b)(1) or (b)(2) of this section, as appropriate, by the amount in dB that the directional gain of the antenna exceeds 6dBi.
3. The conducted output power limit specified in paragraph (b) of this section is based on the use of antennas with directional gains that do not exceed 6 dBi. Except as shown in paragraph (c) of this section, if transmitting antennas of directional gain greater than 6 dBi are used, the conducted output power from the intentional radiator shall be reduced below the stated values in paragraphs (b)(1), (b)(2), and (b)(3) of this section, as appropriate, by the amount in dB that the directional gain of the antenna exceeds 6 dBi.

MEASUREMENT EQUIPMENT USED

Name of Equipment	Manufacturer	Model	Serial Number	Last Calibration	Due Calibration
Power Meter	Anritsu	ML2495A	1204003	02/28/2015	02/27/2016
Power Sensor	Anritsu	MA2411B	1126150	02/28/2015	02/27/2016

Remark: Each piece of equipment is scheduled for calibration once a year.

Test Configuration

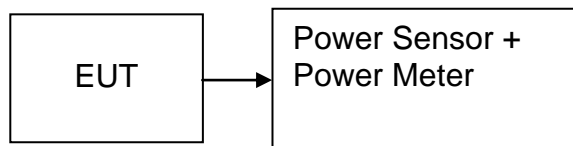

TEST PROCEDURE

The transmitter output is connected to the RF Power Meter. The RF Power Meter is set to the peak power detection.



TEST RESULTS

No non-compliance noted

Test Data

Channel	Frequency (MHz)	Reading Power (dBm)	Factor (dB)	Duty Factor (dB)	Output Power (dBm)	Output Power (W)	Limit (W)	Peak / Average
Low	2405	14.23	3.50	/	17.73	0.05929	1	Peak
Mid	2430	13.98	3.50	/	17.48	0.05598		
High	2455	13.87	3.50	/	17.37	0.05458		
Low	2405	1.11	3.50	9.06	13.67	0.02328	1	Average
Mid	2430	0.96	3.50	9.06	13.52	0.02249		
High	2455	1.01	3.50	9.06	13.57	0.02275		

Note : 1. Reading power: the average result read from the powermeter.

Factor: the cable loss and attenuator between the powermeter and test sample.

2. When measuring the average reading power, the device was not transmitting with 100% duty cycle, but with a lower fixed duty cycle, resulting in duty factor applying to correct the average reading power.

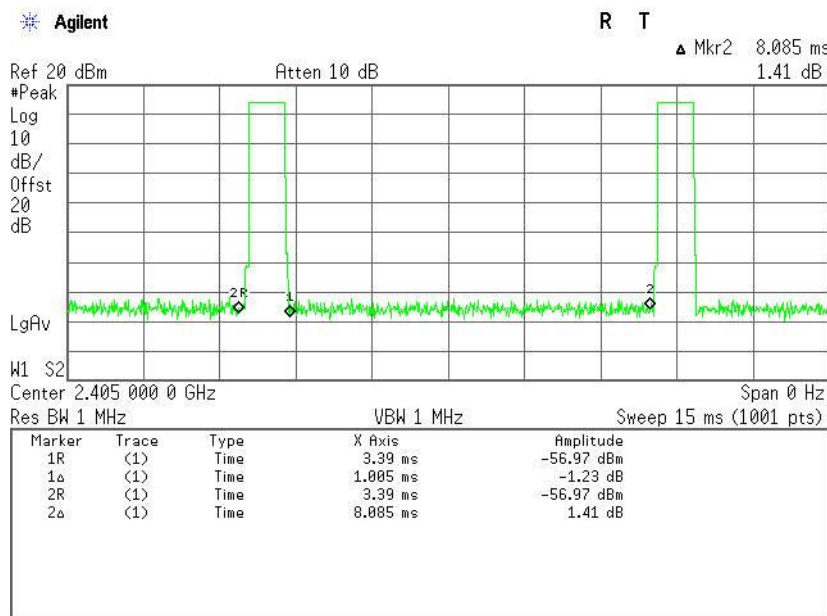

Remark: Duty Factor=10log(1/x)=9.06 , X=On / (On + Off)



6.4 PEAK POWER SPECTRAL DENSITY

LIMIT

1. For direct sequence systems, the peak power spectral density conducted from the intentional radiator to the antenna shall not be greater than 8dBm in any 3kHz band during any time interval of continuous transmission.
2. The direct sequence operating of the hybrid system, with the frequency hopping operation turned off, shall comply with the power density requirements of paragraph (d) of this section.

MEASUREMENT EQUIPMENT USED

Name of Equipment	Manufacturer	Model	Serial Number	Last Calibration	Due Calibration
Spectrum Analyzer	Agilent	E4446A	US44300399	02/28/2015	02/27/2016

Remark: Each piece of equipment is scheduled for calibration once a year.

Test Configuration

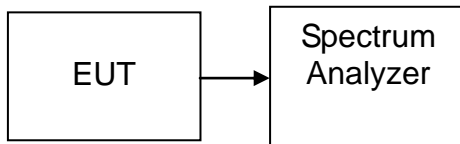

TEST PROCEDURE

1. Set analyzer center frequency to DTS channel center frequency.
2. Set the span to 1.5 times the DTS bandwidth.
3. Set the RBW to: $3 \text{ kHz} \leq \text{RBW} \leq 100 \text{ kHz}$.
4. Set the VBW $\geq 3 \times \text{RBW}$.
5. Detector = peak.
6. Sweep time = auto couple.
7. Trace mode = max hold.
8. Allow trace to fully stabilize.
9. Use the peak marker function to determine the maximum amplitude level within the RBW.
10. If measured value exceeds limit, reduce RBW (no less than 3 kHz) and repeat.

TEST RESULTS

Not applicable. Since the EUT is FHSS device.



6.5 BAND EDGES MEASUREMENT

LIMIT

According to §15.247(c), in any 100 kHz bandwidth outside the frequency bands in which the spread spectrum intentional radiator is operating, the radio frequency power that is produced by the intentional radiator shall be at least 20dB below that in the 100kHz bandwidth within the band that contains the highest level of the desired power. In addition, radiated emissions which fall in the restricted bands, as defined in §15.205(a), must also comply with the radiated emission limits specified in 15.209(a).

MEASUREMENT EQUIPMENT USED

Radiated Emission Test Site 966 (2)					
Name of Equipment	Manufacturer	Model Number	Serial Number	Last Calibration	Due Calibration
Spectrum Analyzer	Agilent	N9010A	MY52221469	02/28/2015	02/27/2016
EMI TEST RECEIVER	ROHDE&SCHWARZ	ESCI	100783	02/28/2015	02/27/2016
Amplifier	MITEQ	AM-1604-3000	1123808	03/18/2015	03/18/2016
High Noise Amplifier	Agilent	8449B	3008A01838	02/28/2015	02/27/2016
Board-Band Horn Antenna	Schwarzbeck	BBHA 9170	9170-497	02/28/2015	02/27/2016
Bilog Antenna	SCHAFFNER	CBL6143	5082	02/28/2015	02/27/2016
Horn Antenna	SCHWARZBECK	BBHA9120	D286	02/28/2015	02/27/2016
Loop Antenna	A、R、A	PLA-1030/B	1029	09/25/2015	09/24/2016
Turn Table	N/A	N/A	N/A	N.C.R	N.C.R
Controller	Sunol Sciences	SC104V	022310-1	N.C.R	N.C.R
Controller	CT	N/A	N/A	N.C.R	N.C.R
Temp. / Humidity Meter	Anymetre	JR913	N/A	02/28/2015	02/27/2016
Antenna Tower	SUNOL	TLT2	N/A	N.C.R	N.C.R
Test S/W	FARAD	LZ-RF / CCS-SZ-3A2			

Test Configuration

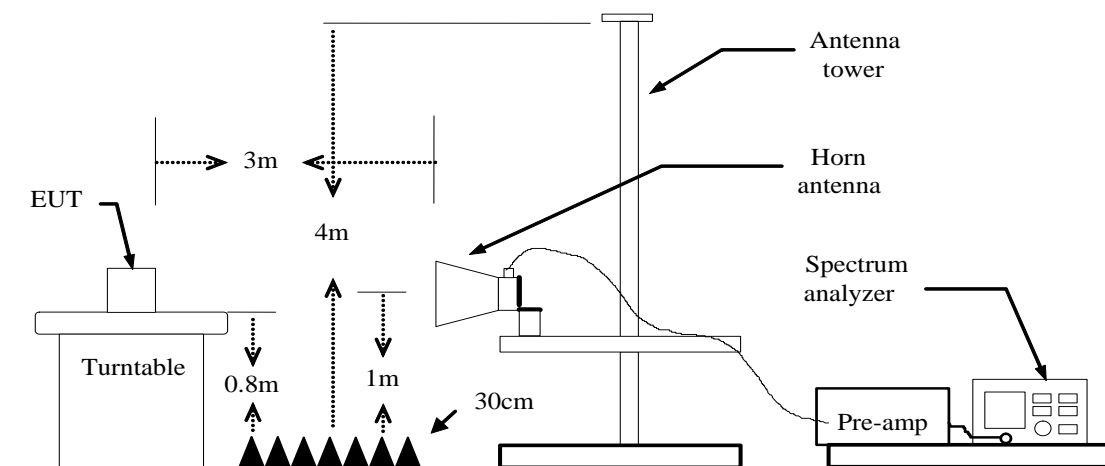



TEST PROCEDURE

1. The EUT is placed on a turntable, which is 0.8m above the ground plane.
2. The turntable shall be rotated for 360 degrees to determine the position of maximum emission level.
3. EUT is set 3m away from the receiving antenna, which is varied from 1m to 4m to find out the highest emission.
4. Set the spectrum analyzer in the following setting in order to capture the lower and upper band-edges of the emission:
 - (a) PEAK: RBW=VBW=1MHz / Sweep=AUTO
 - (b) AVERAGE: RBW=1MHz / VBW=1.2kHz / Sweep=AUTO
5. Repeat the procedures until all the PEAK and AVERAGE versus POLARIZATION are measured.

TEST RESULTS

Refer to attach spectrum analyzer data chart.



Test Data (Hopping OFF)

Band Edges (CH-Low)

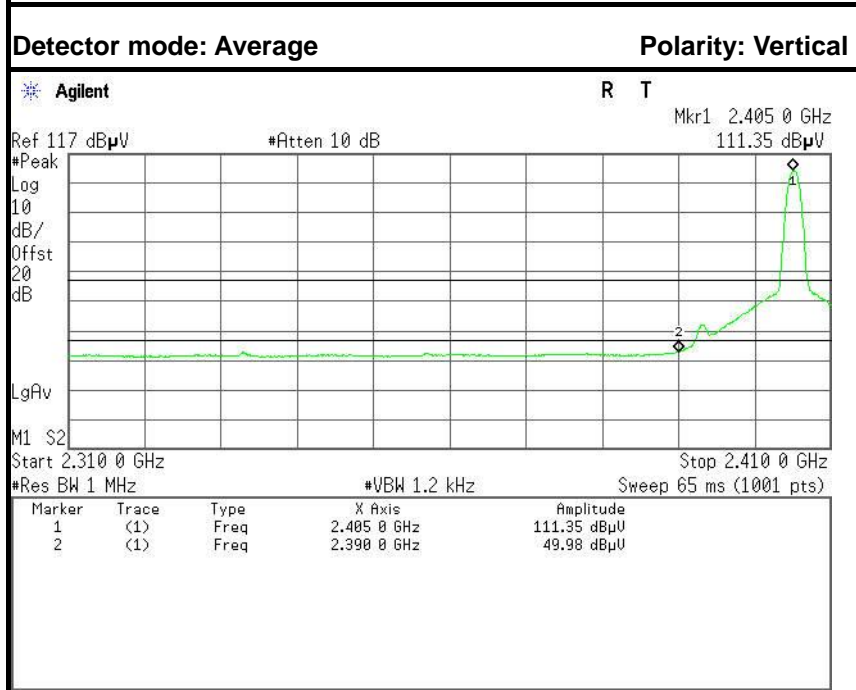
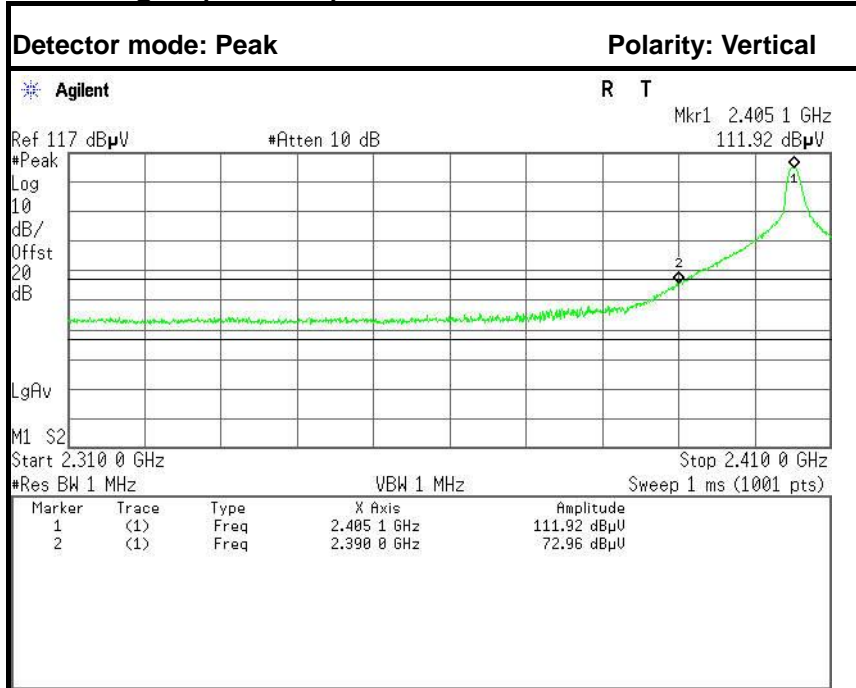

No.	Frequency (MHz)	Reading (dBuV)	Corrected (dB)	Result (dBuV)	Limit (dBuV)	Margin (dB)	Detector	Antenna Pole
1	2390.0000	66.36	-6.60	72.96	74.00	-1.04	Peak	Vertical
2	2390.0000	43.38	-6.60	49.98	54.00	-4.02	Average	Vertical

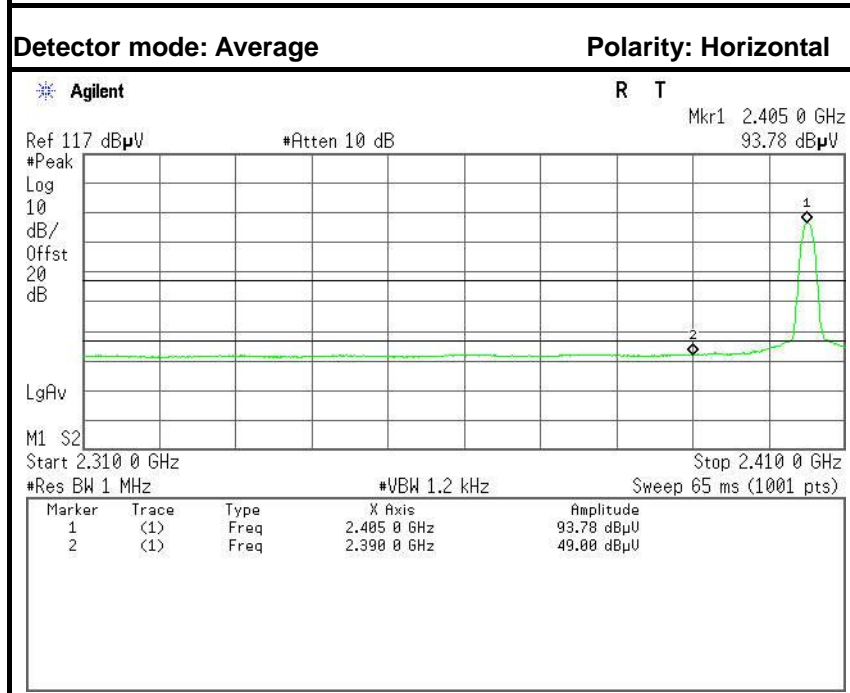
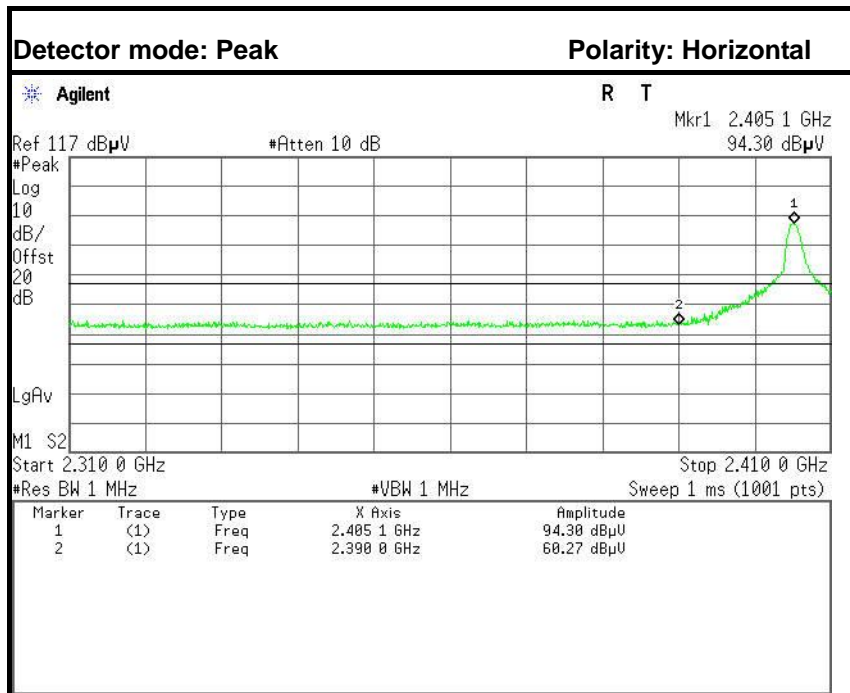

No.	Frequency (MHz)	Reading (dBuV)	Corrected (dB)	Result (dBuV)	Limit (dBuV)	Margin (dB)	Detector	Antenna Pole
1	2390.0000	53.67	-6.60	60.27	74.00	-13.73	Peak	Horizontal
2	2390.0000	42.40	-6.60	49.00	54.00	-5.00	Average	Horizontal



Band Edges (CH-High)

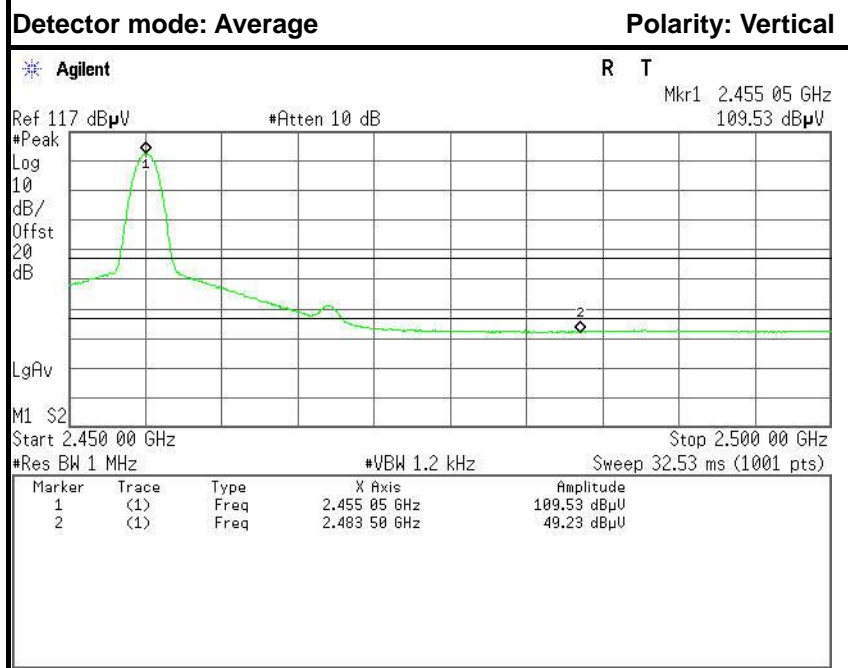
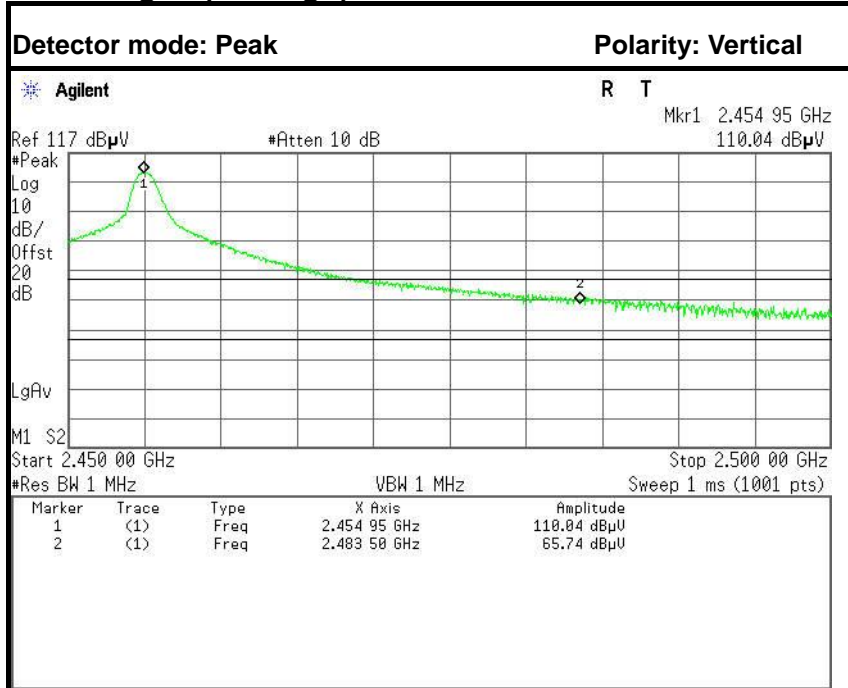

No.	Frequency (MHz)	Reading (dBuV)	Corrected (dB)	Result (dBuV)	Limit (dBuV)	Margin (dB)	Detector	Antenna Pole
1	2483.5000	59.14	-6.60	65.74	74.00	-8.26	Peak	Vertical
2	2483.5000	42.63	-6.60	49.23	54.00	-4.77	Average	Vertical

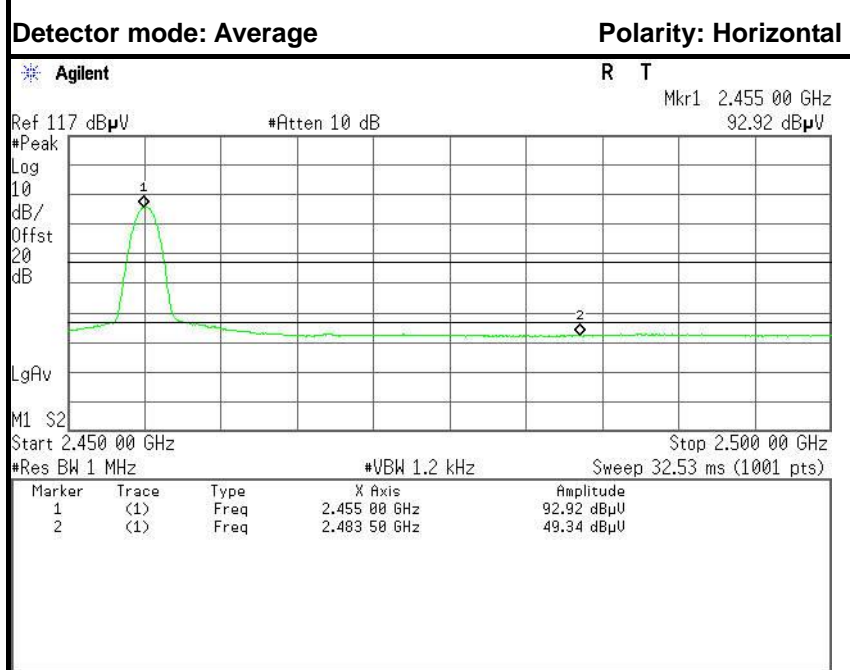
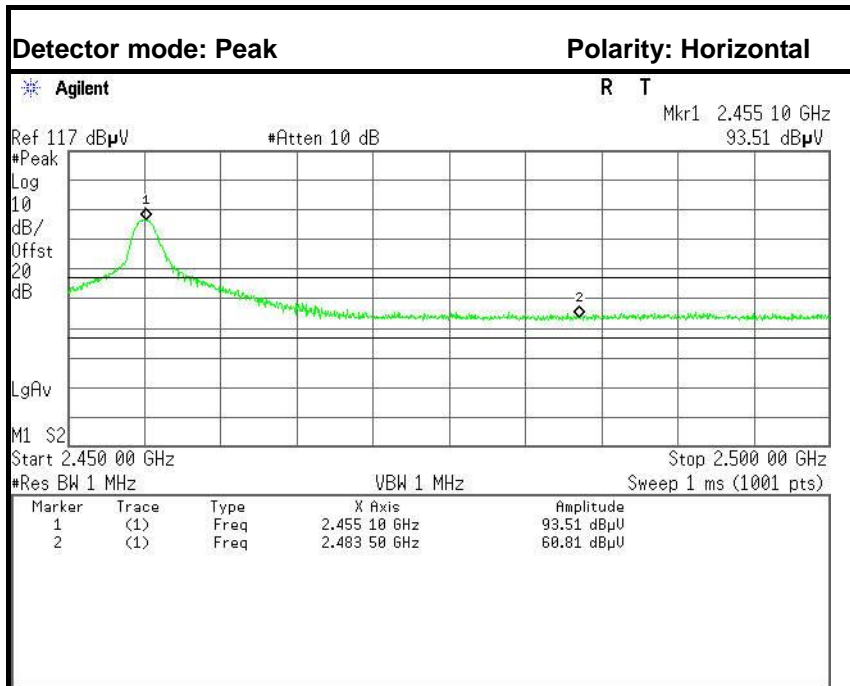

No.	Frequency (MHz)	Reading (dBuV)	Corrected (dB)	Result (dBuV)	Limit (dBuV)	Margin (dB)	Detector	Antenna Pole
1	2483.5000	54.21	-6.60	60.81	74.00	-13.19	Peak	Vertical
2	2483.5000	42.74	-6.60	49.34	54.00	-4.66	Average	Vertical



Test Data (Hopping ON)

Band Edges (CH-Low)

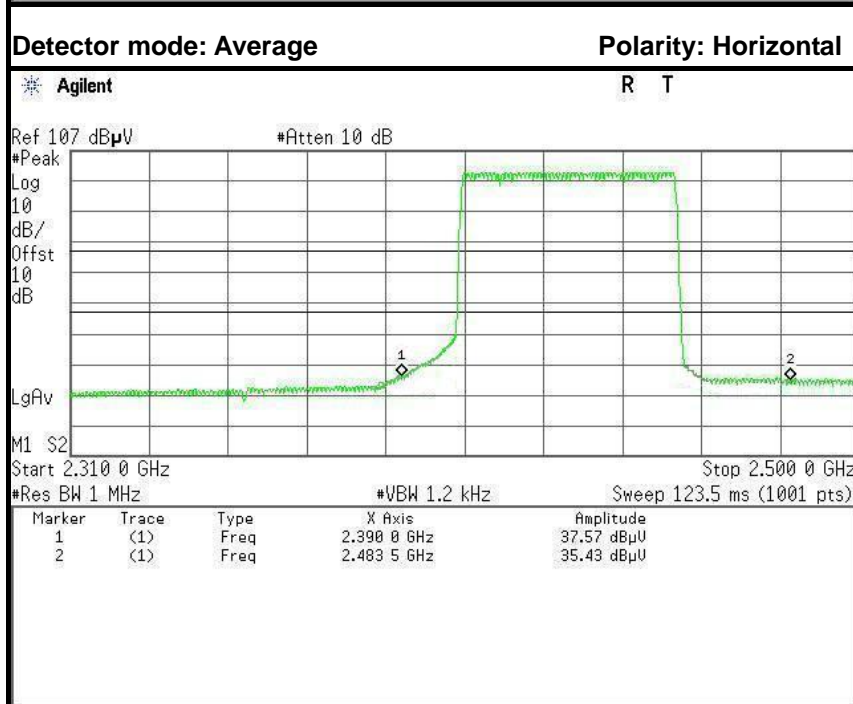
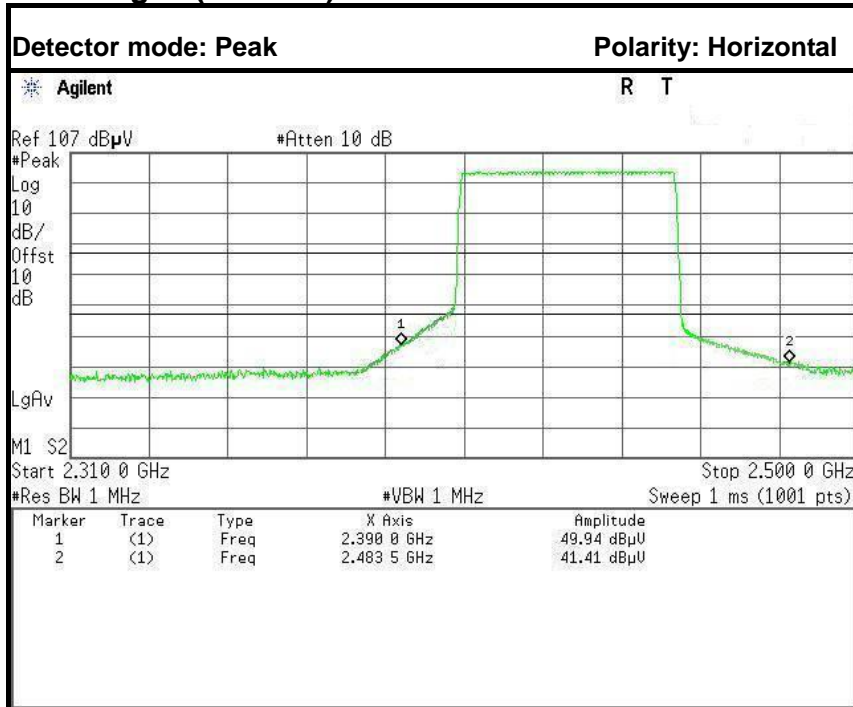

No.	Frequency (MHz)	Reading (dBuV)	Corrected (dB)	Result (dBuV)	Limit (dBuV)	Margin (dB)	Detector	Antenna Pole
1	2390.0000	34.81	-6.60	41.41	74.00	-32.59	Peak	Horizontal
2	2390.0000	28.83	-6.60	35.43	54.00	-18.57	Average	Horizontal

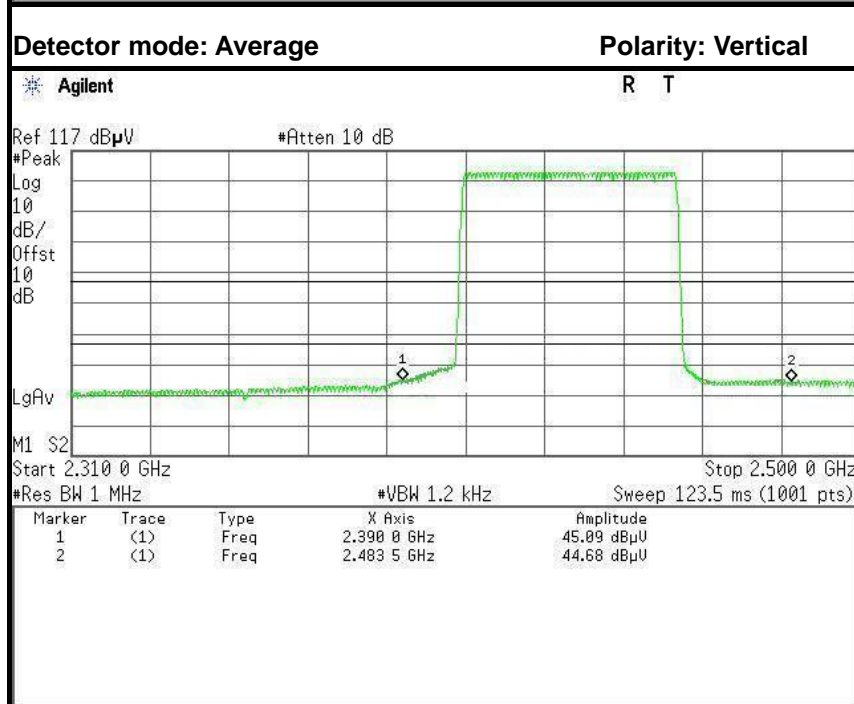
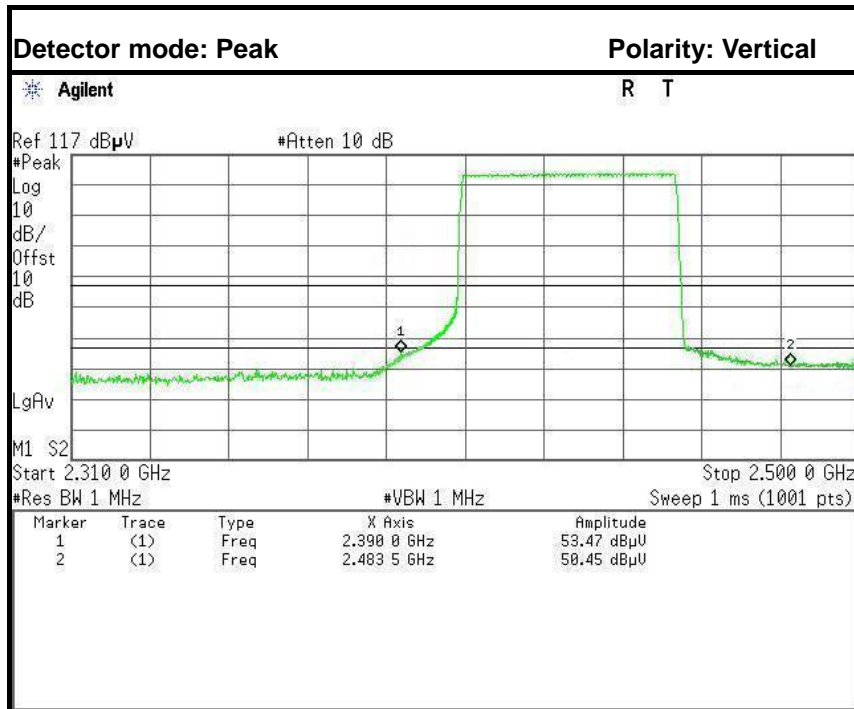

No.	Frequency (MHz)	Reading (dBuV)	Corrected (dB)	Result (dBuV)	Limit (dBuV)	Margin (dB)	Detector	Antenna Pole
1	2390.0000	43.85	-6.60	50.45	74.00	-23.55	Peak	Vertical
2	2390.0000	38.08	-6.60	44.68	54.00	-9.32	Average	Vertical



6.6 FREQUENCY SEPARATION

LIMIT

According to §15.247(a)(1), Frequency hopping systems shall have hopping channel carrier frequencies separated by a minimum of 25 kHz or the 20 dB bandwidth of the hopping channel, whichever is greater. Alternatively, frequency hopping systems operating in the 2400-2483.5 MHz band may have hopping channel carrier frequencies that are separated by 25 kHz or two-thirds of the 20 dB bandwidth of the hopping channel, whichever is greater, provided the systems operate with an output power no greater than 125 mW.

MEASUREMENT EQUIPMENT USED

Name of Equipment	Manufacturer	Model	Serial Number	Last Calibration	Due Calibration
Spectrum Analyzer	Agilent	E4446A	US44300399	02/28/2015	02/27/2016

Remark: Each piece of equipment is scheduled for calibration once a year.

Test Configuration

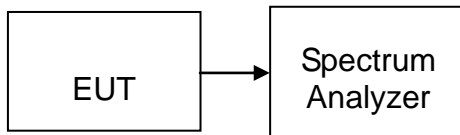

TEST PROCEDURE

1. Place the EUT on the table and set it in transmitting mode.
2. Remove the antenna from the EUT and then connect a low loss RF cable from the antenna port to the spectrum analyzer.
3. Set center frequency of spectrum analyzer = middle of hopping channel.
4. Set the spectrum analyzer as RBW=30kHz, VBW=30kHz, Adjust Span to 4 MHz, Sweep = auto.
5. Max hold. Mark 3 Peaks of hopping channel and record the 3 peaks frequency.

TEST RESULTS

No non-compliance noted

Test Data

Channel Separation (MHz)	Two-thirds of the 20 dB Bandwidth (kHz)	Channel Separation Limit	Result
1.000	254.627	> Two-thirds of the 20 dB Bandwidth	Pass



Test Plot

Measurement of Channel Separation

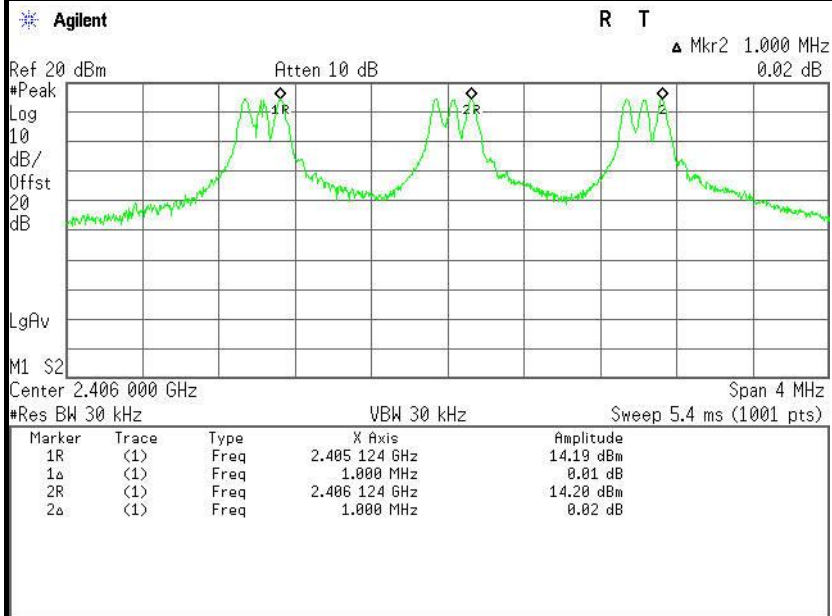

20 dB bandwidth(CH Low)

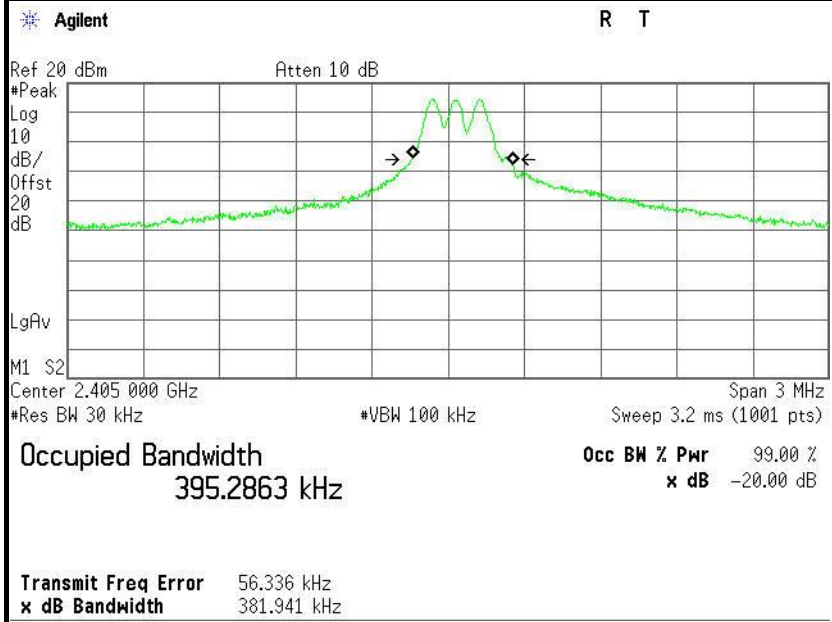



6.7 NUMBER OF HOPPING FREQUENCY

LIMIT

According to §15.247(a)(1)(ii), Frequency hopping systems operating in the 2400MHz-2483.5 MHz bands shall use at least 15 hopping frequencies.

MEASUREMENT EQUIPMENT USED

Name of Equipment	Manufacturer	Model	Serial Number	Last Calibration	Due Calibration
Spectrum Analyzer	Agilent	E4446A	US44300399	02/28/2015	02/27/2016

Remark: Each piece of equipment is scheduled for calibration once a year.

Test Configuration

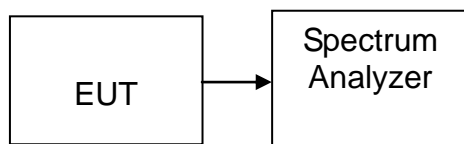

TEST PROCEDURE

1. Place the EUT on the table and set it in transmitting mode.
2. Remove the antenna from the EUT and then connect a low loss RF cable from the antenna port to the spectrum analyzer.
3. Set spectrum analyzer Start=2400MHz, Stop = 2483.5MHz, Sweep = 1ms.
4. Set the spectrum analyzer as RBW, VBW=300kHz,
5. Max hold, view and count how many channel in the band.

TEST RESULTS

No non-compliance noted

Test Data

Result (No. of CH)	Limit (No. of CH)	Result
51	>15	PASS



Test Plot

Channel Number

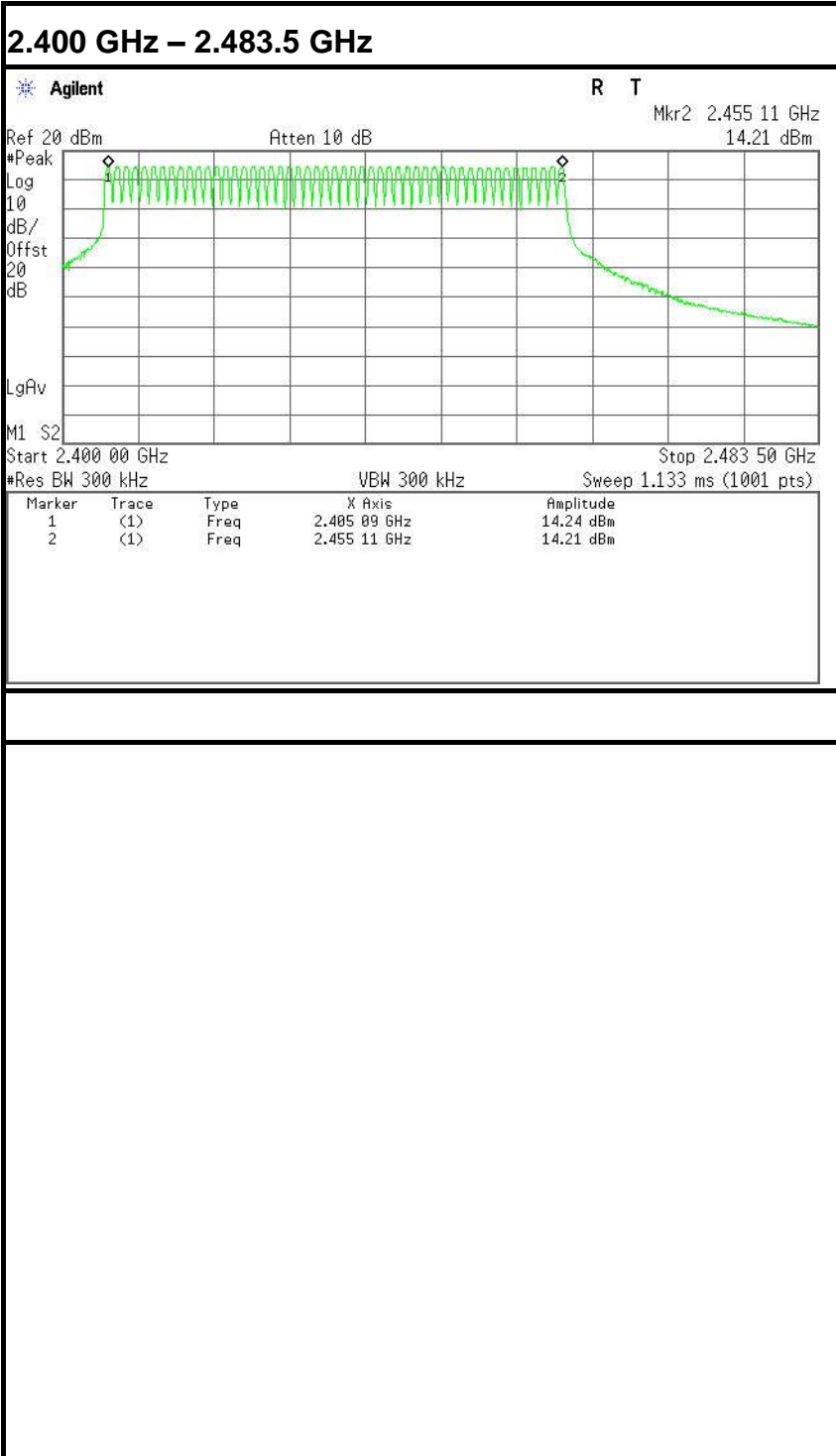



6.8 TIME OF OCCUPANCY (DWELL TIME)

LIMIT

According to §15.247(a)(1)(iii), Frequency hopping systems operating in the 2400MHz-2483.5 MHz bands. The average time of occupancy on any channels shall not greater than 0.4 s within a period 0.4 s multiplied by the number of hopping channels employed.

MEASUREMENT EQUIPMENT USED

Name of Equipment	Manufacturer	Model	Serial Number	Last Calibration	Due Calibration
Spectrum Analyzer	Agilent	E4446A	US44300399	02/28/2015	02/27/2016

Remark: Each piece of equipment is scheduled for calibration once a year.

Test Configuration

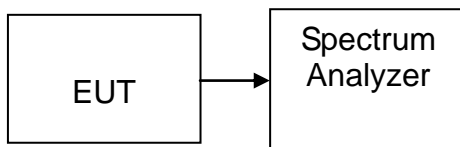

TEST PROCEDURE

1. Place the EUT on the table and set it in transmitting mode.
2. Remove the antenna from the EUT and then connect a low loss RF cable from the antenna port to the spectrum analyzer.
3. Set center frequency of spectrum analyzer = operating frequency.
4. Set the spectrum analyzer as RBW, VBW=1MHz, Span = 0Hz, Sweep = auto.
5. Repeat above procedures until all frequency measured were complete.



TEST RESULTS

No non-compliance noted

Test Data

CH Mid: $0.866 \times 14 \times 6 / 51 \times 43 = 61.333(\text{ms})$

CH	Pulse Time (ms)	Total of Dwell (ms)	Period Time (s)	Limit (ms)	Result
Mid	0.866	61.333	17.2	400.00	PASS



Test Plot

CH Mid

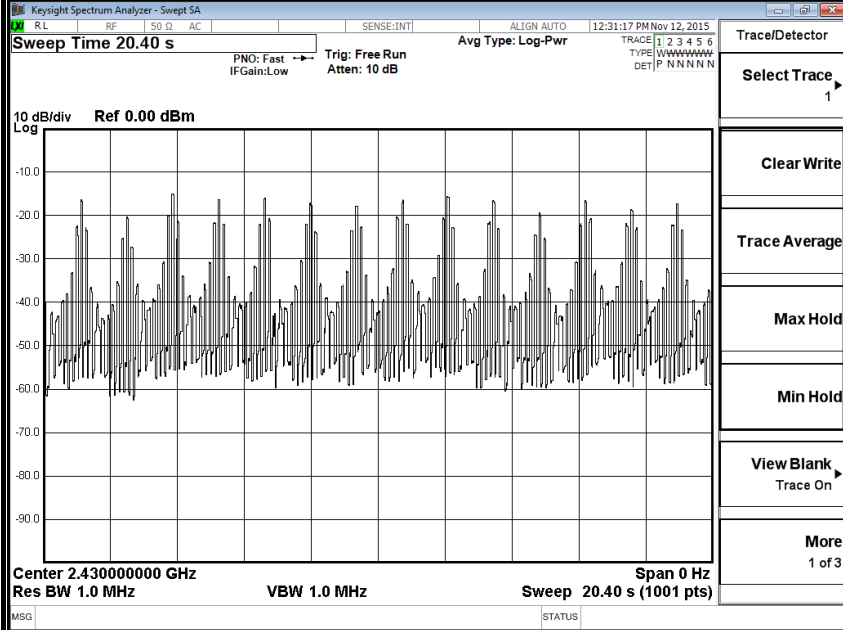

CH Mid

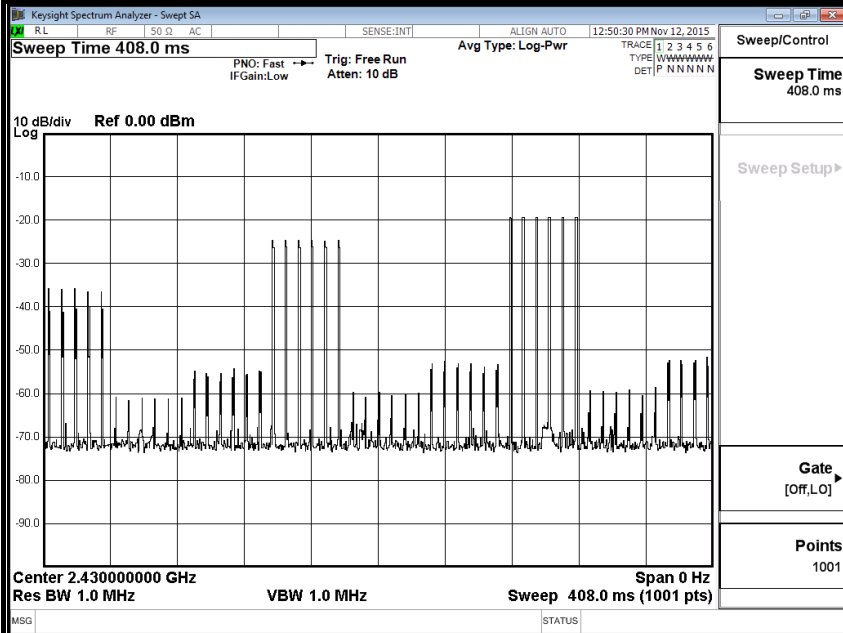

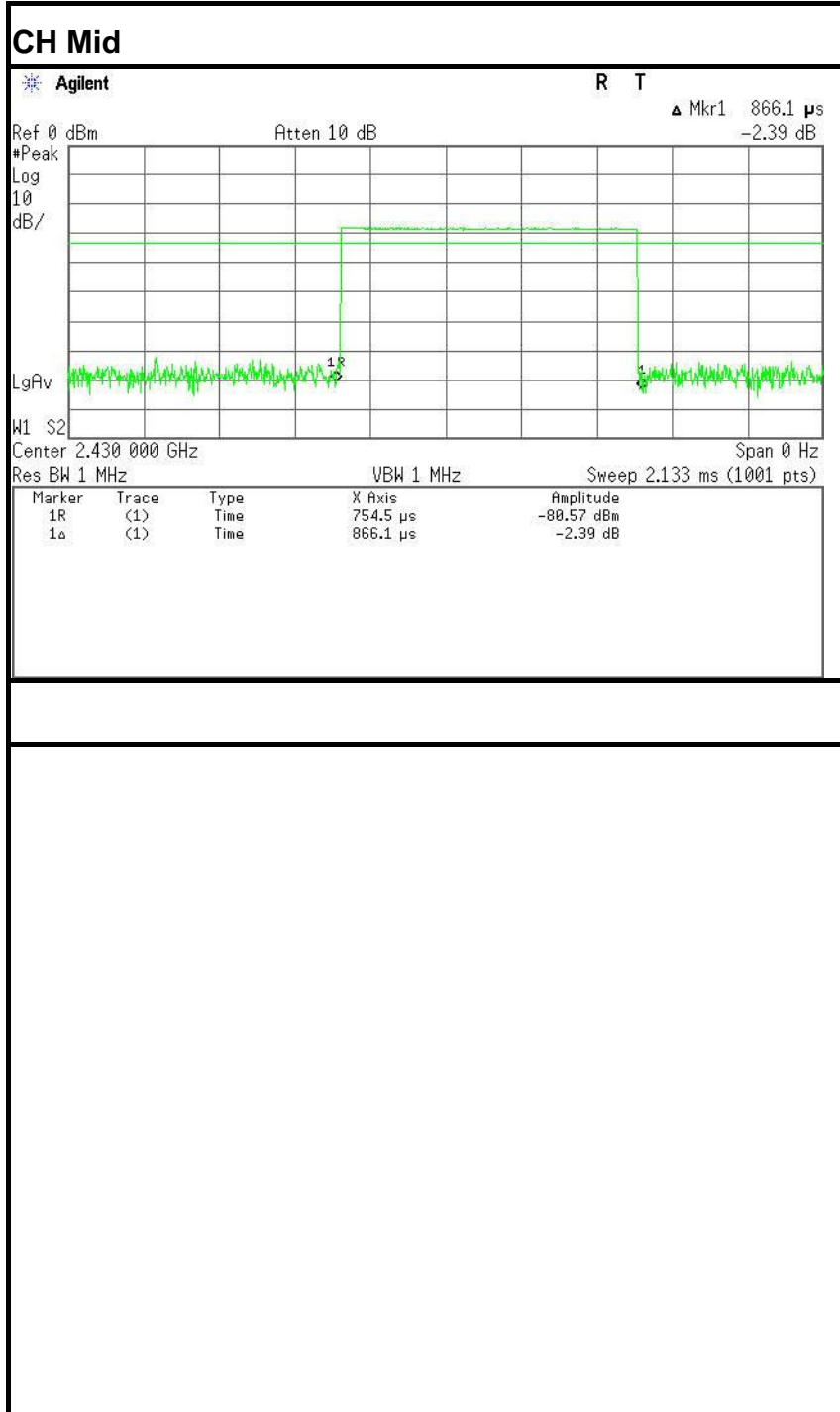



6.9 SPURIOUS EMISSIONS

6.9.1. CONDUCTED MEASUREMENT

LIMIT

In any 100 kHz bandwidth outside the frequency band in which the spread spectrum or digitally modulated intentional radiator is operating, the radio frequency power that is produced by the intentional radiator shall be at least 20 dB below that in the 100 kHz bandwidth within the band that contains the highest level of the desired power, based on either an RF conducted or a radiated measurement. Attenuation below the general limits specified in Section 15.209(a) is not required. In addition, radiated emissions which fall in the restricted bands, as defined in Section 15.205(a), must also comply with the radiated emission limits specified in Section 15.209(a) (see Section 15.205(c)).

MEASUREMENT EQUIPMENT USED

Name of Equipment	Manufacturer	Model	Serial Number	Last Calibration	Due Calibration
Spectrum Analyzer	Agilent	E4446A	US44300399	02/28/2015	02/27/2016

Remark: Each piece of equipment is scheduled for calibration once a year.

Test Configuration

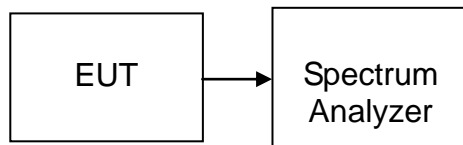

TEST PROCEDURE

Conducted RF measurements of the transmitter output were made to confirm that the EUT antenna port conducted emissions meet the specified limit and to identify any spurious signals that require further investigation or measurements on the radiated emissions site.

The transmitter output is connected to the spectrum analyzer. The resolution bandwidth is set to 100 kHz. The video bandwidth is set to 100 kHz.

Measurements are made over the 30MHz to 26GHz range with the transmitter set to the lowest, middle, and highest channels.

TEST RESULTS

No non-compliance noted



Test Plot

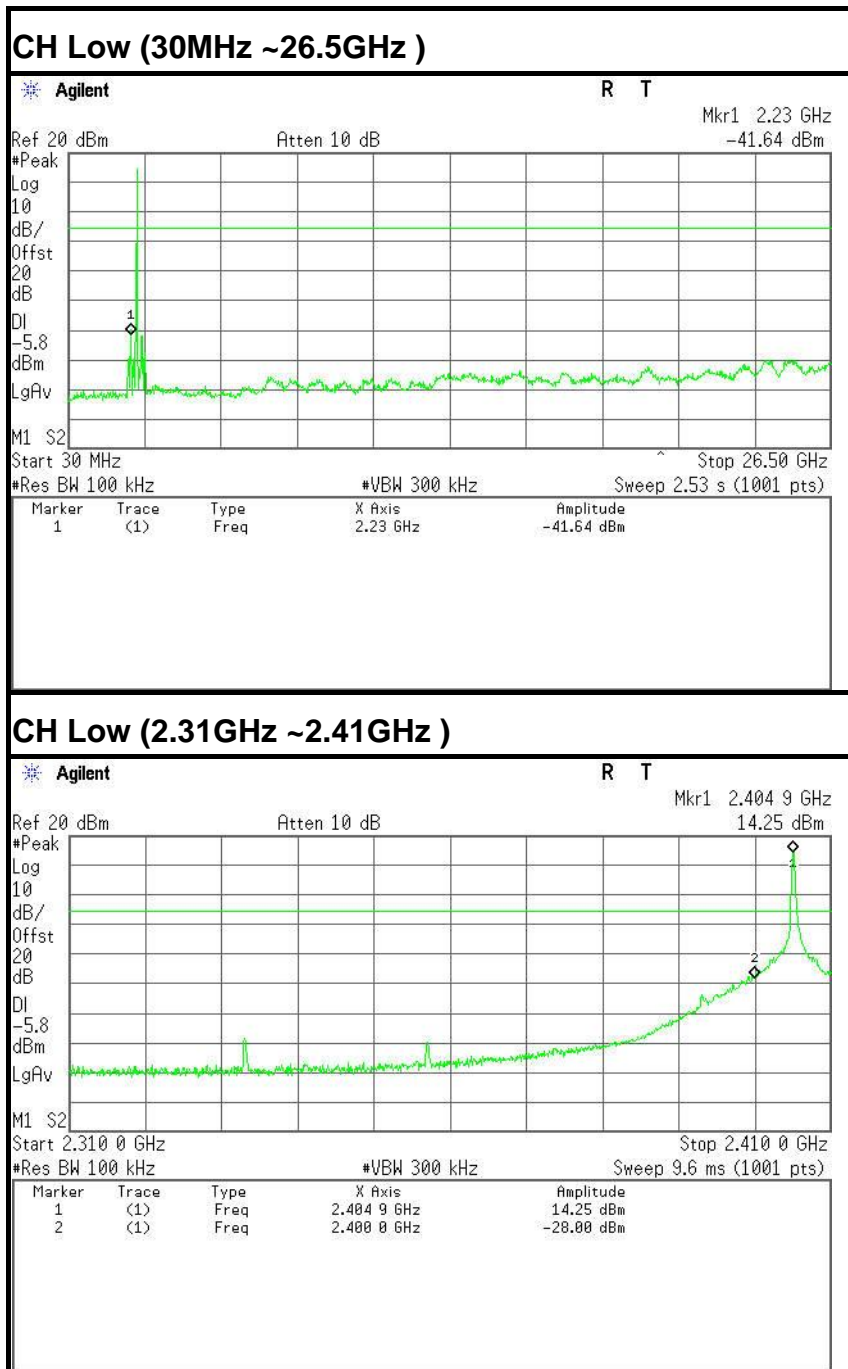



CH Mid (30MHz ~ 26.5GHz)

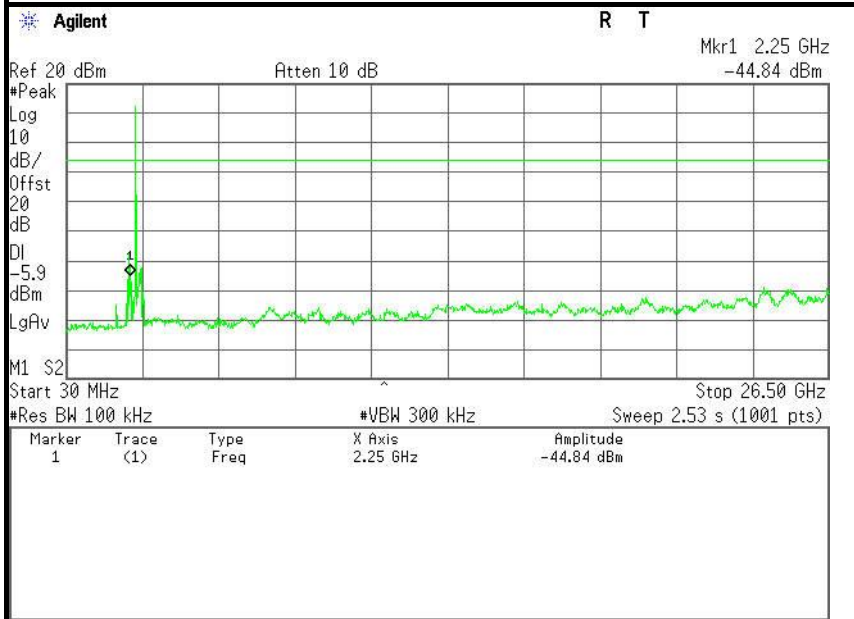

CH High (30MHz ~ 26.5GHz)

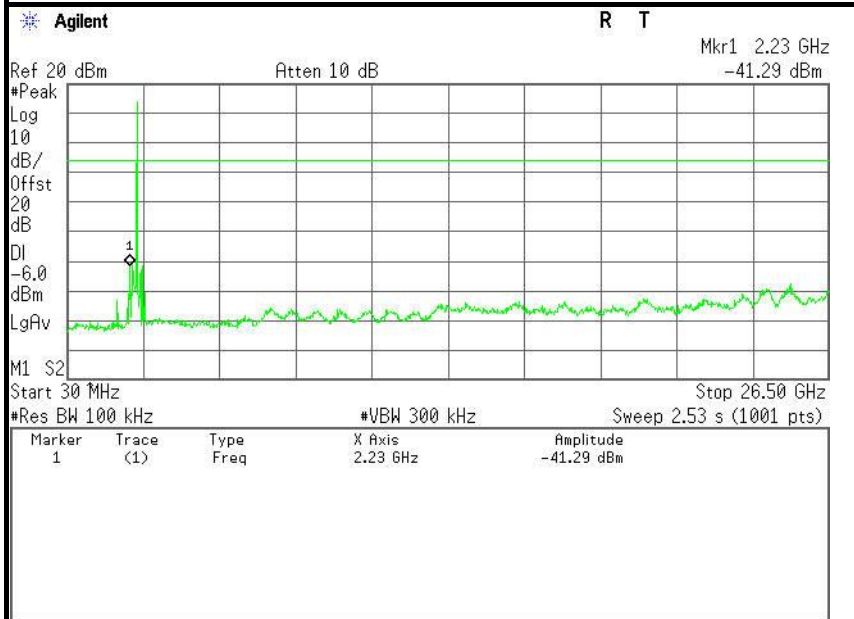

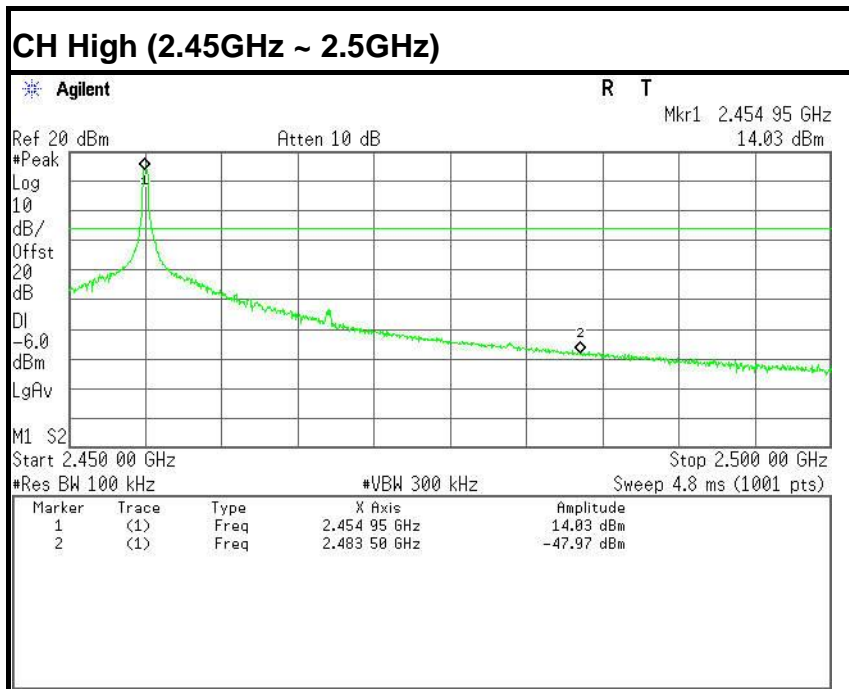



6.9.2. RADIATED EMISSIONS

LIMIT

1. Except as provided elsewhere in this Subpart, the emissions from an intentional radiator shall not exceed the field strength levels specified in the following table:

Frequency (MHz)	Field Strength (mV/m)	Measurement Distance (m)
0.009-0.490	2400/F(kHz)	300
0.490-1.705	24000/F(kHz)	30
1.705-30.0	30	30
30-88	100*	3
88-216	150*	3
216-960	200*	3
Above 960	500	3

Note: Except as provided in paragraph (g), fundamental emissions from intentional radiators operating under this Section shall not be located in the frequency bands 54-72 MHz, 76-88 MHz, 174-216 MHz or 470-806 MHz. However, operation within these frequency bands is permitted under other sections of this Part, e.g., Sections 15.231 and 15.241.

2. In the above emission table, the tighter limit applies at the band edges.

Frequency (Hz)	Field Strength (μ V/m at 3-meter)	Field Strength (dB μ V/m at 3-meter)
30-88	100	40
88-216	150	43.5
216-960	200	46
Above 960	500	54

**MEASUREMENT EQUIPMENT USED**

Radiated Emission Test Site 966 (2)					
Name of Equipment	Manufacturer	Model Number	Serial Number	Last Calibration	Due Calibration
PSA Series Spectrum Analyzer	Agilent	E4446A	US44300399	02/28/2015	02/27/2016
EMI TEST RECEIVER	ROHDE&SCHWARZ	ESCI	100783	02/28/2015	02/27/2016
Amplifier	MITEQ	AM-1604-3000	1123808	03/18/2015	03/18/2016
High Noise Amplifier	Agilent	8449B	3008A01838	02/28/2015	02/27/2016
Board-Band Horn Antenna	Schwarzbeck	BBHA 9170	9170-497	02/28/2015	02/27/2016
Bilog Antenna	SCHAFFNER	CBL6143	5082	02/28/2015	02/27/2016
Horn Antenna	SCHWARZBECK	BBHA9120	D286	02/28/2015	02/27/2016
Loop Antenna	A、R、A	PLA-1030/B	1029	09/25/2015	09/24/2016
Turn Table	N/A	N/A	N/A	N.C.R	N.C.R
Controller	Sunol Sciences	SC104V	022310-1	N.C.R	N.C.R
Controller	CT	N/A	N/A	N.C.R	N.C.R
Temp. / Humidity Meter	Anymetre	JR913	N/A	02/28/2015	02/27/2016
Antenna Tower	SUNOL	TLT2	N/A	N.C.R	N.C.R
Test S/W	FARAD	LZ-RF / CCS-SZ-3A2			

Remark: Each piece of equipment is scheduled for calibration once a year.



TEST CONFIGURATION

Below 1 GHz

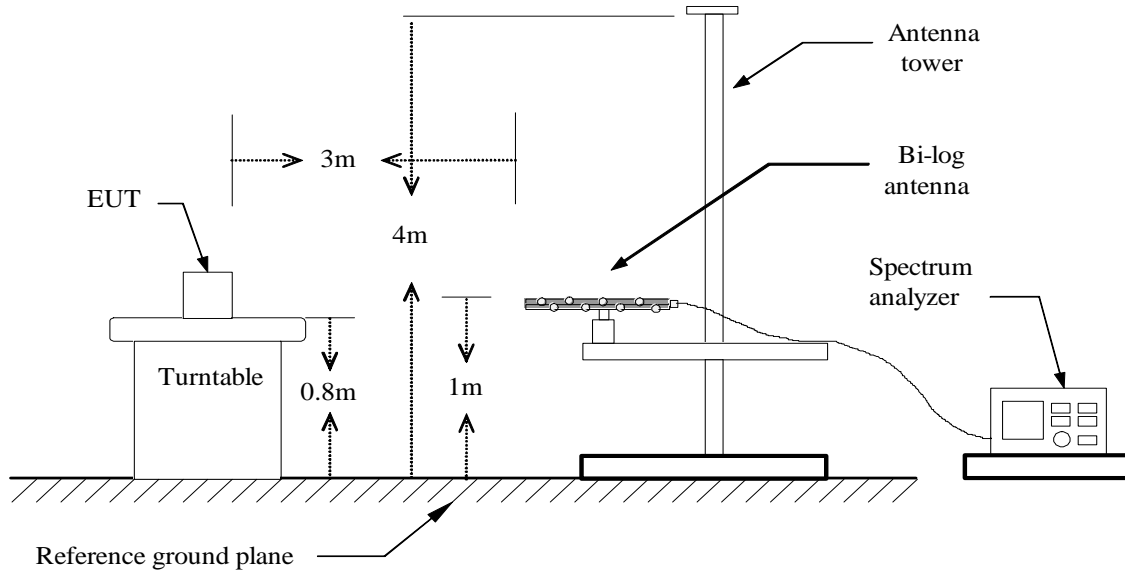

Above 1 GHz

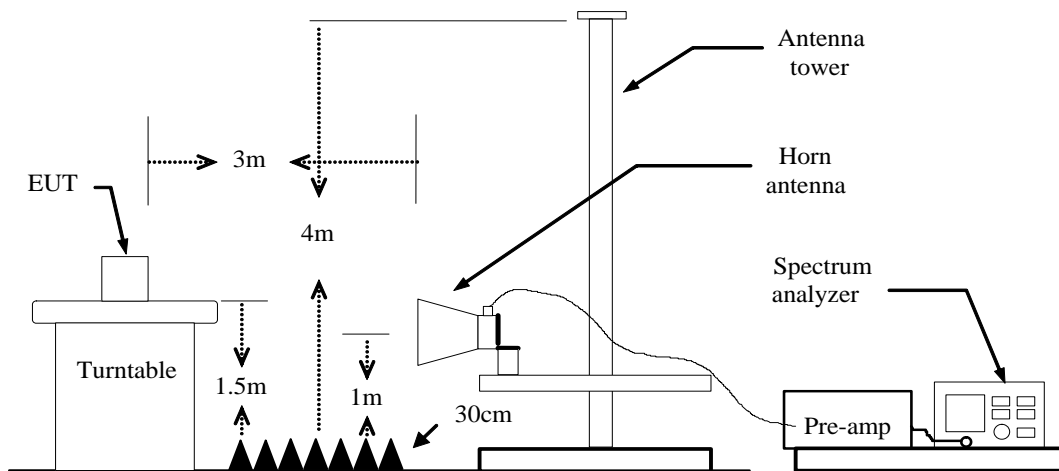



TEST PROCEDURE

1. The EUT is placed on a turntable, which is 0.8m or 1.5m above ground plane.
2. The turntable shall be rotated for 360 degrees to determine the position of maximum emission level.
3. EUT is set 3m away from the receiving antenna, which is varied from 1m to 4m to find out the highest emissions.
4. Maximum procedure was performed on the six highest emissions to ensure EUT compliance.
5. And also, each emission was to be maximized by changing the polarization of receiving antenna both horizontal and vertical.
6. Repeat above procedures until the measurements for all frequencies are complete.



TEST RESULTS

Below 1 GHz

Operation Mode: TX

Test Date: October 29, 2015

Temperature: 24°C

Tested by: Ad Gan

Humidity: 52% RH

Polarity: Ver. / Hor.

Frequency (MHz)	Reading (dBµV)	Correction Factor (dB/m)	Result (dBµV/m)	Limit (dBµV/m)	Margin (dB)	Antenna Pole (V/H)	Remark
133.7900	33.68	-20.94	12.74	43.50	-30.76	V	QP
260.8600	34.48	-19.96	14.52	46.00	-31.48	V	QP
412.1800	36.27	-15.57	20.70	46.00	-25.30	V	QP
494.6300	41.55	-14.36	27.19	46.00	-18.81	V	QP
607.1500	34.94	-12.68	22.26	46.00	-23.74	V	QP
770.1100	34.81	-11.13	23.68	46.00	-22.32	V	QP
223.0300	34.42	-20.80	13.62	46.00	-32.38	H	QP
325.8500	33.90	-18.62	15.28	46.00	-30.72	H	QP
427.7000	34.44	-15.55	18.89	46.00	-27.11	H	QP
553.8000	33.60	-13.16	20.44	46.00	-25.56	H	QP
757.5000	34.30	-11.07	23.23	46.00	-22.77	H	QP
876.8100	34.34	-10.08	24.26	46.00	-21.74	H	QP

****Remark:** No emission found between lowest internal used/generated frequency to 30MHz.

Notes:

1. Measuring frequencies from 9kHz to the 1GHz.
2. Radiated emissions measured in frequency range from 30MHz to 1GHz were made with an instrument using Peak/Quasi-peak detector mode.
3. Data of measurement within this frequency range shown " --- " in the table above means the reading of emissions are attenuated more than 20dB below the permissible limits or the field strength is too small to be measured.
4. The IF bandwidth of SPA between 30MHz to 1GHz was 120kHz.
5. Frequency (MHz) = Emission frequency in MHz
 Reading (dBuV) = Receiver reading
 Correction Factor(dB/m) = Antenna factor + Cable loss – Amplifier gain
 Actual FS (dBuV/m) = Reading (dBuV) + Corr. Factor (dB/m)
 Limit (dBuV/m) = Limit stated in standard
 Margin(dB) = Measured (dBuV/m) – Limits (dBuV/m)
 Antenna Pole(V/H) = Current carrying line of reading



Above 1 GHz

Operation Mode: TX / CH Low

Test Date: October 29, 2015

Temperature: 24°C

Tested by: Ad Gan

Humidity: 52% RH

Polarity: Ver. / Hor.

Frequency (MHz)	Reading (dBuV)	Correction Factor (dB/m)	Result (dBuV/m)	Limit (dBuV/m)	Margin (dB)	Antenna Pole (V/H)	Remark
2215.000	50.77	-3.82	46.95	74.00	-27.05	V	peak
2530.000	44.65	-2.21	42.44	74.00	-31.56	V	peak
4105.000	40.60	1.96	42.56	74.00	-31.44	V	peak
4807.000	48.04	4.35	52.39	74.00	-21.61	V	peak
4807.000	30.75	4.35	35.10	54.00	-18.90	V	AVG
7219.000	46.33	8.13	54.46	74.00	-19.54	V	peak
7219.000	30.77	8.13	38.90	54.00	-15.10	V	AVG
9622.000	43.23	10.89	54.12	74.00	-19.88	V	peak
9622.000	25.91	10.89	36.80	54.00	-17.20	V	AVG
2215.000	44.43	-3.82	40.61	74.00	-33.39	H	peak
2557.000	44.03	-2.16	41.87	74.00	-32.13	H	peak
3925.000	41.76	1.27	43.03	74.00	-30.97	H	peak
4807.000	52.43	4.35	56.78	74.00	-17.22	H	peak
4807.000	34.45	4.35	38.80	54.00	-15.20	H	AVG
7219.000	51.04	8.13	59.17	74.00	-14.83	H	peak
7219.000	33.17	8.13	41.30	54.00	-12.70	H	AVG
9622.000	45.25	10.89	56.14	74.00	-17.86	H	peak
9622.000	27.41	10.89	38.30	54.00	-15.70	H	AVG

Notes:

1. Measuring frequencies from 1 GHz to the 10th harmonic of highest fundamental frequency.
2. Measurements above show only up to 6 maximum emissions noted, or would be lesser if no specific emissions from the EUT are recorded (ie: margin>20dB from the applicable limit) and considered that's already beyond the background noise floor.
3. Radiated emissions measured in frequency above 1000MHz were made with an instrument using Peak detector mode and average detector mode of the emission shown in Actual FS column.
4. Spectrum setting:
 - a. Peak Setting 1GHz - 26GHz, RBW = 1MHz, VBW = 1MHz, Sweep time = 200 ms.
 - b. AV Setting 1GH z- 26GHz, RBW = 1MHz, VBW = 10Hz, Sweep time = 200 ms.
5. Frequency (MHz) = Emission frequency in MHz
 Reading (dBuV/m) =Uncorrected Analyzer / Receiver Reading
 Correction Factor (dB) = Antenna factor + Cable loss – Amplifier gain
 Limit (dBuV/m) = Limit stated in standard
 Margin (dB) = Result (dBuV/m)- Limit (dBuV/m)
 Pk = Peak Reading
 AV. = Average Reading
 Remark = Mark Peak Reading or Average Reading



Operation Mode: TX / CH Mid

Test Date: October 29, 2015

Temperature: 24°C

Tested by: Ad Gan

Humidity: 52% RH

Polarity: Ver. / Hor.

Frequency (MHz)	Reading (dBuV)	Correction Factor (dB/m)	Result (dBuV/m)	Limit (dBuV/m)	Margin (dB)	Antenna Pole (V/H)	Remark
2242.000	49.98	-3.67	46.31	74.00	-27.69	V	peak
3250.000	42.23	-0.94	41.29	74.00	-32.71	V	peak
4024.000	41.21	1.67	42.88	74.00	-31.12	V	peak
4861.000	45.47	4.53	50.00	74.00	-24.00	V	peak
5311.000	43.18	5.53	48.71	74.00	-25.29	V	peak
7291.000	46.18	8.27	54.45	74.00	-19.55	V	peak
7291.000	28.83	8.27	37.10	54.00	-16.90	V	AVG
2530.000	43.98	-2.21	41.77	74.00	-32.23	H	peak
3799.000	42.24	0.74	42.98	74.00	-31.02	H	peak
4348.000	41.05	2.81	43.86	74.00	-30.14	H	peak
4861.000	50.43	4.53	54.96	74.00	-19.04	H	peak
4861.000	32.67	4.53	37.20	54.00	-16.80	H	AVG
7291.000	49.26	8.27	57.53	74.00	-16.47	H	peak
7291.000	31.43	8.27	39.70	54.00	-14.30	H	AVG
9721.000	43.36	11.18	54.54	74.00	-19.46	H	peak
9721.000	25.62	11.18	36.80	54.00	-17.20	H	AVG

Notes:

1. Measuring frequencies from 1 GHz to the 10th harmonic of highest fundamental frequency.
2. Measurements above show only up to 6 maximum emissions noted, or would be lesser if no specific emissions from the EUT are recorded (ie: margin>20dB from the applicable limit) and considered that's already beyond the background noise floor.
3. Radiated emissions measured in frequency above 1000MHz were made with an instrument using Peak detector mode and average detector mode of the emission shown in Actual FS column.
4. Spectrum setting:
 - a. Peak Setting 1GHz - 26GHz, RBW = 1MHz, VBW = 1MHz, Sweep time = 200 ms.
 - b. AV Setting 1GH z- 26GHz, RBW = 1MHz, VBW = 10Hz, Sweep time = 200 ms.
5. Frequency (MHz) = Emission frequency in MHz
 Reading (dBuV/m) =Uncorrected Analyzer / Receiver Reading
 Correction Factor (dB) = Antenna factor + Cable loss – Amplifier gain
 Limit (dBuV/m) = Limit stated in standard
 Margin (dB) = Result (dBuV/m)- Limit (dBuV/m)
 Pk = Peak Reading
 AV. = Average Reading
 Remark = Mark Peak Reading or Average Reading



Operation Mode: TX / CH High

Test Date: October 29, 2015

Temperature: 24°C

Tested by: Ad Gan

Humidity: 52% RH

Polarity: Ver. / Hor.

Frequency (MHz)	Reading (dBuV)	Correction Factor (dB/m)	Result (dBuV/m)	Limit (dBuV/m)	Margin (dB)	Antenna Pole (V/H)	Remark
2170.000	47.31	-4.07	43.24	74.00	-30.76	V	peak
2458.000	47.18	-2.49	44.69	74.00	-29.31	V	peak
3178.000	42.07	-1.06	41.01	74.00	-32.99	V	peak
3898.000	42.00	1.16	43.16	74.00	-30.84	V	peak
4906.000	45.18	4.67	49.85	74.00	-24.15	V	peak
7363.000	44.32	8.41	52.73	74.00	-21.27	V	peak
7363.000	26.89	8.41	35.30	54.00	-18.70	V	AVG
2521.000	43.55	-2.22	41.33	74.00	-32.67	H	peak
2863.000	44.12	-1.61	42.51	74.00	-31.49	H	peak
3835.000	41.73	0.89	42.62	74.00	-31.38	H	peak
4906.000	49.42	4.67	54.09	74.00	-19.91	H	peak
4906.000	31.43	4.67	36.10	54.00	-17.90	H	AVG
7363.000	47.50	8.41	55.91	74.00	-18.09	H	peak
7363.000	29.69	8.41	38.10	54.00	-15.90	H	AVG
9820.000	45.09	11.46	56.55	74.00	-17.45	H	peak
9820.000	26.84	11.46	38.30	54.00	-15.70	H	AVG

Notes:

- Measuring frequencies from 1 GHz to the 10th harmonic of highest fundamental frequency.
- Measurements above show only up to 6 maximum emissions noted, or would be lesser if no specific emissions from the EUT are recorded (ie: margin>20dB from the applicable limit) and considered that's already beyond the background noise floor.
- Radiated emissions measured in frequency above 1000MHz were made with an instrument using Peak detector mode and average detector mode of the emission shown in Actual FS column.
- Spectrum setting:
 - Peak Setting 1GHz - 26GHz, RBW = 1MHz, VBW = 1MHz, Sweep time = 200 ms.
 - AV Setting 1GHz - 26GHz, RBW = 1MHz, VBW = 10Hz, Sweep time = 200 ms.
- Frequency (MHz) = Emission frequency in MHz

Reading (dBuV/m) = Uncorrected Analyzer / Receiver Reading

Correction Factor (dB) = Antenna factor + Cable loss – Amplifier gain

Limit (dBuV/m) = Limit stated in standard

Margin (dB) = Result (dBuV/m) - Limit (dBuV/m)

Pk = Peak Reading

AV = Average Reading

Remark = Mark Peak Reading or Average Reading



6.10 POWERLINE CONDUCTED EMISSIONS

LIMIT

For an intentional radiator which is designed to be connected to the public utility (AC) power line, the radio frequency voltage that is conducted back onto the AC power line on any frequency or frequencies within the band 150 kHz to 30 MHz shall not exceed 250 microvolts (The limit decreases linearly with the logarithm of the frequency in the range 0.15 MHz to 0.50 MHz). The limits at specific frequency range is listed as follows:

Frequency Range (MHz)	Limits (dB μ V)	
	Quasi-peak	Average
0.15 to 0.50	66 to 56	56 to 46
0.50 to 5	56	46
5 to 30	60	50

Compliance with this provision shall be based on the measurement of the radio frequency voltage between each power line (LINE and NEUTRAL) and ground at the power terminals.

MEASUREMENT EQUIPMENT USED

Conducted Emission Test Site					
Name of Equipment	Manufacturer	Model Number	Serial Number	Last Calibration	Due Calibration
EMI TEST RECEIVER	ROHDE&SCHWARZ	ESCI	100783	02/28/2015	02/27/2016
LISN(EUT)	ROHDE&SCHWARZ	ENV216	101543-WX	02/28/2015	02/27/2016
LISN	EMCO	3825/2	8901-1459	02/28/2015	02/27/2016
Temp. / Humidity Meter	VICTOR	HTC-1	N/A	02/28/2015	02/27/2016
Test S/W	FARAD	EZ-EMC/ CCS-3A1-CE			

Remark: Each piece of equipment is scheduled for calibration once a year.



TEST CONFIGURATION

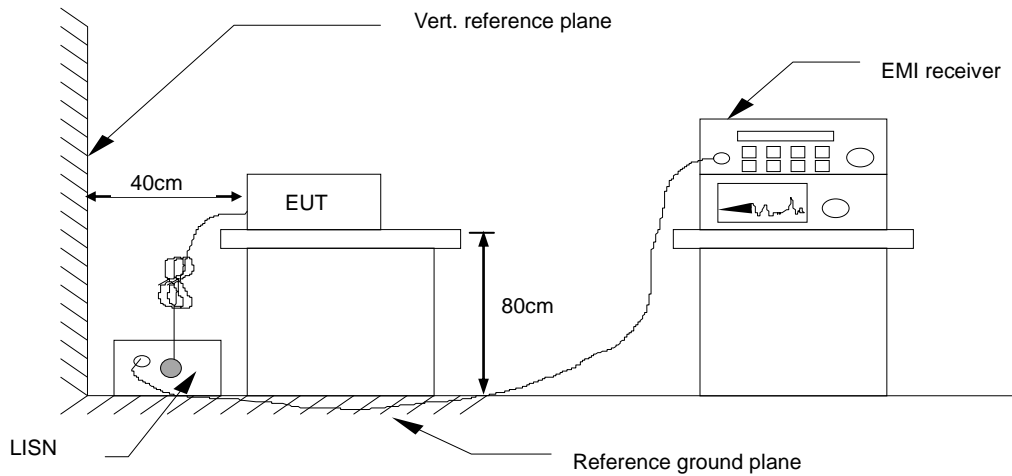

See test photographs attached in Appendix 1 for the actual connections between EUT and support equipment.

TEST PROCEDURE

1. The EUT was placed on a table, which is 0.8m above ground plane.
2. Maximum procedure was performed on the six highest emissions to ensure EUT compliance.
3. Repeat above procedures until all frequency measured were complete.

TEST RESULTS

The initial step in collecting conducted data is a spectrum analyzer peak scan of the measurement range. Significant peaks are then marked as shown on the following data page, and these signals are then quasi-peaked.



Test Data

Operation Mode: TX

Test Date: November 10, 2015

Temperature: 22°C

Humidity: 45% RH

Tested by: Ad Gan

Line L1

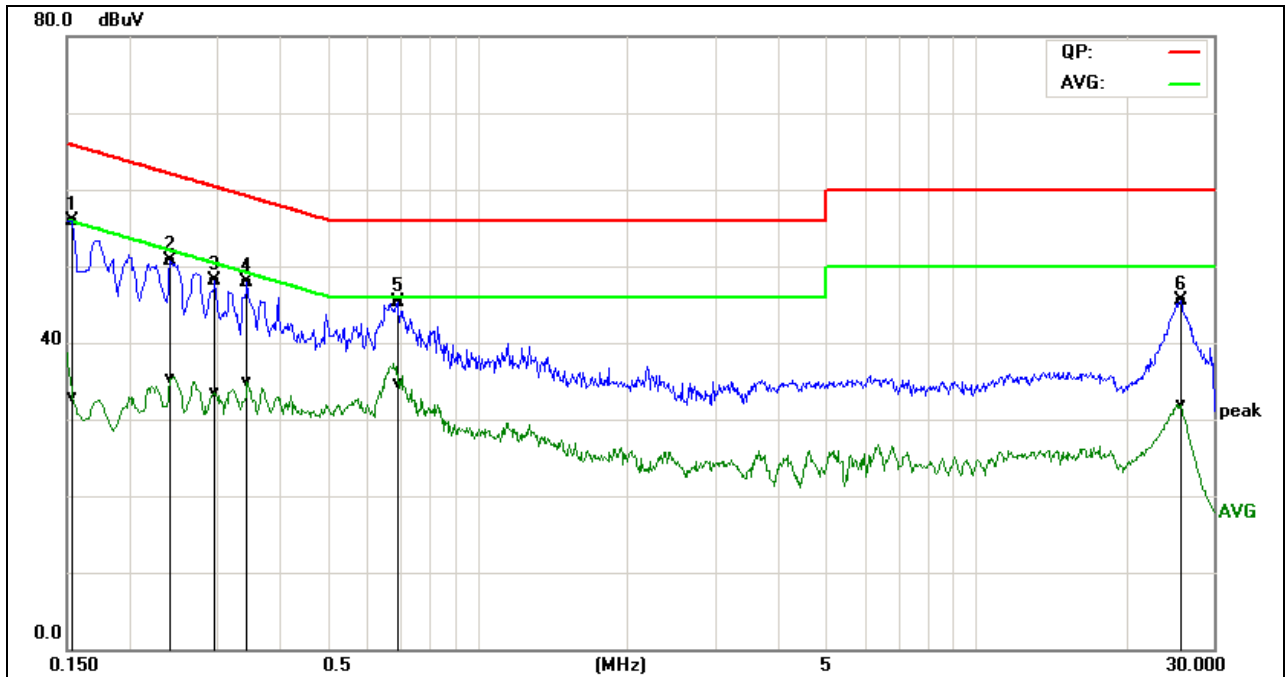

Frequency (MHz)	QuasiPeak Reading (dBuV)	Average Reading (dBuV)	Correction Factor (dB)	QuasiPeak Result (dBuV)	Average Result (dBuV)	QuasiPeak Limit (dBuV)	Average Limit (dBuV)	QuasiPeak Margin (dB)	Average Margin (dB)	Remark
0.1539	46.29	23.25	9.59	55.88	32.84	65.78	55.79	-9.90	-22.95	Pass
0.2420	41.01	25.63	9.69	50.70	35.32	62.02	52.03	-11.32	-16.71	Pass
0.2980	38.36	23.85	9.69	48.05	33.54	60.30	50.30	-12.25	-16.76	Pass
0.3460	38.21	25.22	9.69	47.90	34.91	59.06	49.06	-11.16	-14.15	Pass
0.6900	35.57	25.00	9.78	45.35	34.78	56.00	46.00	-10.65	-11.22	Pass
25.7460	35.62	21.97	9.90	45.52	31.87	60.00	50.00	-14.48	-18.13	Pass

Note:

1. Measuring frequencies from 0.15 MHz to 30MHz.
2. The emissions measured in frequency range from 0.15 MHz to 30MHz were made with an instrument using Peak detector, Quasi-peak detector and average detector.
3. “---” denotes the emission level was or more than 2dB below the Average limit.
4. The IF bandwidth of SPA between 0.15MHz to 30MHz was 10kHz; the IF bandwidth of Test Receiver between 0.15MHz to 30MHz was 9kHz;
5. L1= Line One (Live Line)



Operation Mode: TX

Test Date: November 10, 2015

Temperature: 22°C

Humidity: 45% RH

Tested by: Ad Gan

Line L2

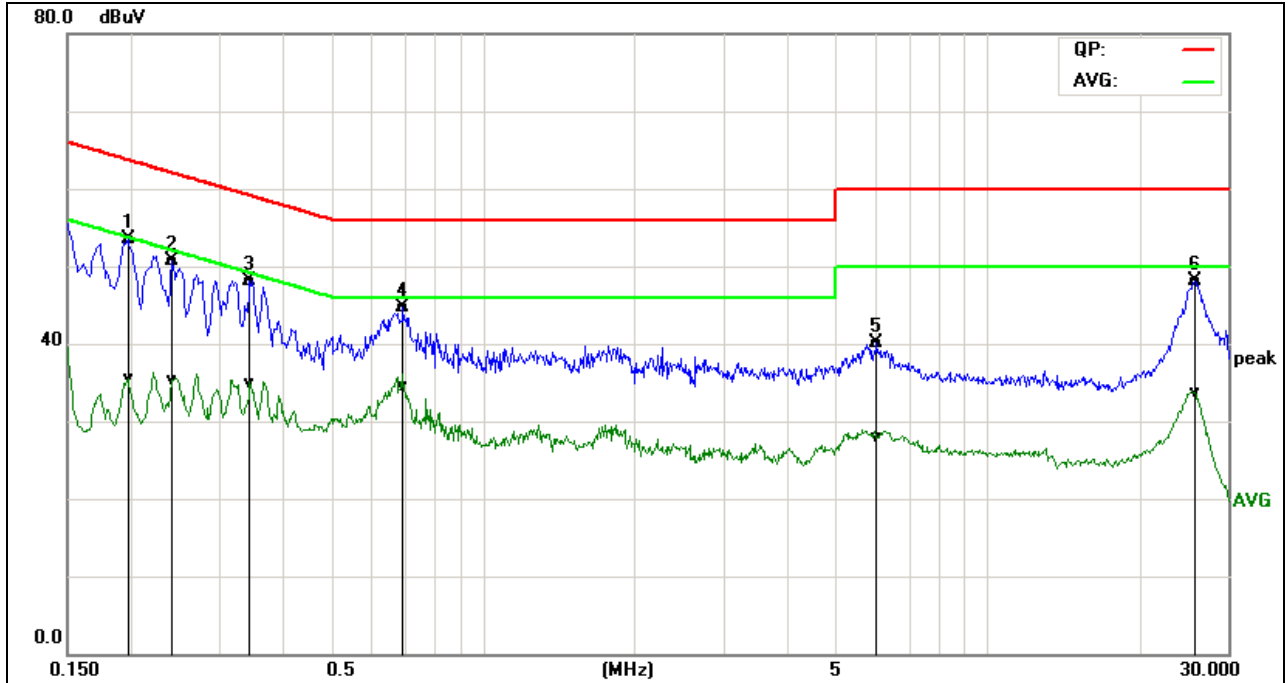

Frequency (MHz)	QuasiPeak Reading (dBuV)	Average Reading (dBuV)	Correction Factor (dB)	QuasiPeak Result (dBuV)	Average Result (dBuV)	QuasiPeak Limit (dBuV)	Average Limit (dBuV)	QuasiPeak Margin (dB)	Average Margin (dB)	Remark
0.1980	43.63	25.62	9.79	53.42	35.41	63.69	53.69	-10.27	-18.28	Pass
0.2420	40.87	25.52	9.78	50.65	35.30	62.02	52.03	-11.37	-16.73	Pass
0.3460	38.33	25.26	9.74	48.07	35.00	59.06	49.06	-10.99	-14.06	Pass
0.6940	35.01	24.90	9.69	44.70	34.59	56.00	46.00	-11.30	-11.41	Pass
6.0340	30.37	18.13	9.78	40.15	27.91	60.00	50.00	-19.85	-22.09	Pass
25.7580	38.32	23.89	9.81	48.13	33.70	60.00	50.00	-11.87	-16.30	Pass

Note:

1. Measuring frequencies from 0.15 MHz to 30MHz.
2. The emissions measured in frequency range from 0.15 MHz to 30MHz were made with an instrument using Peak detector, Quasi-peak detector and average detector.
3. “---” denotes the emission level was or more than 2dB below the Average limit.
4. The IF bandwidth of SPA between 0.15MHz to 30MHz was 10kHz; the IF bandwidth of Test Receiver between 0.15MHz to 30MHz was 9kHz;
5. L2 = Line Two (Neutral Line)