



**FCC 47 CFR PART 15 SUBPART C**

**TEST REPORT**

For

**3CH 2.4GHZ FHSS RADIO CONTROL SYSTEM**

**Model: MT-305**

**Brand: MERITRC**

**Test Report Number:**

**C140605Z05-RP1**

*Prepared for*

**Shanghai Merit Technology Corporation.**

**1058 Taogan road, Sheshan, Songjiang District, Shanghai, China.**

*Prepared by*

**COMPLIANCE CERTIFICATION SERVICES (SHENZHEN) INC.**

**No.10-1, Mingkeda Logistics Park, No.18, Huanguan South Rd.,  
Guan Lan Town, Baoan District, Shenzhen China**

**TEL: 86-755-28055000**

**FAX: 86-755-28055221**

**Issued Date: July 3, 2014**



**Note:** This report shall not be reproduced except in full, without the written approval of Compliance Certification Services Inc. This document may be altered or revised by Compliance Certification Services Inc. personnel only, and shall be noted in the revision section of the document. The client should not use it to claim product endorsement by TAF, A2LA, NVLAP, NIST or any government agencies. The test result of this report relate only to the tested sample identified in this report.



Revision History

Rev.	Issue Data	Revisions	Effect Page	Revised By
00	July 3, 2014	Initial Issue	ALL	Sinphy Xie



---

**TABLE OF CONTENTS**

**1. TEST RESULT CERTIFICATION .....4**

**2. EUT DESCRIPTION.....5**

**3. TEST METHODOLOGY.....6**

    3.1 DESCRIPTION OF TEST MODES .....6

**4. FACILITIES AND ACCREDITATIONS .....7**

    4.1 FACILITIES.....7

    4.2 ACCREDITATIONS .....7

    4.3 MEASUREMENT UNCERTAINTY .....7

**5. SETUP OF EQUIPMENT UNDER TEST .....8**

    5.1 SETUP CONFIGURATION OF EUT .....8

    5.2 SUPPORT EQUIPMENT .....8

**6. FCC PART 15.247 REQUIREMENTS .....9**

    6.1 20dB BANDWIDTH.....9

    6.2 PEAK POWER.....12

    6.3 PEAK POWER SPECTRAL DENSITY .....14

    6.4 BAND EDGES MEASUREMENT .....15

    6.5 FREQUENCY SEPARATION .....21

    6.6 NUMBER OF HOPPING FREQUENCY .....23

    6.7 TIME OF OCCUPANCY (DWELL TIME).....25

    6.8 SPURIOUS EMISSIONS .....28

    6.9 POWERLINE CONDUCTED EMISSIONS .....40



# 1. TEST RESULT CERTIFICATION

<b>Product:</b>	3CH 2.4GHz FHSS RADIO CONTROL SYSTEM
<b>Model:</b>	MT-305
<b>Brand:</b>	MERITRC
<b>Tested:</b>	June 5~ June 30, 2014
<b>Applicant:</b>	<b>Shanghai Merit Technology Corporation.</b> 1058 Taogan road, Sheshan, Songjiang District, Shanghai, China.
<b>Manufacturer:</b>	<b>Shanghai Merit Technology Corporation.</b> 1058 Taogan road, Sheshan, Songjiang District, Shanghai, China.

APPLICABLE STANDARDS	
STANDARD	TEST RESULT
FCC 47 CFR Part 15 Subpart C	No non-compliance noted

### We hereby certify that:

The above equipment was tested by Compliance Certification Services Inc. The test data, data evaluation, test procedures, and equipment configurations shown in this report were made in accordance with the procedures given in ANSI C63.4:2009 and the energy emitted by the sample EUT tested as described in this report is in compliance with conducted and radiated emission limits of FCC Rules Part 15.207, 15.209 and 15.247.

The test results of this report relate only to the tested sample EUT identified in this report.

**Approved by:**

**Reviewed by:**

---

**Sunday Hu**  
Supervisor of EMC Dept.  
Compliance Certification Service Inc.

---

**Ruby Zhang**  
Supervisor of Report Dept.  
Compliance Certification Service Inc.



## 2. EUT DESCRIPTION

<b>Product</b>	3CH 2.4GHz FHSS RADIO CONTROL SYSTEM
<b>Model Number</b>	MT-305
<b>Brand</b>	MERITRC
<b>Model Discrepancy</b>	N/A
<b>Identify Number</b>	C140605Z05-RP1
<b>Power Supply</b>	DC6V supplied by the battery or DC6V supplied by the adapter
<b>Received Date</b>	June 5,2014
<b>Frequency Range</b>	2405-2455MHz
<b>Transmit Power</b>	Peak: 10.07dBm Average : 7.81dBm
<b>Modulation Technique</b>	FHSS
<b>Number of Channels</b>	51 Channels
<b>Antenna Specification</b>	Dipole Antenna with 2dBi (Max)
<b>Temperature Range</b>	0°C ~ +60°C
<b>Hardware Version</b>	V1.1
<b>Software Version</b>	V1.0

**Note:** This submittal(s) (test report) is intended for FCC ID: XJ6MT-305 filing to comply with Section 15.207, 15.209 and 15.247 of the FCC Part 15, Subpart C Rules.



### 3. TEST METHODOLOGY

#### 3.1 DESCRIPTION OF TEST MODES

The EUT has been tested under operating condition.

Test program used to control the EUT for staying in continuous transmitting and receiving mode is programmed.

The following test mode(s) were scanned during the preliminary test below 1G:

Test Item	Test mode	Worse mode
Conducted Emission	<b>Mode 1: Charge</b>	<input checked="" type="checkbox"/>
Radiated Emission	<b>Mode 1: TX</b>	<input checked="" type="checkbox"/>

Above 1G, Channel Low (2405MHz) · Mid (2430MHz) and High (2455MHz) were chosen for full testing for GFSK.



## 4. FACILITIES AND ACCREDITATIONS

### 4.1 FACILITIES

All measurement facilities used to collect the measurement data are located at

- No.10-1, Mingkeda Logistics Park, No.18, Huanguan South Rd., Guan Lan Town, Baoan District, Shenzhen, China**

The sites are constructed in conformance with the requirements of ANSI C63.4:2009, ANSI C63.7 and CISPR Publication 22. All receiving equipment conforms to CISPR Publication 16-1, "Radio Interference Measuring Apparatus and Measurement Methods."

### 4.2 ACCREDITATIONS

Our laboratories are accredited and approved by the following accreditation body according to ISO/IEC 17025.

<b>USA</b>	A2LA
<b>China</b>	CNAS

The measuring facility of laboratories has been authorized or registered by the following approval agencies.

<b>USA</b>	FCC
<b>Japan</b>	VCCI(C-3478, R-3135, T-652, G-624)
<b>Canada</b>	INDUSTRY CANADA
<b>Taiwan</b>	BSMI
<b>Norway</b>	Nemko

Copies of granted accreditation certificates are available for downloading from our web site, <http://www.ccsrf.com>

### 4.3 MEASUREMENT UNCERTAINTY

Where relevant, the following measurement uncertainty levels have been estimated for tests performed on the EUT as specified in CISPR 16-4-2:

Parameter	Uncertainty
Radiated Emission, 30 to 200 MHz Test Site : 966(2)	+/-3.6880dB
Radiated Emission, 200 to 1000 MHz Test Site : 966(2)	+/-3.6695dB
Radiated Emission, 1 to 8 GHz	+/-5.1782dB
Radiated Emission, 8 to 18 GHz	+/-5.2173dB
Conducted Emissions	+/-3.6836dB
Band Width	178kHz
Peak Output Power MU	+/-1.906dB
Band Edge MU	+/-0.182dB
Channel Separation MU	416.178Hz
Duty Cycle MU	0.054ms
Frequency Stability MU	226Hz

This uncertainty represents an expanded uncertainty expressed at approximately the 95% confidence level using a coverage factor of k=2.

The measured result is above (below) the specification limit by a margin less than the measurement uncertainty; it is therefore not possible to state compliance based on the 95% level of confidence. However, the result indicates that compliance (non-compliance) is more probable than non-compliance) with the specification limit.



## 5. SETUP OF EQUIPMENT UNDER TEST

### 5.1 SETUP CONFIGURATION OF EUT

See test photographs attached in Appendix 1 for the actual connections between EUT and support equipment.

### 5.2 SUPPORT EQUIPMENT

No.	Equipment	Model No.	Serial No.	FCC ID	Brand	Data Cable	Power Cord
1	3CH 2.4GHz FHSS RADIO CONTROL SYSTEM(RX)	MR-303	N/A	N/A	MERITRC	N/A	N/A
2	Adapter	CS12B060100 FG	N/A	N/A	CSEC	N/A	Unshielded 1.5m
3	Load*3	N/A	N/A	N/A	N/A	Unshielded 0.12m	N/A
4	Battery	N/A	N/A	N/A	N/A	N/A	Unshielded 0.12m

**Notes:**

*Grounding was established in accordance with the manufacturer's requirements and conditions for the intended use.*





## 6. FCC PART 15.247 REQUIREMENTS

### 6.1 20DB BANDWIDTH

None; for reporting purpose only.

#### MEASUREMENT EQUIPMENT USED

Name of Equipment	Manufacturer	Model	Serial Number	Last Calibration	Due Calibration
Spectrum Analyzer	Agilent	E4446A	US44300399	03/01/2014	03/01/2015

*Remark: Each piece of equipment is scheduled for calibration once a year.*

#### TEST CONFIGURATION

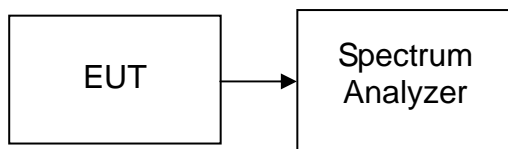

#### TEST PROCEDURE

1. Place the EUT on the table and set it in the transmitting mode.
2. Remove the antenna from the EUT, then connect a low loss RF cable from antenna port to the spectrum analyzer.
3. Set the spectrum analyzer as RBW=30kHz, VBW=100kHz, Span=3MHz, Sweep = auto.
4. Mark the peak frequency and 20dB (upper and lower) frequency.
5. Repeat until all the test channels are investigated.

#### TEST RESULTS

No non-compliance noted



Test plot

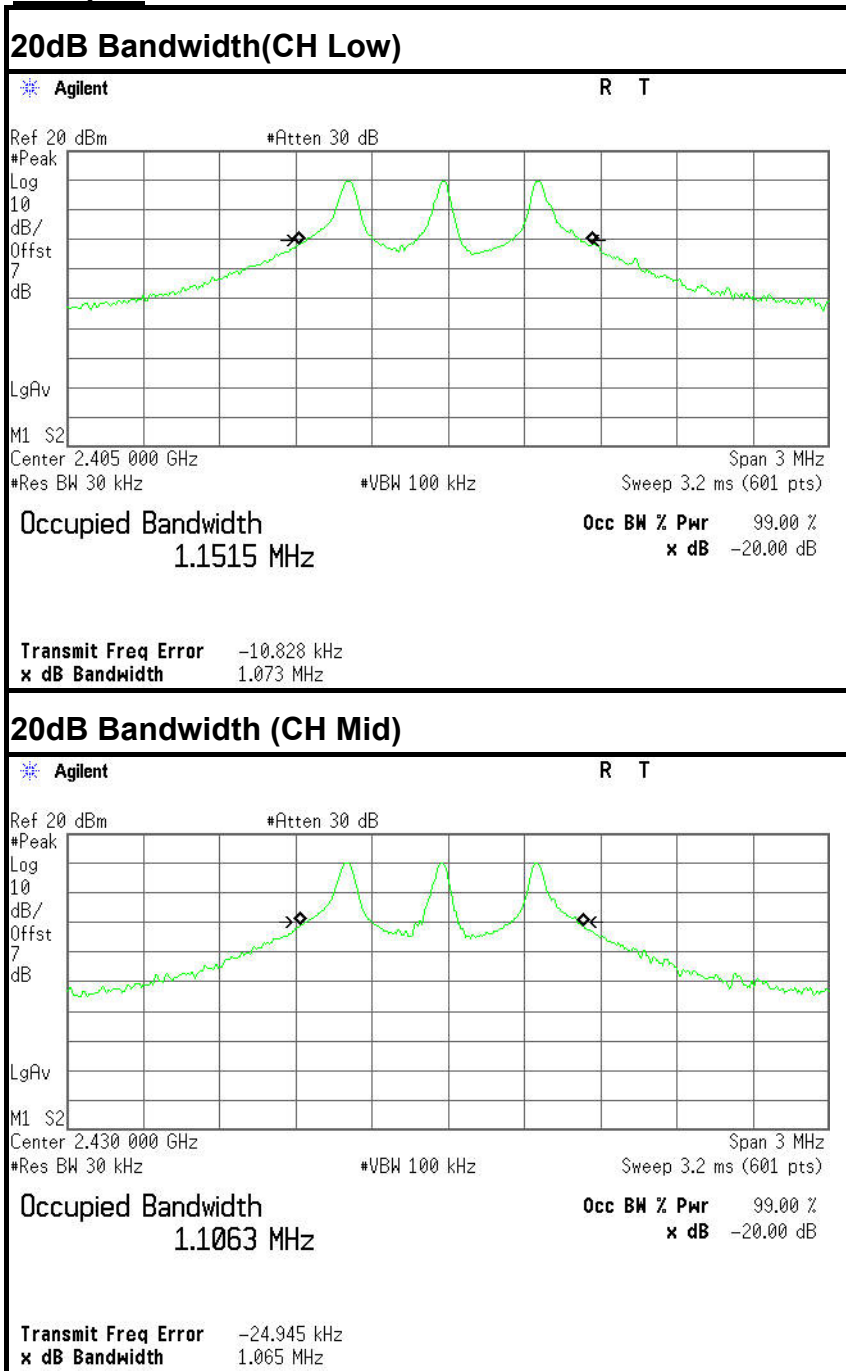



### 20dB Bandwidth (CH High)

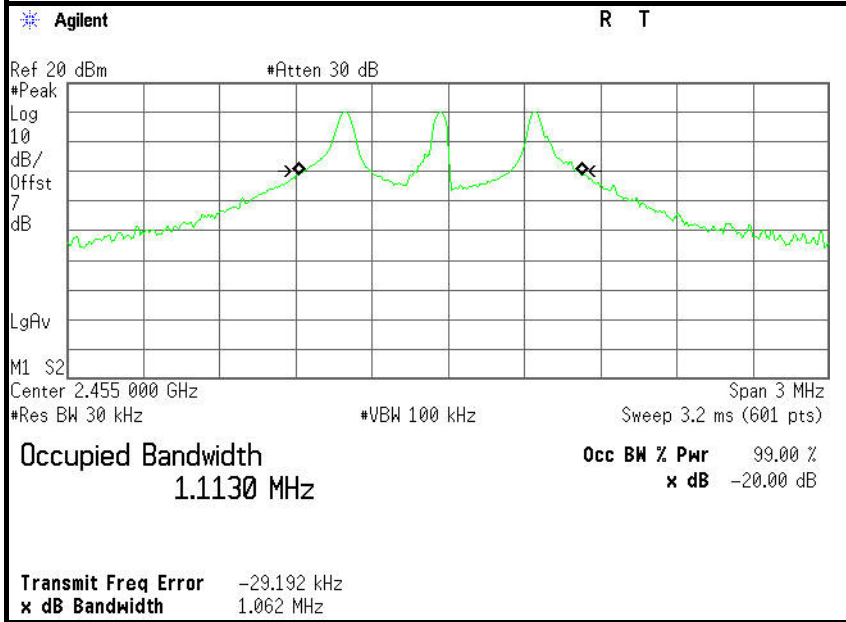



## 6.2 PEAK POWER

### LIMIT

The maximum peak output power of the intentional radiator shall not exceed the following:

1. For frequency hopping systems operating in the 2400-2483.5 MHz band employing at least 75 non-overlapping hopping channels, and all frequency hopping systems in the 5725-5850 MHz band: 1 watt. For all other frequency hopping systems in the 2400-2483.5 MHz band: 0.125 watts.
2. Except as shown in paragraphs (b)(3) (i), (ii) and (iii) of this section, if transmitting antennas of directional gain greater than 6dBi are used the peak output power from the intentional radiator shall be reduced below the stated values in paragraphs (b)(1) or (b)(2) of this section, as appropriate, by the amount in dB that the directional gain of the antenna exceeds 6dBi.
3. The conducted output power limit specified in paragraph (b) of this section is based on the use of antennas with directional gains that do not exceed 6 dBi. Except as shown in paragraph (c) of this section, if transmitting antennas of directional gain greater than 6 dBi are used, the conducted output power from the intentional radiator shall be reduced below the stated values in paragraphs (b)(1), (b)(2), and (b)(3) of this section, as appropriate, by the amount in dB that the directional gain of the antenna exceeds 6 dBi.

### MEASUREMENT EQUIPMENT USED

Name of Equipment	Manufacturer	Model	Serial Number	Last Calibration	Due Calibration
Power Meter	Anritsu	ML2495A	1204003	03/01/2014	03/01/2015
Power Sensor	Anritsu	MA2411B	1126150	03/01/2014	03/01/2015
Spectrum Analyzer	Agilent	E4446A	US44300399	03/01/2014	03/01/2015

*Remark: Each piece of equipment is scheduled for calibration once a year.*

### Test Configuration

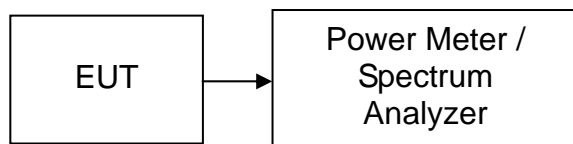

### TEST PROCEDURE

The transmitter output is connected to the RF Power Meter. The RF Power Meter is set to the peak power detection.



**TEST RESULTS**

*No non-compliance noted*

**Test Data**

Channel	Frequency (MHz)	Reading Power (dBm)	Factor (dB)	Output Power (dBm)	Output Power (W)	Limit (W)	Peak / Average	Result
Low	2405	6.29	3.50	9.79	0.00953	1	Peak	PASS
Mid	2430	6.54	3.50	10.04	0.01009			PASS
High	2455	6.57	3.50	10.07	0.01016			PASS
Low	2405	3.99	3.50	7.49	0.00561	1	Average	PASS
Mid	2430	4.14	3.50	7.64	0.00581			PASS
High	2455	4.31	3.50	7.81	0.00604			PASS



### 6.3 PEAK POWER SPECTRAL DENSITY

#### LIMIT

1. For direct sequence systems, the peak power spectral density conducted from the intentional radiator to the antenna shall not be greater than 8dBm in any 3kHz band during any time interval of continuous transmission.
2. The direct sequence operating of the hybrid system, with the frequency hopping operation turned off, shall comply with the power density requirements of paragraph (d) of this section.

#### MEASUREMENT EQUIPMENT USED

Name of Equipment	Manufacturer	Model	Serial Number	Last Calibration	Due Calibration
Spectrum Analyzer	Agilent	E4446A	US44300399	03/01/2014	03/01/2015

*Remark: Each piece of equipment is scheduled for calibration once a year.*

#### Test Configuration

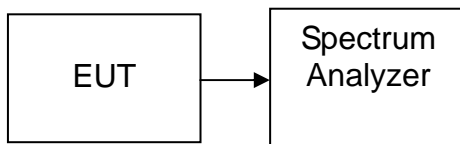

#### TEST PROCEDURE

1. Place the EUT on the table and set it in transmitting mode.
2. Remove the antenna from the EUT and then connect a low loss RF cable from the antenna port to the spectrum analyzer.
3. Set the spectrum analyzer as RBW = 3kHz, VBW = 10kHz, Span = 300kHz, Sweep=100s
4. Record the max. reading.
5. Repeat the above procedure until the measurements for all frequencies are completed.

#### TEST RESULTS

*Not applicable. Since the EUT is FHSS device.*



### 6.4 BAND EDGES MEASUREMENT

#### LIMIT

According to §15.247(c), in any 100 kHz bandwidth outside the frequency bands in which the spread spectrum intentional radiator is operating, the radio frequency power that is produced by the intentional radiator shall be at least 20dB below that in the 100kHz bandwidth within the band that contains the highest level of the desired power. In addition, radiated emissions which fall in the restricted bands, as defined in §15.205(a), must also comply with the radiated emission limits specified in 15.209(a).

#### MEASUREMENT EQUIPMENT USED

Radiated Emission Test Site 966 (2)						
Name of Equipment	Manufacturer	Model Number	Serial Number	Last Calibration	Due Calibration	
PSA Series Spectrum Analyzer	Agilent	E4446A	US44300399	03/01/2014	03/01/2015	
EMI TEST RECEIVER	ROHDE&SCHWARZ	ESCI	100783	03/09/2014	03/08/2015	
Amplifier	MITEQ	AM-1604-3000	1123808	03/18/2015	03/18/2015	
High Noise Amplifier	Agilent	8449B	3008A01838	03/18/2015	03/18/2015	
Board-Band Horn Antenna	Schwarzbeck	BBHA 9170	9170-497	07/10/2013	07/09/2014	
Bilog Antenna	SCHAFFNER	CBL6143	5082	03/01/2014	03/01/2015	
Horn Antenna	SCHWARZBECK	BBHA9120	D286	03/01/2014	03/01/2015	
Loop Antenna	COM-POWER	AL-130	121044	09/27/2013	09/26/2014	
Turn Table	N/A	N/A	N/A	N.C.R	N.C.R	
Controller	Sunol Sciences	SC104V	022310-1	N.C.R	N.C.R	
Controller	CT	N/A	N/A	N.C.R	N.C.R	
Temp. / Humidity Meter	Anymetre	JR913	N/A	02/28/2014	02/28/2015	
Antenna Tower	SUNOL	TLT2	N/A	N.C.R	N.C.R	
Test S/W	FARAD	LZ-RF / CCS-SZ-3A2				

#### Test Configuration

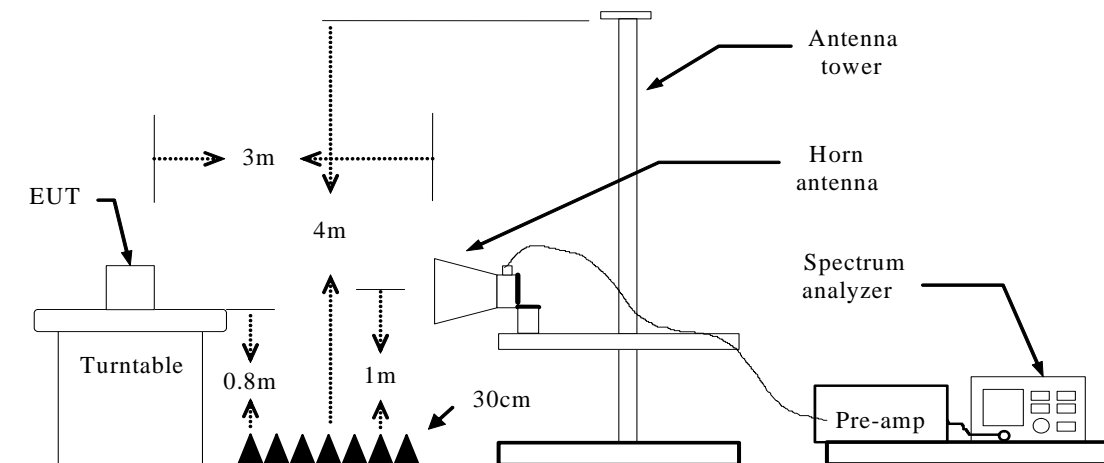



## **TEST PROCEDURE**

1. The EUT is placed on a turntable, which is 0.8m above the ground plane.
2. The turntable shall be rotated for 360 degrees to determine the position of maximum emission level.
3. EUT is set 3m away from the receiving antenna, which is varied from 1m to 4m to find out the highest emission.
4. Set the spectrum analyzer in the following setting in order to capture the lower and upper band-edges of the emission:
  - (a) PEAK: RBW=VBW=1MHz / Sweep=AUTO
  - (b) AVERAGE: RBW=1MHz / VBW=200Hz / Sweep=AUTO
5. Repeat the procedures until all the PEAK and AVERAGE versus POLARIZATION are measured.

## **TEST RESULTS**

Refer to attach spectrum analyzer data chart.





**Test Data**

**Band Edges (CH-Low)**

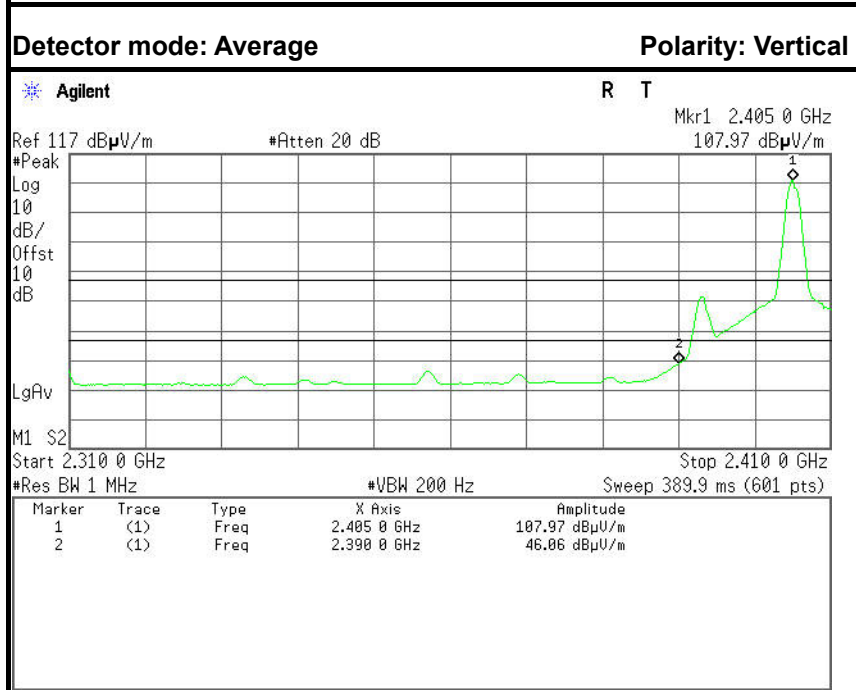
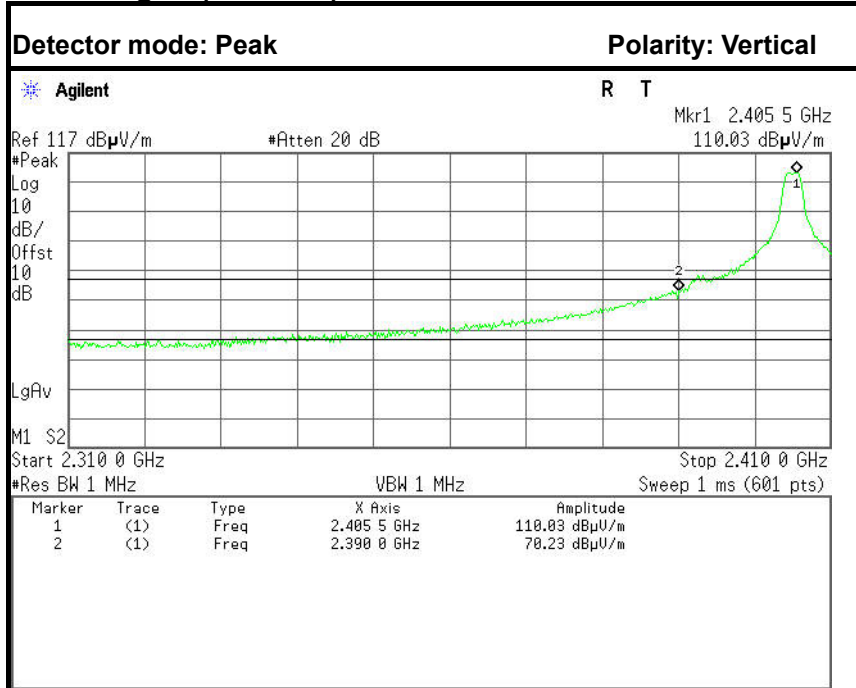

No.	Frequency (MHz)	Reading (dBuV)	Corrected (dB)	Result (dBuV)	Limit (dBuV)	Margin (dB)	Detector	Antenna Pole
1	2390.0000	63.63	-6.60	70.23	74.00	-3.77	Peak	Vertical
2	2390.0000	39.46	-6.60	46.06	54.00	-7.94	Average	Vertical

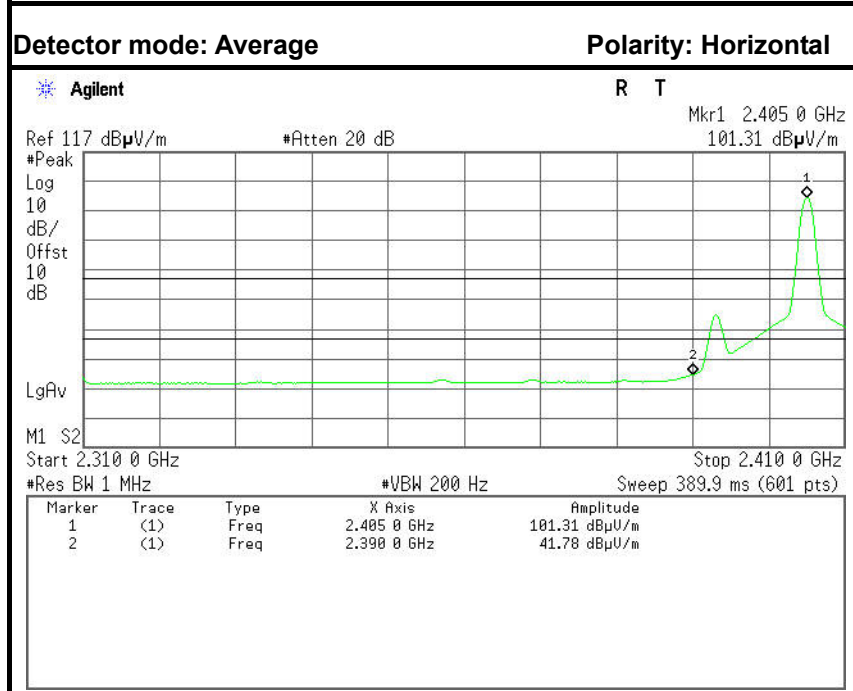
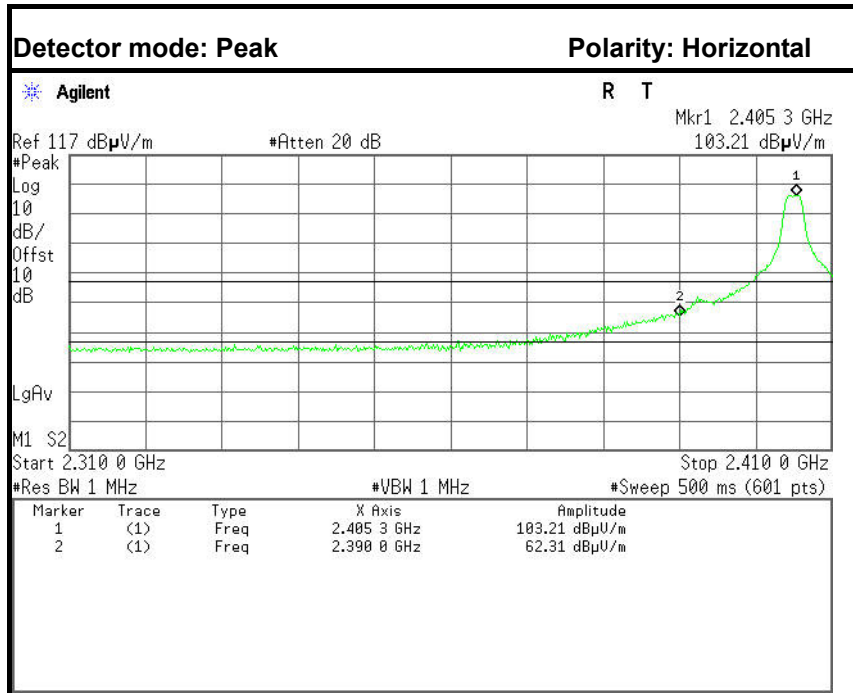

No.	Frequency (MHz)	Reading (dBuV)	Corrected (dB)	Result (dBuV)	Limit (dBuV)	Margin (dB)	Detector	Antenna Pole
1	2390.0000	55.71	-6.60	62.31	74.00	-11.69	Peak	Vertical
2	2390.0000	35.18	-6.60	41.78	54.00	-12.22	Average	Vertical



**Band Edges (CH-High)**

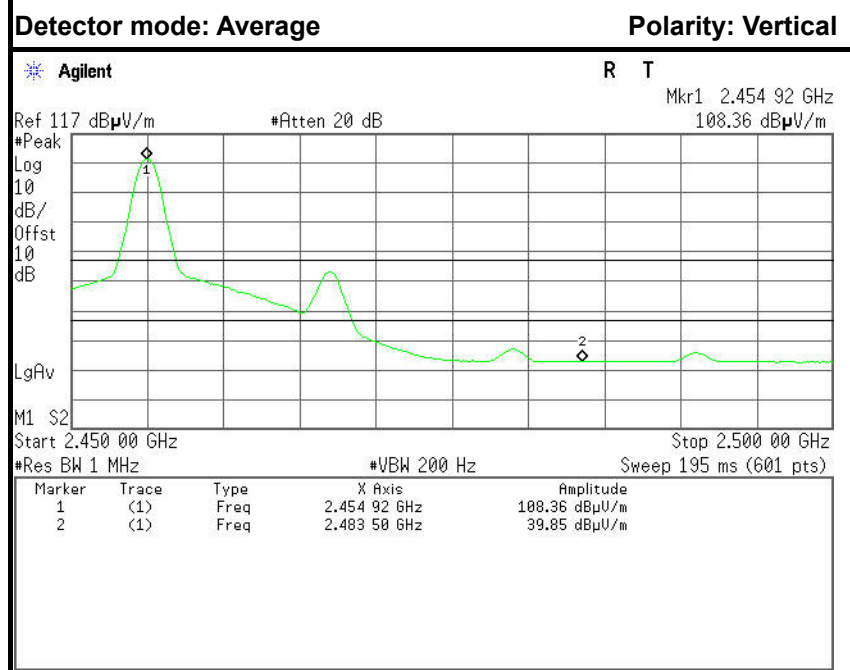
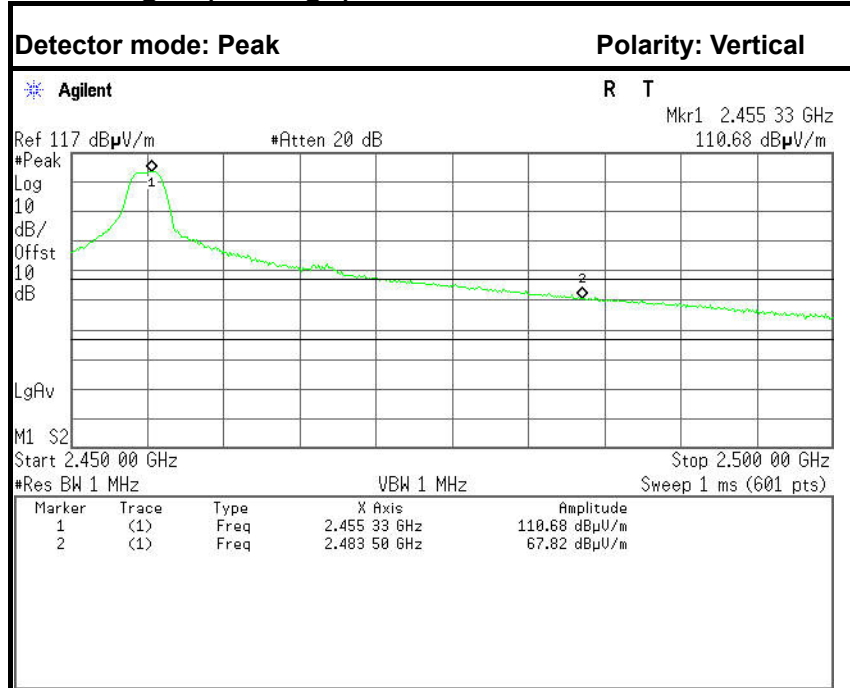

No.	Frequency (MHz)	Reading (dBuV)	Corrected (dB)	Result (dBuV)	Limit (dBuV)	Margin (dB)	Detector	Antenna Pole
1	2483.5000	61.22	-6.60	67.82	74.00	-6.18	Peak	Vertical
2	2483.5000	33.25	-6.60	39.85	54.00	-14.15	Average	Vertical

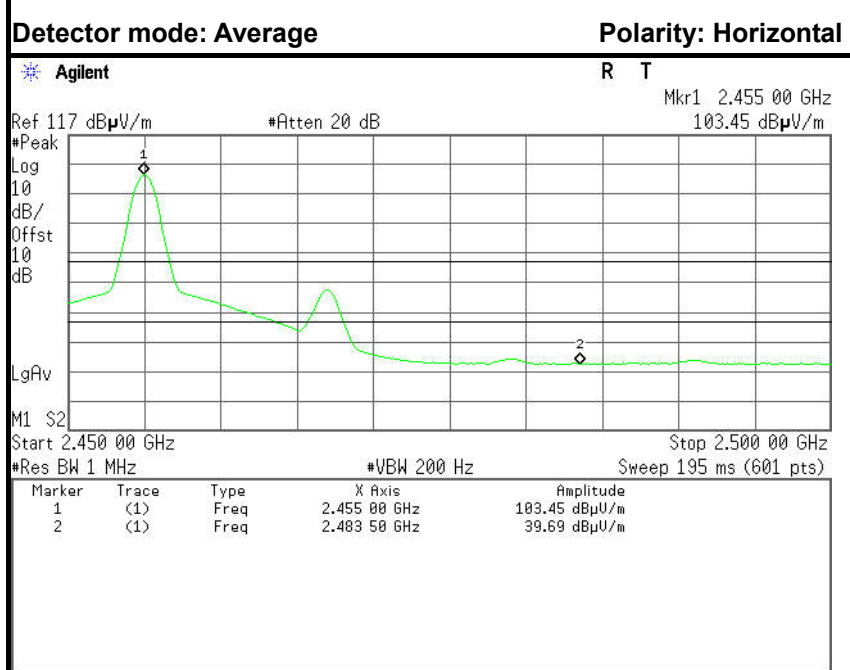
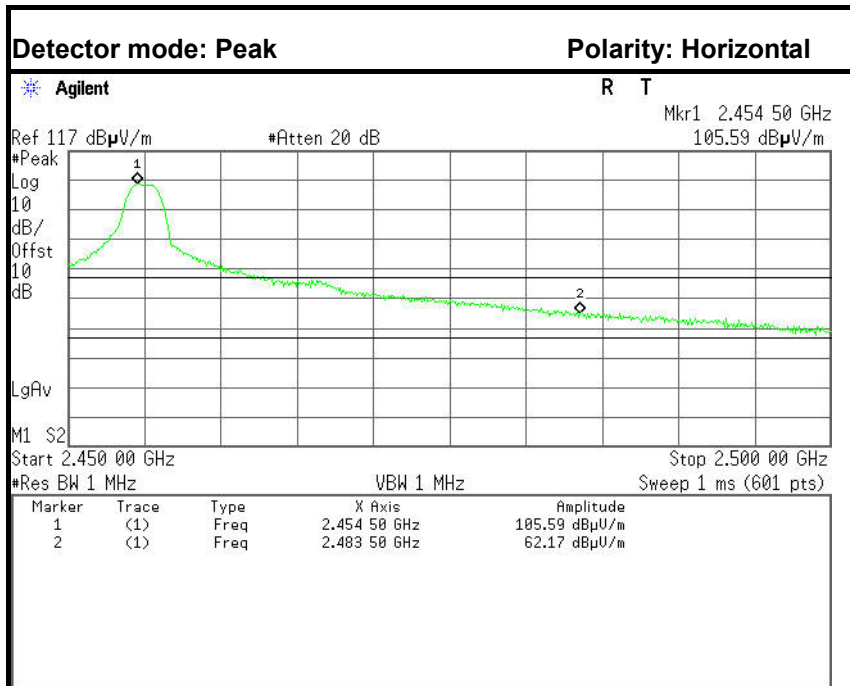

No.	Frequency (MHz)	Reading (dBuV)	Corrected (dB)	Result (dBuV)	Limit (dBuV)	Margin (dB)	Detector	Antenna Pole
1	2483.5000	55.57	-6.60	62.17	74.00	-11.83	Peak	Vertical
2	2483.5000	33.09	-6.60	39.69	54.00	-14.31	Average	Vertical



### 6.5 FREQUENCY SEPARATION

#### LIMIT

According to §15.247(a)(1), Frequency hopping systems shall have hopping channel carrier frequencies separated by a minimum of 25 kHz or the 20 dB bandwidth of the hopping channel, whichever is greater. Alternatively, frequency hopping systems operating in the 2400-2483.5 MHz band may have hopping channel carrier frequencies that are separated by 25 kHz or two-thirds of the 20 dB bandwidth of the hopping channel, whichever is greater, provided the systems operate with an output power no greater than 125 mW.

#### MEASUREMENT EQUIPMENT USED

Name of Equipment	Manufacturer	Model	Serial Number	Last Calibration	Due Calibration
Spectrum Analyzer	Agilent	E4446A	US44300399	03/01/2014	03/01/2015

*Remark: Each piece of equipment is scheduled for calibration once a year.*

#### Test Configuration

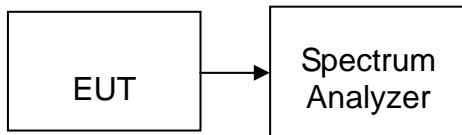

#### TEST PROCEDURE

1. Place the EUT on the table and set it in transmitting mode.
2. Remove the antenna from the EUT and then connect a low loss RF cable from the antenna port to the spectrum analyzer.
3. Set center frequency of spectrum analyzer = middle of hopping channel.
4. Set the spectrum analyzer as RBW=30kHz, VBW=30kHz, Adjust Span to 4 MHz, Sweep = auto.
5. Max hold. Mark 3 Peaks of hopping channel and record the 3 peaks frequency.

#### TEST RESULTS

*No non-compliance noted*

#### Test Data

Channel Separation (MHz)	Two-thirds of the 20 dB Bandwidth (kHz)	Channel Separation Limit	Result
1.000	715.333	> Two-thirds of the 20 dB Bandwidth	Pass



Test Plot

Measurement of Channel Separation

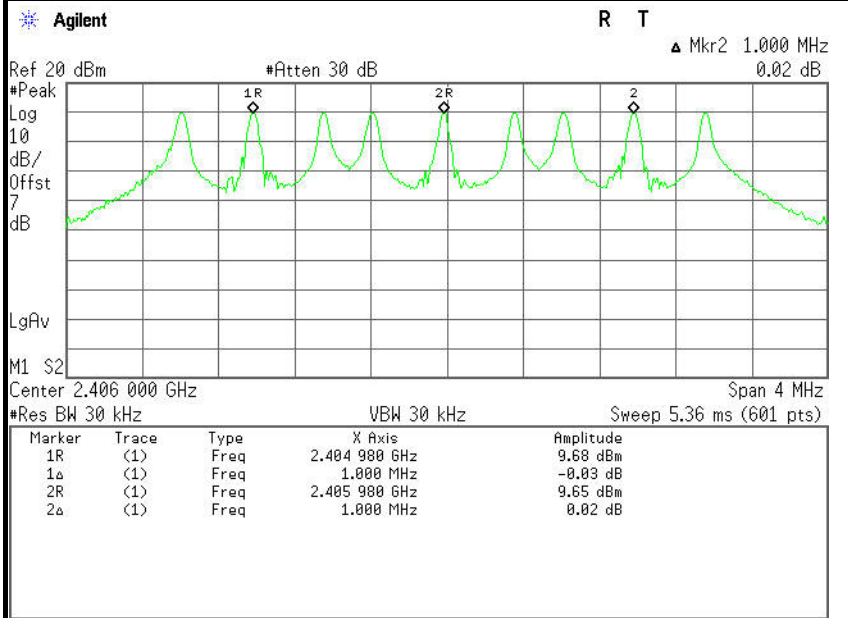

20 dB bandwidth(CH Low)

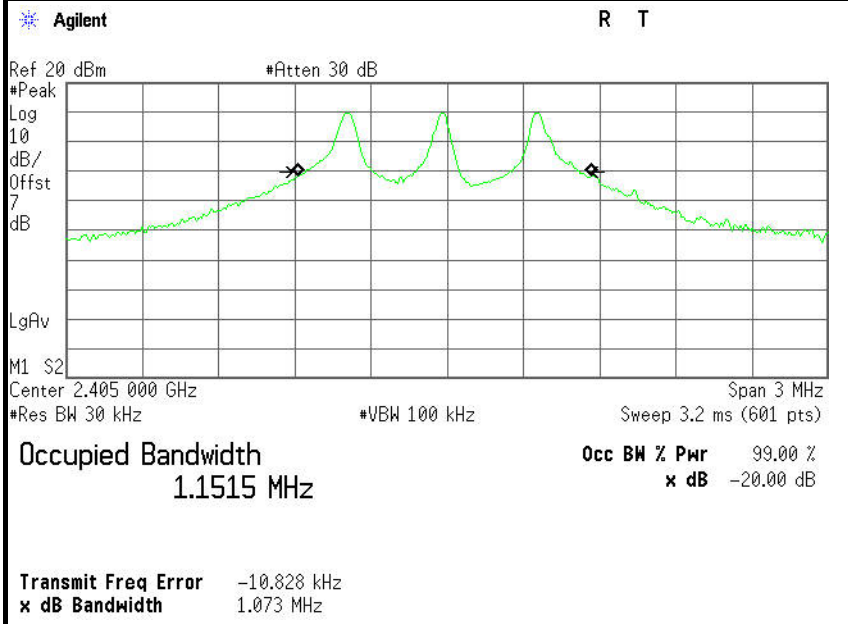



### 6.6 NUMBER OF HOPPING FREQUENCY

#### LIMIT

According to §15.247(a)(1)(ii), Frequency hopping systems operating in the 2400MHz-2483.5 MHz bands shall use at least 15 hopping frequencies.

#### MEASUREMENT EQUIPMENT USED

Name of Equipment	Manufacturer	Model	Serial Number	Last Calibration	Due Calibration
Spectrum Analyzer	Agilent	E4446A	US44300399	03/01/2014	03/01/2015
Spectrum Analyzer	ROHDE&SCHWARZ	FSU	200409	10/11/2013	10/10/2014

*Remark: Each piece of equipment is scheduled for calibration once a year.*

#### Test Configuration

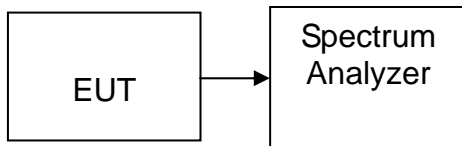

#### TEST PROCEDURE

1. Place the EUT on the table and set it in transmitting mode.
2. Remove the antenna from the EUT and then connect a low loss RF cable from the antenna port to the spectrum analyzer.
3. Set spectrum analyzer Start=2410MHz, Stop = 2470MHz, Sweep = 1ms.
4. Set the spectrum analyzer as RBW, VBW=300kHz,
5. Max hold, view and count how many channel in the band.

#### TEST RESULTS

*No non-compliance noted*

#### Test Data

Result (No. of CH)	Limit (No. of CH)	Result
51	>15	PASS



Test Plot

Channel Number







## 6.7 TIME OF OCCUPANCY (DWELL TIME)

### LIMIT

According to §15.247(a)(1)(iii), Frequency hopping systems operating in the 2400MHz-2483.5 MHz bands. The average time of occupancy on any channels shall not greater than 0.4 s within a period 0.4 s multiplied by the number of hopping channels employed.

### MEASUREMENT EQUIPMENT USED

Name of Equipment	Manufacturer	Model	Serial Number	Last Calibration	Due Calibration
Spectrum Analyzer	Agilent	E4446A	US44300399	03/01/2014	03/01/2015
Spectrum Analyzer	ROHDE&SCHWARZ	FSU	200409	10/11/2013	10/10/2014

*Remark: Each piece of equipment is scheduled for calibration once a year.*

### Test Configuration

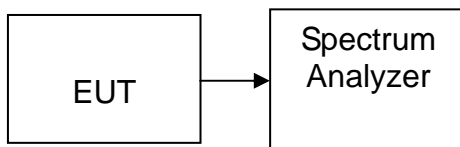

### TEST PROCEDURE

1. Place the EUT on the table and set it in transmitting mode.
2. Remove the antenna from the EUT and then connect a low loss RF cable from the antenna port to the spectrum analyzer.
3. Set center frequency of spectrum analyzer = operating frequency.
4. Set the spectrum analyzer as RBW, VBW=1MHz, Span = 0Hz, Sweep = auto.
5. Repeat above procedures until all frequency measured were complete.



**TEST RESULTS**

*No non-compliance noted*

**Test Data**

CH Mid:  $4.892 * (16/20.4) * 51 * 0.4 = 78.272(\text{ms})$

CH	Pulse Time (ms)	Total of Dwell (ms)	Period Time (s)	Limit (ms)	Result
Mid	4.892	78.272	20.40	400.00	PASS



Test Plot

CH Mid

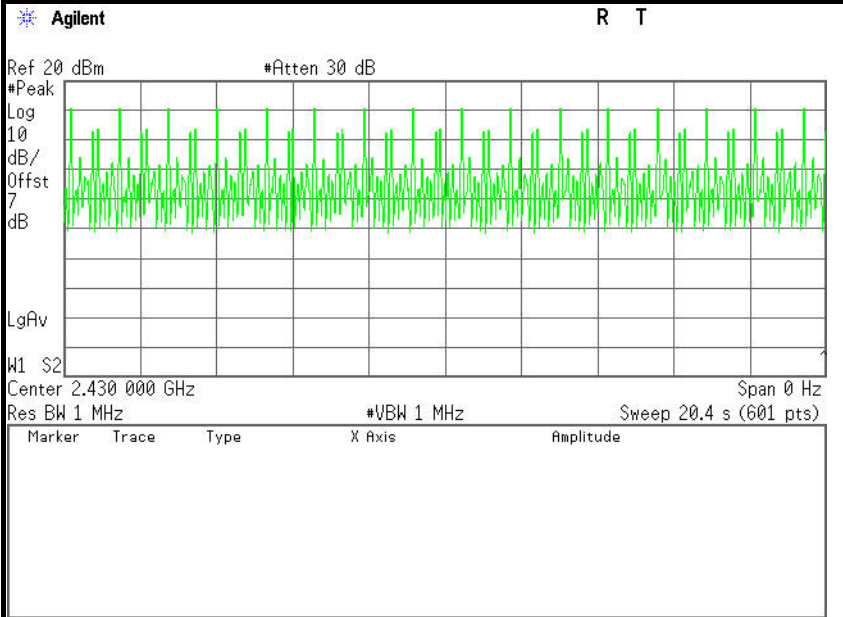

CH Mid

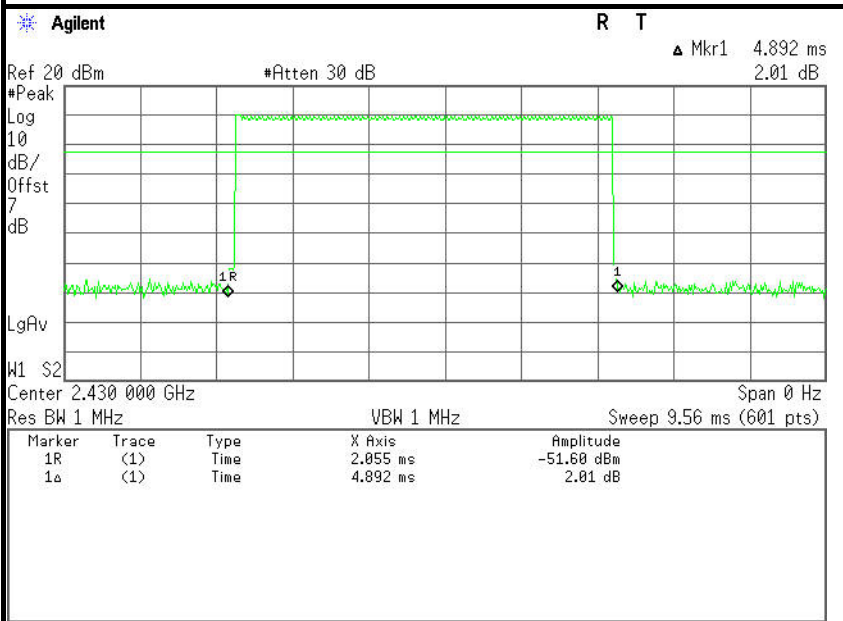



## 6.8 SPURIOUS EMISSIONS

### 6.8.1. CONDUCTED MEASUREMENT

#### LIMIT

In any 100 kHz bandwidth outside the frequency band in which the spread spectrum or digitally modulated intentional radiator is operating, the radio frequency power that is produced by the intentional radiator shall be at least 20 dB below that in the 100 kHz bandwidth within the band that contains the highest level of the desired power, based on either an RF conducted or a radiated measurement. Attenuation below the general limits specified in Section 15.209(a) is not required. In addition, radiated emissions which fall in the restricted bands, as defined in Section 15.205(a), must also comply with the radiated emission limits specified in Section 15.209(a) (see Section 15.205(c)).

#### MEASUREMENT EQUIPMENT USED

Name of Equipment	Manufacturer	Model	Serial Number	Last Calibration	Due Calibration
Spectrum Analyzer	Agilent	E4446A	US44300399	03/01/2014	03/01/2015

*Remark: Each piece of equipment is scheduled for calibration once a year.*

#### Test Configuration

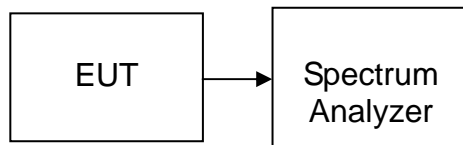

#### TEST PROCEDURE

Conducted RF measurements of the transmitter output were made to confirm that the EUT antenna port conducted emissions meet the specified limit and to identify any spurious signals that require further investigation or measurements on the radiated emissions site.

The transmitter output is connected to the spectrum analyzer. The resolution bandwidth is set to 100 kHz. The video bandwidth is set to 100 kHz.

Measurements are made over the 30MHz to 26GHz range with the transmitter set to the lowest, middle, and highest channels.

#### TEST RESULTS

*No non-compliance noted*



Test Plot

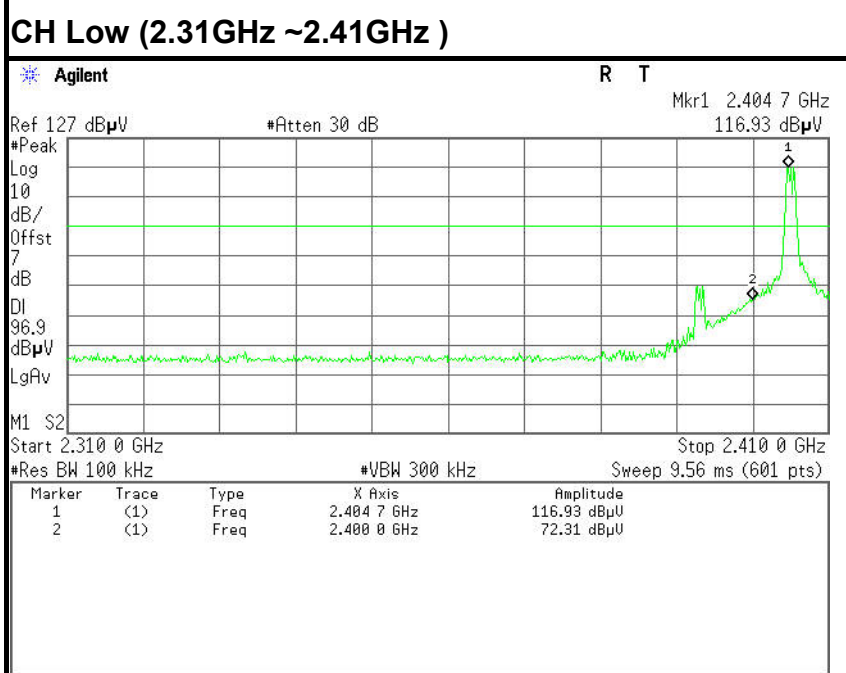
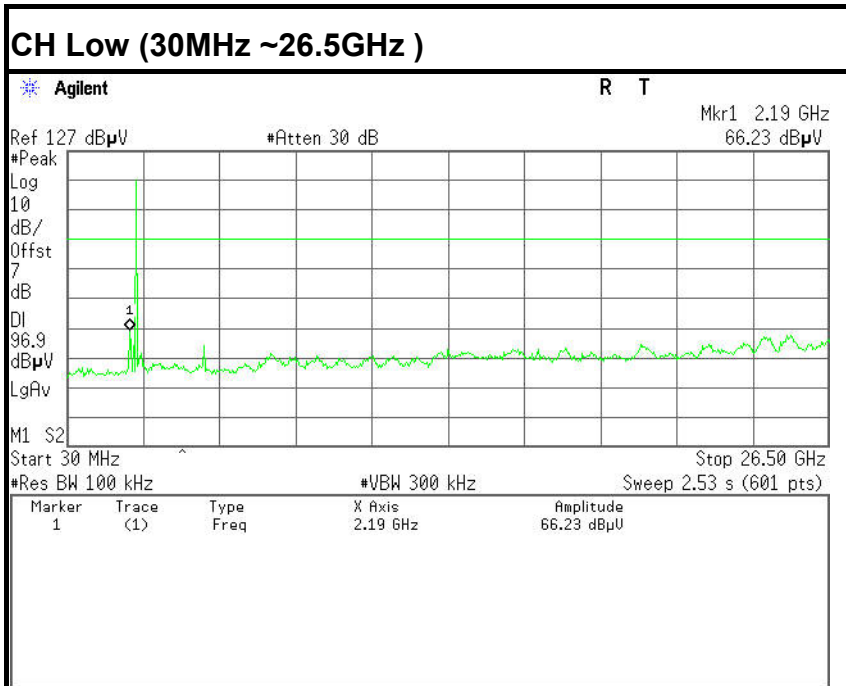



### CH Mid (30MHz ~ 26.5GHz)

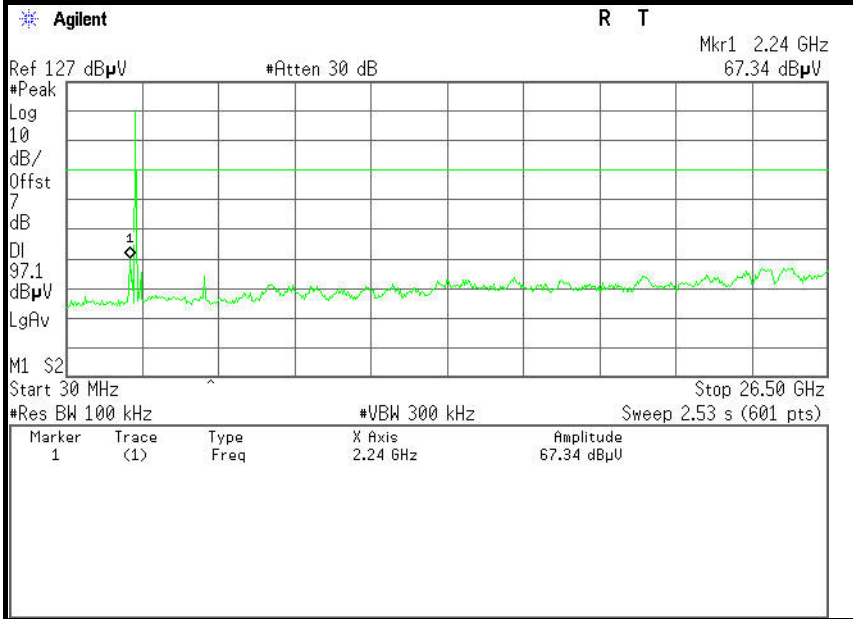

### CH High (30MHz ~ 26.5GHz)

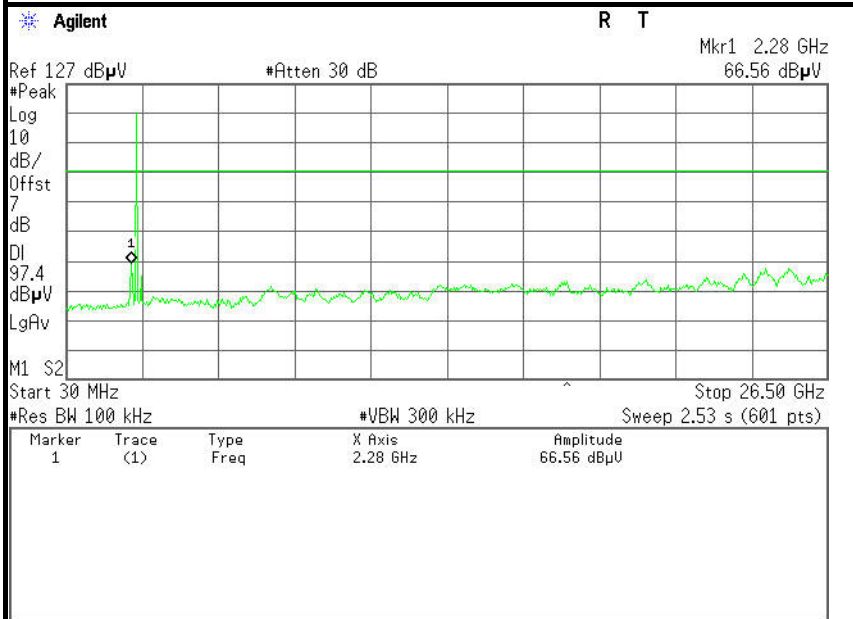

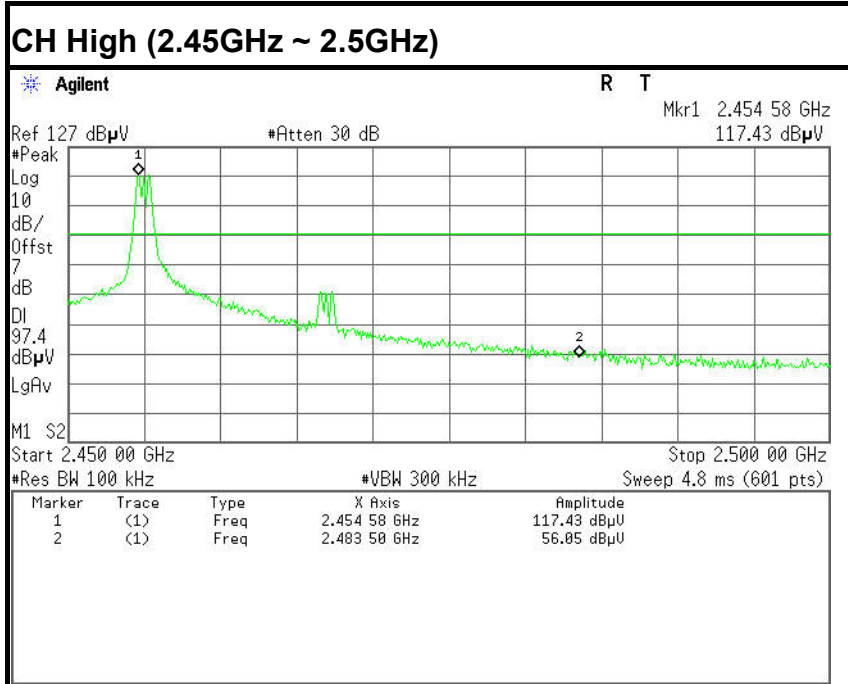



### 6.8.2. RADIATED EMISSIONS

#### LIMIT

1. Except as provided elsewhere in this Subpart, the emissions from an intentional radiator shall not exceed the field strength levels specified in the following table:

Frequency (MHz)	Field Strength (mV/m)	Measurement Distance (m)
0.009-0.490	2400/F(kHz)	300
0.490-1.705	24000/F(kHz)	30
1.705-30.0	30	30
30-88	100*	3
88-216	150*	3
216-960	200*	3
Above 960	500	3

**Note:** Except as provided in paragraph (g), fundamental emissions from intentional radiators operating under this Section shall not be located in the frequency bands 54-72 MHz, 76-88 MHz, 174-216 MHz or 470-806 MHz. However, operation within these frequency bands is permitted under other sections of this Part, e.g., Sections 15.231 and 15.241.

2. In the above emission table, the tighter limit applies at the band edges.

Frequency (Hz)	Field Strength ( $\mu$ V/m at 3-meter)	Field Strength (dB $\mu$ V/m at 3-meter)
30-88	100	40
88-216	150	43.5
216-960	200	46
Above 960	500	54





**MEASUREMENT EQUIPMENT USED**

<b>Radiated Emission Test Site 966 ( 2 )</b>					
<b>Name of Equipment</b>	<b>Manufacturer</b>	<b>Model Number</b>	<b>Serial Number</b>	<b>Last Calibration</b>	<b>Due Calibration</b>
PSA Series Spectrum Analyzer	Agilent	E4446A	US44300399	03/01/2014	03/01/2015
EMI TEST RECEIVER	ROHDE&SCHWARZ	ESCI	100783	03/09/2014	03/08/2015
Amplifier	MITEQ	AM-1604-3000	1123808	03/18/2015	03/18/2015
High Noise Amplifier	Agilent	8449B	3008A01838	03/18/2015	03/18/2015
Board-Band Horn Antenna	Schwarzbeck	BBHA 9170	9170-497	07/10/2013	07/09/2014
Bilog Antenna	SCHAFFNER	CBL6143	5082	03/01/2014	03/01/2015
Horn Antenna	SCHWARZBECK	BBHA9120	D286	03/01/2014	03/01/2015
Loop Antenna	COM-POWER	AL-130	121044	09/27/2013	09/26/2014
Turn Table	N/A	N/A	N/A	N.C.R	N.C.R
Controller	Sunol Sciences	SC104V	022310-1	N.C.R	N.C.R
Controller	CT	N/A	N/A	N.C.R	N.C.R
Temp. / Humidity Meter	Anymetre	JR913	N/A	02/28/2014	02/28/2015
Antenna Tower	SUNOL	TLT2	N/A	N.C.R	N.C.R
Test S/W	FARAD	LZ-RF / CCS-SZ-3A2			

**Remark:** Each piece of equipment is scheduled for calibration once a year.



**TEST CONFIGURATION**

**Below 1 GHz**

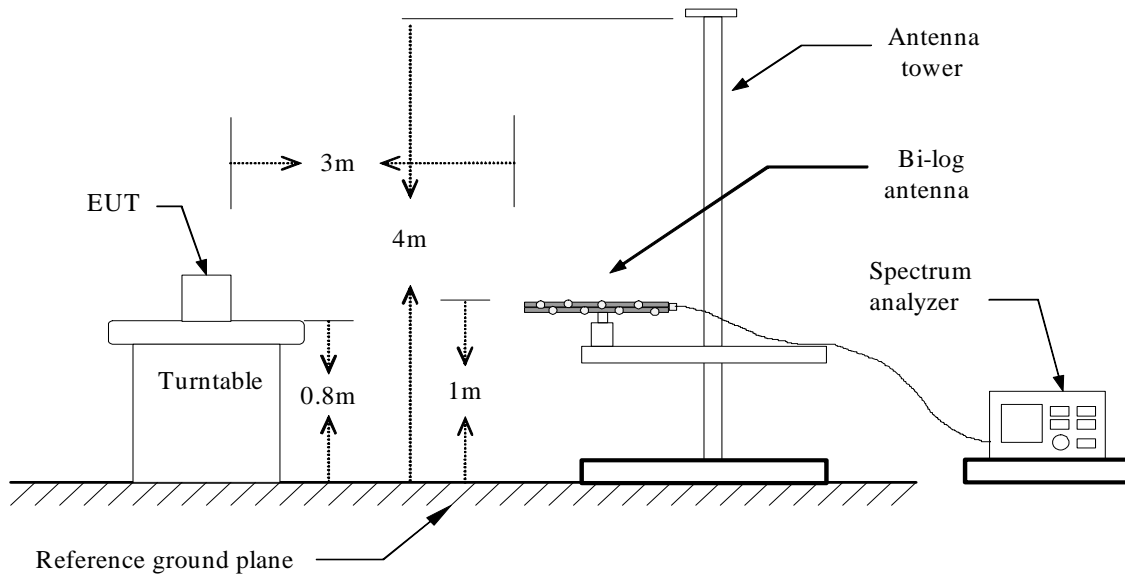

**Above 1 GHz**

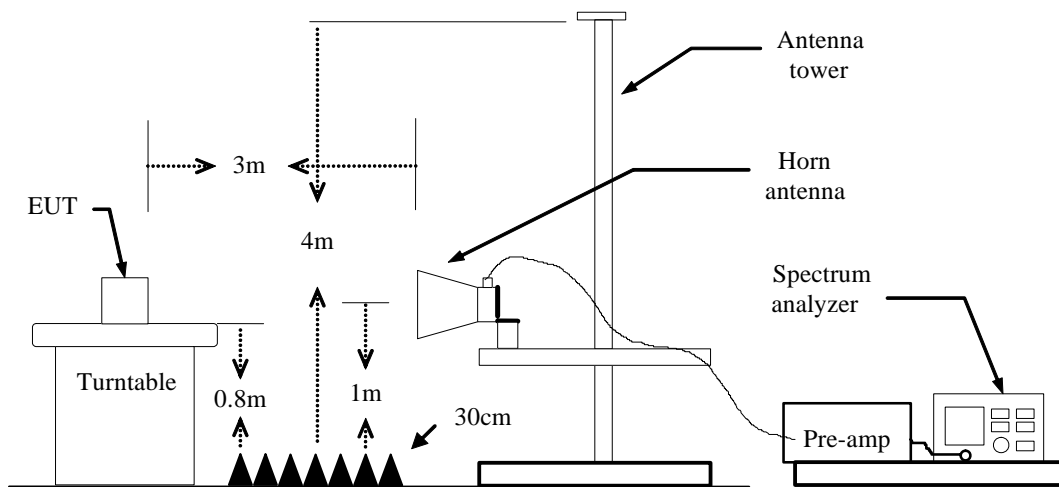



## **TEST PROCEDURE**

1. The EUT is placed on a turntable, which is 0.8m above ground plane.
2. The turntable shall be rotated for 360 degrees to determine the position of maximum emission level.
3. EUT is set 3m away from the receiving antenna, which is varied from 1m to 4m to find out the highest emissions.
4. Maximum procedure was performed on the six highest emissions to ensure EUT compliance.
5. And also, each emission was to be maximized by changing the polarization of receiving antenna both horizontal and vertical.
6. Repeat above procedures until the measurements for all frequencies are complete.



**TEST RESULTS**

**Below 1 GHz**

Operation Mode: TX

Test Date: June 13, 2014

Temperature: 24°C

Tested by: Eve Wang

Humidity: 52% RH

Polarity: Ver. / Hor.

Frequency (MHz)	Reading (dBµV)	Correction Factor (dB/m)	Result (dBµV/m)	Limit (dBµV/m)	Margin (dB)	Antenna Pole (V/H)	Remark
34.8500	42.56	-14.50	28.06	40.00	-11.94	V	QP
73.6500	45.97	-26.06	19.91	40.00	-20.09	V	QP
95.9600	43.86	-24.11	19.75	43.50	-23.75	V	QP
384.0500	41.33	-16.45	24.88	46.00	-21.12	V	QP
416.0600	39.39	-15.49	23.90	46.00	-22.10	V	QP
478.1400	35.45	-14.43	21.02	46.00	-24.98	V	QP
30.9700	40.07	-12.22	27.85	40.00	-12.15	H	QP
73.6500	46.39	-26.06	20.33	40.00	-19.67	H	QP
176.4700	47.81	-22.94	24.87	43.50	-18.63	H	QP
416.0600	44.66	-15.49	29.17	46.00	-16.83	H	QP
721.6100	30.93	-11.82	19.11	46.00	-26.89	H	QP
863.2300	30.70	-10.52	20.18	46.00	-25.82	H	QP

**\*\*Remark:** No emission found between lowest internal used/generated frequency to 30MHz.

**Notes:**

1. Measuring frequencies from 9kHz to the 1GHz.
2. Radiated emissions measured in frequency range from 30MHz to 1GHz were made with an instrument using Peak/Quasi-peak detector mode.
3. Data of measurement within this frequency range shown " --- " in the table above means the reading of emissions are attenuated more than 20dB below the permissible limits or the field strength is too small to be measured.
4. The IF bandwidth of SPA between 30MHz to 1GHz was 120kHz.
5. Frequency (MHz) = Emission frequency in MHz  
 Reading (dBuV) = Receiver reading  
 Correction Factor(dB/m) = Antenna factor + Cable loss – Amplifier gain  
 Actual FS (dBuV/m) = Reading (dBuV) + Corr. Factor (dB/m)  
 Limit (dBuV/m) = Limit stated in standard  
 Margin(dB) = Measured (dBuV/m) – Limits (dBuV/m)  
 Antenna Pole(V/H) = Current carrying line of reading



Above 1 GHz

Operation Mode: TX / CH Low
Temperature: 24°C
Humidity: 52% RH

Test Date: June 13, 2014
Tested by: Eve Wang
Polarity: Ver. / Hor.

Table with 8 columns: Frequency (MHz), Reading (dBuV), Correction Factor (dB/m), Result (dBuV/m), Limit (dBuV/m), Margin (dB), Antenna Pole (V/H), Remark. It contains two groups of data rows for various frequencies.

Notes:

- 1. Measuring frequencies from 1 GHz to the 10th harmonic of highest fundamental frequency.
2. Measurements above show only up to 6 maximum emissions noted, or would be lesser if no specific emissions from the EUT are recorded...
3. Radiated emissions measured in frequency above 1000MHz were made with an instrument using Peak detector mode and average detector mode...
4. Spectrum setting:
a. Peak Setting 1GHz - 26GHz, RBW = 1MHz, VBW = 1MHz, Sweep time = 200 ms.
b. AV Setting 1GHz - 26GHz, RBW = 1MHz, VBW = 10Hz, Sweep time = 200 ms.
5. Frequency (MHz) = Emission frequency in MHz
Reading (dBuV/m) = Uncorrected Analyzer / Receiver Reading
Correction Factor (dB) = Antenna factor + Cable loss - Amplifier gain
Limit (dBuV/m) = Limit stated in standard
Margin (dB) = Result (dBuV/m) - Limit (dBuV/m)
Pk = Peak Reading
AV = Average Reading
Remark = Mark Peak Reading or Average Reading



Operation Mode: TX / CH Mid
Temperature: 24°C
Humidity: 52% RH

Test Date: June 13, 2014
Tested by: Eve Wang
Polarity: Ver. / Hor.

Table with 8 columns: Frequency (MHz), Reading (dBuV), Correction Factor (dB/m), Result (dBuV/m), Limit (dBuV/m), Margin (dB), Antenna Pole (V/H), Remark. It contains 20 rows of test data.

Notes:

- 1. Measuring frequencies from 1 GHz to the 10th harmonic of highest fundamental frequency.
2. Measurements above show only up to 6 maximum emissions noted, or would be lesser if no specific emissions from the EUT are recorded...
3. Radiated emissions measured in frequency above 1000MHz were made with an instrument using Peak detector mode and average detector mode...
4. Spectrum setting:
a. Peak Setting 1GHz - 26GHz, RBW = 1MHz, VBW = 1MHz, Sweep time = 200 ms.
b. AV Setting 1GH z- 26GHz, RBW = 1MHz, VBW = 10Hz, Sweep time = 200 ms.
5. Frequency (MHz) = Emission frequency in MHz
Reading (dBuV/m) =Uncorrected Analyzer / Receiver Reading
Correction Factor (dB) = Antenna factor + Cable loss - Amplifier gain
Limit (dBuV/m) = Limit stated in standard
Margin (dB) = Result (dBuV/m)- Limit (dBuV/m)
Pk = Peak Reading
AV. = Average Reading
Remark = Mark Peak Reading or Average Reading



Operation Mode: TX / CH High

Test Date: June 13, 2014

Temperature: 24°C

Tested by: Eve Wang

Humidity: 52% RH

Polarity: Ver. / Hor.

Frequency (MHz)	Reading (dBuV)	Correction Factor (dB/m)	Result (dBuV/m)	Limit (dBuV/m)	Margin (dB)	Antenna Pole (V/H)	Remark
1900.0000	46.29	-8.46	37.83	74.00	-36.17	V	Peak
2242.0000	48.11	-7.29	40.82	74.00	-33.18	V	Peak
4357.0000	42.94	0.01	42.95	74.00	-31.05	V	Peak
4861.0000	57.47	1.93	59.40	74.00	-14.60	V	Peak
4861.0000	47.81	1.93	49.74	54.00	-4.26	V	AVG
5257.0000	41.77	2.53	44.30	74.00	-29.70	V	Peak
7291.0000	45.52	8.27	53.79	74.00	-20.21	V	Peak
7291.0000	35.86	8.27	44.13	54.00	-9.87	V	AVG
2134.0000	46.56	-7.74	38.82	74.00	-35.18	H	Peak
2845.0000	45.17	-4.54	40.63	74.00	-33.37	H	Peak
4546.0000	41.51	0.62	42.13	74.00	-31.87	H	Peak
4915.0000	57.24	2.16	59.40	74.00	-14.60	H	Peak
4915.0000	47.58	2.16	49.74	54.00	-4.26	H	AVG
6247.0000	40.75	4.45	45.20	74.00	-28.80	H	Peak
7363.0000	46.12	8.41	54.53	74.00	-19.47	H	Peak
7363.0000	36.46	8.41	44.87	54.00	-9.13	H	AVG

Notes:

1. Measuring frequencies from 1 GHz to the 10th harmonic of highest fundamental frequency.
2. Measurements above show only up to 6 maximum emissions noted, or would be lesser if no specific emissions from the EUT are recorded (ie: margin>20dB from the applicable limit) and considered that's already beyond the background noise floor.
3. Radiated emissions measured in frequency above 1000MHz were made with an instrument using Peak detector mode and average detector mode of the emission shown in Actual FS column.
4. Spectrum setting:
  - a. Peak Setting 1GHz - 26GHz, RBW = 1MHz, VBW = 1MHz, Sweep time = 200 ms.
  - b. AV Setting 1GH z- 26GHz, RBW = 1MHz, VBW = 10Hz, Sweep time = 200 ms.
5. Frequency (MHz) = Emission frequency in MHz  
 Reading (dBuV/m) =Uncorrected Analyzer / Receiver Reading  
 Correction Factor (dB) = Antenna factor + Cable loss – Amplifier gain  
 Limit (dBuV/m) = Limit stated in standard  
 Margin (dB) = Result (dBuV/m)- Limit (dBuV/m)  
 Pk = Peak Reading  
 AV. = Average Reading  
 Remark = Mark Peak Reading or Average Reading



### 6.9 POWERLINE CONDUCTED EMISSIONS

#### LIMIT

For an intentional radiator which is designed to be connected to the public utility (AC) power line, the radio frequency voltage that is conducted back onto the AC power line on any frequency or frequencies within the band 150 kHz to 30 MHz shall not exceed 250 microvolts (The limit decreases linearly with the logarithm of the frequency in the range 0.15 MHz to 0.50 MHz). The limits at specific frequency range is listed as follows:

Frequency Range (MHz)	Limits (dBµV)	
	Quasi-peak	Average
0.15 to 0.50	66 to 56	56 to 46
0.50 to 5	56	46
5 to 30	60	50

Compliance with this provision shall be based on the measurement of the radio frequency voltage between each power line (LINE and NEUTRAL) and ground at the power terminals.

#### MEASUREMENT EQUIPMENT USED

Conducted Emission Test Site					
Name of Equipment	Manufacturer	Model Number	Serial Number	Last Calibration	Due Calibration
EMI TEST RECEIVER	ROHDE&SCHWARZ	ESCI	100783	03/09/2014	03/08/2015
LISN(EUT)	ROHDE&SCHWARZ	ENV216	101543-WX	04/20/2014	04/19/2015
LISN	EMCO	3825/2	8901-1459	03/09/2014	03/08/2015
Temp. / Humidity Meter	VICTOR	HTC-1	N/A	03/17/2014	03/17/2015
Test S/W	FARAD	EZ-EMC/ CCS-3A1-CE			

**Remark:** Each piece of equipment is scheduled for calibration once a year.





## TEST CONFIGURATION

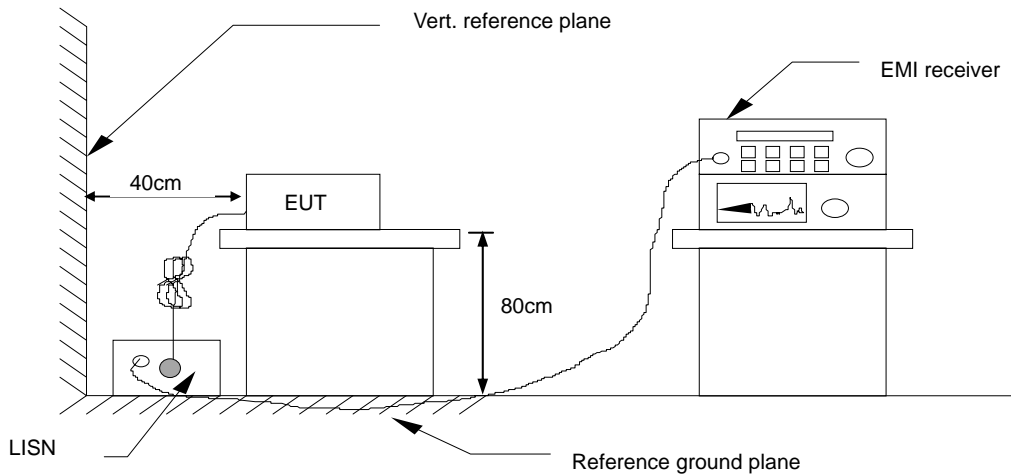

See test photographs attached in Appendix 1 for the actual connections between EUT and support equipment.

## TEST PROCEDURE

1. The EUT was placed on a table, which is 0.8m above ground plane.
2. Maximum procedure was performed on the six highest emissions to ensure EUT compliance.
3. Repeat above procedures until all frequency measured were complete.

## TEST RESULTS

The initial step in collecting conducted data is a spectrum analyzer peak scan of the measurement range. Significant peaks are then marked as shown on the following data page, and these signals are then quasi-peaked.



Test Data

Operation Mode: Charge

Test Date: June 10, 2014

Temperature: 22°C

Humidity: 45% RH

Tested by: Eve Wang

Line L1

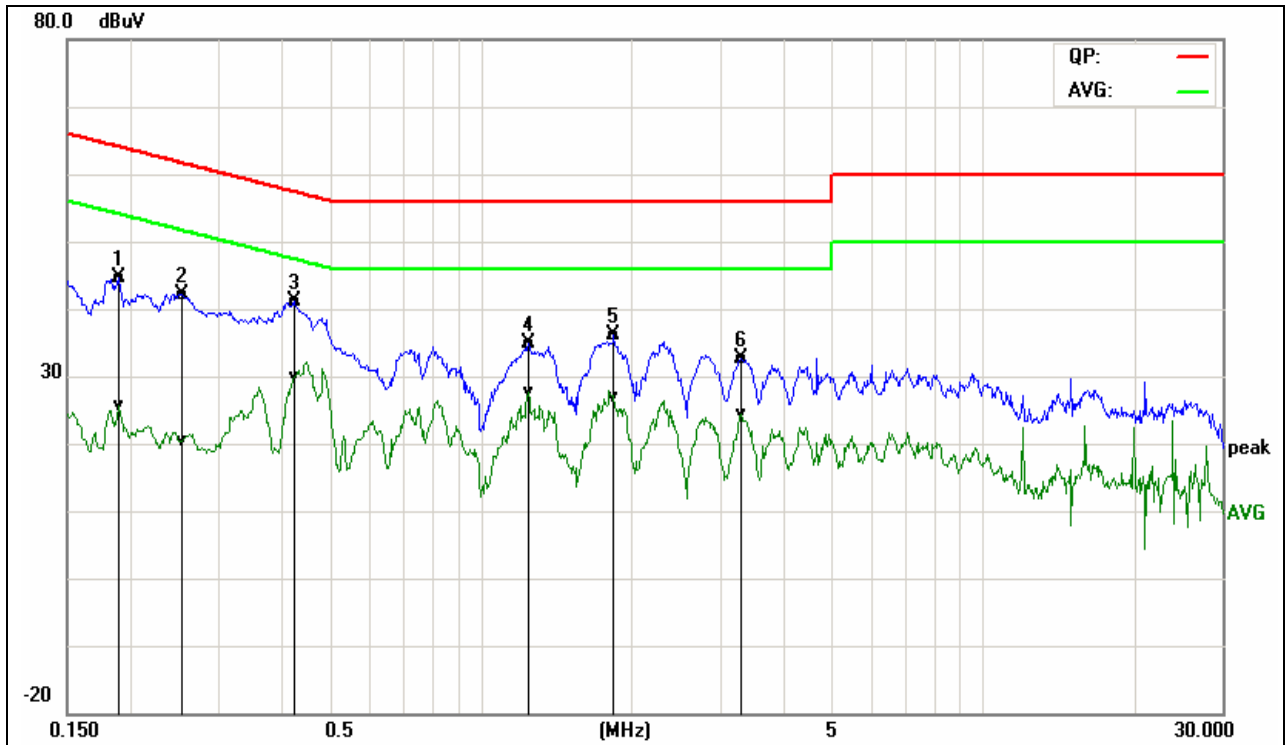

Frequency (MHz)	QuasiPeak Reading (dBuV)	Average Reading (dBuV)	Correction Factor (dB)	QuasiPeak Result (dBuV)	Average Result (dBuV)	QuasiPeak Limit (dBuV)	Average Limit (dBuV)	QuasiPeak Margin (dB)	Average Margin (dB)	Remark
0.1900	35.06	15.97	9.67	44.73	25.64	64.03	54.04	-19.30	-28.40	Pass
0.2540	32.41	10.76	9.69	42.10	20.45	61.62	51.63	-19.52	-31.18	Pass
0.4237	31.34	20.23	9.68	41.02	29.91	57.37	47.38	-16.35	-17.47	Pass
1.2460	25.18	17.99	9.71	34.89	27.70	56.00	46.00	-21.11	-18.30	Pass
1.8460	26.42	17.09	9.73	36.15	26.82	56.00	46.00	-19.85	-19.18	Pass
3.3020	22.88	14.69	9.71	32.59	24.40	56.00	46.00	-23.41	-21.60	Pass

Note:

1. Measuring frequencies from 0.15 MHz to 30MHz.
2. The emissions measured in frequency range from 0.15 MHz to 30MHz were made with an instrument using Peak detector, Quasi-peak detector and average detector.
3. “---” denotes the emission level was or more than 2dB below the Average limit.
4. The IF bandwidth of SPA between 0.15MHz to 30MHz was 10kHz; the IF bandwidth of Test Receiver between 0.15MHz to 30MHz was 9kHz;
5. L1= Line One (Live Line)



Operation Mode: Charge

Test Date: June 10, 2014

Temperature: 22°C

Humidity: 45% RH

Tested by: Eve Wang

Line L2

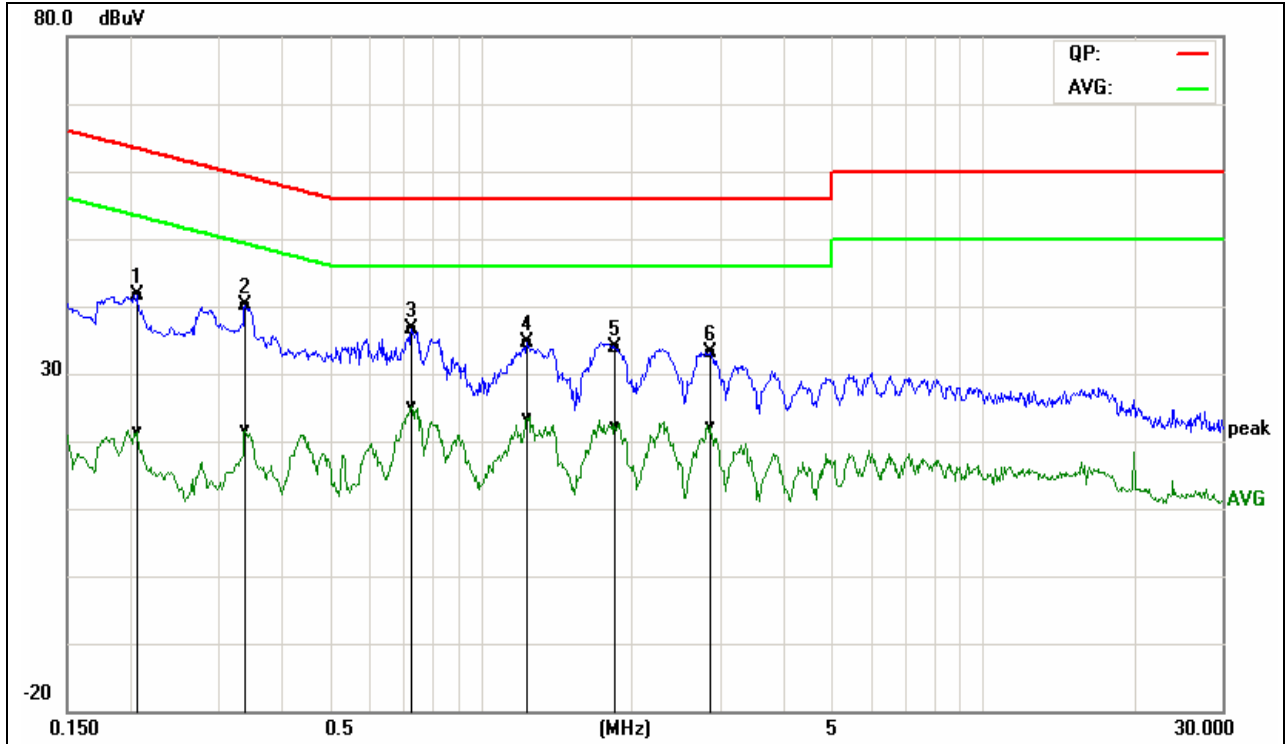

Frequency (MHz)	QuasiPeak Reading (dBuV)	Average Reading (dBuV)	Correction Factor (dB)	QuasiPeak Result (dBuV)	Average Result (dBuV)	QuasiPeak Limit (dBuV)	Average Limit (dBuV)	QuasiPeak Margin (dB)	Average Margin (dB)	Remark
0.2061	31.84	11.77	9.69	41.53	21.46	63.36	53.36	-21.83	-31.90	Pass
0.3392	30.48	11.82	9.69	40.17	21.51	59.22	49.22	-19.05	-27.71	Pass
0.7300	26.73	15.45	9.78	36.51	25.23	56.00	46.00	-19.49	-20.77	Pass
1.2420	24.88	13.67	9.71	34.59	23.38	56.00	46.00	-21.41	-22.62	Pass
1.8500	24.19	12.28	9.73	33.92	22.01	56.00	46.00	-22.08	-23.99	Pass
2.8580	23.42	12.33	9.71	33.13	22.04	56.00	46.00	-22.87	-23.96	Pass

**Note:**

1. Measuring frequencies from 0.15 MHz to 30MHz.
2. The emissions measured in frequency range from 0.15 MHz to 30MHz were made with an instrument using Peak detector, Quasi-peak detector and average detector.
3. “---” denotes the emission level was or more than 2dB below the Average limit.
4. The IF bandwidth of SPA between 0.15MHz to 30MHz was 10kHz; the IF bandwidth of Test Receiver between 0.15MHz to 30MHz was 9kHz;
5. L2 = Line Two (Neutral Line)