

# User Guide

## **NWL-12 Series – 3G Light Industrial M2M Router**



Copyright

Copyright© 2013 NetComm Wireless Limited. All rights reserved.

The information contained herein is proprietary to NetComm Wireless. No part of this document may be translated, transcribed, reproduced, in any form, or by any means without prior written consent of NetComm Wireless.



Note: This document is subject to change without notice.

Save our environment

When this equipment has reached the end of its useful life, it must be taken to a recycling centre and processed separately from domestic waste.

The cardboard box, the plastic contained in the packaging, and the parts that make up this device can be recycled in accordance with regionally established regulations. Never dispose of this electronic equipment along with your household waste. You may be subject to penalties or sanctions under the law. Instead, ask for disposal instructions from your municipal government.

Please be responsible and protect our environment.

**This manual covers the following products:**

NetComm Wireless NWL-12-01

NetComm Wireless NWL-12-02

DOCUMENT VERSION	DATE
Initial document release	

Table 1 - Document Revision History

# Table of Contents

Overview .....	5
Introduction .....	5
Target audience .....	5
Prerequisites .....	5
Notation .....	5
Product introduction .....	6
Product overview .....	6
Package contents .....	6
Product features .....	7
Physical dimensions and indicators .....	8
Physical dimensions .....	8
LED indicators .....	9
Ethernet port LED indicators .....	10
Interfaces .....	11
Placement of the router .....	12
Mounting options .....	12
Installation and configuration of the 3G Light Industrial M2M router .....	18
Powering the router .....	18
Power consumption .....	19
Installing the router .....	19
Advanced configuration .....	20
Status .....	21
Internet .....	24
Data Connection .....	24
Connect on Demand .....	28
Operator Settings .....	32
SIM security settings .....	33
LAN .....	37
Routing .....	41
VPN .....	51
Services .....	65
Dynamic DNS .....	65
Network time (NTP) .....	66
Data stream manager .....	67
Watchdogs .....	69
SNMP .....	72
TR-069 .....	74
GPS .....	75
SMS messaging .....	78
Diagnostics .....	82
Sending an SMS Diagnostic Command .....	85
System .....	92
Log .....	92
System Configuration .....	96
HTTPS key management .....	103
SSH Key Management .....	107
Appendix A: Tables .....	111
Appendix B: Device Mounting Dimensions .....	112
Appendix C: Mounting Bracket .....	114
Appendix D: Default Settings .....	115
Restoring factory default settings .....	116
Recovery mode .....	117
Appendix E: HTTPS - Uploading a self-signed certificate .....	118
Appendix F: RJ-45 connector .....	120
Safety and product care .....	121



# Overview

## Introduction



This document provides you all the information you need to set up, configure and use the NetComm Wireless NWL-12 3G Light Industrial M2M Router.

## Target audience

This document is intended for system integrators or experienced hardware installers who understand telecommunications terminology and concepts.

## Prerequisites

Before continuing with the installation of your 3G Light Industrial M2M Router, please confirm that have the following:

-  A device with a working Ethernet network adapter.
-  A web browser such as Internet Explorer, Mozilla Firefox or Google Chrome.
-  A flathead screwdriver if field terminated power is required.

## Notation

The following symbols are used in this user guide:



The following note requires attention.















The following note provides a warning.



The following note provides useful information.







# Product introduction

## Product overview

-  Penta-band 3G with quad-band 2G auto-fallback
-  HSPA+ up to 14.4 Mbps DL
-  Ethernet port with full passive Power over Ethernet (PoE) support (802.3af) (NWL-12-01 only)
-  RS232/RS422/RS485 Port and USB 2.0 OTG port
-  Integrated ZigBee multipoint mesh wireless networking (NWL-12-01 only)
-  Built in GPS supporting an active or passive GPS Antenna via external SMA connector
-  Three multi-purpose I/O ports
-  One dedicated ignition input
-  Internal diversity antennas with option for external main antenna (autosensing)
-  Intelligent, Tri-Colour LED display for clear, easy to read modem status information
-  Extensive device management with support for TR-069, Web GUI and full feature management with SMS
-  Flexible mounting suitable for in-home use or industrial applications with built-in wall mount and DIN rail mounting options

## Package contents

The NetComm Wireless 3G Light Industrial M2M Router package consists of:

-  1 x 3G Light Industrial M2M Router
-  2 x 3G antennas
-  1 x 1.5m yellow Ethernet cable 8P8C
-  1 x DIN rail mounting bracket
-  1 x six-way terminal block
-  1 x quick start guide and safety manual

If any of these items are missing or damaged, please contact NetComm Wireless Support immediately. The NetComm Wireless Support website can be found at:

<http://support.netcommwireless.com>.

## Product features

The NetComm Wireless NWL-12 3G Light Industrial M2M Router is an M2M device designed by NetComm Wireless to address the rapid growth in M2M deployments. It has been designed to provide state-of-the-art features and versatility at an affordable price. Compatible with network worldwide, the 3G Light Industrial M2M Router can be managed remotely even when it does not have an Internet connection via the use of SMS diagnostics and commands.

The 3G Light Industrial M2M Router includes many features such as Dial on Demand which provides a means to seamlessly connect or disconnect the mobile broadband connection to conserve usage; TR-069 support for easy management of a group of 3G Light Industrial M2M routers; and the ability to function as an SSH server to secure communications. Additionally, the open management system allows you to expand the feature set by producing your own custom software applications.

The NetComm Wireless 3G Light Industrial M2M Router meets the global demand for a reliable and cost-effective M2M device that successfully caters to mass deployment across businesses.

# Physical dimensions and indicators

## Physical dimensions

Below is a list of the physical dimensions of the 3G Light Industrial M2M Router.

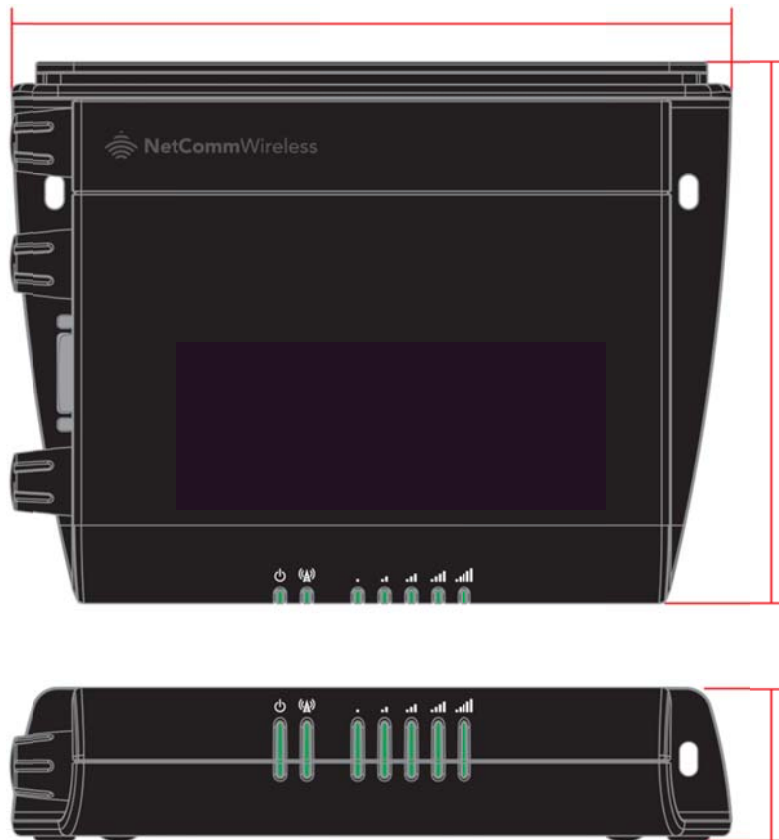

Figure 1 - 3G Light Industrial M2M Router Dimensions

3G LIGHT INDUSTRIAL M2M ROUTER (WITHOUT EXTERNAL ANTENNAS ATTACHED)	
Length	140 mm
Depth	103 mm
Height	30 mm
Weight	

Table 2 - Device Dimensions



## LED indicators

The 3G Light Industrial M2M Router uses 7 LEDs to display the current system and connection status.

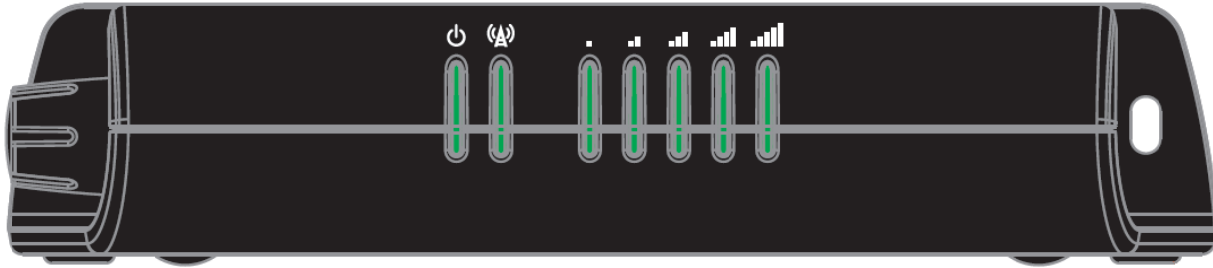

Figure 2 - 3G Light Industrial M2M Router LED Indicators



















LED ICON	NAME	COLOUR	STATE	DESCRIPTION
	Power		Off	Power off
			Double flash	Powering up
			On	Power on
			On	Power on in recovery mode
			Slow flashing	Hardware error
	Network		On	Connected via WWAN
			Blinking <sup>1</sup>	Traffic via WWAN
			Slow flashing	Connecting PDP
			On	Registered network
			Slow flashing	Registering network
			Slow flashing	SIM PIN locked
			Fast flashing	SIM PUK locked
			On	Can't connect
	Signal strength		On	3G
			On	2G GPRS
			On	GSM only (no GPRS)

Table 3 - LED Indicators

<sup>1</sup> The term "blinking" means that the LED may pulse, with the intervals that the LED is on and off not being equal. The term "flashing" means that the LED turns on and off at equal intervals.

## Signal strength LEDs

The following table lists the signal strength range corresponding with the number of lit signal strength LEDs.

NUMBER OF LIT LEDs	SIGNAL STRENGTH
All LEDs unlit	< -109 dBm
1	-109 dBm to -101dBm
2	-101 dBm to -91 dBm
3	-91 dBm to -85 dBm
4	-85 dBm to -77 dBm
5	> -77 dBm

*Table 4 - Signal strength LED descriptions*

## LED update interval

The signal strength LEDs update within a few seconds with a rolling average signal strength reading. When selecting a location for the router or connected or positioning an external antenna, please allow up to 20 seconds for the signal strength LEDs to update before repositioning.

## Ethernet port LED indicators

The Ethernet port of the 3G Light Industrial M2M Router has two LED indicators on it.

*Figure 3 - Ethernet port LED indicators*

The table below describes the statuses of each light and their meanings.

LED	STATUS	DESCRIPTION
Green	On	There is a valid network link.
	Blinking	There is activity on the network link.
Amber	On	The Ethernet port is operating at a speed of 100Mbps.
	Off	The Ethernet port is operating at a speed of 10Mbps or no Ethernet cable is connected.

*Table 5 - Ethernet port LED indicators description*

## Interfaces

The following interfaces are available on the 3G Light Industrial M2M Router:

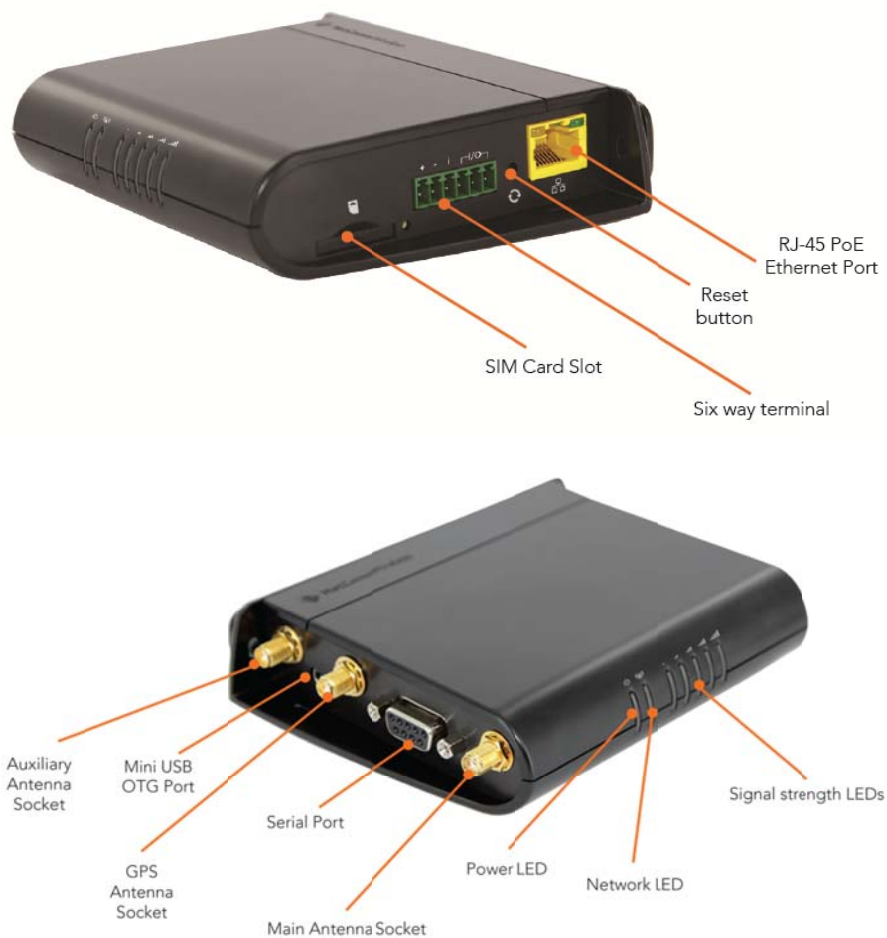

Figure 4 - Interfaces

ITEM	DESCRIPTION
Main antenna socket	SMA female connector for main antenna.
Auxiliary antenna socket	SMA female connector for auxiliary antenna.
GPS antenna socket	SMA female connector for GPS antenna.
Six-way terminal block connector	Connect power source, ignition and I/O wires here. Power, ignition and I/O wires may be terminated on optional terminal block and connected to DC input jack. Refer to the diagram and table on under <a href="#">Step 3</a> of the <a href="#">Installing your device</a> section for correct wiring of the terminal block. Operates in the 8-40V DC range.
Reset button	Press and hold for less than 5 seconds to reboot to normal mode. Press and hold for 5 to 15 seconds to reboot to recovery mode. Press and hold for 15 to 20 seconds to reset the router to factory default settings.
SIM card slot	Insert SIM card here.
RJ45 PoE Ethernet port	Connect one or several devices via a network switch here. This port can also optionally receive Power over Ethernet (802.3af PoE) in which case the DC power supply can serve as a backup power source if required (PoE available on NWL-12-01 only).
Mini USB 2.0 OTG port	Provides connectivity for optional external storage or a USB Ethernet dongle. Supplies up to 0.5A to connected device.
Serial port	Female DB9 port supporting 9-wire RS-232, RS-485 or RS-422 (software selectable).

Table 6 - Interfaces

# Placement of the router

The two external high-performance antennas supplied with the router are designed to provide optimum signal strength in a wide range of environments. If you find the signal strength is weak, try adjusting the orientation of the antennas. If you are unable to get an acceptable signal, try moving the router to a different place or mounting it differently.



Note: When selecting a location for the router, allow at least 20 seconds for the signal strength LEDs to update before trying a different location or connecting an external antenna.

## Mounting options

The 3G Light Industrial M2M router can be quickly and easily mounted in a variety of locations.

### Mounted flat against the wall

When mounted flat against the wall, the 3G Light Industrial M2M router has a slimline form factor. Use appropriately sized screws in the mounting holes provided on the base of the unit.

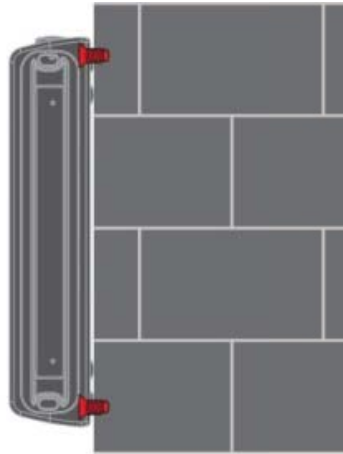

*Figure 5 - Wall mount - Flat against the wall*

## Perpendicular to the wall

If a large surface area is not available, there is the option of mounting the router perpendicular to the wall. This gives the router a small wall footprint while remaining securely attached. Use appropriately sized screws in the mounting holes provided on the back of the unit.

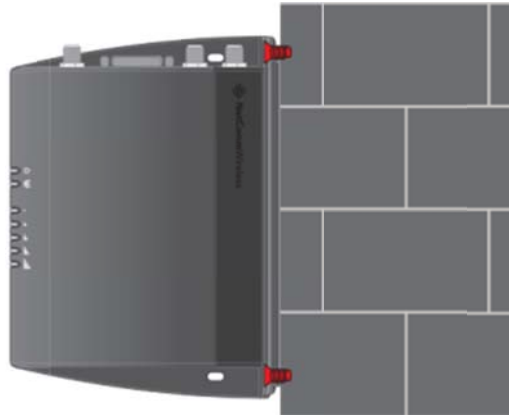

*Figure 6 - Wall mount - Perpendicular to the wall*

## C Section DIN Rail mount

The 3G Light Industrial M2M router easily slides onto a C Section DIN rail so that it is horizontally mounted. The DIN Rail mounting bracket is not required for C Section DIN rail mounting.

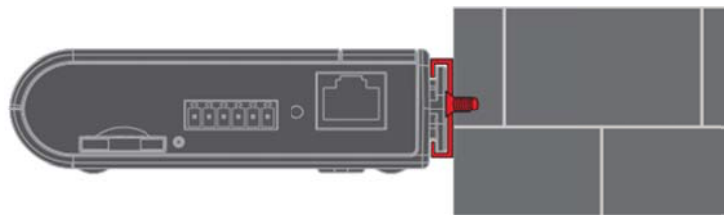

*Figure 7 - C-Section DIN rail mount*

To mount the unit on a C-Section DIN rail, slide it on as illustrated below:

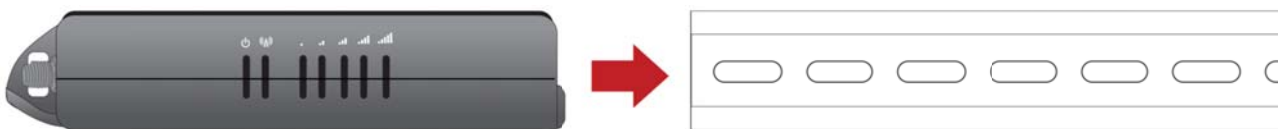

*Figure 8 - Mounting the unit on a DIN rail*

## Mounting bracket

The provided mounting bracket provides additional methods of mounting the 3G Light Industrial M2M router.

To attach the mounting bracket, slide it onto the rear of the router as shown in the diagram below:



*Figure 9 - Sliding on the mounting bracket*

To remove the bracket, press the **PUSH** button and slide the router off the bracket:

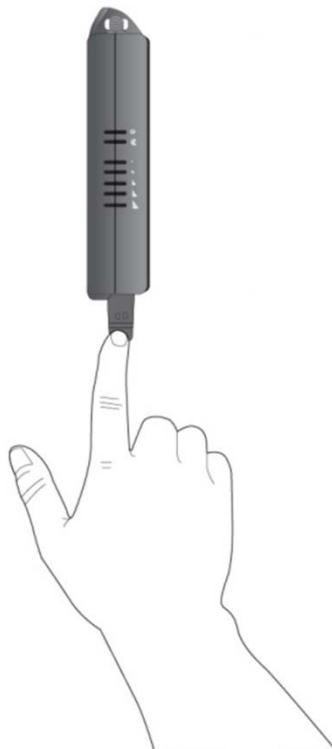

*Figure 10 - Removing the mounting bracket*



## Using the mounting bracket for wall mounting

By first attaching the DIN rail bracket to the wall, the 3G Light Industrial M2M router can be easily attached and removed from the bracket.



*Figure 11 - Wall mount - Mounted via DIN rail bracket*

## Using the mounting bracket for Top hat DIN rail mounting

The 3G Light Industrial M2M router may be vertically mounted to the wall with the bracket by sliding the bracket onto a top hat DIN rail

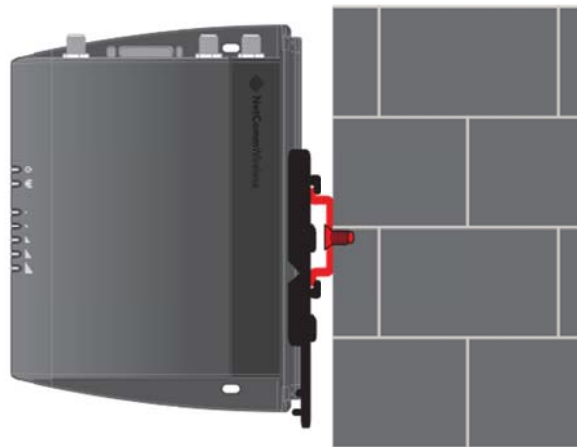

*Figure 12 - Top hat DIN rail mount*

Alternatively, you can attach it to the DIN Rail by using the V bend in the bracket as illustrated below:

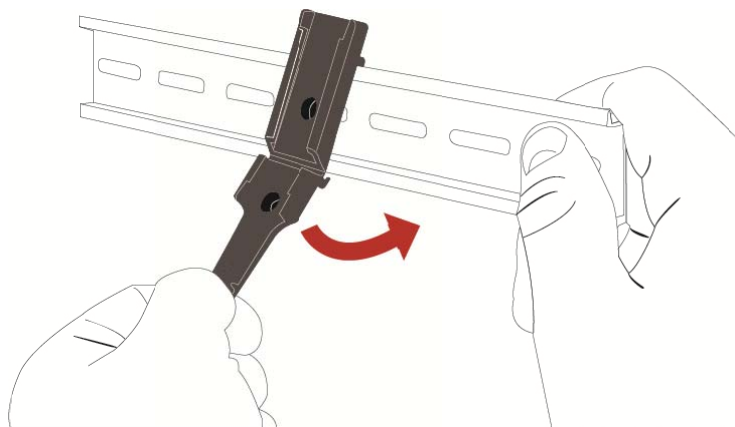
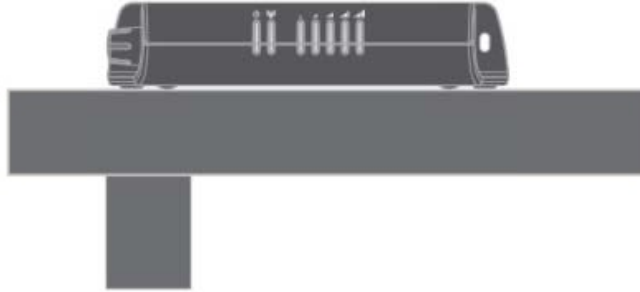

*Figure 13 - Attaching the mounting bracket to the DIN rail using the V bend*



## Desk mount

In situations where wall mounts and DIN rails are not required, you can simply place the 3G Light Industrial M2M router on a desk using its rubber feet to prevent it from slipping.



*Figure 14 - Desk mount*

# Installation and configuration of the 3G Light Industrial M2M router

## Powering the router

The 3G Light Industrial M2M router can be powered in one of three ways:

1. Power over Ethernet (802.3af PoE) (available on the NWL-12-01 only)
2. DC power input via 6-pin connector (8-40V DC)
3. DC power input via field terminated power source (8-40V DC)

The green power LED on the router lights up when a power source is connected.

### Power over Ethernet (802.3af PoE) (available on the NWL-12-01 only)

Power over Ethernet (PoE) is a method of connecting network devices through Ethernet cable where power and data are passed along a single cable. This may be a desirable method of powering the device if PoE is available, or if it's most convenient in the desired installation environment to only have a single cable running to the 3G Light Industrial M2M router.

There are 5 power classes defined in the IEEE 802.3-2005 standard, of which the 3G Light Industrial M2M router is a class 3 device.

CLASS	CLASSIFICATION CURRENT	POWER RANGE	CLASS DESCRIPTION
3	26-30 mA	6.49 – 12.95 W	Mid power

*Table 7 - PoE power classes*

To use PoE to power the 3G Light Industrial M2M router, simply connect your router to a PoE injector or PoE network switch using the bundled yellow Ethernet cable 8P8C.

### DC power via 6-pin connector

The DC input jack can accept power from a separately sold DC power supply. Both a standard temperature range DC power supply and an extended temperature range DC power supply are available to purchase as accessories.

To power the device via DC Power via the 6-pin connector, remove the attached green terminal block from your router and connect the external DC power supply to the router's green DC power jack.

### DC power via field terminated power source

If an existing 8-40V DC power supply is available, you can insert the wires into the supplied terminal block to power your router. Use a No. 3 flathead screwdriver to tighten the terminal block screws and secure the power wires, making sure the polarity of the wires are correctly matched, as illustrated below.

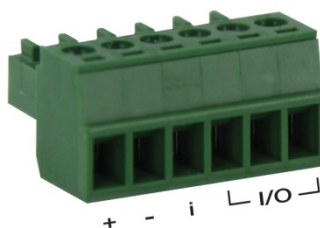

*Figure 15 - Locking Power Terminal Block*

TERMINAL	DESCRIPTION
+	Positive wire for power.
-	Ground wire.
i	Dedicated terminal for ignition detection.
I/O	Three terminals used for input/output detection. (Please refer to the User Guide).

*Table 8 - Locking power block pin outs*

## Failover power support (NWL-12-01 only)

The 3G Light Industrial M2M router includes support for connection of two power sources at the same time. When a PoE Ethernet cable is connected and DC power is also supplied to the DC input jack of the router, the router will source power exclusively from the PoE source. In the event that power from the PoE cable is lost, the router will automatically switch to source power from the DC input jack, without affecting the router's operation. When PoE power is restored, the router automatically switches back to receive power from the PoE input source.

## Viewing power source information

You can view the current power input mode in the **Advanced status** section of the device's web user interface. This is useful for remotely monitoring the device. You can also use the Software Development Kit to access this information for advanced purposes (e.g. configuring SMS alerts to inform you of the power status of the router).

To view the router's power source information, log in to the router and expand the **Advanced status** box on the status page. See the [Status](#) section of this manual for more information on the status page.

## Power consumption

To assist with power consumption planning, the following table summarises average power consumption during the various states of the 3G Light Industrial M2M router under normal usage conditions. It's important to note that this table serves as an indication only as the power consumed by the device is affected by many variables including signal strength, network type, and network activity.

### Average power consumption figures

STATE	POWER CONSUMPTION
Powered on, idle and connected to packet data	1.2W
Powered on, connected to packet data with average load	2.0W
Powered on, connected to packet data with heavy traffic	4.0W
Peak power draw at maximum 3G module transmission power	5.0W

*Table 9 - Average power consumption figures*

## Installing the router

After you have mounted the router and connected a power source, follow these steps to complete the installation process.

1. Connect equipment that requires network access to the Ethernet port of your router. This may be your computer for advanced configuration purposes, or your end equipment which requires data access via the 3G Light Industrial M2M router. You can connect one device directly, or several devices using a network switch.

If you're using PoE as the power source, you need to connect any devices via an available data Ethernet port on your PoE power source (be it a PoE network switch or PoE power injector).

2. Ensure the external power source is switched on and wait 2 minutes for your 3G Light Industrial M2M router to start up. To check the status of your router, compare the LED indicators on the device with those listed on page 8 of this guide.

# Advanced configuration

The 3G Light Industrial M2M Router comes with preconfigured settings that should suit most customers. For advanced configuration, log in to the web-based user interface of the router.

To log in to the web-based user interface router:

1. Open a web browser (e.g. Internet Explorer, Firefox, Safari), type <http://192.168.1.1> into the address bar and press **Enter**. The web-based user interface log in screen is displayed.

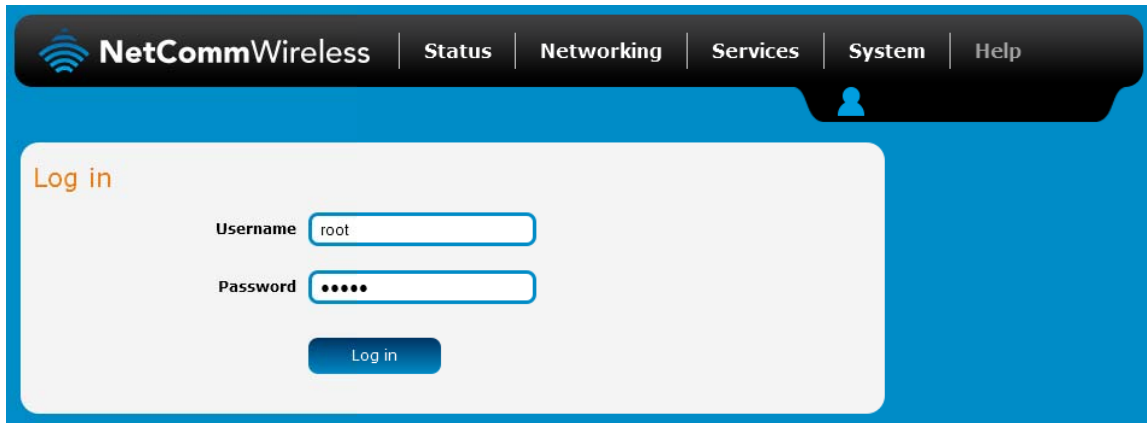

*Figure 16 - Log in prompt for the web-based user interface*

2. Enter the login username and password. If this is the first time you are logging in or you have not previously configured the password for the "root" or "admin" accounts, you can use one of the default account details to log in.

ADMIN MANAGER ACCOUNT		ROOT MANAGER ACCOUNT	
Username:	admin	Username:	root
Password:	admin	Password:	admin

*Table 10 - Management account login details*





Note: To access all features of the router, you must use the root manager account.

For security reasons, we highly recommend that you change the passwords for the root and admin accounts upon initial installation. You can do so by navigating to the System and then Administration page.

The Status page is displayed when you log in successfully.

# Status

The status page of the web interface provides system related information and is displayed when you log in to the 3G Light Industrial M2M router management console. The status page shows System information, LAN details, Cellular connection status, Packet data connection status and Advanced status details. You can toggle the sections from view by clicking the  or  buttons to show or hide them. Extra status boxes will appear as additional software features are enabled (e.g. VPN connectivity).

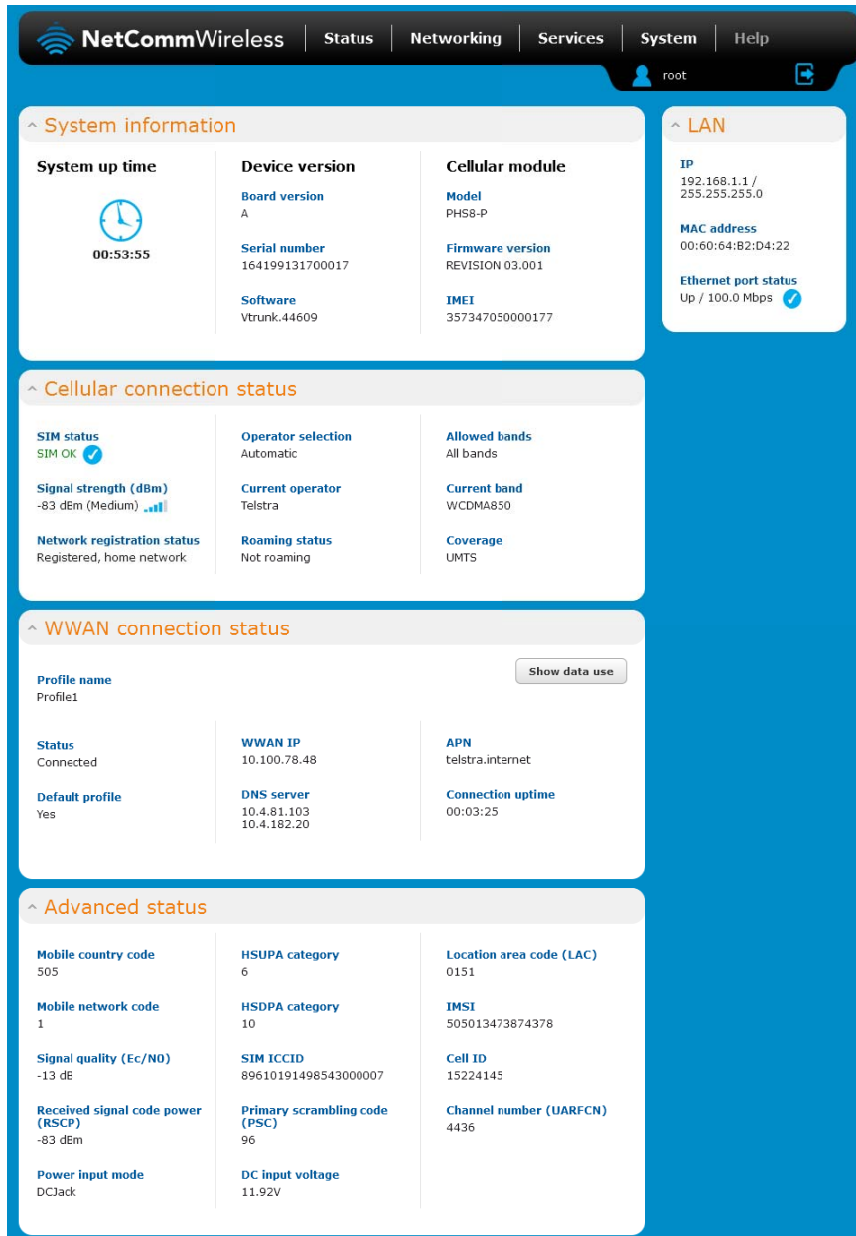

The screenshot shows the NetCommWireless web interface. At the top, there is a navigation bar with the following menu items: Status, Networking, Services, System, and Help. The user is logged in as 'root'. The main content area is divided into several sections, each with a toggle arrow:

- System information:**
  - System up time:** 00:53:55
  - Device version:** Board version A, Serial number 164199131700017, Software Vtrunk.44609
  - Cellular module:** Model PHS8-P, Firmware version REVISION 03.001, IMEI 357347050000177
- LAN:**
  - IP:** 192.168.1.1 / 255.255.255.0
  - MAC address:** 00:60:64:B2:D4:22
  - Ethernet port status:** Up / 100.0 Mbps
- Cellular connection status:**
  - SIM status:** SIM OK
  - Signal strength (dBm):** -83 dBm (Medium)
  - Network registration status:** Registered, home network
  - Operator selection:** Automatic
  - Current operator:** Telstra
  - Roaming status:** Not roaming
  - Allowed bands:** All bands
  - Current band:** WCDMA850
  - Coverage:** UMTS
- WWAN connection status:**
  - Profile name:** Profile1
  - Status:** Connected
  - Default profile:** Yes
  - WWAN IP:** 10.100.78.48
  - DNS server:** 10.4.81.103, 10.4.182.20
  - APN:** telstra.internet
  - Connection uptime:** 00:03:25
- Advanced status:**
  - Mobile country code:** 505
  - Mobile network code:** 1
  - Signal quality (Ec/N0):** -13 dB
  - Received signal code power (RSCP):** -83 dBm
  - Power input mode:** DCJack
  - HSUPA category:** 6
  - HSDPA category:** 10
  - SIM ICCID:** 89610191498543000007
  - Primary scrambling code (PSC):** 96
  - DC input voltage:** 11.92V
  - Location area code (LAC):** 0151
  - IMSI:** 505013473874378
  - Cell ID:** 15224145
  - Channel number (UARFCN):** 4436

Figure 17 - The Status page

ITEM	DEFINITION
<b>System information</b>	
System up time	The current uptime of the router.
Board version	The hardware version of the router.
Serial Number	The serial number of the router.
Software	The software version number running on the router.
Model	The type of phone module and the firmware version of the module.
Firmware version	The firmware revision of the phone module.
IMEI	The International Mobile Station Equipment Identity number used to uniquely identify a mobile device.
<b>LAN</b>	
IP	The IP address and subnet mask of the router.
MAC Address	The MAC address of the router.
Ethernet Port Status	Displays the current status of the Ethernet port and its operating speed.
<b>Cellular connection status</b>	
SIM Status	Displays the activation status of the router on the carrier network.
Signal strength (dBm)	The current signal strength measured in dBm
Network registration status	The status of the router's registration for the current network.
Operator selection	The mode used to select an operator network.
Current operator	The current operator network in use.
Roaming status	The roaming status of the router.
Allowed bands	The bands to which the router may connect.
Current band	The current band being used by the router.
Coverage	The mobile equipment identifier (MEID) of the router, a unique code for identifying devices on a CDMA network.
<b>WWAN Connection Status</b>	
Profile name	The name of the active profile.
Status	The connection status of the active profile.
Default profile	Indicates whether the current profile in use is the default profile.
WWAN IP	The IP address assigned by the mobile broadband carrier network.
DNS server	The primary and secondary DNS servers for the WWAN connection.
APN	The Access Point Name currently in use.
Connection uptime	The length of time of the current mobile connection session.
<b>Advanced status</b>	
Mobile country code	The Mobile Country Code (MCC) of the router.
Mobile network code	The Mobile Network Code (MNC) of the router.
Signal quality (Ec/N0)	A measurement of the portion of the received signal that is usable. This is the signal strength minus the signal noise level.
Received signal code power (RSCP)	The power level of the signal on the current connection's particular channel.
Power input mode	Displays whether power is currently being sourced from the PoE Ethernet port or from the DC input jack (PoE available on NWL-12-01 only)
HSUPA category	Displays the HSUPA category (1-9) for the current uplink
HSDPA category	Displays the HSDPA category (1-8) for the current downlink.
SIM ICCID	The Integrated Circuit Card Identifier of the SIM card used with the router, a unique number up to 19 digits in length.
Primary scrambling code (PSC)	The Primary scrambling code for the current signal.
DC input voltage	Displays the current voltage of the power input source provided via the DC Input jack
Location area code (LAC)	The ID of the cell tower grouping the current signal is broadcasting from.

IMSI	The International mobile subscriber identity is a unique identifier of the user of a cellular network.
Cell ID	A unique code that identifies the base station from within the location area of the current mobile network signal.
Channel number (UARFCN)	The channel number of the current 3G/2G connection.

*Table 11 - Status page item details*

# Internet

The Internet section provides configuration options for Wireless WAN, LAN, Routing and VPN connectivity.

## Data Connection

The data connection page allows you to configure and enable/disable the connection profile. To access this page, click on the **Networking** menu, and under the **Wireless WAN** menu, select the **Data Connection** item.

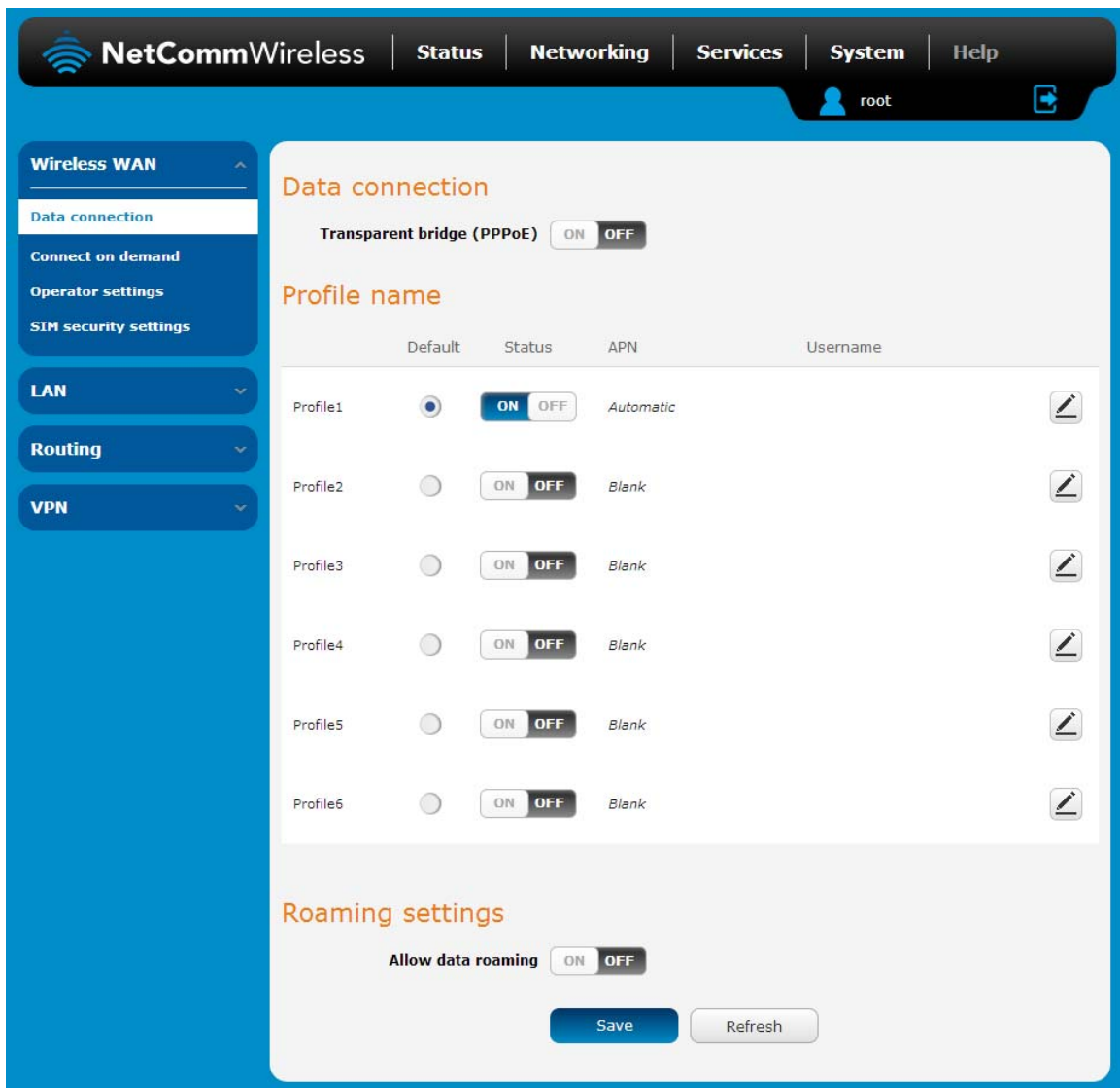

Figure 18 - Data connection settings



ITEM	DEFINITION
<b>Data connection</b>	
Transparent Bridge (PPPoE)	Toggles the transparent bridge function on and off.
<b>Profile name list</b>	
Default	Sets the corresponding profile to be the default gateway for all outbound traffic except traffic for which there are configured static route rules or profile routing settings.
Status	Toggles the corresponding profile on and off. If your carrier supports it, two profiles may be turned on simultaneously.
APN	The APN configured for the corresponding profile.
Username	The username used to log on to the corresponding APN.
<b>Roaming settings</b>	
Allow data roaming	When set to <b>ON</b> , the router will allow local devices to access the Wireless WAN network when the MachineLink 3G is roaming onto a foreign network. When set to <b>OFF</b> , the router will deny network access to data services when roaming onto a foreign network. This setting is <b>ON</b> by default.

*Table 12 - Data connection item details*

## Connecting to the mobile broadband network

The router supports the configuration of up to six APN profiles; these profiles allow you to configure the settings that the router will use to connect to the 2G/3G network and switch easily between different connection settings.

For advanced networking purposes, you may activate a maximum of two profiles simultaneously (dependant on network support). When activating two connection profiles, you should avoid selecting two profiles with the same APN as this can cause only one profile to connect. Similarly, activating two profiles which are both configured to automatically determine an APN can cause a conflict and result in neither profile establishing a connection. We recommend that the two active connection profiles have differing, manually configured APNs to avoid connection issues and ensure smooth operation.

## Manually configuring a connection profile

To manually configure a connection profile:

1. Click the **Edit** button corresponding to the Profile that you wish to modify. The data connection profile settings page is displayed.

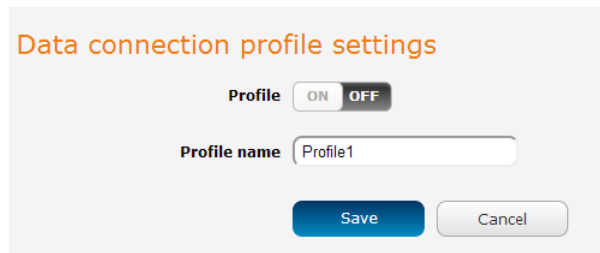

*Figure 19 - Data connection profile settings*

- Click the **Profile** toggle key to turn the profile on. Additional settings appear.

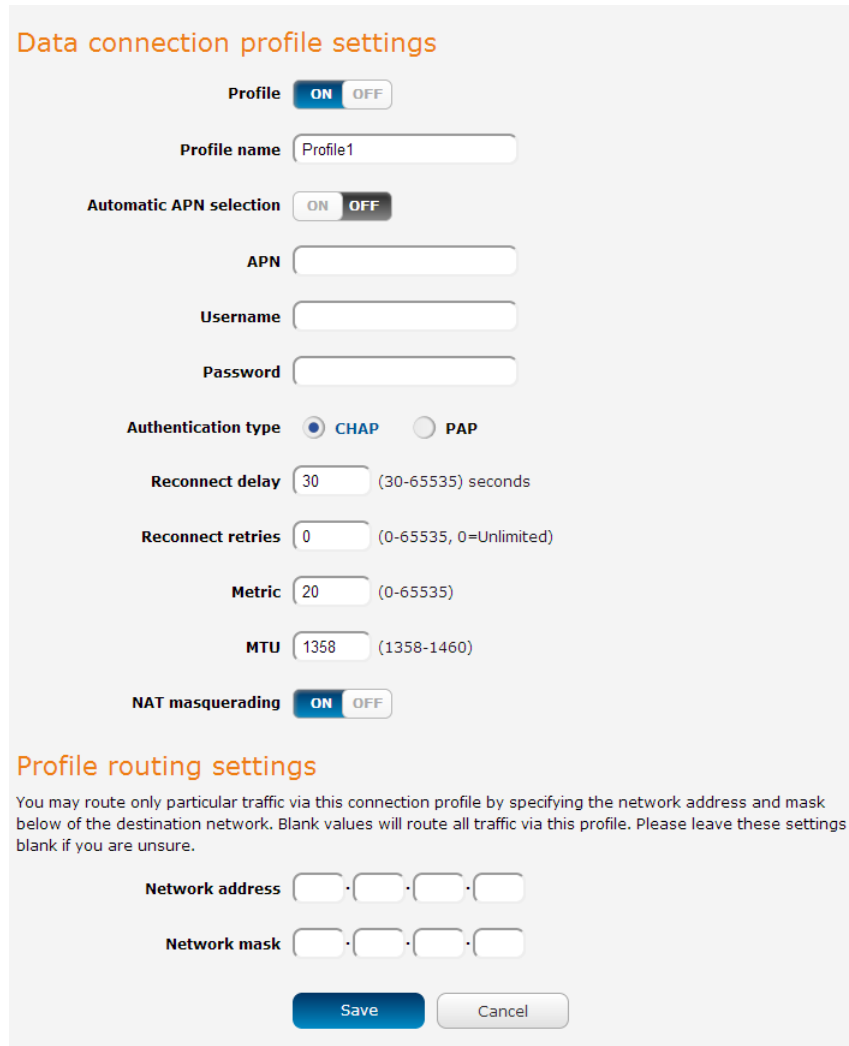

**Data connection profile settings**

**Profile**  ON  OFF

**Profile name**

**Automatic APN selection**  ON  OFF

**APN**

**Username**

**Password**

**Authentication type**  CHAP  PAP

**Reconnect delay**  (30-65535) seconds

**Reconnect retries**  (0-65535, 0=Unlimited)

**Metric**  (0-65535)

**MTU**  (1358-1460)

**NAT masquerading**  ON  OFF

**Profile routing settings**

You may route only particular traffic via this connection profile by specifying the network address and mask below of the destination network. Blank values will route all traffic via this profile. Please leave these settings blank if you are unsure.

**Network address**  .  .  .

**Network mask**  .  .  .

Figure 20 - Data connection settings - Profile turned on

- In the **Profile name** field, enter a name for the profile. This name is only used to identify the profile on the router.
- Ensure that the **Automatic APN selection** toggle key is set to off. If it is not, click it to toggle it to the off position.
- In the **APN** field, enter the APN Name (Access Point Name) and if required, use the **Username** and **Password** fields to enter your login credentials.
- Next to **Authentication type**, select the either CHAP or PAP depending on the type of authentication used by your provider.
- The **Reconnect delay** field specifies the number of seconds to wait between connection attempts. The default setting of 30 seconds is sufficient in most cases but you may modify it to wait up to 65535 seconds if you wish.
- The **Reconnect retries** field specifies the number of times to attempt to connect to the network if the router fails to establish a connection. It is set to 0 by default which causes the router to attempt to reconnect indefinitely.
- The **Metric** value is used by router to prioritise routes (if multiple are available) and is set to 20 by default. This value is sufficient in most cases but you may modify it if you are aware of the effect your changes will have on the service.
- The **MTU** field allows you to modify the Maximum Transmission Unit used on the connection. Do not change this unless instructed to by your carrier.
- Use the **NAT Masquerading** toggle key to turn NAT Masquerading on or off. NAT masquerading, also known simply as NAT is a common routing feature which allows multiple LAN devices to appear as a single WAN IP via network address translation. In this mode, the router modifies network traffic sent and received to inform remote computers on the internet that packets originating from a machine behind the router actually originated from the WAN IP address of the router's internal NAT IP address. This may be disabled if a framed route configuration is required and local devices require WAN IP addresses.
- For advanced networking such as using dual simultaneous PDP contexts, you may wish to configure a particular profile to route only certain traffic via that profile by configuring a custom address and mask of traffic to send via that profile. To do this, in the Profile routing settings section, enter the **Network address** and **Network mask** of the remote network. If you do not want to use this feature, or are unsure, please leave these fields blank, which will not designate any particular traffic to be routed via this profile. For more information on configuring Profile routing settings, see the [Setting a default gateway with two active connection profiles](#) example.

13. Click the **Save** button when you have finished entering the profile details.

## Confirming a successful connection

After configuring the packet data session, and ensuring that it is enabled, click on the Status menu item at the top of the page to return to the Status page. When there is a mobile broadband connection, the **WWAN** section is expanded showing the details of the connection and the Status field displays **Connected**. To see details on the connected session, you can click the **Show data usage** button.

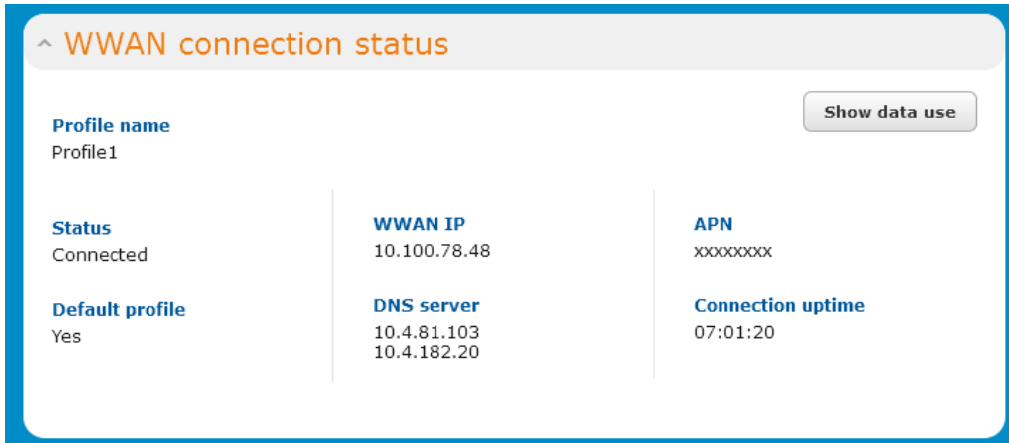

^ WWAN connection status		
<b>Profile name</b> Profile1		<a href="#">Show data use</a>
<b>Status</b> Connected	<b>WWAN IP</b> 10.100.78.48	<b>APN</b> xxxxxxxx
<b>Default profile</b> Yes	<b>DNS server</b> 10.4.81.103 10.4.182.20	<b>Connection uptime</b> 07:01:20

Figure 21 - Packet data connection status section

## Connect on Demand

The connect on demand feature keeps the Packet Data Protocol (PDP) context deactivated by default while making it appear to locally connected devices that the router has a permanent connection to the mobile broadband network. When a packet of interest arrives or an SMS wake-up command is received, the router attempts to establish a mobile broadband data connection. When the data connection is established, the router monitors traffic and terminates the link when it is idle.



Note: When interesting packets arrive, the recovery time for the wireless WAN connection is approximately 20-30 seconds.

## Configuring Connect on Demand

To configure Connect on demand:

1. Click the **Networking** menu item from the top menu bar.
2. On the Connect on demand page, click the Connect on demand toggle key so that it is ON. Extra options appear. See the following sub-sections for further instructions.

### Connect on demand

The connect on demand feature keeps the PDP context deactivated by default while making it appear that the router has permanent connection to WWAN and locally connected devices. When interesting packets arrive or an SMS wake-up command is received, the router will attempt to establish a WWAN data connection. The router will monitor traffic once the data connection is established and will terminate it when the link is idle.

**Connect on demand**  ON  OFF

#### Data activity triggered connection

Connect only when traffic appears to these UDP/TCP destination ports. You can specify multiple ports by separating them with a comma (eg 21, 23, 53).

**Enable dial port filter**  ON  OFF

Connect on data activity except when activity matches these IP protocols

**Ignore ICMP**  ON  OFF

**Ignore TCP**  ON  OFF

**Ignore UDP**  ON  OFF

on data activity except when activity matches these applications

**Ignore DNS**  ON  OFF

**Ignore NTP**  ON  OFF

**Ignore Microsoft network awareness (NCSI) traffic**  ON  OFF

#### Connect and disconnect timers

#### Periodic connect schedule

**On data activity, stay online for at least**

**After connecting, stay online for at least**

**After hanging up, don't redial for**

**Disconnect regardless of traffic after**

**Connect regularly, every**

**Randomise connect frequency by up to**

#### Verbose logging configuration

**Log all matched activity to the system log**  ON  OFF

#### Online / Offline control

**Online status** Disabled

Figure 22 - Connect on demand configuration options

## Setting the router to dial a connection when traffic is detected on specific ports

In some situations, you may wish to have the internet connection disabled except at times when outbound traffic to a particular external host's port or range of ports is sent to the router. To use this feature, click **Enable dial port filter** and enter the port number or list of port numbers separated by commas. When you select this option, all outbound ICMP/TCP/UDP packets to any remote host on the specified port(s) will trigger the connection to dial. Note that when this feature is enabled, the options to ignore specific packet types are not available.

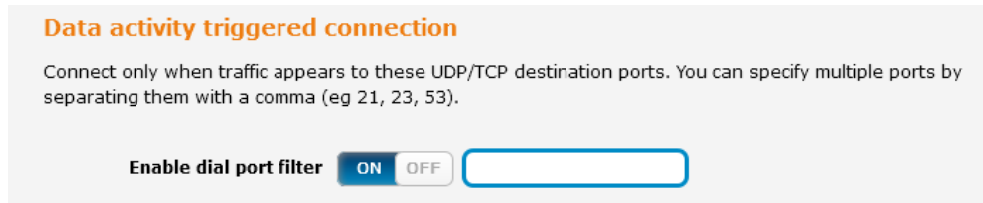

Figure 23 – Dial on demand - Data activity triggered connection

You can allow Microsoft network awareness (NCSI) traffic through but if you prefer that they do not trigger the connection, click the **Ignore Microsoft network awareness (NCSI) traffic** toggle key to set it to **ON**.

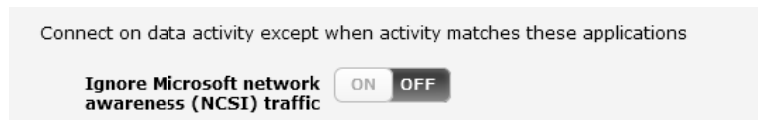

Figure 24 - Dial on demand - Ignore NCSI traffic

## Excluding certain packet types from triggering the connection to dial

Depending on your environment, you might prefer to exclude certain types of traffic passing through the router from triggering the data connection. You can tell the router to ignore outbound TCP, UDP or ICMP packets. When any of these options are checked the router will not dial a connection when that type of outbound destined data packet reaches the router from a locally connected device.



Figure 25 - Dial on demand - Excluding IP protocols

## Excluding certain application types from triggering the connection to dial

Some devices may generate general traffic as a part of normal operation which you may not want to trigger the data connection. You can set the router to ignore Domain Name System (DNS), Network Time Protocol (NTP) or Microsoft network awareness (NCSI) traffic from devices behind the router. When you check the box for these options, it tells the router to ignore the request from that application type and will not dial a connection when this data type is received.



Figure 26 - Dial on demand - Excluding application types

## Setting timers for connection and disconnection

The router has a number of timer settings which let you determine when a connection is dialled and when it is disconnected.

**Connect and disconnect timers**
**Periodic connect schedule**

**On data activity, stay online for at least**

**After connecting, stay online for at least**

**After hanging up, don't redial for**

**Disconnect regardless of traffic after**

**Connect regularly, every**

**Randomise connect frequency by up to**

Figure 27 - Dial on demand - Connect and disconnect timers

OPTION	DESCRIPTION
On data activity, stay online for at least	When traffic as per the configured settings above appear, the router will either continue to stay online, or dial a connection and will not disconnect it for the specified time period (min. 1 minute, max. 1 hour). This timer is continuously reset throughout the duration of a dial-up session, whenever data activity is detected matching the rules above.
After connecting, stay online for at least	This timer configures the router to not hang-up the connection for the specified time period after initially dialling the connection. This setting cannot be less than the keep online period above. This timer affects the connection only once per dial up session, at the beginning of the session.
After hanging up, don't redial for	After a connection has been disconnected, you can tell the router to rest for a period of time before re-dialling.
Disconnect regardless of traffic after	Forces the router to disconnect the connection regardless of the traffic passing through it. The default setting is <i>never</i> .
Connect regularly, every / Randomise connect frequency by up to	<p>If you want to have the router dial a connection at regular intervals, use <b>Connect regularly, every</b> to specify the interval between dials. Setting this to <i>never</i> effectively disables this option.</p> <p>The router also features the ability to randomise the time at which the first dial action is performed. This is useful in situations such as where you have numerous routers in an area where a power outage has occurred. Setting a random dial time helps to reduce network congestion when all the routers are powered on so they do not all try to connect simultaneously.</p> <p>When it is set to at least 2 minutes, you are able to configure the router to randomise the time it begins to dial. The randomised dial timer only affects the initial dial after the unit powers on or after the settings are saved. For example, if you configure the router to dial every 2 minutes with a randomised dial time of 1 minute, the router will dial the initial connection at a time greater than 2 minutes, but less than 3 minutes. After the first dial, the router will dial the connection exactly every 2 minutes.</p>

Table 13 - Connect on demand - Connect and disconnect timers descriptions

## Verbose mode

The router provides the option of logging all the data activity which matches the settings for the Dial on demand feature for advanced troubleshooting purposes. To enable the logging of the Dial on demand feature, click the **Enable verbose mode** toggle key to switch it ON. See the System log section for more information.

**Verbose logging configuration**

Log all matched activity to the system log  ON  OFF

Figure 28 - Dial on demand - Verbose logging configuration

## Manually connecting/disconnecting

There may be times when you need to either force a connection to be made or force a disconnection manually. You can use the **Manual connect** and **Manual disconnect** buttons to do this whenever necessary. The online status of the connection is displayed above the buttons.

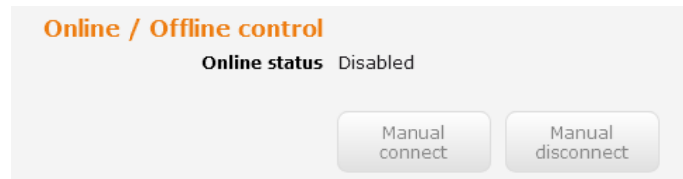

*Figure 29 - Dial on demand - Online/Offline control*

When you have finished configuring the options for the Dial on demand feature, click the **Save** button at the bottom to save your changes.

## SMS Wake up

The router can also be woken up by means of an SMS message using the SMS diagnostics feature by sending a zero byte class 1 flash SMS. See the [Diagnostics](#) section for details on using the SMS Wake up function.

## Operator Settings

The Operator settings page enables you to select which frequency band you will use for your connection and enables you to scan for available network operators in your area.

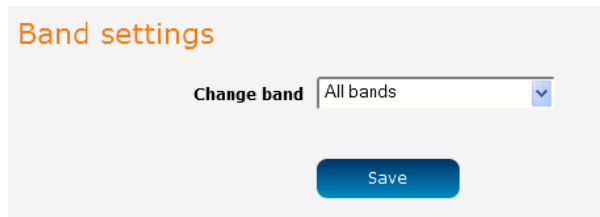

Figure 30 - Band settings



Note: In order to change the cellular band settings, the data connection must be disabled. When you access this page, you are prompted to disable the data connection if it is already active.

You may want to do this if you're using the router in a country with multiple frequency networks that may not all support High Speed Packet Access (HSPA). You can select the router to only connect on the network frequencies that suit your requirements.

Use the **Change band** drop down list to select the band you wish to use.

The following band settings options are available:

-  All Bands
-  GSM All
-  WCDMA All
-  GSM 850
-  GSM 900
-  GSM 1800
-  GSM 1900
-  WCDMA 850
-  WCDMA 900
-  WCDMA 800
-  WCDMA 1900
-  WCDMA 2100

It is not necessary to change the default setting of **All bands** in most cases. In fact, locking to a particular band can cause connection difficulties if the device is moved to a location where the forced band selection is no longer available.

When **All bands** is selected, the router attempts to find the most suitable band based on the available networks for the inserted SIM card.

The GSM All and the WCDMA all options allow you to force the device to lock to either 2G networks only, or 3G networks only.

Click the **Save** button to save and apply your selection.

## Operator settings

The operator settings feature allows you perform a scan of available networks, and to optionally lock to a particular network returned by the network scan. To scan for available networks, set the **Select operator mode** from automatic to **Manual** then click the scan button. This operation can take a few minutes and requires that the packet data session be disconnected prior to scanning.

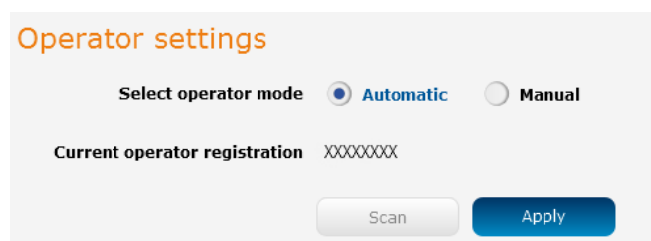



Figure 31 - Operator settings

A list of the detected 3G service carriers in your area is displayed.

Operator name list	MCC	MNC	Operator status	Network type
<input checked="" type="radio"/> Telstra	505	01	Current	UMTS (3G)
<input type="radio"/> Telstra	505	01	Available	GSM (2G)
<input type="radio"/> vodafone AU	505	03	Forbidden	GSM (2G)
<input type="radio"/> YES OPTUS	505	02	Forbidden	GSM (2G)
<input type="radio"/> YES OPTUS	505	02	Forbidden	UMTS (3G)
<input type="radio"/> vodafone AU	505	03	Forbidden	UMTS (3G)

Figure 32 - Detected operator list

Select the most appropriate 3G service from the list shown and click **Apply**.

When **Select operator mode** is set to **Automatic**, the router selects the most appropriate operator based on the inserted SIM card. This is the default option and is sufficient for most users.

## SIM security settings

The SIM security settings page can be used for authenticating SIM cards that have been configured with a security PIN.

### Unlocking a PIN locked SIM

If the SIM card is locked, you will receive a notice when you access the Status page after which you will be directed to the PIN settings page to enter the PIN. The PIN settings page lists the status of the SIM at the top of the page.

If you are not redirected to the PIN settings page, to unlock the SIM:

- a) Click on the **Networking** menu from the top menu bar, and then click **SIM security settings**.

### PIN settings

! SIM is PIN locked - remaining attempt(s) 3

**Current PIN**

**Confirm current PIN**

**Remember PIN**

Figure 33 - SIM security settings - SIM PIN locked

- b) Enter the PIN in the **Current PIN** field and then enter it again in the **Confirm current PIN** field to confirm the PIN.
- c) If you are placing the router in a remote, unattended location, you may wish to check the **Remember PIN** option. This feature allows the router to automatically send the PIN to the SIM each time the SIM asks for it (usually at power up). This enables the SIM to be PIN locked (to prevent unauthorised re-use of the SIM elsewhere), while still allowing the router to connect to the cellular service.

When this feature is enabled, the PIN you enter when setting the **Remember PIN** feature is encrypted and stored locally on the router. The next time the SIM asks the router for the PIN, the router decrypts the PIN and automatically sends it to the SIM without user intervention.

When this feature is disabled and the SIM is PIN locked and the PIN must be manually entered via the router's configuration interface. In situations where the router will be unattended, this is not desirable.



Note: Select Remember PIN if you do not want to enter the PIN code each time the SIM is inserted.

- d) Click the **Save** button. If successful, the router displays the following screen:

## Enabling/Disabling SIM PIN protection

The security PIN protection can be turned on or off using the **PIN protection** toggle key.

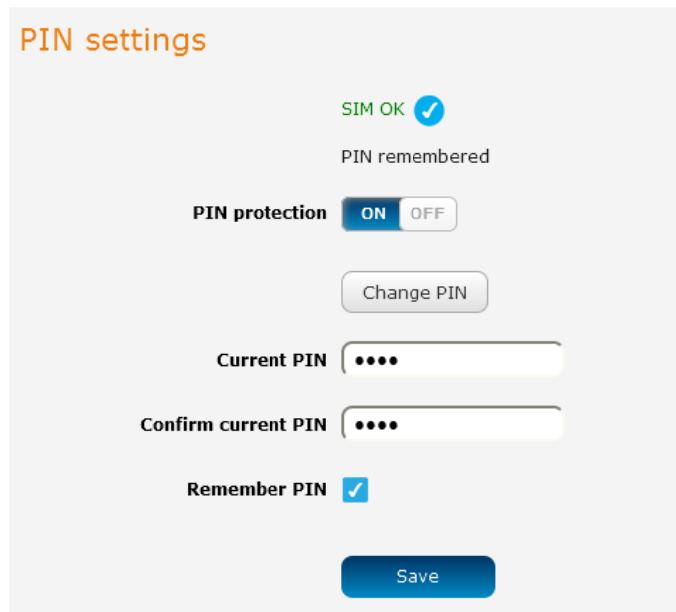

**PIN settings**

SIM OK

PIN remembered

**PIN protection**  ON OFF

Change PIN

**Current PIN**

**Confirm current PIN**

**Remember PIN**

Save

Figure 34 - PIN Settings

## Changing the SIM PIN code

If you would like to change the PIN, click the **Change PIN** button and enter the current PIN into the **Current PIN** and **Confirm current PIN** fields, then enter the desired PIN into the **New PIN** and **Confirm new PIN** fields and click the **Save** button.

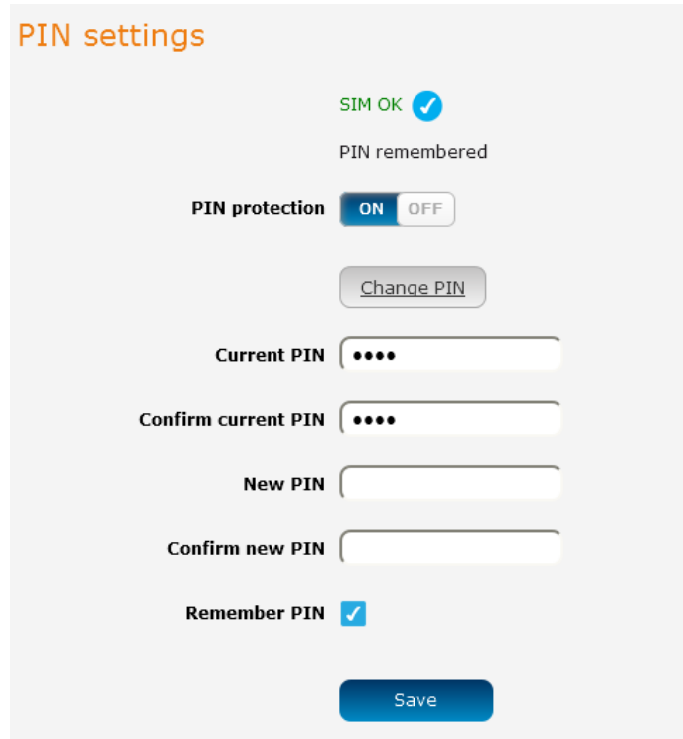

The screenshot shows the 'PIN settings' interface. At the top, it indicates 'SIM OK' with a green checkmark and 'PIN remembered'. Below this, there is a 'PIN protection' toggle switch currently set to 'ON'. A 'Change PIN' button is visible. Underneath are four input fields: 'Current PIN' and 'Confirm current PIN' both containing four black dots; 'New PIN' and 'Confirm new PIN' are empty. At the bottom, there is a 'Remember PIN' checkbox which is checked, and a blue 'Save' button.

Figure 35 - PIN settings - Change PIN

When the PIN has been changed successfully, the following screen is displayed:

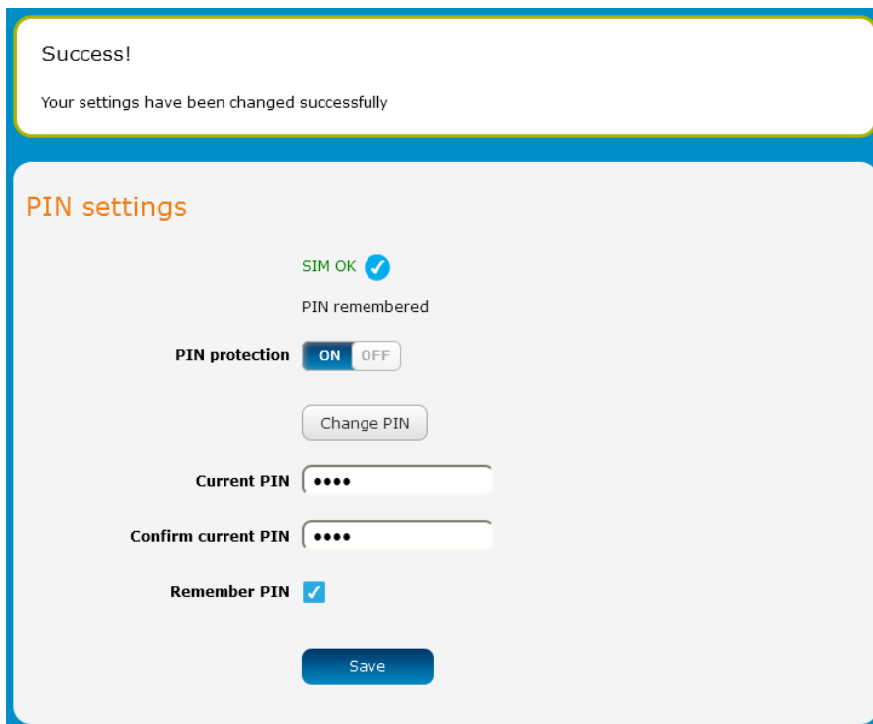

The screenshot shows a success message at the top: 'Success! Your settings have been changed successfully'. Below this, the 'PIN settings' interface is shown again, but with the 'Change PIN' button now disabled. The 'Current PIN' and 'Confirm current PIN' fields still contain four black dots, and the 'Remember PIN' checkbox remains checked. The 'Save' button is still present at the bottom.

Figure 36 - SIM security settings - PIN unlock successful

## Unlocking a PUK locked SIM

After three incorrect attempts at entering the PIN, the SIM card becomes PUK (Personal Unlocking Key) locked and you are requested to enter a PUK code to unlock it.



Note: To obtain the PUK unlock code, you must contact Vodafone.

You will be issued a PUK to enable you to unlock the SIM and enter a new PIN. Enter the new PIN and PUK codes.

Click the **Save** button when you have finished entering the new PIN and PUK codes.

Oops, something went wrong...

Your SIM is PUK locked now. Please enter the PUK code to unlock. You have 10 remaining attempt(s).

### PIN settings

 **SIM is PUK locked**

**Current PIN**

**Confirm current PIN**

**PUK**

**Confirm PUK**

**Remember PIN**

Figure 37 - SIM security - SIM PUK locked

# LAN

## LAN configuration

The LAN configuration page is used to configure the LAN settings of the router and to enable or disable DNS Masquerading.

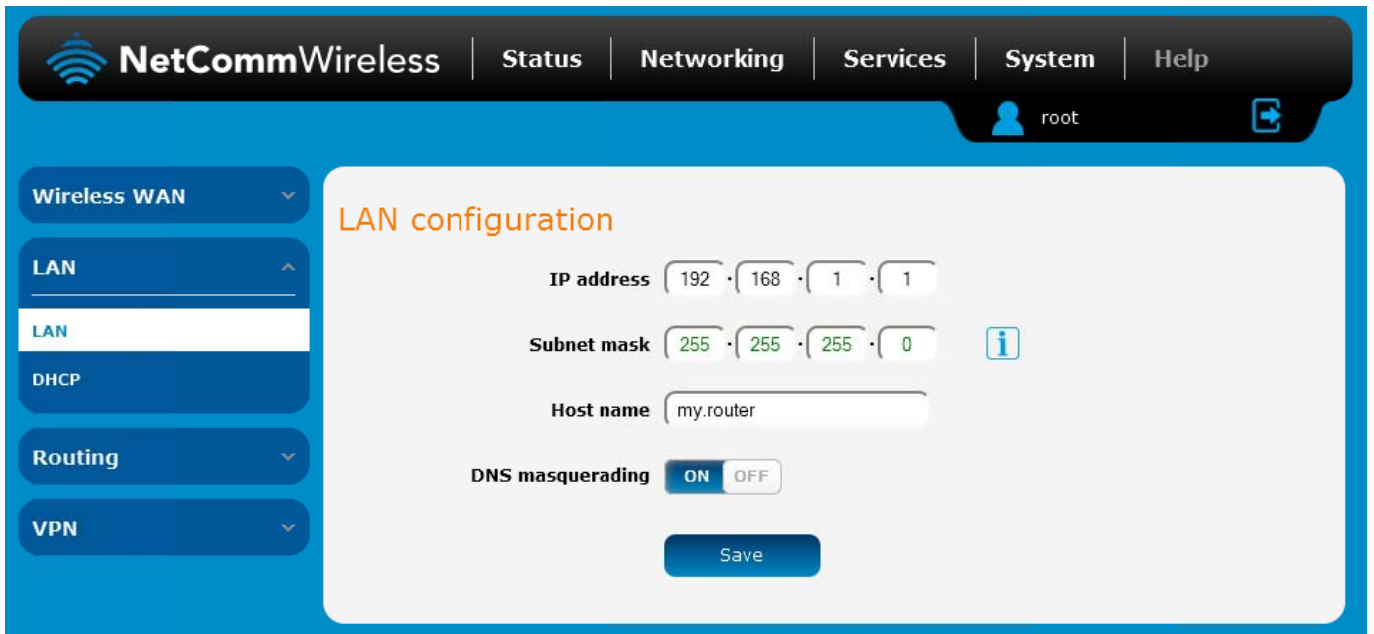

Figure 38 – LAN configuration settings

The default IP of the Ethernet port is 192.168.1.1 with subnet mask 255.255.255.0. To change the IP address or Subnet mask, enter the new IP Address and/or Subnet mask and click the **Save** button.



Note: If you change the IP address, remember to reboot the router and enter the new IP address into your browser address bar.

### DNS masquerading

DNS masquerading allows the router to proxy DNS requests from LAN clients to dynamically assigned DNS servers. When enabled, clients on the router's LAN can then use the router as a DNS server without needing to know the dynamically assigned cellular network DNS servers.

With DNS masquerading **ON**, the DHCP server embedded in the 3G Light Industrial M2M router hands out its own IP address (e.g. 192.168.1.1) as the DNS server address to LAN clients. The downstream clients then send DNS requests to the 3G Light Industrial M2M router which proxies them to the upstream DNS servers.

With DNS masquerading **OFF**, the DHCP server hands out the upstream DNS server IP addresses to downstream clients directly, so that downstream clients send DNS requests directly to the upstream DNS servers without being proxied by the 3G Light Industrial M2M router.

You may also override the DNS Masquerading option by specifying custom DNS Server IP addresses in the DHCP Server configuration mentioned in the next section of this guide. In this case the DHCP server assigns downstream devices the manually configured addresses and the DNS Masquerading option is ignored.

In most cases, it is not necessary to disable DNS masquerading but if you need to, click the **DNS masquerading** toggle key to turn it **OFF** and then click the **Save** button.

## DHCP

The DHCP page is used to adjust the settings used by the router's built in DHCP Server which assigns IP addresses to locally connected devices.

### DHCP relay configuration

In advanced networks configurations where the 3G Light Industrial M2M Router should not be responsible for DHCP assignment, but instead an existing DHCP server is located on the Wireless WAN connection, the clients behind the 3G Light Industrial M2M Router are able to communicate with the DHCP server when DHCP relay is enabled. This enables the 3G Light Industrial M2M Router to accept client broadcast messages and to forward them onto another subnet.

To configure the router to act as a DHCP relay agent click the **DHCP relay** toggle key to turn it ON and enter the DHCP server address into the **DHCP server address** field. DHCP relay is disabled by default.

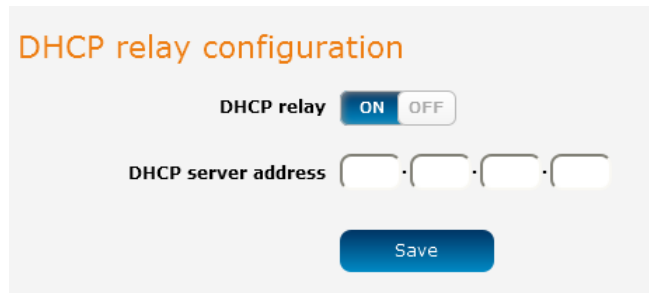

The screenshot shows the 'DHCP relay configuration' interface. At the top, the title 'DHCP relay configuration' is displayed in orange. Below the title, there is a 'DHCP relay' toggle switch currently set to 'ON'. Underneath, the 'DHCP server address' is represented by four empty input boxes separated by dots. At the bottom of the form is a blue 'Save' button.

Figure 39 - DHCP relay configuration

### DHCP configuration

You can manually set the start and end address range to be used to automatically assign addresses within, the lease time of the assigned address, the default domain name suffix, primary and secondary DNS server, the primary and secondary WINS server, as well as the advanced DHCP settings such as NTP, TFTP and Option 150/Option 160 (VoIP options).

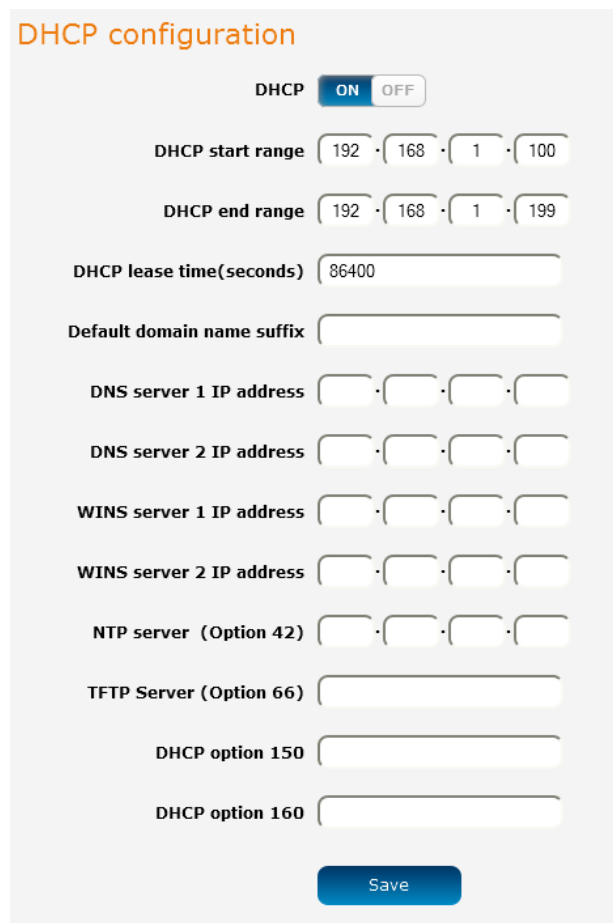

The screenshot shows the 'DHCP configuration' interface. The title 'DHCP configuration' is in orange. A 'DHCP' toggle switch is set to 'ON'. The 'DHCP start range' is set to '192.168.1.100' and the 'DHCP end range' is set to '192.168.1.199'. The 'DHCP lease time(seconds)' is set to '86400'. Below these are fields for 'Default domain name suffix', 'DNS server 1 IP address', 'DNS server 2 IP address', 'WINS server 1 IP address', 'WINS server 2 IP address', 'NTP server (Option 42)', 'TFTP Server (Option 66)', 'DHCP option 150', and 'DHCP option 160'. A blue 'Save' button is at the bottom.

Figure 40 - DHCP configuration

OPTION	DESCRIPTION
DHCP start range	Sets the first IP address of the DHCP range
DHCP end range	Sets the last IP address of the DHCP range
DHCP lease time (seconds)	The length of time in seconds that DHCP allocated IP addresses are valid
Default domain name suffix	Specifies the default domain name suffix for the DHCP clients. A domain name suffix enables users to access a local server, for example, server1, without typing the full domain name server1.domain.com
DNS server 1 IP address	Specifies the primary DNS (Domain Name System) server's IP address.
DNS server 2 IP address	Specifies the secondary DNS (Domain Name System) server's IP address.
WINS server 1 IP address	Specifies the primary WINS (Windows Internet Name Service) server IP address
WINS server 2 IP address	Specifies the secondary WINS (Windows Internet Name Service) server IP address
NTP server (Option 42)	Specifies the IP address of the NTP (Network Time Protocol) server
TFTP Server (Option 66)	Specifies the TFTP (Trivial File Transfer Protocol) server
DHCP option 150	This is used to configure Cisco IP phones. When a Cisco IP phone starts, if it is not pre-configured with the IP address and TFTP address, it sends a request to the DHCP server to obtain this information. Specify the string which will be sent as a reply to the option 150 request.
DHCP option 160	This is used to configure Polycom IP phones. When a Polycom IP phone starts, if it is not pre-configured with the IP address and TFTP address, it sends a request to the DHCP server to obtain this information. Specify the string which will be sent as a reply to the option 160 request.

Enter the desired DHCP options and click the **Save** button.

### Address reservation list

DHCP clients are dynamically assigned an IP address as they connect, but you can reserve an address for a particular device using the address reservation list.



The screenshot shows a web interface for configuring an address reservation list. At the top right is a '+ Add' button. Below it is a table with four columns: 'Computer name', 'MAC address', 'IP address', and 'Enable'. The 'Computer name' and 'MAC address' columns have empty text input fields. The 'IP address' column contains four input boxes, each with the number '0', separated by dots. The 'Enable' column has a toggle switch currently set to 'ON' and a close button with an 'X' icon. At the bottom center of the form is a blue 'Save' button.

Figure 41 – DHCP – Address reservation list

To add a device to the address reservation list:

1. Click the **+Add** button.
2. In the **Computer Name** field enter a name for the device.
3. In the **MAC Address** field, enter the device's MAC address.
4. In the **IP Address** fields, enter the IP address that you wish to reserve for the device.
5. If the **Enable** toggle key is not set to **ON**, click it to switch it to the **ON** position.
6. Click the **Save** button to save the settings.

### Dynamic DHCP client list

The Dynamic DHCP client list displays a list of the DHCP clients. If you want to reserve the current IP address for future use, click the **Clone** button and the details will be copied to the address reservation list fields. Remember to click the **Save** button under the **Address reservation list** section to confirm the configuration.

Dynamic DHCP client list				
Computer name	MAC address	IP address	Expiry time	
xxxxxx	00:21:9b:1a:89:ee	192.168.1.146	Thursday, 5 September 2013 12:02:59 PM	

Figure 42 - Dynamic DHCP client list



# Routing

## Static

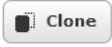
Static routing is the alternative to dynamic routing used in more complex network scenarios and is used to facilitate communication between devices on different networks. Static routing involves configuring the routers in your network with all the information necessary to allow the packets to be forwarded to the correct destination. If you change the IP address of one of the devices in the static route, the route will be broken.

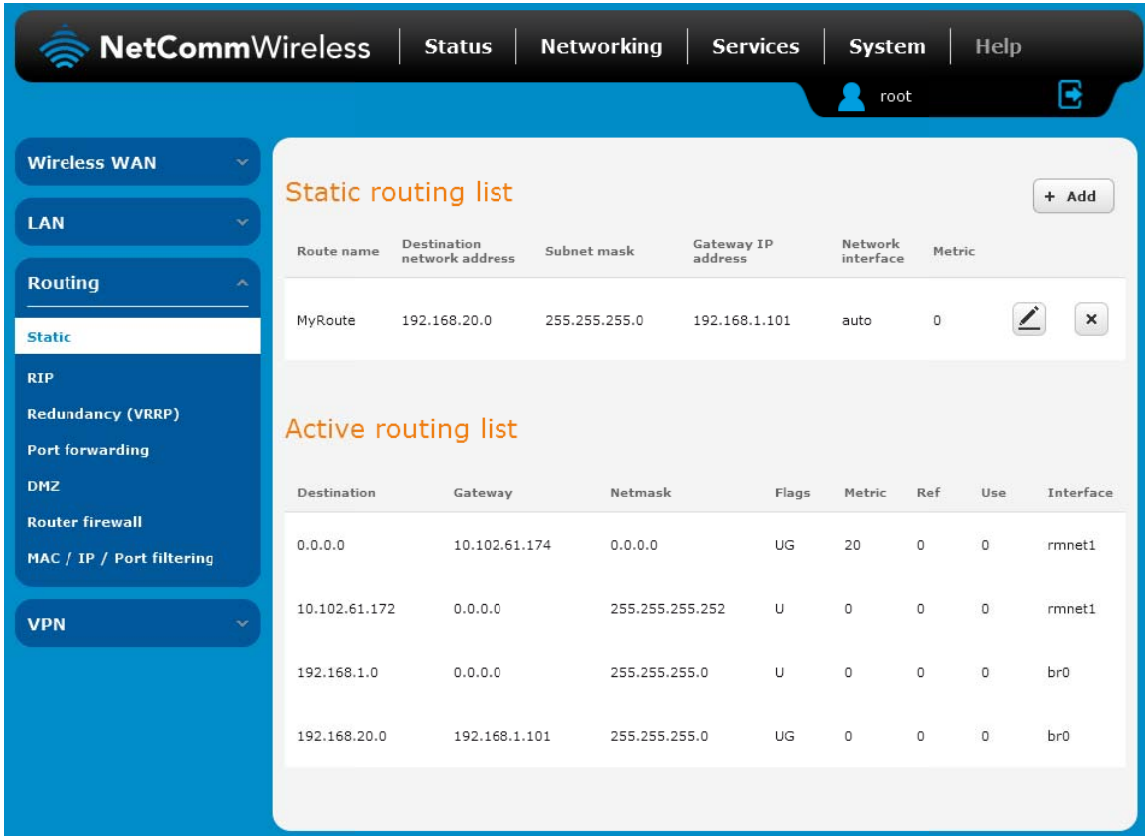

**Static routing list** + Add

Route name	Destination network address	Subnet mask	Gateway IP address	Network interface	Metric
MyRoute	192.168.20.0	255.255.255.0	192.168.1.101	auto	0

**Active routing list**

Destination	Gateway	Netmask	Flags	Metric	Ref	Use	Interface
0.0.0.0	10.102.61.174	0.0.0.0	UG	20	0	0	rmnet1
10.102.61.172	0.0.0.0	255.255.255.252	U	0	0	0	rmnet1
192.168.1.0	0.0.0.0	255.255.255.0	U	0	0	0	br0
192.168.20.0	192.168.1.101	255.255.255.0	UG	0	0	0	br0

Figure 43 - Static routing list

Some routes are added by default by the router on initialization such as the Ethernet subnet route for routing to a device on the Ethernet subnet.

## Adding Static Routes

To add a new route to the static routing list, click the **+Add** button. The Static routes page appears.

1. In the **Route name** field, type a name for the route so that it can be identified in the static routing list.
2. From the **Network interface** drop down list, select the interface for which you would like to create a static route.
3. In the **Destination IP address** field, enter the IP address of the destination of the route.
4. In the **IP subnet mask** field, enter the subnet mask of the route.
5. In the **Gateway IP address** field, enter the IP address of the gateway that will facilitate the route.
6. In the **Metric** field enter the metric for the route. The metric value is used by the router to prioritise routes. The lower the value, the higher the priority. To give the route the highest priority, set it to 0.
7. Click the **Save** button to save your settings.

### Static routes

Route name

Network interface

Destination network address  ·  ·  ·

Destination subnet mask  ·  ·  ·

Gateway IP address  ·  ·  ·

Metric  (0-65535)

Figure 44 - Adding a static route

### Active routing list

Static routes are displayed in the Active routing list.

### Active routing list

Destination	Gateway	Netmask	Flags	Metric	Ref	Use	Interface
0.0.0.0	10.102.61.174	0.0.0.0	UG	20	0	0	rmnet1
10.102.61.172	0.0.0.0	255.255.255.252	U	0	0	0	rmnet1
192.168.1.0	0.0.0.0	255.255.255.0	U	0	0	0	br0

Figure 45 - Active routing list

### Deleting static routes

From the static routing list, click the  icon to the right of the entry you wish to delete.

### Static routing list



Route name	Destination network address	Subnet mask	Gateway IP address	Network interface	Metric		
MyRoute	192.168.20.0	255.255.255.0	192.168.1.101	auto	0		

Figure 46 - Deleting a static route

## RIP

RIP (Routing Information Protocol) is used for advertising routes to other routers. Thus all the routes in the router's routing table will be advertised to other nearby routers. For example, the route for the router's Ethernet subnet could be advertised to a router on the PPP interface side so that a router on this network will know how to route to a device on the router's Ethernet subnet. Static routes must be added manually according to your requirements. See [Adding Static Routes](#).



Note: Some routers will ignore RIP.

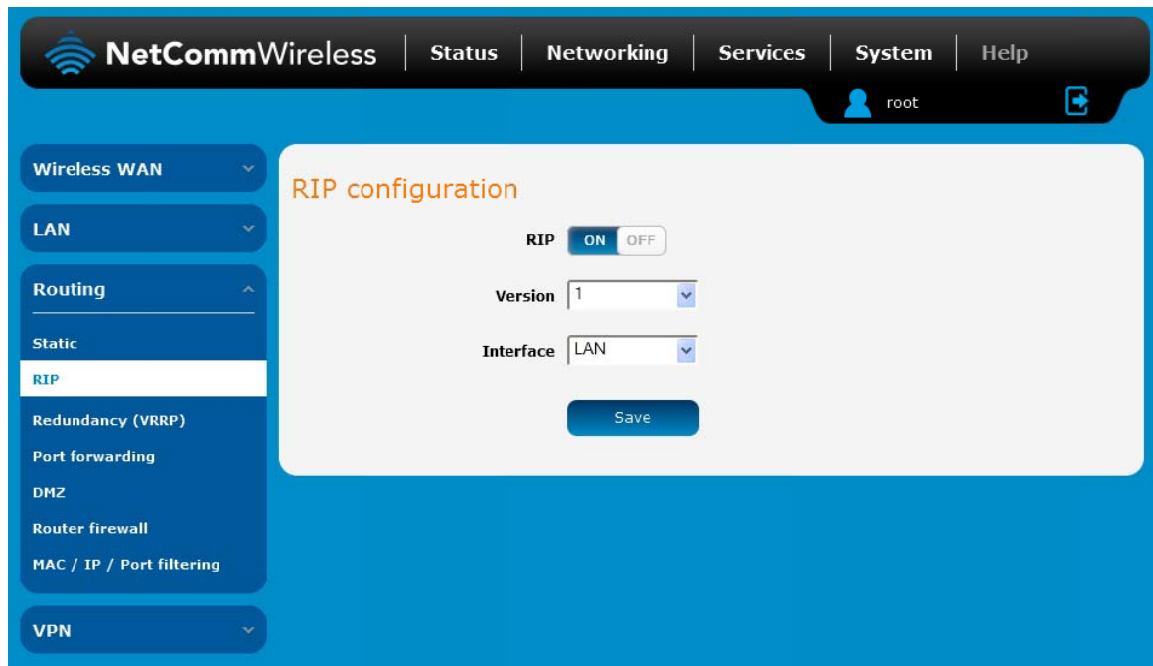

Figure 47 - RIP configuration

To enable Routing Information Protocol (RIP)

1. Click the **RIP** toggle key to switch it to the **ON** position.
2. Using the **Version** drop down list, select the version of RIP that you would like to use.
3. Select the interface for which you want RIP to apply. You can choose the **LAN** interface, the **WWAN** interface or **Both**.
4. Click the **Save** button to confirm your settings.

## Redundancy (VRRP) configuration

Virtual Router Redundancy Protocol (VRRP) is a non-proprietary redundancy protocol designed to increase the availability of the default gateway servicing hosts on the same subnet. This increased reliability is achieved by advertising a "virtual router" (an abstract representation of master and backup routers acting as a group) as a default gateway to the host(s) instead of one physical router. Two or more physical routers are then configured to stand for the virtual router, with only one doing the actual routing at any given time. If the current physical router that is routing the data on behalf of the virtual router fails, an arrangement is made for another physical router to automatically replace it. The physical router that is currently forwarding data on behalf of the virtual router is called the master router.

Master routers have a priority of 255 and backup router(s) can have a priority between 1 and 254.

A virtual router must use 00-00-5E-00-01-XX as its (MAC) address. The last byte of the address (XX) is the Virtual Router Identifier (VRID), which is different for each virtual router in the network. This address is used by only one physical router at a time, and is the only way that other physical routers can identify the master router within a virtual router.

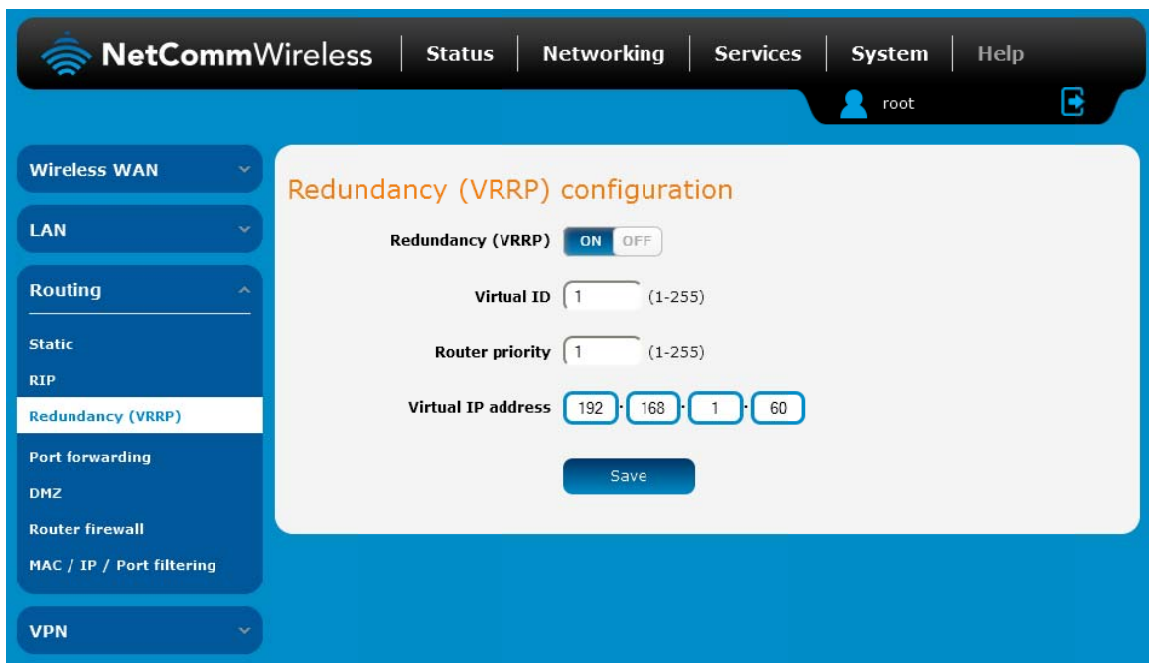

Figure 48 - VRRP configuration

To configure VRRP, configure multiple devices as follows and connect them all via an Ethernet network switch to downstream devices.

1. Click the **Redundancy (VRRP)** toggle key to activate VRRP.
2. In the **Virtual ID** field, enter an ID between 1 and 255. This is the VRRP ID which is different for each virtual router on the network.
3. In the **Router priority** field, enter a value for the priority – a higher value is a higher priority.
4. The **Virtual IP address** field is used to specify the VRRP IP address – this is the virtual IP address that both virtual routers share.
5. Click the **Save** button to save the new settings.



Note: Configuring VRRP changes the MAC address of the Ethernet port and therefore if you want to resume with the web configuration you must use the new IP address (VRRP IP) or on a command prompt type:

`arp -d <ip address>` (i.e. `arp -d 192.168.1.1`) to clear the arp cache.(old MAC address).

## Port Forwarding

The Port forwarding list is used to configure the Network Address Translation (NAT) rules currently in effect on the router.

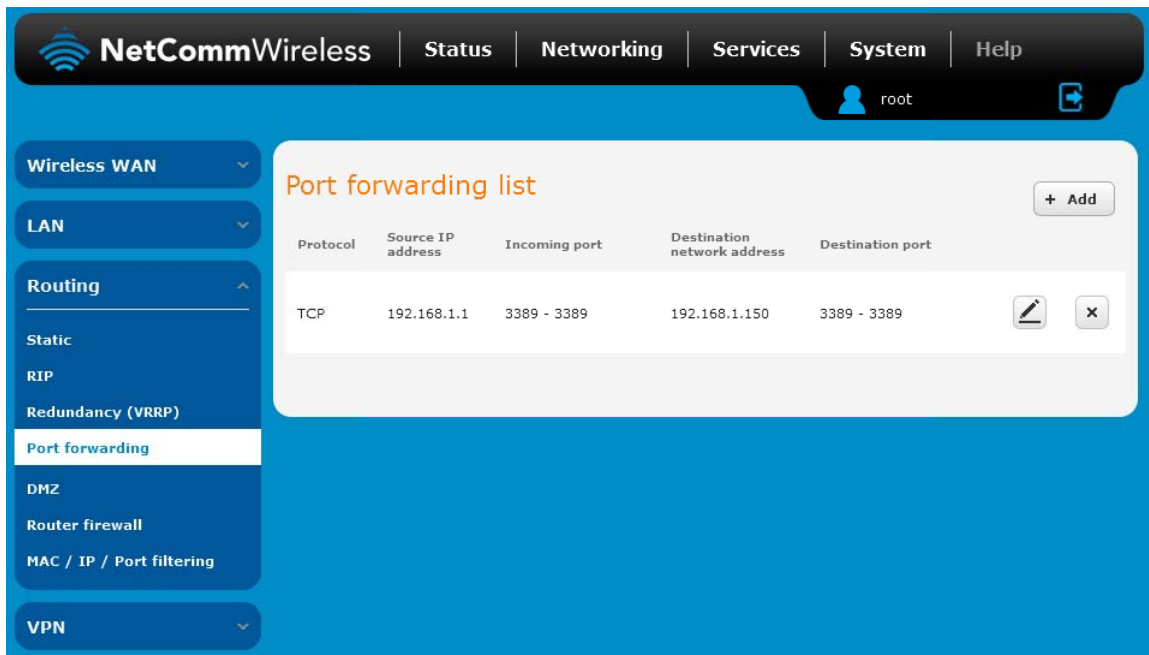

Figure 49 – Port forwarding list

The purpose of the port forwarding feature is to allow mapping of inbound requests to a specific port on the WAN IP address to a device connected on the Ethernet interface.

### Adding a port forwarding rule

To create a new port forwarding rule:

1. Click the **+Add** button. The port forwarding settings screen is displayed.
2. Use the **Protocol** drop down list to select the type of protocol you want to use for the rule. The protocols selections available are TCP, UDP and All.
3. In the **Source IP Address** field, enter a “friendly” address that is allowed to access the router or a wildcard IP address (0.0.0.0) that allows all IP addresses to access the router.
4. The **Source Port Range (From)** and **(To)** fields are used to specify the port(s) on the source side that are to be forwarded. This allows you to send a range of consecutive port numbers by entering the first in the range in the **(From)** field and the last in the range in the **(To)** field. To forward a single port, enter the port in the **(From)** field and repeat it in the **(To)** field.
5. In the **Destination network address** field, enter the IP address of the client to which the traffic should be forwarded.
6. The **Destination Port Range (From)** and **(To)** fields are used to specify the port(s) on the destination side that are to be forwarded. If the Source port range specifies a single port then the destination port may be configured to any port. If the Source port range specifies a range of port numbers then the Destination port range must be the same as the Source port range.
7. Click the **Save** button to confirm your settings.

### Port forwarding settings

**Protocol**

**Source IP address**  ·  ·  ·

**Source port range (From)**  ( 1-65535 ) **(To)**  ( 1-65535 )

**Destination network address**  ·  ·  ·

**Destination port range (From)**  ( 1-65535 ) **(To)**  ( 1-65535 )

*Figure 50 - Port forwarding settings*

To delete a port forwarding rule, click the  button on the Port forwarding list for the corresponding rule that you would like to delete.

## DMZ

The Demilitarized Zone (DMZ) allows you to configure all incoming traffic on all protocols to be forwarded to a selected device behind the router. This feature can be used to avoid complex port forwarding rules, but it exposes the device to untrusted networks as there is no filtering of what traffic is allowed and what is denied.

The DMZ configuration page is used to specify the IP Address of the device to use as the DMZ host.

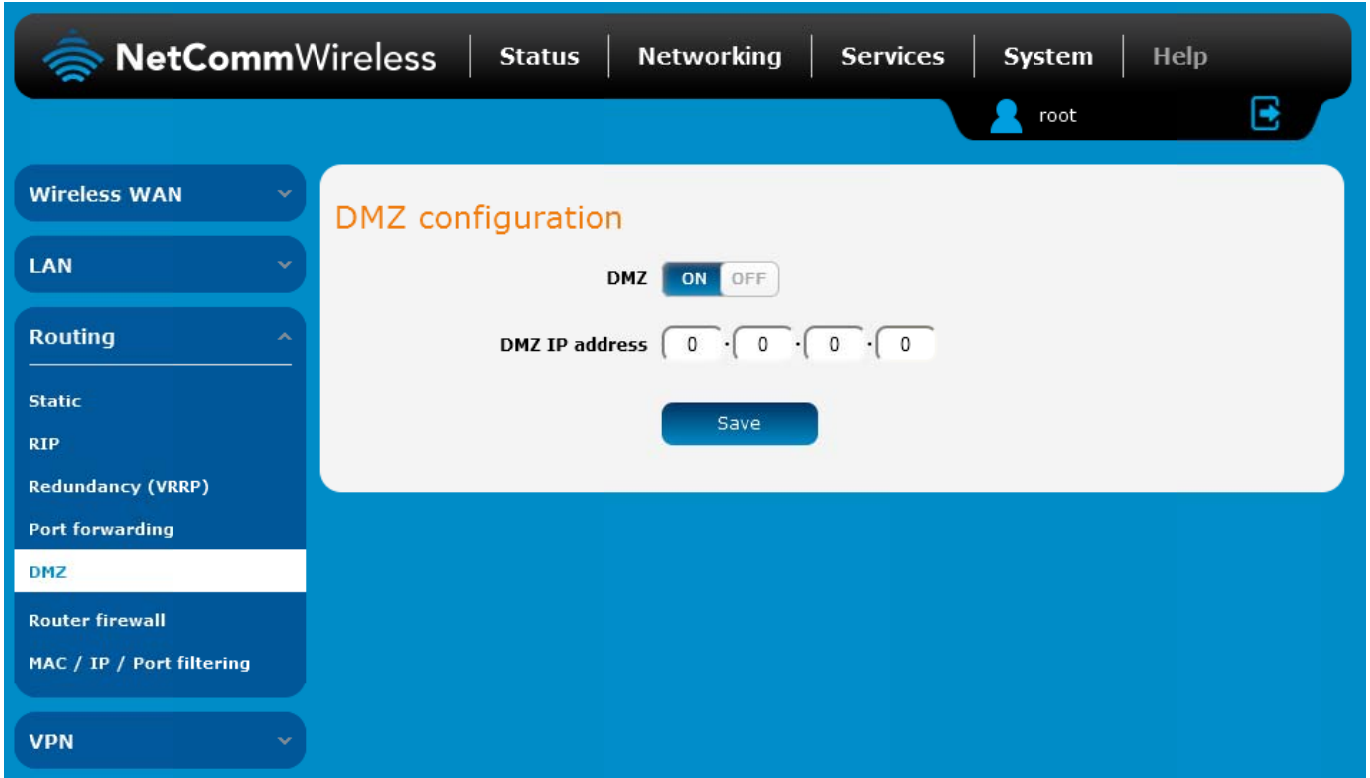

The screenshot displays the NetCommWireless web interface. At the top, there is a navigation bar with the logo and menu items: Status, Networking, Services, System, and Help. The user is logged in as 'root'. On the left side, a sidebar menu lists various configuration options: Wireless WAN, LAN, Routing, Static, RIP, Redundancy (VRRP), Port forwarding, DMZ (highlighted), Router firewall, MAC / IP / Port filtering, and VPN. The main content area is titled 'DMZ configuration'. It contains a 'DMZ' toggle switch currently set to 'ON', a 'DMZ IP address' field with four input boxes each containing the digit '0', and a 'Save' button.

Figure 51 - DMZ configuration

1. Click the DMZ toggle key to turn the DMZ function ON.
2. Enter the IP Address of the device to be the DMZ host into the DMZ IP Address field.
3. Click the **Save** button to save your settings.

## Router Firewall

The Router firewall page is used to enable or disable the in-built firewall on the router. When enabled, the firewall performs stateful packet inspection on inbound traffic from the wireless WAN and blocks all unknown services, that is, all services not listed on the Services configuration page of the router.

With respect to the other Routing options on the Networking page, the firewall takes a low priority. The priority of the firewall can be described as:

DMZ > MAC/IP/Port filtering rules > MAC/IP/Port filtering default rule > Router firewall rules

In other words, the firewall is of the lowest priority when compared to other manual routing configurations. Therefore, a MAC/IP/Port filtering rule takes priority in the event that there is a conflict of rules. When DMZ is enabled, MAC/IP/Port filtering rules and the router firewall are ignored but the router will still honour the configuration of the Remote router access control settings listed under Administration Settings.

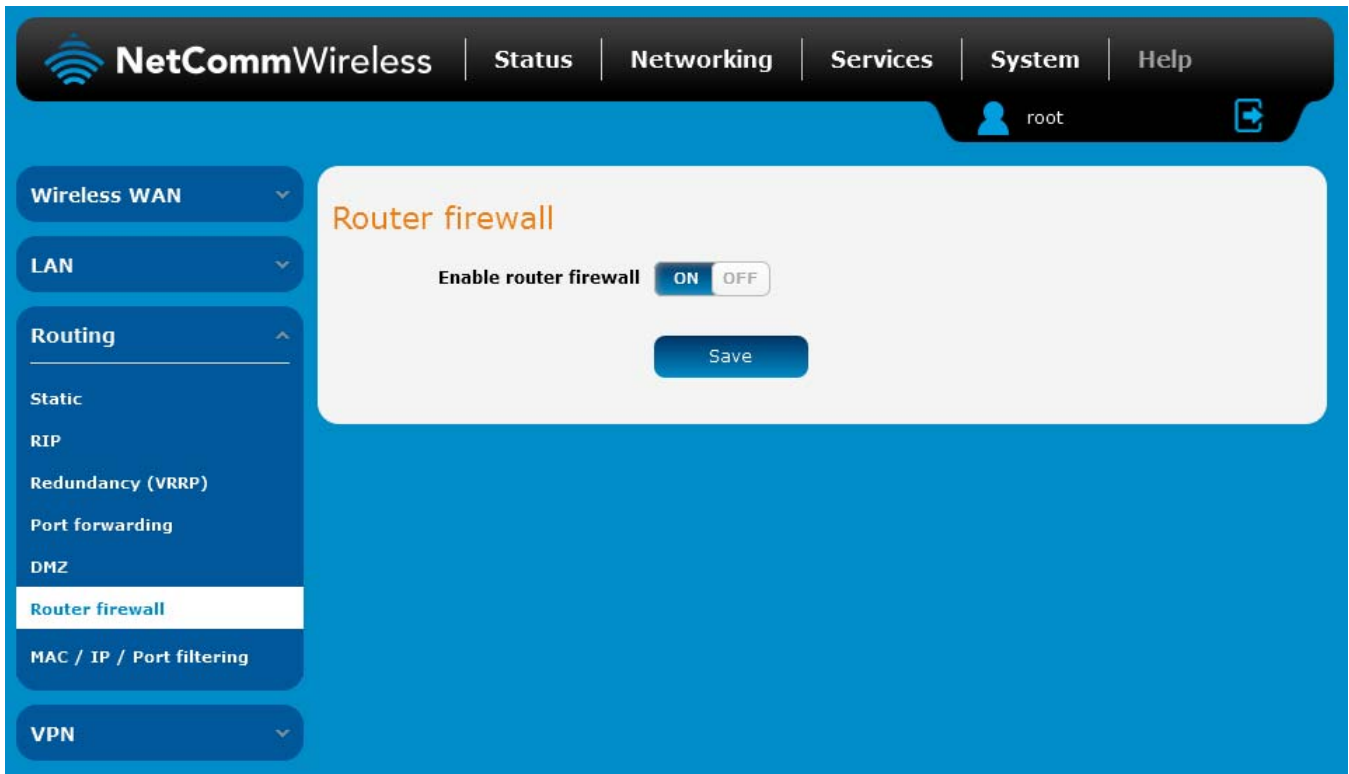

Figure 52 - Router Firewall toggle key



## MAC / IP / Port filtering

The MAC/IP/Port filter feature allows you apply a policy to the traffic that passes through the router, both inbound and outbound, so that network access can be controlled. When the filter is enabled with a default rule of "Accepted", all connections will be allowed except those listed in the "Current MAC / IP / Port filtering rules in effect" list. Conversely, when the default rule is set to "Dropped", all connections are denied except for those listed in the filtering rules list.

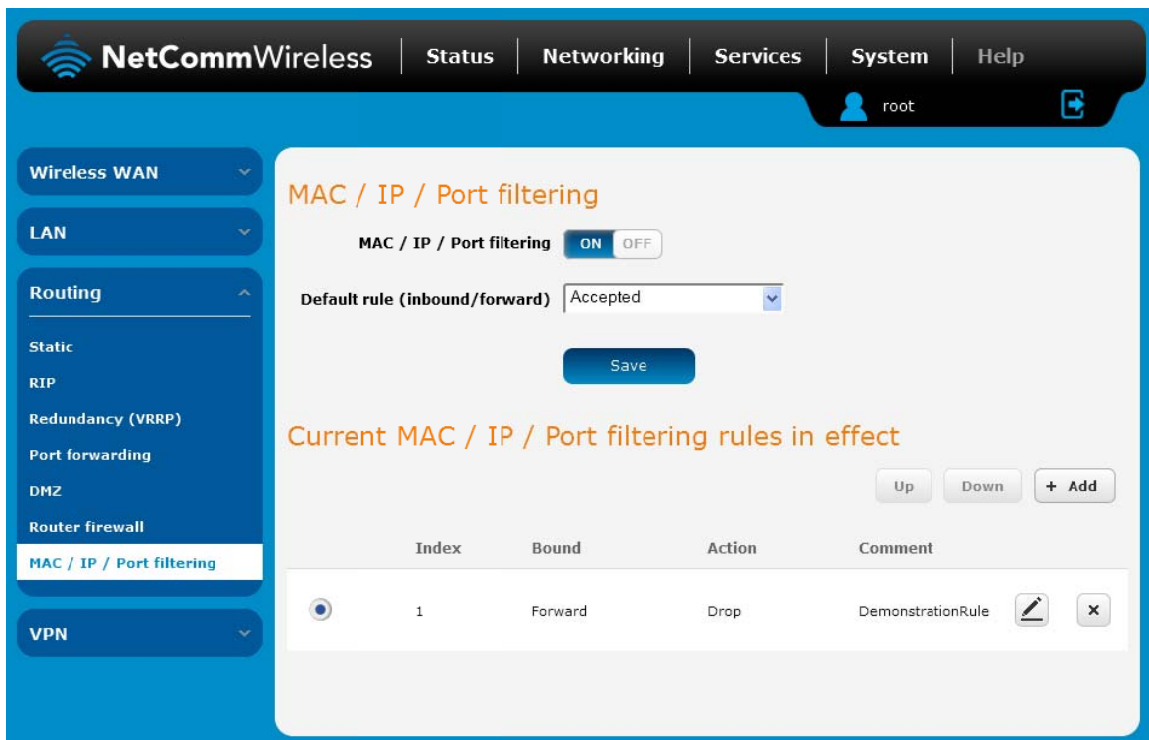

Figure 53 - MAC / IP / Port filtering



Note: When enabling MAC / IP / Port filtering and setting the default rule to "Dropped", you should ensure that you have first added a filtering rule which allows at least one known MAC/IP to access the router, otherwise you will not be able to access the user interface of the router without resetting the router to factory default settings.

## Creating a MAC / IP / Port filtering rule

To create a filtering rule:

1. Click the **MAC / IP / Port filtering** toggle key to switch it to the **ON** position.
2. Using the **Default rule (inbound/forward)** drop down list, select the default action for the router to take when traffic reaches it. By default, this is configured to **Accepted**. If you change this to **Dropped**, you should first configure a filter rule that allows at least one device access to the router, otherwise you will effectively be locked out of the router.
3. Click the **Save** button to confirm the default rule.
4. In the **Current MAC / IP / Port filtering rules in system** section, click the **+Add** button.



Figure 54 - Current MAC / IP / Port filtering rules in effect

5. Enter the details of the rule in the section that is displayed and click the **Save** button.

### MAC / IP / Port filter settings

**Bound**

**Protocol**

**Source MAC address**

**Source IP address**     /

**Destination IP address**     /



**Action**

**Comment**

Figure 55 - MAC / IP / Port filtering settings

OPTION	DESCRIPTION
Bound	Use the drop down list to select the direction of the traffic for which you want to apply to the rule. <b>Inbound</b> refers to all traffic that is entering the router including data entering from the WAN and the LAN. <b>Outbound</b> refers to all traffic exiting the router including traffic leaving in the direction of the WAN and traffic leaving in the direction of the LAN. <b>Forward</b> specifies traffic that enters on the LAN or WAN side and is forwarded to the opposite end.
Protocol	Use the drop down list to select the protocol for the rule. You can have the rule apply to <b>All</b> protocols, <b>TCP</b> , <b>UDP</b> , <b>UDP/TCP</b> or <b>ICMP</b> .
Source MAC Address	Enter the MAC address in six groups of two hexadecimal digits separated by colons (:), e.g. 00:40:F4:CE:FA:1E
Source IP Address	Enter the IPv4 address that the traffic originates from and the subnet mask using CIDR notation.
Destination IP Address	Enter the IPv4 address that the traffic is destined for and the subnet mask using CIDR notation.
Action	Select the action to take for traffic which meets the above criteria. You can choose to <b>Accept</b> or <b>Drop</b> packets. When the default rule is set to <b>Accept</b> , you cannot create a rule with an <b>Accept</b> action since the rule is redundant. Likewise, if the default rule is set to <b>Dropped</b> you cannot create a rule with a <b>Drop</b> action.
Comment	[Optional] Use this field to enter a comment as a meaningful description of the rule.

Table 14 - Current MAC / IP / Port filtering rules in effect

6. The new rule is displayed in the filtering rules list. You can edit the rule by clicking the  **Edit** button or delete the rule by clicking the  **x** button.

### Current MAC/IP/Port filtering rules in system







	Index	Bound	Action	Comment	
<input checked="" type="radio"/>	1	Forward	Drop	Demonstration rule	 

Figure 56 - Completed filtering rule

## VPN

A Virtual Private Network (VPN) is a tunnel providing a private link between two networks or devices over a public network. Data to be sent via a VPN needs to be encapsulated and as such is generally not visible to the public network.

The advantages of a VPN connection include:

-  Data Protection
-  Access Control
-  Data Origin Authentication
-  Data Integrity

Each VPN connection has different configuration requirements. The following pages detail the configuration options available for the different VPN connection types.



Note: The following descriptions are an overview of the various VPN options available. More detailed instructions are available in separate whitepapers on the NetComm Wireless website.

## IPSec

IPSec operates on Layer 3 of the OSI model and as such can protect higher layered protocols. IPSec is used for both site to site VPN and Remote Access VPN. The 3G Light Industrial M2M router supports IPSec end points and can be configured with Site to Site VPN tunnels with third party VPN routers.

## Configuring an IPSec VPN

From the menu at the top of the screen, click **Networking** and under the VPN section, click **IPSec**. A list of configured IPSec VPN connections is displayed.

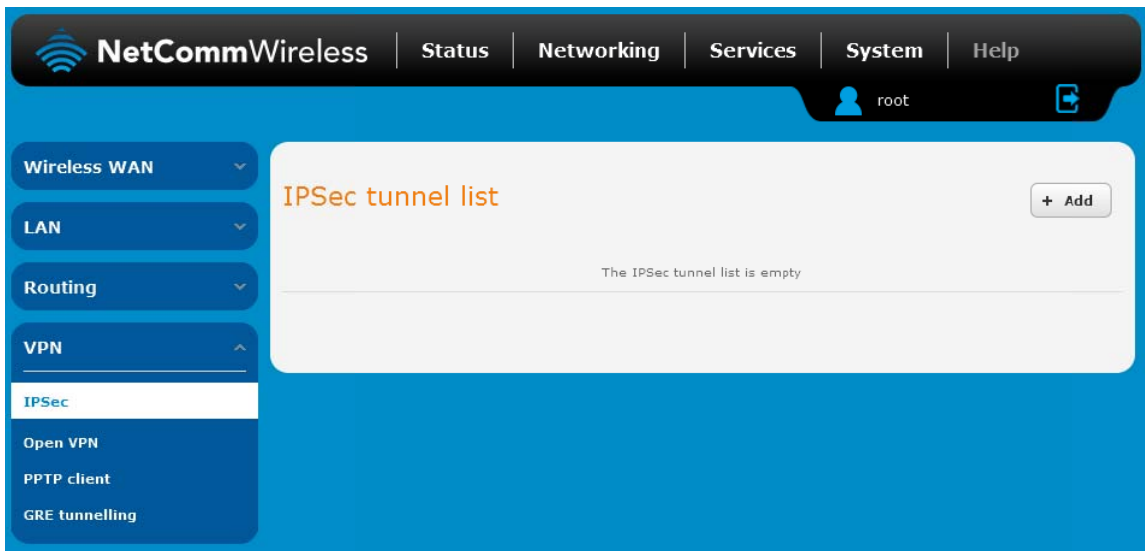

Figure 57 - IPSec VPN List

Click the **+Add** button to begin configuring an IPSec VPN connection.

## IPSec profile edit

**IPSec profile**  ON  OFF

**Profile name**

**Remote IPSec server address**  ·  ·  ·

**Remote LAN address**  ·  ·  ·

**Remote LAN subnet mask**  ·  ·  ·

**Local LAN address**  ·  ·  ·

**Local LAN subnet mask**  ·  ·  ·

**Encapsulation type**

**IKE mode**

**PFS**

**IKE Encryption**

**IKE hash**

**IPSec encryption**

**IPSec hash**

**DH group**

**DPD action**

**DPD keep alive time**  secs

**DPD timeout**  secs

**IKE re-key time**  (0-78400, 0=Unlimited) secs

**SA life time**  (0-78400, 0=Unlimited) secs

**Key mode**

**Pre-shared key**

**Remote ID**  (xy.sample.com or blank)

**Local ID**  (xy.sample.com or blank)

Figure 58 - IPSec profile edit



The following table describes each of the fields of the IPSec VPN Connection Settings page.

ITEM	DEFINITION
IPSec profile	Enables or disables the VPN profile.
Profile name	A name used to identify the VPN connection profile.
Remote IPSec server address	The IP address of the IPSec server.
Remote LAN address	Enter the IP address of the remote network for use on the VPN connection.
Remote LAN subnet mask	Enter the subnet mask in use on the remote network.
Local LAN address	Enter the IP address of the local network for use on the VPN connection.
Local LAN subnet mask	Enter the subnet mask in use on the local network.
Encapsulation type	Select the encapsulation protocol to use with the VPN connection. You can choose <b>ESP</b> , <b>AH</b> or <b>Any</b> .
IKE mode	Select the IKE mode to use with the VPN connection. You can choose <b>Main</b> , <b>Aggressive</b> or <b>Any</b> .
PFS	Choose whether Perfect Forward Secrecy is ON or OFF for the VPN connection.
IKE encryption	Select the cipher type to use for the Internet Key Exchange.
IKE hash	Select the IKE Hash type to use for the VPN connection. The hash is used for authentication of packets for the key exchange.
IPSec encryption	Select the IPSec encryption type to use with the VPN connection.
IPSec hash	Select the IPSec hash type to use for the VPN connection. The hash is used for authentication of packets for the VPN connection.
DH group	Select the desired Diffie-Hellman group to use. Higher groups are more secure but also require longer to generate a key.
DPD action	Select the desired Dead Peer Detection action. This is the action to take when a dead Internet Key Exchange Peer is detected.
DPD keep alive time	Enter the time in seconds for the interval between Dead Peer Detection keep alive messages.
DPD timeout	Enter the time in seconds of no response from a peer before Dead Peer Detection times out.
IKE re-key time	Enter the time in seconds between changes of the encryption key. To disable changing the key, set this to 0.
SA life time	Enter the time in seconds for the security association lifetime.
Key mode	Select the type of key mode in use for the VPN connection. You can select from: <ul style="list-style-type: none"> <li>● Pre Shared Key</li> <li>● RSA keys</li> <li>● Certificates</li> </ul>
Pre-shared key	The pre-shared key is the key that peers used to authenticate each other for Internet Key Exchange.
Remote ID	Specifies the domain name of the remote network.
Local ID	Specifies the domain name of the local network.
Update Time	Displays the last time the key was updated.
Local RSA Key Upload	Select the RSA key file for the local router here by clicking the <b>Browse</b> button.
Remote RSA Key Upload	Select the RSA key file for the remote router here by clicking the <b>Browse</b> button.
Private key Passphrase	The Private key passphrase of the router is the passphrase used when generating the router's private key using OpenSSL CA.
Key / Certificate	Select the type of key or certificate to use for authentication. You can select <b>Local private key</b> , <b>Local public certificate</b> , <b>Remote public certificate</b> , <b>CA certificate</b> , <b>CRL certificate</b> .
IPSec Certificate Upload	Select the IPSec certificate to upload by clicking the <b>Browse</b> button.

*Table 15 - IPSec Configuration Items*

## OpenVPN

OpenVPN is an open source virtual private network (VPN) program for creating point-to-point or server-to-multi-client encrypted tunnels between host computers. It can traverse network address translation (NAT) and firewalls and allows authentication by certificate, pre-shared key or username and password. OpenVPN works well through proxy servers and can run over TCP and UDP transports. Support for OpenVPN is available on several operating systems, including Windows, Linux, Mac OS, Solaris, OpenBSD, FreeBSD, NetBSD and QNX.

## Configuring an Open VPN server

From the menu at the top of the screen, click **Networking** and from the VPN section on the left, click **OpenVPN**. A list of configured OpenVPN VPN connections is displayed.

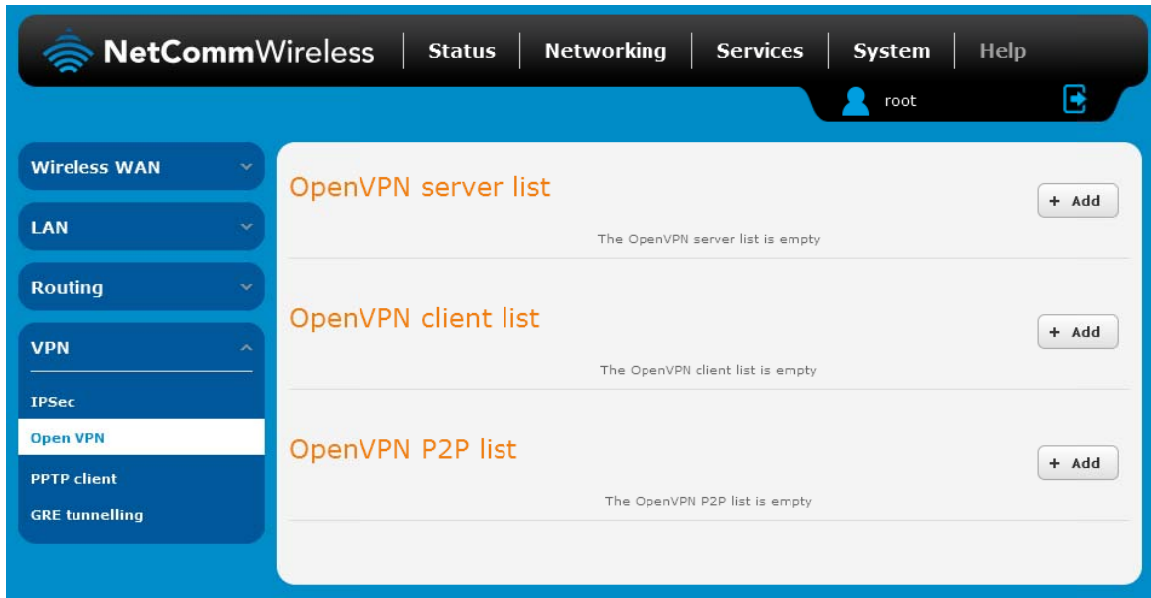

Figure 59 - OpenVPN VPN List

Click the **+Add** button for the type of OpenVPN server/client you would like to configure.

## OpenVPN Server

To configure an OpenVPN Server:

1. Click the **OpenVPN profile** toggle key to switch it to the **ON** position.
2. Type a name for the OpenVPN server profile you are creating.
3. Use the **Server port** field to select a port number and then use the drop down list to select a packet type to use for your OpenVPN Server. The default OpenVPN port is 1194 and default packet type is UDP.
4. In the **VPN network address** and **VPN network subnet mask** fields, enter the IP address and network subnet mask to assign to your VPN. This is ideally an internal IP address which differs from your existing address scheme.
5. Next to Diffie-Hellman parameters, click the **Generate DH** button. This will create an encryption key to secure your OpenVPN connection.
6. Under Server Certificates, enter the required details. All fields must be completed. The **Country** field must consist of two characters only. When the details have been entered, click the **Generate CA certificate** button to generate the Certificate Authority (CA) certificate based on this information.
7. Under the **Server certificates** section, select the **Authentication type** that you would like to use for the OpenVPN Server.



Note: The Diffie-Hellman parameters can take up to 10 minutes to generate. Please be patient.

### Certificate Authentication

In the Certificate Management section, enter the required details to create a client certificate. All fields are required. When you have finished entering the details, click the **Generate** button.

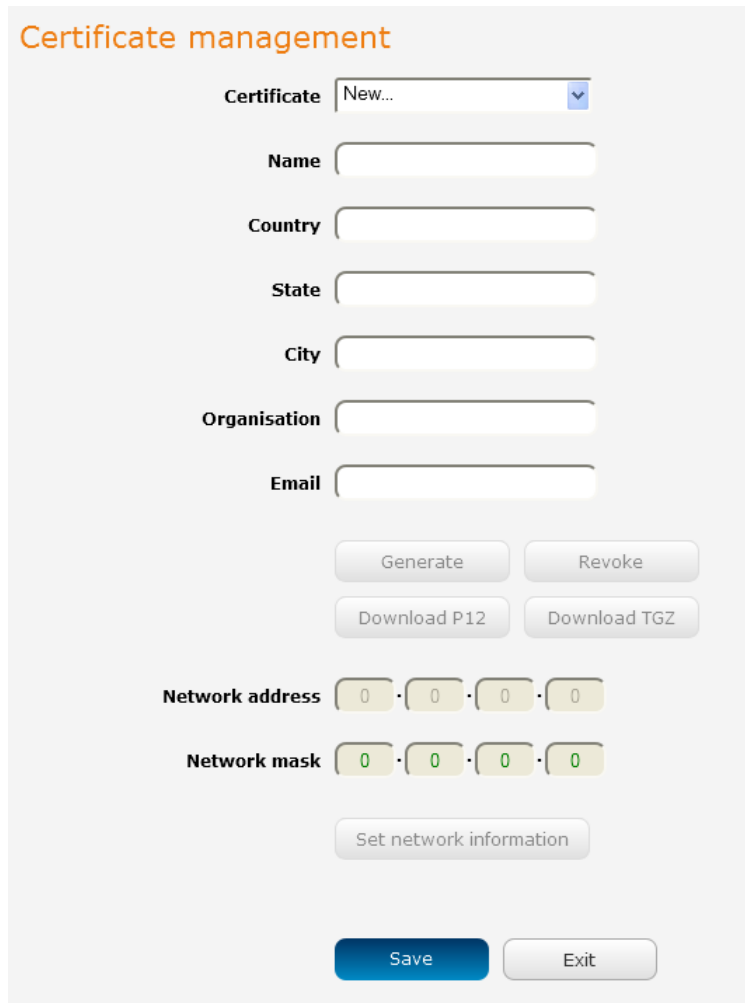

The screenshot shows a web interface titled "Certificate management" in orange text. It contains several input fields: "Certificate" (a dropdown menu with "New..." selected), "Name", "Country", "State", "City", "Organisation", and "Email". Below these fields are four buttons: "Generate", "Revoke", "Download P12", and "Download TGZ". Further down are two IP address input fields, "Network address" and "Network mask", each with four digit boxes containing "0". Below these is a "Set network information" button. At the bottom are two buttons: "Save" (highlighted in blue) and "Exit".

Figure 60 - OpenVPN server configuration - Certificate management

When it is done, you can click the **Download P12** button or the **Download TGZ** button to save the certificate file depending on which format you would like. If for some reason the integrity of your network has been compromised, you can return to this screen and use the Certificate drop down list to select the certificate and then press the **Revoke** button to disable it.

**Optional:** To inform the OpenVPN server of the network address scheme of the currently selected certificate, enter the network address and network subnet mask in the respective fields and click the **Set network information** button. If you do not enter the remote subnet here, any packet requests from the server to the client will not be received by the client network because it is not aware of the remote client's subnet.



### OpenVPN server edit

OpenVPN profile  ON  OFF

Profile name

Type

Server port

VPN network address  ·  ·  ·

VPN network subnet mask  ·  ·  ·

Diffie-Hellman parameters

### Server certificates

Not before N/A

Not after N/A

Country

State

City

Organisation

Email

Authentication type  Certificate  Username / Password

### Certificate management

Certificate

Name

Country

State

City

Organisation

Email

Network address  ·  ·  ·

Network mask  ·  ·  ·

Figure 61 – OpenVPN server profile settings

## Username / Password Authentication

In the Username/Password section, enter the username and password you would like to use for authentication on the OpenVPN Server. Click the **Download CA certificate** button to save the **ca.crt** file. This file will need to be provided to the client.



Note: If you wish to have more than one client connect to this OpenVPN server, you must use Certificate authentication mode as Username/Password only allows for a single client connection.

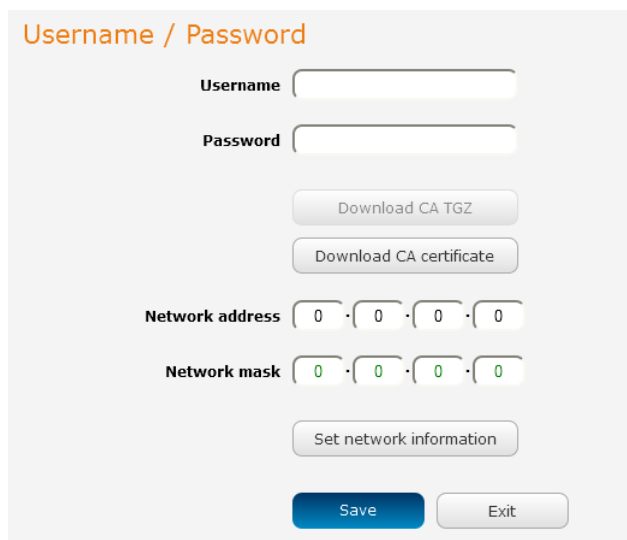

**Username / Password**

Username

Password

Download CA TGZ

Download CA certificate

Network address

Network mask

Set network information

Save Exit

Figure 62 - OpenVPN Server - Username / Password section

**Optional:** To inform the OpenVPN server of the network address scheme of the currently selected certificate, enter the network address and network subnet mask in the respective fields and click the **Set Network Information** button. If you do not enter the remote subnet here, any packet requests from the server to the client will not be received by the client network because it is not aware of the remote client's subnet.

When you have finished entering all the required information, click **Save** to finish configuring the OpenVPN server.

## Configuring an OpenVPN Client

1. Click the **OpenVPN profile** toggle key to switch it to the **ON** position.
2. In the **Profile name** field, type a name for the OpenVPN client profile you are creating.
3. In the **Server IP** address field, type the WAN IP address of the OpenVPN server.
4. Use the **Server port** field to select a port number and then use the drop down list to select a packet type to use for the OpenVPN server. The default OpenVPN port is 1194 and default packet type is UDP.
5. If the **Default gateway** option is applied on the OpenVPN client page, the OpenVPN server will enable connections to be made to other client networks connected to it. If it is not selected, the OpenVPN connection allows for secure communication links between this router and the remote OpenVPN server only.
6. Use the **Authentication type** options to select the Authentication type that you would like to use for the OpenVPN client.

### Certificate Authentication

In the Certificate upload section at the bottom of the screen, click the **Browse** button and locate the certificate file you downloaded when you configured the OpenVPN server. When it has been selected, click the **Upload** button to send it to the router.

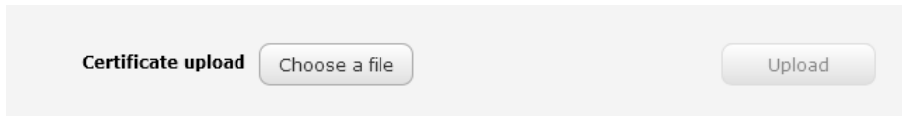

Figure 63 - OpenVPN client - Certificate upload

### Username / Password Authentication

Enter the username and password to authenticate with the OpenVPN server.

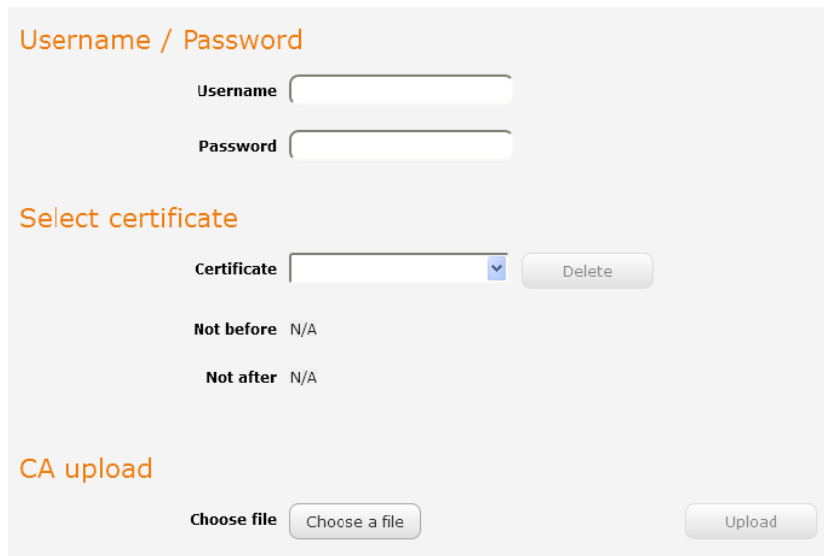

Figure 64 - OpenVPN Client - Username/Password section

Use the **Browse** button to locate the CA certificate file you saved from the OpenVPN Server and then press the **Upload** button to send it to the router.

Click the **Save** button to complete the OpenVPN Client configuration.

## Configuring an OpenVPN P2P Connection

To configure an OpenVPN peer-to-peer connection:

1. Set the **OpenVPN** profile toggle key to switch it to the **ON** position.
2. In the **Profile name** field, type a name for the OpenVPN P2P profile you are creating.
3. On the router designated as the master, leave the **Server IP address** field empty. On the router designated as the slave, enter the **WAN IP address** of the master.

### OpenVPN peer edit

OpenVPN profile  ON  OFF

Profile name

Server IP address  ·  ·  ·   
(leave empty if it's a peer-to-peer server)

Server port

Local IP address  ·  ·  ·

Remote IP address  ·  ·  ·

### Remote network

Address  ·  ·  ·

Subnet mask  ·  ·  ·

### Server secret key

Update time N/A

### Client secret key

Update time N/A

Client secret key upload

Figure 65 - OpenVPN P2P mode settings

4. Use the **Server port** field to select a port number and then use the drop down list to select a packet type to use for the OpenVPN server. The default OpenVPN port is 1194 and default packet type is UDP.
5. In the **Local IP Address** and **Remote IP Address** fields, enter the respective local and remote IP addresses to use for the OpenVPN tunnel. The slave should have the reverse settings of the master.
6. Under the Remote network section, enter the network **Address** and network **Subnet mask**. The Network Address and Network Mask fields inform the Master node of the LAN address scheme of the slave.
7. Press the **Generate** button to create a secret key to be shared with the slave. When the timestamp appears, you can click the **Download** button to save the file to exchange with the other router.
8. When you have saved the secret key file on each router, use the **Browse** button to locate the secret key file for the master and then press the **Upload** button to send it to the slave. Perform the same for the other router, uploading the slave's secret key file to master.
9. When they are uploaded click the **Save** button to complete the peer-to-peer OpenVPN configuration.

## PPTP-Client

The Point-to-Point Tunneling Protocol (PPTP) is a method for implementing virtual private networks using a TCP and GRE tunnel to encapsulate PPP packets. PPTP operates on Layer 2 of the OSI model and is included on Windows computers.

## Configuring the PPTP Client

To configure the PPTP client:

1. From the menu bar at the top of the screen, click **Networking** and then from the VPN section on the left side of the screen, click **PPTP client**. The PPTP client list is displayed.

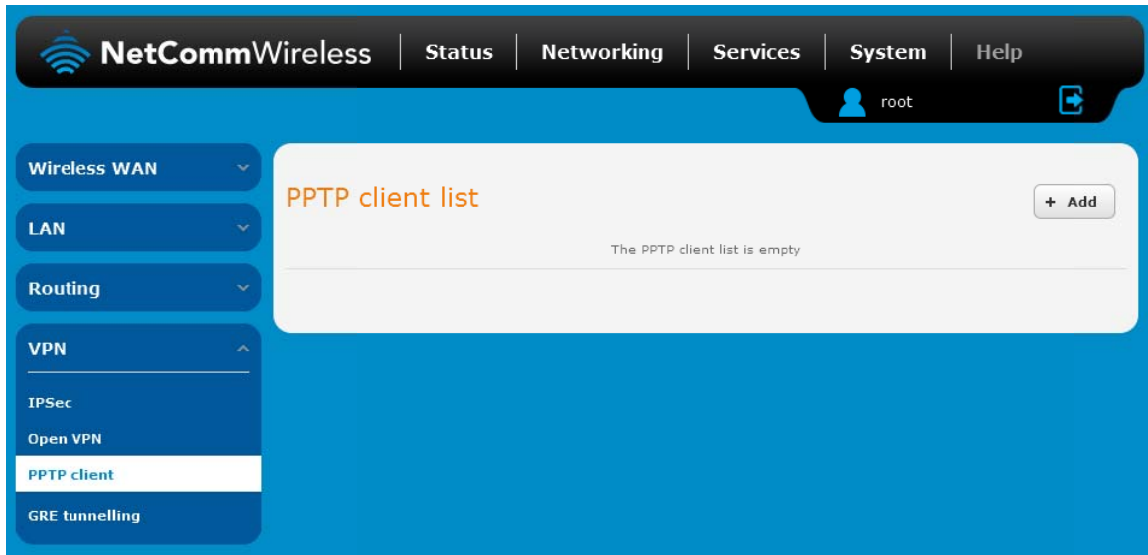

Figure 66 - PPTP client list

2. Click the **+Add** button to begin configuring a new PPTP client profile. The PPTP client edit screen is displayed.

### VPN PPTP client edit

**Enable PPTP client**  ON  OFF

**Profile name**

**Username**

**Password**

**PPTP server**

**Authentication type** any

**Metric**  (0-65535)

**Use peer DNS**  ON  OFF

**NAT masquerading**  ON  OFF

**Set PPTP server as default gateway**  ON  OFF

**MPPE**  ON  OFF





**Extra PPP option**

**Verbose logging**  ON  OFF

**Reconnect delay**  (30-65535) seconds

**Reconnect retries**  (0-65535, 0=Unlimited)

Figure 67 - VPN PPTP client edit

3. Click the **Enable PPTP client** toggle key to switch it to the **ON** position.
4. In the **Profile name** list, enter a profile name for the tunnel. This may be anything you like and is used to identify the tunnel on the router.
5. Use the **Username** and **Password** fields to enter the username and password for the PPTP account.
6. In the **PPTP server address** field, enter the IP address of the PPTP server.
7. From the **Authentication type** drop down list, select the Authentication type used on the server. If you do not know the authentication method used, select **any** and the router will attempt to determine the correct authentication type for you. There are 5 authentication types you can choose from:
  -  **CHAP** – uses a three way handshake to authenticate the identity of a client.
  -  **MS-CHAP v1** – This is the Microsoft implementation of the Challenge Handshake Authentication Protocol for which support was dropped in Windows® Vista.
  -  **MS-CHAP v2** - This is the Microsoft implementation of the Challenge Handshake Authentication Protocol which was introduced in Windows® NT 4.0 and is still supported today.
  -  **PAP** – The Password Authentication Protocol uses a password as a means of authentication and as such, is commonly supported. PAP is not recommended because it transmits passwords unencrypted and is not secure.
  -  **EAP** – Extensible Authentication Protocol. An Authentication protocol commonly used in wireless networks.
8. The **metric** value helps the router to prioritise routes and must be a number between 0 and 65535. The default value is 30 and should not be modified unless you are aware of the effect your changes will have.
9. The **Use peer DNS** option allows you to select whether the remote clients will use the Domain Name Server of the PPTP server. Click the toggle key to set this to ON or OFF as required.
10. **NAT masquerading** allows the router to modify the packets sent and received to inform remote computers on the internet that packets originating from a machine behind the router actually originated from the WAN IP address of the router's internal NAT IP address. Click the toggle key to switch this to the ON position if you want to use this feature.
11. Set **default route to PPTP** sets all outbound data packets to go out through the PPTP tunnel. Click the toggle key to switch this to the ON position if you want to use this feature.
12. The **Verbose logging** option sets the router to output detailed logs regarding the PPTP connection in the **System Log** section of the router interface.
13. The **Reconnect delay** is the time in seconds that the router will wait before attempting to connect to the PPTP server in the event that the connection is broken. The minimum time to wait is 30 seconds so as to not flood the PPTP server with connection requests, while the maximum time to wait is 65335 seconds.
14. The **Reconnect retries** is the number of connection attempts that the router will make in the event that the PPTP connection goes down. If set to 0, the router will retry the connection indefinitely, otherwise the maximum number of times to retry cannot be greater than 65335.
15. Click the **Save** button to save the changes. The VPN will attempt to connect after your click Save. Click the **Status** button at the top left of the interface to return to the status window and monitor the VPN's connection state.

## GRE tunnelling

The Generic Route Encapsulation (GRE) protocol is used in addition to Point-to-Point Tunnelling Protocol (PPTP) to create VPNs (virtual private networks) between clients and servers or between clients only. Once a PPTP control session establishes the VPN tunnel GRE is used to securely encapsulate the data or payload.

## Configuring GRE tunnelling

To configure GRE tunnelling:

1. From the menu bar at the top of the screen, click **Networking** and then from the VPN section on the left side of the screen, click **GRE**. The GRE client list is displayed.

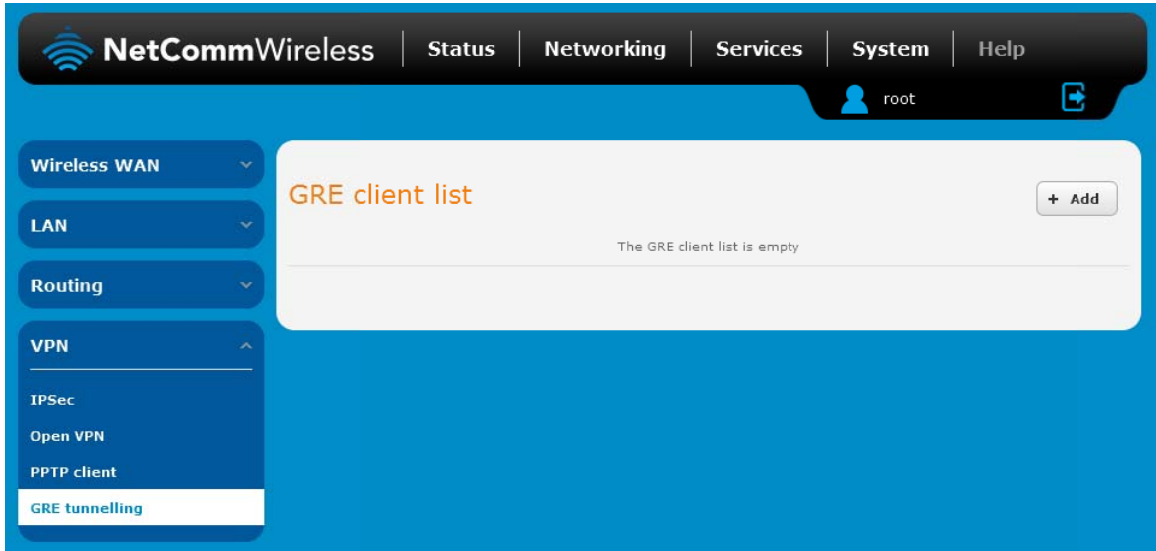

Figure 68 - GRE client list

2. Click the **+Add** button to begin configuring a new GRE tunnelling client profile. The GRE Client Edit screen is displayed.

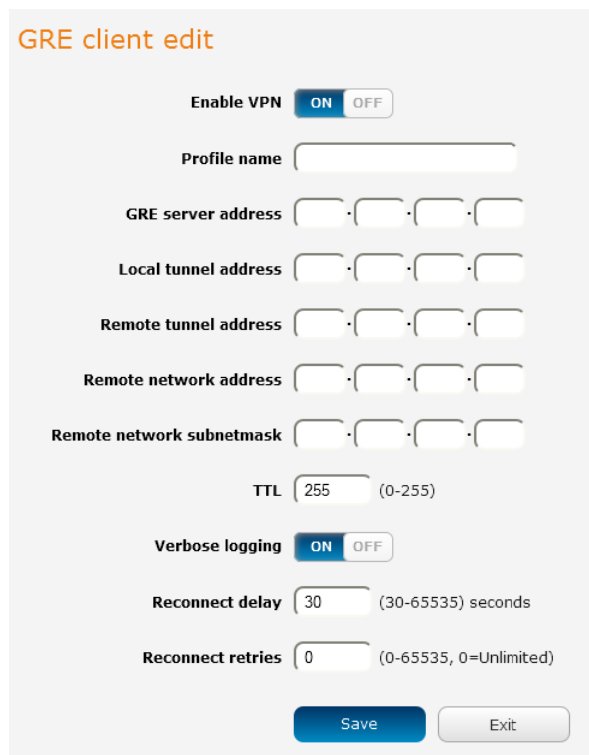

Figure 69 - GRE client edit

3. Click the **Enable GRE Tunnel** toggle key to switch it to the **ON** position.

4. In the **Profile name**, enter a profile name for the tunnel. This may be anything you like and is used to identify the tunnel on the router.
5. In the **GRE server address** field, enter the IP address of the GRE server.
6. In the **Local tunnel address** field, enter the IP address you want to assign the tunnel locally.
7. In the **Remote tunnel address** field, enter the IP address you want to assign to the remote tunnel.
8. In the **Remote network address** field, enter the IP address scheme of the remote network.
9. In the **Remote network subnetmask** field, enter the subnet mask of the remote network.
10. The **TTL (Time To Live)** field is an 8-bit field used to remove an undeliverable data packet from a network to avoid unnecessary network traffic across the internet. The default value of 255 is the upper limit on the time that an IP datagram can exist. The value is reduced by at least one for each hop the data packet takes to the next router on the route to the datagram's destination. If the TTL field reaches zero before the datagram arrives at its destination the data packet is discarded and an error message is sent back to the sender.
11. The **Verbose logging** option sets the router to output detailed logs regarding the GRE tunnel in the **System Log** section of the router interface.
12. The **Reconnect delay** is the time in seconds that the router will wait before attempting to connect to the GRE server in the event that the connection is broken. The minimum time to wait is 30 seconds so as to not flood the GRE server with connection requests, while the maximum time to wait is 65335 seconds.
13. The **Reconnect retries** is the number of connection attempts that the router will make in the event that the GRE connection goes down. If set to 0, the router will retry the connection indefinitely, otherwise the maximum number of times to retry cannot be greater than 65335.
14. Click the **Save** button to save the changes. The VPN will attempt to connect after your click Save. Click the **Status** button at the top left of the interface to return to the status window and monitor the VPN's connection state.



# Services

## Dynamic DNS

The DDNS page is used to configure the Dynamic DNS feature of the router. A number of Dynamic DNS hosts are available from which to select.



Figure 70 – Dynamic DNS settings

Dynamic DNS provides a method for the router to update an external name server with the current WAN IP address.

To configure dynamic DNS:

1. Click the **DDNS configuration** toggle key to switch it to the ON position.
2. From the **Dynamic DNS** drop down list, select the Dynamic DNS service that you wish to use. The available DDNS services available are:
  - [www.dhs.org](http://www.dhs.org)
  - [www.dyndns.org](http://www.dyndns.org)
  - [www.dyns.cx](http://www.dyns.cx)
  - [www.easydns.com](http://www.easydns.com)
  - [www.justlinux.com](http://www.justlinux.com)
  - [www.ods.org](http://www.ods.org)
  - [www.tzo.com](http://www.tzo.com)
  - [www.zoneedit.com](http://www.zoneedit.com)
3. In the **Username** and **Password** fields, enter the logon credentials for your DDNS account. Enter the password for the account again in the **Verify password** field.
4. Click the **Save** button to save the DDNS configuration settings.

## Network time (NTP)

The NTP (Network Time Protocol) settings page allows you to configure the 3G Light Industrial M2M router to synchronize its internal clock with a global Internet Time server and specify the time zone for the location of the router. This provides an accurate timekeeping function for features such as System Log entries and Firewall settings where the current system time is displayed and recorded.

Any NTP server available publicly on the internet may be used. The default NTP server is 0.netcomm.pool.ntp.org.

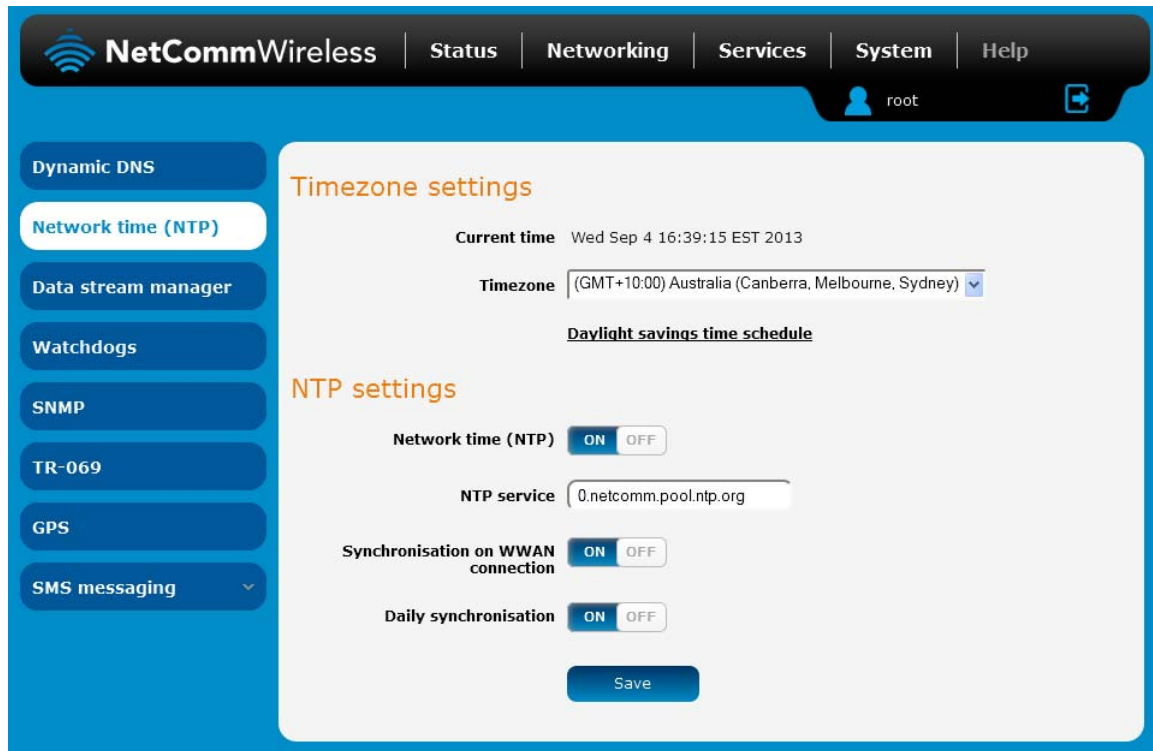

Figure 71 - NTP settings

### Configuring Timezone settings

To configure time zone settings:

1. The **Current time** field shows the time and date configured on the router. If this is not accurate, use the **Time zone** drop down list to select the correct time zone for the router. If the selected zone observes daylight savings time, a [Daylight savings time schedule](#) link appears below the drop down list. Click the link to see the start and end times for daylight savings.
2. When you have selected the correct time zone, click the **Save** button to save the settings.

### Configuring NTP settings

To configure NTP settings:

1. Click the **Network time (NTP)** toggle key to switch it to the **ON** position.
2. In the **NTP service** field, enter the address of the NTP server you wish to use.
3. The **Synchronization on WWAN connection** toggle key enables or disables the router from performing a synchronization of the time each time a mobile broadband connection is established.
4. The **Daily synchronisation** toggle key enables or disables the router from performing a synchronization of the time each day.
5. When you have finished configuring NTP settings, click the **Save** button to save the settings.

## Data stream manager

The data stream manager provides you with the ability to create mappings between input ports and output ports (e.g. Serial Port, SMS, GPS, USB) and performs any required translation or data processing by each virtual data tunnel. Customers interested in developing their own applications to create custom mappings can contact NetComm Wireless about our Software Development Kit.

The data stream manager provides a wide range of possibilities and expands upon simple PAD functionality to include the forwarding and translation of data between any of the inputs and outputs of the router. Certain accessories connected via the USB port such as USB to Serial cables are also supported. For example, you could send the GPS data received by the module (in NMEA format) through the built-in serial port or out of the USB port using a USB to Serial cable.

The following is an example of how to configure the router to send GPS data through the serial port:

1. Click the **+Add** button on the right side of the page.

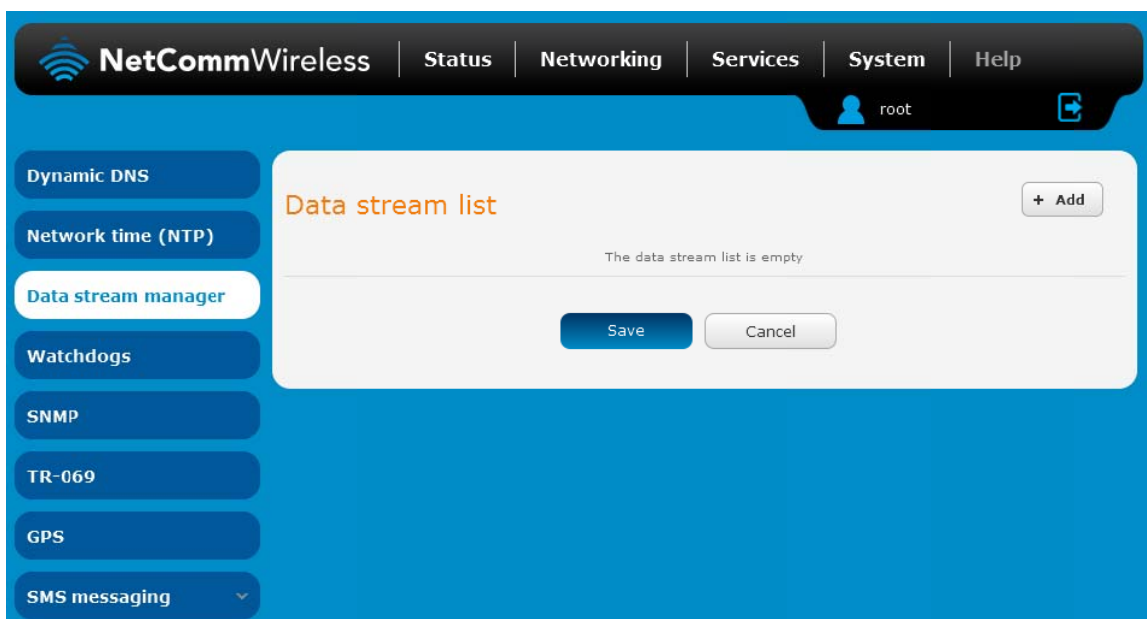

Figure 72 - Data stream list

2. Click the **Activate** toggle key so that it is in the **ON** position.



Figure 73 - Activate button

3. In the **Data stream name** field, enter a name to identify the mapping on the Data stream list.
4. Under the **Endpoint A** section, use the **Type** drop down list to select **GPS**.
5. Under the **Endpoint B** section, use the **Type** drop down list to select **Serial**. Under the **Serial port settings** section, use the drop down lists to select the appropriate parameters for the serial port output. The screenshot below shows an example of typical settings for this scenario.

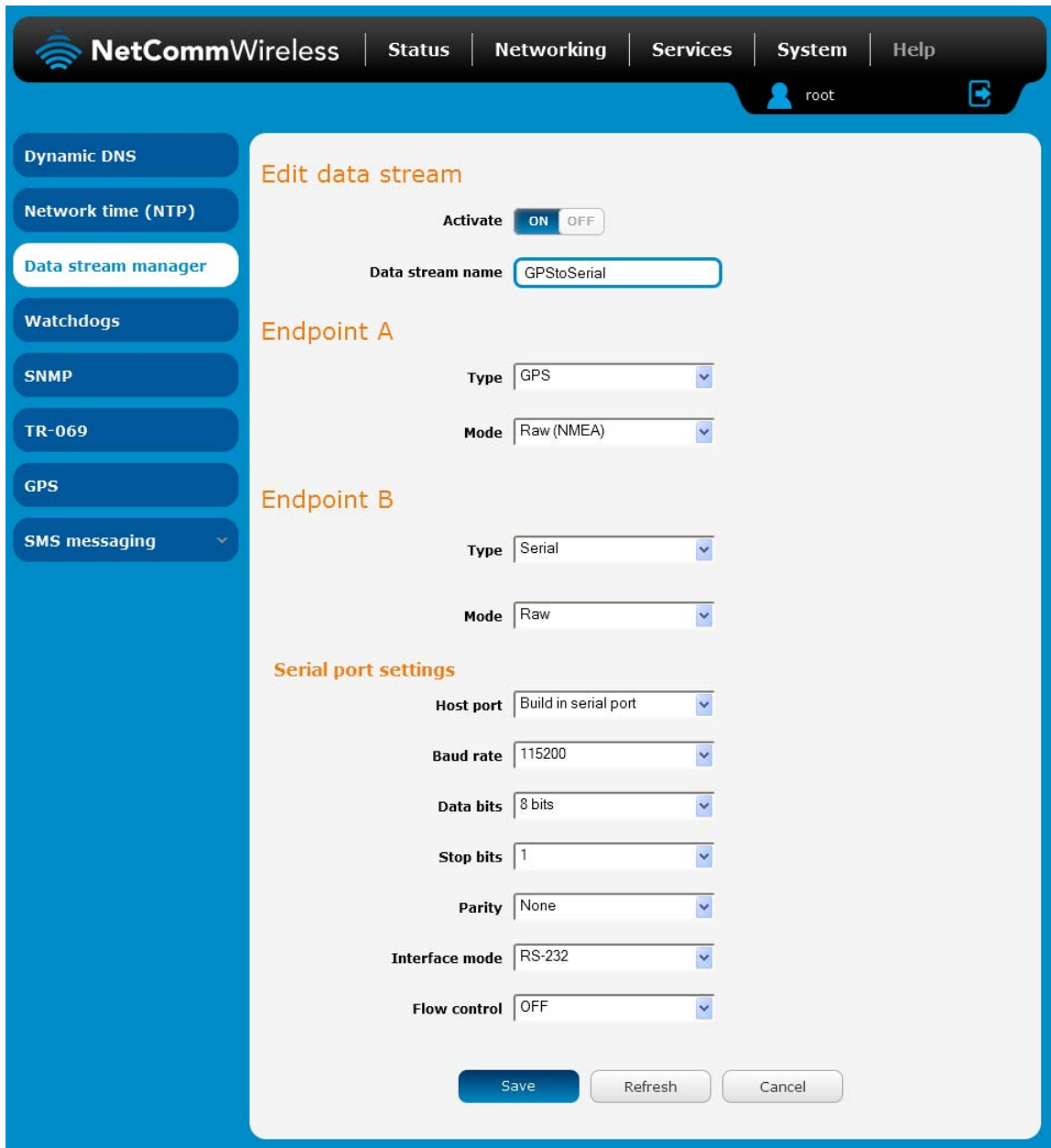

**NetCommWireless** | Status | Networking | Services | System | Help

root

**Edit data stream**

Activate  ON  OFF

Data stream name:

**Endpoint A**

Type:

Mode:

**Endpoint B**

Type:

Mode:

**Serial port settings**

Host port:

Baud rate:

Data bits:

Stop bits:

Parity:

Interface mode:

Flow control:

Figure 74 - Data stream manager - GPS to Serial port example

- Click the **Save** button to confirm your settings. The new data stream appears in the Data stream list.

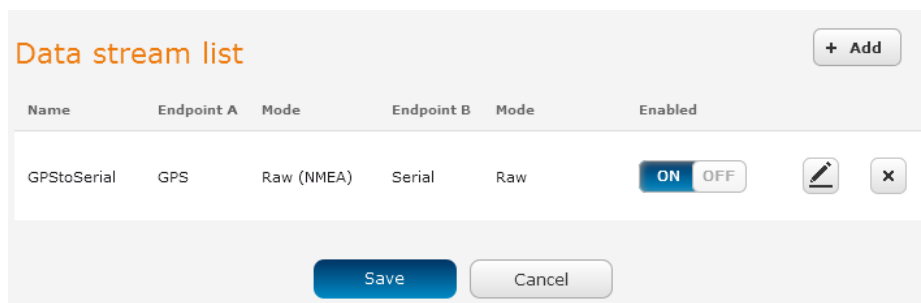

**Data stream list** + Add

Name	Endpoint A	Mode	Endpoint B	Mode	Enabled
GPStoSerial	GPS	Raw (NMEA)	Serial	Raw	<input checked="" type="checkbox"/> ON <input type="checkbox"/> OFF

Table 16 - Data stream list entry

# Watchdogs

To access the Watchdogs page, click the **Services** menu item, then select the **Watchdogs** menu item on the left.

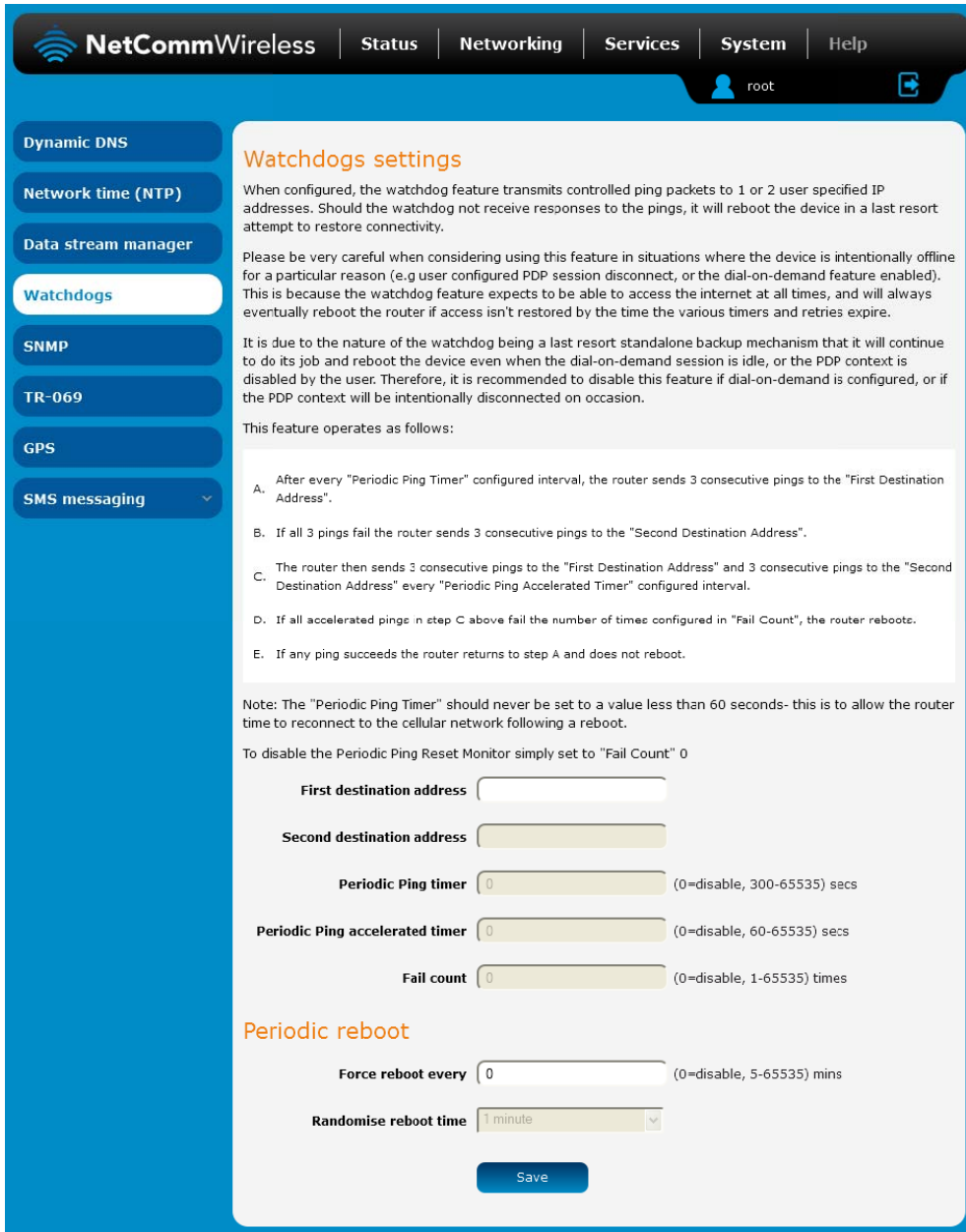

**Watchdogs settings**

When configured, the watchdog feature transmits controlled ping packets to 1 or 2 user specified IP addresses. Should the watchdog not receive responses to the pings, it will reboot the device in a last resort attempt to restore connectivity.

Please be very careful when considering using this feature in situations where the device is intentionally offline for a particular reason (e.g user configured PDP session disconnect, or the dial-on-demand feature enabled). This is because the watchdog feature expects to be able to access the internet at all times, and will always eventually reboot the router if access isn't restored by the time the various timers and retries expire.

It is due to the nature of the watchdog being a last resort standalone backup mechanism that it will continue to do its job and reboot the device even when the dial-on-demand session is idle, or the PDP context is disabled by the user. Therefore, it is recommended to disable this feature if dial-on-demand is configured, or if the PDP context will be intentionally disconnected on occasion.

This feature operates as follows:

- After every "Periodic Ping Timer" configured interval, the router sends 3 consecutive pings to the "First Destination Address".
- If all 3 pings fail the router sends 3 consecutive pings to the "Second Destination Address".
- The router then sends 3 consecutive pings to the "First Destination Address" and 3 consecutive pings to the "Second Destination Address" every "Periodic Ping Accelerated Timer" configured interval.
- If all accelerated pings in step C above fail the number of times configured in "Fail Count", the router reboots.
- If any ping succeeds the router returns to step A and does not reboot.

Note: The "Periodic Ping Timer" should never be set to a value less than 60 seconds- this is to allow the router time to reconnect to the cellular network following a reboot.

To disable the Periodic Ping Reset Monitor simply set to "Fail Count" 0

**First destination address**

**Second destination address**

**Periodic Ping timer**  (0=disable, 300-65535) secs

**Periodic Ping accelerated timer**  (0=disable, 60-65535) secs

**Fail count**  (0=disable, 1-65535) times

**Periodic reboot**

**Force reboot every**  (0=disable, 5-65535) mins

**Randomise reboot time**

**Save**

Figure 75 - Watchdogs Settings

Watchdogs are features which monitor the router for anomalies and restart the router if an anomaly occurs preventing its normal operation. When configured, the watchdogs feature transmits controlled ping packets to 1 or 2 user specified IP addresses to confirm an active connection. If the watchdog does not receive responses to the pings after a specified number of failures, it will reboot the device in a last resort attempt to restore connectivity.

We recommend using caution when implementing this feature in situations where the device is intentionally offline for a particular reason, for example, when Dial-on-demand has been enabled. This is because the watchdog expects to be able to access the internet at all times, and will always eventually reboot the router if access isn't restored by the time the various timers expire and the fail count is reached.

It is due to the nature of the watchdog being a last resort standalone backup mechanism that it will continue to do its job and reboot the device even when the Dial-on-demand session is idle, or the mobile broadband connection is disabled by the user. Therefore, we recommended that you disable this feature if Dial-on-demand is configured or if the mobile broadband connection will be intentionally disconnected on occasion.

The watchdog works as follows:

- a) The router sends 3 consecutive pings to the first destination address at the interval specified in the **Periodic Ping timer** field.
- b) If all 3 pings to the first destination address fail, the router sends 3 consecutive pings to the second destination address at the **Periodic Ping timer** interval.
- c) If all 3 pings to the second destination address fail, the router sends 3 pings to the first destination address using the **Periodic Ping accelerated timer** interval.
- d) If all 3 accelerated pings to the first destination address fail, the router sends 3 pings to the second destination address at the **Periodic Ping accelerated timer** interval.
- e) If all 3 accelerated pings to the second destination address fail, the router registers this as a fail and returns to step C.
- f) When the number of failures reaches the number configured in the **Fail count** field, the router reboots. If any ping succeeds, the router returns to step A and does not reboot.



Note: The Periodic Ping timer should not be set to a value of less than 210 seconds to allow the router time to reconnect to the cellular network following a reboot.

To disable the periodic ping reset monitor, set **Fail count** to 0.

**First destination address**

**Second destination address**

**Periodic Ping timer**  (0=disable, 300-65535) secs

**Periodic Ping accelerated timer**  (0=disable, 60-65535) secs

**Fail count**  (0=disable, 1-65535) times

**Periodic reboot**

**Force reboot every**  (0=disable, 5-65535) mins

**Randomise reboot time**

Figure 76 – Ping watchdog settings

## Configuring Periodic Ping settings

The Periodic Ping settings configure the router to transmit controlled ping packets to 2 specified IP addresses. If the router does not receive responses to the pings, the router will reboot.

To configure the ping watchdog:

1. In the **First destination address** field, enter a website address or IP address to which the router should send the first round of ping requests.
2. In the **Second destination address** field, enter a website address or IP address to which the router should send the second round of ping requests.
3. In the **Periodic Ping timer** field, enter an integer between 300 and 65535 for the number of seconds the router should wait between ping attempts. Setting this to 0 disables the ping watchdog function.
4. In the **Periodic Ping accelerated timer** field, enter an integer between 60 and 65535 for the number of seconds the router should wait between accelerated ping attempts, i.e. pings to the second destination address. Setting this to 0 disables the ping watchdog function.
5. In the **Fail count** field, enter an integer between 1 and 65535 for the number of times an accelerated ping should fail before the router reboots. Setting this to 0 disables the ping watchdog function.

## Disabling the Periodic Ping reset function

To disable the Periodic Ping reset function, set **Fail count** to 0.



Note: The traffic generated by the periodic ping feature is usually counted as chargeable data usage. Please keep this in mind when selecting how often to ping.

## Configuring a Periodic reboot

The router can be configured to automatically reboot after a period of time specified in minutes. While this is not necessary, it does ensure that in the case of remote installations, the router will reboot if some anomaly occurs.

1. In the **Force reboot every** field, enter the time in minutes between forced reboots. The default value is 0 which disables the Periodic reboot function. The minimum period between reboots is 5 minutes while the maximum value is 65535 minutes.
2. If you have configured a forced reboot time, you can use the **Randomise reboot time** drop down list to select a random reboot timer. Randomising the reboot time is useful for preventing a large number of devices from rebooting simultaneously and flooding the network with connection attempts. The router will wait for the configured **Force reboot every** time and then randomly reboot within the configured **Randomise reboot time**.
3. Click the **Save** button to save the settings.

# SNMP

## SNMP configuration

The SNMP page is used to configure the SNMP features of the router.



Figure 77 - SNMP configuration

SNMP (Simple Network Management Protocol) is used to remotely monitor the router for conditions that may warrant administrative attention. It can be used to retrieve information from the router such as the signal strength, the system time and the interface status.

To configure SNMP:

1. Click the **SNMP** toggle key to switch it to the **ON** position.
2. Enter **Read-only community name** and **Read-write community name** which are used for client authentication.



Community names are used as a type of security to prevent access to reading and/or writing to the routers configuration. It is recommended that you change the Community names to something other than the default settings when using this feature.

3. Click the **Save** button to save any changes to the settings.

The **Download** button displays the Management information base (MIB) of the router. The MIB displays all the objects of the router that can have their values set or report their status. The MIB is formatted in the SNMP-related standard RFC1155.



## SNMP traps

SNMP traps are messages from the router to the Network Management System sent as UDP packets. They are often used to notify the management system of any significant events such as whether the link is up or down.

## Configuring SNMP traps

To configure SNMP traps:

1. In the **Trap destination** field, enter the IP address to which SNMP data is to be sent.
2. In the **Heartbeat interval** field, enter the number of seconds between SNMP heartbeats.
3. Use the **Trap persistence** field to specify the time in seconds that an SNMP trap persists.
4. Use the **Trap retransmission** time to specify the length of time in seconds between SNMP trap retransmissions.

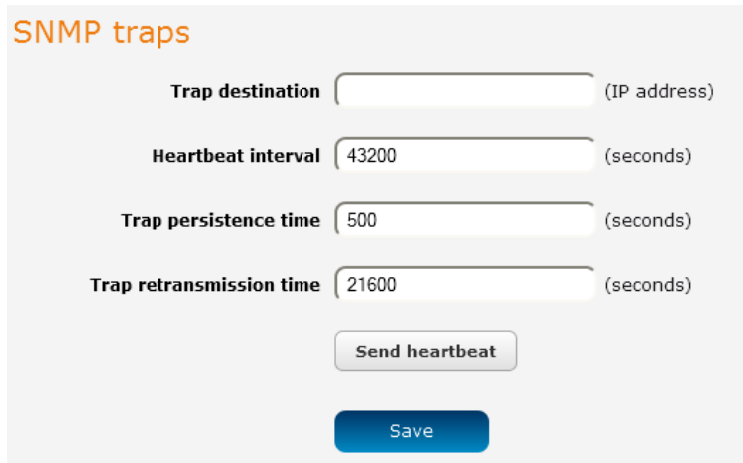

The image shows a configuration panel titled "SNMP traps" with four input fields and two buttons. The fields are: "Trap destination" (empty), "Heartbeat interval" (43200), "Trap persistence time" (500), and "Trap retransmission time" (21600). Each field has a unit label in parentheses: "(IP address)", "(seconds)", "(seconds)", and "(seconds)". Below the fields are two buttons: "Send heartbeat" and "Save".

*Figure 78 - SNMP traps*

To send a manual SNMP Heartbeat, click the **Send heartbeat** button. When you have finished configuring the SNMP traps, click the **Save** button to save the settings.

## TR-069





To access the TR-069 configuration page, click the **Services** menu item, then select the TR-069 menu item on the left.



Figure 79 - TR-069 configuration

The TR-069 (Technical Report 069) protocol is a technical specification also known as CPE WAN Management Protocol (CWMP). It is a framework for remote management and auto-configuration of end-user devices such as customer-premises equipment (CPE) and Auto Configuration Servers (ACS). It is particularly efficient in applying configuration updates across networks to multiple CPEs.

TR-069 uses a bi-directional SOAP/HTTP-based protocol based on the application layer protocol and provides several benefits for the maintenance of a field of CPEs:

-  Simplifies the initial configuration of a device during installation
-  Enables easy restoration of service after a factory reset or replacement of a faulty device
-  Firmware and software version management
-  Diagnostics and monitoring



Note: You must have your own compatible ACS infrastructure to use TR-069. In order to access and configure the TR-069 settings you must be logged into the router as the root user.

## TR-069 configuration

To configure TR-069:

1. Click the **Enable TR-069** toggle key to switch it to the **ON** position.
2. In the **ACS URL** field, enter the Auto Configuration Server's full domain name or IP address.
3. Use the **ACS username** field to specify the username for the Auto Configuration Server.
4. In the **ACS password** and **Verify ACS password** fields, enter the Auto Configuration Server password.
5. In the **Connection Request Username** field, enter the username to use for the connection requests.
6. In the **Connection Request Password** and **Verify password** fields, enter the connection request password.
7. The inform message acts as a beacon to inform the ACS of the existence of the router. Click the **Enable periodic ACS informs** toggle key to turn on the periodic ACS inform messages.
8. In the **Inform Period** field, enter the number of seconds between the inform messages.
9. Click the **Save** button to save the settings.

# GPS

The built-in GPS module allows you to use location-based services, monitor field deployed hardware or find your current location. The GPS Status window provides up to date information about the current location and the current GPS signal conditions (position dilution of precision (PDOP), horizontal dilution of precision (HDOP) and vertical dilution of precision (VDOP)) of the router.

To use the GPS function, set the GPS operation toggle key to ON and click the Save button.

### GPS Configuration

GPS operation  ON  OFF

### GPS applications

### Mobile Station Based Assisted GPS configuration

A-GPS Enable  ON  OFF

### GPS status

**Positioning data source** Previously Stored GPS Data (N/A)

**Date & Time** N/A

**Latitude & Longitude** N/A , N/A

**Altitude** N/A m

**Ground speed** N/A km/h , N/A knots

**PDOP & HDOP & VDOP** N/A , N/A , N/A

**Standalone GPS device status** Invalid

**Mobile assisted GPS device status** Invalid

**Number of satellites** N/A

### Odometer

**Odometer reading** NaN Meter

**Odometer start time**

**Odometer**  ON  OFF

**Ignition control**  ▼

**Threshold**  (0 -100) meters

### Satellites status

Index	In Use	PRN	SNR	Elevation	Azimuth
1	✘	N/A		N/A	N/A
2	✘	N/A		N/A	N/A
3	✘	N/A		N/A	N/A
4	✘	N/A		N/A	N/A
5	✘	N/A		N/A	N/A
6	✘	N/A		N/A	N/A
7	✘	N/A		N/A	N/A
8	✘	N/A		N/A	N/A
9	✘	N/A		N/A	N/A
10	✘	N/A		N/A	N/A
11	✘	N/A		N/A	N/A
12	✘	N/A		N/A	N/A

The **Google map** button provides a quick short cut to show your router's current position on a map and because GPS positioning relies on accurate clock settings to obtain the correct information about your location, the **Clock Sync** button allows you to quickly set the router clock to the correct time. This ensures you will always have the correct GPS position information available.

## Mobile Station Based Assisted GPS configuration

If you are not using a dedicated GPS antenna, you may use the nearby mobile base stations to triangulate your position. To do this, set the **A-GPS** toggle key to the **ON** position and use the drop down lists to configure the automatic retry options.

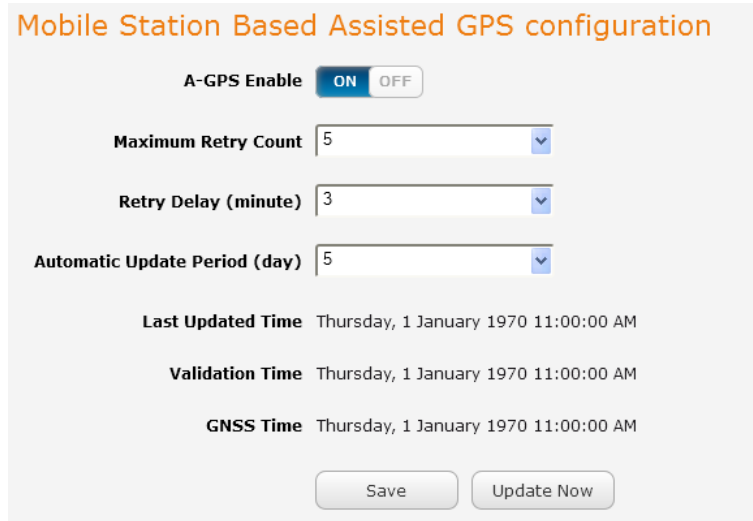

**Mobile Station Based Assisted GPS configuration**

**A-GPS Enable**  ON  OFF

**Maximum Retry Count** 5

**Retry Delay (minute)** 3

**Automatic Update Period (day)** 5

**Last Updated Time** Thursday, 1 January 1970 11:00:00 AM

**Validation Time** Thursday, 1 January 1970 11:00:00 AM

**GNSS Time** Thursday, 1 January 1970 11:00:00 AM

Save Update Now

Figure 80 - Mobile Stations Based Assisted GPS configuration options

ITEM	DESCRIPTION
A-GPS Enable	Enables or disables the mobile station based assisted GPS function.
Maximum Retry Count	Sets the maximum number of times the router should attempt to triangulate its position.
Retry delay (minute)	Sets the number of minutes the router should wait between attempts to triangulate its position.
Automatic Update Period (day)	Sets the number of days that the router should automatically update the A-GPS data. The maximum update period is 7 days.

Table 17 - Mobile Station Based Assisted GPS configuration options

## Odometer

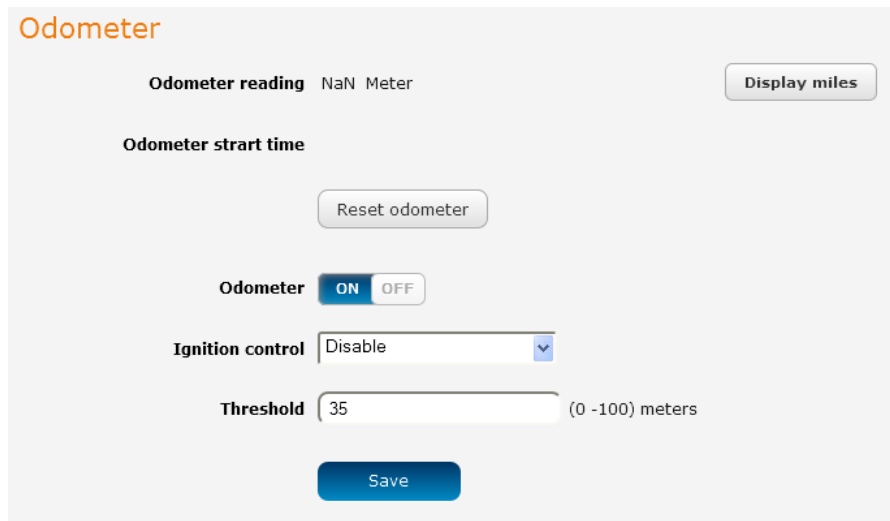

**Odometer**

**Odometer reading** NaN Meter Display miles

**Odometer start time**

Reset odometer

**Odometer**  ON  OFF

**Ignition control** Disable

**Threshold** 35 (0 -100) meters









Save



## SMS messaging

The 3G Light Industrial M2M router offers an advanced SMS feature set, including sending messages, receiving messages, redirecting incoming messages to another destination, as well as supporting remote commands and diagnostics messages.

Some of the functions supported include:

-  Ability to send a text message via a CDMA network and store it in permanent storage.
-  Ability to receive a text message via a CDMA network and store it in permanent storage.
-  Ability to forward incoming text messages via a CDMA network to another remote destination which may be a TCP/UDP server or other mobile devices.
-  Ability to receive run-time variables from the device (e.g. uptime) on request via SMS
-  Ability to change live configuration on the device (e.g. network username) via SMS.
-  Ability to execute supported commands (e.g. reboot) via SMS
-  Ability to trigger the 3G Light Industrial M2M router to download and install a firmware upgrade
-  Ability to trigger the 3G Light Industrial M2M router to download and apply a configuration file

To access the SMS messaging functions of the 3G Light Industrial M2M router, click on the **Services** menu item from the top menu bar, and then select one of the options under the **SMS messaging** section on the left hand menu.

## Setup

The Setup page provides the options to enable or disable the SMS messaging functionality and SMS forwarding functionalities of the router. SMS messaging is enabled by default.

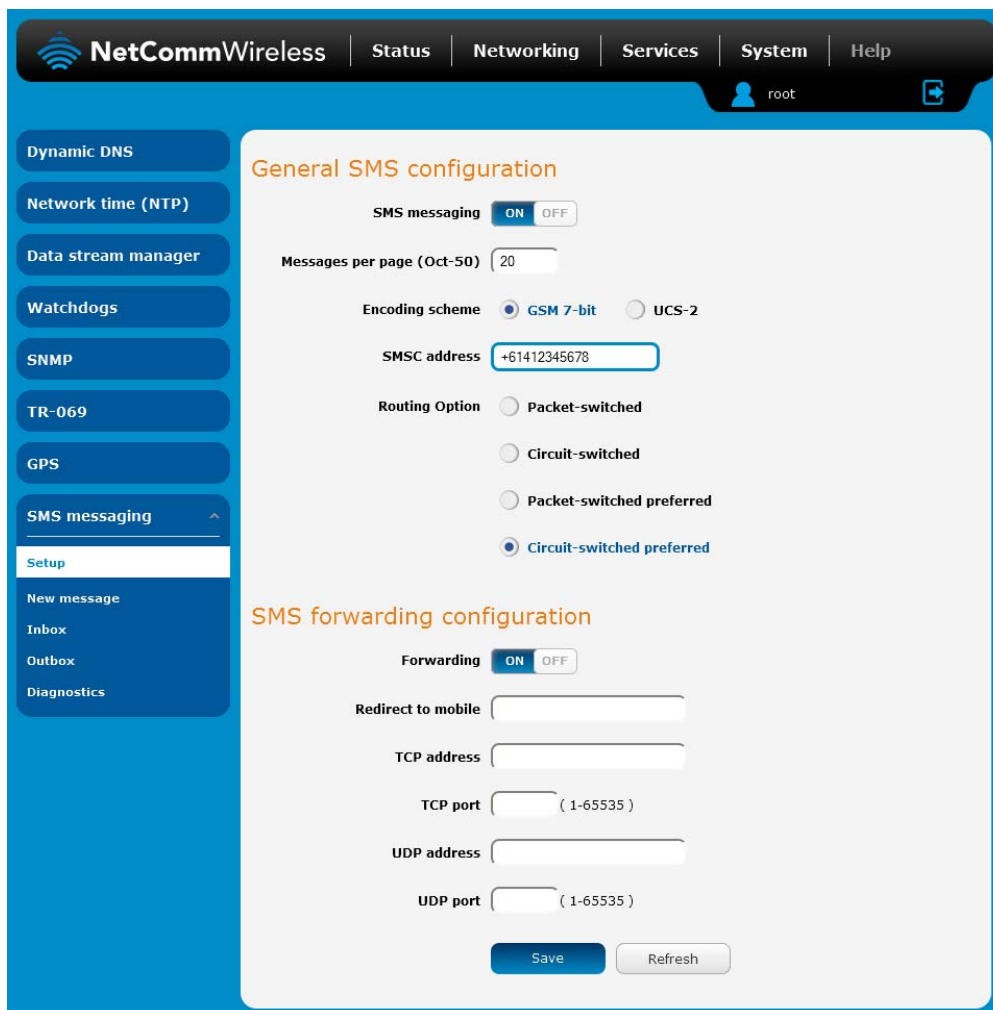

**NetCommWireless** | Status | Networking | Services | System | Help

root

**Dynamic DNS**

**Network time (NTP)**

**Data stream manager**

**Watchdogs**

**SNMP**

**TR-069**

**GPS**

**SMS messaging**

Setup

New message

Inbox

Outbox

Diagnostics

### General SMS configuration

SMS messaging  ON  OFF

Messages per page (Oct-50)

Encoding scheme  GSM 7-bit  UCS-2

SMSC address

Routing Option  Packet-switched

Circuit-switched

Packet-switched preferred

Circuit-switched preferred

### SMS forwarding configuration

Forwarding  ON  OFF

Redirect to mobile

TCP address

TCP port  ( 1-65535 )

UDP address

UDP port  ( 1-65535 )

Figure 81 - General SMS Configuration

OPTION	DEFINITION
<b>General SMS configuration</b>	
SMS messaging	Toggles the SMS functionality of the router on and off.
Messages per page (10-50)	The number of SMS messages to display per page. Must be a value between 10 and 50.
Encoding scheme	The encoding method used for outbound SMS messages. GSM 7-bit mode permits up to 160 characters per message but drops to 50 characters if the message includes special characters. UCS-2 mode allows the sending of Unicode characters and permits a message to be up to 50 characters in length.
<b>SMS forwarding configuration</b>	
Forwarding	Toggles the SMS forwarding function of the router on and off.
Redirect to mobile	Enter a mobile number as the destination for forwarded SMS messages.
TCP address	Enter an IP address or domain name as the destination for forwarded SMS messages using TCP.
TCP port	The TCP port on which to connect to the remote destination.
UDP address	Enter an IP address or domain name as the destination for forwarded SMS messages using UDP.
UDP port	The UDP port on which to connect to the remote destination.

*Table 18 - SMS Setup Settings*

## SMS forwarding configuration

Incoming text messages can be redirected to another mobile device and/or a TCP/UDP message server.

### Redirect to mobile

You can forward incoming text messages to a different destination number. This destination number can be another mobile phone or a 3G router phone number.

For Example:

If someone sends a text message and **Redirect to mobile** is set to "+61412345678", the text message is stored on the router and forwarded to "+61412345678" at the same time.

To disable redirection to a mobile, clear the **Redirect to mobile** field and click the **Save** button.

### Redirect to TCP / UDP address

You can also forward incoming text messages to a TCP/UDP based destination. The TCP or UDP server can be any kind of public or private server if the server accepts incoming text-based messages.

The TCP/UDP address can be an IP address or domain name. The port number range is from 1 to 65535. Please refer to your TCP/UDP based SMS server configuration for which port to use.

For Example:

If someone sends a text message and **TCP address** is set to "192.168.20.3" and **TCP port** is set to "2002", this text message is stored in the router and forwarded to "192.168.20.3" on port "2002" at the same time.

To disable redirection to a TCP or UDP address, clear the **TCP address** and **UDP address** fields and click the **Save** button.

## New message

The New message page can be used to send SMS text messages to a single or multiple recipients.

A new SMS message can be sent to a maximum of 100 recipients at the same time. After sending the message, the result is displayed next to the destination number as "Success" or "Failure" if the message failed to send. By default, only one destination number field is displayed. Additional destination numbers may be added one at a time after entering a valid number for the current destination number field. To add a destination number, click the  button and to remove the last destination in the list, click the  button.

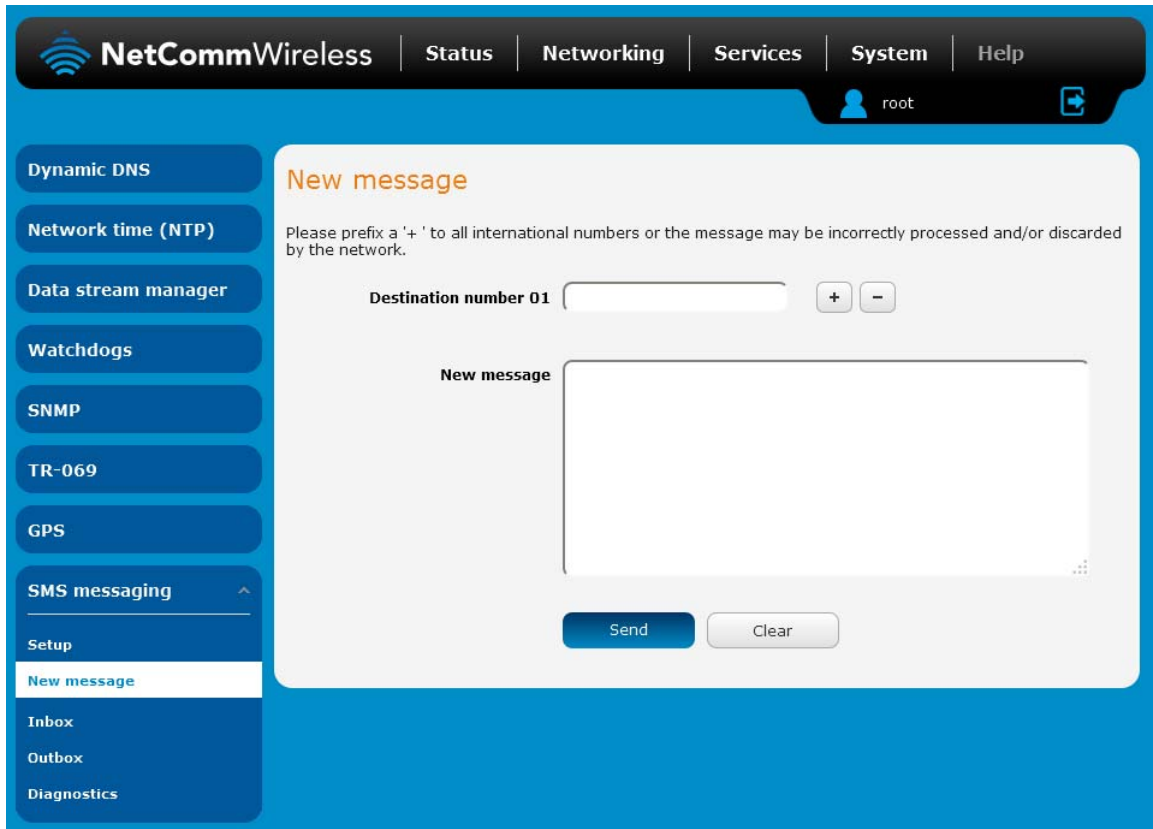

Figure 82 - SMS - New Message

Destination numbers should begin with the "+" symbol followed by the country calling code. To send a message to a destination number, enter the "+" symbol followed by the country calling code and then the destination number.

For example:

To send a message to the mobile destination number 0412345678 in Australia (country calling code 61), enter "+61412345678".

After entering the required recipient numbers, type your SMS message in the **New message** field. As you type your message, a counter shows how many characters you have entered out of the total number available for your chosen encoding scheme. When you have finished typing your message and you are ready to send it, click the **Send** button.



## Inbox / Outbox

The Inbox displays all received messages that are stored on the router while the Outbox displays all sent messages.

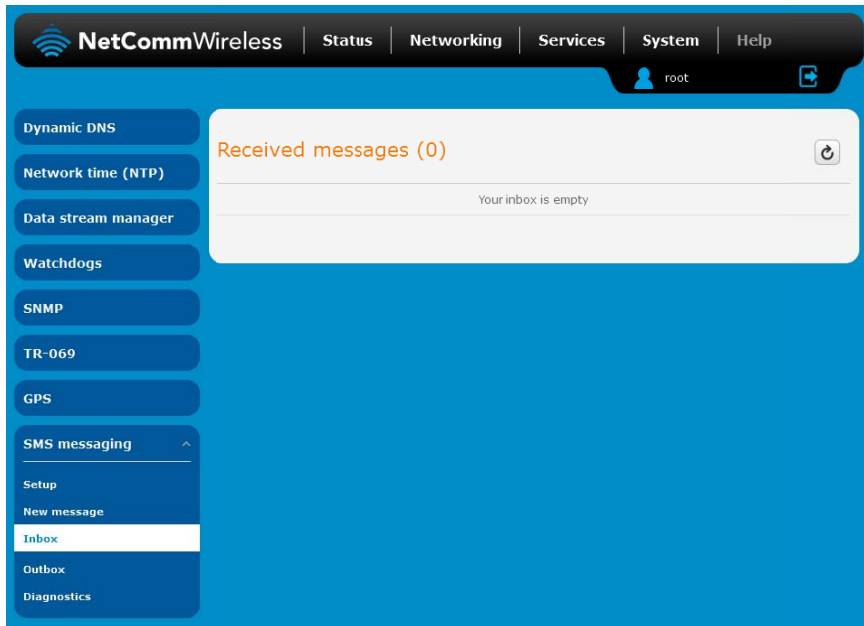

Figure 83 - SMS Inbox

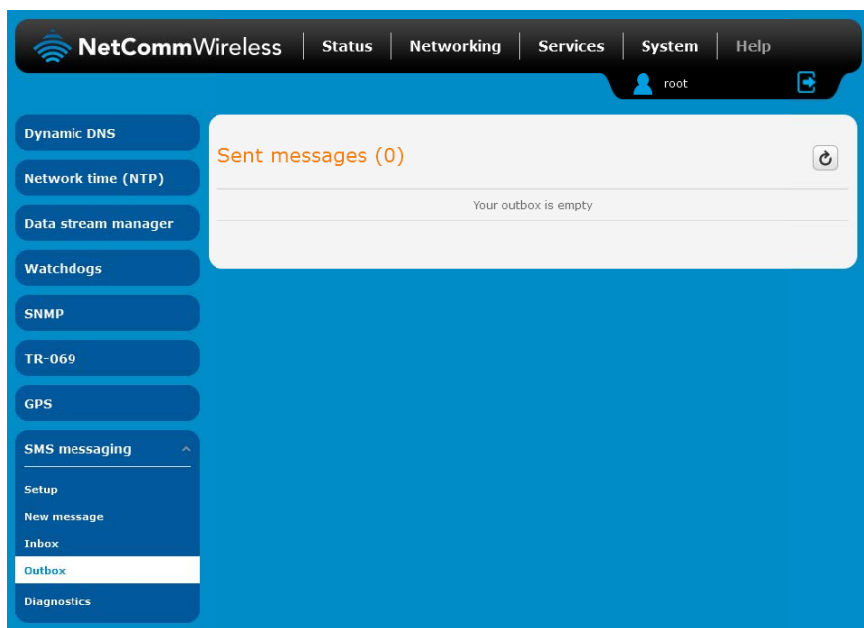

Figure 84 - SMS Outbox





ICON	DESCRIPTION
	Forward button. Click this button to open a new message window where you can forward the corresponding message to another recipient.
	Reply button. Click this button to open a new message window where you can reply to the sender.
	Add to White list. Click this button to add the sender's mobile number to the white list on the router.
	Delete button. Click this button to delete the corresponding message.
	Refresh button. Click this button to refresh the inbox or outbox to see new messages.

Table 19 - Inbox/Outbox icons

# Diagnostics

The Diagnostics page is used to configure the SMS diagnostics and command execution configuration. This allows you to change the configuration, perform functions remotely and check on the status of the router via SMS commands.

To access the Diagnostics page, click on the **Services** menu item then select the **SMS** menu on the left and finally select **Diagnostics** beneath it.

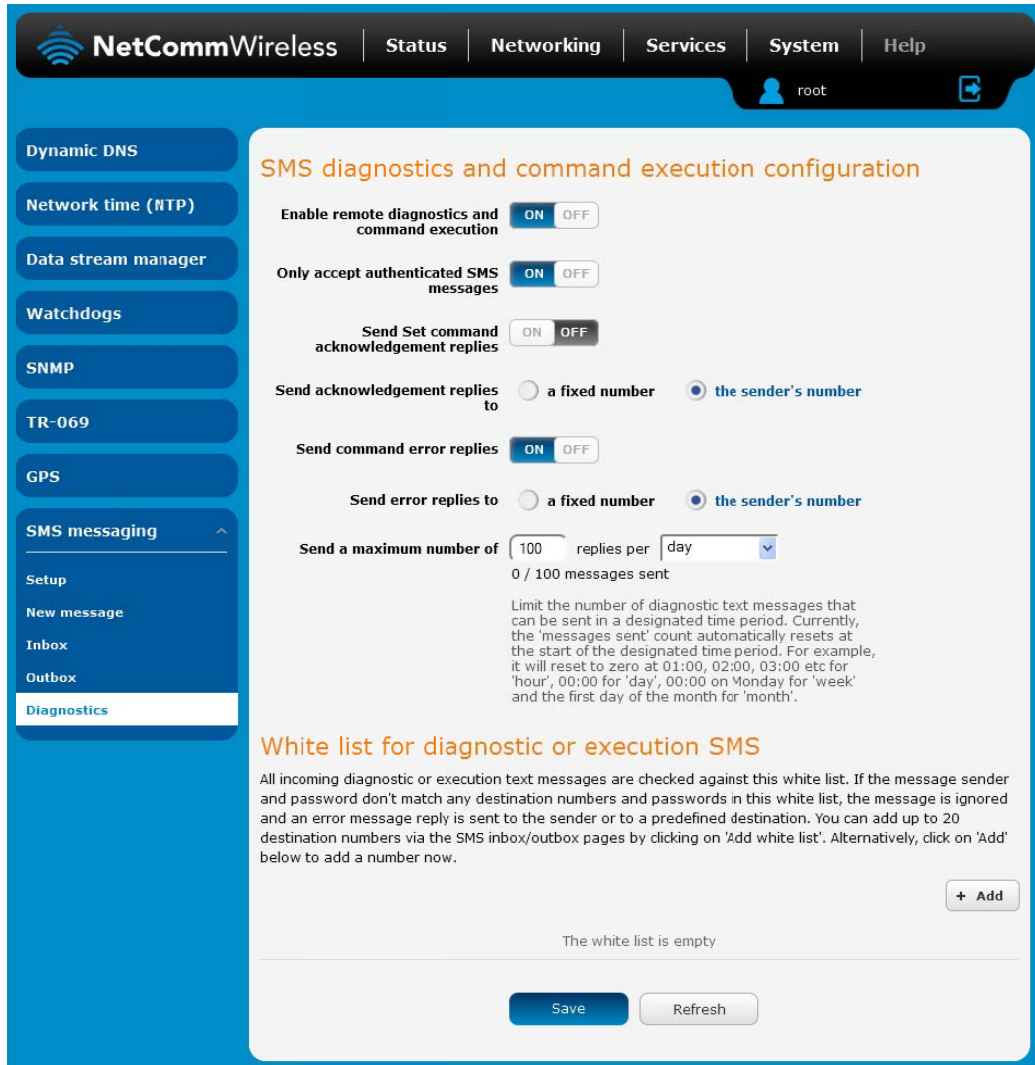

Figure 85 - SMS diagnostics and command execution configuration

## SMS diagnostics and command execution configuration

The options on this page are described below.

### Enable remote diagnostics and command execution

Enables or disables the remote diagnostics feature. If this setting is enabled all incoming text messages are parsed and tested for remote diagnostics commands.

If remote diagnostics commands are found, the router executes those commands. This feature is enabled by default. All remote diagnostic commands that are received are stored in the Inbox.



Note: It is possible to adjust settings and prevent your router from functioning correctly using remote diagnostics. If this occurs, you will need to perform a factory reset in order to restore normal operation.



We highly recommended that you use the white list and a password when utilising this feature to prevent unauthorised access. See the [White list](#) description for more information.

### Only accept authenticated SMS messages

Enables or disables checking the sender's phone number against the allowed sender white list for incoming diagnostics and command execution SMS messages.

If authentication is enabled, the router will check if the sender's number exists in the white list. If it exists, the router then checks the password (if configured) in the incoming message against the password in the white list for the corresponding sending number. If they match, the diagnostic or command is executed.

If the number does not exist in the white list or the password does not match, the router does not execute the incoming diagnostic or command in the SMS message.

This is enabled by default and it is strongly advised that you leave this feature enabled to maintain security.

### Send Set command acknowledgement replies

The 3G Light Industrial M2M router will automatically reply to certain types of commands received, such as *get* commands, or *execute* commands. However replies from the 3G Light Industrial M2M router are optional with *set* commands and the *Wakeup* command. This option Enables or disables sending an acknowledgment message after execution of a *set* command or SMS Wakeup command. If disabled, the router does not send any acknowledgement after execution of a *set* command or SMS Wakeup command. All acknowledgment replies are stored in the Outbox after they have been sent.

This can be useful to determine if a command was received and executed by the router. This option is disabled by default.

### Send acknowledgement replies to

This option allows you to specify where to send acknowledgment messages after the execution of a *set*, or *exec* command.

If a **fixed number** is selected, the acknowledgement message will be sent to the number defined in the **Fixed number to send replies to** field. If the **sender's number** is selected, the acknowledgement message will be sent to the number that the SMS diagnostic or command message originated from. The default setting is to use **the sender's number**.

### Fixed number to send replies to

This field defines the destination number to which error messages are sent after the execution of a *get*, *set*, or *exec* command. This field is only displayed when **Send Error SMS to** is set to **Fixed Number**.

### Send command error replies

Enables or disables the sending of an error message resulting from the execution of a *get*, *set*, or *exec* command. All error replies are stored in the Outbox after they have been sent.

### Send error replies to

When **Send Error SMS for Get/Set/Exec Command** is set to **ON**, this option is used to specify where the error SMS is sent. Use the radio buttons to select either **Fixed Number** or **SMS Sender Number**. When set to **SMS Sender Number** the router will reply to the originating number of the SMS diagnostic or command. When set to **Fixed Number** the router will send the error messages to the number specified in the following field.

### Send a maximum number of

You can set the maximum number of acknowledgement and error messages sent when an SMS diagnostic or command is executed. The maximum limit can be set per hour, day, week or month. The router will send a maximum of 100 replies by default.

The number of messages sent is shown below the options. The total transmitted message count resets after a reboot or at the beginning of the time frame specified.

## White List for diagnostic or execution SMS

The white list is a list of mobile numbers that you can create which are considered “friendly” to the router. If **Only accept authenticated SMS messages** is enabled in the diagnostics section, the router will compare the mobile number of all incoming diagnostic and command messages against this white list to determine whether the diagnostic or command should be executed. You may optionally configure a password for each number to give an additional level of security. When a password is specified for a number, the SMS diagnostic or command message is parsed for the password and will only be executed if the number and password match.

### White list for diagnostic or execution SMS

All incoming diagnostic or execution text messages are checked against this white list. If the message sender and password don't match any destination numbers and passwords in this white list, the message is ignored and an error message reply is sent to the sender or to a predefined destination. You can add up to 20 destination numbers via the SMS inbox/outbox pages by clicking on 'Add white list'. Alternatively, click on 'Add' below to add a number now.

The white list is empty

Figure 86 - White list for diagnostic or execution SMS

A maximum of 20 numbers can be stored on the router in the white list. To add a number to the white list, click the “+Add” button.

#	Destination number	Password	
01	0412345678	password123	<input type="button" value="x"/>

Figure 87 - Adding a number to the SMS white list

The White List numbers and passwords can be cleared by pressing the  button to the right of each entry. To add a number to the white list, enter it in the **Destination number** field and optionally define a password in the **Password** field. When you have finished adding numbers click the **Save** button to save the entries.

## Sending an SMS Diagnostic Command

Follow the steps below to configure the router to optionally accept SMS diagnostic commands only from authenticated senders and learn how to send SMS diagnostic commands to the router.

1. Navigate to the **Services > SMS messaging > Diagnostics** page
2. Confirm that the **Enable remote diagnostics and command execution** toggle key is set to the **ON** position. If it is set to **OFF** click the toggle key to switch it to the **ON** position.
3. If you wish to have the router only accept commands from authenticated senders, ensure that **Only accept authenticated SMS messages** is set to the **ON** position. In the **White list for diagnostic or execution SMS messages** section, click the **+Add** button and enter the sender's number in international format into the **Destination number** field that appears. If you wish to also configure a password, enter the password in the **Password** field corresponding to the destination number.
4. If you would prefer to accept SMS diagnostic commands from any sender, set the **Only accept authenticated SMS messages** toggle key to the **OFF** position.





Note: An alternative method of adding a number to the white list is to send an SMS message to the router, navigate to **Services > SMS messaging > Inbox** and then click the  button next to the message which corresponds to the sender's number.



5. Click the **Save** button.

## Types of SMS diagnostic commands



There are three types of commands that can be sent; **execute**, **get** and **set**. The basic syntax is as follows:

-  execute COMMAND
-  get VARIABLE
-  set VARIABLE=VALUE

If authentication is enabled, each command must be preceded by the password:

-  PASSWORD execute COMMAND
-  PASSWORD get VARIABLE
-  PASSWORD set VARIABLE=VALUE

The following are some examples of SMS diagnostic commands:

-  password6657 execute reboot
-  get rssi
-  set apn1=testAPNvalue

## SMS acknowledgment replies

The router automatically replies to **get** commands with a value and **execute** commands with either a success or error response. **Set** commands will only be responded to if the **Send Set command acknowledgement replies** toggle key is set to **ON**. If the **Send command error replies** toggle key is set to **ON**, the router will send a reply if the command is correct but a variable or value is incorrect, for example, due to misspelling.

## SMS command format

Generic Format for reading variables:

get VARIABLE

PASSWORD get VARIABLE

Generic Format for writing to variables:

set VARIABLE=VALUE

PASSWORD set VARIABLE=VALUE

Generic Format for executing a command:

Execute COMMAND

PASSWORD execute COMMAND

Replies

Upon receipt of a successfully formatted, authenticated (if required) command, the gateway will reply to the SMS in the following format:

TYPE	SMS CONTENTS	NOTES
get command	"VARIABLE=VALUE"	
set command	"Successfully set VARIABLE to VALUE"	Only sent if the acknowledgment message function is enabled
execute command	"Successfully executed command COMMAND"	

*Table 20 - SMS Diagnostic Command Syntax*

Where "VARIABLE" is the name of the value to be read

Where "VARIABLE (x)" is the name of another value to be read

Where "VALUE" is the content to be written to the "VARIABLE"

Where "COMMAND" is a supported command to be executed by the device (e.g. reboot)

Where "PASSWORD" is the password (if configured) for the corresponding sender number specified in the White List

Multiple commands can be sent in the same message, if separated by a semicolon.

For Example:

get VARIABLE1; get VARIABLE2; get VARIABLE3

PASSWORD get VARIABLE1; get VARIABLE2

set VARIABLE=VALUE1 ; set VARIABLE2=VALUE2

PASSWORD set VARIABLE1=VALUE1; set VARIABLE2=VALUE2; set VARIABLE3=VALUE3

If required, values can also be bound by an apostrophe, double apostrophe or back tick.

For Example:

"set VARIABLE='VALUE'"

"set VARIABLE=""VALUE""

"set VARIABLE=`VALUE`"

"get VARIABLE"



A password (if required), only needs to be specified once per SMS, but can be prefixed to each command if desired.

"PASSWORD get Variable1"; "get VARIABLE2"

"PASSWORD set VARIABLE1=VALUE1"; "set VARIABLE2=VALUE2"

If the command sent includes the "reboot" command and has already passed the white list password check, the device keeps this password and executes the remaining command line after the reboot with this same password.

For Example:

"PASSWORD execute reboot; getVariable1"; "get VARIABLE2"

"PASSWORD execute reboot; PASSWORD get Variable1"; "get VARIABLE2"



Note: Commands, variables and values are case sensitive.

## List of valid commands

A list of valid commands which can be used in conjunction with the execute command are listed below:

"pdpcycle", "pdpdown" and "pdpup" commands can have a profile number suffix 'x' added. Without the suffix specified, the command operates against the default profile configured on the profile list page of the Web-UI.

#	COMMAND NAME	DESCRIPTION
1	reboot	Immediately performs a soft reboot.
2	pdpcycle	Disconnects (if connected) and reconnects the data connection. If a profile number is selected in the command, try to disconnect/reconnect the specified profile in case the profile is active. If no profile number is selected, try to disconnect/reconnect the current active profile. Reports an error if no profile number is selected and there is no currently activated profile.
3	pdpdown	Disconnects the PDP. If a profile number is selected in the command, the router tries to disconnect the specified profile in case the profile is active. If no profile number is selected, try to disconnect the current active profile. Reports an error if no profile number is selected and there is no currently activated profile.
4	pdpup	Reconnects the PDP. If a profile number is selected in the command, the router tries to connect with the specified profile. If no profile number is selected, the router tries to connect to the last active profile. The gateway will check the currently activated profile and disconnect this profile before executing the command. The router reports an error if no profile number is selected and there is no stored last active profile number.
5	factorydefaults	Performs a factory reset on the router.
6	download	<p>Performs a download and install of a Firmware Upgrade (.cdi), Config File (.tar.gz) or a help document (.pdf) file.</p> <p>If the file is a firmware image as in the case of a .cdi file, the router will apply the recovery image first and then the main firmware image. The download location is specified immediately after the command and may be from an HTTP or FTP source URL.</p> <p>If the file is a .tar.gz file, the router will apply the file as a configuration file update for the device and reboot afterwards.</p> <p>If the file is a .pdf, the router will assume this is a user guide document and save it to the router and make the file available for viewing via the help menu on the Web-UI.</p> <p>Note: If your download URL includes any space characters, please encode these prior to transmission according to RFC1738, for example:</p> <p><code>ftp://username:password@serveraddress/directory%20with%20spaces/filename.cdi</code></p> <p>Note: Authenticated FTP addresses may be used following the format as defined in RFC1738, for example:</p> <p><a href="ftp://username:password@serveraddress/directory/filename.cdi">ftp://username:password@serveraddress/directory/filename.cdi</a></p>

Table 21 - List of Valid SMS diagnostic commands



The following table lists valid variables where "x" is a profile number (1-6). If no profile is specified, variables are read from or written to for the current active profile. If a profile is specified, variables are read from or written to for the specified profile number ('x').

#	RDB VARIABLE NAME	SMS VARIABLE NAME	READ/WRITE	DESCRIPTION	EXAMPLE VALUE
0	link_profile.1.enable link_profile.1.apn link_profile.1.user link_profile.1.pass link_profile.1.auth_type link_profile.1.iplocal link_profile.1.status	profile	RW	Profile	Read: (profile no,atd#xxx,user,pass,auth,iplocal,status) 1,atd#777,username,password, chap,202.44.185.111,up  Write: (atd#xxx, user, pass,auth) atd#777,username,password
2	link_profile.1.user	username	RW	3G username	Guest, could also return "null"
3	link_profile.1.pass	password	RW	3G password	Guest, could also return "null"
4	link_profile.1.auth_type	authtype	RW	3G Authentication type	"pap" or"chap"
5	link_profile.1.iplocal	wanip	R	WAN IP address	202.44.185.111
6	wwan.0.radio.information.signal_strength	rsi	R	3G signal strength	-65i dBm
7	wwan.0.meid	meid	R	MEID number	0xD0A1000021D003BB
8	statistics.usage_current	usage	R	3G data usage of current session	"Rx 500 bytes, Tx 1024 bytes, Total 1524 bytes" or "Rx 0 byte, Tx 0 byte, Total 0 byte" when wwan down
9	statistics.usage_current	wanuptime	R	Up time of current 3G session	1 days 02:30:12 or 0 days 00:00:00 when wwan down
10	/proc/uptime	deviceuptime	R	Device up time	1 days 02:30:12
11	wwan.0.system_network_status.current_band	band	R	Current Frequency channel & band	CH1:425 PCS-B Band

Table 22 - List of SMS diagnostics variables

## SMS diagnostics examples

The examples below demonstrate various combinations of supported commands. This is not an exhaustive list and serves as an example of possibilities only.

DESCRIPTION	AUTHENTICATION	INPUT EXAMPLE
Send SMS to change the data connection username	Not required	set username='NetComm'
	Required	PASSWORD set username= 'NetComm'
Send SMS to change the data connection password	Not required	set password= 'NetComm'
	Required	PASSWORD set password= 'NetComm'
Send SMS to change the data connection authentication	Not required	set authtype= 'pap'
	Required	PASSWORD set authtype = pap
Send SMS to reboot	Not required	execute reboot
	Required	PASSWORD execute reboot
Send SMS to check the WAN IP address	Not required	get wanip
	Required	PASSWORD get wanip
Send SMS to check the mobile signal strength	Not required	get rsi
	Required	PASSWORD get rsi

Send SMS to check the MEID number	Not required	get meid
	Required	PASSWORD get meid
Send SMS to check the current band	Not required	get band
	Required	PASSWORD get band
Send SMS to Disconnect (if connected) and reconnect the data connection	Not required	execute pdpcycle
	Required	PASSWORD execute pdpcycle
Send SMS to disconnect the data connection	Not required	execute pdpdown
	Required	PASSWORD execute pdpdown
Send SMS to connect the data connection	Not required	execute pdpup
	Required	PASSWORD execute pdpup
Send multiple get command	Not required	get wanip; get rssi
	Required	PASSWORD get wanip; get rssi
Send multiple set command	Not required	set ssh.genkeys=1; set username=test; set auth=pap
	Required	PASSWORD set ssh.genkeys=1; set username=test; set auth=pap
Send SMS to reset to factory default settings	Not required	execute factorydefaults
	Required	PASSWORD execute factorydefaults
Send SMS to retrieve status of router	Not required	get status
	Required	PASSWORD get status
Send SMS to retrieve the history of the session, including start time, end time and total data usage	Not required	get sessionhistory
	Required	PASSWORD get sessionhistory
Send SMS to configure the router to send syslog to a remote syslog server	Not required	set syslogserver
	Required	PASSWORD set syslogserver
Send SMS to wake up the router, turn on the default gateway and trigger the 'connect on demand' profile if in waiting state.	Not required	execute wakeup
	Required	PASSWORD execute wakeup
Send SMS to perform firmware upgrade when firmware is located on HTTP server	Not required	execute download <a href="http://download.com:8080/firmware_image.cdi">http://download.com:8080/firmware_image.cdi</a> execute download <a href="http://download.com:8080/firmware_image_r.cdi">http://download.com:8080/firmware_image_r.cdi</a>
	Required	PASSWORD execute download <a href="http://download.com:8080/firmware_image.cdi">http://download.com:8080/firmware_image.cdi</a> PASSWORD execute download <a href="http://download.com:8080/firmware_image_r.cdi">http://download.com:8080/firmware_image_r.cdi</a>
Send SMS to perform firmware upgrade when firmware is located on FTP server	Not required	execute download ftp://username:password@download.com/firmware_image.cdi execute download ftp://username:password@download.com/firmware_image_r.cdi
	Required	PASSWORD execute download ftp://username:password@download.com/firmware_image.cdi PASSWORD execute download ftp://username:password@download.com/firmware_image_r.cdi
Send SMS to turn off PPPoE	Not required	set pppoe=0
	Required	PASSWORD set pppoe=0
Send SMS to turn on PPPoE and set dialstring and service name	Not required	set pppoe=1,atd#777, Test
	Required	PASSWORD set pppoe=1,atd#777, Test
Send SMS to retrieve the PPPoE status, currently configured dial string and service name	Not required	get pppoe
	Required	PASSWORD get pppoe
Send SMS to set the LED mode timeout to 10 minutes	Not required	set ledmode=10
	Required	PASSWORD set ledmode=10
Send SMS to retrieve the current LED mode	Not required	get ledmode
	Required	PASSWORD get ledmode
Retrieve current SSH protocol	Not required	get ssh.proto
	Required	PASSWORD get ssh.proto

Select SSH protocol	Not required	set ssh.proto=1
	Required	PASSWORD set ssh.proto=1
Retrieve password authentication status	Not required	get ssh.passauth
	Required	PASSWORD get.ssh.passauth
Enable/disable password authentication on host	Not required	set ssh.passauth=1 or set ssh.passauth=0
	Required	PASSWORD set ssh.passauth=1 or PASSWORD set ssh.passauth=0
Generate set of public/private keys on the host	Not required	execute ssh.genkeys
	Required	PASSWORD execute ssh.genkeys
Clear client public keys stored on host	Not required	execute ssh.clearkeys
	Required	PASSWORD execute ssh.clearkeys
Retrieve the MEID of the router	Not required	get MEID
	Required	PASSWORD get MEID

*Table 23 - SMS diagnostics example commands*

# System

## Log

The Log pages are used to display or download the System log and IPSec logs on the router.

### System log

The System Log enables you to troubleshoot any issues you may be experiencing with your 3G Light Industrial M2M router. To access the System Log page, click on the **System** menu. The System Log is displayed.

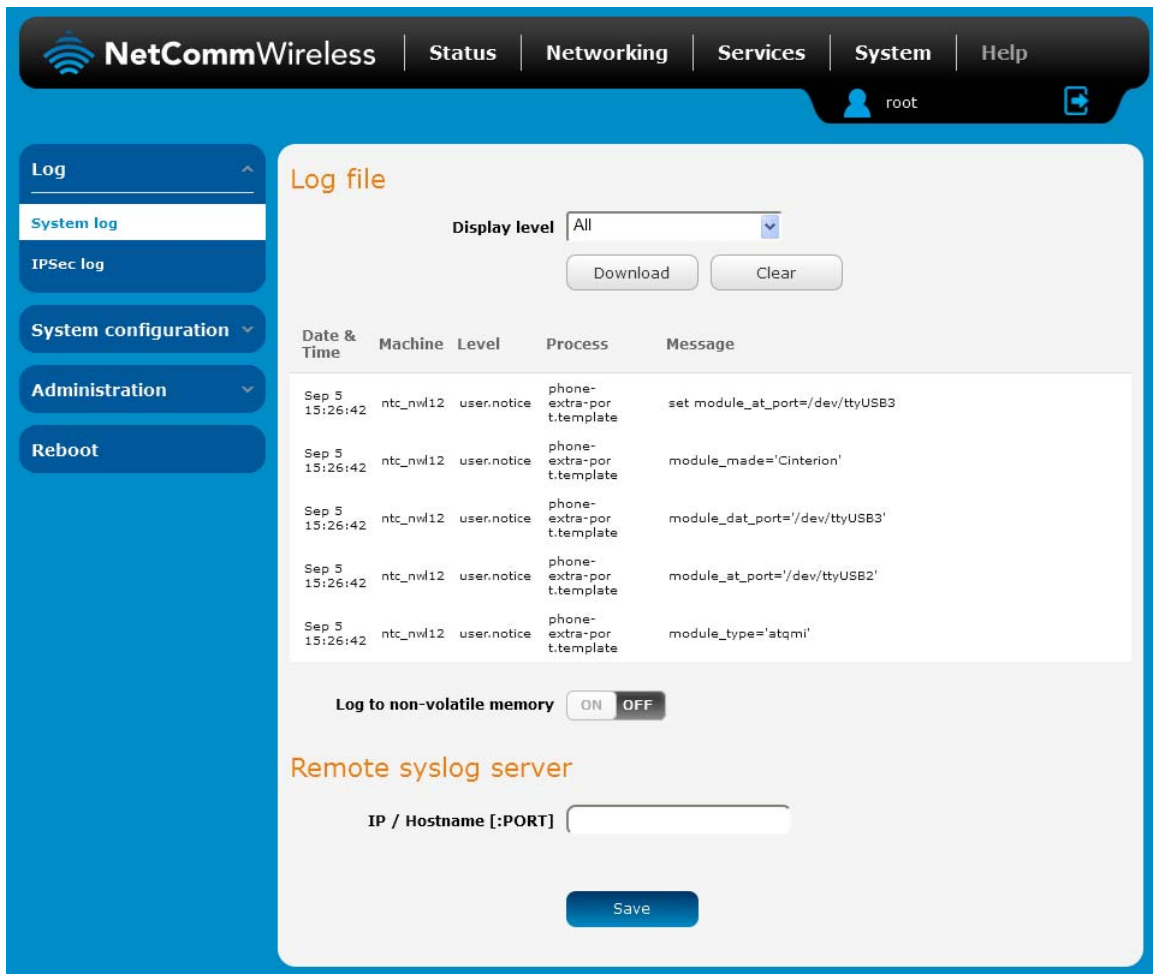

Figure 88 - System log file

### Log file

Use the **Display level** drop-down list to select a message level to be displayed. The message levels are described in the table below.

To download the System log for offline viewing, right-click the **Download** button and choose **Save as..** to save the file. To clear the System log, click the **Clear** button. The downloaded log file is in Linux text format with carriage return (CR) only at the end of a line, therefore in order to be displayed correctly with new lines shown, it is recommended to use a text file viewer which displays this format correctly (e.g. Notepad++).

Log data is stored in RAM and therefore, when the unit loses power or is rebooted, it will lose any log information stored in RAM. To ensure that log information is accessible between reboots of the router there are two options:

1. Enable the **Log to file** option

2. Use a remote syslog server

### Enable the log to file option

When the router is configured to log to a file, the log data is stored in flash memory, making it accessible after a reboot of the router. Up to 512kb of log data will be stored before it is overwritten by new log data. Flash memory has a finite number of program-erase operations that it may perform to the blocks of memory. While this number of program-erase operations is quite large, we recommend that you do not enable this option for anything other than debugging to avoid excessive wear on the memory.

### Use a remote syslog server

The router can be configured to output log data to a remote syslog server. This is an application running on a remote computer which accepts and displays the log data. Most syslog servers can also save the log data to a file on the computer on which it is running allowing you to ensure that no log data is lost between reboots.

To configure the 3G Light Industrial M2M Router to output log data to a remote syslog server:

1. Click on the **System** menu from the top menu bar. The System log item is displayed.
2. Under the **Remote syslog server** section, enter the IP address or hostname of the syslog server in the **IP / Hostname [:PORT]** field. You can also specify the port number after the IP or hostname by entering a semi-colon and then the port number e.g. 192.168.1.102:514. If you do not specify a port number, the router will use the default UDP port 514.
3. Click the **Save** button to save the configuration.

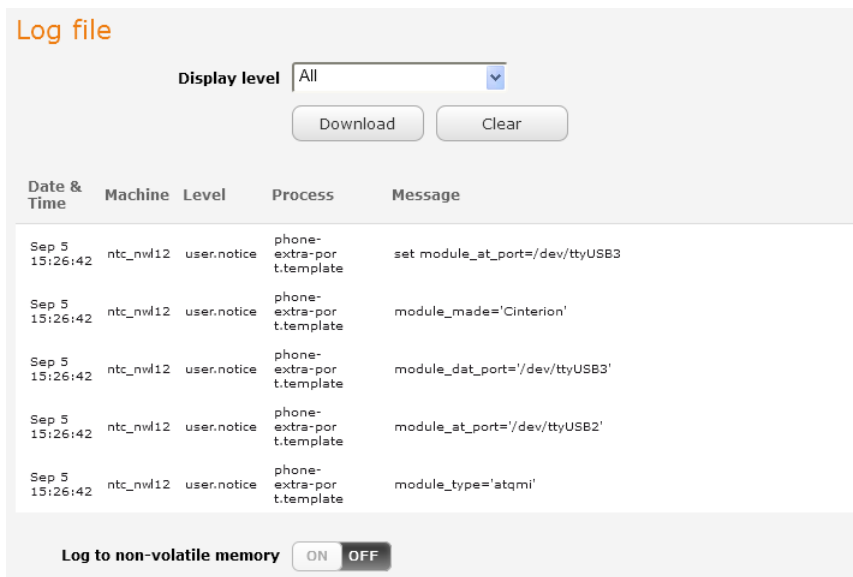

Figure 89 - System log

ITEM	DEFINITION
All	Display all system log messages.
Debug	Show extended system log messages with full debugging level details.
Info	Show informational messages only.
Notice	Show normal system logging information.
Warning	Show warning messages only.
Error	Show error condition messages only.

Table 24 - System log detail levels

## IPSec log

The IPSec log section provides the ability for you to download the log for the IPSec VPN function. This can assist in troubleshooting any problems you may have with the IPSec VPN.

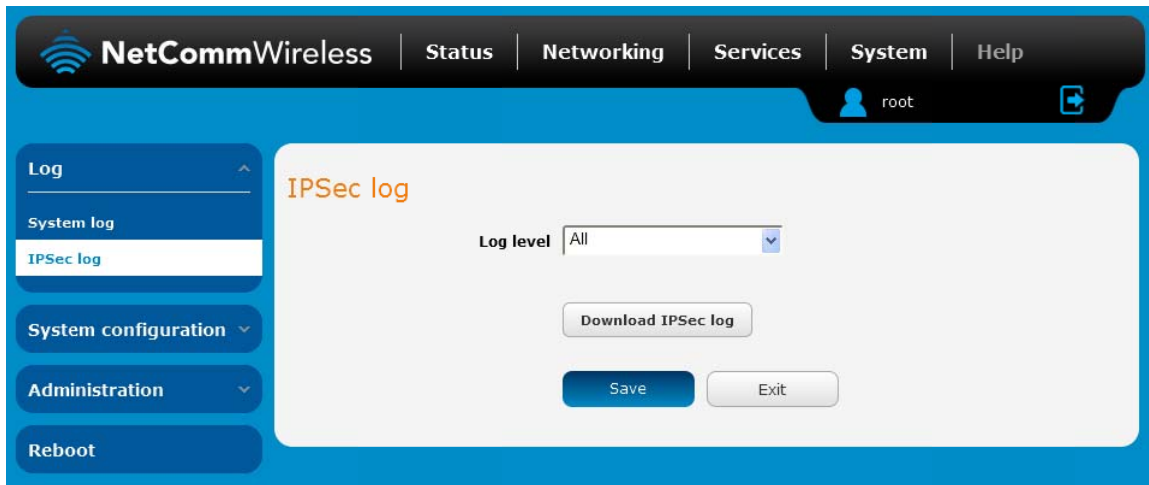

Figure 90 - IPSec log

Use the **Log level** drop down list to specify the type of detail you want to capture in the log and then click the **Save** button. When you change the logging level, any active IPSec VPN tunnels will be disconnected as a change in logging level requires the IPSec service to be restarted.

To download the IPSec log, click the **Download IPSec log** button and you will be prompted to save the file.

# System Configuration

## Settings backup and restore

The settings backup / restore page is used to backup or restore the router's configuration or to reset it to factory defaults. In order to view the settings page you must be logged into the web user interface as **root** using the password **admin**. The backup / restore functions can be used to easily configure a large number of 3G Light Industrial M2M router by configuring one router with your desired settings, backing them up to a file and then restoring that file to multiple 3G Light Industrial M2M routers.

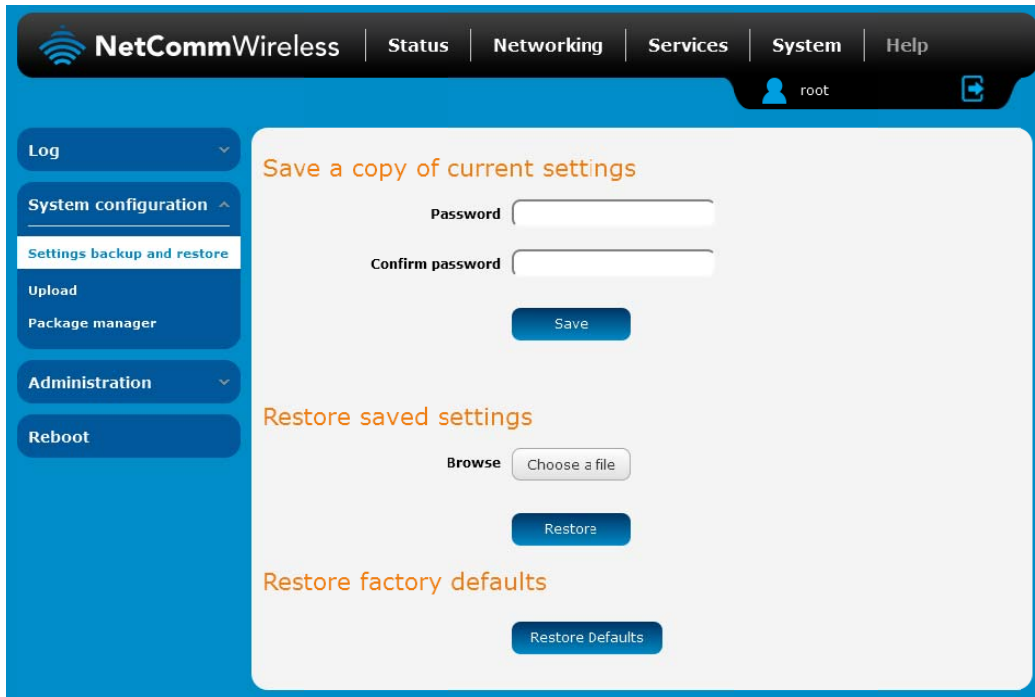

Figure 91 - Settings backup and restore

### Back up your router's configuration

Log in to the web configuration interface, click on the **System** menu and select **Settings backup and restore**.

If you want to password protect your backup configuration files, enter your password in the fields under **Save a copy of current settings** and click on **Save**. If you don't want to password protect your files, just click on **Save**. The router will then prompt you to select a location to save the settings file.



Note: The following conditions apply:-

- It is NOT possible to edit the contents of the file downloaded; if you modify the contents of the configuration file in any way you will not be able to restore it later.
- You may change the name of the file if you wish but the filename extension must remain as ".cfg"

### Restore your backup configuration

1. In the web configuration interface click on the **System** menu and select **Settings backup and restore**.
2. From the **Restore saved settings** section, click on **Browse** or **Choose a file** and select the backup configuration file on your computer.
3. Click **Restore** to copy the settings to the new 3G Light Industrial M2M router. The router will apply these settings and inform you it will reboot - click on **OK**.

### Restoring the router's factory default configuration

Click the **Restore Defaults** button to restore the factory default configuration. The router asks you to confirm that you wish to restore factory default settings. If you wish to continue with the restoring of factory defaults, click **OK**.



Note: All current settings on the router will be lost when performing a restore of factory default settings. The device IP address will change to 192.168.1.1 and the default username **root** and default password **admin** will be configured.



## Upload

To access the Upload page, click on the **System** menu, then **System Configuration** and then **Upload**.

The Upload page allows you to upload firmware files, HTTPS certificates or user created application packages to the 3G Light Industrial M2M router. When firmware files have been uploaded, they can also be installed from this page. PDF files, such as this user guide may also be uploaded for access on the router's help page.

For more information on application development, contact NetComm Wireless about our Software Development Kit.

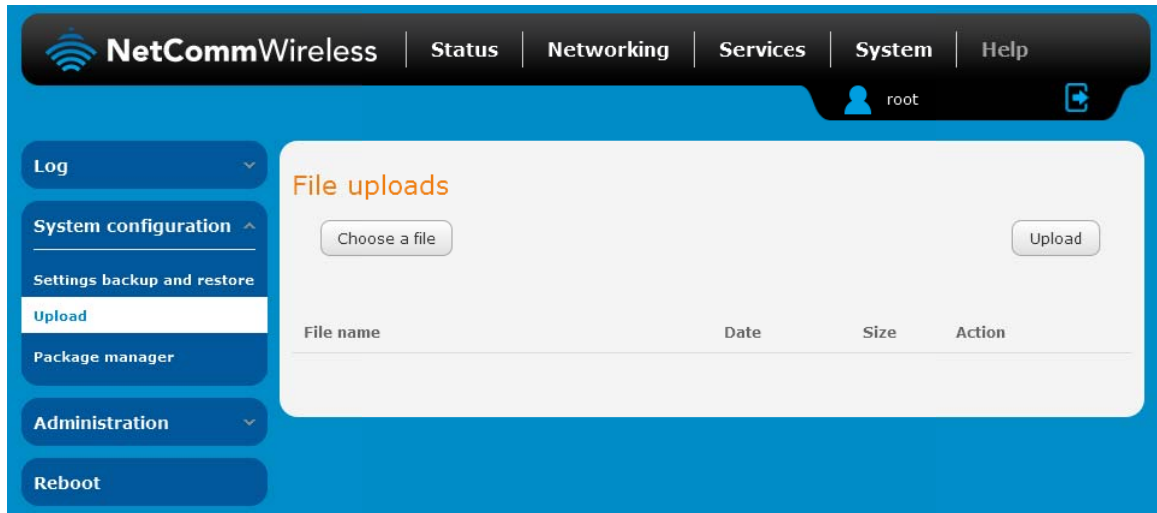

Figure 92 - Upload page

## Updating the Firmware

The firmware update process involves first updating the recovery image firmware and then updating the main firmware image.



Note: In order to perform an update, you must be logged into the router with the root manager account (see the [Advanced configuration](#) section for more details).

To update the 3G Light Industrial M2M Router's firmware:

1. Power on the router as described in the [Installing the router](#) section.
2. Log in to the router with the root user account (See the [Advanced configuration](#) section for details)
3. Select the **System** item from the top menu bar, select the **System configuration** item from the menu on the left and then select the **Upload** menu item.
4. Under the **File uploads** section, click the **Browse** button. Locate the recovery firmware image file on your computer and click **Open**. The recovery image is named `ntc_nwl12_x.xx.xx.x_r.cdi` while the main system firmware image is named `ntc_nwl12_x.xx.xx.x.cdi`.
5. Click the **Upload** button. The firmware image is uploaded to the storage on the router.

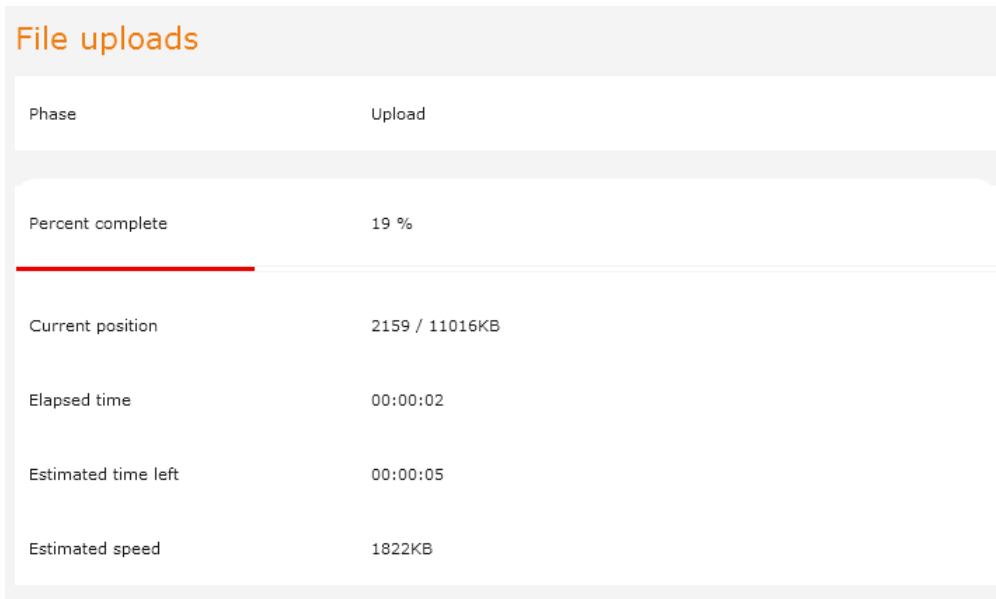

Figure 93 - File upload

- Repeat steps 4 and 5 for the main system firmware image.
- The uploaded firmware images are listed in the **Uploaded files** section. Click the **Install** link next to the recovery image to begin installing the recovery firmware image and then click **OK** on the confirmation window that appears.

File name	Date	Size	Action
ntc_nwl12_trunk.44948.cdi	Sep 6 2013	27.6M	<b>Install</b> <b>Delete</b>
ntc_nwl12_trunk.44948_r.cdi	Sep 5 2013	10.8M	<b>Install</b> <b>Delete</b>

Figure 94 - Uploaded files

- The recovery firmware image is flashed and when it is complete, the router displays "The firmware update was successful" and returns to the main Upload screen.

```
Erasing 128 Kibyte @ b20000 -- 92 % complete.
Erasing 128 Kibyte @ b40000 -- 93 % complete.
Erasing 128 Kibyte @ b60000 -- 94 % complete.
Erasing 128 Kibyte @ b80000 -- 95 % complete.
Erasing 128 Kibyte @ ba0000 -- 96 % complete.
Erasing 128 Kibyte @ bc0000 -- 97 % complete.
Erasing 128 Kibyte @ be0000 -- 98 % complete.
Erasing 128 Kibyte @ c00000 -- 100 % complete.
Flashing root_r.ubi to "rfs" (/dev/mtd2)
Writing data to block 55 at offset 0x6e0000
Writing data to block 56 at offset 0x700000
Writing data to block 57 at offset 0x720000
Writing data to block 58 at offset 0x740000
Writing data to block 59 at offset 0x760000
Writing data to block 60 at offset 0x780000
Writing data to block 61 at offset 0x7a0000
Done
Done
Done
The firmware update was successful
```

**Close**

Figure 95 - Recovery firmware flash process

- Click the [Install](#) link to the right of the main firmware image you uploaded and then click OK to confirm that you want to continue with the installation.



Note: Do not remove the power when the router's LEDs are flashing as this is when the firmware update is in process.

- The installation is complete when the countdown reaches zero. The router attempts to redirect you to the Status page.

```
Writing data to block 190 at offset 0x17c0000
Writing data to block 191 at offset 0x17e0000
Writing data to block 192 at offset 0x1800000
Writing data to block 193 at offset 0x1820000
Writing data to block 194 at offset 0x1840000
Done
Done
Done
The firmware update was successful Reboot to main system...
Estimated time remaining: 47 seconds
Estimated time remaining: 42 seconds
Estimated time remaining: 37 seconds
Estimated time remaining: 32 seconds
Estimated time remaining: 27 seconds
Estimated time remaining: 22 seconds
Estimated time remaining: 17 seconds
Estimated time remaining: 12 seconds
Estimated time remaining: 7 seconds
Estimated time remaining: 2 seconds
Redirecting you to the Status page...
```

[Close](#)

Figure 96 -- Installing main firmware image

- Hold down the reset button on the router for 15-20 seconds to reboot and restore the factory default settings of the router. See the [Restoring factory default settings](#) section for more information.

## Package manager

The Package Manager page is used to provide details of any user installed packages on the router and allow them to be uninstalled.

For more information on application development, contact NetComm Wireless about our Software Development Kit.

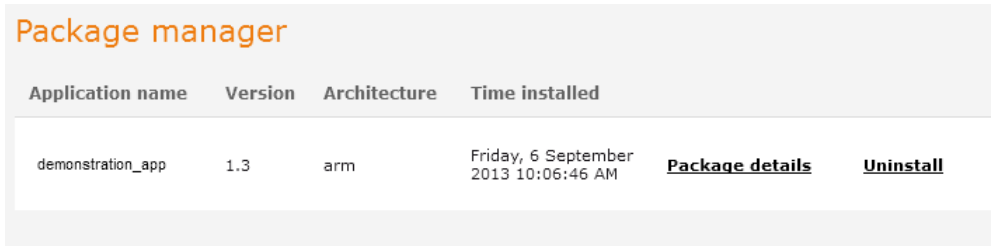

Application name	Version	Architecture	Time installed		
demonstration_app	1.3	arm	Friday, 6 September 2013 10:06:46 AM	<a href="#">Package details</a>	<a href="#">Uninstall</a>

*Figure 97 - Software applications manager*

The Application name, Version number of the application, the architecture type and time of installation are all displayed. Clicking the [Package details](#) link will display a pop-up window with further details of the package.

To uninstall any software applications, click the [Uninstall](#) link.

## Administration settings

To access the Administration Settings page, click on the **System** menu then the **Administration** menu on the left and then click on **Administration Settings**.

The Administration settings page is used to enable or disable protocols used for remote access and configure the passwords for the user accounts used to log in to the router.

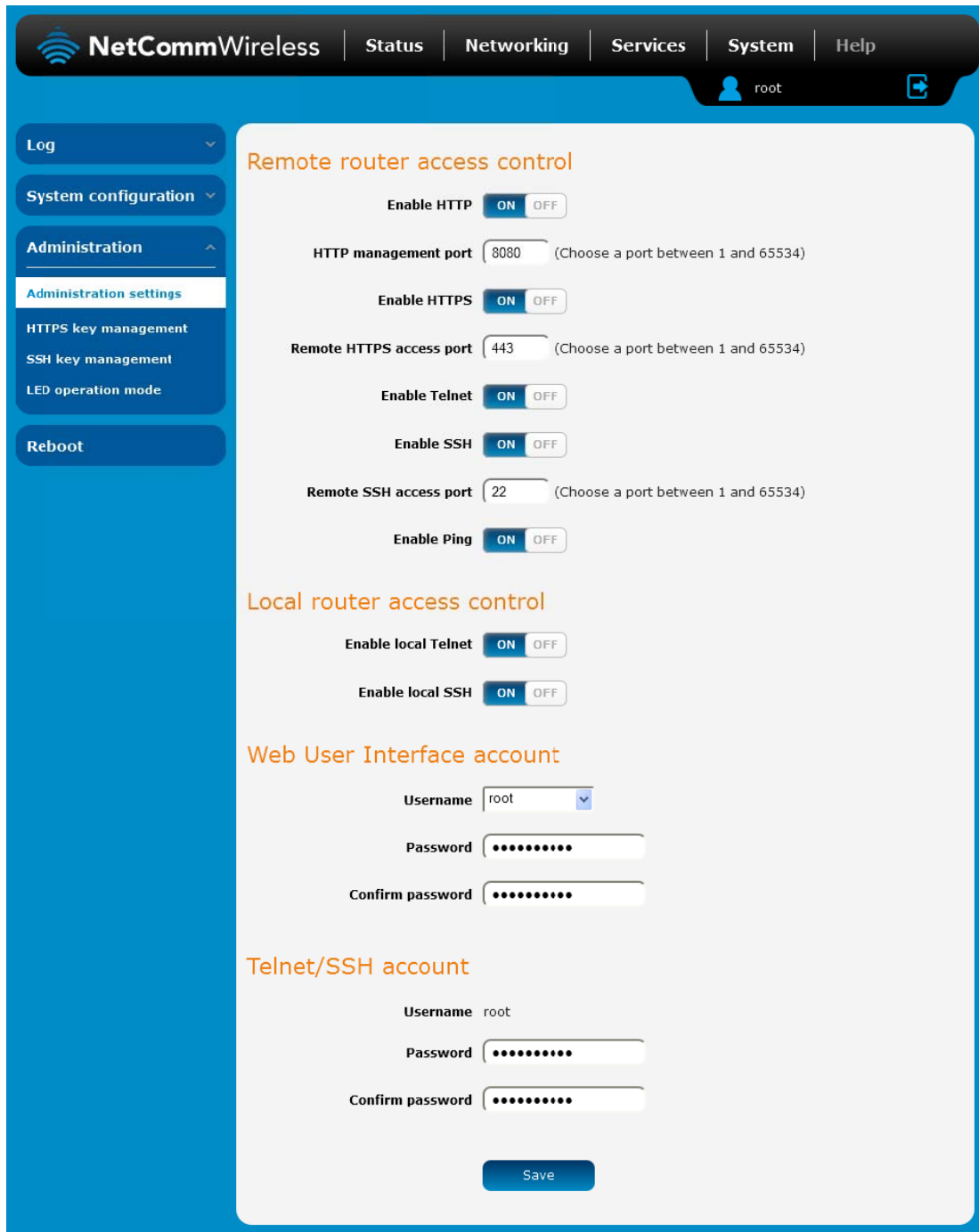

**NetCommWireless** | Status | Networking | Services | System | Help

root

Log

System configuration

Administration

Administration settings

HTTPS key management

SSH key management

LED operation mode

Reboot

### Remote router access control

Enable HTTP  ON  OFF

HTTP management port  (Choose a port between 1 and 65534)

Enable HTTPS  ON  OFF

Remote HTTPS access port  (Choose a port between 1 and 65534)

Enable Telnet  ON  OFF

Enable SSH  ON  OFF

Remote SSH access port  (Choose a port between 1 and 65534)

Enable Ping  ON  OFF

### Local router access control

Enable local Telnet  ON  OFF

Enable local SSH  ON  OFF

### Web User Interface account

Username

Password

Confirm password

### Telnet/SSH account

Username

Password

Confirm password

Save

Figure 98 - Administration page

OPTION	DEFINITION
<b>Remote router access control</b>	
Enable HTTP	Enable or disable remote HTTP access to the router. You can also set the port you would like remote HTTP access to be available on.
HTTP management port	Enter a port number between 1 and 65534 to use when accessing the router remotely.
Enable HTTPS	Enable or disable remote HTTPS access to the router using a secure connection.
Remote HTTPS access port	Enter a port number between 1 and 65534 to use when accessing the router remotely over a secure HTTPS connection.
Enable Telnet	Enable or disable remote telnet (command line) access to the router.
Enable SSH	Enable or disable Secure Shell on the router.
Remote SSH Access Port	Enter the port number for remote SSH access. Must be a port number between 1 and 65534.
Enable Ping	Enable or disable remote ping responses on the WWAN connection.
<b>Web User Interface account</b>	
Username	Use the drop down list to select the <b>root</b> or <b>admin</b> account to change its web user interface password.
Password	Enter the desired web user interface password.
Confirm password	Re-enter the desired web user interface password.
<b>Telnet/SSH account</b>	
Username	Displays the Telnet/SSH.username. This may not be changed.
Password	Enter the desired Telnet/SSH password.
Confirm password	Re-enter the desired Telnet/SSH password.

*Table 25 - Administration configuration options*

To access the router's configuration pages remotely:

1. Open a new browser window and navigate to the WAN IP address and assigned port number of the router, for example <http://123.209.130.249:8080>



Note: You can find the router's WAN IP address by clicking on the "Status" menu. The WWAN IP field in the WWAN Connection Status section shows the router's WAN IP address.

2. Enter the username and password to login to the router and click **Log in**.



Note: To perform functions like Firmware upgrade, device configuration backup and to restore and reset the router to factory defaults, you must be logged in with the root manager account.

# HTTPS key management

## What is HTTP Secure?

HTTP Secure or HTTPS is the use of the HTTP protocol over an SSL/TLS protocol. It is used primarily to protect against eavesdropping of communication between a web browser and the web site to which it is connected. This is especially important when you wish to have a secure connection over a public network such as the internet. HTTPS connections are secured through the use of certificates issued by trusted certificate authorities such as VeriSign. When a web browser makes a connection attempt to a secured web site, a digital certificate is sent to the browser so that it can verify the authenticity of the site using a built-in list of trusted certificate authorities.

There are two main differences between how HTTPS and HTTP connections work:

1. HTTPS uses port 443 while HTTP uses port 80 by default.
2. Over an HTTPS connection, all data sent and received is encrypted with SSL while over an HTTP connection, all data is sent unencrypted.

The encryption is achieved through the use of a pair of public and private keys on both sides of the connection. In cryptography, a key refers to a numerical value used by an algorithm to alter information (encrypt it), making the information secure and visible only to those who have the corresponding key to recover (decrypt) the information. The public key is used to encrypt information and can be distributed freely. The private key is used to decrypt information and must be secret by its owner.

Each 3G Light Industrial M2M router contains a self-signed digital certificate which is identical on all 3G Light Industrial M2M routers. For a greater level of security, the router also supports generating your own unique key. Additionally, you may use third party software to generate your own self-signed digital certificate or purchase a signed certificate from a trusted certificate authority and then upload those certificates to the router.

## Generating your own self-signed certificate

To generate your own self-signed certificate:

1. Click the **System** item from the top menu bar, then **Administration** from the side menu bar and then **HTTPS key management**.
2. Enter the certificate details using the appropriate fields. Each field must be completed in order to generate a certificate.



The screenshot shows the NetCommWireless web interface. At the top, there is a navigation bar with the logo and menu items: Status, Networking, Services, System, and Help. The user is logged in as 'root'. On the left side, there is a sidebar menu with options: Log, System configuration, Administration (expanded), Administration settings, HTTPS key management (selected), SSH key management, LED operation mode, and Reboot. The main content area is titled 'Generate self signed HTTPS certificate' and contains the following form fields: Country, State, City, Organisation, and Email. A 'Generate' button is located at the bottom of the form.

Figure 99 - Generate self signed HTTPS certificate



Note: The Country field must contain a code for the desired country from the list below.

CODE	COUNTRY	CODE	COUNTRY	CODE	COUNTRY	CODE	COUNTRY
AX	Åland Islands	ER	Eritrea	LS	Lesotho	SA	Saudi Arabia
AD	Andorra	ES	Spain	LT	Lithuania	SB	Solomon Islands
AE	United Arab Emirates	ET	Ethiopia	LU	Luxembourg	SC	Seychelles
AF	Afghanistan	FI	Finland	LV	Latvia	SE	Sweden
AG	Antigua and Barbuda	FJ	Fiji	LY	Libya	SG	Singapore
AI	Anguilla	FK	Falkland Islands (Malvinas)	MA	Morocco	SH	St. Helena
AL	Albania	FM	Micronesia	MC	Monaco	SI	Slovenia
AM	Armenia	FO	Faroe Islands	MD	Moldova	SJ	Svalbard and Jan Mayen Islands
AN	Netherlands Antilles	FR	France	ME	Montenegro	SK	Slovak Republic
AO	Angola	FX	France, Metropolitan	MG	Madagascar	SL	Sierra Leone
AQ	Antarctica	GA	Gabon	MH	Marshall Islands	SM	San Marino
AR	Argentina	GB	Great Britain (UK)	MK	Macedonia	SN	Senegal
AS	American Samoa	GD	Grenada	ML	Mali	SR	Suriname
AT	Austria	GE	Georgia	MM	Myanmar	ST	Sao Tome and Principe
AU	Australia	GF	French Guiana	MN	Mongolia	SU	USSR (former)
AW	Aruba	GG	Guernsey	MO	Macau	SV	El Salvador
AZ	Azerbaijan	GH	Ghana	MP	Northern Mariana Islands	SZ	Swaziland
BA	Bosnia and Herzegovina	GI	Gibraltar	MQ	Martinique	TC	Turks and Caicos Islands
BB	Barbados	GL	Greenland	MR	Mauritania	TD	Chad
BD	Bangladesh	GM	Gambia	MS	Montserrat	TF	French Southern Territories
BE	Belgium	GN	Guinea	MT	Malta	TG	Togo
BF	Burkina Faso	GP	Guadeloupe	MU	Mauritius	TH	Thailand
BG	Bulgaria	GQ	Equatorial Guinea	MV	Maldives	TJ	Tajikistan
BH	Bahrain	GR	Greece	MW	Malawi	TK	Tokelau
BI	Burundi	GS	S. Georgia and S. Sandwich Isls.	MX	Mexico	TM	Turkmenistan
BJ	Benin	GT	Guatemala	MY	Malaysia	TN	Tunisia
BM	Bermuda	GU	Guam	MZ	Mozambique	TO	Tonga
BN	Brunei Darussalam	GW	Guinea-Bissau	NA	Namibia	TP	East Timor
BO	Bolivia	GY	Guyana	NC	New Caledonia	TR	Turkey
BR	Brazil	HK	Hong Kong	NE	Niger	TT	Trinidad and Tobago
BS	Bahamas	HM	Heard and McDonald Islands	NF	Norfolk Island	TV	Tuvalu
BT	Bhutan	HN	Honduras	NG	Nigeria	TW	Taiwan
BV	Bouvet Island	HR	Croatia (Hrvatska)	NI	Nicaragua	TZ	Tanzania
BW	Botswana	HT	Haiti	NL	Netherlands	UA	Ukraine
BZ	Belize	HU	Hungary	NO	Norway	UG	Uganda
CA	Canada	ID	Indonesia	NP	Nepal	UM	US Minor Outlying Islands
CC	Cocos (Keeling) Islands	IE	Ireland	NR	Nauru	US	United States
CF	Central African Republic	IL	Israel	NT	Neutral Zone	UY	Uruguay
CH	Switzerland	IM	Isle of Man	NU	Niue	UZ	Uzbekistan
CI	Cote D'Ivoire (Ivory Coast)	IN	India	NZ	New Zealand (Aotearoa)	VA	Vatican City State (Holy See)
CK	Cook Islands	IO	British Indian Ocean Territory	OM	Oman	VC	Saint Vincent and the Grenadines
CL	Chile	IS	Iceland	PA	Panama	VE	Venezuela
CM	Cameroon	IT	Italy	PE	Peru	VG	Virgin Islands (British)
CN	China	JE	Jersey	PF	French Polynesia	VI	Virgin Islands (U.S.)
CO	Colombia	JM	Jamaica	PG	Papua New Guinea	VN	Viet Nam
CR	Costa Rica	JO	Jordan	PH	Philippines	VU	Vanuatu
CS	Czechoslovakia (former)	JP	Japan	PK	Pakistan	WF	Wallis and Futuna Islands
CV	Cape Verde	KE	Kenya	PL	Poland	WS	Samoa
CX	Christmas Island	KG	Kyrgyzstan	PM	St. Pierre and Miquelon	YE	Yemen
CY	Cyprus	KH	Cambodia	PN	Pitcairn	YT	Mayotte
CZ	Czech Republic	KI	Kiribati	PR	Puerto Rico	ZA	South Africa
DE	Germany	KM	Comoros	PS	Palestinian Territory	ZM	Zambia
DJ	Djibouti	KN	Saint Kitts and Nevis	PT	Portugal	COM	US Commercial
DK	Denmark	KR	Korea (South)	PW	Palau	EDU	US Educational
DM	Dominica	KW	Kuwait	PY	Paraguay	GOV	US Government
DO	Dominican Republic	KY	Cayman Islands	QA	Qatar	INT	International
DZ	Algeria	KZ	Kazakhstan	RE	Reunion	MIL	US Military
EC	Ecuador	LA	Laos	RO	Romania	NET	Network
EE	Estonia	LC	Saint Lucia	RS	Serbia	ORG	Non-Profit Organization
EG	Egypt	LI	Liechtenstein	RU	Russian Federation	ARPA	Old style Arpanet
EH	Western Sahara	LK	Sri Lanka	RW	Rwanda		





3. When you have entered all the required details, press the **Generate** button. The certificate takes several minutes to generate. When the certificate has been generated, you are informed that it has been successfully generated and installed. The web server on the router restarts and you are logged out of the router. Click **OK** to be taken back to the login screen.

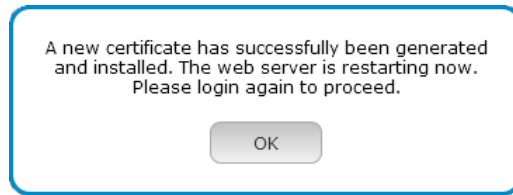



*Figure 100 - New certificate successfully generated message*

## SSH Key Management

Secure Shell (SSH) is UNIX-based command interface and network protocol used to gain secure access to a remote computer, execute commands on a remote machine or to transfer files between machines. It was designed as a replacement for Telnet and other insecure remote shell protocols which send information, including passwords, as plain text.

SSH uses RSA public key cryptography for both connection and authentication. Two common ways of using SSH are:

-  Use automatically generated public-private key pairs to encrypt the network connection and then use password authentication to log on.
-  Use a manually generated public-private key pair to perform the authentication and allow users or programs to log in without using a password.

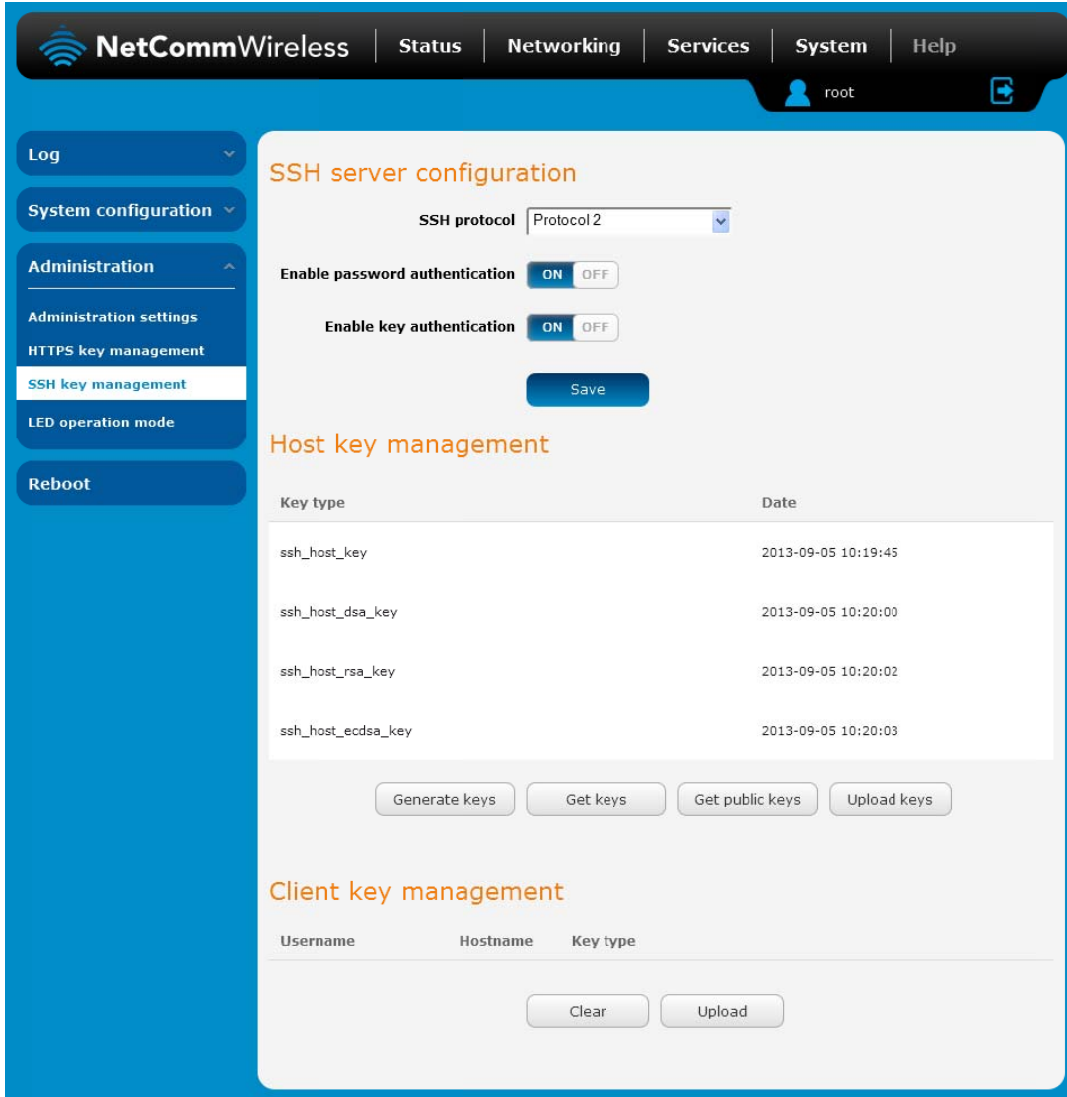

**SSH server configuration**

SSH protocol: Protocol 2

Enable password authentication:  ON  OFF

Enable key authentication:  ON  OFF

Save

**Host key management**

Key type	Date
ssh_host_key	2013-09-05 10:19:45
ssh_host_dsa_key	2013-09-05 10:20:00
ssh_host_rsa_key	2013-09-05 10:20:02
ssh_host_ecdsa_key	2013-09-05 10:20:03

Generate keys | Get keys | Get public keys | Upload keys

**Client key management**

Username	Hostname	Key type

Clear | Upload

Figure 101 - SSH Server Configuration

## SSH Server Configuration

To configure the SSH server settings:

1. Use the SSH Protocol drop down list to select the protocol that you want to use. Protocol 2 is more recent and is considered more secure.
2. Select the types of authentication you want to use by clicking the **Enable password authentication** and **Enable key authentication** toggle keys on or off. Note that you may have both authentication methods on but you may not turn them both off.
3. Click the **Save** button to confirm your settings.

## Host key management

SSH keys provide a means of identification using public key cryptography and challenge response authentication. This means that a secure connection can be established without transmitting a password, thereby greatly reducing the threat of someone eavesdropping and guessing the correct credentials.

SSH Keys always come in pairs with one being a public key and the other a private key. The public key may be shared with any server to which you want to connect. When a connection request is made, the server uses the public key to encrypt a challenge (a coded message) to which the correct response must be given. Only the private key can decrypt this challenge and produce the correct response. For this reason, the private key should not be shared with those who you do not wish to give authorization.

The Host key management section displays the current public keys on the router and their date and timestamp. These public keys are provided in different formats, including DSA, RSA and ECDSA. Each format has advantages and disadvantages in terms of signature generation speed, validation speed and encryption/decryption speed. There are also compatibility concerns to consider with older clients when using ECDSA, for example.

### Host key management

Key type	Date
ssh_host_key	2013-09-05 10:19:45
ssh_host_dsa_key	2013-09-05 10:20:00
ssh_host_rsa_key	2013-09-05 10:20:02
ssh_host_ecdsa_key	2013-09-05 10:20:03

### Generating new keys

The complete set of keys can be re-generated by selecting the **Generate keys** button. This key generation process takes approximately 30 seconds to complete.

### Downloading keys

The **Get keys** button allows you to download the complete set of public and private keys while the **Get public keys** button will download only the set of public keys.

### Uploading your own key files

Click the Upload keys button to upload your own public key to the router.

## Client key management

The Client Key Management section is used for uploading the public key file of clients. To upload a client public key, click the **Upload** button, browse to the file and click **Open**.

### Client key management

Username	Hostname	Key type
----------	----------	----------

When the file is uploaded, it is examined for validity. If the key file is not a valid public key, it will not be uploaded.

## LED operation mode

The 7 front LED indicators may be turned off after a timeout period for aesthetic or power saving reasons. To access the LED Operation Mode page, click the **System** menu, then **Administration** on the left and finally select **LED Operation Mode**.

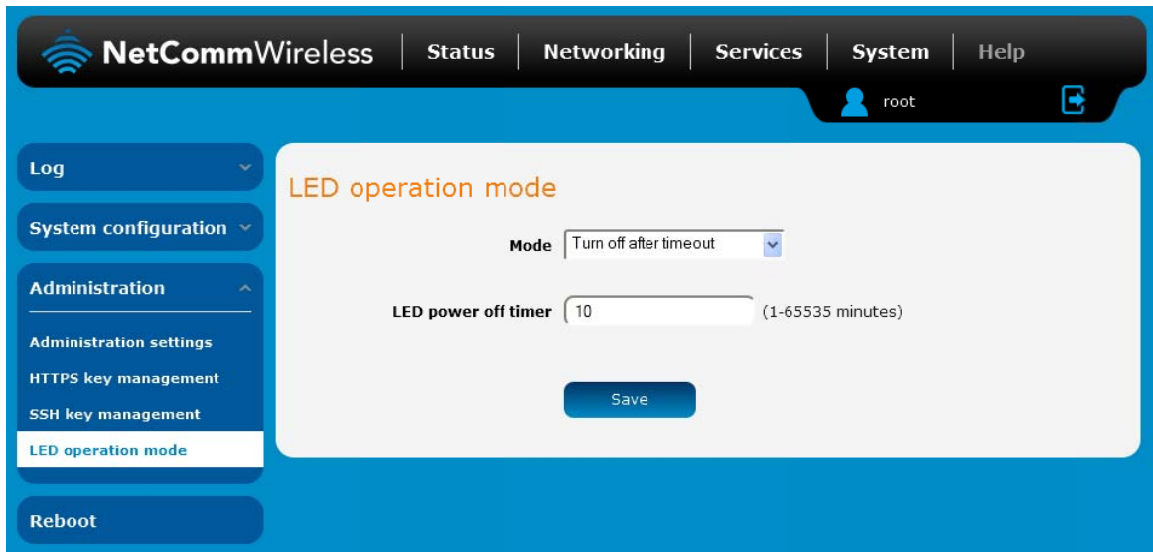

Figure 102 - LED Operation Mode

The **Mode** drop down list sets the operation mode of the LEDs on the front panel of the router. To set the lights to operate at all times, set this to **Always on**. To set the lights to turn off after a specified period, select **Turn off after timeout**. When configured to turn off after timeout, use the **LED power off timer** field to specify the time in minutes to wait before turning off the LED indicators. The LED Power Off Timer must be an integer between 1 and 65535.

The wait period begins from the time the **Save** button is clicked. When the wait period expires, the LEDs will turn off. If the router is rebooted, the LED power off timer is reset. The router will boot up and wait for the configured time before turning off again.

## Reboot

The reboot option in the System section performs a soft reboot of the router. This can be useful if you have made configuration changes you want to implement.

To reboot the router:

1. Click the **System** menu item from the top menu bar.
2. Click the **Reboot** button from the menu on the left side of the screen.

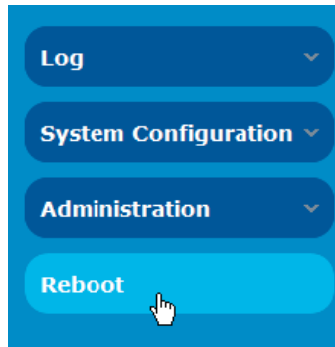

*Figure 103 - Reboot menu option*

3. The router displays a warning that you are about to perform a reboot. If you wish to proceed, click the **Reboot** button then click **OK** on the confirmation window which appears.

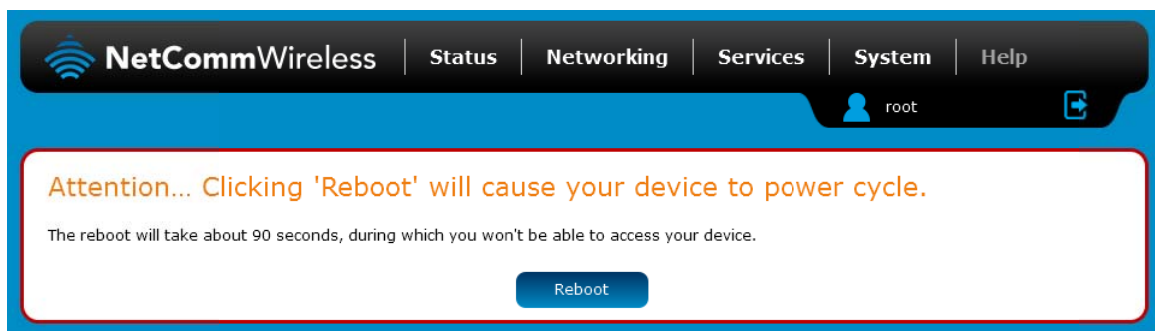

*Figure 104 - Reboot confirmation*



Note: It can take up to 2 minutes for the router to reboot.

## Logging out

To log out of the router, click the  icon at the top right corner of the web user interface.

# Appendix A: Tables

Table 1 - Document Revision History.....	3
Table 2 - Device Dimensions .....	8
Table 3 - LED Indicators.....	9
Table 4 - Signal strength LED descriptions .....	10
Table 5 – Interfaces .....	11
Table 6 - PoE power classes.....	18
Table 7 - Locking power block pin outs.....	19
Table 8 - Average power consumption figures.....	19
Table 9 - Management account login details .....	20
Table 10 - Status page item details .....	23
Table 11 - Data connection item details .....	25
Table 12 - Connect on demand - Connect and disconnect timers descriptions .....	30
Table 13 - Current MAC / IP / Port filtering rules in effect.....	50
Table 14 - IPSec Configuration Items .....	54
Table 15 - SMS Setup Settings .....	79
Table 16 - Inbox/Outbox icons.....	81
Table 17 - SMS Diagnostic Command Syntax.....	86
Table 18 - List of Valid SMS diagnostic commands .....	88
Table 19 - List of SMS diagnostics variables.....	89
Table 22 - SMS diagnostics example commands .....	91
Table 23 - System log detail levels .....	94
Table 24 - Administration configuration options .....	102
Table 25 - LAN Management Default Settings .....	115
Table 26 - Web Interface Default Settings .....	115
Table 27 - Telnet Access.....	115
Table 28 - RJ-45 connector pin outs.....	120

# Appendix B: Device Mounting Dimensions

The image below is at 100% scale and may be used as a template for mounting the device. All dimensions shown are in millimetres.

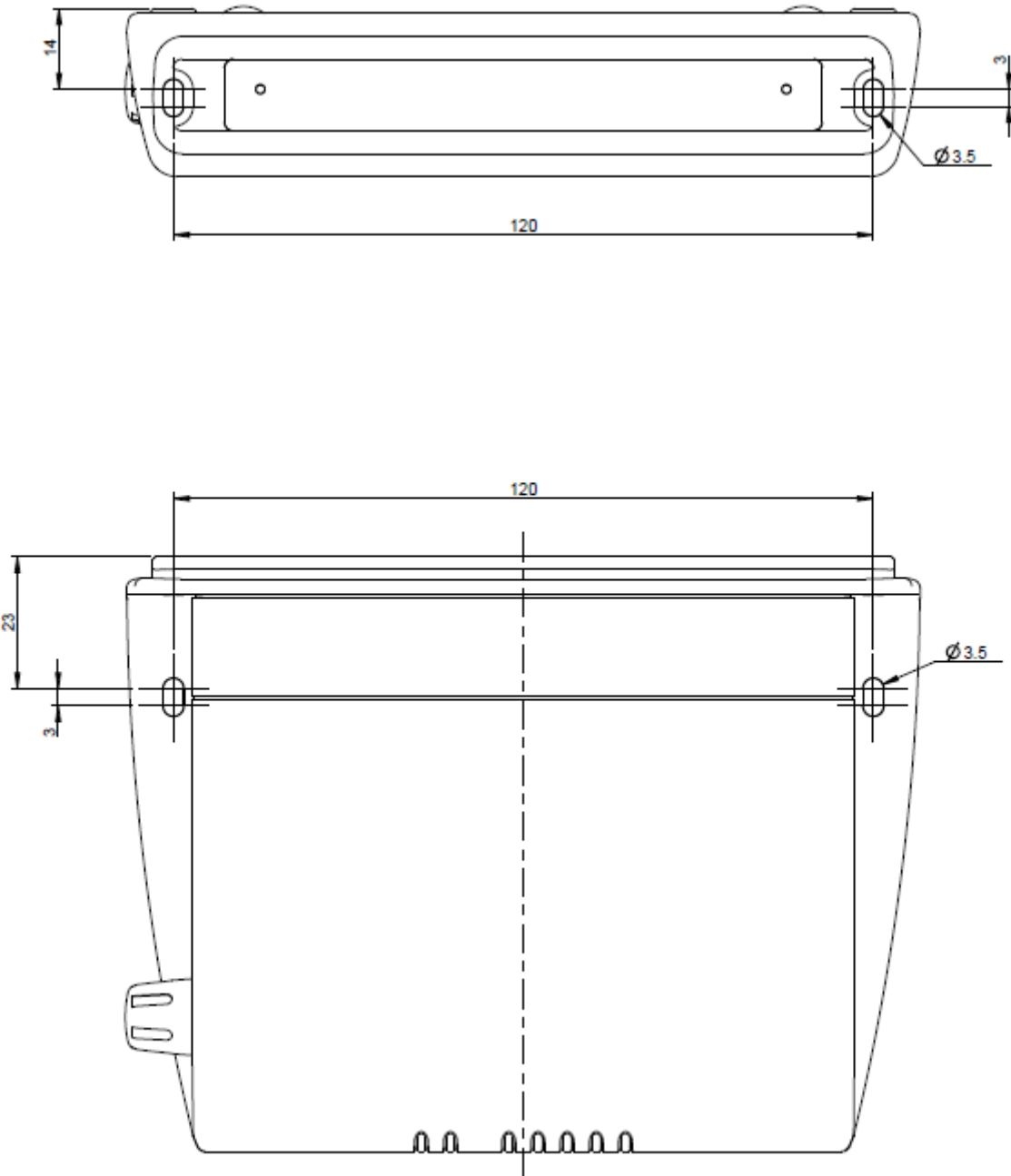

Figure 105 - Device mounting dimensions





# Appendix C: Mounting Bracket

The image below is at 100% scale and may be used as a template for mounting the bracket. All dimensions shown are in millimetres.

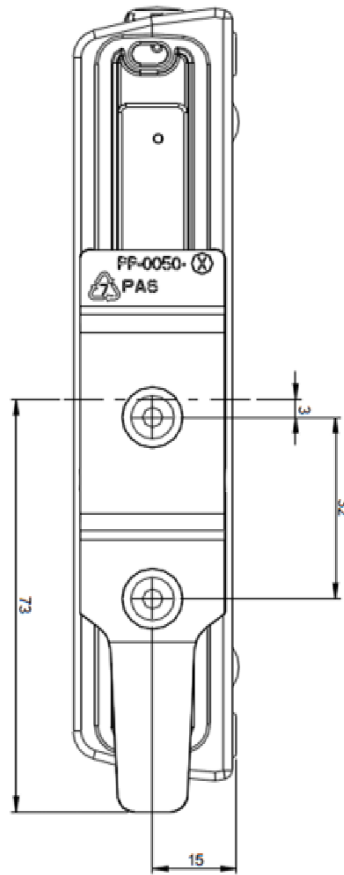

Figure 106 - Mounting bracket

# Appendix D: Default Settings

The following tables list the default settings for the 3G Light Industrial M2M router.

LAN (MANAGEMENT)	
Static IP Address:	192.168.1.1
Subnet Mask:	255.255.255.0
Default Gateway:	192.168.1.1

*Table 26 - LAN Management Default Settings*

ADMIN MANAGER ACCOUNT		ROOT MANAGER ACCOUNT	
Username:	admin	Username:	root
Password:	admin	Password:	admin

*Table 27 - Web Interface Default Settings*





Note: The admin manager account allows you to manage all settings of the router except functions such as firmware upgrade, device configuration backup and restore and reset to factory default settings, which are privileged only to the root manager account.

3G LIGHT INDUSTRIAL M2M ROUTER TELNET ACCESS	
Username:	root
Password:	admin



*Table 28 - Telnet Access*

## Restoring factory default settings

Restoring factory defaults will reset the 3G Light Industrial M2M router to its factory default configuration. You may encounter a situation where you need to restore the factory defaults on your 3G Light Industrial M2M router such as:

-  You have lost your username and password and are unable to login to the web configuration page;
-  You are asked to perform a factory reset by support staff.

There are two methods you can use to restore factory default settings on your 3G Light Industrial M2M router:

-  Using the web-based user interface
-  Using the reset button on the interface panel of the router

### Using the web-based user interface

To restore your router to its factory default settings, please follow these steps:

1. Open a browser window and navigate to the IP address of the router (default address is <http://192.168.1.1>). Login to the router using **root** as the User Name and **admin** as the password.
2. Click the **System** item from the top menu bar, then **System configuration** on the left menu and then click **Settings backup and restore**.
3. Under the **Restore factory defaults** section, click the **Restore Defaults** button. The router asks you to confirm that you wish to restore factory defaults. Click OK to continue. The router sets all settings to default. Click OK again to reboot the router.
4. When the Power light returns to a steady red, the reset is complete. The default settings are now restored.

### Using the reset button on the interface panel of the router

Use a pen to depress the Reset button on the device for 15-20 seconds. The router will restore the factory default settings and reboot.

When you have reset your 3G Light Industrial M2M router to its default settings you will be able to access the device's configuration web interface using <http://192.168.1.1> with username **admin** or **root** and password **admin**.

## Recovery mode

The 3G Light Industrial M2M router features two independent operating systems, each with its own file systems. These two systems are referred to as 'Main' and 'Recovery'. It is always possible to use one in order to restore the other in the event that one system becomes damaged or corrupted (such as during a firmware upgrade failure).

Both systems have Web interfaces that can be used to manipulate the other inactive system. The 3G Light Industrial M2M router starts up by default in the Main system mode, however the router may be triggered to start in recovery mode if desired.

To start the router in recovery mode:

1. Press and hold the physical reset button on the interface panel of the router for 5 to 15 seconds. When the LEDs on the front panel change to amber and countdown in a sequence, release the reset button. The router then boots into recovery mode.
2. In your browser, navigate to <http://192.168.1.1>. The router's recovery mode is hardcoded to use this address regardless of the IP address that was configured in the main system. The router's recovery console is displayed.

### NetComm NWL Series Cellular Router Recovery Console

Status	Log	Application Installer	Settings	Reboot
<b>Status</b>				
<b>System Information</b>				
System Up time	00:16:45			
Router Version	Hardware: A Software: V1.10.28.1			
Serial Number	163011125100035			
Trigger	button			
<b>LAN</b>				
IP	192.168.1.1 / 255.255.255.0			
MAC Address	00:60:64:9F:14:18			
<b>Ethernet Port Status</b>				
LAN: 	Up / 100.0 Mbps / FDX			

Figure 107 - Recovery console

The recovery console provides limited functionality. Basic status information is available, as well as access to the System log for troubleshooting. The Application Installer can be used to upload and install different firmware, allowing you to roll back to a previous firmware in the event that an upgrade fails. The Settings menu provides the ability to reset the router to factory default settings and the Reboot tab allows you to perform a soft reboot of the router.

# Appendix E: HTTPS - Uploading a self-signed certificate

If you have your own self-signed certificate or one purchased elsewhere and signed by a Certificate Authority, you can upload it to the 3G Light Industrial M2M Router using the [Upload](#) page.



Note: Your key and certificate files must be named `server.key` and `server.crt` respectively otherwise they will not work.

To upload your certificate:

1. Click on the **System** item from the top menu bar. From the side menu bar, select **System Configuration** and then **Upload**. The file upload screen is displayed.

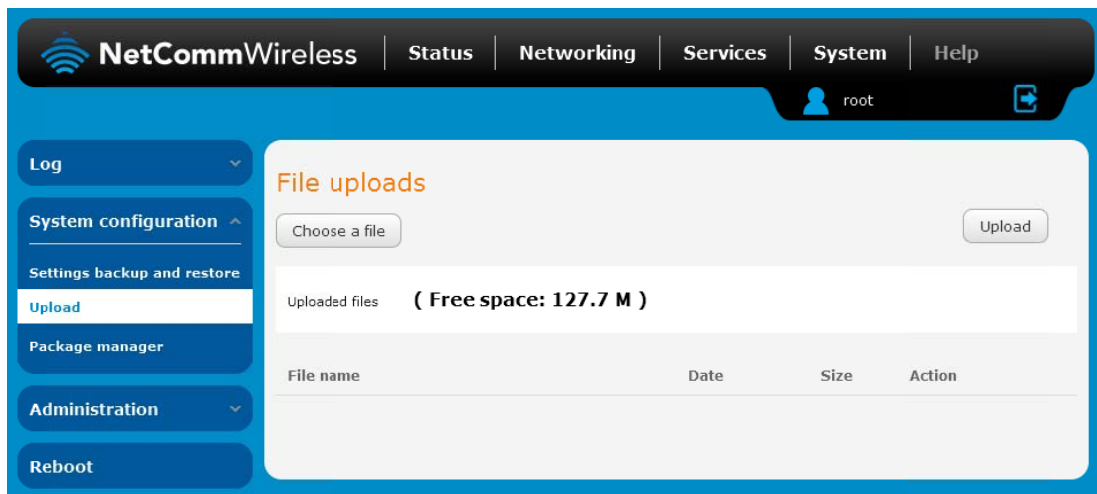

Figure 108 - Upload page

2. Click the **Choose a File** button and locate your server certificate file and click **Open**.

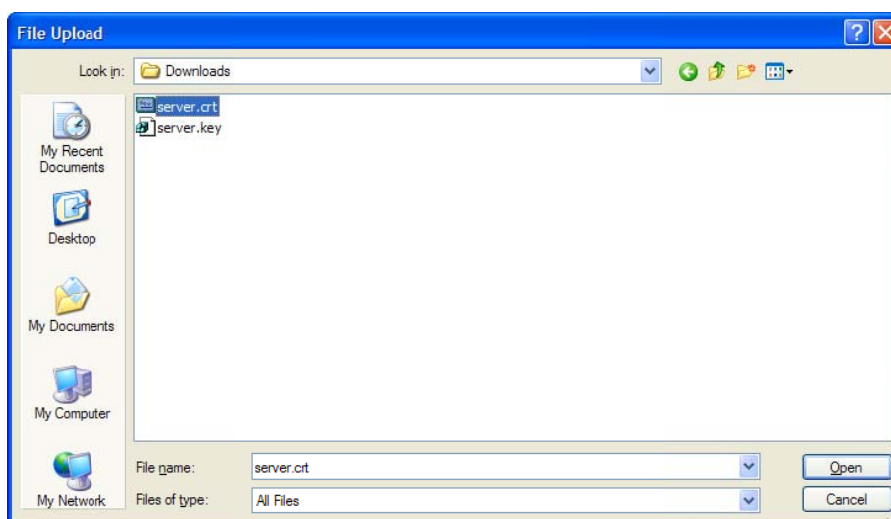

Figure 109 - Browse for server.crt

- Click the **Upload** button to begin uploading it to the router. The file appears in the list of files stored on the router.

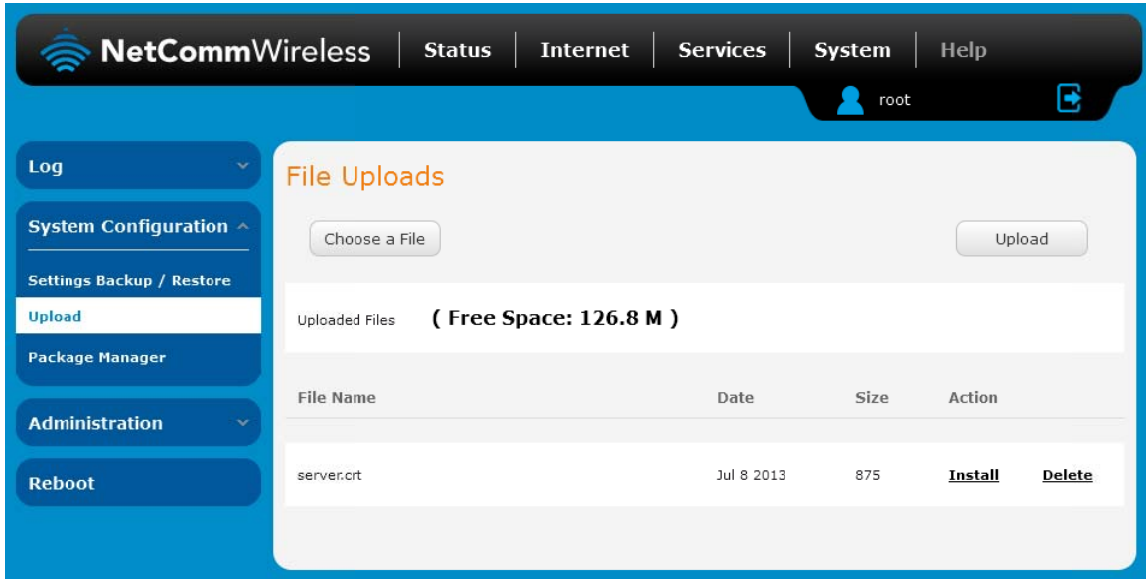

Figure 110 - Server certificate file uploaded

- Repeat steps 2 and 3 for the server key file.
- Click the **Install** link next to the server.crt file then click **OK** on the prompt that is displayed. The certificate file is installed. Repeat this for the key file. When each file is installed it is removed from the list of stored files.

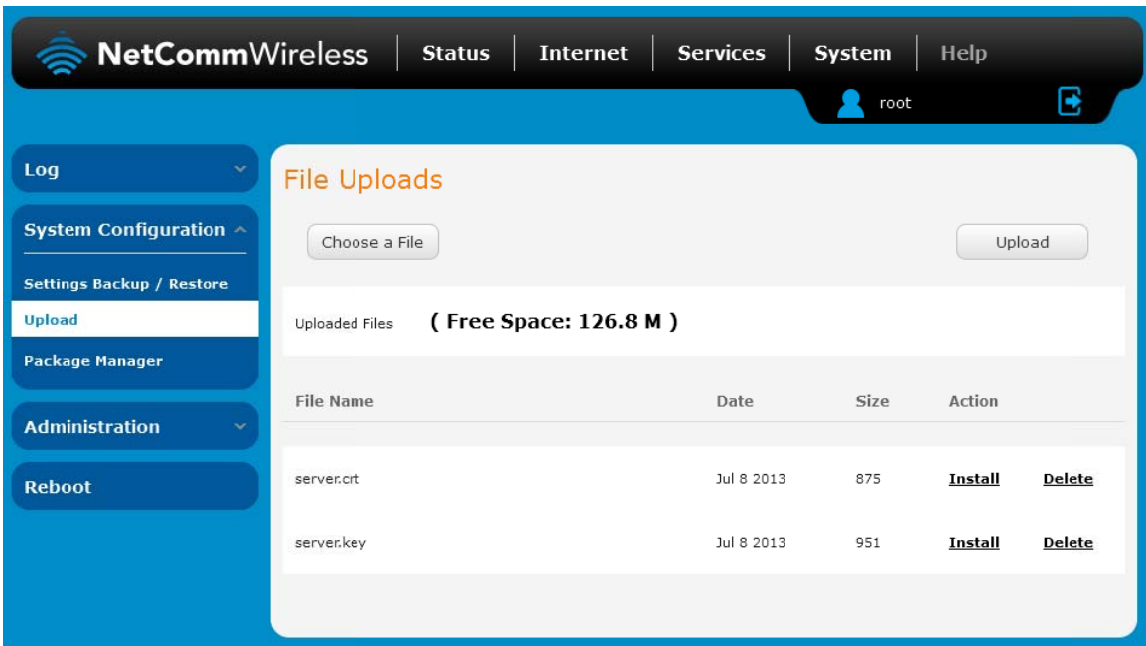

Figure 111 - Installing the server.crt file

# Appendix F: RJ-45 connector

The RJ-45 connector provides an interface for a data connection and for device input power using the pin layout shown below.



Pin: 8 1

*Figure 112 -The RJ-45 connector*

PIN	COLOUR	SIGNAL (802.3AF MODE A)	SIGNAL (802.3AF MODE B)
1	White/Orange stripe	Rx +	Rx + DC +
2	Orange Solid	Rx -	Rx - DC +
3	White/Green stripe	Tx +	Tx + DC -
4	Blue solid	DC +	unused
5	White/Blue stripe	DC +	unused
6	Green solid	Tx -	Tx - DC -
7	White/Brown stripe	DC -	unused
8	Brown solid	DC -	unused

*Table 29 - RJ-45 connector pin outs*



# Safety and product care

## RF Exposure

Your device contains a transmitter and a receiver. When it is on, it receives and transmits RF energy. When you communicate with your device, the system handling your connection controls the power level at which your device transmits.

This device meets the government's requirements for exposure to radio waves.

This device is designed and manufactured not to exceed the emission limits for exposure to radio frequency (RF) energy set by the Federal Communications Commission of the U.S. Government.

This device complies with FCC radiation exposure limits set forth for an uncontrolled environment. To ensure compliance with RF exposure guidelines the device must be used with a minimum of 20cm separation from the body. Failure to observe these instructions could result in your RF exposure exceeding the relevant guideline limits.

## External antenna

Any optional external antenna used for this transmitter must be installed to provide a separation distance of at least 20 cm from all persons and must not be co-located or operated in conjunction with any other antenna or transmitter. Please consult the health and safety guide of the chosen antenna for specific body separation guidelines as a greater distance of separation may be required for high-gain antennas.

Any external antenna gain must meet RF exposure and maximum radiated output power limits of the applicable rule section. The maximum antenna gain for this device as reported to the FCC is: 0.2 dBi (850MHz) and 2.7 dBi (1900MHz).

## CE Approval

This device has been tested to and conforms to the regulatory requirements of the European Union and attained CE Marking. The CE Mark is a conformity marking consisting of the letters "CE." The CE Mark applies to the products regulated by the central European health, safety and environmental protection legislation. The CE Mark is obligatory for products it applies to: the manufacturer affixes the marking in order to be allowed to sell their product in the European market.

The wireless device is approved to be used in the member states of the EU. NetComm Wireless declares that the wireless device is in compliance with the essential requirements and other relevant provisions of the Radio and Telecommunications Terminal Equipment Directive 1999/5/EC (R&TTE Directive). Compliance with this directive implies conformity to the following European Norms – N 60950 – Product Safety, EN 301 489 EMC, EN301511 GSM RF, EN301908 UMTS RF, EN 62311 SAR Technical requirement for radio equipment. A notified body has determined that this device has properly demonstrated that the requirements of the directive have been met and has issued a favourable certificate of expert opinion. As such the device will bear the notified body number 0682 after the CE mark.

The CE Marking is not a quality mark. Foremost, it refers to the safety rather than to the quality of the product. Secondly, CE Marking is mandatory for the product it applies to whereas most quality markings are voluntary.

Marking: The product shall bear the CE mark, the notified body number(s) as depicted to the right. CE0682.

This product has also passed the following certification standards –

CE SAR- EN62311/EN50385

CE RF – EN301511, EN301908-1/-2,

CE EMC – EN301489-1/-7/-24, EN55022/EN55024

CE Safety – EN60950

NOTE: It is highly recommended that the device must be kept at least 20cm away from the human body.

This is a regulatory requirement and applies to all 3G capable devices meeting standard regulatory compliance such as the compliance standards listed above.

## FCC Statement

### FCC compliance

Federal Communications Commission Notice (United States): Before a wireless device model is available for sale to the public, it must be tested and certified to the FCC that it does not exceed the limit established by the government-adopted requirement for safe exposure.

### FCC regulations

#### § 15.19 (a)(3)

This device complies with part 15 of the FCC Rules. Operation is subject to the following two conditions: (1) This device may not cause harmful interference, and (2) this device must accept any interference received, including interference that may cause undesired operation.

#### § 15.21

Changes or modifications not expressly approved by the party responsible for compliance could void the user's authority to operate the equipment.

.....

#### § 15.105 (b)

This equipment has been tested and found to comply with the limits for a Class B digital device, pursuant to part 15 of the FCC Rules. These limits are designed to provide reasonable protection against harmful interference in a residential installation. This equipment generates, uses and can radiate radio frequency energy and, if not installed and used in accordance with the instructions, may cause harmful interference to radio communications. However, there is no guarantee that interference will not occur in a particular installation. If this equipment does cause harmful interference to radio or television reception, which can be determined by turning the equipment off and on, the user is encouraged to try to correct the interference by one or more of the following measures:

- Reorient or relocate the receiving antenna.
- Increase the separation between the equipment and receiver.
- Connect the equipment into an outlet on a circuit different from that to which the receiver is connected.
- Consult the dealer or an experienced radio/TV technician for help.

### RF Exposure Information (MPE)

This equipment complies with radio frequency (RF) exposure limits adopted by the Federal Communications Commission for an uncontrolled environment. This equipment should be installed and operated with minimum distance 20 cm between the radiator & your body.

## IC Regulations:

### RSS-Gen 7.1.3

This device complies with Industry Canada license-exempt RSS standard(s). Operation is subject to the following two conditions:

- (1) this device may not cause interference, and
- (2) this device must accept any interference, including interference that may cause undesired operation of the device.

Le présent appareil est conforme aux CNR d'Industrie Canada applicables aux appareils radio exempts de licence. L'exploitation est autorisée aux deux conditions suivantes:

- (1) l'appareil ne doit pas produire de brouillage, et
- (2) l'utilisateur de l'appareil doit accepter tout brouillage radioélectrique subi, même si le brouillage est susceptible d'en compromettre le fonctionnement."

.....

### ICES-003

CAN ICES-3(B)/ NMB-3(B)

.....

### RSS-Gen 7.1.2

This radio transmitter has been approved by Industry Canada to operate with the antenna types listed below with the maximum permissible gain and required antenna impedance for each antenna type indicated. Antenna types not included in this list, having a gain greater than the maximum gain indicated for that type, are strictly prohibited for use with this device.

Antenna types: Dipole

Antenna gain: 850MHz: 0.2dBi; 1900MHz: 2.7dBi

\*\*\*\*\*

## IC RF Exposure Statement (MPE)

This equipment complies with IC RSS-102 RF exposure limits set forth for an uncontrolled environment. This equipment should be installed and operated with minimum distance **20 cm** between the radiator & your body.

## Electrical safety

### Accessories

Only use approved accessories.

Do not connect with incompatible products or accessories.

### Connection to a car

Seek professional advice when connecting a device interface to the vehicle electrical system.

## Distraction

### Operating machinery

Full attention must be given to operating the machinery in order to reduce the risk of an accident.

## Product handling

You alone are responsible for how you use your device and any consequences of its use.

You must always switch off your device wherever the use of a mobile phone is prohibited. Do not use the device without the clip-on covers attached, and do not remove or change the covers while using the device. Use of your device is subject to safety measures designed to protect users and their environment.

Always treat your device and its accessories with care and keep it in a clean and dust-free place.

Do not expose your device or its accessories to open flames or lit tobacco products.

Do not expose your device or its accessories to liquid, moisture or high humidity.

Do not drop, throw or try to bend your device or its accessories.

Do not use harsh chemicals, cleaning solvents, or aerosols to clean the device or its accessories.

Do not paint your device or its accessories.

Do not attempt to disassemble your device or its accessories, only authorised personnel must do so.

Do not use or install this product in extremely hot or cold areas. Ensure that the device is installed in an area where the temperature is within the supported operating temperature range (-20°C to 65°C)

Do not use your device in an enclosed environment or where heat dissipation is poor. Prolonged use in such space may cause excessive heat and raise ambient temperature, which will lead to automatic shutdown of your device or the disconnection of the mobile network connection for your safety. To use your device normally again after such shutdown, cool it in a well-ventilated place before turning it on.

Please check local regulations for disposal of electronic products.

Do not operate the device where ventilation is restricted

Installation and configuration should be performed by trained personnel only.

Do not use or install this product near water to avoid fire or shock hazard. Avoid exposing the equipment to rain or damp areas.

Arrange power and Ethernet cables in a manner such that they are not likely to be stepped on or have items placed on them.

Ensure that the voltage and rated current of the power source match the requirements of the device. Do not connect the device to an inappropriate power source.

### Small children

Do not leave your device and its accessories within the reach of small children or allow them to play with it.

They could hurt themselves or others, or could accidentally damage the device.

Your device contains small parts with sharp edges that may cause an injury or which could become detached and create a choking hazard.

## Emergency situations

This device, like any wireless device, operates using radio signals, which cannot guarantee connection in all conditions. Therefore, you must never rely solely on any wireless device for emergency communications.

## Device heating

Your device may become warm during normal use.

## Faulty and damaged products

Do not attempt to disassemble the device or its accessories.

Only qualified personnel must service or repair the device or its accessories.

If your device or its accessories have been submerged in water, punctured or subjected to a severe fall, do not use until they have been checked at an authorised service centre.

## Interference

Care must be taken when using the device in close proximity to personal medical devices, such as pacemakers and hearing aids.

### Pacemakers

Pacemaker manufacturers recommend that a minimum separation of 15cm be maintained between a device and a pacemaker to avoid potential interference with the pacemaker.

### Hearing aids

People with hearing aids or other cochlear implants may experience interfering noises when using wireless devices or when one is nearby.

The level of interference will depend on the type of hearing device and the distance from the interference source, increasing the separation between them may reduce the interference. You may also consult your hearing aid manufacturer to discuss alternatives.

### Medical devices

Please consult your doctor and the device manufacturer to determine if operation of your device may interfere with the operation of your medical device.

### Hospitals

Switch off your wireless device when requested to do so in hospitals, clinics or health care facilities. These requests are designed to prevent possible interference with sensitive medical equipment.

### Interference in cars

Please note that because of possible interference to electronic equipment, some vehicle manufacturers forbid the use of devices in their vehicles unless an external antenna is included in the installation.

## Explosive environments

### Petrol stations and explosive atmospheres

In locations with potentially explosive atmospheres, obey all posted signs to turn off wireless devices such as your device or other radio equipment.

Areas with potentially explosive atmospheres include fuelling areas, below decks on boats, fuel or chemical transfer or storage facilities, areas where the air contains chemicals or particles, such as grain, dust, or metal powders.

### Blasting caps and areas

Turn off your device or wireless device when in a blasting area or in areas posted turn off "two-way radios" or "electronic devices" to avoid interfering with blasting operations.