

## FCC Test Report

### (Part 27)

**Report No.:** RF160725C16-1

**FCC ID:** XIA-NRB51B

**Test Model:** NRB-51

**Received Date:** Jul. 25, 2016

**Test Date:** Aug. 01 ~ Aug. 22, 2016

**Issued Date:** Aug. 22, 2016

**Applicant:** NetComm Wireless Limited

**Address:** Level 2, 18-20 Orion Road, Lane Cove, NSW 2066, Sydney Australia

**Issued By:** Bureau Veritas Consumer Products Services (H.K.) Ltd., Taoyuan Branch

**Lab Address:** No. 47-2, 14th Ling, Chia Pau Vil., Lin Kou Dist., New Taipei City, Taiwan, R.O.C.

**Test Location:** No. 19, Hwa Ya 2nd Rd., Wen Hwa Vil., Kwei Shan Dist., Taoyuan City 33383, TAIWAN (R.O.C.)



This report is for your exclusive use. Any copying or replication of this report to or for any other person or entity, or use of our name or trademark, is permitted only with our prior written permission. This report sets forth our findings solely with respect to the test samples identified herein. The results set forth in this report are not indicative or representative of the quality or characteristics of the lot from which a test sample was taken or any similar or identical product unless specifically and expressly noted. Our report includes all of the tests requested by you and the results thereof based upon the information that you provided to us. You have 60 days from date of issuance of this report to notify us of any material error or omission caused by our negligence, provided, however, that such notice shall be in writing and shall specifically address the issue you wish to raise. A failure to raise such issue within the prescribed time shall constitute your unqualified acceptance of the completeness of this report, the tests conducted and the correctness of the report contents. Unless specific mention, the uncertainty of measurement has been explicitly taken into account to declare the compliance or non-compliance to the specification. The report must not be used by the client to claim product certification, approval, or endorsement by TAF or any government agency

## Table of Contents

<b>Release Control Record</b> .....	<b>3</b>
<b>1 Certificate of Conformity</b> .....	<b>4</b>
<b>2 Summary of Test Results</b> .....	<b>5</b>
2.1 Measurement Uncertainty.....	5
2.2 Test Site and Instruments.....	6
<b>3 General Information</b> .....	<b>7</b>
3.1 General Description of EUT.....	7
3.2 Configuration of System Under Test.....	8
3.2.1 Description of Support Units.....	8
3.3 Test Mode Applicability and Tested Channel Detail.....	9
3.4 EUT Operating Conditions.....	10
3.5 General Description of Applied Standards.....	10
<b>4 Test Types and Results</b> .....	<b>11</b>
4.1 Output Power Measurement.....	11
4.1.1 Limits of Output Power Measurement.....	11
4.1.2 Test Procedures.....	11
4.1.3 Test Setup.....	12
4.1.4 Test Results.....	13
4.2 Frequency Stability Measurement.....	18
4.2.1 Limits of Frequency Stability Measurement.....	18
4.2.2 Test Procedure.....	18
4.2.3 Test Setup.....	18
4.2.4 Test Results.....	19
4.3 Emission Bandwidth Measurement.....	20
4.3.1 Limits of Emission Bandwidth Measurement.....	20
4.3.2 Test Procedure.....	20
4.3.3 Test Setup.....	20
4.3.4 Test Result.....	21
4.4 Channel Edge Measurement.....	23
4.4.1 Limits of Band Edge Measurement.....	23
4.4.2 Test Setup.....	23
4.4.3 Test Procedures.....	23
4.4.4 Test Results.....	24
4.5 Peak to Average Ratio.....	26
4.5.1 Limits of Peak to Average Ratio Measurement.....	26
4.5.2 Test Setup.....	26
4.5.3 Test Procedures.....	26
4.5.4 Test Results.....	27
4.6 Conducted Spurious Emissions.....	29
4.6.1 Limits of Conducted Spurious Emissions Measurement.....	29
4.6.2 Test Setup.....	29
4.6.3 Test Procedure.....	29
4.6.4 Test Results.....	30
4.7 Radiated Emission Measurement.....	34
4.7.1 Limits of Radiated Emission Measurement.....	34
4.7.2 Test Procedure.....	34
4.7.3 Deviation from Test Standard.....	34
4.7.4 Test Setup.....	35
4.7.5 Test Results.....	36
<b>5 Pictures of Test Arrangements</b> .....	<b>41</b>
<b>Appendix – Information on the Testing Laboratories</b> .....	<b>42</b>



### Release Control Record

Issue No.	Description	Date Issued
RF160725C16-1	Original release	Aug. 22, 2016

## 1 Certificate of Conformity

**Product:** Outdoor LTE Router

**Brand:** Netcomm

**Test Model:** NRB-51

**Sample Status:** Engineering sample

**Applicant:** NetComm Wireless Limited

**Test Date:** Aug. 01 ~ Aug. 22, 2016

**Standards:** FCC Part 27, Subpart C, D

The above equipment has been tested by **Bureau Veritas Consumer Products Services (H.K.) Ltd., Taoyuan Branch**, and found compliance with the requirement of the above standards. The test record, data evaluation & Equipment Under Test (EUT) configurations represented herein are true and accurate accounts of the measurements of the sample's EMC characteristics under the conditions specified in this report.

**Prepared by :** Celine Chou , **Date:** Aug. 22, 2016  
Celine Chou / Specialist

**Approved by :** Jeremy Lin , **Date:** Aug. 22, 2016  
Jeremy Lin / Project Engineer

## 2 Summary of Test Results

Applied Standard: FCC Part 27 & Part 2			
FCC Clause	Test Item	Result	Remarks
2.1046 27.50(h)(2)	Equivalent Isotropically radiated power	Pass	Meet the requirement of limit.
2.1055 27.54	Frequency Stability Stay with the authorized bands of operation	Pass	Meet the requirement of limit.
2.1049 27.53(m)(6)	Emission Bandwidth	Pass	Meet the requirement of limit.
2.1051 27.53(a)(1)	Band Edge Measurements	Pass	Meet the requirement of limit.
27.50(a)(1)(B)	Peak To Average Ratio	Pass	Meet the requirement of limit.
2.1051 27.53(a)(1)	Conducted Spurious Emissions	Pass	Meet the requirement of limit.
2.1053 27.53(a)(1)	Radiated Spurious Emissions	Pass	Meet the requirement of limit. Minimum passing margin is -9.40dB at 30.00MHz.

### 2.1 Measurement Uncertainty

Where relevant, the following measurement uncertainty levels have been estimated for tests performed on the EUT as specified in CISPR 16-4-2:

Measurement	Frequency	Expanded Uncertainty (k=2) ( $\pm$ )
Radiated Emissions up to 1 GHz	30MHz ~ 200MHz	3.63 dB
	200MHz ~1000MHz	3.64 dB
Radiated Emissions above 1 GHz	1GHz ~ 18GHz	2.29 dB
	18GHz ~ 40GHz	2.29 dB

## 2.2 Test Site and Instruments

Description & Manufacturer	Model No.	Serial No.	Cal. Date	Cal. Due
Test Receiver ROHDE & SCHWARZ	ESCS30	100289	Dec. 23, 2015	Dec. 22, 2016
Spectrum Analyzer ROHDE & SCHWARZ	FSP40	100269	Apr. 19, 2016	Apr. 18, 2017
BILOG Antenna SCHWARZBECK	VULB9168	9168-148	Jan. 18, 2016	Jan. 17, 2017
HORN Antenna SCHWARZBECK	BBHA 9120 D	9120D-1169	Jan. 08, 2016	Jan. 07, 2017
HORN Antenna SCHWARZBECK	BBHA 9170	BBHA9170241	Jan. 18, 2016	Jan. 17, 2017
Preamplifier Agilent	8449B	3008A01911	Aug. 09, 2015	Aug. 08, 2016
			Aug. 09, 2016	Aug. 08, 2017
Preamplifier Agilent	8447D	2944A10638	Aug. 09, 2015	Aug. 08, 2016
			Aug. 09, 2016	Aug. 08, 2017
RF signal cable HUBER+SUHNER	SUCOFLEX 104	CABLE-CH9-02(309222 +248780)	Aug. 09, 2015	Aug. 08, 2016
			Aug. 09, 2016	Aug. 08, 2017
RF signal cable HUBER+SUHNER	SUCOFLEX 104	CABLE-CH9-03(274092)	Aug. 09, 2015	Aug. 08, 2016
			Aug. 09, 2016	Aug. 08, 2017
RF signal cable Woken	8D-FB	Cable-CH9-01	Aug. 11, 2015	Aug. 10, 2016
			Aug. 09, 2016	Aug. 08, 2017
Software BV ADT	ADT_Radiated_ V7.6.15.9.4	NA	NA	NA
Antenna Tower EMCO	2070/2080	512.835.4684	NA	NA
Turn Table EMCO	2087-2.03	NA	NA	NA
Antenna Tower & Turn BV ADT	AT100	AT93021705	NA	NA
Turn Table BV ADT	TT100	TT93021705	NA	NA
Turn Table Controller BV ADT	SC100	SC93021705	NA	NA
WIT Standard Temperature And Humidity Chamber	TH-4S-C	W981030	Jun. 08, 2016	Jun. 07, 2017
Mini-Circuits Power Splitter	ZN2PD-9G	NA	Jun. 09, 2016	Jun. 08, 2017
JFW 20dB attenuation	50HF-020-SMA	NA	NA	NA
AC Power Supply Exttech	CFW-105	E000603	NA	NA

- Note: 1. The calibration interval of the above test instruments is 12 months and the calibrations are traceable to NML/ROC and NIST/USA.  
 2. The test was performed in HwaYa Chamber 9.  
 3. The horn antenna and preamplifier (model: 8449B) are used only for the measurement of emission frequency above 1GHz if tested.  
 4. The FCC Site Registration No. is 215374.  
 5. The IC Site Registration No. is IC 7450F-9.

### 3 General Information

#### 3.1 General Description of EUT

Product	Outdoor LTE Router	
Brand	Netcomm	
Test Model	NRB-51	
Status of EUT	Engineering sample	
Power Supply Rating	48 Vdc (PoE)	
Modulation Type	QPSK, 16QAM	
Operating Frequency	LTE Band 30 (Channel Bandwidth 5MHz)	2307.5MHz ~ 2312.5MHz
	LTE Band 30 (Channel Bandwidth 10MHz)	2310MHz
Max. EIRP Power	Modulation Type: QPSK	
	LTE Band 30 (Channel Bandwidth 5MHz)	676.083mW (28.30dBm)
	LTE Band 30 (Channel Bandwidth 10MHz)	707.946mW (28.50dBm)
	Modulation Type: 16QAM	
	LTE Band 30 (Channel Bandwidth 5MHz)	524.807mW (27.20dBm)
	LTE Band 30 (Channel Bandwidth 10MHz)	575.440mW (27.60dBm)
Antenna Type	Directional antenna with 13dBi gain	
Antenna Connector	IPEX	
Accessory Device	NA	
Data Cable Supplied	NA	
Power Cord	NA	

Note: The EUT uses following PoE.

PoE (Support Unit)	
Brand	NetcommWireless
Model	POE-02
Input Power	100-240Vac~50/60Hz
Output Power	48Vdc, 15.4W

### 3.2 Configuration of System Under Test

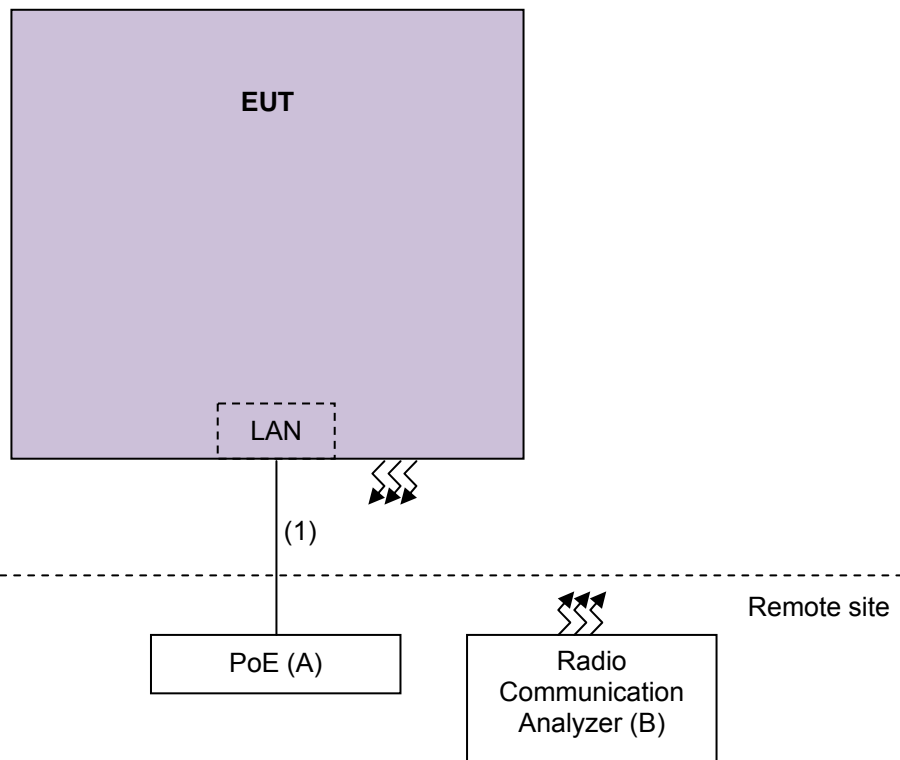

#### 3.2.1 Description of Support Units

The EUT has been tested as an independent unit together with other necessary accessories or support units. The following support units or accessories were used to form a representative test configuration during the tests.

ID	Product	Brand	Model No.	Serial No.	FCC ID	Remarks
A.	PoE	NetcommWireless	POE-02	NA	NA	Provided by manufacturer
B.	Radio Communication Analyzer	Anritsu	MT8820C	6201010284	NA	-

Note:

1. All power cords of the above support units are non-shielded (1.8m).
2. Item B acted as communication partner to transfer data.

ID	Descriptions	Qty.	Length (m)	Shielding (Yes/No)	Cores (Qty.)	Remarks
1.	RJ45 cable	1	10	N	0	-



### 3.3 Test Mode Applicability and Tested Channel Detail

Pre-Scan has been conducted to determine the worst-case mode from all possible combinations between available modulations, data rates and antenna ports

The worst case was found when positioned on Z-plane. Following channel(s) was (were) selected for the final test as listed below:

Test Item	Available Channel	Tested Channel	Channel Bandwidth	Modulation	Mode
Output Power	27685 to 27735	27685, 27710, 27735	5MHz	QPSK, 16QAM	1 RB / 0 RB Offset
	27710	27710	10MHz	QPSK, 16QAM	1 RB / 0 RB Offset
Frequency Stability	27685 to 27735	27710	5MHz	QPSK	1 RB / 0 RB Offset
Emission Bandwidth	27685 to 27735	27685, 27710, 27735	5MHz	QPSK, 16QAM	25 RB / 0 RB Offset
	27710	27710	10MHz	QPSK, 16QAM	50 RB / 0 RB Offset
Channel Edge	27685 to 27735	27685, 27735	5MHz	QPSK	25 RB / 0 RB Offset
	27710	27710	10MHz	QPSK	50 RB / 0 RB Offset
Peak to Average Ratio	27685 to 27735	27685, 27710, 27735	5MHz	QPSK	1 RB / 0 RB Offset
	27710	27710	10MHz	QPSK	1 RB / 0 RB Offset
Conducted Emission	27685 to 27735	27685, 27710, 27735	5MHz	QPSK	1 RB / 0 RB Offset
	27710	27710	10MHz	QPSK	1 RB / 0 RB Offset
Radiated Emission Below 1GHz	27685 to 27735	27685	5MHz	QPSK	1 RB / 0 RB Offset
	27710	27710	10MHz	QPSK	1 RB / 0 RB Offset
Radiated Emission Above 1GHz	27685 to 27735	27685, 27710, 27735	5MHz	QPSK	1 RB / 0 RB Offset
	27710	27710	10MHz	QPSK	1 RB / 0 RB Offset

**Note:**

1. For radiated emission below 1 GHz, the low, mid and high channels were pre-tested in chamber. The low channel was the worst case and chosen for final test.
2. The conducted output power for QPSK and 16QAM, measured value of QPSK is higher than 16QAM mode. Therefore, only Emission Bandwidth had been tested under QPSK and 16QAM modes, the others test items were performed under QPSK mode only.

**Test Condition:**

Test Item	Environmental Conditions	Input Power	Tested By
Output Power	24deg. C, 64%RH 20deg. C, 69%RH	48Vdc	Match Tsui Tank Wu
Frequency Stability	24deg. C, 64%RH	120Vac, 60Hz (System)	Match Tsui
Emission Bandwidth	24deg. C, 64%RH	48Vdc	Match Tsui
Channel Edge	24deg. C, 64%RH	48Vdc	Match Tsui
Conducted Emission	24deg. C, 64%RH	48Vdc	Match Tsui
Radiated Emission Below 1GHz	20deg. C, 69%RH	48Vdc	Tank Wu
Radiated Emission Above 1GHz	20deg. C, 69%RH	48Vdc	Tank Wu

### **3.4 EUT Operating Conditions**

The EUT makes a call to the communication simulator. The communication simulator station system controlled a EUT to export maximum output power under transmission mode and specific channel frequency

### **3.5 General Description of Applied Standards**

The EUT is a RF Product. According to the specifications of the manufacturer, it must comply with the requirements of the following standards:

**FCC 47 CFR Part 2**

**FCC 47 CFR Part 27**

**KDB 971168 D01 Power Meas License Digital Systems v02r02**

**ANSI/TIA/EIA-603-C 2004**

Note: All test items have been performed and recorded as per the above standards.

## 4 Test Types and Results

### 4.1 Output Power Measurement

#### 4.1.1 Limits of Output Power Measurement

Base and fixed stations are limited to 2000 watts e.i.r.p.w within any 5 megahertz of authorized for LTE Band 30.

#### 4.1.2 Test Procedures

##### **EIRP / ERP Measurement:**

- a. All measurements were done at low, middle and high operational frequency range. RWB and VBW is 5MHz for LTE.
- b. Substitution method is used for E.I.R.P measurement. In the semi-anechoic chamber, EUT placed on the 0.8m height of Turn Table, rotated the table around 360 degrees to search the maximum radiation power and receiver antenna shall be rotated vertical and horizontal polarization and moved height from 1m to 4m to find the maximum polar radiated power. The "Read Value" is the spectrum reading the maximum power value.
- c. The substitution horn antenna is substituted for EUT at the same position and signals generator export the CW signal to the substitution antenna via a tx cable. Rotated the Turn Table and moved receiving antenna to find the maximum radiation power. Adjust output power level of S.G to get a Value of spectrum reading equal to "Read Value" of step b. Record the power level of S.G
- d.  $EIRP = \text{Output power level of S.G} - \text{TX cable loss} + \text{Antenna gain of substitution horn.}$  E.R.P power can be calculated form E.I.R.P power by subtracting the gain of dipole,  $E.R.P \text{ power} = E.I.R.P \text{ power} - 2.15\text{dBi}$ .

##### **Conducted Power Measurement:**

A power sensor was used on the output port of the EUT. A power meter was used to read the response of the power sensor. Record the power level.

### 4.1.3 Test Setup

EIRP / ERP MEASUREMENT:

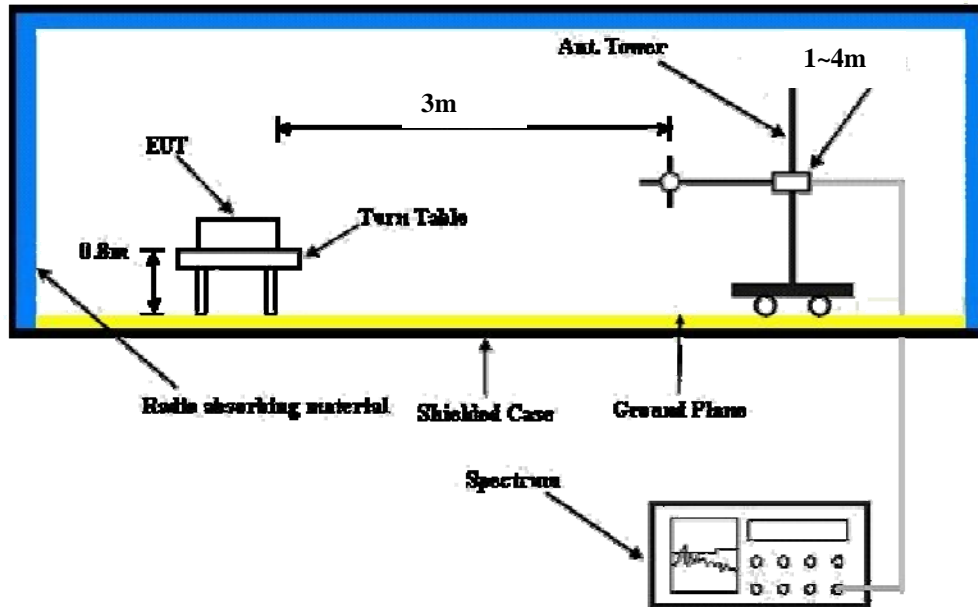

For the actual test configuration, please refer to the attached file (Test Setup Photo).

CONDUCTED POWER MEASUREMENT:



For the actual test configuration, please refer to the attached file (Test Setup Photo).

#### 4.1.4 Test Results

##### CONDUCTED OUTPUT POWER (dBm)

Band / BW	RB Size	RB Offset	QPSK			16QAM		
			Low CH 27685	Mid CH 27710	High CH 27735	Low CH 27685	Mid CH 27710	High CH 27735
			2307.5 MHz	2310 MHz	2312.5 MHz	2307.5 MHz	2310 MHz	2312.5 MHz
30 / 5M	1	0	18.28	18.52	<b>18.61</b>	17.43	17.56	<b>17.62</b>
	1	12	18.20	18.41	18.53	17.32	17.46	17.55
	1	24	18.11	18.34	18.42	17.25	17.41	17.49
	12	0	18.25	18.43	18.55	17.37	17.49	17.58
	12	6	18.13	18.31	18.46	17.31	17.40	17.45
	12	13	18.04	18.23	18.32	17.24	17.28	17.34
	25	0	17.56	17.64	17.77	16.87	16.94	17.00
Band / BW	RB Size	RB Offset	QPSK			16QAM		
			Mid CH 27710			Mid CH 27710		
			2310MHz			2310MHz		
30 / 10M	1	0	<b>18.55</b>			<b>17.41</b>		
	1	24	18.31			17.32		
	1	49	18.22			17.19		
	25	0	18.42			17.35		
	25	12	18.35			17.26		
	25	25	18.21			17.11		
	50	0	18.00			17.03		

EIRP Power (dBm)

**Modulation: QPSK**

Channel Bandwidth: 5MHz

MODE		TX channel 27685					
Antenna Polarity & Test Distance: Horizontal at 3 M							
No.	Freq. (MHz)	Reading (dBm)	S.G Power Value (dBm)	Correction Factor (dB)	EIRP (dBm)	Limit (dBm)	Margin (dB)
1	2307.50	-13.20	28.20	-0.10	28.10	63.00	-34.90
Antenna Polarity & Test Distance: Vertical at 3 M							
No.	Freq. (MHz)	Reading (dBm)	S.G Power Value (dBm)	Correction Factor (dB)	EIRP (dBm)	Limit (dBm)	Margin (dB)
1	2307.50	-16.30	26.80	-0.10	26.70	63.00	-36.30

MODE		TX channel 27710					
Antenna Polarity & Test Distance: Horizontal at 3 M							
No.	Freq. (MHz)	Reading (dBm)	S.G Power Value (dBm)	Correction Factor (dB)	EIRP (dBm)	Limit (dBm)	Margin (dB)
1	2310.00	-13.20	28.20	-0.10	28.10	63.00	-34.90
Antenna Polarity & Test Distance: Vertical at 3 M							
No.	Freq. (MHz)	Reading (dBm)	S.G Power Value (dBm)	Correction Factor (dB)	EIRP (dBm)	Limit (dBm)	Margin (dB)
1	2310.00	-16.20	26.90	-0.10	26.80	63.00	-36.20

MODE		TX channel 27735					
Antenna Polarity & Test Distance: Horizontal at 3 M							
No.	Freq. (MHz)	Reading (dBm)	S.G Power Value (dBm)	Correction Factor (dB)	EIRP (dBm)	Limit (dBm)	Margin (dB)
1	2312.50	-13.00	28.40	-0.10	<b>28.30</b>	63.00	-34.70
Antenna Polarity & Test Distance: Vertical at 3 M							
No.	Freq. (MHz)	Reading (dBm)	S.G Power Value (dBm)	Correction Factor (dB)	EIRP (dBm)	Limit (dBm)	Margin (dB)
1	2312.50	-15.90	27.20	-0.10	27.10	63.00	-35.90

NOTE: EIRP (dBm) = S.G Power Value (dBm) + Correction Factor (dB).

Channel Bandwidth: 10MHz

MODE		TX channel 27710					
Antenna Polarity & Test Distance: Horizontal at 3 M							
No.	Freq. (MHz)	Reading (dBm)	S.G Power Value (dBm)	Correction Factor (dB)	EIRP (dBm)	Limit (dBm)	Margin (dB)
1	2310.00	-12.80	28.60	-0.10	<b>28.50</b>	63.00	-34.50
Antenna Polarity & Test Distance: Vertical at 3 M							
No.	Freq. (MHz)	Reading (dBm)	S.G Power Value (dBm)	Correction Factor (dB)	EIRP (dBm)	Limit (dBm)	Margin (dB)
1	2310.00	-16.10	27.00	-0.10	26.90	63.00	-36.10

NOTE: EIRP (dBm) = S.G Power Value (dBm) + Correction Factor (dB).

**Modulation: 16QAM**

Channel Bandwidth: 5MHz

MODE		TX channel 27685					
Antenna Polarity & Test Distance: Horizontal at 3 M							
No.	Freq. (MHz)	Reading (dBm)	S.G Power Value (dBm)	Correction Factor (dB)	EIRP (dBm)	Limit (dBm)	Margin (dB)
1	2307.50	-14.10	27.30	-0.10	27.20	63.00	-35.80
Antenna Polarity & Test Distance: Vertical at 3 M							
No.	Freq. (MHz)	Reading (dBm)	S.G Power Value (dBm)	Correction Factor (dB)	EIRP (dBm)	Limit (dBm)	Margin (dB)
1	2307.50	-17.20	25.90	-0.10	25.80	63.00	-37.20

MODE		TX channel 27710					
Antenna Polarity & Test Distance: Horizontal at 3 M							
No.	Freq. (MHz)	Reading (dBm)	S.G Power Value (dBm)	Correction Factor (dB)	EIRP (dBm)	Limit (dBm)	Margin (dB)
1	2310.00	-14.30	27.10	-0.10	27.00	63.00	-36.00
Antenna Polarity & Test Distance: Vertical at 3 M							
No.	Freq. (MHz)	Reading (dBm)	S.G Power Value (dBm)	Correction Factor (dB)	EIRP (dBm)	Limit (dBm)	Margin (dB)
1	2310.00	-16.20	26.90	-0.10	26.80	63.00	-36.20

MODE		TX channel 27735					
Antenna Polarity & Test Distance: Horizontal at 3 M							
No.	Freq. (MHz)	Reading (dBm)	S.G Power Value (dBm)	Correction Factor (dB)	EIRP (dBm)	Limit (dBm)	Margin (dB)
1	2312.50	-14.10	27.30	-0.10	27.20	63.00	-35.80
Antenna Polarity & Test Distance: Vertical at 3 M							
No.	Freq. (MHz)	Reading (dBm)	S.G Power Value (dBm)	Correction Factor (dB)	EIRP (dBm)	Limit (dBm)	Margin (dB)
1	2312.50	-17.00	26.10	-0.10	26.00	63.00	-37.00

NOTE: EIRP (dBm) = S.G Power Value (dBm) + Correction Factor (dB).



Channel Bandwidth: 10MHz

MODE		TX channel 27710					
Antenna Polarity & Test Distance: Horizontal at 3 M							
No.	Freq. (MHz)	Reading (dBm)	S.G Power Value (dBm)	Correction Factor (dB)	EIRP (dBm)	Limit (dBm)	Margin (dB)
1	2310.00	-13.70	27.70	-0.10	27.60	63.00	-35.40
Antenna Polarity & Test Distance: Vertical at 3 M							
No.	Freq. (MHz)	Reading (dBm)	S.G Power Value (dBm)	Correction Factor (dB)	EIRP (dBm)	Limit (dBm)	Margin (dB)
1	2310.00	-17.20	25.90	-0.10	25.80	63.00	-37.20

NOTE: EIRP (dBm) = S.G Power Value (dBm) + Correction Factor (dB).

## 4.2 Frequency Stability Measurement

### 4.2.1 Limits of Frequency Stability Measurement

According to the FCC part 2.1055 shall be tested the frequency stability. The rule is defined that "The frequency stability shall be sufficient to ensure that the fundamental emission stays within the authorized frequency block." The test extreme voltage is according to the 2.1055(d)(1) Vary primary supply voltage from 85 to 115 percent of the nominal value for other than hand carried battery equipment and the extreme temperature rule is comply with specification of EUT  $-30^{\circ}\text{C} \sim 50^{\circ}\text{C}$ .

### 4.2.2 Test Procedure

- Device is placed at the oven room. The oven room could control the temperatures and humidity. Power warm up is at least 15 min and power applied should perform before recording frequency error.
- EUT is connected the external power supply to control the DC input power. The test voltage range is from minimum to maximum working voltage. Each step shall be record the frequency error rate.
- The temperature range step is 10 degrees in this test items. All temperature levels shall be hold the  $\pm 0.5^{\circ}\text{C}$  during the measurement testing. The each temperature step shall be at least 0.5 hours, consider the EUT could be test under the stability condition.

Note: The frequency error was recorded frequency error from the communication simulator.

### 4.2.3 Test Setup

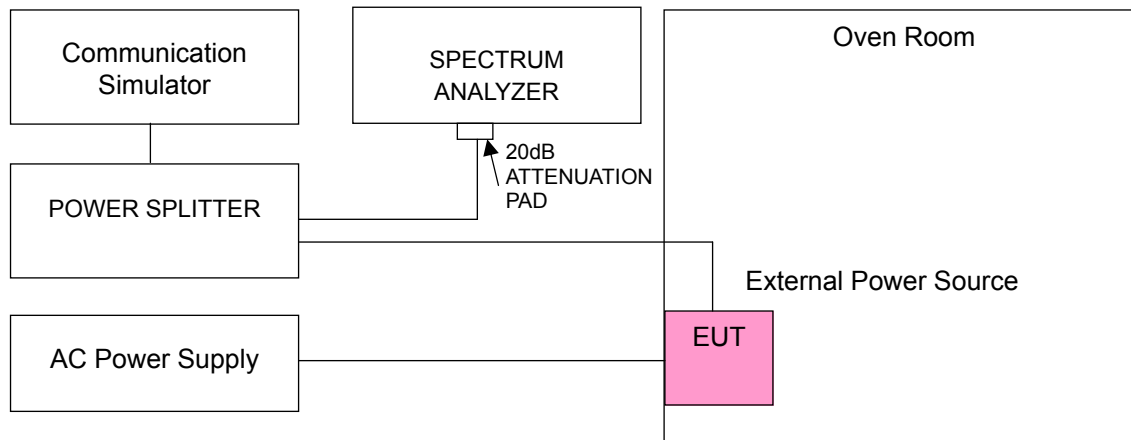

#### 4.2.4 Test Results

##### Frequency Error vs. Voltage

Voltage (Volts)	Frequency Error (ppm)	Limit (ppm)
138	-0.007	2.5
120	-0.005	2.5
102	-0.006	2.5

Note: The applicant defined the normal working voltage is from 102Vac to 138Vac.

##### Frequency Error vs. Temperature.

Temp. (°C)	Frequency Error (ppm)	Limit (ppm)
60	-0.010	2.5
50	-0.010	2.5
40	-0.009	2.5
30	-0.007	2.5
20	-0.005	2.5
10	-0.004	2.5
0	-0.008	2.5
-10	-0.010	2.5
-20	-0.013	2.5

### 4.3 Emission Bandwidth Measurement

#### 4.3.1 Limits of Emission Bandwidth Measurement

According to FCC 27.53(m)(6) specified that emission bandwidth is defined as the width of the signal between two points, one below the carrier center frequency and one above the carrier center frequency, outside of which all emissions are attenuated at least 26dB below the transmitter power.

#### 4.3.2 Test Procedure

The transmitter output was connected to the spectrum analyzer through an attenuator. The bandwidth of the fundamental frequency was measured by spectrum analyzer with RBW = 51kHz and VBW = 150kHz (Channel Bandwidth: 5MHz), RBW = 100kHz and VBW = 300kHz (Channel Bandwidth: 10MHz). The 26dB bandwidth is defined as the total spectrum the power of which is higher than peak power minus 26dB.

#### 4.3.3 Test Setup

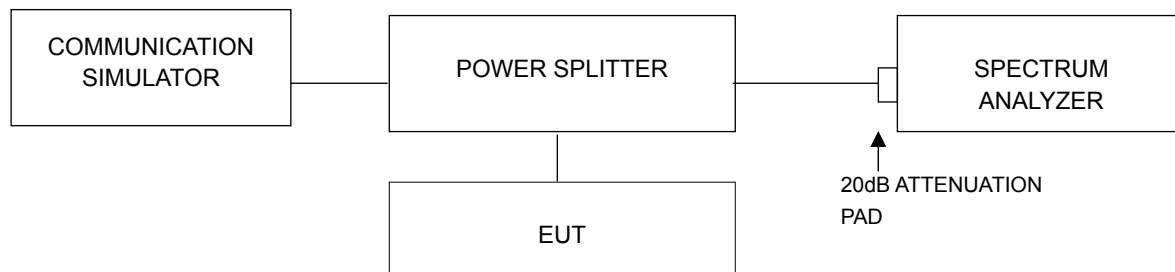

### 4.3.4 Test Result

Channel Bandwidth: 5MHz					
Channel	Frequency (MHz)	-26dBc Bandwidth (MHz)		Occupied Bandwidth (MHz)	
		QPSK	16QAM	QPSK	16QAM
27685	2307.5	4.97	4.98	4.47	4.48
27710	2310.0	4.94	4.97	4.45	4.47
27735	2312.5	4.98	4.97	4.47	4.47

### SPECTRUM PLOT OF WORST VALUE

#### -26dBc Bandwidth

##### QPSK

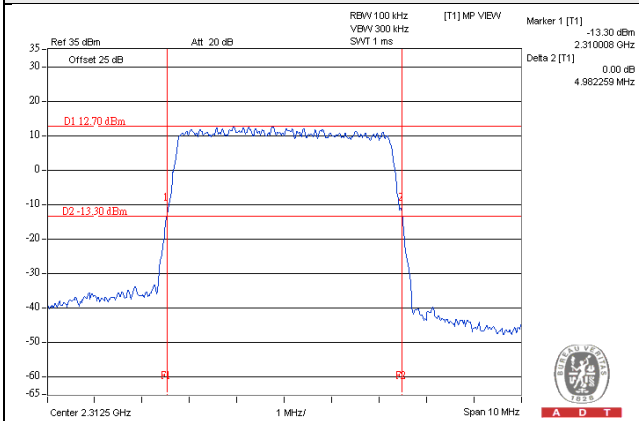

##### 16QAM

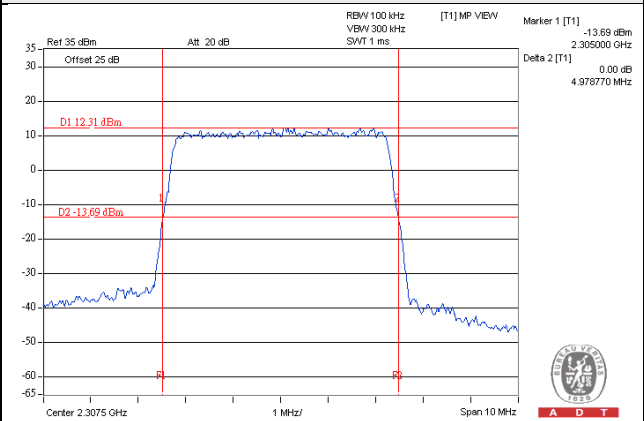

#### Occupied Bandwidth

##### QPSK

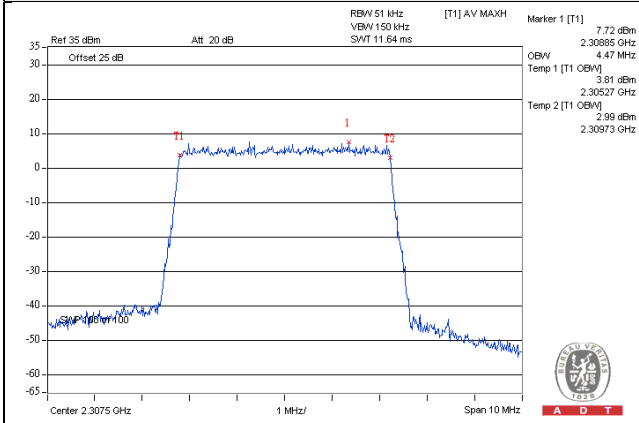

##### 16QAM

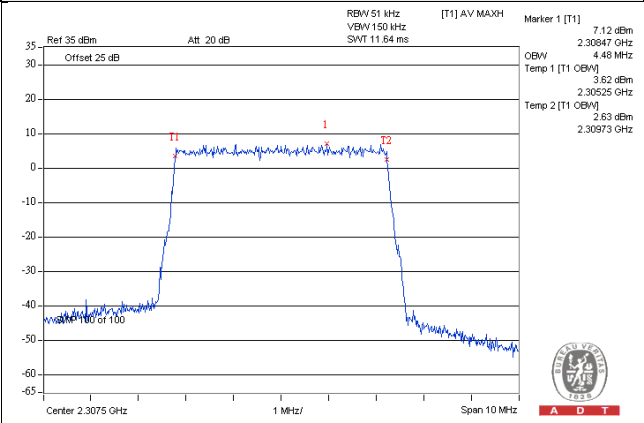

Channel Bandwidth: 10MHz					
Channel	Frequency (MHz)	-26dBc Bandwidth (MHz)		Occupied Bandwidth (MHz)	
		QPSK	16QAM	QPSK	16QAM
27710	2310.0	9.84	9.71	8.90	8.93

**SPECTRUM PLOT OF WORST VALUE**  
-26dBc Bandwidth

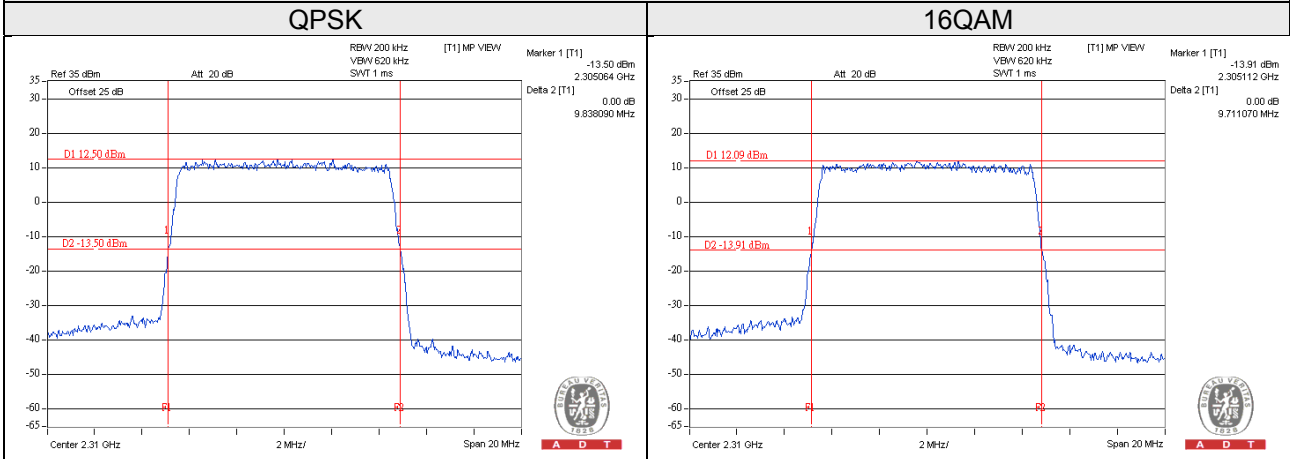

**Occupied Bandwidth**

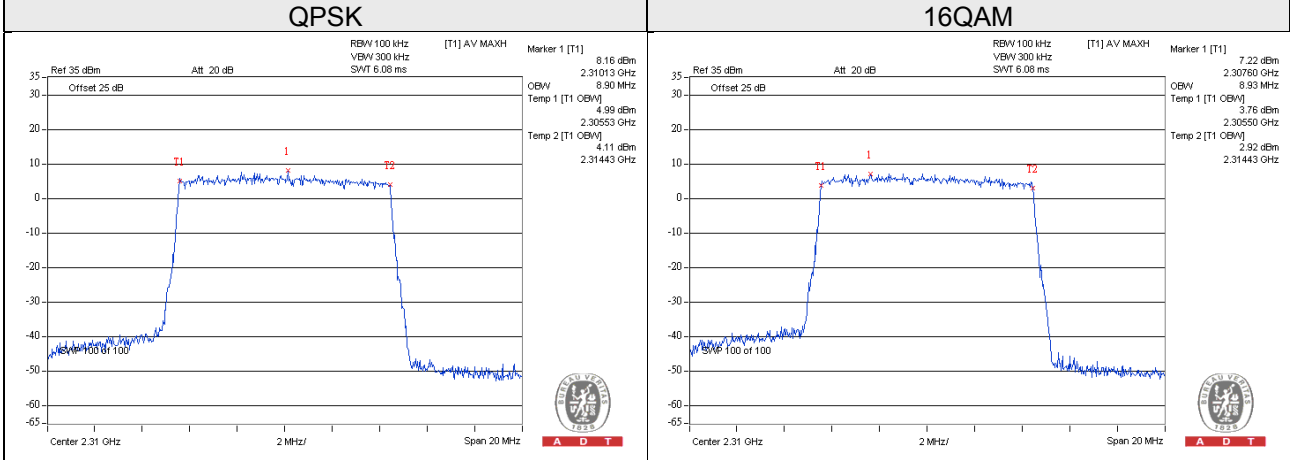

## 4.4 Channel Edge Measurement

### 4.4.1 Limits of Band Edge Measurement

- (1) For base and fixed stations' operations in the 2305-2320 MHz band and the 2345-2360 MHz band:
  - (i) By a factor of not less than  $43 + 10 \log (P)$  dB on all frequencies between 2305 and 2320 MHz and on all frequencies between 2345 and 2360 MHz that are outside the licensed band(s) of operation, and not less than  $75 + 10 \log (P)$  dB on all frequencies between 2320 and 2345 MHz;
  - (ii) By a factor of not less than  $43 + 10 \log (P)$  dB on all frequencies between 2300 and 2305 MHz,  $70 + 10 \log (P)$  dB on all frequencies between 2287.5 and 2300 MHz,  $72 + 10 \log (P)$  dB on all frequencies between 2285 and 2287.5 MHz, and  $75 + 10 \log (P)$  dB below 2285 MHz;
  - (iii) By a factor of not less than  $43 + 10 \log (P)$  dB on all frequencies between 2360 and 2362.5 MHz,  $55 + 10 \log (P)$  dB on all frequencies between 2362.5 and 2365 MHz,  $70 + 10 \log (P)$  dB on all frequencies between 2365 and 2367.5 MHz,  $72 + 10 \log (P)$  dB on all frequencies between 2367.5 and 2370 MHz, and  $75 + 10 \log (P)$  dB above 2370 MHz.
- (2) Measurement procedure. Compliance with these rules is based on the use of measurement instrumentation employing a resolution bandwidth of 1 MHz or greater. However, in the 1 MHz bands immediately outside and adjacent to the channel blocks at 2305, 2310, 2315, 2320, 2345, 2350, 2355, and 2360 MHz, a resolution bandwidth of at least 1 percent of the emission bandwidth of the fundamental emission of the transmitter may be employed. A narrower resolution bandwidth is permitted in all cases to improve measurement accuracy provided the measured power is integrated over the full required measurement bandwidth (i.e., 1 MHz). The emission bandwidth is defined as the width of the signal between two points, one below the carrier center frequency and one above the carrier center frequency, outside of which all emissions are attenuated at least 26 dB below the transmitter power.

### 4.4.2 Test Setup

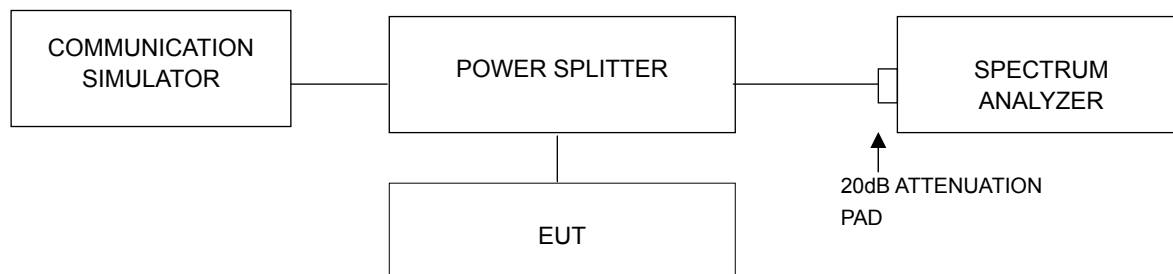

### 4.4.3 Test Procedures

- a. The EUT was set up for the rated peak power. The power was measured with Spectrum Analyzer. All measurements were done at 2 channels for the 5MHz: low and high operational frequency range and 1 channel for the 10MHz: middle operational frequency range.
- b. The center frequency of spectrum is the band edge frequency. RBW = 1MHz and VBW = 3MHz.
- c. Record the max trace plot into the test report.

#### 4.4.4 Test Results

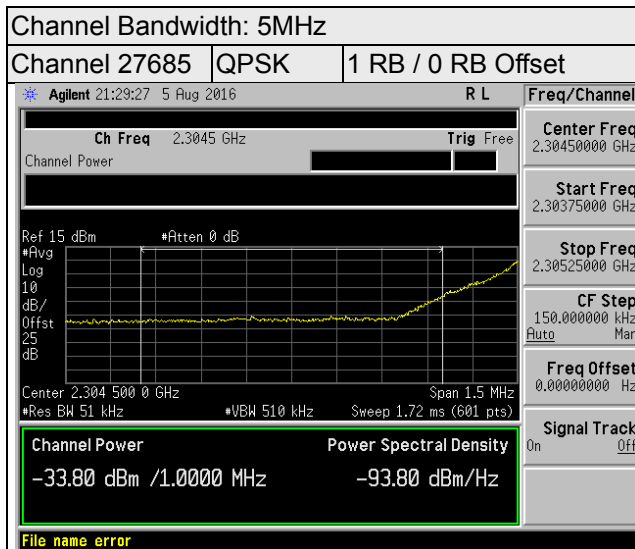
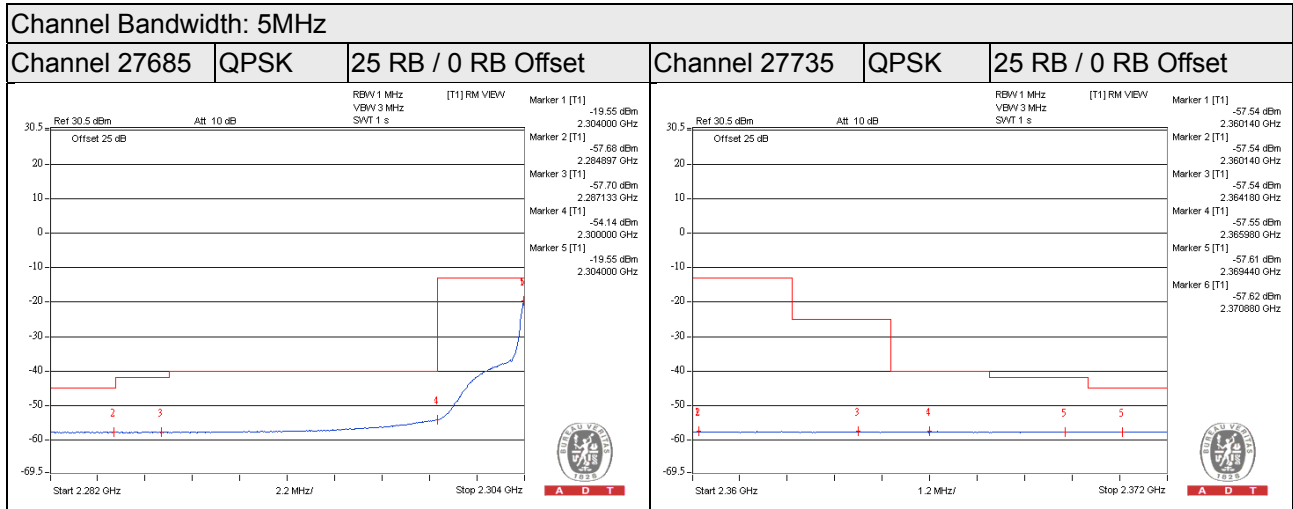

Note: Refer to item 4.4.1(2) measurement procedure.



Channel Bandwidth: 10MHz

Channel 27710

QPSK

50 RB / 0 RB Offset

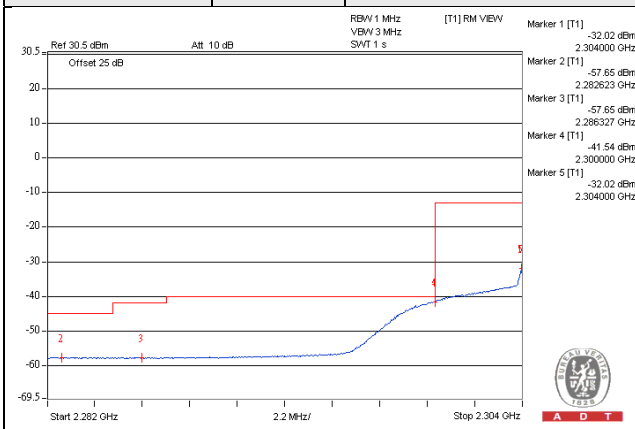

Channel 27710

QPSK

50 RB / 0 RB Offset

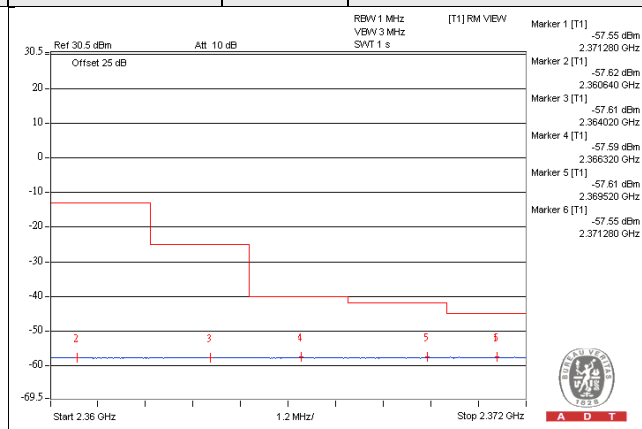

Channel Bandwidth: 10MHz

Channel 27710

QPSK

1 RB / 0 RB Offset

Agilent 21:59:46 5 Aug 2016 R L

Ch Freq 2.3045 GHz Trig Free

Channel Power

Ref 15 dBm #Atten 10 dB

#Avg Log 10 dB/Offset 25 dB

Center 2.304500 GHz Span 1.5 MHz

#Res BW 100 kHz #VBW 1 MHz Sweep 1 ms (601 pts)

Channel Power: -43.51 dBm /1.0000 MHz

Power Spectral Density: -103.51 dBm/Hz

Center Freq: 2.30450000 GHz

Start Freq: 2.30375000 GHz

Stop Freq: 2.30525000 GHz

CF Step: 150.000000 kHz

Freq Offset: 0.00000000 Hz

Signal Track: On

Copyright 2000-2012 Agilent Technologies

Note: Refer to item 4.4.1(2) measurement procedure.

## 4.5 Peak to Average Ratio

### 4.5.1 Limits of Peak to Average Ratio Measurement

In measuring transmissions in this band using an average power technique, the peak to-average ratio (PAR) of the transmission may not exceed 13 dB

### 4.5.2 Test Setup

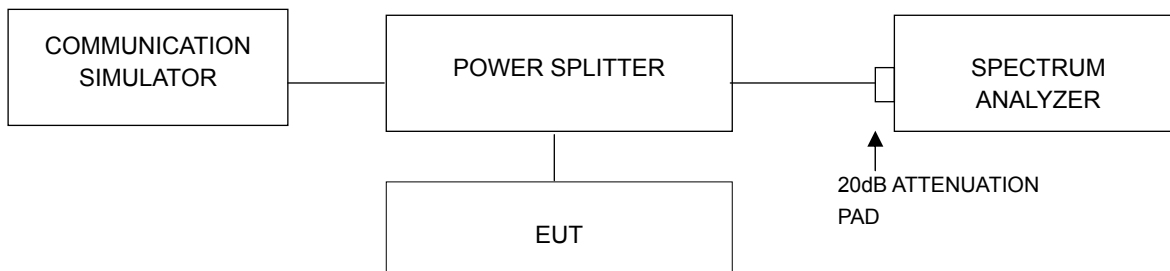

### 4.5.3 Test Procedures

- Set resolution/measurement bandwidth  $\geq$  signal's occupied bandwidth;
- Set the number of counts to a value that stabilizes the measured CCDF curve;
- Record the maximum PAPR level associated with a probability of 0.1%.

#### 4.5.4 Test Results

Channel Bandwidth: 5MHz			
Channel	Frequency (MHz)	Peak To Average Ratio (dB)	
		QPSK	16QAM
27685	2307.5	4.45	4.68
27710	2310.0	4.53	4.74
27735	2312.5	4.22	4.43

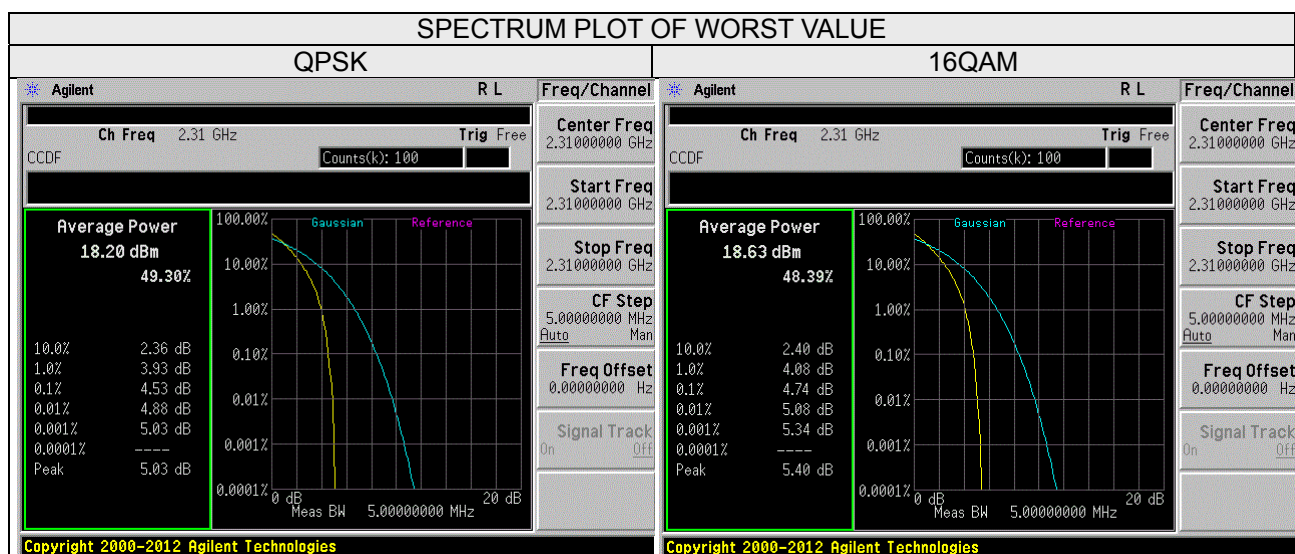

Channel Bandwidth: 10MHz			
Channel	Frequency (MHz)	Peak To Average Ratio (dB)	
		QPSK	16QAM
27710	2310.0	4.34	4.57

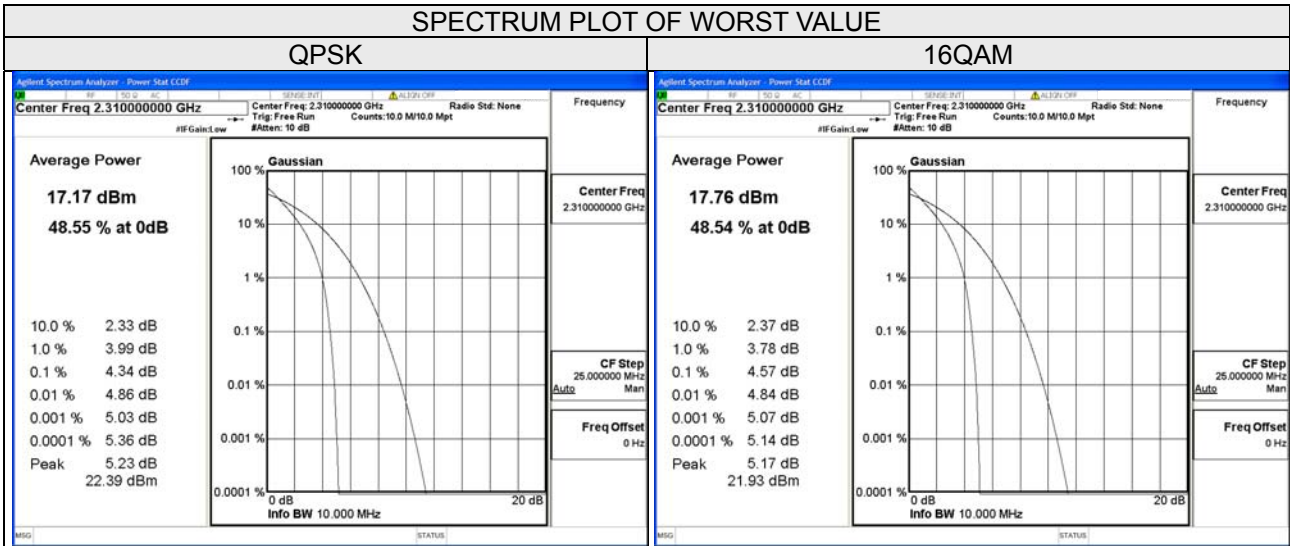

## 4.6 Conducted Spurious Emissions

### 4.6.1 Limits of Conducted Spurious Emissions Measurement

In the FCC 27.53(a)(1), On any frequency outside a licensee's frequency block, the power of any emission shall be attenuated below the transmitter power (P) by at least  $75 + 10 \log (P)$  dB. The emission limit equal to  $-45\text{dBm}$ .

### 4.6.2 Test Setup

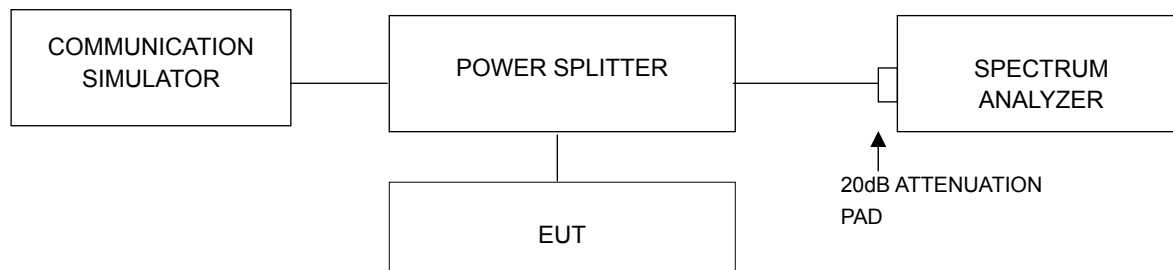

### 4.6.3 Test Procedure

- All measurements were done at 3 channels: low, middle and high operational frequency range.
- When the spectrum scanned from 9kHz to 20GHz, it shall be connected to the 20dB pad attenuated the carried frequency. The spectrum set  $RB = 1\text{MHz}$ ,  $VB = 3\text{MHz}$ .

### 4.6.4 Test Results

Channel Bandwidth: 5MHz

Channel 27685

Frequency Range : 9kHz~3GHz      Frequency Range : 3GHz~10GHz

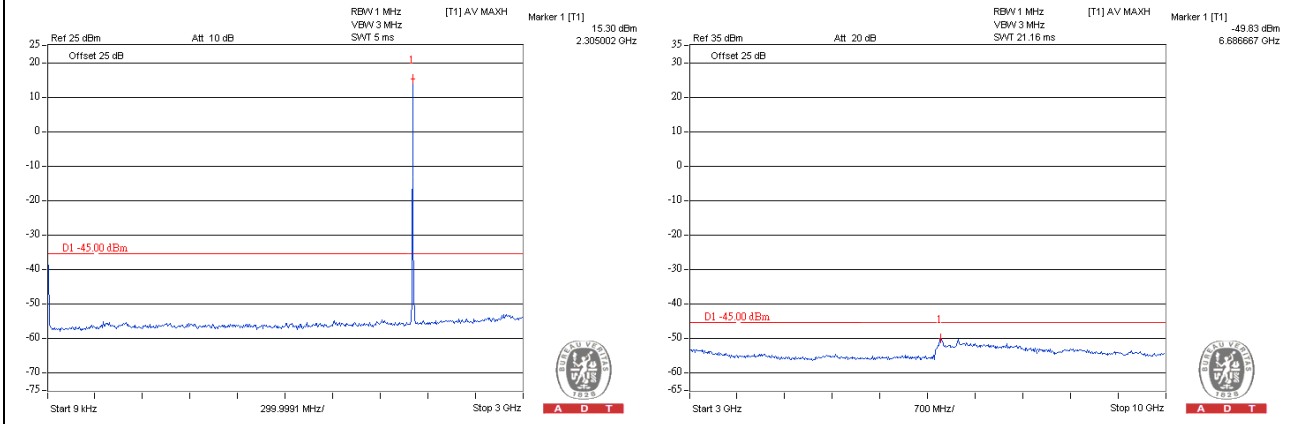

Frequency Range : 10GHz~20GHz

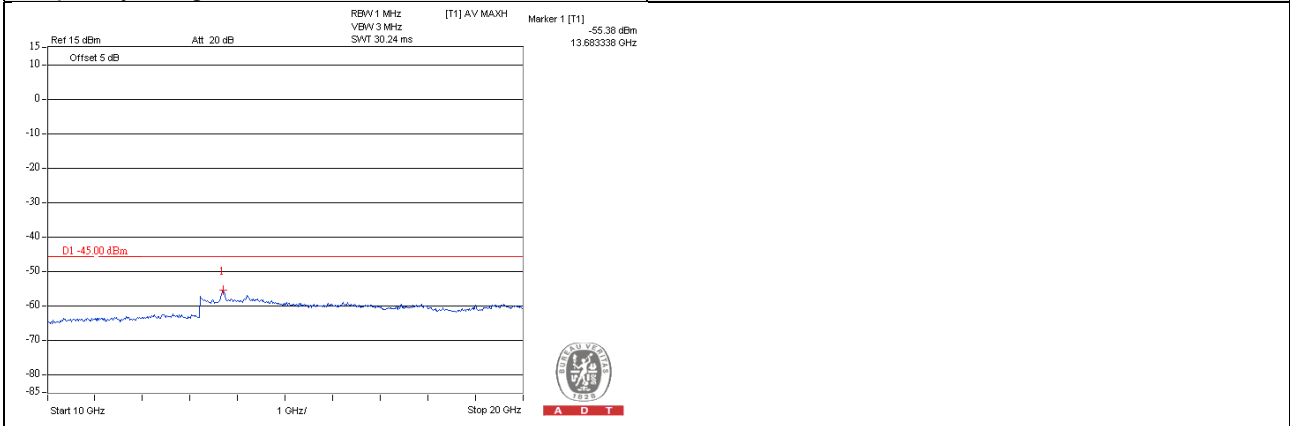

Channel Bandwidth: 5MHz

Channel 27710

Frequency Range : 9kHz~3GHz

Frequency Range : 3GHz~10GHz

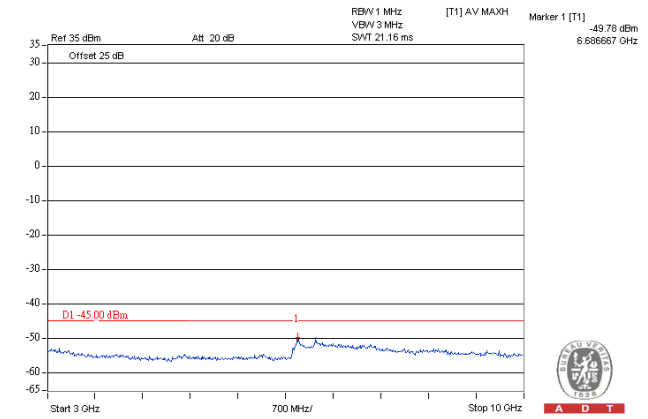
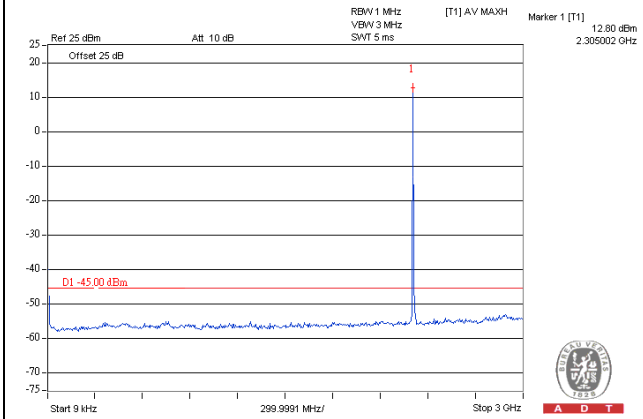

Frequency Range : 10GHz~20GHz

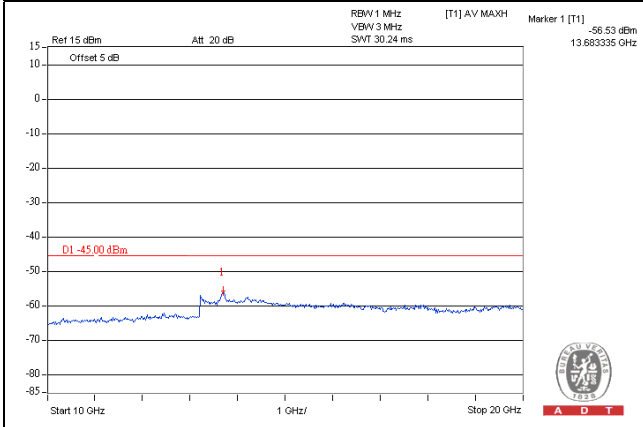

Channel Bandwidth: 5MHz

Channel 27735

Frequency Range : 9kHz~3GHz

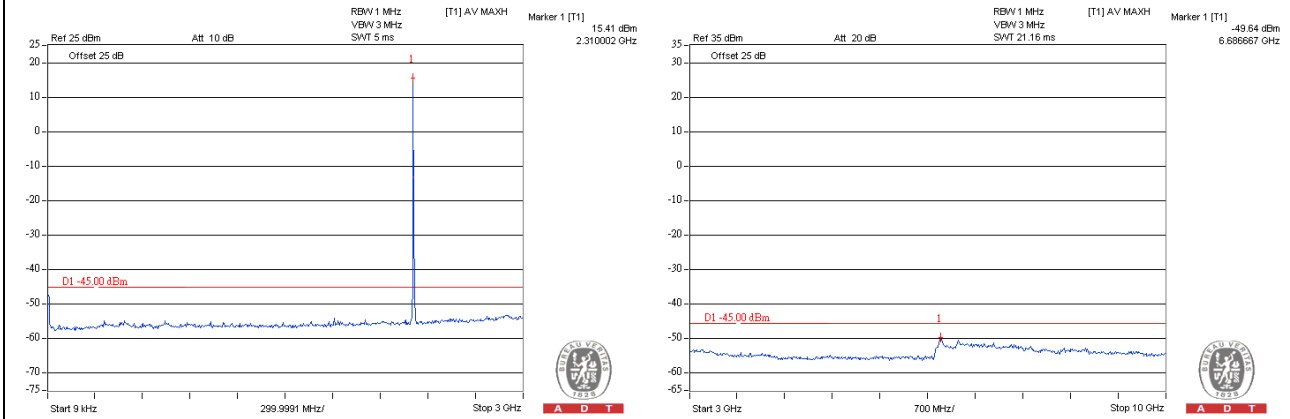

Frequency Range : 10GHz~20GHz

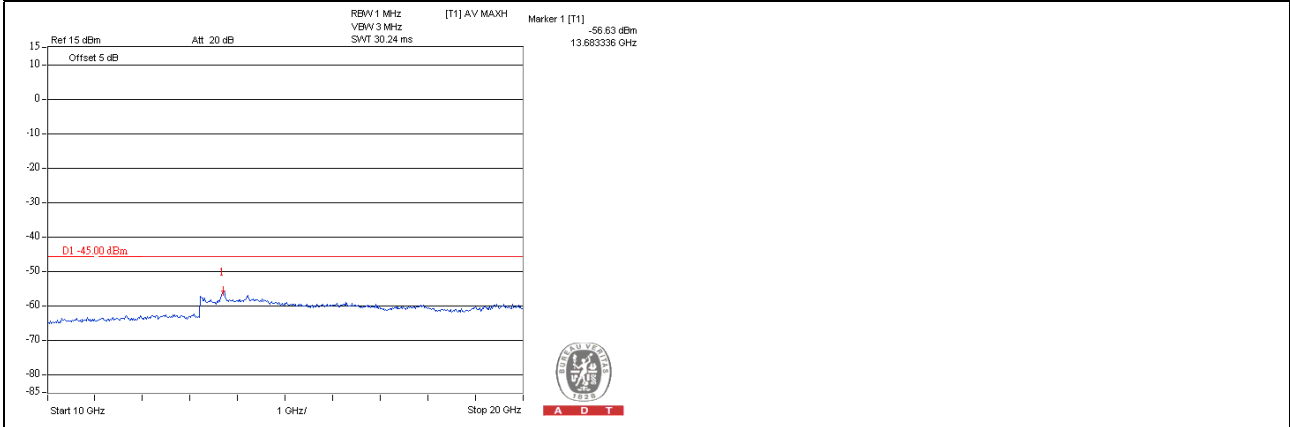



Channel Bandwidth: 10MHz

Channel 27710

Frequency Range : 9kHz~3GHz

Frequency Range : 3GHz~10GHz

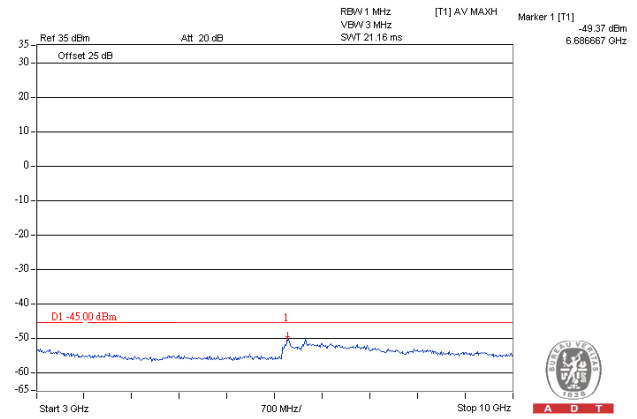
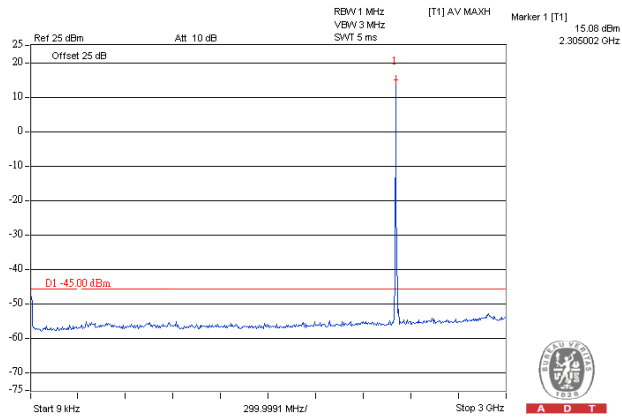

Frequency Range : 10GHz~20GHz

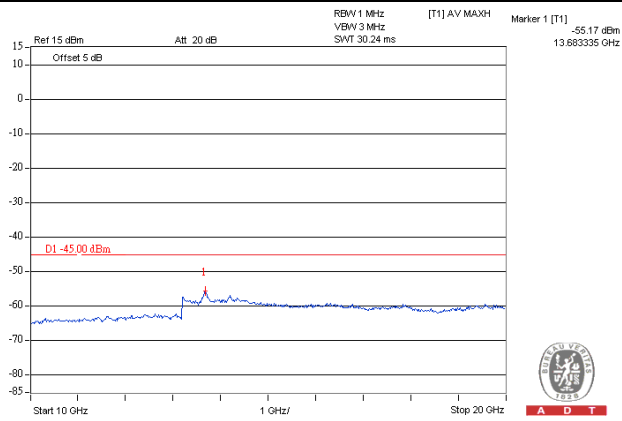

## 4.7 Radiated Emission Measurement

### 4.7.1 Limits of Radiated Emission Measurement

In the FCC 27.53(a) (1), On any frequency outside a licensee's frequency block, The power of any emission shall be attenuated below the transmitter power (P) by at least  $75 + 10 \log (P)$  dB. The emission limit equal to  $-45\text{dBm}$ .

### 4.7.2 Test Procedure

- a. The power was measured with R&S Spectrum Analyzer. All measurements were done at 3 channels (low, middle and high channel of operational frequency range.)
- b. Substitution method is used for E.I.R.P measurement. In the semi-anechoic chamber, EUT placed on the 0.8m height of Turn Table, rotated the table around 360 degrees to search the maximum radiation power and receiver antenna shall be rotated vertical and horizontal polarization and moved height from 1m to 4m to find the maximum polar radiated power. The "Read Value" is the spectrum reading the maximum power value.
- c. The substitution antenna is substituted for EUT at the same position and signals generator export the CW signal to the substitution antenna via a TX cable. Rotated the Turn Table and moved receiving antenna to find the maximum radiation power. Adjust output power level of S.G to get a Value of spectrum reading equal to "Read Value" of step b. Record the power level of S.G
- d.  $\text{EIRP} = \text{Output power level of S.G} - \text{TX cable loss} + \text{Antenna gain of substitution antenna}$ .

Note: The resolution bandwidth and video bandwidth of test receiver/spectrum analyzer is 1MHz/3MHz.

### 4.7.3 Deviation from Test Standard

No deviation.

#### 4.7.4 Test Setup

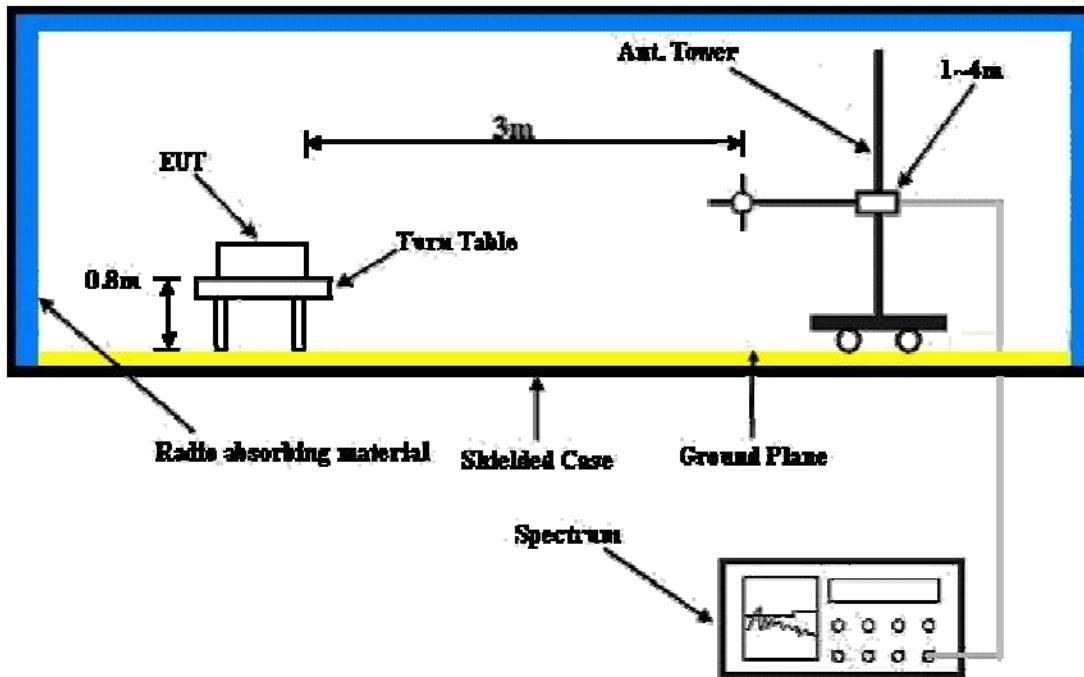

For the actual test configuration, please refer to the attached file (Test Setup Photo).

#### 4.7.5 Test Results

Below 1GHz

Channel Bandwidth: 5MHz

Mode	TX channel 27685	Frequency Range	Below 1000 MHz
Environmental Conditions	20deg. C, 69%RH	Input Power	48Vdc
Tested By	Tank Wu		

Antenna Polarity & Test Distance: Horizontal at 3 M							
No.	Freq. (MHz)	Reading (dBm)	S.G Power Value (dBm)	Correction Factor (dB)	EIRP (dBm)	Limit (dBm)	Margin (dB)
1	30.00	-63.60	-40.20	-19.40	-59.60	-45.00	-14.60
2	90.14	-52.50	-60.30	-0.20	-60.50	-45.00	-15.50
3	313.24	-60.40	-68.50	4.00	-64.50	-45.00	-19.50
4	383.08	-68.70	-73.30	3.50	-69.80	-45.00	-24.80
5	846.74	-71.10	-68.00	3.40	-64.60	-45.00	-19.60
6	974.78	-72.20	-66.90	3.60	-63.30	-45.00	-18.30
Antenna Polarity & Test Distance: Vertical at 3 M							
No.	Freq. (MHz)	Reading (dBm)	S.G Power Value (dBm)	Correction Factor (dB)	EIRP (dBm)	Limit (dBm)	Margin (dB)
1	30.00	-46.20	-36.70	-19.40	-56.10	-45.00	-11.10
2	92.08	-55.90	-62.20	-0.60	-62.80	-45.00	-17.80
3	196.84	-62.30	-60.70	-2.50	-63.20	-45.00	-18.20
4	313.24	-64.50	-68.60	4.00	-64.60	-45.00	-19.60
5	385.02	-68.20	-72.10	3.50	-68.60	-45.00	-23.60
6	992.24	-71.50	-65.00	3.40	-61.60	-45.00	-16.60

Remarks:

1. Output Power (dBm) = S.G Value (dBm) + Correction Factor (dB).
2. Correction Factor (dB) = Substitution Antenna Gain (dB) + Cable Loss (dB).

Channel Bandwidth: 10MHz

Mode	TX channel 27710	Frequency Range	Below 1000 MHz
Environmental Conditions	20deg. C, 69%RH	Input Power	48Vdc
Tested By	Tank Wu		

**Antenna Polarity & Test Distance: Horizontal at 3 M**

No.	Freq. (MHz)	Reading (dBm)	S.G Power Value (dBm)	Correction Factor (dB)	EIRP (dBm)	Limit (dBm)	Margin (dB)
<b>1</b>	<b>30.00</b>	<b>-58.40</b>	<b>-35.00</b>	<b>-19.40</b>	<b>-54.40</b>	<b>-45.00</b>	<b>-9.40</b>
2	90.14	-52.80	-60.60	-0.20	-60.80	-45.00	-15.80
3	307.42	-60.80	-69.00	3.90	-65.10	-45.00	-20.10
4	402.48	-69.80	-73.80	3.30	-70.50	-45.00	-25.50
5	897.18	-70.90	-66.90	3.50	-63.40	-45.00	-18.40
6	976.72	-71.80	-66.60	3.60	-63.00	-45.00	-18.00

**Antenna Polarity & Test Distance: Vertical at 3 M**

No.	Freq. (MHz)	Reading (dBm)	S.G Power Value (dBm)	Correction Factor (dB)	EIRP (dBm)	Limit (dBm)	Margin (dB)
1	30.00	-50.50	-41.00	-19.40	-60.40	-45.00	-15.40
2	90.14	-57.20	-63.30	-0.20	-63.50	-45.00	-18.50
3	196.84	-64.00	-62.40	-2.50	-64.90	-45.00	-19.90
4	313.24	-64.70	-68.80	4.00	-64.80	-45.00	-19.80
5	379.20	-67.90	-72.00	3.60	-68.40	-45.00	-23.40
6	996.12	-72.80	-66.00	3.30	-62.70	-45.00	-17.70

Remarks:

1. Output Power (dBm) = S.G Value (dBm) + Correction Factor (dB).
2. Correction Factor (dB) = Substitution Antenna Gain (dB) + Cable Loss (dB).

Above 1GHz

Channel Bandwidth: 5MHz

Mode	TX channel 27685	Frequency Range	Above 1000MHz
Environmental Conditions	20deg. C, 69%RH	Input Power	48Vdc
Tested By	Tank Wu		

Antenna Polarity & Test Distance: Horizontal at 3 M							
No.	Freq. (MHz)	Reading (dBm)	S.G Power Value (dBm)	Correction Factor (dB)	EIRP (dBm)	Limit (dBm)	Margin (dB)
1	4615.00	-79.00	-68.60	1.00	-67.60	-45.00	-22.60
Antenna Polarity & Test Distance: Vertical at 3 M							
No.	Freq. (MHz)	Reading (dBm)	S.G Power Value (dBm)	Correction Factor (dB)	EIRP (dBm)	Limit (dBm)	Margin (dB)
1	4615.00	-80.20	-70.00	1.00	-69.00	-45.00	-24.00

Remarks:

1. Output Power (dBm) = S.G Value (dBm) + Correction Factor (dB).
2. Correction Factor (dB) = Substitution Antenna Gain (dB) + Cable Loss (dB).

Mode	TX channel 27710	Frequency Range	Above 1000MHz
Environmental Conditions	20deg. C, 69%RH	Input Power	48Vdc
Tested By	Tank Wu		

Antenna Polarity & Test Distance: Horizontal at 3 M							
No.	Freq. (MHz)	Reading (dBm)	S.G Power Value (dBm)	Correction Factor (dB)	EIRP (dBm)	Limit (dBm)	Margin (dB)
1	4620.00	-74.00	-63.60	1.00	-62.60	-45.00	-17.60
Antenna Polarity & Test Distance: Vertical at 3 M							
No.	Freq. (MHz)	Reading (dBm)	S.G Power Value (dBm)	Correction Factor (dB)	EIRP (dBm)	Limit (dBm)	Margin (dB)
1	4620.00	-80.00	-69.70	1.00	-68.70	-45.00	-23.70

Remarks:

1. Output Power (dBm) = S.G Value (dBm) + Correction Factor (dB).
2. Correction Factor (dB) = Substitution Antenna Gain (dB) + Cable Loss (dB).

Mode	TX channel 27735	Frequency Range	Above 1000MHz
Environmental Conditions	20deg. C, 69%RH	Input Power	48Vdc
Tested By	Tank Wu		

Antenna Polarity & Test Distance: Horizontal at 3 M							
No.	Freq. (MHz)	Reading (dBm)	S.G Power Value (dBm)	Correction Factor (dB)	EIRP (dBm)	Limit (dBm)	Margin (dB)
1	4625.00	-80.00	-69.60	1.10	-68.50	-45.00	-23.50
Antenna Polarity & Test Distance: Vertical at 3 M							
No.	Freq. (MHz)	Reading (dBm)	S.G Power Value (dBm)	Correction Factor (dB)	EIRP (dBm)	Limit (dBm)	Margin (dB)
1	4625.00	-81.10	-70.90	1.10	-69.80	-45.00	-24.80

Remarks:

1. Output Power (dBm) = S.G Value (dBm) + Correction Factor (dB).
2. Correction Factor (dB) = Substitution Antenna Gain (dB) + Cable Loss (dB).

Channel Bandwidth: 10MHz

Mode	TX channel 27710	Frequency Range	Above 1000MHz
Environmental Conditions	20deg. C, 69%RH	Input Power	48Vdc
Tested By	Tank Wu		

Antenna Polarity & Test Distance: Horizontal at 3 M							
No.	Freq. (MHz)	Reading (dBm)	S.G Power Value (dBm)	Correction Factor (dB)	EIRP (dBm)	Limit (dBm)	Margin (dB)
1	4620.00	-78.00	-67.60	1.00	-66.60	-45.00	-21.60
Antenna Polarity & Test Distance: Vertical at 3 M							
No.	Freq. (MHz)	Reading (dBm)	S.G Power Value (dBm)	Correction Factor (dB)	EIRP (dBm)	Limit (dBm)	Margin (dB)
1	4620.00	-79.50	-69.20	1.00	-68.20	-45.00	-23.20

Remarks:

1. Output Power (dBm) = S.G Value (dBm) + Correction Factor (dB).
2. Correction Factor (dB) = Substitution Antenna Gain (dB) + Cable Loss (dB).



## 5 Pictures of Test Arrangements

Please refer to the attached file (Test Setup Photo).

## Appendix – Information on the Testing Laboratories

We, Bureau Veritas Consumer Products Services (H.K.) Ltd., Taoyuan Branch, were founded in 1988 to provide our best service in EMC, Radio, Telecom and Safety consultation. Our laboratories are accredited and approved according to ISO/IEC 17025.

If you have any comments, please feel free to contact us at the following:

### Linko EMC/RF Lab

Tel: 886-2-26052180

Fax: 886-2-26051924

### Hsin Chu EMC/RF/Telecom Lab

Tel: 886-3-6668565

Fax: 886-3-6668323

### Hwa Ya EMC/RF/Safety Lab

Tel: 886-3-3183232

Fax: 886-3-3270892

**Email:** [service.adt@tw.bureauveritas.com](mailto:service.adt@tw.bureauveritas.com)

**Web Site:** [www.bureauveritas-adt.com](http://www.bureauveritas-adt.com)

The address and road map of all our labs can be found in our web site also.

--- END ---