

# FCC Test Report

## (Part 24)

**Report No.:** RF160225C21

**FCC ID:** XIA-NRB51

**Test Model:** NRB-51

**Received Date:** Feb. 18, 2016

**Test Date:** Feb. 22 ~ Feb. 23, 2016

**Issued Date:** Feb. 26, 2016

**Applicant:** NetComm Wireless Limited

**Address:** Level 2, 18-20 Orion Road, Lane Cove, NSW 2066, Sydney Australia

**Issued By:** Bureau Veritas Consumer Products Services (H.K.) Ltd., Taoyuan Branch

**Lab Address:** No. 47-2, 14th Ling, Chia Pau Vil., Lin Kou Dist., New Taipei City, Taiwan, R.O.C.

**Test Location:** No. 19, Hwa Ya 2nd Rd., Wen Hwa Vil., Kwei Shan Dist., Taoyuan City 33383, TAIWAN (R.O.C.)



This report is for your exclusive use. Any copying or replication of this report to or for any other person or entity, or use of our name or trademark, is permitted only with our prior written permission. This report sets forth our findings solely with respect to the test samples identified herein. The results set forth in this report are not indicative or representative of the quality or characteristics of the lot from which a test sample was taken or any similar or identical product unless specifically and expressly noted. Our report includes all of the tests requested by you and the results thereof based upon the information that you provided to us. You have 60 days from date of issuance of this report to notify us of any material error or omission caused by our negligence, provided, however, that such notice shall be in writing and shall specifically address the issue you wish to raise. A failure to raise such issue within the prescribed time shall constitute your unqualified acceptance of the completeness of this report, the tests conducted and the correctness of the report contents. Unless specific mention, the uncertainty of measurement has been explicitly taken into account to declare the compliance or non-compliance to the specification. The report must not be used by the client to claim product certification, approval, or endorsement by TAF or any government agencies.

**Table of Contents**

<b>Release Control Record</b> .....	<b>3</b>
<b>1 Certificate of Conformity</b> .....	<b>4</b>
<b>2 Summary of Test Results</b> .....	<b>5</b>
2.1 Measurement Uncertainty.....	5
2.2 Test Site and Instruments.....	6
<b>3 General Information</b> .....	<b>7</b>
3.1 General Description of EUT.....	7
3.2 Configuration of System Under Test.....	8
3.2.1 Description of Support Units.....	8
3.3 Test Mode Applicability and Tested Channel Detail.....	9
3.4 EUT Operating Conditions.....	11
3.5 General Description of Applied Standards.....	11
<b>4 Test Types and Results</b> .....	<b>12</b>
4.1 Output Power Measurement.....	12
4.1.1 Limits of Output Power Measurement.....	12
4.1.2 Test Procedures.....	12
4.1.3 Test Setup.....	13
4.1.4 Test Results.....	14
4.2 Frequency Stability Measurement.....	22
4.2.1 Limits of Frequency Stability Measurement.....	22
4.2.2 Test Procedure.....	22
4.2.3 Test Setup.....	22
4.2.4 Test Results.....	23
4.3 Occupied Bandwidth Measurement.....	24
4.3.1 Test Procedure.....	24
4.3.2 Test Setup.....	24
4.3.3 Test Result.....	24
4.4 Band Edge Measurement.....	26
4.4.1 Limits of Band Edge Measurement.....	26
4.4.2 Test Setup.....	26
4.4.3 Test Procedures.....	26
4.4.4 Test Results.....	27
4.5 Peak To Average Ratio.....	33
4.5.1 Limits of Peak To Average Ratio Measurement.....	33
4.5.2 Test Setup.....	33
4.5.3 Test Procedures.....	33
4.5.4 Test Results.....	34
4.6 Conducted Spurious Emissions.....	36
4.6.1 Limits of Conducted Spurious Emissions Measurement.....	36
4.6.2 Test Setup.....	36
4.6.3 Test Procedure.....	36
4.6.4 Test Results.....	37
4.7 Radiated Emission Measurement.....	55
4.7.1 Limits of Radiated Emission Measurement.....	55
4.7.2 Test Procedure.....	55
4.7.3 Deviation from Test Standard.....	55
4.7.4 Test Setup.....	56
4.7.5 Test Results.....	57
<b>5 Pictures of Test Arrangements</b> .....	<b>70</b>
<b>Appendix – Information on the Testing Laboratories</b> .....	<b>71</b>



A D T

### Release Control Record

Issue No.	Description	Date Issued
RF160225C21	Original release	Feb. 26, 2016



**1 Certificate of Conformity**

**Product:** Outdoor LTE Router  
**Brand:** Netcomm  
**Test Model:** NRB-51  
**Sample Status:** Engineering sample  
**Applicant:** NetComm Wireless Limited  
**Test Date:** Feb. 22 ~ Feb. 23, 2016  
**Standards:** FCC Part 24, Subpart E

The above equipment has been tested by **Bureau Veritas Consumer Products Services (H.K.) Ltd., Taoyuan Branch**, and found compliance with the requirement of the above standards. The test record, data evaluation & Equipment Under Test (EUT) configurations represented herein are true and accurate accounts of the measurements of the sample's EMC characteristics under the conditions specified in this report.

**Prepared by :**  , **Date:** Feb. 26, 2016  
Pettie Chen / Senior Specialist

**Approved by :**  , **Date:** Feb. 26, 2016  
Jeremy Lin / Project Engineer

## 2 Summary of Test Results

Applied Standard: FCC Part 24 & Part 2			
FCC Clause	Test Item	Result	Remarks
2.1046 24.232	Effective Radiated Power	Pass	Meet the requirement of limit.
2.1046 24.232(d)	Peak To Average Ratio	Pass	Meet the requirement of limit.
2.1055 24.235	Frequency Stability	Pass	Meet the requirement of limit.
2.1049 24.238(b)	Occupied Bandwidth	Pass	Meet the requirement of limit.
24.238(b)	Band Edge Measurements	Pass	Meet the requirement of limit.
2.1051 24.238	Conducted Spurious Emissions	Pass	Meet the requirement of limit.
2.1053 24.238	Radiated Spurious Emissions	Pass	Meet the requirement of limit. Minimum passing margin is -23.5dB at 3760.00MHz.

### 2.1 Measurement Uncertainty

Where relevant, the following measurement uncertainty levels have been estimated for tests performed on the EUT as specified in CISPR 16-4-2:

Measurement	Frequency	Expanded Uncertainty (k=2) (±)
Conducted Emissions at mains ports	150kHz ~ 30MHz	2.44 dB
Radiated Emissions up to 1 GHz	30MHz ~ 200MHz	3.63 dB
	200MHz ~ 1000MHz	3.64 dB
Radiated Emissions above 1 GHz	1GHz ~ 18GHz	2.29 dB
	18GHz ~ 40GHz	2.29 dB



## 2.2 Test Site and Instruments

Description & Manufacturer	Model No.	Serial No.	Cal. Date	Cal. Due
Test Receiver ROHDE & SCHWARZ	ESCS30	100289	Dec. 23, 2015	Dec. 22, 2016
Spectrum Analyzer ROHDE & SCHWARZ	FSP40	100269	Mar. 30, 2015	Mar. 29, 2016
BILOG Antenna SCHWARZBECK	VULB9168	9168-148	Jan. 18, 2016	Jan. 17, 2017
HORN Antenna SCHWARZBECK	BBHA 9120 D	9120D-1169	Jan. 08, 2016	Jan. 07, 2017
HORN Antenna SCHWARZBECK	BBHA 9170	BBHA9170241	Jan. 18, 2016	Jan. 17, 2017
Preamplifier Agilent	8449B	3008A01911	Aug. 09, 2015	Aug. 08, 2016
Preamplifier Agilent	8447D	2944A10638	Aug. 09, 2015	Aug. 08, 2016
RF signal cable HUBER+SUHNER	SUCOFLEX 104	CABLE-CH9-02(309222 +248780)	Aug. 09, 2015	Aug. 08, 2016
RF signal cable HUBER+SUHNER	SUCOFLEX 104	CABLE-CH9-03(274092)	Aug. 09, 2015	Aug. 08, 2016
RF signal cable Woken	8D-FB	Cable-CH9-01	Aug. 11, 2015	Aug. 10, 2016
Software BV ADT	ADT_Radiated_ V7.6.15.9.4	NA	NA	NA
Antenna Tower EMCO	2070/2080	512.835.4684	NA	NA
Turn Table EMCO	2087-2.03	NA	NA	NA
Antenna Tower & Turn BV ADT	AT100	AT93021705	NA	NA
Turn Table BV ADT	TT100	TT93021705	NA	NA
Turn Table Controller BV ADT	SC100	SC93021705	NA	NA
WIT Standard Temperature And Humidity Chamber	TH-4S-C	W981030	Jun. 08, 2015	Jun. 07, 2016
Mini-Circuits Power Splitter	ZN2PD-9G	NA	Jun. 09, 2015	Jun. 08, 2016
JFW 20dB attenuation	50HF-020-SMA	NA	NA	NA

- Note: 1. The calibration interval of the above test instruments is 12 months and the calibrations are traceable to NML/ROC and NIST/USA.  
2. The test was performed in HwaYa Chamber 9.  
3. The horn antenna and HP preamplifier (model: 8449B) are used only for the measurement of emission frequency above 1GHz if tested.  
4. The FCC Site Registration No. is 215374.  
5. The IC Site Registration No. is IC 7450F-9.

### 3 General Information

#### 3.1 General Description of EUT

Product	Outdoor LTE Router	
Brand	Netcomm	
Test Model	NRB-51	
Status of EUT	Engineering sample	
Power Supply Rating	48 Vdc (PoE)	
Modulation Type	QPSK, 16QAM	
Operating Frequency	LTE Band 2 (Channel Bandwidth 1.4MHz)	1850.7MHz ~ 1909.3MHz
	LTE Band 2 (Channel Bandwidth 3MHz)	1851.5MHz ~ 1908.5MHz
	LTE Band 2 (Channel Bandwidth 5MHz)	1852.5MHz ~ 1907.5MHz
	LTE Band 2 (Channel Bandwidth 10MHz)	1855MHz ~ 1905MHz
	LTE Band 2 (Channel Bandwidth 15MHz)	1857.5MHz ~ 1902.5MHz
	LTE Band 2 (Channel Bandwidth 20MHz)	1860MHz ~ 1900MHz
Max. EIRP Power	LTE Band 2 (Channel Bandwidth 1.4MHz)	1174.898mW (30.7dBm)
	LTE Band 2 (Channel Bandwidth 3MHz)	1096.478mW (30.4dBm)
	LTE Band 2 (Channel Bandwidth 5MHz)	933.254mW (29.7dBm)
	LTE Band 2 (Channel Bandwidth 10MHz)	891.251mW (29.5dBm)
	LTE Band 2 (Channel Bandwidth 15MHz)	1096.478mW (30.4dBm)
	LTE Band 2 (Channel Bandwidth 20MHz)	891.251mW (29.5dBm)
Antenna Type	Directional antenna with 13dBi gain	
Antenna Connector	IPEX	
Accessory Device	NA	
Power Cord	NA	
Data Cable Supplied	NA	

**Note:**

1. The EUT uses following PoE.

PoE (Support Unit)	
Brand	NetcommWireless
Model	PoE-02
Input Power	100-240Vac~50/60Hz
Output Power	48Vdc, 15.4W

### 3.2 Configuration of System Under Test

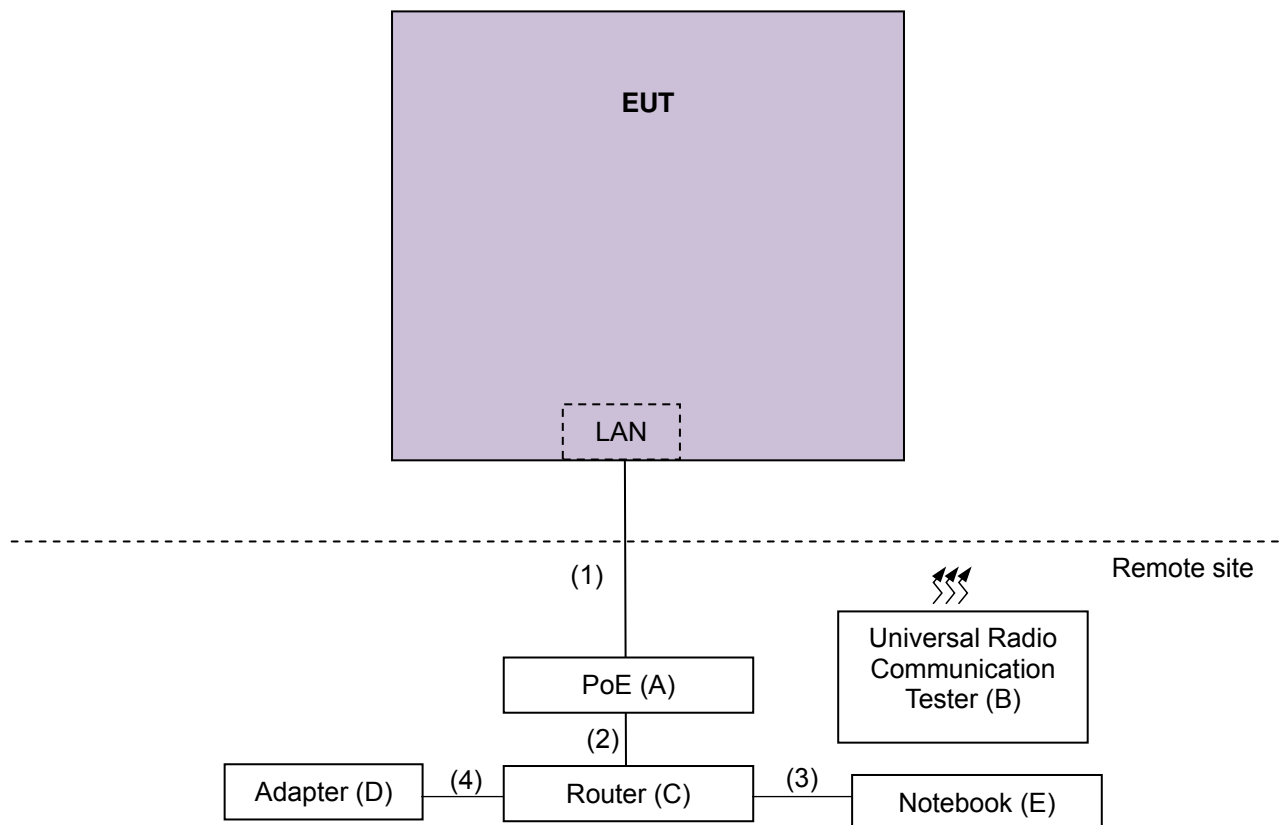

#### 3.2.1 Description of Support Units

The EUT has been tested as an independent unit together with other necessary accessories or support units. The following support units or accessories were used to form a representative test configuration during the tests.

ID	Product	Brand	Model No.	Serial No.	FCC ID	Remarks
A.	PoE	NetcommWireless	PoE-02	NA	NA	Provided by manufacturer
B.	Universal Radio Communication Tester	Anritsu	MT8820C	6201010284	NA	-
C.	Router	MikroTik	RouterBoard 260GS	5A51040BA8AE/446	NA	Provided by manufacturer
D.	Adapter	Ten Pao International Inc.	S018KM1200150	NA	NA	Provided by manufacturer
E.	Notebook	DELL	D531	CN-0XM006-48643-81 U-2973	QDS-BRCM 1020	

Note:

1. All power cords of the above support units are non-shielded (1.8m).
2. Item A, B, C, D, E acted as communication partners to transfer data.

ID	Descriptions	Qty.	Length (m)	Shielding (Yes/No)	Cores (Qty.)	Remarks
1.	RJ45 cable	1	10	N	0	-
2.	RJ45 cable	1	1.8	N	0	-
3.	RJ45 cable	1	1.8	N	0	-
4.	Power cord	1	1.5	-	0	-



### 3.3 Test Mode Applicability and Tested Channel Detail

Following channel(s) was (were) selected for the final test as listed below:

LTE Band 2

Test item	Available channel	Tested channel	Channel Bandwidth	Modulation	Mode
EIRP	18607 to 19193	18607, 18900, 19193	1.4MHz	QPSK	1 RB / 0 RB Offset
	18615 to 19185	18615, 18900, 19185	3MHz	QPSK	1 RB / 0 RB Offset
	18625 to 19175	18625, 18900, 19175	5MHz	QPSK	1 RB / 0 RB Offset
	18650 to 19150	18650, 18900, 19150	10MHz	QPSK	1 RB / 0 RB Offset
	18675 to 19125	18675, 18900, 19125	15MHz	QPSK	1 RB / 0 RB Offset
	18700 to 19100	18700, 18900, 19100	20MHz	QPSK	1 RB / 0 RB Offset
Frequency Stability	18615 to 19185	18900	3MHz	QPSK	1 RB / 0 RB Offset
Occupied Bandwidth	18607 to 19193	18607, 18900, 19193	1.4MHz	QPSK / 16QAM	1 RB / 0 RB Offset
	18615 to 19185	18615, 18900, 19185	3MHz	QPSK / 16QAM	1 RB / 0 RB Offset
	18625 to 19175	18625, 18900, 19175	5MHz	QPSK / 16QAM	1 RB / 0 RB Offset
	18650 to 19150	18650, 18900, 19150	10MHz	QPSK / 16QAM	1 RB / 0 RB Offset
	18675 to 19125	18675, 18900, 19125	15MHz	QPSK / 16QAM	1 RB / 0 RB Offset
	18700 to 19100	18700, 18900, 19100	20MHz	QPSK / 16QAM	1 RB / 0 RB Offset
Band Edge	18607 to 19193	18607	1.4MHz	QPSK	1 RB / 0 RB Offset 6 RB / 0 RB Offset
		19193	1.4MHz	QPSK	1 RB / 5 RB Offset 6 RB / 0 RB Offset
	18615 to 19185	18615	3MHz	QPSK	1 RB / 0 RB Offset 15 RB / 0 RB Offset
		19185	3MHz	QPSK	1 RB / 14 RB Offset 15 RB / 0 RB Offset
	18625 to 19175	18625	5MHz	QPSK	1 RB / 0 RB Offset 25 RB / 0 RB Offset
		19175	5MHz	QPSK	1 RB / 24 RB Offset 25 RB / 0 RB Offset
	18650 to 19150	18650	10MHz	QPSK	1 RB / 0 RB Offset 50 RB / 0 RB Offset
		19150	10MHz	QPSK	1 RB / 49 RB Offset 50 RB / 0 RB Offset
	18675 to 19125	18675	15MHz	QPSK	1 RB / 0 RB Offset 75 RB / 0 RB Offset
		19125	15MHz	QPSK	1 RB / 74 RB Offset 75 RB / 0 RB Offset
	18700 to 19100	18700	20MHz	QPSK	1 RB / 0 RB Offset 100 RB / 0 RB Offset
		19100	20MHz	QPSK	1 RB / 99 RB Offset 100 RB / 0 RB Offset

Test item	Available channel	Tested channel	Channel Bandwidth	Modulation	Mode
Peak to Average Ratio	18607 to 19193	18607, 18900, 19193	1.4MHz	QPSK / 16QAM	1 RB / 0 RB Offset
	18615 to 19185	18615, 18900, 19185	3MHz	QPSK / 16QAM	1 RB / 0 RB Offset
	18625 to 19175	18625, 18900, 19175	5MHz	QPSK / 16QAM	1 RB / 0 RB Offset
	18650 to 19150	18650, 18900, 19150	10MHz	QPSK / 16QAM	1 RB / 0 RB Offset
	18675 to 19125	18675, 18900, 19125	15MHz	QPSK / 16QAM	1 RB / 0 RB Offset
	18700 to 19100	18700, 18900, 19100	20MHz	QPSK / 16QAM	1 RB / 0 RB Offset
Conducuted Emission	18607 to 19193	18607, 18900, 19193	1.4MHz	QPSK	1 RB / 0 RB Offset
	18615 to 19185	18615, 18900, 19185	3MHz	QPSK	1 RB / 0 RB Offset
	18625 to 19175	18625, 18900, 19175	5MHz	QPSK	1 RB / 0 RB Offset
	18650 to 19150	18650, 18900, 19150	10MHz	QPSK	1 RB / 0 RB Offset
	18675 to 19125	18675, 18900, 19125	15MHz	QPSK	1 RB / 0 RB Offset
	18700 to 19100	18700, 18900, 19100	20MHz	QPSK	1 RB / 0 RB Offset
Radiated Emission Below 1GHz	18615 to 19185	19185	3MHz	QPSK	1 RB / 0 RB Offset
Radiated Emission Above 1GHz	18607 to 19193	18607, 18900, 19193	1.4MHz	QPSK	1 RB / 0 RB Offset
	18615 to 19185	18615, 18900, 19185	3MHz	QPSK	1 RB / 0 RB Offset
	18625 to 19175	18625, 18900, 19175	5MHz	QPSK	1 RB / 0 RB Offset
	18650 to 19150	18650, 18900, 19150	10MHz	QPSK	1 RB / 0 RB Offset
	18675 to 19125	18675, 18900, 19125	15MHz	QPSK	1 RB / 0 RB Offset
	18700 to 19100	18700, 18900, 19100	20MHz	QPSK	1 RB / 0 RB Offset

**Test Condition:**

Test Item	Environmental Conditions	Input Power	Tested By
EIRP	25deg. C, 65%RH	48Vdc	Tank Wu
Frequency Stability	24deg. C, 64%RH	120Vac, 60Hz (System)	Match Tsui
Occupied Bandwidth	24deg. C, 64%RH	48Vdc	Match Tsui
Band Edge	24deg. C, 64%RH	48Vdc	Match Tsui
Peak To Average Ratio	24deg. C, 64%RH	48Vdc	Match Tsui
Conducted Emission	24deg. C, 64%RH	48Vdc	Match Tsui
Radiated Emission	25deg. C, 65%RH	48Vdc	Tank Wu

### **3.4 EUT Operating Conditions**

The EUT makes a call to the communication simulator. The communication simulator station system controlled a EUT to export maximum output power under transmission mode and specific channel frequency

### **3.5 General Description of Applied Standards**

The EUT is a RF Product. According to the specifications of the manufacturer, it must comply with the requirements of the following standards:

**FCC 47 CFR Part 2**

**FCC 47 CFR Part 24**

**KDB 971168 D01 Power Meas License Digital Systems v02r02**

**ANSI/TIA/EIA-603-C 2004**

- Note:**
1. All test items have been performed and recorded as per the above standards.
  2. The EUT has been verified to comply with the requirements of FCC Part 15, Subpart B, Class B (DoC). The test report has been issued separately.

## 4 Test Types and Results

### 4.1 Output Power Measurement

#### 4.1.1 Limits of Output Power Measurement

Base stations with an emission bandwidth of 1 MHz or less are limited to 1640 watts equivalent isotropically radiated power (EIRP) with an antenna height up to 300 meters HAAT,

#### 4.1.2 Test Procedures

##### EIRP / ERP Measurement:

- a. All measurements were done at low, middle and high operational frequency range. RBW and VBW is 10MHz for LTE Mode.
- b. Substitution method is used for E.I.R.P measurement. In the semi-anechoic chamber, EUT placed on the 0.8m height of Turn Table, rotated the table around 360 degrees to search the maximum radiation power and receiver antenna shall be rotated vertical and horizontal polarization and moved height from 1m to 4m to find the maximum polar radiated power. The "Read Value" is the spectrum reading the maximum power value.
- c. The substitution horn antenna is substituted for EUT at the same position and signals generator export the CW signal to the substitution antenna via a tx cable. Rotated the Turn Table and moved receiving antenna to find the maximum radiation power. Adjust output power level of S.G to get a Value of spectrum reading equal to "Read Value" of step b. Record the power level of S.G
- d.  $EIRP = \text{Output power level of S.G} - \text{TX cable loss} + \text{Antenna gain of substitution horn}$ . E.R.P power can be calculated form E.I.R.P power by subtracting the gain of dipole,  $E.R.P \text{ power} = E.I.R.P \text{ power} - 2.15\text{dBi}$ .

##### Conducted Power Measurement:

The EUT was set up for the maximum power with LTE link data modulation and link up with simulator. Set the EUT to transmit under low, middle and high channel and record the power level shown on simulator.

### 4.1.3 Test Setup

EIRP / ERP MEASUREMENT:

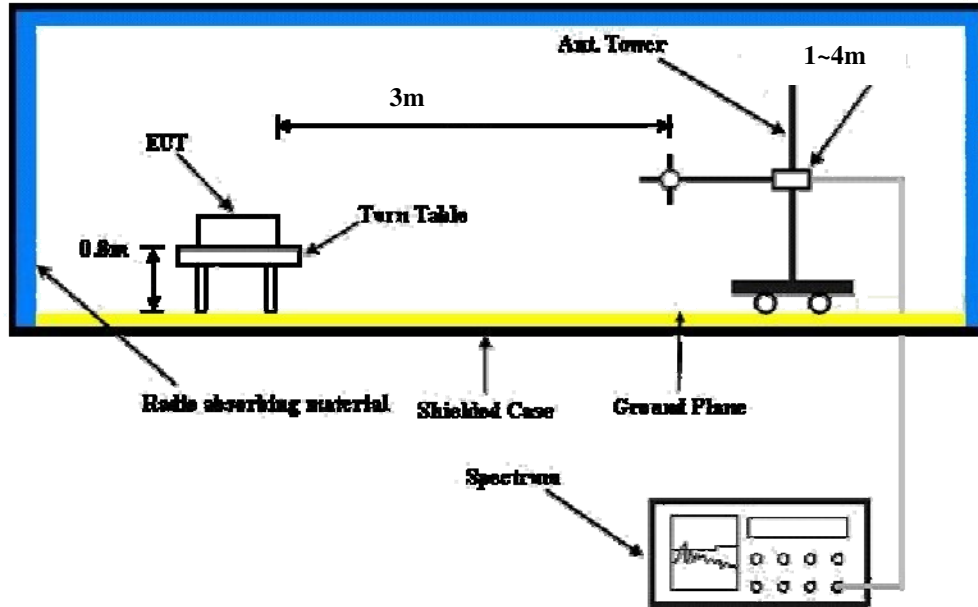

For the actual test configuration, please refer to the attached file (Test Setup Photo).

CONDUCTED POWER MEASUREMENT:



For the actual test configuration, please refer to the attached file (Test Setup Photo).

**4.1.4 Test Results**
**CONDUCTED OUTPUT POWER (dBm)**

Band / BW	RB Size	RB Offset	QPSK			16QAM		
			Low CH	Mid CH	High CH	Low CH	Mid CH	High CH
			18607	18900	19193	18607	18900	19193
			1850.7 MHz	1880 MHz	1909.3 MHz	1850.7 MHz	1880 MHz	1909.3 MHz
2 / 1.4M	1	0	19.27	18.81	19.75	18.57	18.11	19.05
	1	2	19.61	19.05	<b>19.81</b>	19.08	18.52	<b>19.28</b>
	1	5	19.32	18.97	19.67	18.51	18.16	18.86
	3	0	19.17	18.77	19.49	18.34	17.94	18.66
	3	1	19.29	18.95	19.52	18.19	17.85	18.42
	3	3	19.14	18.75	19.54	18.33	17.94	18.73
	6	0	18.10	17.71	18.36	17.17	16.78	17.43
Band / BW	RB Size	RB	QPSK			16QAM		
		Offset	Low CH	Mid CH	High CH	Low CH	Mid CH	High CH
			18615	18900	19185	18615	18900	19185
			1851.5 MHz	1880 MHz	1908.5 MHz	1851.5 MHz	1880 MHz	1908.5 MHz
2 / 3M	1	0	19.24	18.79	19.73	18.54	18.09	19.03
	1	7	19.65	19.05	<b>19.83</b>	19.12	18.52	<b>19.30</b>
	1	14	19.25	18.95	19.62	18.44	18.14	18.81
	8	0	18.17	17.74	18.47	17.34	16.91	17.64
	8	3	18.07	17.69	18.28	16.97	16.59	17.18
	8	7	18.03	17.64	18.43	17.22	16.83	17.62
	15	0	18.16	17.80	18.44	17.23	16.87	17.51
Band / BW	RB Size	RB Offset	QPSK			16QAM		
			Low CH	Mid CH	High CH	Low CH	Mid CH	High CH
			18625	18900	19175	18625	18900	19175
			1852.5 MHz	1880 MHz	1907.5 MHz	1852.5 MHz	1880 MHz	1907.5 MHz
2 / 5M	1	0	19.21	17.75	19.71	18.46	17.00	18.96
	1	12	19.55	17.76	<b>19.72</b>	18.98	17.19	<b>19.15</b>
	1	24	19.34	17.76	19.71	18.52	16.94	18.89
	12	0	18.11	17.11	18.41	17.25	16.25	17.55
	12	6	18.26	17.16	18.49	17.19	16.09	17.42
	12	13	18.00	17.00	18.39	17.13	16.13	17.52
	25	0	18.19	17.02	18.45	17.25	16.08	17.51

Band / BW	RB Size	RB Offset	QPSK			16QAM		
			Low CH	Mid CH	High CH	Low CH	Mid CH	High CH
			18650 MHz	18900 MHz	19150 MHz	18650 MHz	18900 MHz	19150 MHz
2 / 10M	1	0	19.08	18.64	19.60	18.33	17.89	18.85
	1	24	19.47	18.89	<b>19.73</b>	18.90	18.32	<b>19.16</b>
	1	49	19.15	18.79	19.54	18.37	18.01	18.76
	25	0	18.21	17.68	18.42	17.34	16.81	17.55
	25	12	18.25	17.97	18.46	17.16	16.88	17.37
	25	25	18.14	17.86	18.54	17.36	17.08	17.76
	50	0	18.37	18.00	18.63	17.46	17.09	17.72
Band / BW	RB Size	RB Offset	QPSK			16QAM		
			Low CH	Mid CH	High CH	Low CH	Mid CH	High CH
			18675 MHz	18900 MHz	19125 MHz	18675 MHz	18900 MHz	19125 MHz
2 / 15M	1	0	19.34	19.15	19.65	18.59	18.46	18.89
	1	37	19.49	18.76	<b>19.68</b>	18.92	18.19	<b>19.13</b>
	1	74	19.24	19.36	19.45	18.47	18.60	18.75
	36	0	18.04	17.86	18.41	17.17	17.07	17.56
	36	19	18.00	17.79	18.44	17.06	16.70	17.57
	36	39	18.11	17.92	18.46	17.33	17.25	17.71
	75	0	18.05	17.77	18.38	17.14	16.80	17.50
Band / BW	RB Size	RB Offset	QPSK			16QAM		
			Low CH	Mid CH	High CH	Low CH	Mid CH	High CH
			18700 MHz	18900 MHz	19100 MHz	18700 MHz	18900 MHz	19100 MHz
2 / 20M	1	0	19.44	18.44	18.95	18.69	17.75	18.19
	1	50	18.58	18.41	<b>19.46</b>	18.01	17.84	<b>18.91</b>
	1	99	18.64	18.34	19.12	17.87	17.58	18.42
	50	0	18.15	18.05	17.79	17.28	17.26	16.94
	50	25	17.80	17.56	17.62	16.86	16.47	16.75
	50	50	17.73	17.64	17.78	16.95	16.97	17.03
	100	0	17.95	17.44	17.78	17.04	16.47	16.90

EIRP Power (dBm)

LTE Band 2

Channel Bandwidth: 1.4MHz

MODE		TX channel 18607					
Antenna Polarity & Test Distance: Horizontal at 3 M							
No.	Freq. (MHz)	Reading (dBm)	S.G Power Value (dBm)	Correction Factor (dB)	EIRP (dBm)	Limit (dBm)	Margin (dB)
1	1850.70	-9.6	30.6	0.1	<b>30.7</b>	62.14	-31.44
Antenna Polarity & Test Distance: Vertical at 3 M							
No.	Freq. (MHz)	Reading (dBm)	S.G Power Value (dBm)	Correction Factor (dB)	EIRP (dBm)	Limit (dBm)	Margin (dB)
1	1850.70	-9.9	30.5	0.1	30.6	62.14	-31.54

MODE		TX channel 18900					
Antenna Polarity & Test Distance: Horizontal at 3 M							
No.	Freq. (MHz)	Reading (dBm)	S.G Power Value (dBm)	Correction Factor (dB)	EIRP (dBm)	Limit (dBm)	Margin (dB)
1	1880.00	-10.3	30.2	0.0	30.2	62.14	-31.94
Antenna Polarity & Test Distance: Vertical at 3 M							
No.	Freq. (MHz)	Reading (dBm)	S.G Power Value (dBm)	Correction Factor (dB)	EIRP (dBm)	Limit (dBm)	Margin (dB)
1	1880.00	-10.9	29.7	0.0	29.7	62.14	-32.44

MODE		TX channel 19193					
Antenna Polarity & Test Distance: Horizontal at 3 M							
No.	Freq. (MHz)	Reading (dBm)	S.G Power Value (dBm)	Correction Factor (dB)	EIRP (dBm)	Limit (dBm)	Margin (dB)
1	1909.30	-10.2	30.5	-0.1	30.4	62.14	-31.74
Antenna Polarity & Test Distance: Vertical at 3 M							
No.	Freq. (MHz)	Reading (dBm)	S.G Power Value (dBm)	Correction Factor (dB)	EIRP (dBm)	Limit (dBm)	Margin (dB)
1	1909.30	-10.3	30.5	-0.1	30.4	62.14	-31.74

Note: EIRP (dBm) = S.G Power Value (dBm) + Correction Factor (dB).



Channel Bandwidth: 3MHz

MODE		TX channel 18615					
Antenna Polarity & Test Distance: Horizontal at 3 M							
No.	Freq. (MHz)	Reading (dBm)	S.G Power Value (dBm)	Correction Factor (dB)	EIRP (dBm)	Limit (dBm)	Margin (dB)
1	1851.50	-10.9	29.3	0.1	29.4	62.14	-32.74
Antenna Polarity & Test Distance: Vertical at 3 M							
No.	Freq. (MHz)	Reading (dBm)	S.G Power Value (dBm)	Correction Factor (dB)	EIRP (dBm)	Limit (dBm)	Margin (dB)
1	1851.50	-10.1	30.3	0.1	<b>30.4</b>	62.14	-31.74

MODE		TX channel 18900					
Antenna Polarity & Test Distance: Horizontal at 3 M							
No.	Freq. (MHz)	Reading (dBm)	S.G Power Value (dBm)	Correction Factor (dB)	EIRP (dBm)	Limit (dBm)	Margin (dB)
1	1880.00	-10.7	29.8	0.0	29.8	62.14	-32.34
Antenna Polarity & Test Distance: Vertical at 3 M							
No.	Freq. (MHz)	Reading (dBm)	S.G Power Value (dBm)	Correction Factor (dB)	EIRP (dBm)	Limit (dBm)	Margin (dB)
1	1880.00	-11.3	29.3	0.0	29.3	62.14	-32.84

MODE		TX channel 19185					
Antenna Polarity & Test Distance: Horizontal at 3 M							
No.	Freq. (MHz)	Reading (dBm)	S.G Power Value (dBm)	Correction Factor (dB)	EIRP (dBm)	Limit (dBm)	Margin (dB)
1	1908.50	-11.9	28.8	-0.1	28.7	62.14	-33.44
Antenna Polarity & Test Distance: Vertical at 3 M							
No.	Freq. (MHz)	Reading (dBm)	S.G Power Value (dBm)	Correction Factor (dB)	EIRP (dBm)	Limit (dBm)	Margin (dB)
1	1908.50	-11.4	29.4	-0.1	29.3	62.14	-32.84

Note: EIRP (dBm) = S.G Power Value (dBm) + Correction Factor (dB).

Channel Bandwidth: 5MHz

MODE		TX channel 18625					
Antenna Polarity & Test Distance: Horizontal at 3 M							
No.	Freq. (MHz)	Reading (dBm)	S.G Power Value (dBm)	Correction Factor (dB)	EIRP (dBm)	Limit (dBm)	Margin (dB)
1	1852.50	-11.7	28.5	0.1	28.6	62.14	-33.54
Antenna Polarity & Test Distance: Vertical at 3 M							
No.	Freq. (MHz)	Reading (dBm)	S.G Power Value (dBm)	Correction Factor (dB)	EIRP (dBm)	Limit (dBm)	Margin (dB)
1	1852.50	-10.8	29.6	0.1	<b>29.7</b>	62.14	-32.44

MODE		TX channel 18900					
Antenna Polarity & Test Distance: Horizontal at 3 M							
No.	Freq. (MHz)	Reading (dBm)	S.G Power Value (dBm)	Correction Factor (dB)	EIRP (dBm)	Limit (dBm)	Margin (dB)
1	1880.00	-12.1	28.4	0.0	28.4	62.14	-33.74
Antenna Polarity & Test Distance: Vertical at 3 M							
No.	Freq. (MHz)	Reading (dBm)	S.G Power Value (dBm)	Correction Factor (dB)	EIRP (dBm)	Limit (dBm)	Margin (dB)
1	1880.00	-12.6	28.0	0.0	28.0	62.14	-34.14

MODE		TX channel 19175					
Antenna Polarity & Test Distance: Horizontal at 3 M							
No.	Freq. (MHz)	Reading (dBm)	S.G Power Value (dBm)	Correction Factor (dB)	EIRP (dBm)	Limit (dBm)	Margin (dB)
1	1907.50	-12.4	28.3	-0.1	28.2	62.14	-33.94
Antenna Polarity & Test Distance: Vertical at 3 M							
No.	Freq. (MHz)	Reading (dBm)	S.G Power Value (dBm)	Correction Factor (dB)	EIRP (dBm)	Limit (dBm)	Margin (dB)
1	1907.50	-11.3	29.5	-0.1	29.4	62.14	-32.74

Note: EIRP (dBm) = S.G Power Value (dBm) + Correction Factor (dB).

Channel Bandwidth: 10MHz

MODE		TX channel 18650					
Antenna Polarity & Test Distance: Horizontal at 3 M							
No.	Freq. (MHz)	Reading (dBm)	S.G Power Value (dBm)	Correction Factor (dB)	EIRP (dBm)	Limit (dBm)	Margin (dB)
1	1855.00	-11.8	28.5	0.0	28.5	62.14	-33.64
Antenna Polarity & Test Distance: Vertical at 3 M							
No.	Freq. (MHz)	Reading (dBm)	S.G Power Value (dBm)	Correction Factor (dB)	EIRP (dBm)	Limit (dBm)	Margin (dB)
1	1855.00	-11.0	29.5	0.0	<b>29.5</b>	62.14	-32.64

MODE		TX channel 18900					
Antenna Polarity & Test Distance: Horizontal at 3 M							
No.	Freq. (MHz)	Reading (dBm)	S.G Power Value (dBm)	Correction Factor (dB)	EIRP (dBm)	Limit (dBm)	Margin (dB)
1	1880.00	-12.1	28.4	0.0	28.4	62.14	-33.74
Antenna Polarity & Test Distance: Vertical at 3 M							
No.	Freq. (MHz)	Reading (dBm)	S.G Power Value (dBm)	Correction Factor (dB)	EIRP (dBm)	Limit (dBm)	Margin (dB)
1	1880.00	-12.6	28.0	0.0	28.0	62.14	-34.14

MODE		TX channel 19150					
Antenna Polarity & Test Distance: Horizontal at 3 M							
No.	Freq. (MHz)	Reading (dBm)	S.G Power Value (dBm)	Correction Factor (dB)	EIRP (dBm)	Limit (dBm)	Margin (dB)
1	1905.00	-12.0	28.7	-0.1	28.6	62.14	-33.54
Antenna Polarity & Test Distance: Vertical at 3 M							
No.	Freq. (MHz)	Reading (dBm)	S.G Power Value (dBm)	Correction Factor (dB)	EIRP (dBm)	Limit (dBm)	Margin (dB)
1	1905.00	-11.3	29.5	-0.1	29.4	62.14	-32.74

Note: EIRP (dBm) = S.G Power Value (dBm) + Correction Factor (dB).

## Channel Bandwidth: 15MHz

MODE		TX channel 18675					
Antenna Polarity & Test Distance: Horizontal at 3 M							
No.	Freq. (MHz)	Reading (dBm)	S.G Power Value (dBm)	Correction Factor (dB)	EIRP (dBm)	Limit (dBm)	Margin (dB)
1	1857.50	-11.1	29.2	0.0	29.2	62.14	-32.94
Antenna Polarity & Test Distance: Vertical at 3 M							
No.	Freq. (MHz)	Reading (dBm)	S.G Power Value (dBm)	Correction Factor (dB)	EIRP (dBm)	Limit (dBm)	Margin (dB)
1	1857.50	-10.1	30.4	0.0	<b>30.4</b>	62.14	-31.74

MODE		TX channel 18900					
Antenna Polarity & Test Distance: Horizontal at 3 M							
No.	Freq. (MHz)	Reading (dBm)	S.G Power Value (dBm)	Correction Factor (dB)	EIRP (dBm)	Limit (dBm)	Margin (dB)
1	1880.00	-10.9	29.6	0.0	29.6	62.14	-32.54
Antenna Polarity & Test Distance: Vertical at 3 M							
No.	Freq. (MHz)	Reading (dBm)	S.G Power Value (dBm)	Correction Factor (dB)	EIRP (dBm)	Limit (dBm)	Margin (dB)
1	1880.00	-11.2	29.4	0.0	29.4	62.14	-32.74

MODE		TX channel 19125					
Antenna Polarity & Test Distance: Horizontal at 3 M							
No.	Freq. (MHz)	Reading (dBm)	S.G Power Value (dBm)	Correction Factor (dB)	EIRP (dBm)	Limit (dBm)	Margin (dB)
1	1902.50	-12.1	28.6	-0.1	28.5	62.14	-33.64
Antenna Polarity & Test Distance: Vertical at 3 M							
No.	Freq. (MHz)	Reading (dBm)	S.G Power Value (dBm)	Correction Factor (dB)	EIRP (dBm)	Limit (dBm)	Margin (dB)
1	1902.50	-11.9	28.9	-0.1	28.8	62.14	-33.34

Note: EIRP (dBm) = S.G Power Value (dBm) + Correction Factor (dB).

Channel Bandwidth: 20MHz

MODE		TX channel 18700					
Antenna Polarity & Test Distance: Horizontal at 3 M							
No.	Freq. (MHz)	Reading (dBm)	S.G Power Value (dBm)	Correction Factor (dB)	EIRP (dBm)	Limit (dBm)	Margin (dB)
1	1860.00	-11.2	29.1	0.0	29.1	62.14	-33.04
Antenna Polarity & Test Distance: Vertical at 3 M							
No.	Freq. (MHz)	Reading (dBm)	S.G Power Value (dBm)	Correction Factor (dB)	EIRP (dBm)	Limit (dBm)	Margin (dB)
1	1860.00	-11.1	29.4	0.0	29.4	62.14	-32.74

MODE		TX channel 18900					
Antenna Polarity & Test Distance: Horizontal at 3 M							
No.	Freq. (MHz)	Reading (dBm)	S.G Power Value (dBm)	Correction Factor (dB)	EIRP (dBm)	Limit (dBm)	Margin (dB)
1	1880.00	-11.4	29.1	0.0	29.1	62.14	-33.04
Antenna Polarity & Test Distance: Vertical at 3 M							
No.	Freq. (MHz)	Reading (dBm)	S.G Power Value (dBm)	Correction Factor (dB)	EIRP (dBm)	Limit (dBm)	Margin (dB)
1	1880.00	-12.0	28.6	0.0	28.6	62.14	-33.54

MODE		TX channel 19100					
Antenna Polarity & Test Distance: Horizontal at 3 M							
No.	Freq. (MHz)	Reading (dBm)	S.G Power Value (dBm)	Correction Factor (dB)	EIRP (dBm)	Limit (dBm)	Margin (dB)
1	1900.00	-11.1	29.6	-0.1	<b>29.5</b>	62.14	-32.64
Antenna Polarity & Test Distance: Vertical at 3 M							
No.	Freq. (MHz)	Reading (dBm)	S.G Power Value (dBm)	Correction Factor (dB)	EIRP (dBm)	Limit (dBm)	Margin (dB)
1	1900.00	-11.5	29.3	-0.1	29.2	62.14	-32.94

Note: EIRP (dBm) = S.G Power Value (dBm) + Correction Factor (dB).

## 4.2 Frequency Stability Measurement

### 4.2.1 Limits of Frequency Stability Measurement

The frequency stability shall be sufficient to ensure that the fundamental emission stays within the authorized frequency block.

### 4.2.2 Test Procedure

- a. Device is placed at the oven room. The oven room could control the temperatures and humidity. Power warm up is at least 15 min and power applied should perform before recording frequency error.
- b. EUT is connected the external power supply to control the AC input power. The test voltage range is from minimum to maximum working voltage. Each step shall be record the frequency error rate.
- c. The temperature range step is 10 degrees in this test items. All temperature levels shall be hold the  $\pm 0.5$  °C during the measurement testing. The each temperature step shall be at least 0.5 hours, consider the EUT could be test under the stability condition.

**Note:** The frequency error was recorded frequency error from the communication simulator.

### 4.2.3 Test Setup

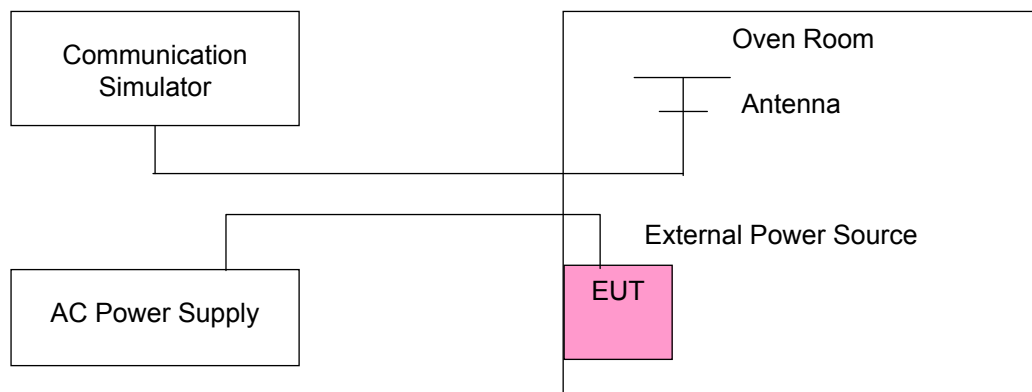

#### 4.2.4 Test Results

##### Frequency Error vs. Voltage

Voltage (Volts)	Frequency Error (ppm)	Limit (ppm)
	LTE Band 2	
138	-0.006	2.5
120	-0.004	2.5
102	-0.005	2.5

Note: The applicant defined the normal working voltage is from 102Vac to 138Vac.

##### Frequency Error vs. Temperature

Temp. (°C)	Frequency Error (ppm)	Limit (ppm)
	LTE Band 2	
60	-0.007	2.5
50	-0.006	2.5
40	-0.006	2.5
30	-0.005	2.5
20	-0.004	2.5
10	-0.005	2.5
0	-0.007	2.5
-10	-0.007	2.5
-20	-0.009	2.5

### 4.3 Occupied Bandwidth Measurement

#### 4.3.1 Test Procedure

The EUT makes a call to the communication simulator. All measurements were done at low, middle and high operational frequency range, The communication simulator station system controlled a EUT to export maximum output power under transmission mode and specific channel frequency. Use OBW measurement function of Spectrum analyzer to measure 99 % occupied bandwidth.

#### 4.3.2 Test Setup

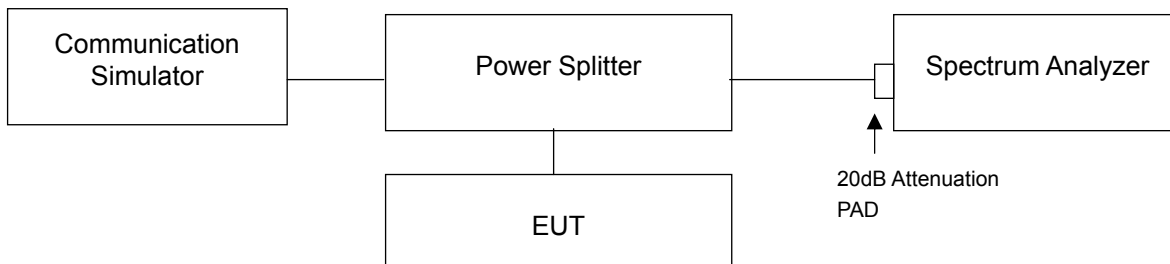

#### 4.3.3 Test Result

LTE Band 2							
Channel Bandwidth 1.4MHz				Channel Bandwidth 3MHz			
Channel	Frequency (MHz)	99% Occupied Bandwidth (MHz)		Channel	Frequency (MHz)	99% Occupied Bandwidth (MHz)	
		QPSK	16QAM			QPSK	16QAM
18607	1850.7	1.09	1.09	18615	1851.5	2.69	2.69
18900	1880	1.10	1.10	18900	1880	2.70	2.68
19193	1909.3	1.09	1.09	19185	1908.5	2.69	2.70
Channel Bandwidth 5MHz				Channel Bandwidth 10MHz			
Channel	Frequency (MHz)	99% Occupied Bandwidth (MHz)		Channel	Frequency (MHz)	99% Occupied Bandwidth (MHz)	
		QPSK	16QAM			QPSK	16QAM
18625	1852.5	4.48	4.48	18650	1855	8.93	8.97
18900	1880	4.48	4.48	18900	1880	8.97	8.93
19175	1907.5	4.47	4.48	19150	1905	8.97	8.93
Channel Bandwidth 15MHz				Channel Bandwidth 20MHz			
Channel	Frequency (MHz)	99% Occupied Bandwidth (MHz)		Channel	Frequency (MHz)	99% Occupied Bandwidth (MHz)	
		QPSK	16QAM			QPSK	16QAM
18675	1857.5	13.40	13.40	18700	1860	17.87	17.93
18900	1880	13.43	13.40	18900	1880	18.00	18.00
19125	1902.5	13.40	13.40	19100	1900	17.87	17.93



### Spectrum Plot Of Worst Value

#### 1.4MHz / QPSK

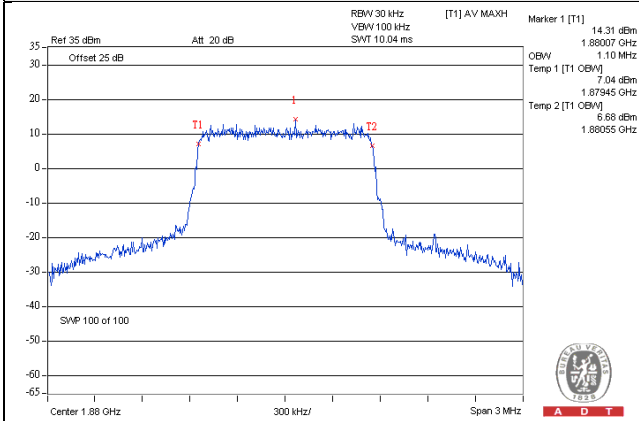

#### 3MHz / QPSK

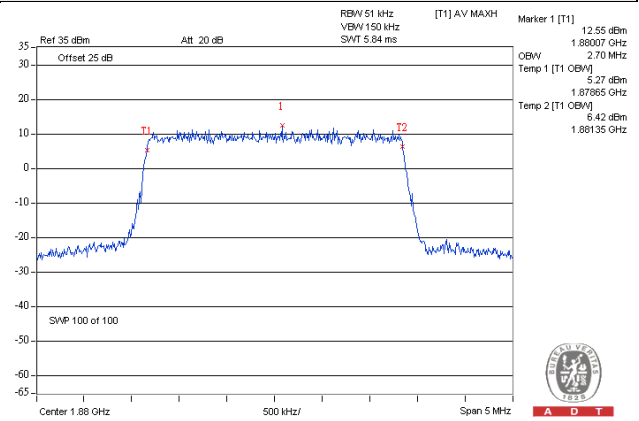

#### 5MHz / QPSK

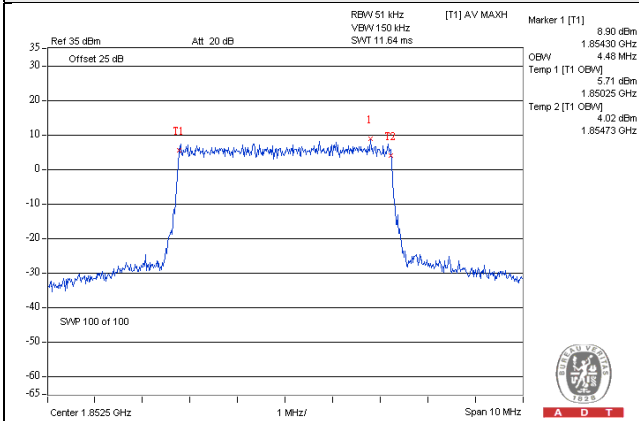

#### 10MHz / 16QAM

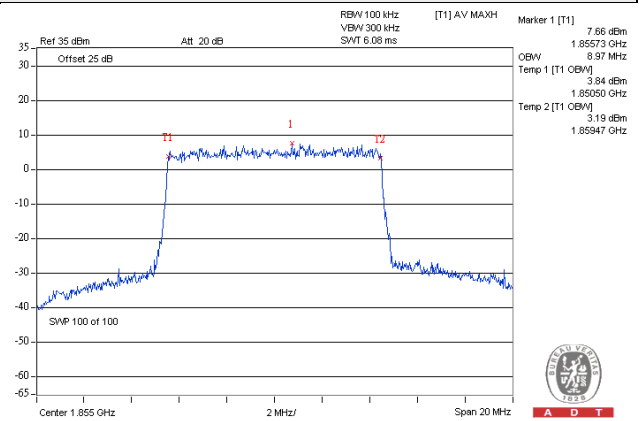

#### 15MHz / QPSK

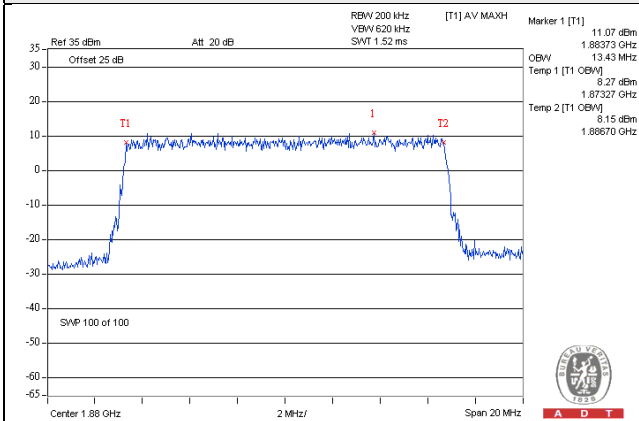

#### 20MHz / QPSK

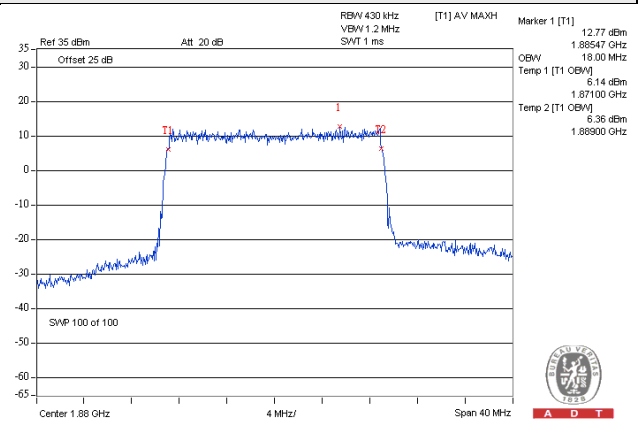

## 4.4 Band Edge Measurement

### 4.4.1 Limits of Band Edge Measurement

Power of any emission outside of the authorized operating frequency ranges must be attenuated below the transmitting power ( $P$ ) by a factor of at least  $43 + 10 \log(P)$  dB. In the 1 MHz bands immediately outside and adjacent to the frequency block a resolution bandwidth of at least one percent of the emission bandwidth of the fundamental emission of the transmitter may be employed.

### 4.4.2 Test Setup

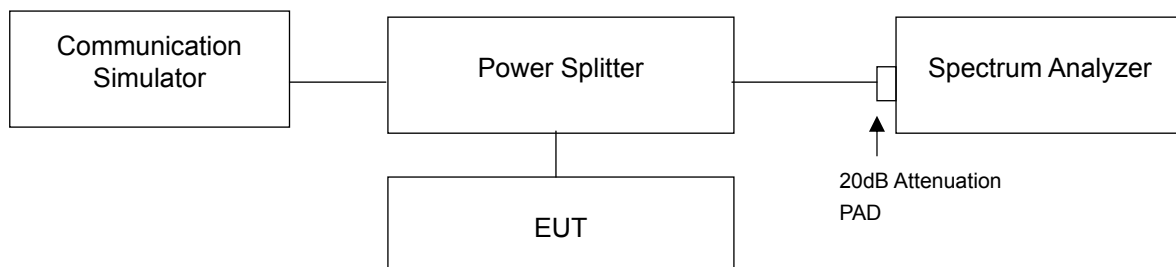

### 4.4.3 Test Procedures

- All measurements were done at low and high operational frequency range.
- The center frequency of spectrum is the band edge frequency and span is 1MHz. RB of the spectrum is 30kHz and VB of the spectrum is 100kHz (LTE Channel Bandwidth 1.4MHz and 3MHz).
- The center frequency of spectrum is the band edge frequency and span is 1MHz. RB of the spectrum is 51kHz and VB of the spectrum is 150kHz (LTE Channel Bandwidth 5MHz).
- The center frequency of spectrum is the band edge frequency and span is 1MHz. RB of the spectrum is 100kHz and VB of the spectrum is 300kHz (LTE Channel Bandwidth 10MHz).
- The center frequency of spectrum is the band edge frequency and span is 1MHz. RB of the spectrum is 200kHz and VB of the spectrum is 620kHz (LTE Channel Bandwidth 15MHz).
- The center frequency of spectrum is the band edge frequency and span is 1MHz. RB of the spectrum is 430kHz and VB of the spectrum is 1200kHz (LTE Channel Bandwidth 20MHz).
- Record the max trace plot into the test report.

### 4.4.4 Test Results

#### LTE Band 2

#### Channel Bandwidth 1.4MHz

Channel	18607	1 RB	Channel	19193	1 RB
---------	-------	------	---------	-------	------

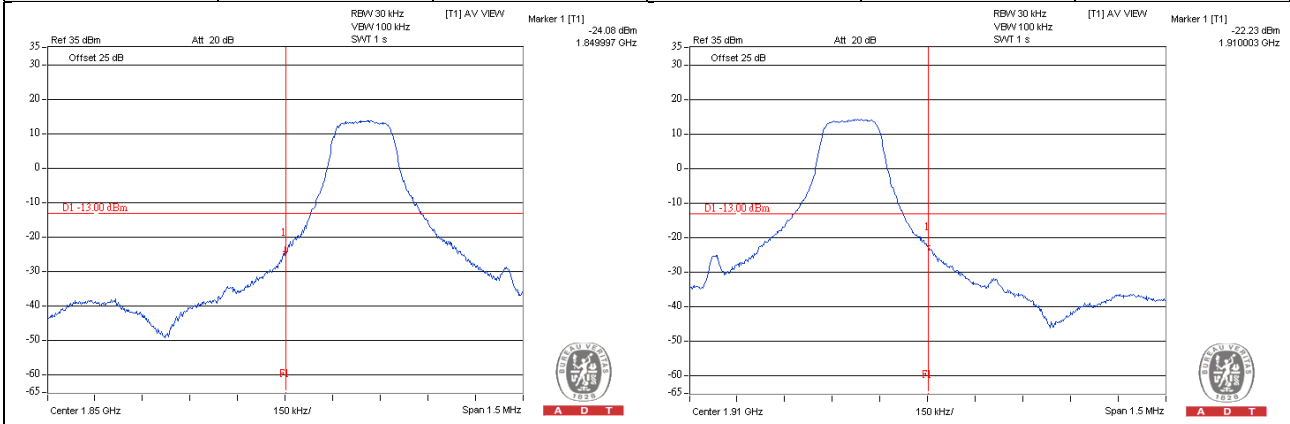

Channel	18607	6 RB	Channel	19193	6 RB
---------	-------	------	---------	-------	------

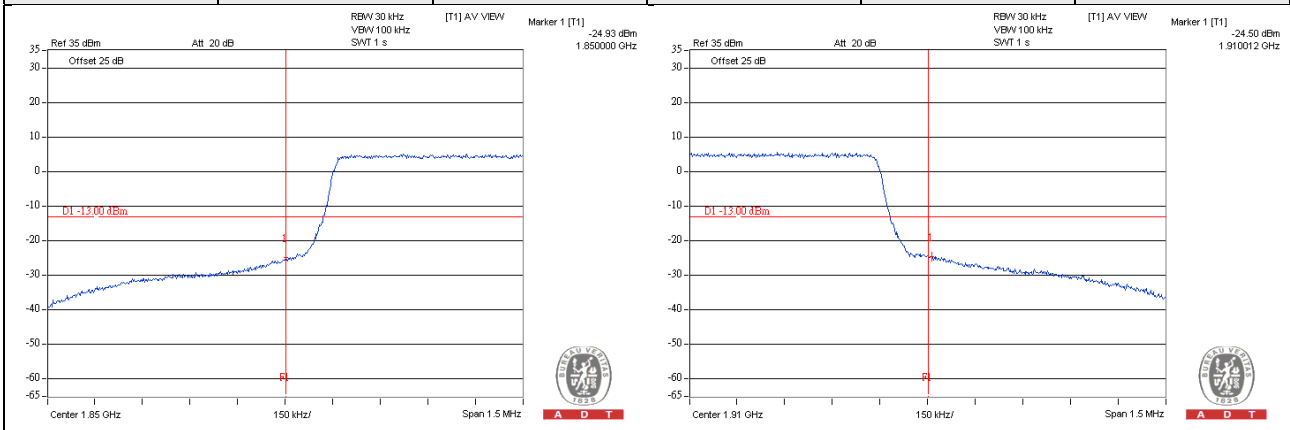

LTE Band 2

Channel Bandwidth 3MHz

Channel	18615	1 RB	Channel	19185	1 RB
---------	-------	------	---------	-------	------

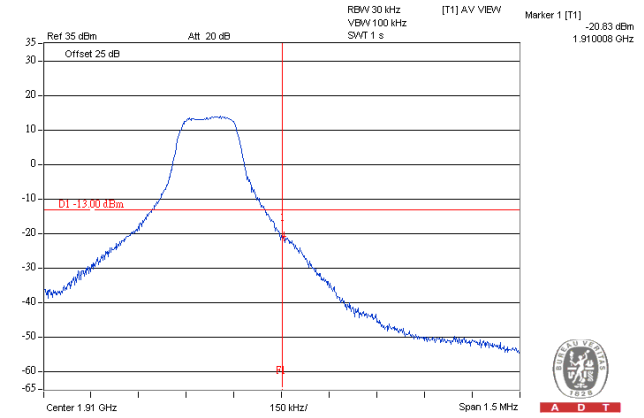
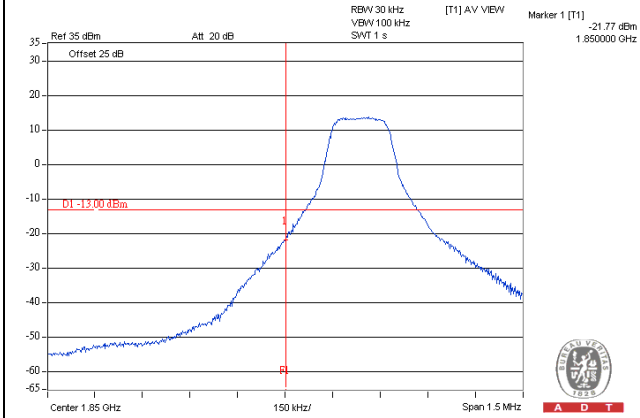

Channel	18615	15 RB	Channel	19185	15 RB
---------	-------	-------	---------	-------	-------

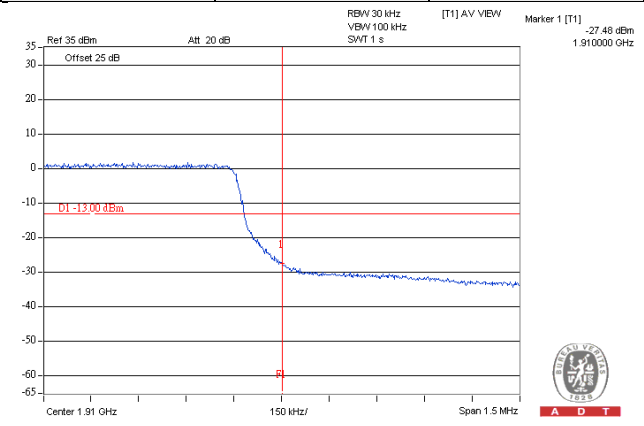
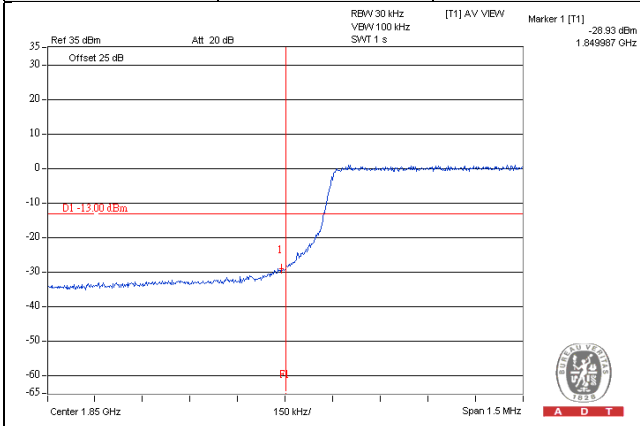

**LTE Band 2**

**Channel Bandwidth 5MHz**

Channel	18625	1 RB	Channel	19175	1 RB
---------	-------	------	---------	-------	------

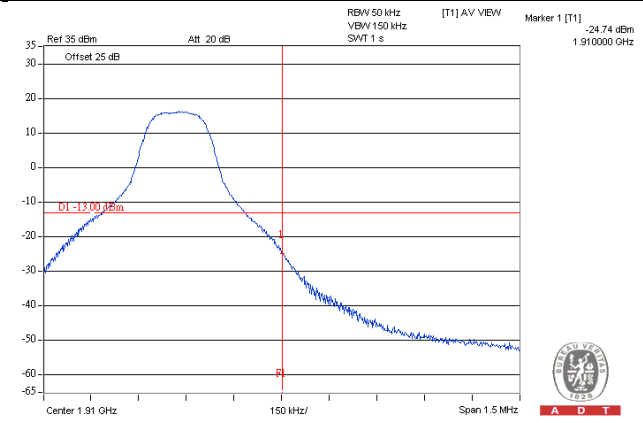
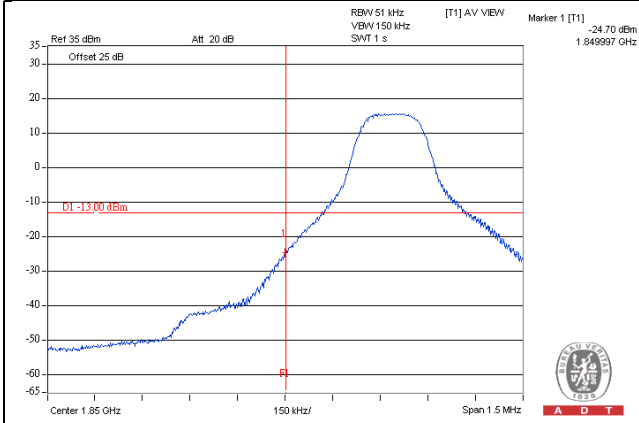

Channel	18625	25 RB	Channel	19175	25 RB
---------	-------	-------	---------	-------	-------

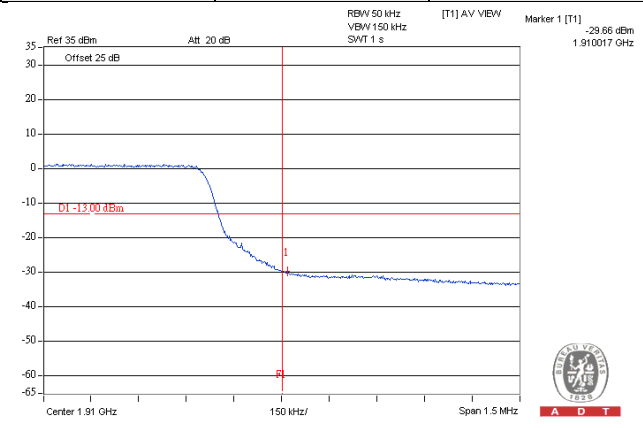
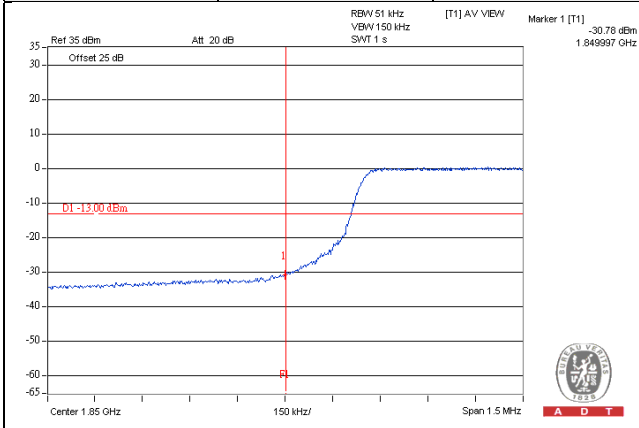

**LTE Band 2**

**Channel Bandwidth 10MHz**

Channel	18650	1 RB	Channel	19150	1 RB
---------	-------	------	---------	-------	------

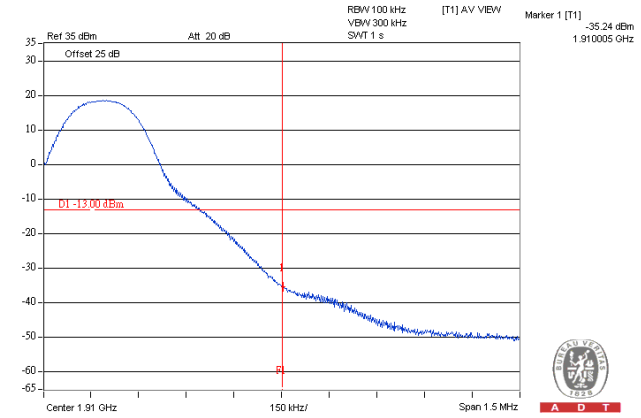
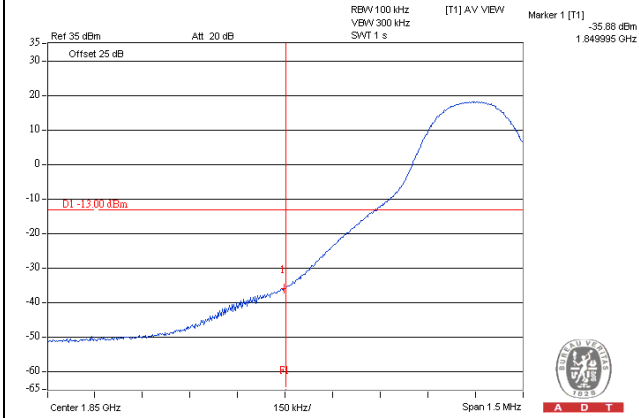

Channel	18650	50 RB	Channel	19150	50 RB
---------	-------	-------	---------	-------	-------

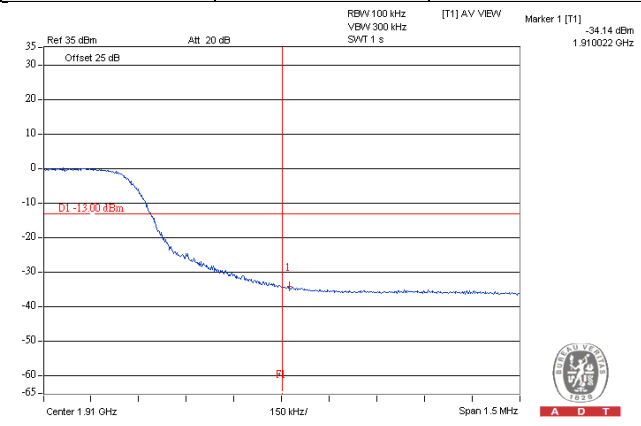
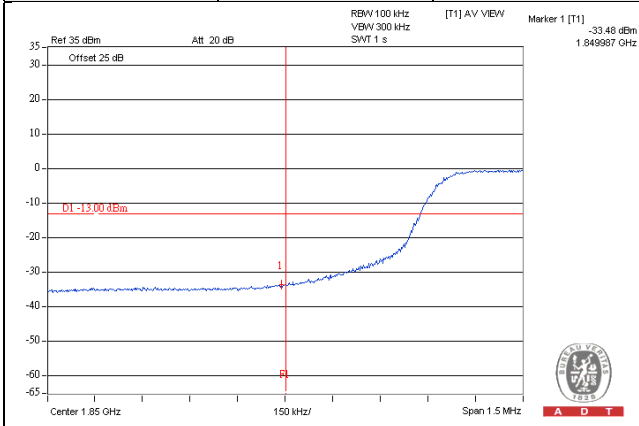

**LTE Band 2**

**Channel Bandwidth 15MHz**

Channel	18675	1 RB	Channel	19125	1 RB
---------	-------	------	---------	-------	------

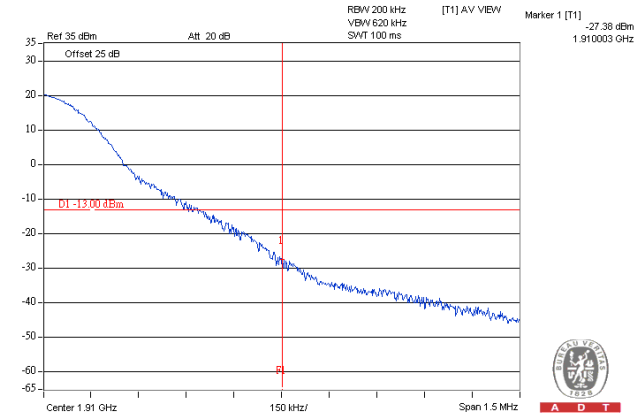
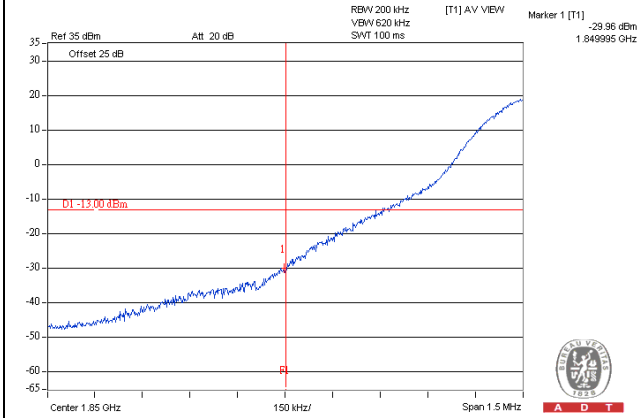

Channel	18675	75 RB	Channel	19125	75 RB
---------	-------	-------	---------	-------	-------

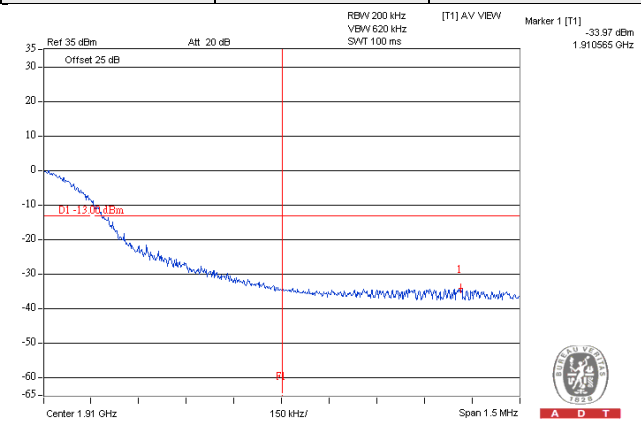
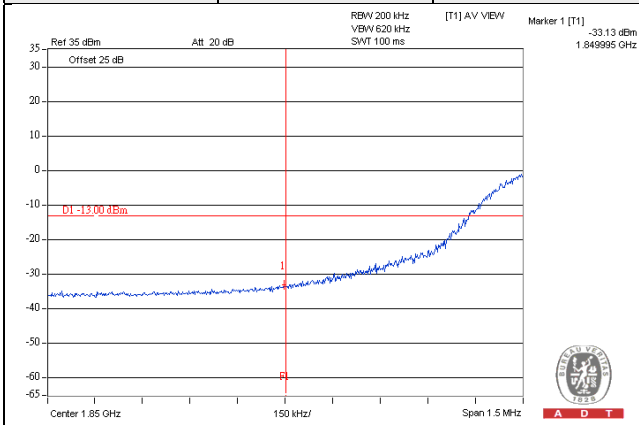

**LTE Band 2**

**Channel Bandwidth 20MHz**

Channel	18700	1 RB	Channel	19100	1 RB
---------	-------	------	---------	-------	------

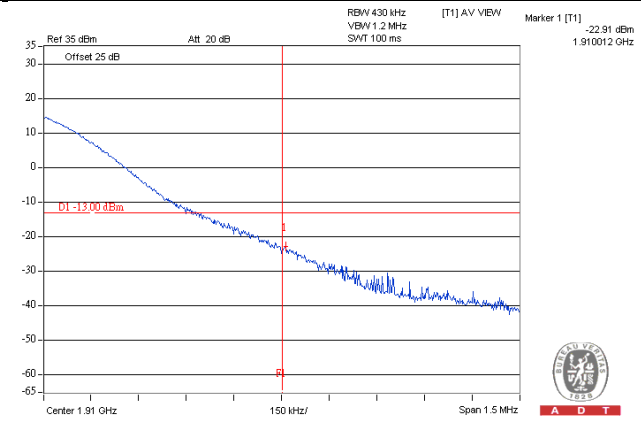
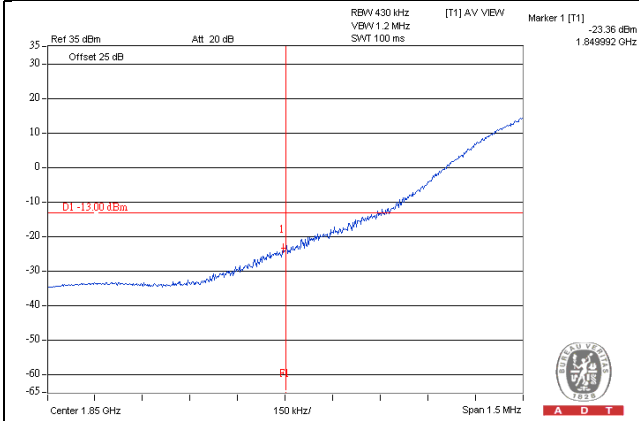

Channel	18700	100 RB	Channel	19100	100 RB
---------	-------	--------	---------	-------	--------

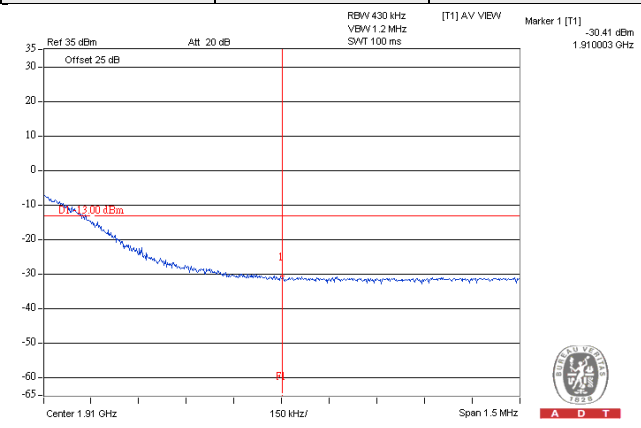
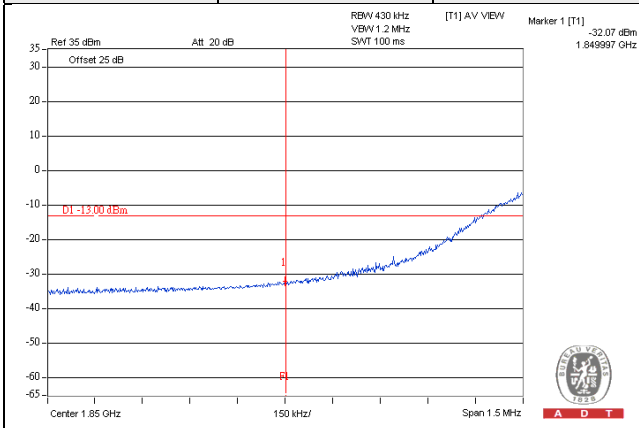



## 4.5 Peak To Average Ratio

### 4.5.1 Limits of Peak To Average Ratio Measurement

In measuring transmissions in this band using an average power technique, the peak to-average ratio (PAR) of the transmission may not exceed 13 dB

### 4.5.2 Test Setup

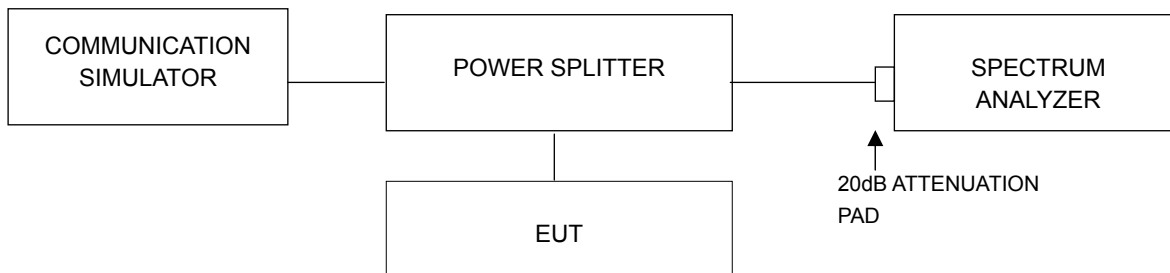

### 4.5.3 Test Procedures

- Set resolution/measurement bandwidth  $\geq$  signal's occupied bandwidth;
- Set the number of counts to a value that stabilizes the measured CCDF curve;
- Record the maximum PAPR level associated with a probability of 0.1%.

#### 4.5.4 Test Results

LTE Band 2							
Channel Bandwidth 1.4MHz				Channel Bandwidth 3MHz			
Channel	Frequency (MHz)	Peak To Average Ratio (dB)		Channel	Frequency (MHz)	Peak To Average Ratio (dB)	
		QPSK	16QAM			QPSK	16QAM
18607	1850.7	5.99	5.89	18615	1851.5	5.72	5.72
18900	1880	5.98	5.90	18900	1880	5.70	5.71
19193	1909.3	6.19	6.18	19185	1908.5	5.87	5.91
Channel Bandwidth 5MHz				Channel Bandwidth 10MHz			
Channel	Frequency (MHz)	Peak To Average Ratio (dB)		Channel	Frequency (MHz)	Peak To Average Ratio (dB)	
		QPSK	16QAM			QPSK	16QAM
18625	1852.5	5.49	5.48	18650	1855	5.57	5.54
18900	1880	5.59	5.48	18900	1880	5.73	5.72
19175	1907.5	5.58	5.50	19150	1905	5.55	5.55
Channel Bandwidth 15MHz				Channel Bandwidth 20MHz			
Channel	Frequency (MHz)	99% Occupied Bandwidth (MHz)		Channel	Frequency (MHz)	99% Occupied Bandwidth (MHz)	
		QPSK	16QAM			QPSK	16QAM
18675	1857.5	5.48	5.47	18700	1860	5.33	5.33
18900	1880	5.75	5.75	18900	1880	5.62	5.62
19125	1902.5	5.54	5.54	19100	1900	5.39	5.38



A D T

### Spectrum Plot Of Worst Value

#### 1.4MHz / QPSK

#### 3MHz / 16QAM

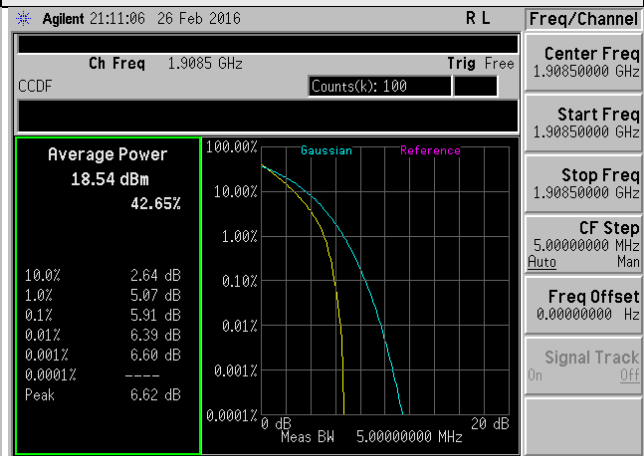
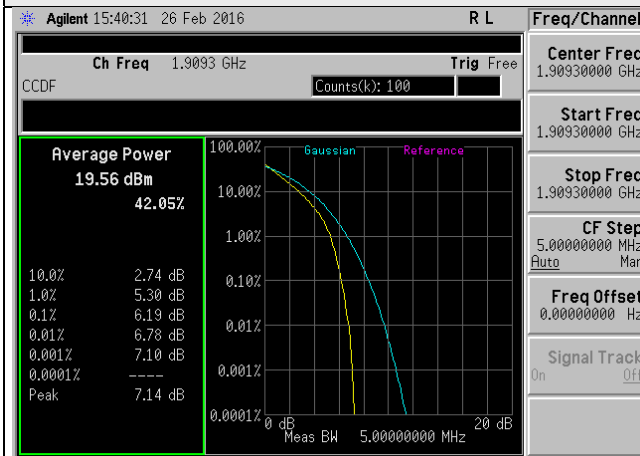

#### 5MHz / QPSK

#### 10MHz / QPSK

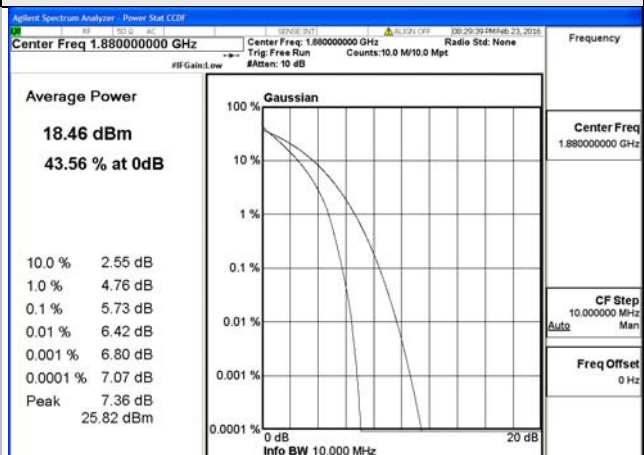
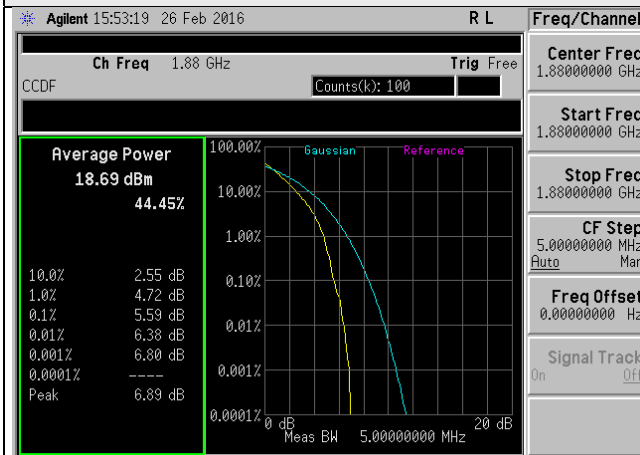

#### 15MHz / QPSK

#### 20MHz / QPSK

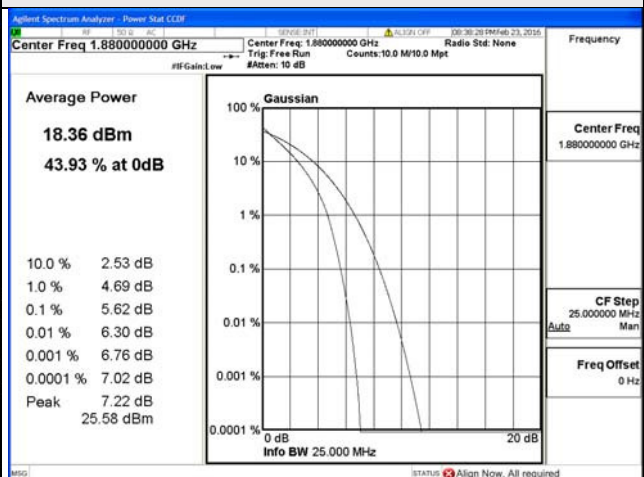
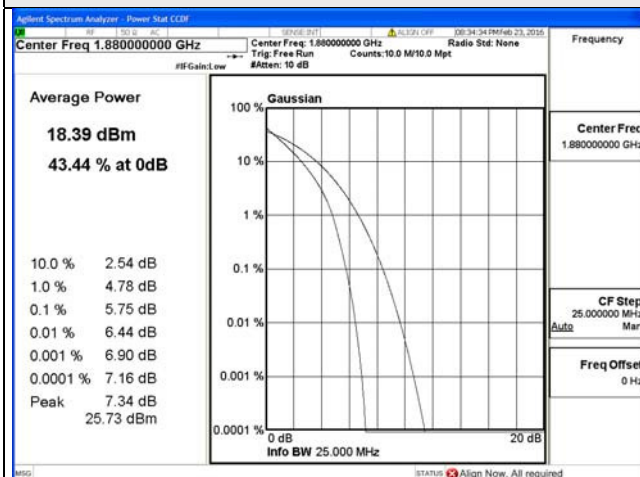

## 4.6 Conducted Spurious Emissions

### 4.6.1 Limits of Conducted Spurious Emissions Measurement

The power of any emission outside of the authorized operating frequency ranges must be attenuated below the transmitting power ( $P$ ) by a factor of at least  $43 + 10 \log(P)$  dB. The emission limit equal to  $-13\text{dBm}$ .

### 4.6.2 Test Setup

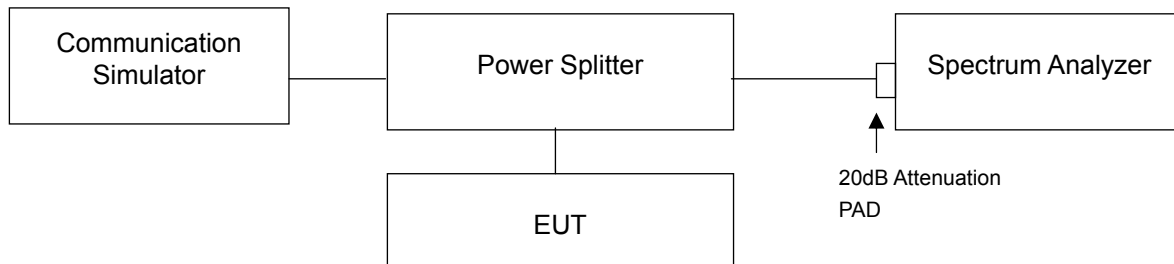

### 4.6.3 Test Procedure

- The EUT makes a phone call to the communication simulator. All measurements were done at low, middle and high operational frequency range.
- Measuring frequency range is from 9 kHz to 20GHz. 20dB attenuation pad is connected with spectrum. RBW=1MHz and VBW=3MHz is used for conducted emission measurement.

### 4.6.4 Test Results

LTE Band 2 Channel Band width: 1.4MHz

Channel 18607

Frequency Range : 9kHz~3GHz

Frequency Range : 3GHz~10GHz

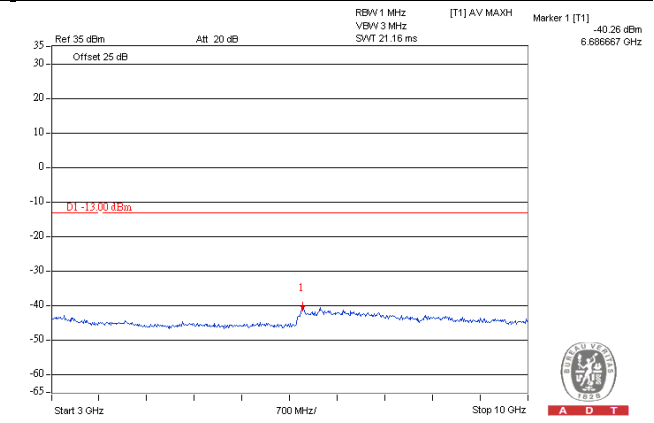
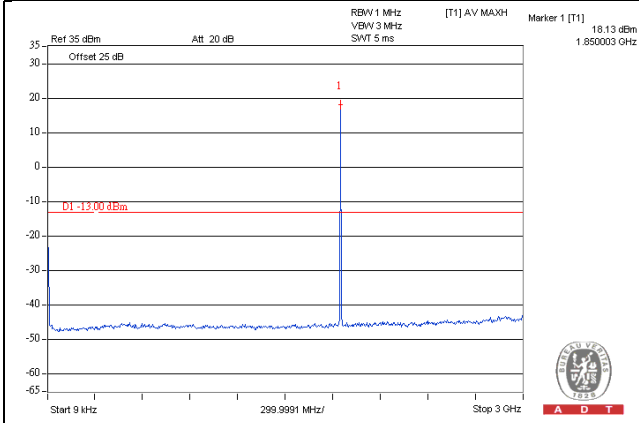

Frequency Range : 10GHz~20GHz

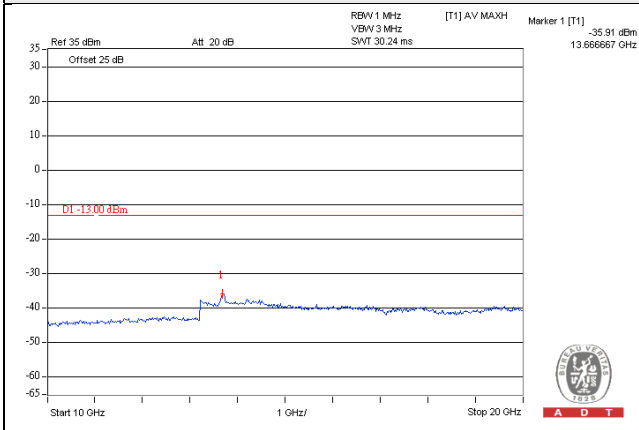

LTE Band 2 Channel Band width: 1.4MHz

Channel 18900

Frequency Range : 9kHz~3GHz

Frequency Range : 3GHz~10GHz

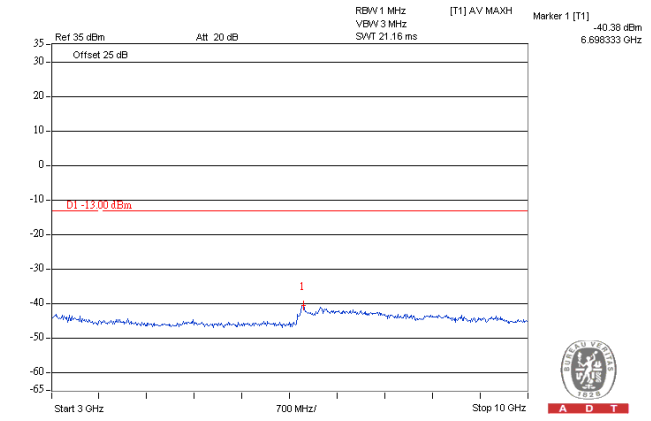
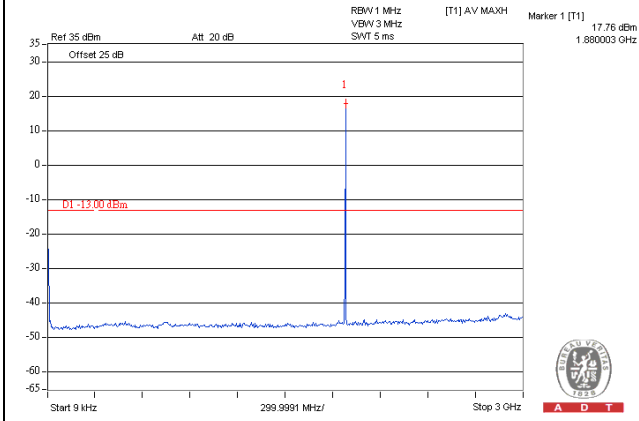

Frequency Range : 10GHz~20GHz

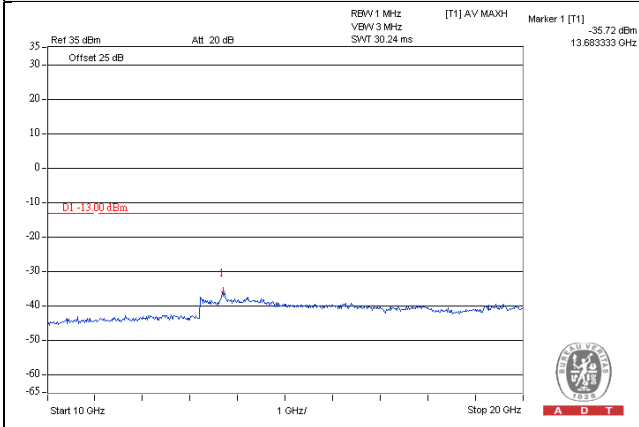

LTE Band 2 Channel Band width: 1.4MHz

Channel 19193

Frequency Range : 9kHz~3GHz

Frequency Range : 3GHz~10GHz

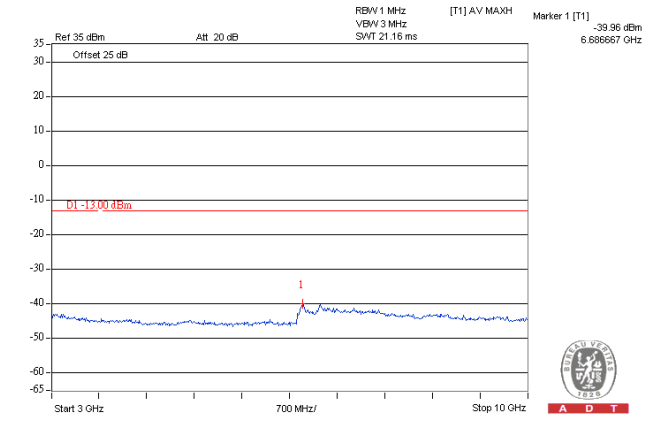
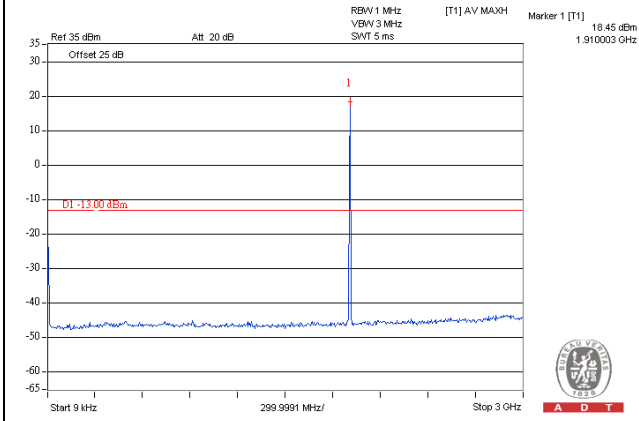

Frequency Range : 10GHz~20GHz

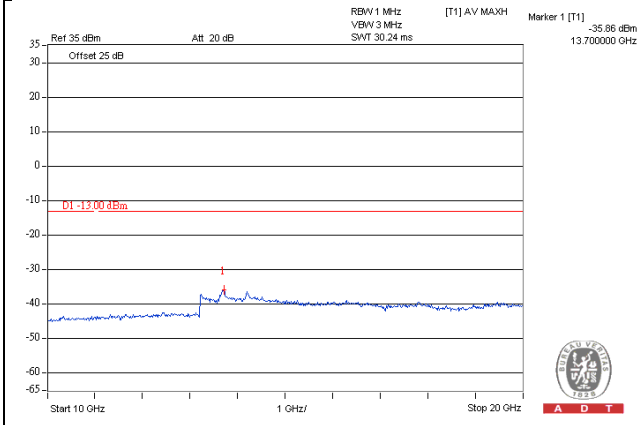

LTE Band 2 Channel Band width: 3MHz

Channel 18615

Frequency Range : 9kHz~3GHz

Frequency Range : 3GHz~10GHz

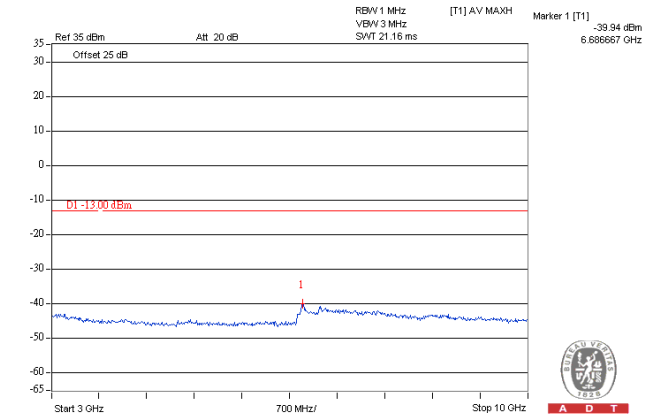
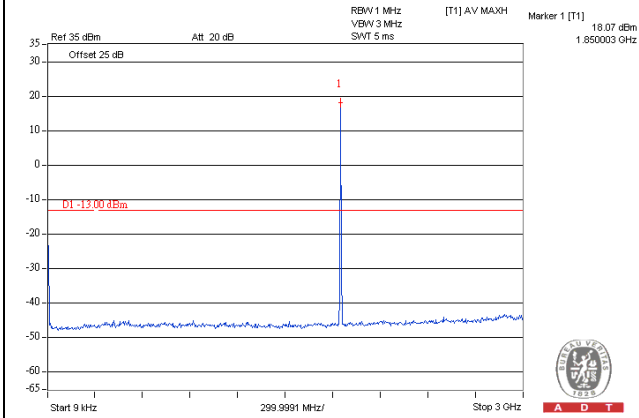

Frequency Range : 10GHz~20GHz

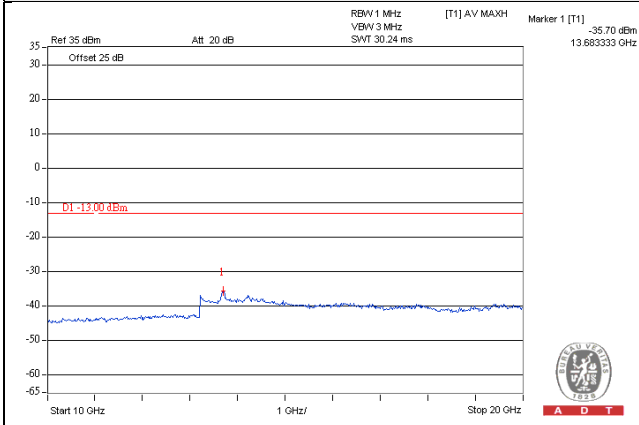

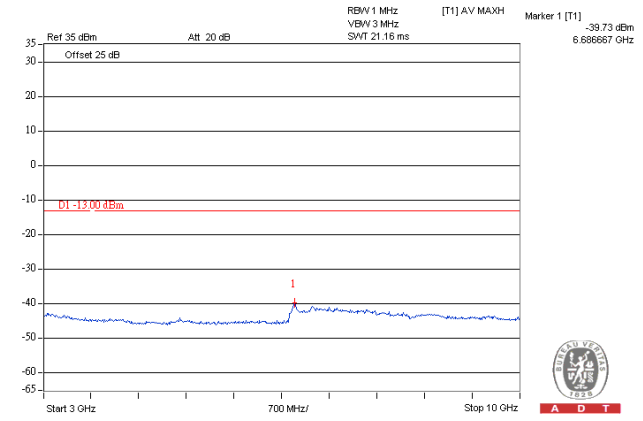
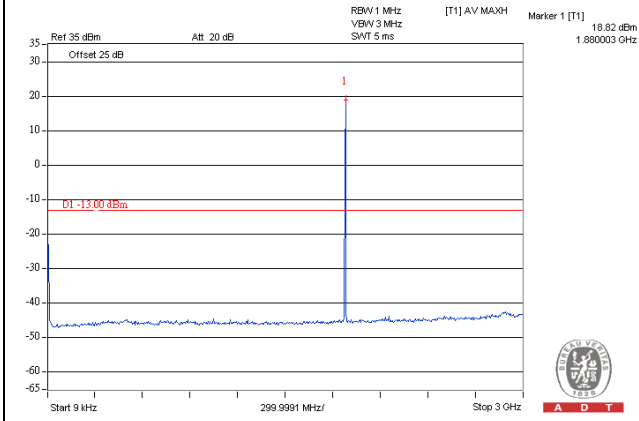
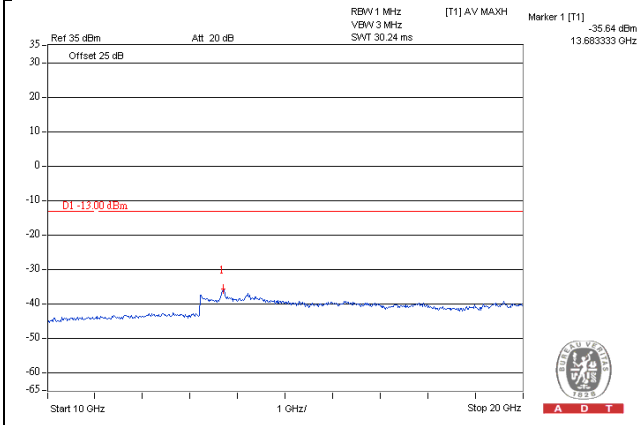

**LTE Band 2 Channel Band width: 3MHz****Channel 18900****Frequency Range : 9kHz~3GHz****Frequency Range : 3GHz~10GHz****Frequency Range : 10GHz~20GHz**

LTE Band 2 Channel Band width: 3MHz

Channel 19185

Frequency Range : 9kHz~3GHz

Frequency Range : 3GHz~10GHz

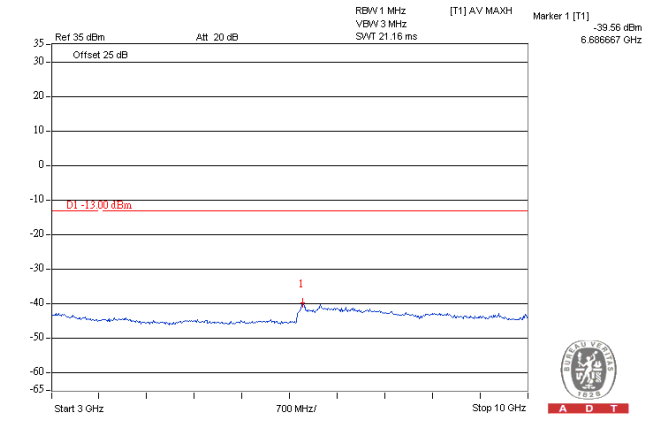
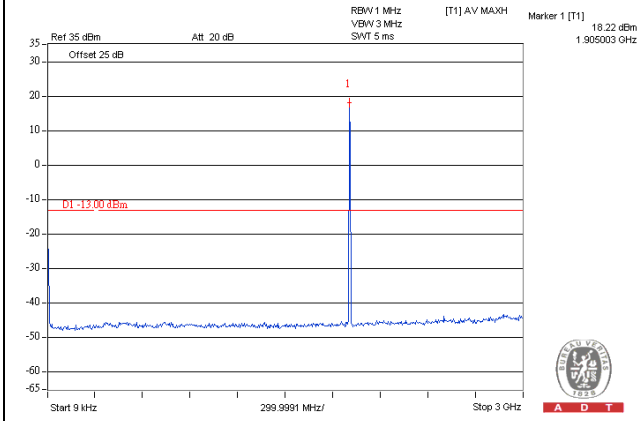

Frequency Range : 10GHz~20GHz

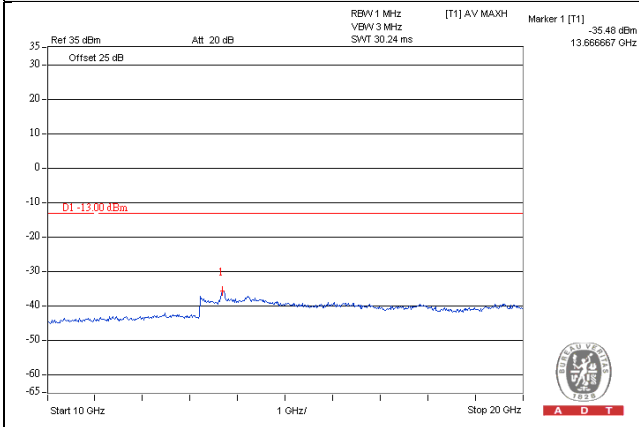

LTE Band 2 Channel Band width: 5MHz

Channel 18625

Frequency Range : 9kHz~3GHz

Frequency Range : 3GHz~10GHz

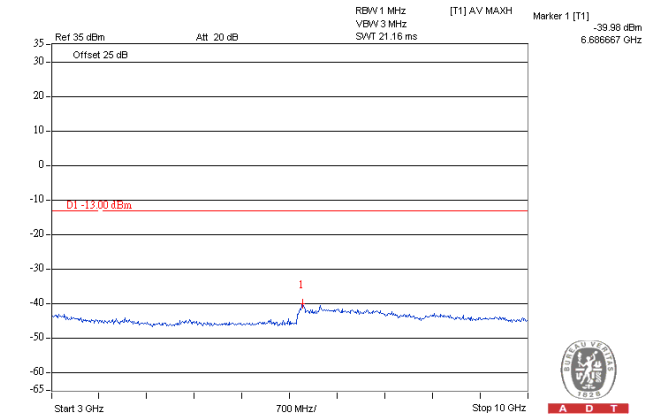
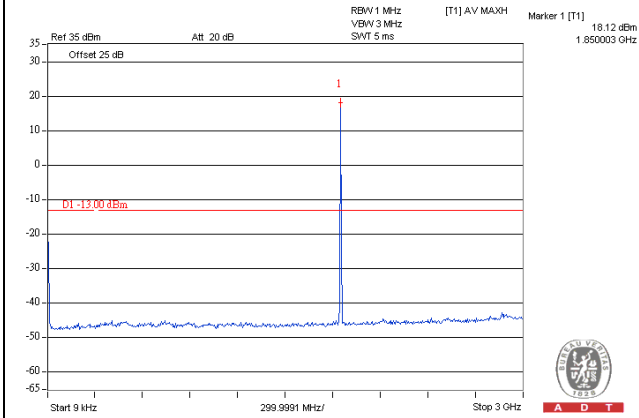

Frequency Range : 10GHz~20GHz

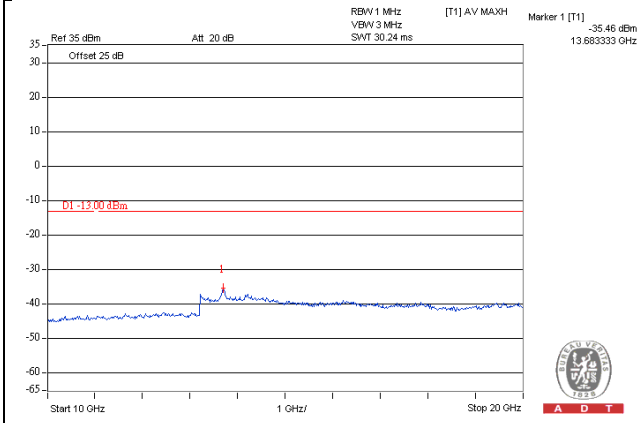

LTE Band 2 Channel Band width: 5MHz

Channel 18900

Frequency Range : 9kHz~3GHz

Frequency Range : 3GHz~10GHz

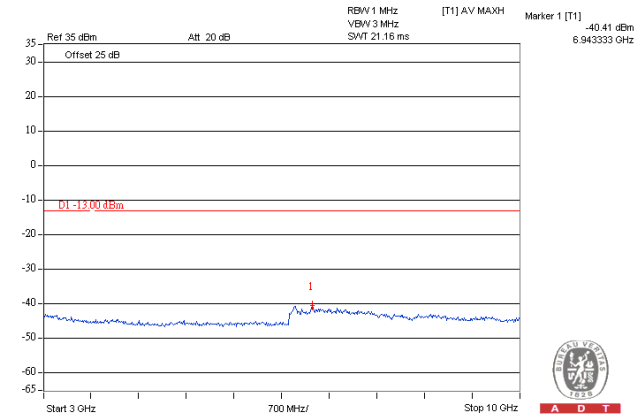
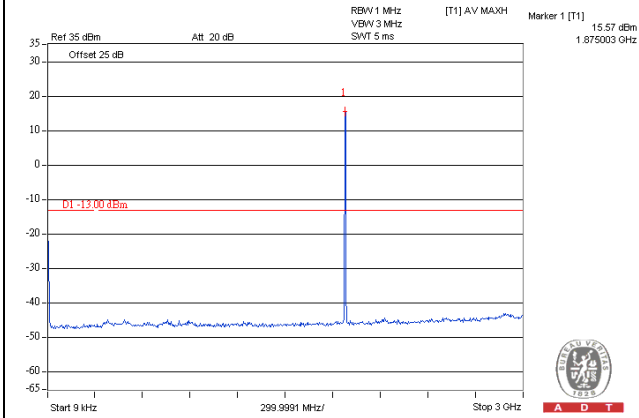

Frequency Range : 10GHz~20GHz

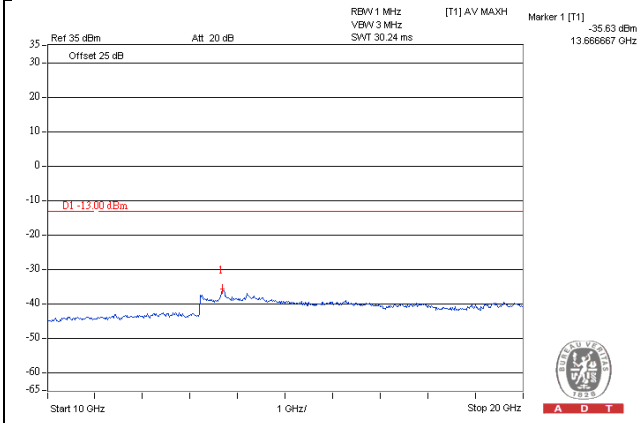

LTE Band 2 Channel Band width: 5MHz

Channel 19175

Frequency Range : 9kHz~3GHz

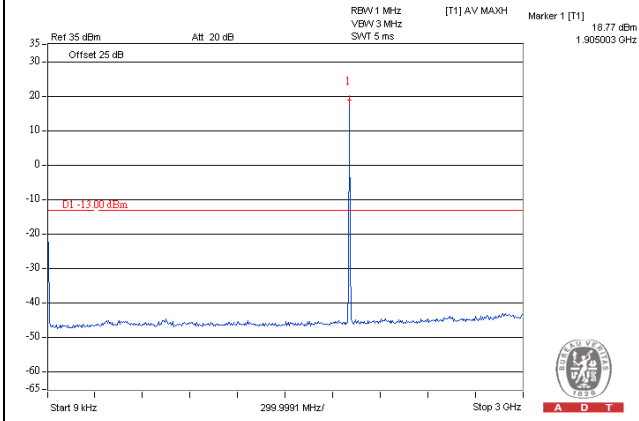

Frequency Range : 3GHz~10GHz

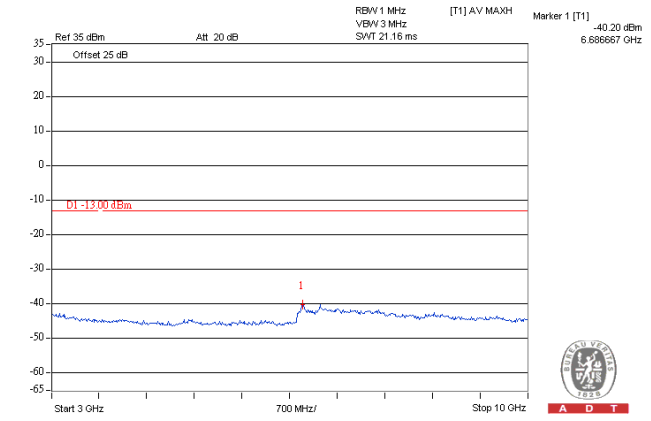

Frequency Range : 10GHz~20GHz

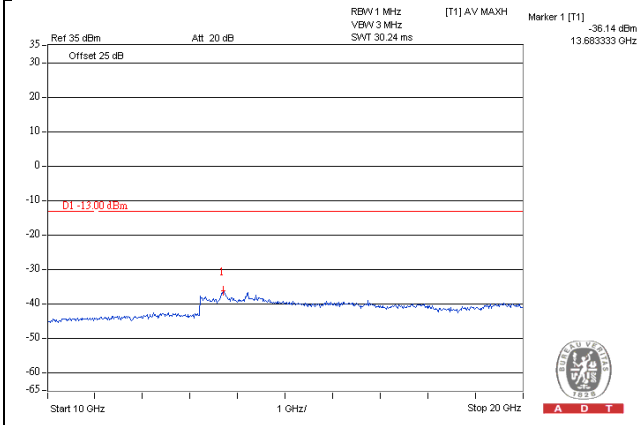

LTE Band 2 Channel Band width: 10MHz

Channel 18650

Frequency Range : 9kHz~3GHz

Frequency Range : 3GHz~10GHz

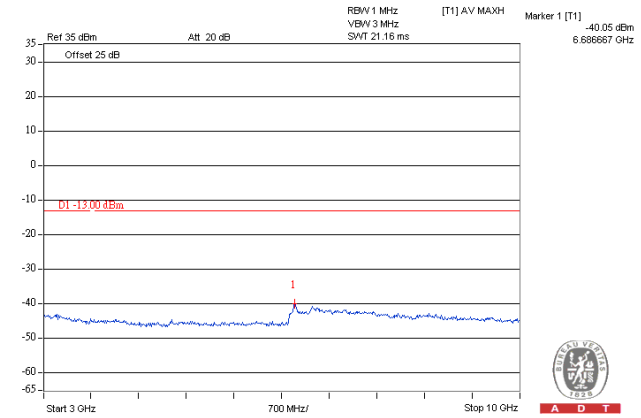
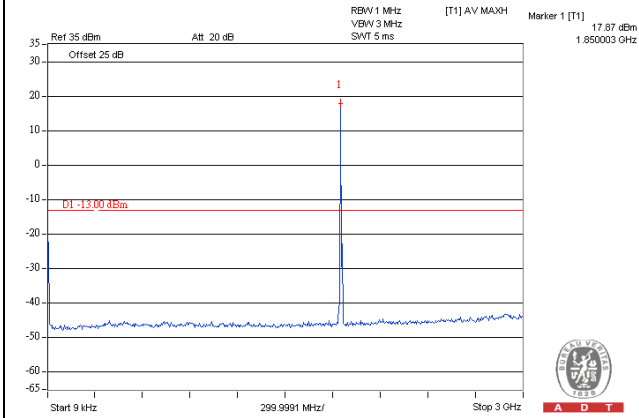

Frequency Range : 10GHz~20GHz

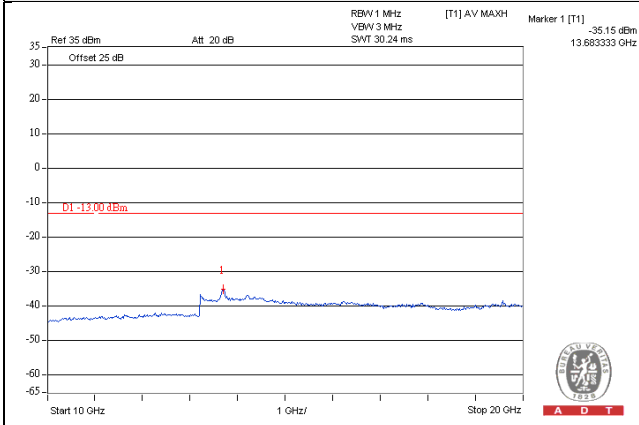

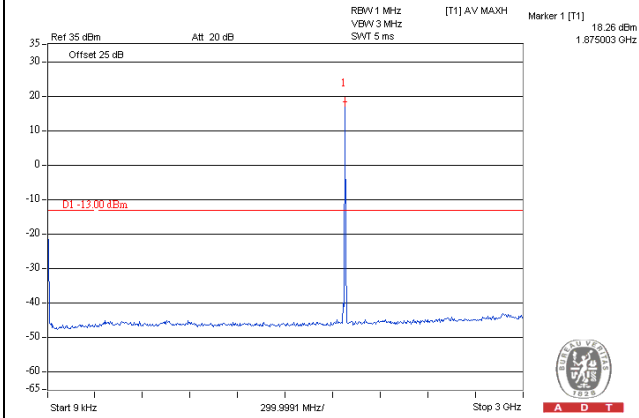
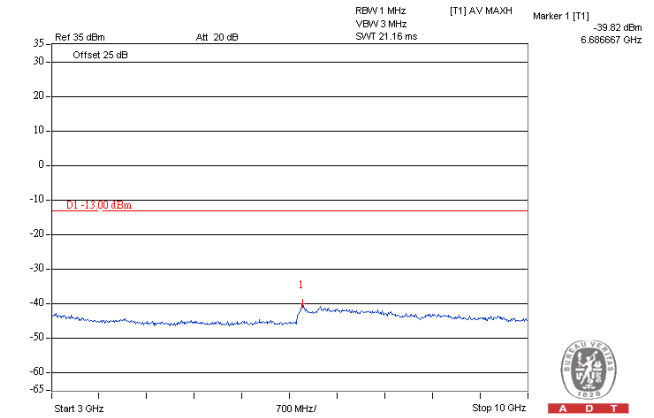
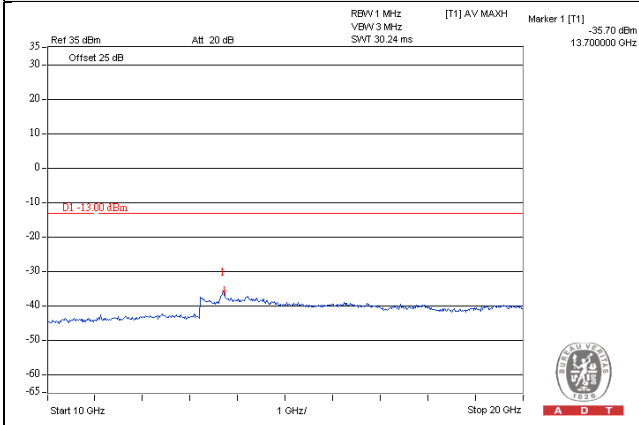
**LTE Band 2 Channel Band width: 10MHz****Channel 18900****Frequency Range : 9kHz~3GHz****Frequency Range : 3GHz~10GHz****Frequency Range : 10GHz~20GHz**

LTE Band 2 Channel Band width: 10MHz

Channel 19150

Frequency Range : 9kHz~3GHz

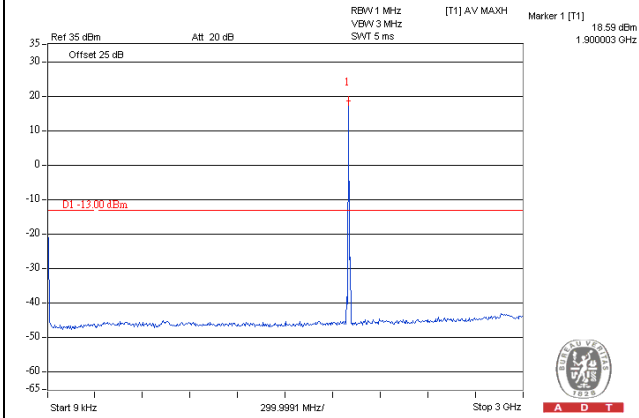

Frequency Range : 3GHz~10GHz

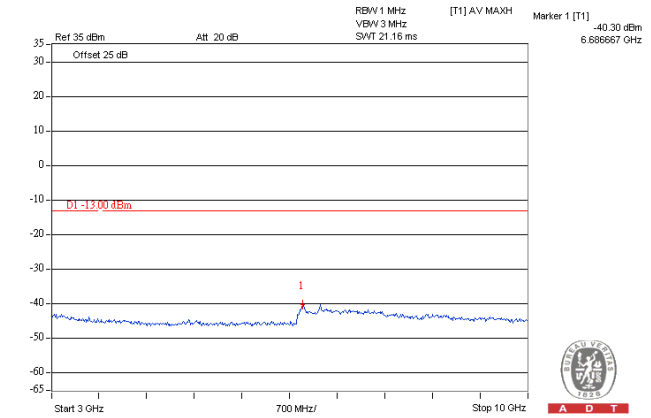

Frequency Range : 10GHz~20GHz

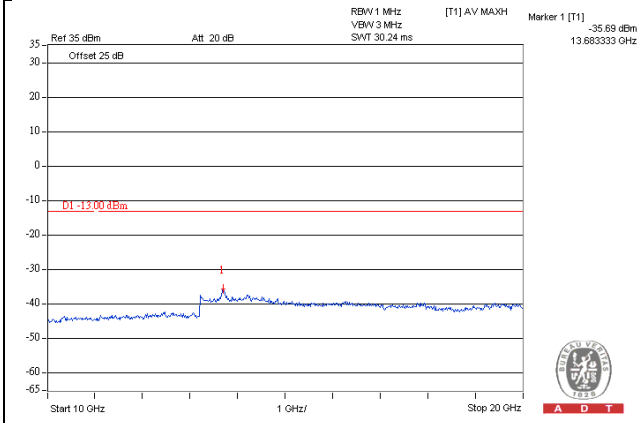



LTE Band 2 Channel Band width: 15MHz

Channel 18675

Frequency Range : 9kHz~3GHz

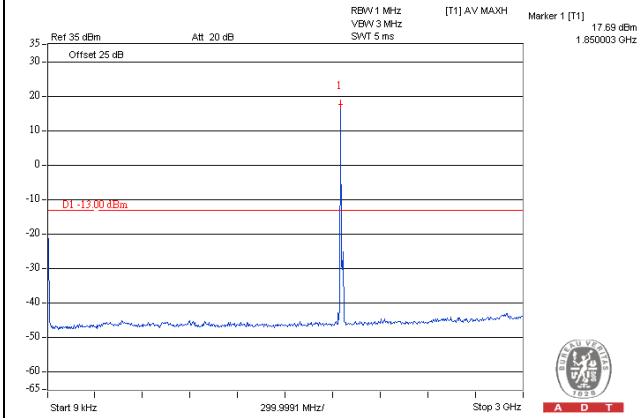

Frequency Range : 3GHz~10GHz

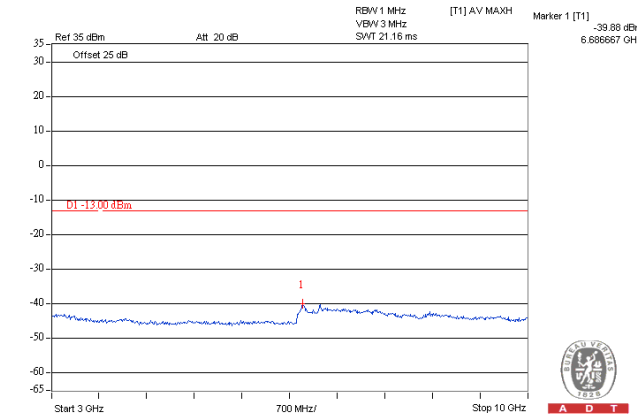

Frequency Range : 10GHz~20GHz

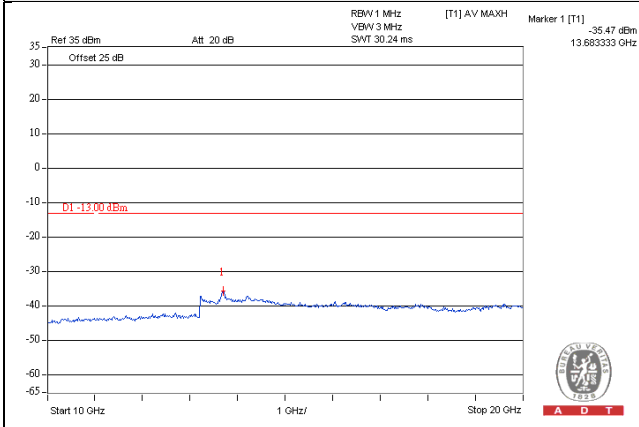

LTE Band 2 Channel Band width: 15MHz

Channel 18900

Frequency Range : 9kHz~3GHz

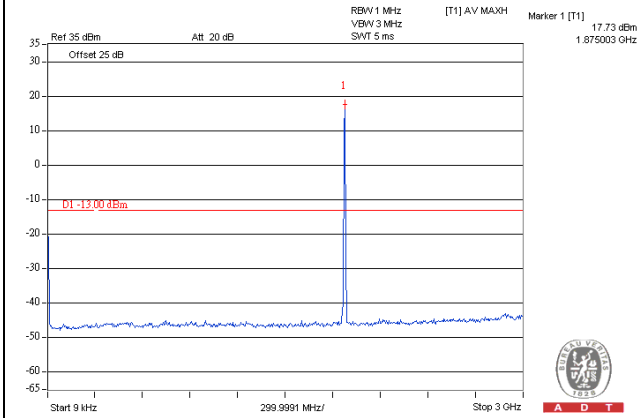

Frequency Range : 3GHz~10GHz

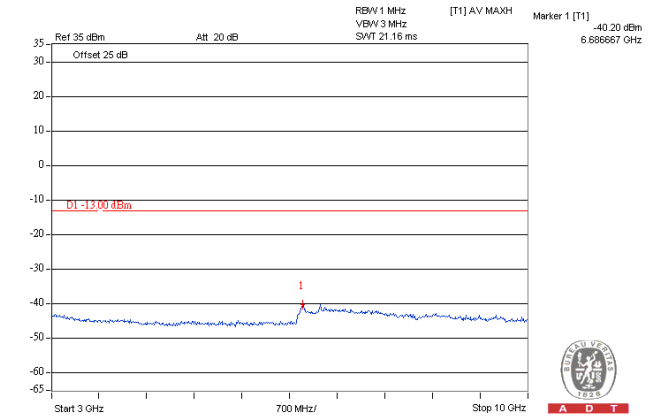

Frequency Range : 10GHz~20GHz

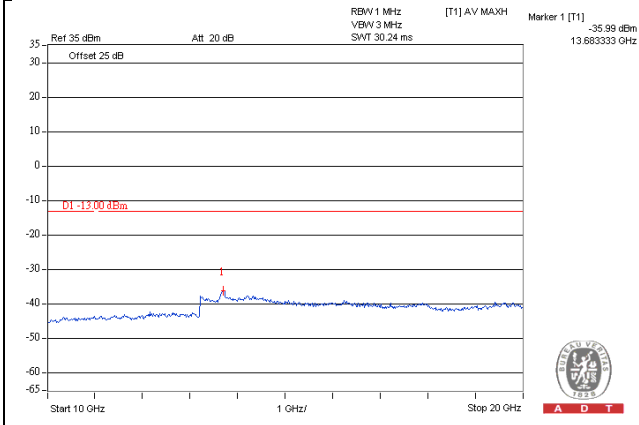

LTE Band 2 Channel Band width: 15MHz

Channel 19125

Frequency Range : 9kHz~3GHz

Frequency Range : 3GHz~10GHz

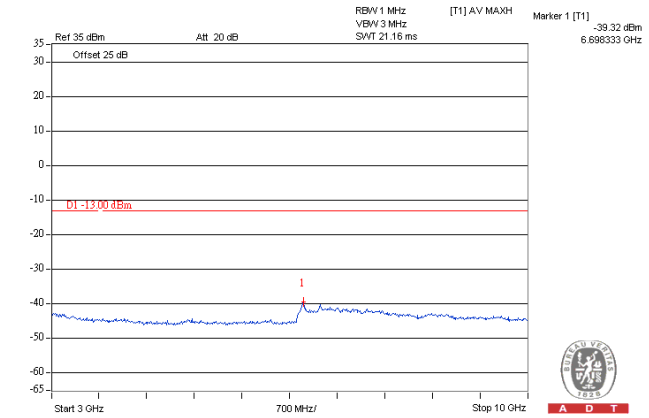
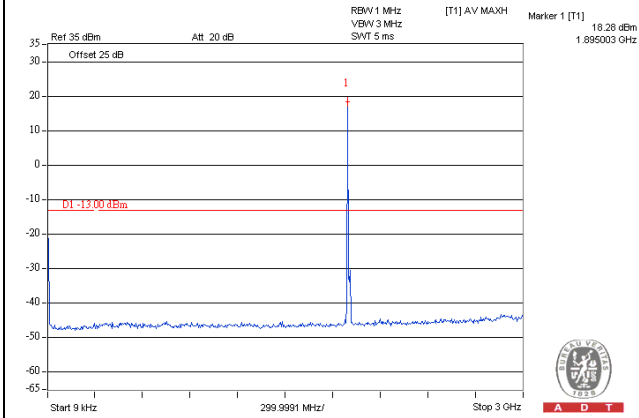

Frequency Range : 10GHz~20GHz

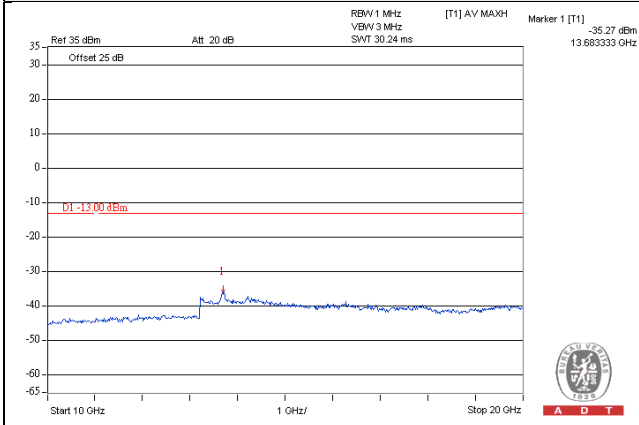

LTE Band 2 Channel Band width: 20MHz

Channel 18700

Frequency Range : 9kHz~3GHz

Frequency Range : 3GHz~10GHz

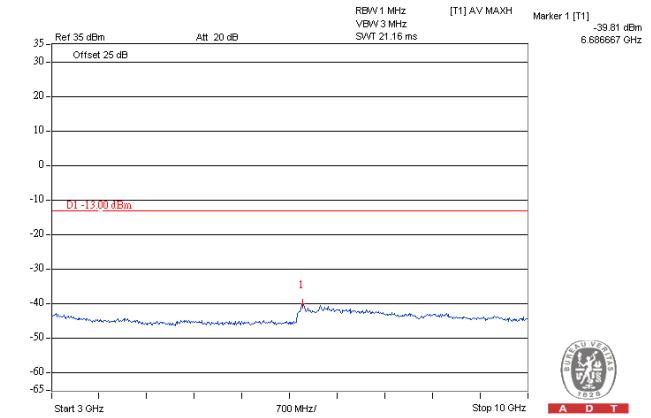
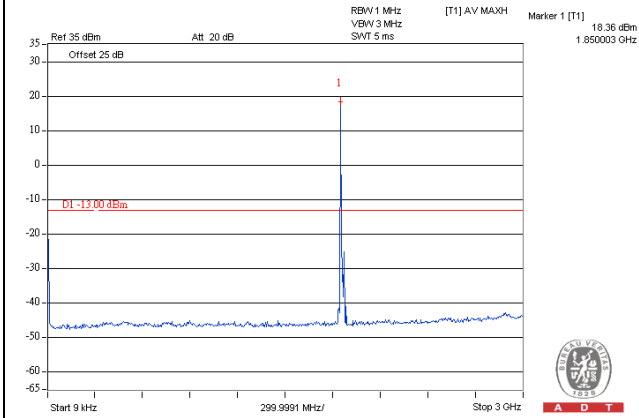

Frequency Range : 10GHz~20GHz

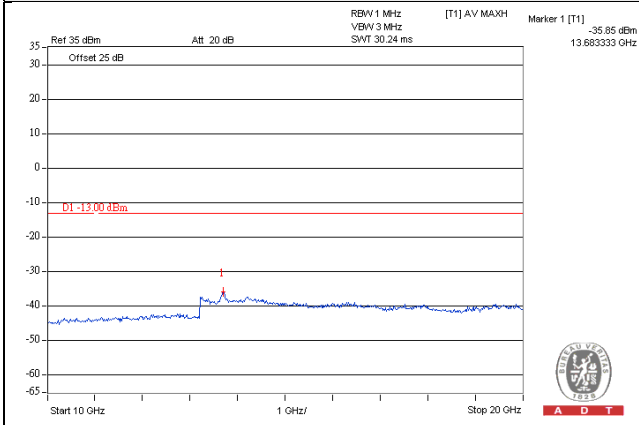

LTE Band 2 Channel Band width: 20MHz

Channel 18900

Frequency Range : 9kHz~3GHz

Frequency Range : 3GHz~10GHz

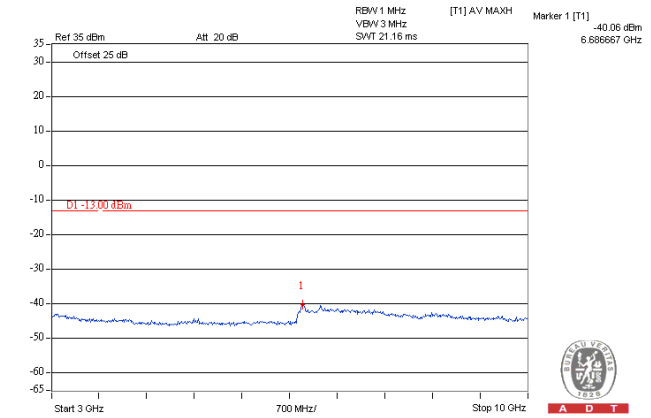
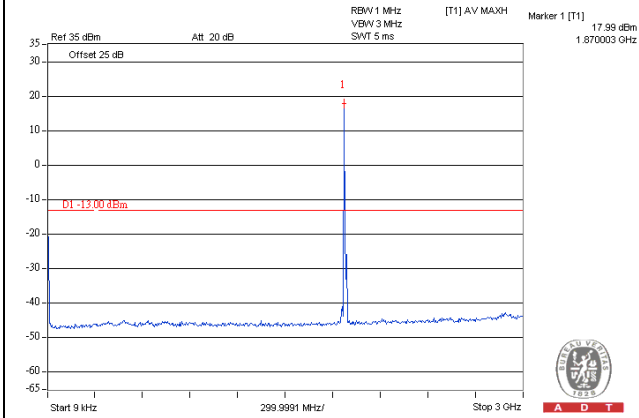

Frequency Range : 10GHz~20GHz

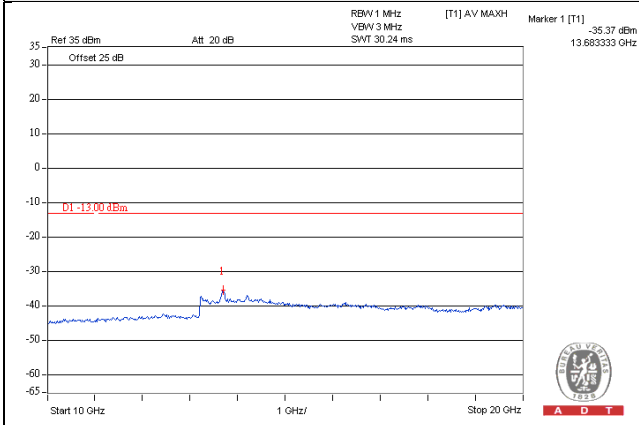

LTE Band 2 Channel Band width: 20MHz

Channel 19100

Frequency Range : 9kHz~3GHz

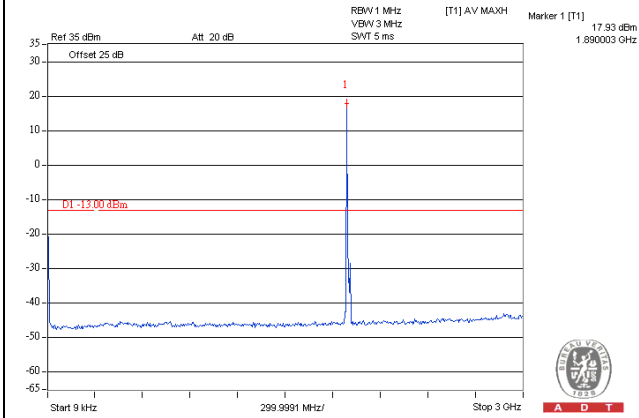

Frequency Range : 3GHz~10GHz

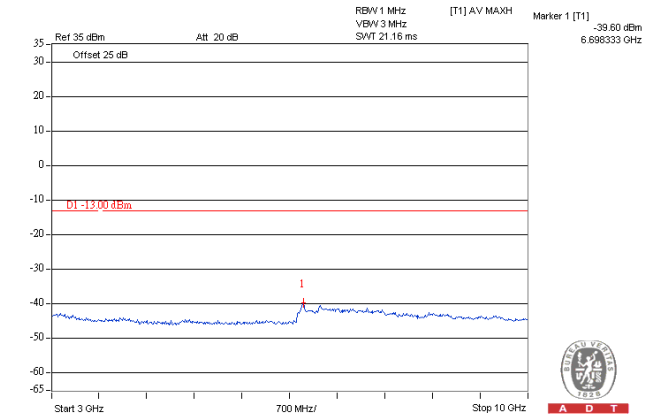

Frequency Range : 10GHz~20GHz

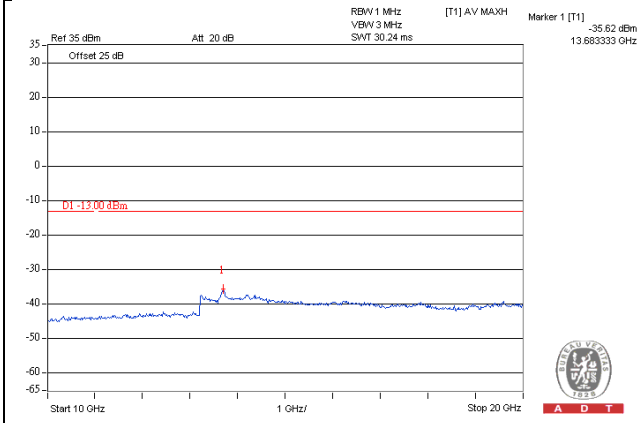

## 4.7 Radiated Emission Measurement

### 4.7.1 Limits of Radiated Emission Measurement

The power of any emission outside of the authorized operating frequency ranges must be attenuated below the transmitting power (P) by a factor of at least  $43 + 10 \log(P)$  dB. The emission limit equal to  $-13\text{dBm}$ .

### 4.7.2 Test Procedure

- a. Substitution method is used for E.I.R.P measurement. In the semi-anechoic chamber, EUT placed on the 0.8m height of Turn Table, rotated the table around 360 degrees to search the maximum radiation power and receiver antenna shall be rotated vertical and horizontal polarization and moved height from 1m to 4m to find the maximum polar radiated power. The "Read Value" is the spectrum reading the maximum power value.
- b. The substitution horn antenna is substituted for EUT at the same position and signals generator export the CW signal to the substitution antenna via a TX cable. Rotated the Turn Table and moved receiving antenna to find the maximum radiation power. Adjust output power level of S.G to get a Value of spectrum reading equal to "Read Value" of step a. Record the power level of S.G
- c.  $\text{EIRP} = \text{Output power level of S.G} - \text{TX cable loss} + \text{Antenna gain of substitution horn}$ .
- d. E.R.P power can be calculated form E.I.R.P power by subtracting the gain of dipole,  $\text{E.R.P power} = \text{E.I.R.P power} - 2.15\text{dBi}$ .

**Note:** The resolution bandwidth and video bandwidth of test receiver/spectrum analyzer is 1MHz/3MHz.

### 4.7.3 Deviation from Test Standard

No deviation.

#### 4.7.4 Test Setup

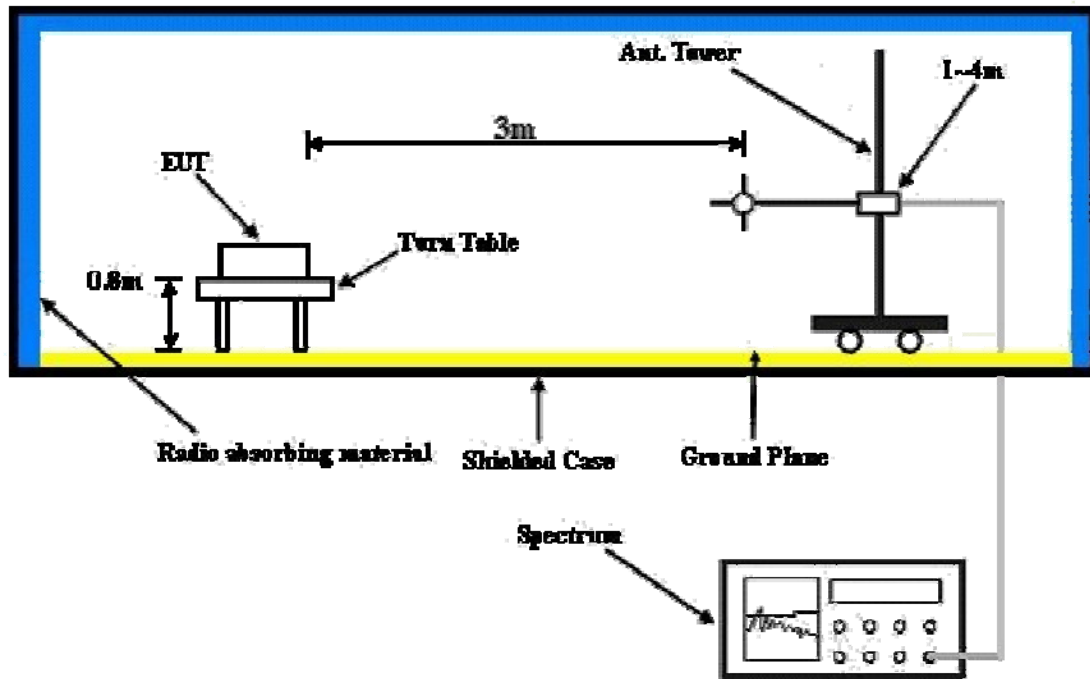

For the actual test configuration, please refer to the attached file (Test Setup Photo).



#### 4.7.5 Test Results

Below 1GHz

LTE Band 2

Channel Bandwidth: 3MHz

Mode	TX channel 19185	Frequency Range	Below 1000 MHz
Environmental Conditions	25deg. C, 65%RH	Input Power	120Vac, 60Hz
Tested By	Ted Chang		

Antenna Polarity & Test Distance: Horizontal at 3 M							
No.	Freq. (MHz)	Reading (dBm)	S.G Power Value (dBm)	Correction Factor (dB)	EIRP (dBm)	Limit (dBm)	Margin (dB)
1	33.88	-48.6	-28.6	-17.1	-45.7	-13.0	-32.7
2	94.02	-34.0	-42.0	-0.7	-42.7	-13.0	-29.7
3	169.68	-49.8	-53.8	-2.8	-56.6	-13.0	-43.6
4	315.18	-48.1	-56.1	4.0	-52.1	-13.0	-39.1
5	495.60	-62.0	-66.0	3.8	-62.2	-13.0	-49.2
6	714.82	-60.4	-60.6	3.5	-57.1	-13.0	-44.1
Antenna Polarity & Test Distance: Vertical at 3 M							
No.	Freq. (MHz)	Reading (dBm)	S.G Power Value (dBm)	Correction Factor (dB)	EIRP (dBm)	Limit (dBm)	Margin (dB)
1	33.88	-35.0	-28.5	-17.1	-45.6	-13.0	-32.6
2	94.02	-34.4	-41.0	-0.7	-41.7	-13.0	-28.7
3	167.74	-43.8	-44.1	-2.9	-47.0	-13.0	-34.0
4	297.72	-50.5	-49.1	-1.7	-50.8	-13.0	-37.8
5	495.60	-60.8	-64.7	3.8	-60.9	-13.0	-47.9
6	714.82	-60.6	-58.1	3.5	-54.6	-13.0	-41.6

Remarks:

1. Output Power (dBm) = S.G Value (dBm) + Correction Factor (dB).
2. Correction Factor (dB) = Substitution Antenna Gain (dB) + Cable Loss (dB).



Above 1GHz

LTE Band 2

Channel Bandwidth: 1.4MHz

Mode	TX channel 18607	Frequency Range	Above 1000MHz
Environmental Conditions	25deg. C, 65%RH	Input Power	120Vac, 60Hz
Tested By	Tank Wu		

Antenna Polarity & Test Distance: Horizontal at 3 M							
No.	Freq. (MHz)	Reading (dBm)	S.G Power Value (dBm)	Correction Factor (dB)	EIRP (dBm)	Limit (dBm)	Margin (dB)
1	3701.40	-49.5	-41.0	1.4	-39.6	-13.0	-26.6
Antenna Polarity & Test Distance: Vertical at 3 M							
No.	Freq. (MHz)	Reading (dBm)	S.G Power Value (dBm)	Correction Factor (dB)	EIRP (dBm)	Limit (dBm)	Margin (dB)
1	3701.40	-51.4	-43.2	1.4	-41.8	-13.0	-28.8

Remarks:

1. Output Power (dBm) = S.G Value (dBm) + Correction Factor (dB).
2. Correction Factor (dB) = Substitution Antenna Gain (dB) + Cable Loss (dB).

Mode	TX channel 18900	Frequency Range	Above 1000MHz
Environmental Conditions	25deg. C, 65%RH	Input Power	120Vac, 60Hz
Tested By	Tank Wu		

Antenna Polarity & Test Distance: Horizontal at 3 M							
No.	Freq. (MHz)	Reading (dBm)	S.G Power Value (dBm)	Correction Factor (dB)	EIRP (dBm)	Limit (dBm)	Margin (dB)
1	3760.00	-48.8	-40.3	1.3	-39.0	-13.0	-26.0
Antenna Polarity & Test Distance: Vertical at 3 M							
No.	Freq. (MHz)	Reading (dBm)	S.G Power Value (dBm)	Correction Factor (dB)	EIRP (dBm)	Limit (dBm)	Margin (dB)
1	3760.00	-49.7	-41.4	1.3	-40.1	-13.0	-27.1

Remarks:

1. Output Power (dBm) = S.G Value (dBm) + Correction Factor (dB).
2. Correction Factor (dB) = Substitution Antenna Gain (dB) + Cable Loss (dB).



Mode	TX channel 19193	Frequency Range	Above 1000MHz
Environmental Conditions	25deg. C, 65%RH	Input Power	120Vac, 60Hz
Tested By	Tank Wu		

Antenna Polarity & Test Distance: Horizontal at 3 M							
No.	Freq. (MHz)	Reading (dBm)	S.G Power Value (dBm)	Correction Factor (dB)	EIRP (dBm)	Limit (dBm)	Margin (dB)
1	3818.60	-51.8	-43.5	1.4	-42.1	-13.0	-29.1

Antenna Polarity & Test Distance: Vertical at 3 M							
No.	Freq. (MHz)	Reading (dBm)	S.G Power Value (dBm)	Correction Factor (dB)	EIRP (dBm)	Limit (dBm)	Margin (dB)
1	3818.60	-52.7	-44.5	1.4	-43.1	-13.0	-30.1

## Remarks:

1. Output Power (dBm) = S.G Value (dBm) + Correction Factor (dB).
2. Correction Factor (dB) = Substitution Antenna Gain (dB) + Cable Loss (dB).

**Channel Bandwidth: 3 MHz**

Mode	TX channel 18615	Frequency Range	Above 1000MHz
Environmental Conditions	25deg. C, 65%RH	Input Power	120Vac, 60Hz
Tested By	Tank Wu		

Antenna Polarity & Test Distance: Horizontal at 3 M							
No.	Freq. (MHz)	Reading (dBm)	S.G Power Value (dBm)	Correction Factor (dB)	EIRP (dBm)	Limit (dBm)	Margin (dB)
1	3703.00	-50.6	-42.1	1.4	-40.7	-13.0	-27.7
Antenna Polarity & Test Distance: Vertical at 3 M							
No.	Freq. (MHz)	Reading (dBm)	S.G Power Value (dBm)	Correction Factor (dB)	EIRP (dBm)	Limit (dBm)	Margin (dB)
1	3703.00	-53.1	-44.9	1.4	-43.5	-13.0	-30.5

**Remarks:**

1. Output Power (dBm) = S.G Value (dBm) + Correction Factor (dB).
2. Correction Factor (dB) = Substitution Antenna Gain (dB) + Cable Loss (dB).

Mode	TX channel 18900	Frequency Range	Above 1000MHz
Environmental Conditions	25deg. C, 65%RH	Input Power	120Vac, 60Hz
Tested By	Tank Wu		

Antenna Polarity & Test Distance: Horizontal at 3 M							
No.	Freq. (MHz)	Reading (dBm)	S.G Power Value (dBm)	Correction Factor (dB)	EIRP (dBm)	Limit (dBm)	Margin (dB)
1	3760.00	-49.9	-41.4	1.3	-40.1	-13.0	-27.1
Antenna Polarity & Test Distance: Vertical at 3 M							
No.	Freq. (MHz)	Reading (dBm)	S.G Power Value (dBm)	Correction Factor (dB)	EIRP (dBm)	Limit (dBm)	Margin (dB)
1	3760.00	-51.0	-42.7	1.3	-41.4	-13.0	-28.4

**Remarks:**

1. Output Power (dBm) = S.G Value (dBm) + Correction Factor (dB).
2. Correction Factor (dB) = Substitution Antenna Gain (dB) + Cable Loss (dB).



Mode	TX channel 19185	Frequency Range	Above 1000MHz
Environmental Conditions	25deg. C, 65%RH	Input Power	120Vac, 60Hz
Tested By	Tank Wu		

Antenna Polarity & Test Distance: Horizontal at 3 M							
No.	Freq. (MHz)	Reading (dBm)	S.G Power Value (dBm)	Correction Factor (dB)	EIRP (dBm)	Limit (dBm)	Margin (dB)
1	3817.00	-51.8	-43.5	1.4	-42.1	-13.0	-29.1

Antenna Polarity & Test Distance: Vertical at 3 M							
No.	Freq. (MHz)	Reading (dBm)	S.G Power Value (dBm)	Correction Factor (dB)	EIRP (dBm)	Limit (dBm)	Margin (dB)
1	3817.00	-52.9	-44.7	1.4	-43.3	-13.0	-30.3

## Remarks:

1. Output Power (dBm) = S.G Value (dBm) + Correction Factor (dB).
2. Correction Factor (dB) = Substitution Antenna Gain (dB) + Cable Loss (dB).

**Channel Bandwidth: 5MHz**

Mode	TX channel 18625	Frequency Range	Above 1000MHz
Environmental Conditions	25deg. C, 65%RH	Input Power	120Vac, 60Hz
Tested By	Tank Wu		

Antenna Polarity & Test Distance: Horizontal at 3 M							
No.	Freq. (MHz)	Reading (dBm)	S.G Power Value (dBm)	Correction Factor (dB)	EIRP (dBm)	Limit (dBm)	Margin (dB)
1	3705.00	-49.3	-40.8	1.4	-39.4	-13.0	-26.4
Antenna Polarity & Test Distance: Vertical at 3 M							
No.	Freq. (MHz)	Reading (dBm)	S.G Power Value (dBm)	Correction Factor (dB)	EIRP (dBm)	Limit (dBm)	Margin (dB)
1	3705.00	-52.2	-44.0	1.4	-42.6	-13.0	-29.6

**Remarks:**

1. Output Power (dBm) = S.G Value (dBm) + Correction Factor (dB).
2. Correction Factor (dB) = Substitution Antenna Gain (dB) + Cable Loss (dB).

Mode	TX channel 18900	Frequency Range	Above 1000MHz
Environmental Conditions	25deg. C, 65%RH	Input Power	120Vac, 60Hz
Tested By	Tank Wu		

Antenna Polarity & Test Distance: Horizontal at 3 M							
No.	Freq. (MHz)	Reading (dBm)	S.G Power Value (dBm)	Correction Factor (dB)	EIRP (dBm)	Limit (dBm)	Margin (dB)
1	3760.00	-48.7	-40.2	1.3	-38.9	-13.0	-25.9
Antenna Polarity & Test Distance: Vertical at 3 M							
No.	Freq. (MHz)	Reading (dBm)	S.G Power Value (dBm)	Correction Factor (dB)	EIRP (dBm)	Limit (dBm)	Margin (dB)
1	3760.00	-50.3	-42.0	1.3	-40.7	-13.0	-27.7

**Remarks:**

1. Output Power (dBm) = S.G Value (dBm) + Correction Factor (dB).
2. Correction Factor (dB) = Substitution Antenna Gain (dB) + Cable Loss (dB).



Mode	TX channel 19175	Frequency Range	Above 1000MHz
Environmental Conditions	25deg. C, 65%RH	Input Power	120Vac, 60Hz
Tested By	Tank Wu		

Antenna Polarity & Test Distance: Horizontal at 3 M							
No.	Freq. (MHz)	Reading (dBm)	S.G Power Value (dBm)	Correction Factor (dB)	EIRP (dBm)	Limit (dBm)	Margin (dB)
1	3815.00	-51.9	-43.6	1.4	-42.2	-13.0	-29.2

Antenna Polarity & Test Distance: Vertical at 3 M							
No.	Freq. (MHz)	Reading (dBm)	S.G Power Value (dBm)	Correction Factor (dB)	EIRP (dBm)	Limit (dBm)	Margin (dB)
1	3815.00	-52.7	-44.5	1.4	-43.1	-13.0	-30.1

## Remarks:

1. Output Power (dBm) = S.G Value (dBm) + Correction Factor (dB).
2. Correction Factor (dB) = Substitution Antenna Gain (dB) + Cable Loss (dB).



## Channel Bandwidth: 10MHz

Mode	TX channel 18650	Frequency Range	Above 1000MHz
Environmental Conditions	25deg. C, 65%RH	Input Power	120Vac, 60Hz
Tested By	Tank Wu		

Antenna Polarity & Test Distance: Horizontal at 3 M							
No.	Freq. (MHz)	Reading (dBm)	S.G Power Value (dBm)	Correction Factor (dB)	EIRP (dBm)	Limit (dBm)	Margin (dB)
1	3710.00	-49.1	-40.6	1.4	-39.2	-13.0	-26.2
Antenna Polarity & Test Distance: Vertical at 3 M							
No.	Freq. (MHz)	Reading (dBm)	S.G Power Value (dBm)	Correction Factor (dB)	EIRP (dBm)	Limit (dBm)	Margin (dB)
1	3710.00	-51.4	-43.2	1.4	-41.8	-13.0	-28.8

## Remarks:

1. Output Power (dBm) = S.G Value (dBm) + Correction Factor (dB).
2. Correction Factor (dB) = Substitution Antenna Gain (dB) + Cable Loss (dB).

Mode	TX channel 18900	Frequency Range	Above 1000MHz
Environmental Conditions	25deg. C, 65%RH	Input Power	120Vac, 60Hz
Tested By	Tank Wu		

Antenna Polarity & Test Distance: Horizontal at 3 M							
No.	Freq. (MHz)	Reading (dBm)	S.G Power Value (dBm)	Correction Factor (dB)	EIRP (dBm)	Limit (dBm)	Margin (dB)
1	3760.00	-48.2	-39.7	1.3	-38.4	-13.0	-25.4
Antenna Polarity & Test Distance: Vertical at 3 M							
No.	Freq. (MHz)	Reading (dBm)	S.G Power Value (dBm)	Correction Factor (dB)	EIRP (dBm)	Limit (dBm)	Margin (dB)
1	3760.00	-49.7	-41.4	1.3	-40.1	-13.0	-27.1

## Remarks:

1. Output Power (dBm) = S.G Value (dBm) + Correction Factor (dB).
2. Correction Factor (dB) = Substitution Antenna Gain (dB) + Cable Loss (dB).





Mode	TX channel 19150	Frequency Range	Above 1000MHz
Environmental Conditions	25deg. C, 65%RH	Input Power	120Vac, 60Hz
Tested By	Tank Wu		

Antenna Polarity & Test Distance: Horizontal at 3 M							
No.	Freq. (MHz)	Reading (dBm)	S.G Power Value (dBm)	Correction Factor (dB)	EIRP (dBm)	Limit (dBm)	Margin (dB)
1	3810.00	-49.5	-41.1	1.3	-39.8	-13.0	-26.8

Antenna Polarity & Test Distance: Vertical at 3 M							
No.	Freq. (MHz)	Reading (dBm)	S.G Power Value (dBm)	Correction Factor (dB)	EIRP (dBm)	Limit (dBm)	Margin (dB)
1	3810.00	-51.8	-43.5	1.3	-42.2	-13.0	-29.2

## Remarks:

1. Output Power (dBm) = S.G Value (dBm) + Correction Factor (dB).
2. Correction Factor (dB) = Substitution Antenna Gain (dB) + Cable Loss (dB).



Channel Bandwidth: 15MHz

Mode	TX channel 18675	Frequency Range	Above 1000MHz
Environmental Conditions	25deg. C, 65%RH	Input Power	120Vac, 60Hz
Tested By	Tank Wu		

Antenna Polarity & Test Distance: Horizontal at 3 M							
No.	Freq. (MHz)	Reading (dBm)	S.G Power Value (dBm)	Correction Factor (dB)	EIRP (dBm)	Limit (dBm)	Margin (dB)
1	3715.00	-48.3	-39.8	1.4	-38.4	-13.0	-25.4
Antenna Polarity & Test Distance: Vertical at 3 M							
No.	Freq. (MHz)	Reading (dBm)	S.G Power Value (dBm)	Correction Factor (dB)	EIRP (dBm)	Limit (dBm)	Margin (dB)
1	3715.00	-51.3	-43.1	1.4	-41.7	-13.0	-28.7

Remarks:

1. Output Power (dBm) = S.G Value (dBm) + Correction Factor (dB).
2. Correction Factor (dB) = Substitution Antenna Gain (dB) + Cable Loss (dB).

Mode	TX channel 18900	Frequency Range	Above 1000MHz
Environmental Conditions	25deg. C, 65%RH	Input Power	120Vac, 60Hz
Tested By	Tank Wu		

Antenna Polarity & Test Distance: Horizontal at 3 M							
No.	Freq. (MHz)	Reading (dBm)	S.G Power Value (dBm)	Correction Factor (dB)	EIRP (dBm)	Limit (dBm)	Margin (dB)
<b>1</b>	<b>3760.00</b>	<b>-46.3</b>	<b>-37.8</b>	<b>1.3</b>	<b>-36.5</b>	<b>-13.0</b>	<b>-23.5</b>
Antenna Polarity & Test Distance: Vertical at 3 M							
No.	Freq. (MHz)	Reading (dBm)	S.G Power Value (dBm)	Correction Factor (dB)	EIRP (dBm)	Limit (dBm)	Margin (dB)
1	3760.00	-48.1	-39.8	1.3	-38.5	-13.0	-25.5

Remarks:

1. Output Power (dBm) = S.G Value (dBm) + Correction Factor (dB).
2. Correction Factor (dB) = Substitution Antenna Gain (dB) + Cable Loss (dB).



Mode	TX channel 19125	Frequency Range	Above 1000MHz
Environmental Conditions	25deg. C, 65%RH	Input Power	120Vac, 60Hz
Tested By	Tank Wu		

Antenna Polarity & Test Distance: Horizontal at 3 M							
No.	Freq. (MHz)	Reading (dBm)	S.G Power Value (dBm)	Correction Factor (dB)	EIRP (dBm)	Limit (dBm)	Margin (dB)
1	3805.00	-50.3	-41.9	1.3	-40.6	-13.0	-27.6

Antenna Polarity & Test Distance: Vertical at 3 M							
No.	Freq. (MHz)	Reading (dBm)	S.G Power Value (dBm)	Correction Factor (dB)	EIRP (dBm)	Limit (dBm)	Margin (dB)
1	3805.00	-51.7	-43.5	1.3	-42.2	-13.0	-29.2

## Remarks:

1. Output Power (dBm) = S.G Value (dBm) + Correction Factor (dB).
2. Correction Factor (dB) = Substitution Antenna Gain (dB) + Cable Loss (dB).



Channel Bandwidth: 20MHz

Mode	TX channel 18700	Frequency Range	Above 1000MHz
Environmental Conditions	25deg. C, 65%RH	Input Power	120Vac, 60Hz
Tested By	Tank Wu		

Antenna Polarity & Test Distance: Horizontal at 3 M							
No.	Freq. (MHz)	Reading (dBm)	S.G Power Value (dBm)	Correction Factor (dB)	EIRP (dBm)	Limit (dBm)	Margin (dB)
1	3720.00	-49.6	-41.1	1.4	-39.7	-13.0	-26.7
Antenna Polarity & Test Distance: Vertical at 3 M							
No.	Freq. (MHz)	Reading (dBm)	S.G Power Value (dBm)	Correction Factor (dB)	EIRP (dBm)	Limit (dBm)	Margin (dB)
1	3720.00	-51.3	-43.1	1.4	-41.7	-13.0	-28.7

Remarks:

1. Output Power (dBm) = S.G Value (dBm) + Correction Factor (dB).
2. Correction Factor (dB) = Substitution Antenna Gain (dB) + Cable Loss (dB).

Mode	TX channel 18900	Frequency Range	Above 1000MHz
Environmental Conditions	25deg. C, 65%RH	Input Power	120Vac, 60Hz
Tested By	Tank Wu		

Antenna Polarity & Test Distance: Horizontal at 3 M							
No.	Freq. (MHz)	Reading (dBm)	S.G Power Value (dBm)	Correction Factor (dB)	EIRP (dBm)	Limit (dBm)	Margin (dB)
<b>1</b>	<b>3760.00</b>	<b>-46.3</b>	<b>-37.8</b>	<b>1.3</b>	<b>-36.5</b>	<b>-13.0</b>	<b>-23.5</b>
Antenna Polarity & Test Distance: Vertical at 3 M							
No.	Freq. (MHz)	Reading (dBm)	S.G Power Value (dBm)	Correction Factor (dB)	EIRP (dBm)	Limit (dBm)	Margin (dB)
1	3760.00	-48.1	-39.8	1.3	-38.5	-13.0	-25.5

Remarks:

1. Output Power (dBm) = S.G Value (dBm) + Correction Factor (dB).
2. Correction Factor (dB) = Substitution Antenna Gain (dB) + Cable Loss (dB).



Mode	TX channel 19100	Frequency Range	Above 1000MHz
Environmental Conditions	25deg. C, 65%RH	Input Power	120Vac, 60Hz
Tested By	Tank Wu		

Antenna Polarity & Test Distance: Horizontal at 3 M							
No.	Freq. (MHz)	Reading (dBm)	S.G Power Value (dBm)	Correction Factor (dB)	EIRP (dBm)	Limit (dBm)	Margin (dB)
1	3800.00	-50.5	-42.1	1.3	-40.8	-13.0	-27.8

Antenna Polarity & Test Distance: Vertical at 3 M							
No.	Freq. (MHz)	Reading (dBm)	S.G Power Value (dBm)	Correction Factor (dB)	EIRP (dBm)	Limit (dBm)	Margin (dB)
1	3800.00	-51.5	-43.3	1.3	-42.0	-13.0	-29.0

Remarks:

1. Output Power (dBm) = S.G Value (dBm) + Correction Factor (dB).
2. Correction Factor (dB) = Substitution Antenna Gain (dB) + Cable Loss (dB).



## 5 Pictures of Test Arrangements

Please refer to the attached file (Test Setup Photo).

## Appendix – Information on the Testing Laboratories

We, Bureau Veritas Consumer Products Services (H.K.) Ltd., Taoyuan Branch, were founded in 1988 to provide our best service in EMC, Radio, Telecom and Safety consultation. Our laboratories are accredited and approved according to ISO/IEC 17025.

If you have any comments, please feel free to contact us at the following:

**Linko EMC/RF Lab**

Tel: 886-2-26052180

Fax: 886-2-26051924

**Hsin Chu EMC/RF/Telecom Lab**

Tel: 886-3-6668565

Fax: 886-3-6668323

**Hwa Ya EMC/RF/Safety Lab**

Tel: 886-3-3183232

Fax: 886-3-3270892

**Email:** [service.adt@tw.bureauveritas.com](mailto:service.adt@tw.bureauveritas.com)

**Web Site:** [www.bureauveritas-adt.com](http://www.bureauveritas-adt.com)

The address and road map of all our labs can be found in our web site also.

--- END ---