



FCC RADIO TEST REPORT

FCC ID : XIA-IFWA40
Equipment : Wireless Home Internet
Brand Name : Netcomm
Model Name : IFWA-40
Applicant : NetComm Wireless Limited
18-20 Orion Road Lane Cove NSW 2066 Australia
Manufacturer : NetComm Wireless Limited
18-20 Orion Road Lane Cove NSW 2066 Australia
Standard : 47 CFR Part 2, 22(H), 24(E)

The product was received on Oct. 17, 2018 and testing was started from Dec. 18, 2018 and completed on Dec. 20, 2018. We, SPORTON INTERNATIONAL INC. EMC & Wireless Communications Laboratory, would like to declare that the tested sample has been evaluated in accordance with the test procedures given in ANSI / TIA-603-E and has been in compliance with the applicable technical standards.

The report must not be used by the client to claim product certification, approval, or endorsement by TAF or any agency of government.

The test results in this report apply exclusively to the tested model / sample. Without written approval of SPORTON INTERNATIONAL INC. EMC & Wireless Communications Laboratory, the test report shall not be reproduced except in full.

Approved by: Jones Tsai

SPORTON INTERNATIONAL INC. EMC & Wireless Communications Laboratory

No. 52, Huaya 1st Rd., Guishan Dist., Taoyuan City, Taiwan (R.O.C.)



Table of Contents

History of this test report.....3

Summary of Test Result.....4

1 General Description5

 1.1 Product Feature of Equipment Under Test5

 1.2 Modification of EUT5

 1.3 Testing Location5

 1.4 Applicable Standards5

2 Test Configuration of Equipment Under Test6

 2.1 Test Mode.....6

 2.2 Connection Diagram of Test System6

 2.3 Support Unit used in test configuration7

 2.4 Measurement Results Explanation Example7

 2.5 Frequency List of Low/Middle/High Channels.....7

3 Conducted Test Result8

 3.1 Measuring Instruments8

 3.2 Conducted Output Power and ERP/EIRP9

 3.3 Peak-to-Average Ratio10

 3.4 99% Occupied Bandwidth and 26dB Bandwidth Measurement.....11

 3.5 Conducted Band Edge12

 3.6 Conducted Spurious Emission13

 3.7 Frequency Stability.....14

4 Radiated Test Items15

 4.1 Measuring Instruments15

 4.2 Test Setup15

 4.3 Test Result of Radiated Test.....15

 4.4 Field Strength of Spurious Radiation Measurement16

5 List of Measuring Equipment.....17

6 Uncertainty of Evaluation18

Appendix A. Test Results of Conducted Test

Appendix B. Test Results of ERP/EIRP and Radiated Test

Appendix C. Test Setup Photographs



Summary of Test Result

Report Clause	Ref Std. Clause	Test Items	Result (PASS/FAIL)	Remark
3.2	§2.1046	Conducted Output Power	Pass	-
	§22.913 (a)(2)	Effective Radiated Power		
	§24.232 (c)	Equivalent Isotropic Radiated Power		
3.3	§24.232 (d)	Peak-to-Average Ratio	Pass	-
3.4	§2.1049 §22.917 (b) §24.238 (b)	Occupied Bandwidth	Pass	-
3.5	§2.1051 §22.917 (a) §24.238 (a)	Band Edge Measurement	Pass	-
3.6	§2.1051 §22.917 (a) §24.238 (a)	Conducted Emission	Pass	-
3.7	§2.1055 §22.355	Frequency Stability Temperature & Voltage	Pass	-
	§2.1055 §24.235			-
4.4	§2.1053 §22.917 (a) §24.238 (a)	Field Strength of Spurious Radiation	Pass	Under limit 26.57 dB at 5640.000 MHz

Declaration of Conformity:
The test results with all measurement uncertainty excluded are presented in accordance with the regulation limits or requirements declared by manufacturers.
Comments and Explanations:
The declared of product specification for EUT presented in the report are provided by the manufacturer, and the manufacturer takes all the responsibilities for the accuracy of product specification.

Reviewed by: Wii Chang

Report Producer: Polly Tsai



1 General Description

1.1 Product Feature of Equipment Under Test

WCDMA/LTE, Bluetooth, Wi-Fi 2.4GHz 802.11b/g/n, Wi-Fi 5GHz 802.11a/n/ac, and GNSS.

Product Specification subjective to this standard	
Antenna Type	WWAN: PIFA Antenna WLAN: Internal Antenna GPS/Glonass/BDS/Galileo: PIFA Antenna

1.2 Modification of EUT

No modifications are made to the EUT during all test items.

1.3 Testing Location

Test Site	SPORTON INTERNATIONAL INC.	
Test Site Location	No.52, Huaya 1st Rd., Guishan Dist., Taoyuan City, Taiwan (R.O.C.) TEL: +886-3-327-3456 FAX: +886-3-328-4978	
Test Site No.	Sporton Site No.	
	TH03-HY	03CH07-HY
Temperature	21~24°C	23~25°C
Relative Humidity	51~55%	53~56%
Test Engineer	George Chen	Stan Hsieh and Troye Hsieh

Note: The test site complies with ANSI C63.4 2014 requirement.

FCC Designation No. TW1190

1.4 Applicable Standards

According to the specifications of the manufacturer, the EUT must comply with the requirements of the following standards:

- ♦ ANSI C63.26-2015
- ♦ ANSI / TIA-603-E
- ♦ 47 CFR Part 2, 22(H), 24(E)
- ♦ FCC KDB 971168 D01 Power Meas. License Digital Systems v03r01
- ♦ FCC KDB 412172 D01 Determining ERP and EIRP v01r01

Remark: All test items were verified and recorded according to the standards and without any deviation during the test.

2 Test Configuration of Equipment Under Test

2.1 Test Mode

Antenna port conducted and radiated test items were performed according to KDB 971168 D01 Power Meas. License Digital Systems v03r01 with maximum output power.

For radiated measurement, pre-scanned in three orthogonal panels, X, Y, Z. The worst cases (X plane) were recorded in this report.

Radiated emissions were investigated as following frequency range:

1. 30 MHz to 9000 MHz for WCDMA Band V.
2. 30 MHz to 19100 MHz for WCDMA Band II.

All modes and data rates and positions were investigated.

Test modes are chosen to be reported as the worst case configuration below:

Test Modes		
Band	Radiated TCs	Conducted TCs
WCDMA Band V	■ RMC 12.2Kbps Link	■ RMC 12.2Kbps Link
WCDMA Band II	■ RMC 12.2Kbps Link	■ RMC 12.2Kbps Link

2.2 Connection Diagram of Test System

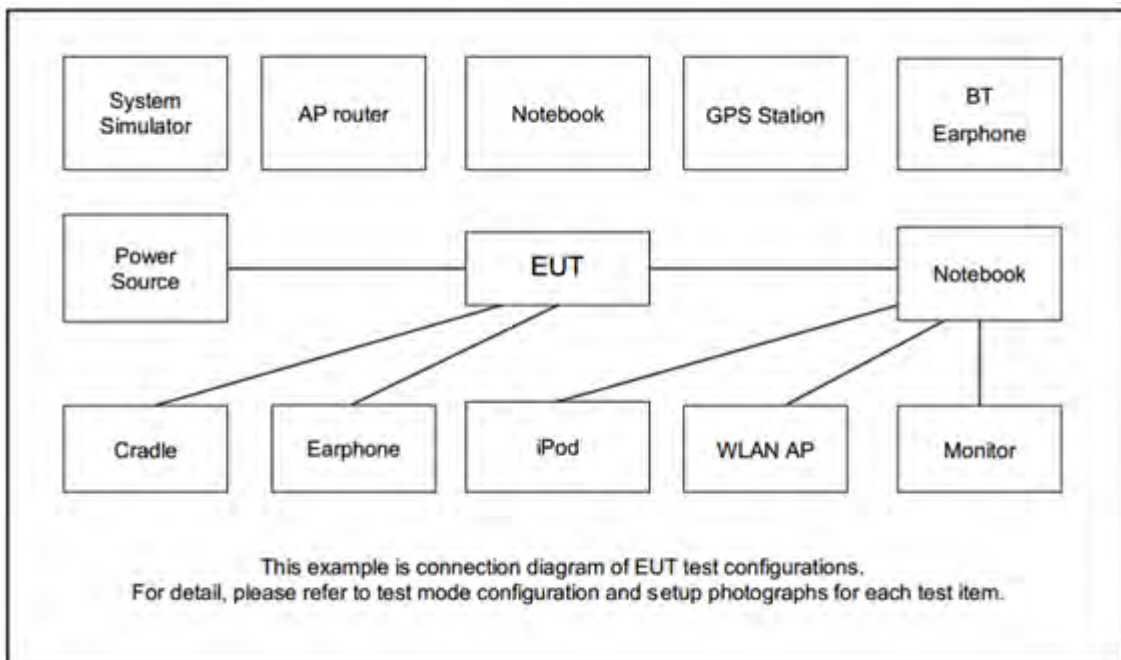



2.3 Support Unit used in test configuration

Item	Equipment	Trade Name	Model No.	FCC ID	Data Cable	Power Cord
1.	System Simulator	R&S	CMU 200	N/A	N/A	Unshielded, 1.8 m

2.4 Measurement Results Explanation Example

For all conducted test items:

The offset level is set in the spectrum analyzer to compensate the RF cable loss and attenuator factor between RF conducted output port and spectrum analyzer. With the offset compensation, the spectrum analyzer reading level will be exactly the RF output level.

The spectrum analyzer offset is derived from RF cable loss and attenuator factor.

$$\text{Offset} = \text{RF cable loss} + \text{attenuator factor}.$$

The following shows an offset computation example with RF cable loss 4.2 dB and a 10dB attenuator.

Example:

$$\begin{aligned} \text{Offset(dB)} &= \text{RF cable loss(dB)} + \text{attenuator factor(dB)}. \\ &= 4.2 + 10 = 14.2 \text{ (dB)} \end{aligned}$$

2.5 Frequency List of Low/Middle/High Channels

Frequency List				
Band	Channel/Frequency(MHz)	Lowest	Middle	Highest
WCDMA Band V	Channel	4132	4182	4233
	Frequency	826.4	836.4	846.6
WCDMA Band II	Channel	9262	9400	9538
	Frequency	1852.4	1880.0	1907.6

3 Conducted Test Result

3.1 Measuring Instruments

See list of measuring instruments of this test report.

3.1.1 Test Setup

3.1.2 Conducted Output Power



3.1.3 Peak-to-Average Ratio, Occupied Bandwidth, Conducted Band-Edge and Conducted Spurious Emission

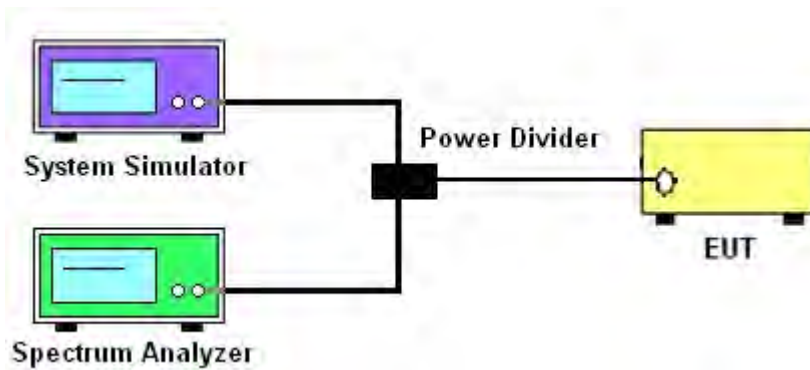

3.1.4 Frequency Stability

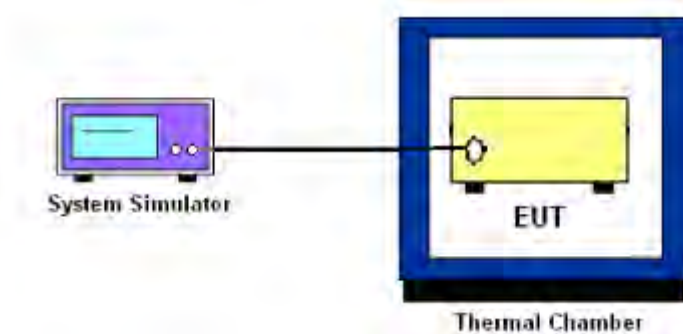

3.1.5 Test Result of Conducted Test

Please refer to Appendix A.



3.2 Conducted Output Power and ERP/EIRP

3.2.1 Description of the Conducted Output Power and ERP/EIRP

A system simulator was used to establish communication with the EUT. Its parameters were set to enforce EUT transmitting at the maximum power. The measured power in the radio frequency on the transmitter output terminals shall be reported.

The ERP of mobile transmitters must not exceed 7 Watts for WCDMA Band V.

The EIRP of mobile transmitters must not exceed 2 Watts for WCDMA Band II.

According to KDB 412172 D01 Power Approach,

$EIRP = P_T + G_T - L_C$, $ERP = EIRP - 2.15$, where

P_T = transmitter output power in dBm

G_T = gain of the transmitting antenna in dBi

L_C = signal attenuation in the connecting cable between the transmitter and antenna in dB

3.2.2 Test Procedures

1. The transmitter output port was connected to the system simulator.
2. Set EUT at maximum power through system simulator.
3. Select lowest, middle, and highest channels for each band and different modulation.
4. Measure the maximum burst average power for GSM and maximum average power for other modulation signal.



3.3 Peak-to-Average Ratio

3.3.1 Description of the PAR Measurement

The peak-to-average ratio (PAR) of the transmission may not exceed 13 dB.

3.3.2 Test Procedures

The testing follows FCC KDB 971168 D01 v03r01 Section 5.7.1

1. The EUT was connected to spectrum analyzer and system simulator via a power divider.
2. Set EUT to transmit at maximum output power.
3. When the duty cycle is less than 98%, then signal gating will be implemented on the spectrum analyzer by triggering from the system simulator.
4. Set the CCDF (Complementary Cumulative Distribution Function) option of the spectrum analyzer.
5. Record the maximum PAPR level associated with a probability of 0.1%.



3.4 99% Occupied Bandwidth and 26dB Bandwidth Measurement

3.4.1 Description of 99% Occupied Bandwidth and 26dB Bandwidth Measurement

The occupied bandwidth is the width of a frequency band such that, below the lower and above the upper frequency limits, the mean powers emitted are each equal to a specified percentage 0.5% of the total mean transmitted power.

The 26 dB emission bandwidth is defined as the frequency range between two points, one above and one below the carrier frequency, at which the spectral density of the emission is attenuated 26 dB below the maximum in-band spectral density of the modulated signal. Spectral density (power per unit bandwidth) is to be measured with a detector of resolution bandwidth equal to approximately 1.0% of the emission bandwidth.

3.4.2 Test Procedures

The testing follows FCC KDB 971168 D01 v03r01 Section 4.2

1. The EUT was connected to spectrum analyzer and system simulator via a power divider.
2. The spectrum analyzer center frequency is set to the nominal EUT channel center frequency. The span range for the spectrum analyzer shall be between two and five times the anticipated OBW.
3. The nominal resolution bandwidth (RBW) shall be in the range of 1 to 5 % of the anticipated OBW, and the VBW shall be at least 3 times the RBW.
4. Set the detection mode to peak, and the trace mode to max hold.
5. Determine the reference value: Set the EUT to transmit a modulated signal. Allow the trace to stabilize. Set the spectrum analyzer marker to the highest level of the displayed trace.
(this is the reference value)
6. Determine the “-26 dB down amplitude” as equal to (Reference Value – X).
7. Place two markers, one at the lowest and the other at the highest frequency of the envelope of the spectral display such that each marker is at or slightly below the “-X dB down amplitude” determined in step 6. If a marker is below this “-X dB down amplitude” value it shall be placed as close as possible to this value. The OBW is the positive frequency difference between the two markers.
8. Use the 99 % power bandwidth function of the spectrum analyzer and report the measured bandwidth.



3.5 Conducted Band Edge

3.5.1 Description of Conducted Band Edge Measurement

The power of any emission outside of the authorized operating frequency ranges must be lower than the transmitter power (P) by a factor of at least $43 + 10 \log (P)$ dB.

3.5.2 Test Procedures

The testing follows FCC KDB 971168 D01 v03r01 Section 6.0.

1. The EUT was connected to the spectrum analyzer and system simulator via a power divider.
2. The RF output of EUT was connected to the spectrum analyzer by an RF cable and attenuator. The path loss was compensated to the results for each measurement.
3. The band edges of low and high channels for the highest RF powers were measured.
4. The RF fundamental frequency should be excluded against the limit line in the operating frequency band.
5. The limit line is derived from $43 + 10\log(P)$ dB below the transmitter power P(Watts)



3.6 Conducted Spurious Emission

3.6.1 Description of Conducted Spurious Emission Measurement

The power of any emission outside of the authorized operating frequency ranges must be lower than the transmitter power (P) by a factor of at least $43 + 10 \log (P)$ dB.

It is measured by means of a calibrated spectrum analyzer and scanned from 30 MHz up to a frequency including its 10th harmonic.

3.6.2 Test Procedures

The testing follows FCC KDB 971168 D01 v03r01 Section 6.0.

1. The EUT was connected to the spectrum analyzer and system simulator via a power divider.
2. The RF output of EUT was connected to the spectrum analyzer by an RF cable and attenuator. The path loss was compensated to the results for each measurement.
3. The middle channel for the highest RF power within the transmitting frequency was measured.
4. The conducted spurious emission for the whole frequency range was taken.
5. The RF fundamental frequency should be excluded against the limit line in the operating frequency band.
6. The limit line is derived from $43 + 10\log(P)$ dB below the transmitter power P(Watts)



3.7 Frequency Stability

3.7.1 Description of Frequency Stability Measurement

22.355

The frequency stability shall be measured by variation of ambient temperature and variation of primary supply voltage to ensure that the fundamental emission stays within the authorized frequency block. The frequency stability of the transmitter shall be maintained within $\pm 0.00025\%$ ($\pm 2.5\text{ppm}$) of the center frequency.

24.235

The frequency stability shall be sufficient to ensure that the fundamental emission stays within the authorized frequency block.

3.7.2 Test Procedures for Temperature Variation

The testing follows FCC KDB 971168 D01 v03r01 Section 9.0.

1. The EUT was set up in the thermal chamber and connected with the system simulator.
2. With power OFF, the temperature was decreased to -30°C and the EUT was stabilized before testing. Power was applied and the maximum change in frequency was recorded within one minute.
3. With power OFF, the temperature was raised in 10°C steps up to 50°C . The EUT was stabilized at each step for at least half an hour. Power was applied and the maximum frequency change was recorded within one minute.

3.7.3 Test Procedures for Voltage Variation

The testing follows FCC KDB 971168 D01 v03r01 Section 9.0.

1. The EUT was placed in a temperature chamber at $20\pm 5^{\circ}\text{C}$ and connected with the system simulator.
2. The power supply voltage to the EUT was varied from 85% to 115% of the nominal value measured at the input to the EUT.
3. The variation in frequency was measured for the worst case.

4 Radiated Test Items

4.1 Measuring Instruments

See list of measuring instruments of this test report.

4.2 Test Setup

For radiated test from 30MHz to 1GHz

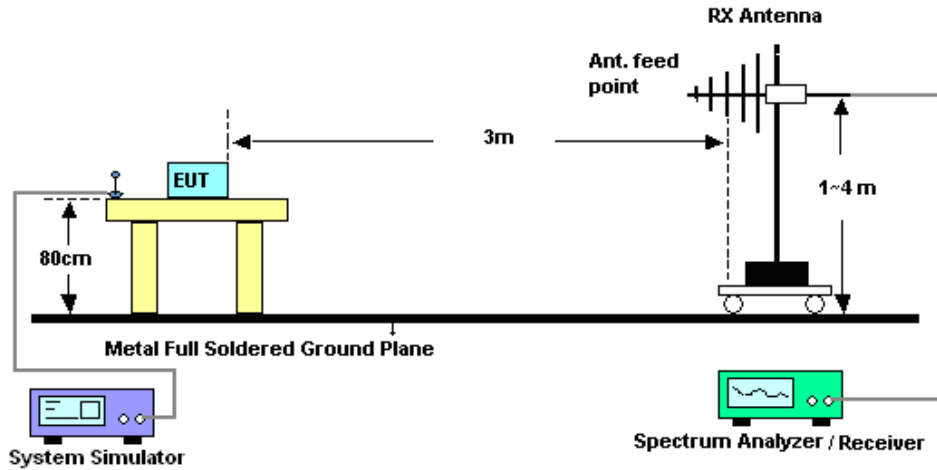

For radiated test above 1GHz

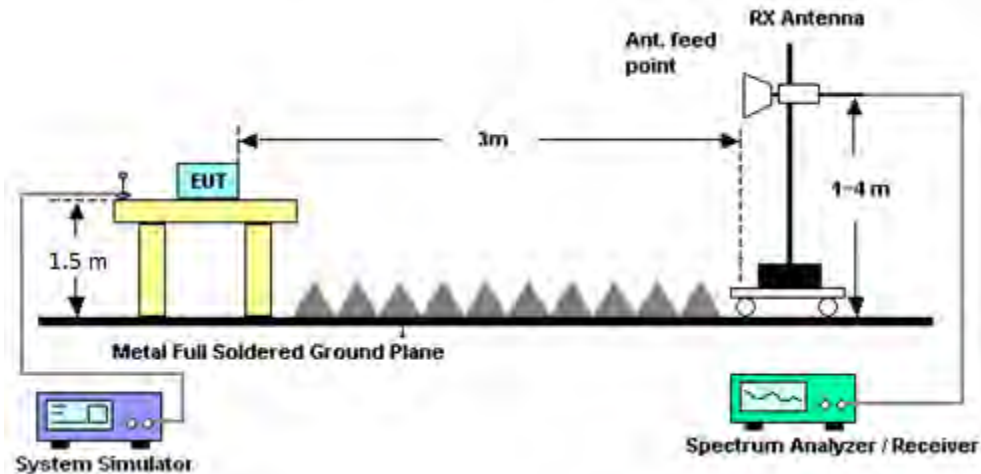

4.3 Test Result of Radiated Test

Please refer to Appendix B.



4.4 Field Strength of Spurious Radiation Measurement

4.4.1 Description of Field Strength of Spurious Radiated Measurement

The power of any emission outside of the authorized operating frequency ranges must be attenuated below the transmitter power (P) by a factor of at least $43 + 10 \log (P)$ dB. The spectrum is scanned from 30 MHz up to a frequency including its 10th harmonic.

4.4.2 Test Procedures

The testing follows FCC KDB 971168 D01 v03r01 Section 5.8 and ANSI / TIA-603-E Section 2.2.12.

1. The EUT was placed on a rotatable wooden table 0.8 meters for frequency below 1GHz and 1.5 meter for frequency above 1GHz above the ground.
2. The EUT was set 3 meters from the receiving antenna, which was mounted on the antenna tower.
3. The table was rotated 360 degrees to determine the position of the highest spurious emission.
4. The height of the receiving antenna is varied between one meter and four meters to search for the maximum spurious emission for both horizontal and vertical polarizations.
5. Make the measurement with the spectrum analyzer's RBW = 1MHz, VBW = 3MHz, taking record of maximum spurious emission.
6. A horn antenna was substituted in place of the EUT and was driven by a signal generator.
7. Tune the output power of signal generator to the same emission level with EUT maximum spurious emission.
8. Taking the record of output power at antenna port.
9. Repeat step 7 to step 8 for another polarization.
10. $EIRP (dBm) = S.G. Power - Tx Cable Loss + Tx Antenna Gain$
11. $ERP (dBm) = EIRP - 2.15$
12. The RF fundamental frequency should be excluded against the limit line in the operating frequency band.
13. The limit line is derived from $43 + 10\log(P)$ dB below the transmitter power P(Watts)



5 List of Measuring Equipment

Instrument	Manufacturer	Model No.	Serial No.	Characteristics	Calibration Date	Test Date	Due Date	Remark
Spectrum Analyzer	Rohde & Schwarz	FSP30	101329	9kHz~30GHz	Jun. 29, 2018	Dec. 18, 2018~ Dec. 19, 2018	Jun. 28, 2019	Conducted (TH03-HY)
Temperature Chamber	ESPEC	SU-641	92013721	-30°C ~70°C	Dec. 06, 2017	Dec. 18, 2018~ Dec. 19, 2018	Dec. 05, 2019	Conducted (TH03-HY)
Programmable Power Supply	GW Instek	PSS-2005	EL883644	Voltage:0~20V; Current:0~5A	Dec. 06, 2017	Dec. 18, 2018~ Dec. 19, 2018	Dec. 05, 2019	Conducted (TH03-HY)
Base Station (Measure)	Rohde & Schwarz	CMU200	117995	GSM / GPRS / WCDMA / CDMA	Aug. 10, 2018	Dec. 18, 2018~ Dec. 19, 2018	Aug. 09, 2019	Conducted (TH03-HY)
Bilog Antenna	Schaffner	CBL6111C& N-6-06	2725&AT-N0 601	30MHz~1GHz	Oct. 13, 2018	Dec. 18, 2018~ Dec. 20, 2018	Oct. 12, 2019	Radiation (03CH07-HY)
Double Ridge Horn Antenna	ESCO	3117	00075962	1GHz ~ 18GHz	Dec. 02, 2018	Dec. 18, 2018~ Dec. 20, 2018	Dec. 03, 2019	Radiation (03CH07-HY)
EMI Test Receiver	Agilent	N9038A (MXE)	MY5329005 3	20Hz to 26.5GHz	Jan. 16, 2018	Dec. 18, 2018~ Dec. 20, 2018	Jan. 15, 2019	Radiation (03CH07-HY)
Preamplifier	COM-POWER	PA-103A	161241	10MHz-1GHz	May 21, 2018	Dec. 18, 2018~ Dec. 20, 2018	May 20, 2019	Radiation (03CH07-HY)
Preamplifier	Agilent	8449B	3008A02362	1GHz~ 26.5GHz	Nov. 02, 2018	Dec. 18, 2018~ Dec. 20, 2018	Nov. 01, 2019	Radiation (03CH07-HY)
RF Cable	HUBER + SUHNER	SUCOFLEX 104	MY28655/4, MY24971/4, MY15682/4	30MHz~1GHz	Feb. 27, 2018	Dec. 18, 2018~ Dec. 20, 2018	Feb. 26, 2019	Radiation (03CH07-HY)
RF Cable	HUBER + SUHNER	SUCOFLEX 104	MY28655/4, MY24971/4, MY15682/4	1GHz~18GHz	Feb. 27, 2018	Dec. 18, 2018~ Dec. 20, 2018	Feb. 26, 2019	Radiation (03CH07-HY)
Antenna Mast	Max-Full	MFA520BS	N/A	1m~4m	N/A	Dec. 18, 2018~ Dec. 20, 2018	N/A	Radiation (03CH07-HY)
Turn Table	ChainTek	Chaintek 3000	N/A	0~360 Degree	N/A	Dec. 18, 2018~ Dec. 20, 2018	N/A	Radiation (03CH07-HY)
Amplifier	MITEQ	TTA1840-35 -HG	1871923	18GHz~40GHz, VSWR : 2.5:1 max	Jul. 16, 2018	Dec. 18, 2018~ Dec. 20, 2018	Jul. 15, 2019	Radiation (03CH07-HY)
Software	Audix	E3 6.2009-8-24	RK-001042	N/A	N/A	Dec. 18, 2018~ Dec. 20, 2018	N/A	Radiation (03CH07-HY)
Horn Antenna	ESCO	3117	00143261	1GHz~18GHz	Dec. 27, 2017	Dec. 18, 2018~ Dec. 20, 2018	Dec. 26, 2018	Radiation (03CH07-HY)
Filter	Microwave	H3G018G1	SN477220	3.0G High Pass	Aug. 23, 2018	Dec. 18, 2018~ Dec. 20, 2018	Aug. 22, 2019	Radiation (03CH07-HY)
Signal Generator	Anritsu	MG3694C	163401	0.1Hz~40GHz	Jan. 15, 2018	Dec. 18, 2018~ Dec. 20, 2018	Jan. 14, 2019	Radiation (03CH07-HY)
SHF-EHF Horn Antenna	SCHWARZBECK	BBHA 9170	BBHA91705 84	18GHz- 40GHz	Dec. 05, 2018	Dec. 18, 2018~ Dec. 20, 2018	Dec. 04, 2019	Radiation (03CH07-HY)



6 Uncertainty of Evaluation

Uncertainty of Radiated Emission Measurement (30 MHz ~ 1000 MHz)

Measuring Uncertainty for a Level of Confidence of 95% ($U = 2Uc(y)$)	3.05
-------------------------------------------------------------------------	------

Uncertainty of Radiated Emission Measurement (1 GHz ~ 18 GHz)

Measuring Uncertainty for a Level of Confidence of 95% ($U = 2Uc(y)$)	3.44
-------------------------------------------------------------------------	------

Uncertainty of Radiated Emission Measurement (18 GHz ~ 40 GHz)

Measuring Uncertainty for a Level of Confidence of 95% ($U = 2Uc(y)$)	3.95
-------------------------------------------------------------------------	------



Appendix A. Test Results of Conducted Test

Conducted Output Power(Average power)

Conducted Power (*Unit: dBm)						
Band	WCDMA Band V			WCDMA Band II		
Channel	4132	4182	4233	9262	9400	9538
Frequency	826.4	836.4	846.6	1852.4	1880	1907.6
RMC 12.2K	24.64	24.42	24.23	24.74	25.39	25.09
HSDPA Subtest-1	23.59	23.42	23.33	24.33	24.50	24.20
HSDPA Subtest-2	23.58	23.38	23.22	24.31	24.49	24.17
HSDPA Subtest-3	23.06	22.87	22.77	23.78	24.00	23.68
HSDPA Subtest-4	23.08	22.96	22.85	23.77	23.98	23.67
HSUPA Subtest-1	23.58	23.35	23.27	24.26	24.50	24.12
HSUPA Subtest-2	21.60	21.35	21.32	22.06	22.33	22.15
HSUPA Subtest-3	22.63	22.37	22.24	23.14	23.45	23.12
HSUPA Subtest-4	21.61	21.42	21.28	22.13	22.36	22.16
HSUPA Subtest-5	23.50	23.20	23.10	24.10	24.30	24.20



A2. WCDMA

Peak-to-Average Ratio

Mode	WCDMA Band V	WCDMA Band II	Limit: 13dB
Mod.	RMC 12.2Kbps	RMC 12.2Kbps	Result
Lowest CH	3.00	3.04	PASS
Middle CH	3.16	3.08	
Highest CH	3.20	2.88	

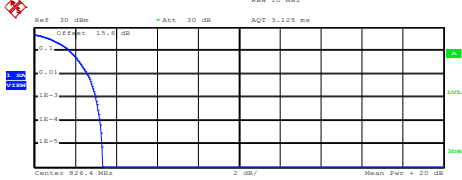
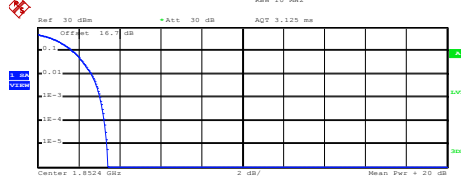
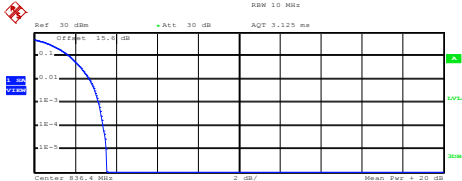
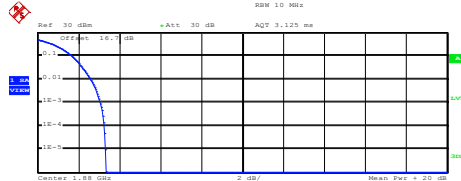
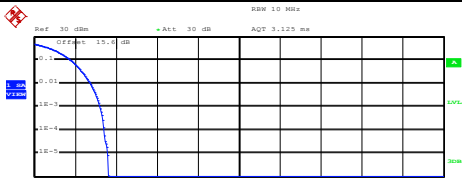
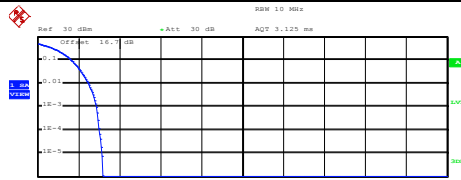

WCDMA Band V (RMC 12.2Kbps)	WCDMA Band II (RMC 12.2Kbps)																
<p align="center">Lowest Channel</p>  <p>Center 826.4 MHz 2 dB/ Mean Pwr + 20 dB</p> <p>Complementary Cumulative Distribution Function (100000 samples) Trace 1 Mean 23.51 dBm Peak 26.84 dBm Crest 3.33 dB</p> <table border="1"> <tr><td>10 %</td><td>1.72 dB</td></tr> <tr><td>1 %</td><td>2.60 dB</td></tr> <tr><td>.1 %</td><td>3.00 dB</td></tr> <tr><td>.01 %</td><td>3.20 dB</td></tr> </table> <p>Date: 18.DEC.2018 17:03:19</p>	10 %	1.72 dB	1 %	2.60 dB	.1 %	3.00 dB	.01 %	3.20 dB	<p align="center">Lowest Channel</p>  <p>Center 1.8524 GHz 2 dB/ Mean Pwr + 20 dB</p> <p>Complementary Cumulative Distribution Function (100000 samples) Trace 1 Mean 22.77 dBm Peak 26.20 dBm Crest 3.44 dB</p> <table border="1"> <tr><td>10 %</td><td>1.72 dB</td></tr> <tr><td>1 %</td><td>2.64 dB</td></tr> <tr><td>.1 %</td><td>3.04 dB</td></tr> <tr><td>.01 %</td><td>3.24 dB</td></tr> </table> <p>Date: 18.DEC.2018 16:41:33</p>	10 %	1.72 dB	1 %	2.64 dB	.1 %	3.04 dB	.01 %	3.24 dB
10 %	1.72 dB																
1 %	2.60 dB																
.1 %	3.00 dB																
.01 %	3.20 dB																
10 %	1.72 dB																
1 %	2.64 dB																
.1 %	3.04 dB																
.01 %	3.24 dB																
<p align="center">Middle Channel</p>  <p>Center 836.4 MHz 2 dB/ Mean Pwr + 20 dB</p> <p>Complementary Cumulative Distribution Function (100000 samples) Trace 1 Mean 23.30 dBm Peak 26.84 dBm Crest 3.54 dB</p> <table border="1"> <tr><td>10 %</td><td>1.72 dB</td></tr> <tr><td>1 %</td><td>2.68 dB</td></tr> <tr><td>.1 %</td><td>3.16 dB</td></tr> <tr><td>.01 %</td><td>3.36 dB</td></tr> </table> <p>Date: 18.DEC.2018 17:03:56</p>	10 %	1.72 dB	1 %	2.68 dB	.1 %	3.16 dB	.01 %	3.36 dB	<p align="center">Middle Channel</p>  <p>Center 1.88 GHz 2 dB/ Mean Pwr + 20 dB</p> <p>Complementary Cumulative Distribution Function (100000 samples) Trace 1 Mean 23.02 dBm Peak 26.35 dBm Crest 3.32 dB</p> <table border="1"> <tr><td>10 %</td><td>1.68 dB</td></tr> <tr><td>1 %</td><td>2.60 dB</td></tr> <tr><td>.1 %</td><td>3.08 dB</td></tr> <tr><td>.01 %</td><td>3.24 dB</td></tr> </table> <p>Date: 18.DEC.2018 16:41:31</p>	10 %	1.68 dB	1 %	2.60 dB	.1 %	3.08 dB	.01 %	3.24 dB
10 %	1.72 dB																
1 %	2.68 dB																
.1 %	3.16 dB																
.01 %	3.36 dB																
10 %	1.68 dB																
1 %	2.60 dB																
.1 %	3.08 dB																
.01 %	3.24 dB																
<p align="center">Highest Channel</p>  <p>Center 846.6 MHz 2 dB/ Mean Pwr + 20 dB</p> <p>Complementary Cumulative Distribution Function (100000 samples) Trace 1 Mean 23.22 dBm Peak 26.84 dBm Crest 3.62 dB</p> <table border="1"> <tr><td>10 %</td><td>1.80 dB</td></tr> <tr><td>1 %</td><td>2.76 dB</td></tr> <tr><td>.1 %</td><td>3.20 dB</td></tr> <tr><td>.01 %</td><td>3.40 dB</td></tr> </table> <p>Date: 18.DEC.2018 17:04:18</p>	10 %	1.80 dB	1 %	2.76 dB	.1 %	3.20 dB	.01 %	3.40 dB	<p align="center">Highest Channel</p>  <p>Center 1.9076 GHz 2 dB/ Mean Pwr + 20 dB</p> <p>Complementary Cumulative Distribution Function (100000 samples) Trace 1 Mean 23.02 dBm Peak 26.20 dBm Crest 3.18 dB</p> <table border="1"> <tr><td>10 %</td><td>1.64 dB</td></tr> <tr><td>1 %</td><td>2.48 dB</td></tr> <tr><td>.1 %</td><td>2.88 dB</td></tr> <tr><td>.01 %</td><td>3.00 dB</td></tr> </table> <p>Date: 18.DEC.2018 16:41:48</p>	10 %	1.64 dB	1 %	2.48 dB	.1 %	2.88 dB	.01 %	3.00 dB
10 %	1.80 dB																
1 %	2.76 dB																
.1 %	3.20 dB																
.01 %	3.40 dB																
10 %	1.64 dB																
1 %	2.48 dB																
.1 %	2.88 dB																
.01 %	3.00 dB																



26dB Bandwidth

Mode	WCDMA Band V	WCDMA Band II
Mod.	RMC 12.2Kbps	RMC 12.2Kbps
Lowest CH	4.69	4.69
Middle CH	4.68	4.71
Highest CH	4.69	4.71



WCDMA Band V (RMC 12.2Kbps)

WCDMA Band II (RMC 12.2Kbps)

Lowest Channel

Lowest Channel

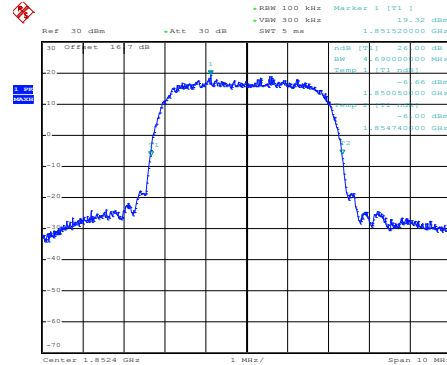
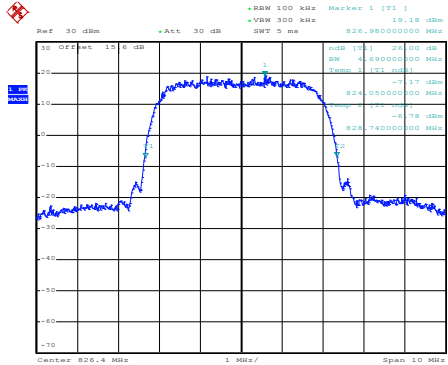

Date: 18.DEC.2018 16:43:01

Date: 18.DEC.2018 16:25:52

Middle Channel

Middle Channel

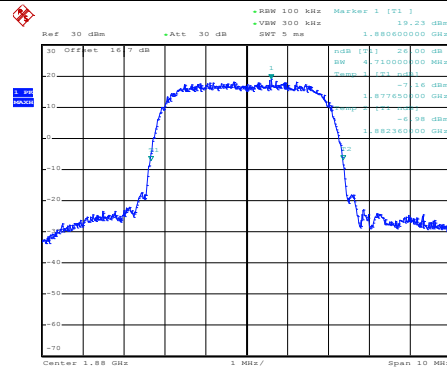
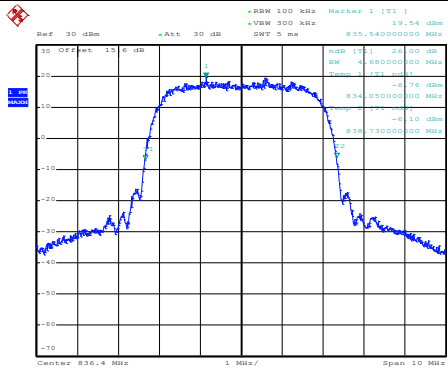

Date: 18.DEC.2018 16:43:37

Date: 18.DEC.2018 16:26:50

Highest Channel

Highest Channel

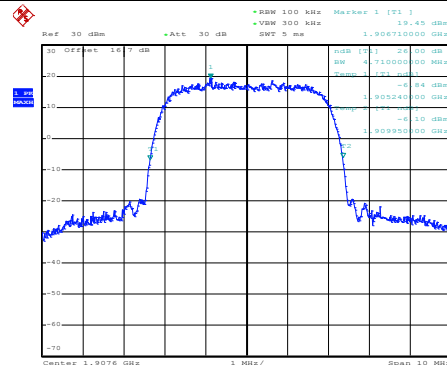
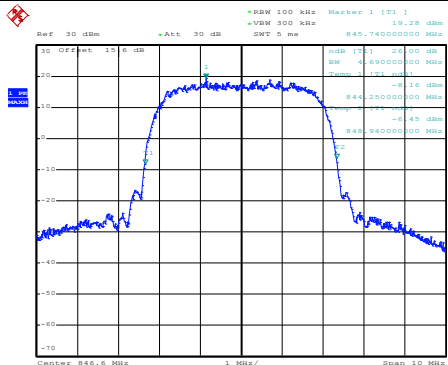

Date: 18.DEC.2018 16:44:14

Date: 18.DEC.2018 16:27:26



Occupied Bandwidth

Mode	WCDMA Band V	WCDMA Band II
Mod.	RMC 12.2Kbps	RMC 12.2Kbps
Lowest CH	4.13	4.12
Middle CH	4.09	4.12
Highest CH	4.11	4.12



Conducted Band Edge

WCDMA Band V (RMC 12.2Kbps)

Lowest Band Edge

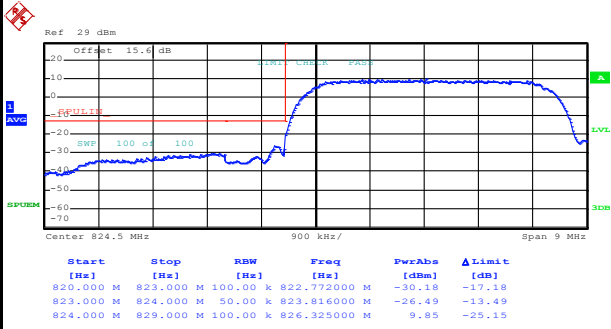

Date: 18.DEC.2018 16:56:45

Highest Band Edge

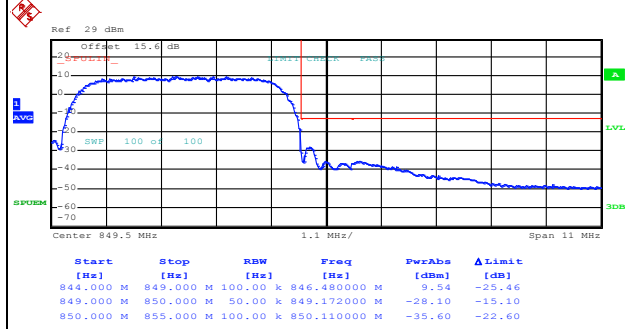

Date: 18.DEC.2018 16:59:38

WCDMA Band II (RMC 12.2Kbps)

Lowest Band Edge

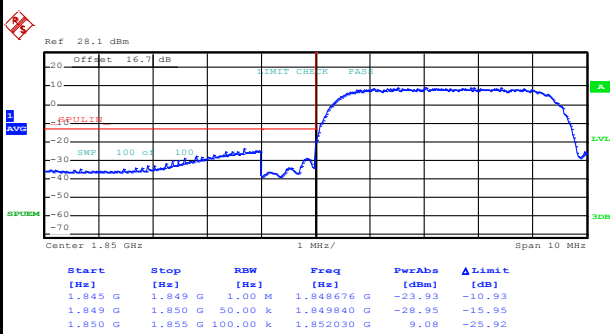

Date: 18.DEC.2018 16:32:48

Highest Band Edge

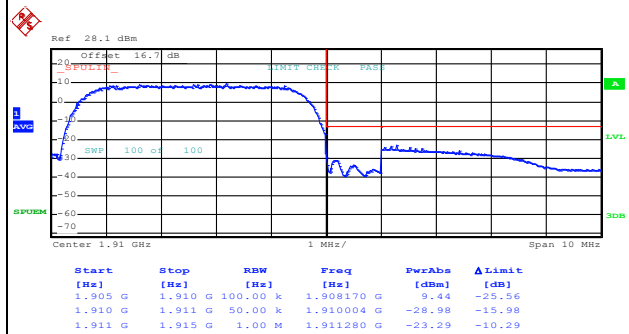

Date: 18.DEC.2018 16:35:38

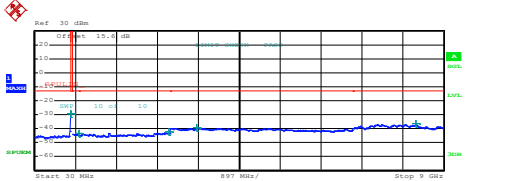
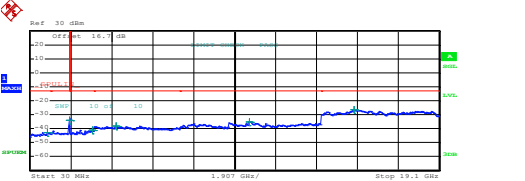
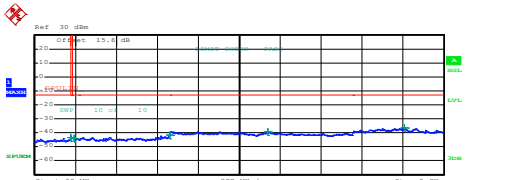
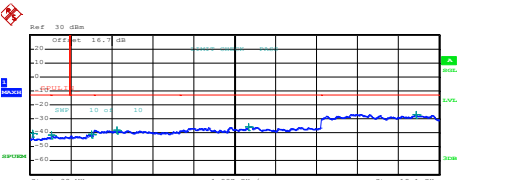
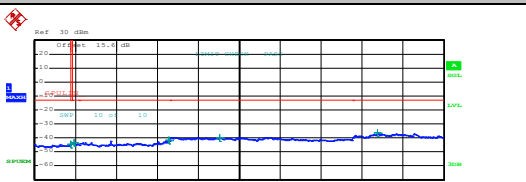
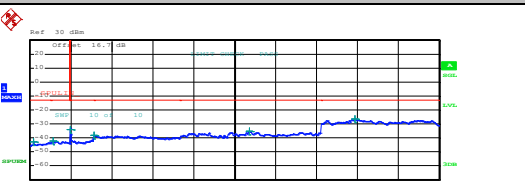

Conducted Spurious Emission

WCDMA Band V (RMC 12.2Kbps)	WCDMA Band II (RMC 12.2Kbps)																																																																														
Lowest Channel	Lowest Channel																																																																														
 <table border="1" data-bbox="239 660 702 739"> <thead> <tr> <th>Start [Hz]</th> <th>Stop [Hz]</th> <th>RBW [Hz]</th> <th>Freq [Hz]</th> <th>PwrAbs [dBm]</th> <th>ΔLimit [dB]</th> </tr> </thead> <tbody> <tr> <td>30.000 M</td> <td>820.000 M</td> <td>1.00 M</td> <td>818.012500 M</td> <td>-29.54</td> <td>-29.54</td> </tr> <tr> <td>835.000 M</td> <td>1.000 G</td> <td>1.00 M</td> <td>990.393759 M</td> <td>-43.54</td> <td>-30.54</td> </tr> <tr> <td>1.000 G</td> <td>3.000 G</td> <td>1.00 M</td> <td>2.973500 G</td> <td>-42.22</td> <td>-29.22</td> </tr> <tr> <td>3.000 G</td> <td>7.000 G</td> <td>1.00 M</td> <td>3.585000 G</td> <td>-39.47</td> <td>-26.47</td> </tr> <tr> <td>7.000 G</td> <td>9.000 G</td> <td>1.00 M</td> <td>8.138500 G</td> <td>-36.54</td> <td>-23.54</td> </tr> </tbody> </table> <p data-bbox="207 913 383 931">Date: 18.DEC.2018 17:01:09</p>	Start [Hz]	Stop [Hz]	RBW [Hz]	Freq [Hz]	PwrAbs [dBm]	ΔLimit [dB]	30.000 M	820.000 M	1.00 M	818.012500 M	-29.54	-29.54	835.000 M	1.000 G	1.00 M	990.393759 M	-43.54	-30.54	1.000 G	3.000 G	1.00 M	2.973500 G	-42.22	-29.22	3.000 G	7.000 G	1.00 M	3.585000 G	-39.47	-26.47	7.000 G	9.000 G	1.00 M	8.138500 G	-36.54	-23.54	 <table border="1" data-bbox="893 660 1356 739"> <thead> <tr> <th>Start [Hz]</th> <th>Stop [Hz]</th> <th>RBW [Hz]</th> <th>Freq [Hz]</th> <th>PwrAbs [dBm]</th> <th>ΔLimit [dB]</th> </tr> </thead> <tbody> <tr> <td>30.000 M</td> <td>1.000 G</td> <td>1.00 M</td> <td>826.127500 M</td> <td>-42.92</td> <td>-29.92</td> </tr> <tr> <td>1.000 G</td> <td>3.000 G</td> <td>1.00 M</td> <td>1.843099 G</td> <td>-34.24</td> <td>-21.24</td> </tr> <tr> <td>3.000 G</td> <td>7.000 G</td> <td>1.00 M</td> <td>2.934900 G</td> <td>-40.86</td> <td>-27.86</td> </tr> <tr> <td>7.000 G</td> <td>13.600 G</td> <td>1.00 M</td> <td>4.029000 G</td> <td>-38.00</td> <td>-25.00</td> </tr> <tr> <td>13.600 G</td> <td>19.100 G</td> <td>1.00 M</td> <td>10.248850 G</td> <td>-35.05</td> <td>-22.05</td> </tr> <tr> <td>19.100 G</td> <td>19.100 G</td> <td>1.00 M</td> <td>19.139313 G</td> <td>-26.68</td> <td>-13.68</td> </tr> </tbody> </table> <p data-bbox="861 913 1037 931">Date: 18.DEC.2018 16:38:51</p>	Start [Hz]	Stop [Hz]	RBW [Hz]	Freq [Hz]	PwrAbs [dBm]	ΔLimit [dB]	30.000 M	1.000 G	1.00 M	826.127500 M	-42.92	-29.92	1.000 G	3.000 G	1.00 M	1.843099 G	-34.24	-21.24	3.000 G	7.000 G	1.00 M	2.934900 G	-40.86	-27.86	7.000 G	13.600 G	1.00 M	4.029000 G	-38.00	-25.00	13.600 G	19.100 G	1.00 M	10.248850 G	-35.05	-22.05	19.100 G	19.100 G	1.00 M	19.139313 G	-26.68	-13.68
Start [Hz]	Stop [Hz]	RBW [Hz]	Freq [Hz]	PwrAbs [dBm]	ΔLimit [dB]																																																																										
30.000 M	820.000 M	1.00 M	818.012500 M	-29.54	-29.54																																																																										
835.000 M	1.000 G	1.00 M	990.393759 M	-43.54	-30.54																																																																										
1.000 G	3.000 G	1.00 M	2.973500 G	-42.22	-29.22																																																																										
3.000 G	7.000 G	1.00 M	3.585000 G	-39.47	-26.47																																																																										
7.000 G	9.000 G	1.00 M	8.138500 G	-36.54	-23.54																																																																										
Start [Hz]	Stop [Hz]	RBW [Hz]	Freq [Hz]	PwrAbs [dBm]	ΔLimit [dB]																																																																										
30.000 M	1.000 G	1.00 M	826.127500 M	-42.92	-29.92																																																																										
1.000 G	3.000 G	1.00 M	1.843099 G	-34.24	-21.24																																																																										
3.000 G	7.000 G	1.00 M	2.934900 G	-40.86	-27.86																																																																										
7.000 G	13.600 G	1.00 M	4.029000 G	-38.00	-25.00																																																																										
13.600 G	19.100 G	1.00 M	10.248850 G	-35.05	-22.05																																																																										
19.100 G	19.100 G	1.00 M	19.139313 G	-26.68	-13.68																																																																										
Middle Channel	Middle Channel																																																																														
 <table border="1" data-bbox="239 1176 702 1254"> <thead> <tr> <th>Start [Hz]</th> <th>Stop [Hz]</th> <th>RBW [Hz]</th> <th>Freq [Hz]</th> <th>PwrAbs [dBm]</th> <th>ΔLimit [dB]</th> </tr> </thead> <tbody> <tr> <td>30.000 M</td> <td>820.000 M</td> <td>1.00 M</td> <td>818.210000 M</td> <td>-43.64</td> <td>-30.64</td> </tr> <tr> <td>835.000 M</td> <td>1.000 G</td> <td>1.00 M</td> <td>890.230000 M</td> <td>-43.78</td> <td>-30.78</td> </tr> <tr> <td>1.000 G</td> <td>3.000 G</td> <td>1.00 M</td> <td>2.984500 G</td> <td>-41.45</td> <td>-28.45</td> </tr> <tr> <td>3.000 G</td> <td>7.000 G</td> <td>1.00 M</td> <td>5.142000 G</td> <td>-39.27</td> <td>-26.27</td> </tr> <tr> <td>7.000 G</td> <td>9.000 G</td> <td>1.00 M</td> <td>8.139500 G</td> <td>-36.45</td> <td>-23.45</td> </tr> </tbody> </table> <p data-bbox="207 1433 383 1451">Date: 18.DEC.2018 17:02:02</p>	Start [Hz]	Stop [Hz]	RBW [Hz]	Freq [Hz]	PwrAbs [dBm]	ΔLimit [dB]	30.000 M	820.000 M	1.00 M	818.210000 M	-43.64	-30.64	835.000 M	1.000 G	1.00 M	890.230000 M	-43.78	-30.78	1.000 G	3.000 G	1.00 M	2.984500 G	-41.45	-28.45	3.000 G	7.000 G	1.00 M	5.142000 G	-39.27	-26.27	7.000 G	9.000 G	1.00 M	8.139500 G	-36.45	-23.45	 <table border="1" data-bbox="893 1176 1356 1254"> <thead> <tr> <th>Start [Hz]</th> <th>Stop [Hz]</th> <th>RBW [Hz]</th> <th>Freq [Hz]</th> <th>PwrAbs [dBm]</th> <th>ΔLimit [dB]</th> </tr> </thead> <tbody> <tr> <td>30.000 M</td> <td>1.000 G</td> <td>1.00 M</td> <td>140.580000 M</td> <td>-40.51</td> <td>-27.51</td> </tr> <tr> <td>1.000 G</td> <td>3.000 G</td> <td>1.00 M</td> <td>3.026024 G</td> <td>-41.81</td> <td>-28.81</td> </tr> <tr> <td>3.000 G</td> <td>7.000 G</td> <td>1.00 M</td> <td>2.886617 G</td> <td>-41.07</td> <td>-28.07</td> </tr> <tr> <td>7.000 G</td> <td>13.600 G</td> <td>1.00 M</td> <td>4.079000 G</td> <td>-37.85</td> <td>-24.85</td> </tr> <tr> <td>13.600 G</td> <td>19.100 G</td> <td>1.00 M</td> <td>10.257600 G</td> <td>-35.56</td> <td>-22.56</td> </tr> <tr> <td>19.100 G</td> <td>19.100 G</td> <td>1.00 M</td> <td>18.025437 G</td> <td>-26.84</td> <td>-13.84</td> </tr> </tbody> </table> <p data-bbox="861 1433 1037 1451">Date: 18.DEC.2018 16:39:45</p>	Start [Hz]	Stop [Hz]	RBW [Hz]	Freq [Hz]	PwrAbs [dBm]	ΔLimit [dB]	30.000 M	1.000 G	1.00 M	140.580000 M	-40.51	-27.51	1.000 G	3.000 G	1.00 M	3.026024 G	-41.81	-28.81	3.000 G	7.000 G	1.00 M	2.886617 G	-41.07	-28.07	7.000 G	13.600 G	1.00 M	4.079000 G	-37.85	-24.85	13.600 G	19.100 G	1.00 M	10.257600 G	-35.56	-22.56	19.100 G	19.100 G	1.00 M	18.025437 G	-26.84	-13.84
Start [Hz]	Stop [Hz]	RBW [Hz]	Freq [Hz]	PwrAbs [dBm]	ΔLimit [dB]																																																																										
30.000 M	820.000 M	1.00 M	818.210000 M	-43.64	-30.64																																																																										
835.000 M	1.000 G	1.00 M	890.230000 M	-43.78	-30.78																																																																										
1.000 G	3.000 G	1.00 M	2.984500 G	-41.45	-28.45																																																																										
3.000 G	7.000 G	1.00 M	5.142000 G	-39.27	-26.27																																																																										
7.000 G	9.000 G	1.00 M	8.139500 G	-36.45	-23.45																																																																										
Start [Hz]	Stop [Hz]	RBW [Hz]	Freq [Hz]	PwrAbs [dBm]	ΔLimit [dB]																																																																										
30.000 M	1.000 G	1.00 M	140.580000 M	-40.51	-27.51																																																																										
1.000 G	3.000 G	1.00 M	3.026024 G	-41.81	-28.81																																																																										
3.000 G	7.000 G	1.00 M	2.886617 G	-41.07	-28.07																																																																										
7.000 G	13.600 G	1.00 M	4.079000 G	-37.85	-24.85																																																																										
13.600 G	19.100 G	1.00 M	10.257600 G	-35.56	-22.56																																																																										
19.100 G	19.100 G	1.00 M	18.025437 G	-26.84	-13.84																																																																										
Highest Channel	Highest Channel																																																																														
 <table border="1" data-bbox="239 1691 702 1769"> <thead> <tr> <th>Start [Hz]</th> <th>Stop [Hz]</th> <th>RBW [Hz]</th> <th>Freq [Hz]</th> <th>PwrAbs [dBm]</th> <th>ΔLimit [dB]</th> </tr> </thead> <tbody> <tr> <td>30.000 M</td> <td>820.000 M</td> <td>1.00 M</td> <td>812.830000 M</td> <td>-44.23</td> <td>-31.23</td> </tr> <tr> <td>835.000 M</td> <td>1.000 G</td> <td>1.00 M</td> <td>891.068750 M</td> <td>-43.55</td> <td>-30.55</td> </tr> <tr> <td>1.000 G</td> <td>3.000 G</td> <td>1.00 M</td> <td>2.979500 G</td> <td>-42.91</td> <td>-29.91</td> </tr> <tr> <td>3.000 G</td> <td>7.000 G</td> <td>1.00 M</td> <td>4.090000 G</td> <td>-39.69</td> <td>-26.69</td> </tr> <tr> <td>7.000 G</td> <td>9.000 G</td> <td>1.00 M</td> <td>7.555000 G</td> <td>-36.53</td> <td>-23.53</td> </tr> </tbody> </table> <p data-bbox="207 1948 383 1966">Date: 18.DEC.2018 17:02:55</p>	Start [Hz]	Stop [Hz]	RBW [Hz]	Freq [Hz]	PwrAbs [dBm]	ΔLimit [dB]	30.000 M	820.000 M	1.00 M	812.830000 M	-44.23	-31.23	835.000 M	1.000 G	1.00 M	891.068750 M	-43.55	-30.55	1.000 G	3.000 G	1.00 M	2.979500 G	-42.91	-29.91	3.000 G	7.000 G	1.00 M	4.090000 G	-39.69	-26.69	7.000 G	9.000 G	1.00 M	7.555000 G	-36.53	-23.53	 <table border="1" data-bbox="893 1691 1356 1769"> <thead> <tr> <th>Start [Hz]</th> <th>Stop [Hz]</th> <th>RBW [Hz]</th> <th>Freq [Hz]</th> <th>PwrAbs [dBm]</th> <th>ΔLimit [dB]</th> </tr> </thead> <tbody> <tr> <td>30.000 M</td> <td>1.000 G</td> <td>1.00 M</td> <td>170.852500 M</td> <td>-42.56</td> <td>-29.56</td> </tr> <tr> <td>1.000 G</td> <td>3.000 G</td> <td>1.00 M</td> <td>1.092739 G</td> <td>-42.32</td> <td>-29.32</td> </tr> <tr> <td>3.000 G</td> <td>7.000 G</td> <td>1.00 M</td> <td>1.937370 G</td> <td>-39.90</td> <td>-26.90</td> </tr> <tr> <td>7.000 G</td> <td>13.600 G</td> <td>1.00 M</td> <td>3.098000 G</td> <td>-38.22</td> <td>-25.22</td> </tr> <tr> <td>13.600 G</td> <td>19.100 G</td> <td>1.00 M</td> <td>10.239775 G</td> <td>-35.48</td> <td>-22.48</td> </tr> <tr> <td>19.100 G</td> <td>19.100 G</td> <td>1.00 M</td> <td>19.139313 G</td> <td>-26.68</td> <td>-13.68</td> </tr> </tbody> </table> <p data-bbox="861 1948 1037 1966">Date: 18.DEC.2018 16:40:41</p>	Start [Hz]	Stop [Hz]	RBW [Hz]	Freq [Hz]	PwrAbs [dBm]	ΔLimit [dB]	30.000 M	1.000 G	1.00 M	170.852500 M	-42.56	-29.56	1.000 G	3.000 G	1.00 M	1.092739 G	-42.32	-29.32	3.000 G	7.000 G	1.00 M	1.937370 G	-39.90	-26.90	7.000 G	13.600 G	1.00 M	3.098000 G	-38.22	-25.22	13.600 G	19.100 G	1.00 M	10.239775 G	-35.48	-22.48	19.100 G	19.100 G	1.00 M	19.139313 G	-26.68	-13.68
Start [Hz]	Stop [Hz]	RBW [Hz]	Freq [Hz]	PwrAbs [dBm]	ΔLimit [dB]																																																																										
30.000 M	820.000 M	1.00 M	812.830000 M	-44.23	-31.23																																																																										
835.000 M	1.000 G	1.00 M	891.068750 M	-43.55	-30.55																																																																										
1.000 G	3.000 G	1.00 M	2.979500 G	-42.91	-29.91																																																																										
3.000 G	7.000 G	1.00 M	4.090000 G	-39.69	-26.69																																																																										
7.000 G	9.000 G	1.00 M	7.555000 G	-36.53	-23.53																																																																										
Start [Hz]	Stop [Hz]	RBW [Hz]	Freq [Hz]	PwrAbs [dBm]	ΔLimit [dB]																																																																										
30.000 M	1.000 G	1.00 M	170.852500 M	-42.56	-29.56																																																																										
1.000 G	3.000 G	1.00 M	1.092739 G	-42.32	-29.32																																																																										
3.000 G	7.000 G	1.00 M	1.937370 G	-39.90	-26.90																																																																										
7.000 G	13.600 G	1.00 M	3.098000 G	-38.22	-25.22																																																																										
13.600 G	19.100 G	1.00 M	10.239775 G	-35.48	-22.48																																																																										
19.100 G	19.100 G	1.00 M	19.139313 G	-26.68	-13.68																																																																										



Frequency Stability

Test Conditions	Middle Channel	WCDMA Band V (RMC 12.2Kbps)	Limit 2.5ppm
Temperature (°C)	Voltage (Volt)	Deviation (ppm)	Result
50	Normal Voltage	0.0036	PASS
40	Normal Voltage	0.0036	
30	Normal Voltage	0.0060	
20(Ref.)	Normal Voltage	0.0000	
10	Normal Voltage	0.0179	
0	Normal Voltage	0.0203	
-10	Normal Voltage	0.0227	
-20	Normal Voltage	0.0239	
-30	Normal Voltage	0.0203	
20	Maximum Voltage	0.0036	
20	Normal Voltage	0.0000	
20	Battery End Point	0.0084	



Test Conditions	Middle Channel	WCDMA Band II (RMC 12.2Kbps)	Limit Note 2.
Temperature (°C)	Voltage (Volt)	Deviation (ppm)	Result
50	Normal Voltage	0.0005	PASS
40	Normal Voltage	0.0053	
30	Normal Voltage	0.0011	
20(Ref.)	Normal Voltage	0.0000	
10	Normal Voltage	0.0005	
0	Normal Voltage	0.0032	
-10	Normal Voltage	0.0053	
-20	Normal Voltage	0.0053	
-30	Normal Voltage	0.0048	
20	Maximum Voltage	0.0037	
20	Normal Voltage	0.0000	
20	Battery End Point	0.0048	

Note:

- 1. Normal Voltage = 9V. ; Battery End Point (BEP) = 7.65 V. ; Maximum Voltage =10.35 V
- 2. The frequency fundamental emissions stay within the authorized frequency block.



Appendix B. Test Results of ERP/EIRP and Radiated Test

ERP/EIRP

Channel	Mode	Conducted		ERP	
		Power (dBm)	Power (Watts)	ERP(dBm)	ERP(W)
Lowest	WCDMA Band V	24.64	0.2911	24.39	0.2748
Middle	RMC 12.2Kbps	24.42	0.2767	24.17	0.2612
Highest	(GT - LC = 1.9 dB)	24.23	0.2649	23.98	0.2500
Limit	ERP < 7W	Result		PASS	

Channel	Mode	Conducted		EIRP	
		Power (dBm)	Power (Watts)	EIRP(dBm)	EIRP(W)
Lowest	WCDMA Band II	24.74	0.2979	27.74	0.5943
Middle	RMC 12.2Kbps	25.39	0.3459	28.39	0.6902
Highest	(GT - LC = 3 dB)	25.09	0.3228	28.09	0.6442
Limit	EIRP < 2W	Result		PASS	



Radiated Spurious Emission

WCDMA 850

WCDMA 850									
Channel	Frequency (MHz)	ERP (dBm)	Limit (dBm)	Over Limit (dB)	SPA Reading (dBm)	S.G. Power (dBm)	TX Cable loss (dB)	TX Antenna Gain (dBi)	Polarization (H/V)
Lowest	1648	-59.22	-13	-46.22	-71.68	-60.98	0.98	4.89	H
	2480	-49.74	-13	-36.74	-67.28	-51.65	1.28	5.34	H
	3296	-57.71	-13	-44.71	-77.58	-61.12	1.54	7.10	H
									H
									H
									H
									H
	1648	-61.53	-13	-48.53	-74.48	-63.29	0.98	4.89	V
	2480	-55.35	-13	-42.35	-73.33	-57.26	1.28	5.34	V
	3296	-57.48	-13	-44.48	-77.64	-60.89	1.54	7.10	V
									V
									V
									V
									V



Middle	1672	-61.18	-13	-48.18	-73.95	-62.86	0.99	4.82	H
	2512	-52.94	-13	-39.94	-70.63	-54.91	1.29	5.41	H
	3344	-57.87	-13	-44.87	-77.94	-61.48	1.56	7.31	H
									H
									H
									H
									H
	1672	-60.47	-13	-47.47	-73.69	-62.15	0.99	4.82	V
	2512	-57.06	-13	-44.06	-75.24	-59.03	1.29	5.41	V
	3344	-57.65	-13	-44.65	-77.95	-61.26	1.56	7.31	V
									V
									V
									V
									V
Highest	1688	-50.54	-13	-37.54	-63.3	-52.17	1.00	4.77	H
	2536	-55.96	-13	-42.96	-72.66	-57.94	1.30	5.43	H
	3376	-57.69	-13	-44.69	-77.9	-61.43	1.57	7.45	H
									H
									H
									H
									H
	1688	-54.49	-13	-41.49	-67.7	-56.12	1.00	4.77	V
	2536	-56.66	-13	-43.66	-74.85	-58.64	1.30	5.43	V
	3376	-57.72	-13	-44.72	-77.97	-61.46	1.57	7.45	V
									V
									V
									V
									V

Remark: Spurious emissions within 30-1000MHz were found more than 20dB below limit line.



WCDMA 1900

WCDMA 1900									
Channel	Frequency (MHz)	EIRP (dBm)	Limit (dBm)	Over Limit (dB)	SPA Reading (dBm)	S.G. Power (dBm)	TX Cable loss (dB)	TX Antenna Gain (dBi)	Polarization (H/V)
Lowest	3702	-50.26	-13	-37.26	-71.37	-56.83	1.67	8.24	H
	5556	-40.93	-13	-27.93	-66.34	-48	2.66	9.72	H
	7410	-50.99	-13	-37.99	-78.37	-60.15	2.46	11.62	H
									H
									H
									H
									H
	3702	-46.94	-13	-33.94	-68.04	-53.51	1.67	8.24	V
	5556	-41.75	-13	-28.75	-67.13	-48.82	2.66	9.72	V
	7410	-50.43	-13	-37.43	-78.02	-59.59	2.46	11.62	V
									V
									V
									V
									V
Middle	3756	-53.89	-13	-40.89	-74.95	-60.51	1.68	8.31	H
	5640	-39.57	-13	-26.57	-65.35	-46.62	2.71	9.76	H
	7518	-50.19	-13	-37.19	-77.56	-59.58	2.42	11.81	H
									H
									H
									H
									H
	3756	-52.12	-13	-39.12	-73.19	-58.74	1.68	8.31	V
	5640	-41.53	-13	-28.53	-67.17	-48.58	2.71	9.76	V
	7518	-50.07	-13	-37.07	-77.72	-59.46	2.42	11.81	V
									V
									V
									V
									V



Highest	3819	-55.91	-13	-42.91	-76.7	-62.59	1.70	8.38	H
	5726	-39.84	-13	-26.84	-65.42	-46.88	2.76	9.79	H
	7635	-49.23	-13	-36.23	-76.94	-58.73	2.39	11.88	H
									H
									H
									H
									H
	3819	-52.34	-13	-39.34	-73.12	-59.02	1.70	8.38	V
	5726	-41.07	-13	-28.07	-66.52	-48.11	2.76	9.79	V
	7635	-48.91	-13	-35.91	-76.82	-58.41	2.39	11.88	V
									V
									V
									V
									V

Remark: Spurious emissions within 30-1000MHz were found more than 20dB below limit line.