

RF MEASUREMENT REPORT

FCC ID: XMR2022RG520NNA
Application: Quectel Wireless Solutions Co., Ltd
Product: 5G Sub-6 GHz LGA Module
Model No.: RG520N-NA
Brand Name: Quectel
FCC Rule Part(s): Part 2, 22 (H), 24 (E), 27
Test Procedure(s): ANSI C63.26: 2015
Result: Complies
Test Date: 2022-04-26 ~ 2022-07-22

Reviewed By:

Sunny Sun

Sunny Sun

Approved By:

Robin Wu

Robin Wu



The test results relate only to the samples tested.

This equipment has been shown to be capable of compliance with the applicable technical standards as indicated in the measurement report and was tested in accordance with the measurement procedures specified in ANSI C63.26-2015. Test results reported herein relate only to the item(s) tested.

The test report shall not be reproduced except in full without the written approval of MRT Technology (Suzhou) Co., Ltd.

Revision History

Report No.	Version	Description	Issue Date	Note
2204RSU037-U1	Rev. 01	Initial Report	2022-08-07	Valid

CONTENTS

Description	Page
1. General Information.....	5
1.1. Applicant.....	5
1.2. Manufacturer.....	5
1.3. Testing Facility.....	5
1.4. Product Information.....	6
1.5. Radio Specification under Test.....	6
1.6. Description of Available Antennas.....	7
1.7. Test Methodology.....	7
1.8. Device Capabilities.....	8
2. Test Configuration.....	9
2.1. Test System Connection Diagram.....	9
2.2. Test Environment Condition.....	9
3. Measuring Instrument.....	10
4. Decision Rules and Measurement Uncertainty.....	12
4.1. Decision Rules.....	12
4.2. Measurement Uncertainty.....	12
5. Test Result.....	13
5.1. Summary.....	13
5.2. Occupied Bandwidth Measurement.....	14
5.2.1. Test Limit.....	14
5.2.2. Test Procedure.....	14
5.2.3. Test Setting.....	14
5.2.4. Test Setup.....	14
5.2.5. Test Result.....	14
5.3. Frequency Stability Measurement.....	15
5.3.1. Test Limit.....	15
5.3.2. Test Procedure.....	15
5.3.3. Test Setting.....	15
5.3.4. Test Setup.....	16
5.3.5. Test Result.....	16
5.4. Equivalent Isotropically Radiated Power Measurement.....	17
5.4.1. Test Limit.....	17
5.4.2. Test Procedure.....	17
5.4.3. Test Setting.....	17

5.4.4.	Test Setup	18
5.4.5.	Test Result	18
5.5.	Band Edge Measurement	19
5.5.1.	Test Limit	19
5.5.2.	Test Procedure	19
5.5.3.	Test Setting	20
5.5.4.	Test Setup	20
5.5.5.	Test Result	20
5.6.	Peak to Average Ratio Measurement	21
5.6.1.	Test Limit	21
5.6.2.	Test Procedure	21
5.6.3.	Test Setting	21
5.6.4.	Test Setup	21
5.6.5.	Test Result	21
5.7.	Conducted Spurious Emissions Measurement	22
5.7.1.	Test Limit	22
5.7.2.	Test Procedure	22
5.7.3.	Test Setting	22
5.7.4.	Test Setup	23
5.7.5.	Test Result	23
5.8.	Radiated Spurious Emissions Measurement	24
5.8.1.	Test Limit	24
5.8.2.	Test Procedure	24
5.8.3.	Test Setting	24
5.8.4.	Test Setup	25
5.8.5.	Test Result	26
Appendix A - Test Result		27
A.1	Occupied Bandwidth Test Result	27
A.2	Frequency Stability Test Result	117
A.3	Equivalent Isotropically Radited Power Test Result	126
A.4	Band Edge Test Result	310
A.5	Peak to Average Radio Test Result	405
A.6	Conducted Spurious Emissions Test Result	414
A.7	Radiated Spurious Emissions Test Result	475
Appendix B - Test Setup Photograph		484
Appendix C - EUT Photograph		485

1. General Information

1.1. Applicant

Quectel Wireless Solutions Co., Ltd

Building 5, Shanghai Business Park Phase III (Area B), No.1016 Tianlin Road, Minhang District, Shanghai, China 200233

1.2. Manufacturer

Quectel Wireless Solutions Co., Ltd

Building 5, Shanghai Business Park Phase III (Area B), No.1016 Tianlin Road, Minhang District, Shanghai, China 200233

1.3. Testing Facility

<input checked="" type="checkbox"/>	Test Site - MRT Suzhou Laboratory
	Laboratory Location (Suzhou - Wuzhong) D8 Building, No.2 Tian'edang Rd., Wuzhong Economic Development Zone, Suzhou, China
	Laboratory Location (Suzhou - SIP) 4b Building, Liando U Valley, No.200 Xingpu Rd., Shengpu Town, Suzhou Industrial Park, China
	Laboratory Accreditations
	A2LA: 3628.01 FCC: CN1166 VCCI: R-20025, G-20034, C-20020, T-20020
<input type="checkbox"/>	Test Site - MRT Shenzhen Laboratory
	Laboratory Location (Shenzhen) 1G, Building A, Junxiangda Building, Zhongshanyuan Road West, Nanshan District, Shenzhen, China
	Laboratory Accreditations
	A2LA: 3628.02 FCC: CN1284
<input type="checkbox"/>	Test Site - MRT Taiwan Laboratory
	Laboratory Location (Taiwan) No. 38, Fuxing 2 nd Rd., Guishan Dist., Taoyuan City 333, Taiwan (R.O.C.)
	Laboratory Accreditations
	TAF: L3261-190725 FCC: 291082, TW3261

1.4. Product Information

Product Name	5G Sub-6 GHz LGA Module
Model No.	RG520N-NA
Brand Name	Quectel
IMEI	Conducted Measurement 1: 863109050007421 Conducted Measurement 2: 863109050005151 Radiated Measurement: 863109050007306
E-UTRA Band	Band 2, 4, 5, 7, 12, 13, 14, 17, 25, 26, 30, 38, 41, 48, 66, 71
5G NR Band	n2, n5, n7, n12, n13, n14, n25, n26, n30, n38, n41, n66, n71, n77, n78
Operating Temperature	-30 ~ 75 °C
Power Type	3.3 ~ 4.4Vdc, typical 3.8Vdc
Remark: The declared of product specification for EUT presented in the report are provided by the manufacturer, and the manufacturer takes all the responsibilities for the accuracy of product specification.	

1.5. Radio Specification under Test

E-UTRA Specification	
FDD T _x Frequency Range	Band 2: 1850 ~ 1910 MHz; Band 4: 1710 ~ 1755 MHz Band 5: 824 ~ 849 MHz; Band 7: 2500 ~ 2570 MHz Band 12: 699 ~ 716 MHz; Band 13: 777 ~ 787 MHz Band 17: 704 ~ 716 MHz; Band 25: 1850 ~ 1915 MHz; Band 26: 824 ~ 849 MHz; Band 66: 1710 ~ 1780 MHz Band 71: 663 ~ 698 MHz
FDD R _x Frequency Range	Band 2: 1930 ~ 1990 MHz; Band 4: 2110 ~ 2155 MHz Band 5: 869 ~ 894 MHz; Band 7: 2620 ~ 2690 MHz Band 12: 729 ~ 746 MHz; Band 13: 746 ~ 756 MHz Band 17: 734 ~ 746 MHz; Band 25: 1930 ~ 1995 MHz; Band 26: 869 ~ 894 MHz; Band 66: 2110 ~ 2200 MHz Band 71: 617 ~ 652 MHz
TDD T _x & R _x Frequency Range	Band 38: 2570 ~ 2620 MHz; Band 41: 2496 ~ 2690 MHz;
Intra-Band:	CA_2C, CA_5B, CA_7C, CA_38C, CA_41C, CA_48C, CA_66B, CA_66C
Modulation:	UL up to 256QAM, DL up to 256QAM
Remark:	
<ol style="list-style-type: none"> For other features of this EUT, test report will be issued separately. LTE band 26 transmit frequency for part 90 rule is 814 ~ 824MHz and part 22 rule is 824 ~ 849MHz. ERP over 15MHz bandwidth complies the ERP limit line of part 22 rule, therefore ERP of the partial frequency spectrum which falls within part 22 also complies. 	

1.6. Description of Available Antennas

Technology	Frequency Range (MHz)	Antenna Type	MaxPeak Gain (dBi)
LTE Band 2	1850 ~ 1910	Dipole	1.37
LTE Band 4	1710 ~ 1755		1.37
LTE Band 5	824 ~ 849		1.18
LTE Band 7	2500 ~ 2570		2.07
LTE Band 12	699 ~ 716		1.18
LTE Band 13	777 ~ 787		1.18
LTE Band 14	788 ~ 798		1.18
LTE Band 17	704~ 716		1.18
LTE Band 25	1850 ~ 1915		1.37
LTE Band 26	814~849		1.18
LTE Band 30	2305 ~ 2315		1.11
LTE Band 38	2570 ~ 2620		2.07
LTE Band 41	2496 ~ 2690		2.07
LTE Band 48	3550 ~ 3700		0.58
LTE Band 66	1710 ~ 1780		1.37
LTE Band 71	663 ~ 698		1.18

Note: All antenna information (Antenna type and Peak Gain) is provided by the manufacturer.

1.7. Test Methodology

According to the specifications of the manufacturer, the EUT must comply with the requirements of the following standards:

- ANSI C63.26:2015
- FCC CFR 47 Part 2, Part 22, Part 24, Part 27
- FCC KDB 971168 D01 v03r01: Power Meas License Digital Systems
- FCC KDB 971168 D02 v02r01: Misc Rev Approv License Devices
- FCC KDB 412172 D01 v01r01: Determining ERP and EIRP

1.8. Device Capabilities

This device contains the following capabilities:

Working on LTE Band 2, 4, 5, 7, 12, 13, 14, 17, 25, 26, 30, 38, 41, 48, 66, 71; Intra-band CA_2C, CA_5B, CA_7C, CA_38C, CA_41C, CA_48C, CA_66B, CA_66C LTE Module.

LTE Band 25 (1850 ~ 1915 MHz) overlaps the entire frequency range of LTE Band 2 (1850 ~ 1910 MHz). Therefore, test data provided in this report covers Band 2 as well as Band 25.

LTE Band 66 (1710 ~ 1780 MHz) overlaps the entire frequency range of LTE Band 4 (1710 ~ 1755 MHz). Therefore, test data provided in this report covers Band 4 as well as Band 66.

LTE Band 26 (814 ~ 849 MHz) overlaps the entire frequency range of LTE Band 5 (824 ~ 849 MHz). Therefore, test data provided in this report covers Band 5 as well as Band 26.

LTE Band 41 (2496 ~ 2690 MHz) overlaps the entire frequency range of LTE Band 38 (2570 ~ 2620 MHz). Therefore, test data provided in this report covers Band 38 as well as Band 41

2. Test Configuration

2.1. Test System Connection Diagram

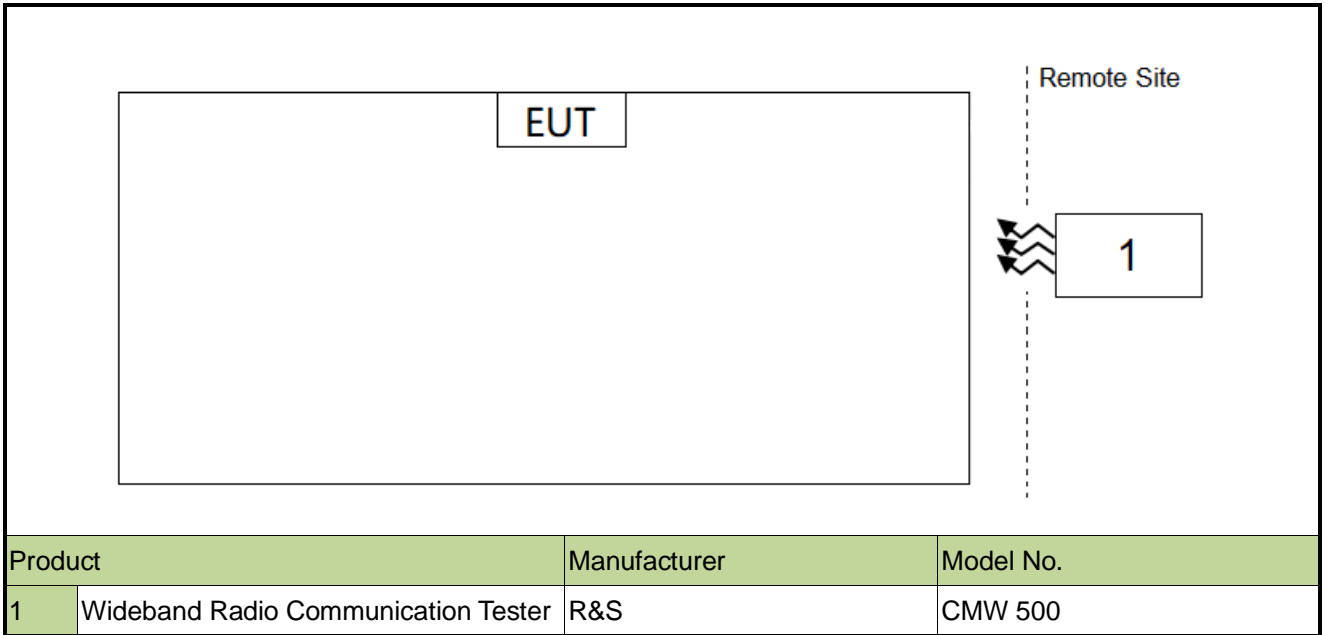

2.2. Test Environment Condition

Ambient Temperature	15 ~ 35°C
Relative Humidity	20% ~ 75%RH

3. Measuring Instrument

Instrument	Manufacturer	Model No.	Asset No.	Cali. Interval	Cali. Due Date	Test Site
Signal Analyzer	Keysight	N9010B	MRTSUE07028	1 year	2022-12-09	SIP-SR1
Signal Analyzer	Keysight	N9010B	MRTSUE06559	1 year	2023-06-01	SIP-SR1
Signal Analyzer	Keysight	N9010B	MRTSUE06603	1 year	2022-10-31	SIP-SR1
Signal Analyzer	Keysight	N9020B	MRTSUE06604	1 year	2022-09-07	SIP-SR1
Communication Tester	R&S	CMU 200	MRTSUE06009	1 year	2022-09-07	SIP-SR1
Communication Tester	R&S	CMW500	MRTSUE06243	1 year	2022-10-10	SIP-SR1
Signal Generator	Keysight	E8257D	MRTSUE06453	1 year	2023-06-01	SIP-SR1
Thermohygrometer	testo	622	MRTSUE06629	1 year	2023-01-06	SIP-SR1
5G Wireless Test Platform	Keysight	E7515B	MRTSUE06903	1 year	2022-11-23	SIP-SR1
Signal Generator	Keysight	E8257D	MRTSUE06904	1 year	2022-11-23	SIP-SR1
DC POWER MODULE	Keysight	N6743B	MRTSUE06905	N/A	N/A	SIP-SR1
DC POWER MODULE	Keysight	N6743B	MRTSUE06906	N/A	N/A	SIP-SR1
Low-Profile Modular Power System Mainframe	Keysight	N6700C	MRTSUE06907	N/A	N/A	SIP-SR1
FR1 Switching Unit	Keysight	C8880A	MRTSUE06908	N/A	N/A	SIP-SR1
Signal Analyzer	Keysight	N9021B	MRTSUE06915	1 year	2022-12-29	SIP-SR1
Temperature Chamber	BAOYT	BYG-80CL	MRTSUE06932	1 year	2023-02-27	SIP-SR1
Shielding Room	MIX-BEP	SIP-SR1	MRTSUE06948	N/A	N/A	SIP-SR1
Millimeter-Wave Transceiver for 5G	Keysight	M1740A	MRTSUE06954	3 years	2024-06-02	SIP-SR1
Millimeter-Wave Transceiver for 5G	Keysight	M1740A	MRTSUE06955	3 years	2024-06-02	SIP-SR1
5G Wireless Test Platform	Keysight	E7515B	MRTSUE06956	1 year	2023-06-01	SIP-SR1
Common Interface Unit	Keysight	E7770A	MRTSUE06957	N/A	N/A	SIP-SR1
USB Power Sensor	Keysight	U8488A	MRTSUE06958	1 year	2022-07-08	SIP-SR1
Directional Coupler	ar	DC7200A	MRTSUE06147	N/A	N/A	SIP
Directional Coupler	ar	DC6080A	MRTSUE06148	N/A	N/A	SIP-SR1
Directional Coupler	narda	4226-10	MRTSUE06564	1 year	2022-10-11	SIP-SR1
Directional Coupler	PULSAR	CS10-23-436/20	MRTSUE06846	1 year	2023-06-02	SIP-SR1
Directional Coupler	PULSAR	CS10-23-436/20	MRTSUE06848	1 year	2023-06-02	SIP-SR1
Attenuator	MVE	MVE2213	MRTSUE11055	1 year	2023-06-09	SIP-SR1
Attenuator	MVE	MVE2213	MRTSUE11056	1 year	2023-06-09	SIP-SR1
Attenuator	MVE	MVE2213	MRTSUE11057	1 year	2023-06-09	SIP-SR1
Attenuator	MVE	MVE2213	MRTSUE11058	1 year	2023-06-09	SIP-SR1
Attenuator	MVE	MVE2213	MRTSUE11059	1 year	2023-06-09	SIP-SR1

Attenuator	MVE	MVE2213	MRTSUE11060	1 year	2023-06-09	SIP-SR1
------------	-----	---------	-------------	--------	------------	---------

Software	Version	Function
EMI Software	V3.0.0	EMI Test Software

4. Decision Rules and Measurement Uncertainty

4.1. Decision Rules

The Decision Rule is based on Simple Acceptance in accordance with ISO Guide 98-4: 2012 Clause 8.2. (Measurement uncertainty is not taken into account when stating conformity with a specified requirement.)

4.2. Measurement Uncertainty

Where relevant, the following test uncertainty levels have been estimated for tests performed on the EUT as specified in CISPR 16-4-2. This uncertainty represents an expanded uncertainty expressed at approximately the 95% confidence level using a coverage factor of $k = 2$.

Radiated Spurious Emissions
Measurement Uncertainty for a Level of Confidence of 95% ($U=2Uc(y)$): Horizontal: 9kHz ~ 300MHz: 5.04dB 300MHz ~ 1GHz: 4.95dB 1GHz ~ 40GHz: 6.40dB Vertical: 9kHz ~ 300MHz: 5.24dB 300MHz ~ 1GHz: 6.03dB 1GHz ~ 40GHz: 6.40dB
Conducted Spurious Emissions
Measuring Uncertainty for a Level of Confidence of 95% ($U=2Uc(y)$): 0.78dB
Output Power
Measuring Uncertainty for a Level of Confidence of 95% ($U=2Uc(y)$): 1.13dB
Occupied Bandwidth
Measuring Uncertainty for a Level of Confidence of 95% ($U=2Uc(y)$): 0.28%
Frequency Stability
Measuring Uncertainty for a Level of Confidence of 95% ($U=2Uc(y)$): 76.2Hz

5. Test Result

5.1. Summary

FCC Part Section(s)	Test Description	Test Condition	Test Result	Reference
2.1049	Occupied Bandwidth	Conducted	Pass	Section 5.2
2.1055, 22.355 24.235, 27.54	Frequency Stability		Pass	Section 5.3
22.913(a)(5) 27.50(b)(9), (c)(9), (c)(10)	Equivalent Radiated Power (Band 5/2612, 13, 17, 71)		Pass	Section 5.4
24.232(c) 27.50(h)(2), (d)(4)	Equivalent Isotropic Radiated Power (Band 2/25, 7, 38/41, 4/66)		Pass	Section 5.6
24.232(d), 27.50(d)(5)	Peak to Average Ratio		Pass	Section 5.6
2.1051, 22.917(a) 24.238(a), 27.53(c), (g), (h), (m)	Band Edge		Pass	Section 5.5, 5.7
2.1051, 22.917(a) 24.238(a) 27.53(c), (g), (h), (m)	Spurious Emission			
2.1051, 22.917(a) 24.238(a) 27.53(c), (g), (h), (m)	Spurious Emissions	Radiated	Pass	Section 5.8

Notes:

- 1) The analyzer plots shown in this section were all taken with a correction table loaded into the analyzer. The correction table was used to account for the losses of the cables and attenuators used as part of the system to connect the EUT to the analyzer at all frequencies of interest.
- 2) All supported modulation types were evaluated. The worst-case emission of modulation was selected. Therefore, the Frequency Stability, Channel Band Edge, Conducted Spurious Emission, Radiated Spurious Emission (include the Intr-Band CA Mode) were presented the worst-case in the test report.

5.2. Occupied Bandwidth Measurement

5.2.1. Test Limit

The occupied bandwidth, that is the frequency bandwidth such that, below its lower and above its upper frequency limits, the mean powers radiated are each equal to 0.5 percent of the total mean power radiated by a given emission shall be measured.

5.2.2. Test Procedure

ANSI C63.26-2015 - Section 5.4

5.2.3. Test Setting

1. Set center frequency to the nominal EUT channel center frequency
2. RBW = The nominal RBW shall be in the range of 1% to 5% of the anticipated OBW
3. VBW $\geq 3 \times$ RBW
4. Detector = Peak
5. Trace mode = max hold
6. Sweep = auto couple
7. Allow the trace to stabilize
8. Use the 99% power bandwidth function of the instrument and report the measured bandwidth.

5.2.4. Test Setup

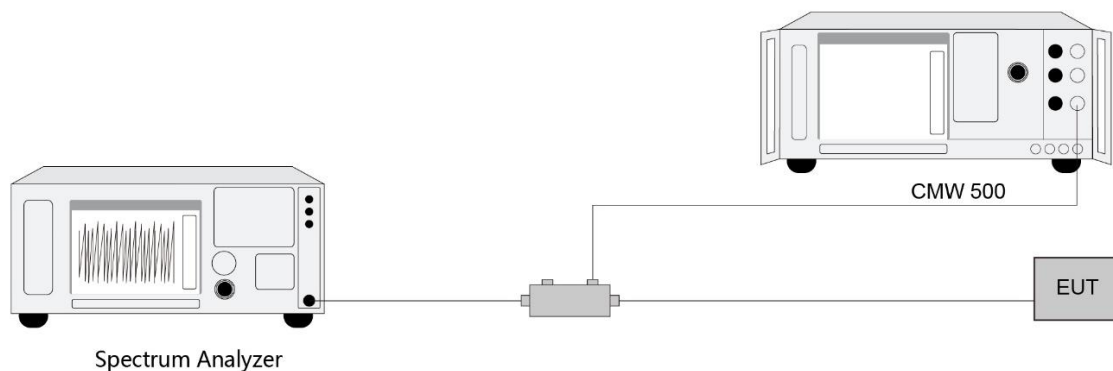

5.2.5. Test Result

Refer to Appendix A.1.

5.3. Frequency Stability Measurement

5.3.1. Test Limit

The frequency stability shall be measured by variation of ambient temperature and variation of primary supply voltage to ensure that the fundamental emission stays within the authorized frequency block. The frequency stability of the transmitter shall be maintained within $\pm 0.00025\%$ ($\pm 2.5\text{ppm}$) of the center frequency.

5.3.2. Test Procedure

ANSI C63.26-2015 - Section 5.6

5.3.3. Test Setting

Frequency Stability Under Temperature Variations:

The equipment under test was connected to an external AC or DC power supply and input rated voltage. RF output was connected to a frequency counter or spectrum analyzer via feed through attenuators. The EUT was placed inside the temperature chamber. Set the spectrum analyzer RBW low enough to obtain the desired frequency resolution and measure EUT 20°C operating frequency as reference frequency. Turn EUT off and set the chamber temperature to highest. After the temperature stabilized for approximately 30 minutes recorded the frequency. Repeat step measure with 10°C decreased per stage until the lowest temperature reached.

Frequency Stability Under Voltage Variations:

Set chamber temperature to 20°C. Use a variable AC power supply / DC power source to power the EUT and set the voltage to rated voltage. Set the spectrum analyzer RBW low enough to obtain the desired frequency resolution and recorded the frequency.

Reduce the input voltage to specify extreme voltage variation ($\pm 15\%$) and endpoint, record the maximum frequency change.

5.3.4. Test Setup

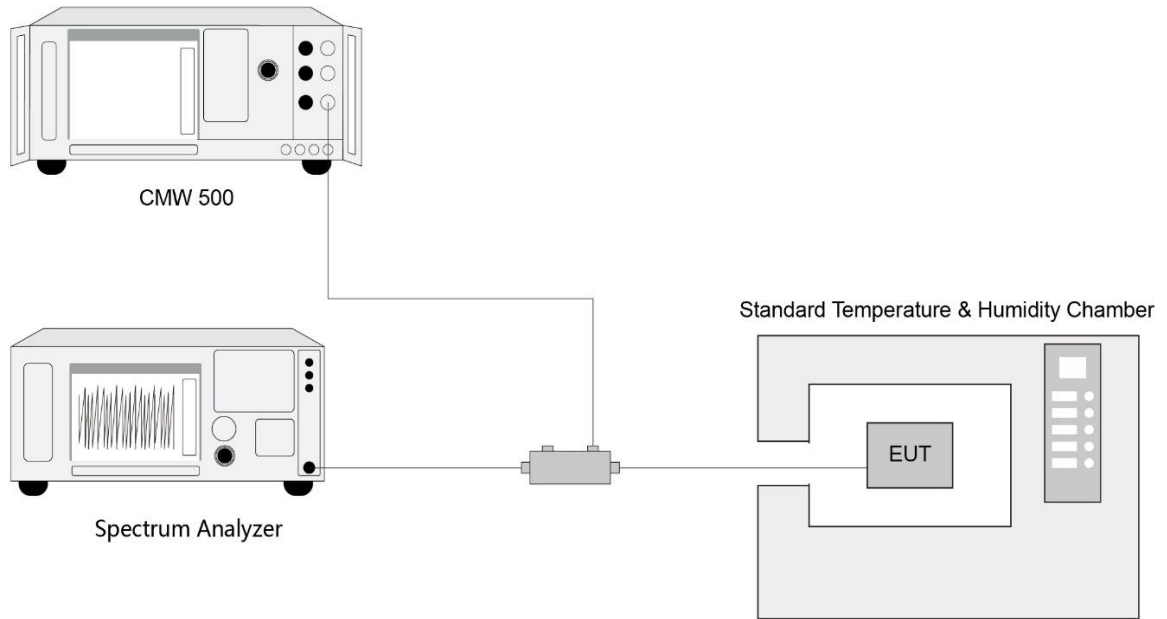

5.3.5. Test Result

Refer to Appendix A.2.

5.4. Equivalent Isotropically Radiated Power Measurement

5.4.1. Test Limit

Band 5/26:

The ERP of mobile transmitters and auxiliary test transmitters must not exceed 7 watts.

Band 12, 13, 17

Control stations and mobile stations transmitting in the 746-757 MHz, 776-788 MHz, and 805-806 MHz bands are limited to 30 watts ERP.

Control and mobile stations in the 698-746 MHz band are limited to 30 watts ERP.

Band 71

Fixed and mobile stations in the 600 MHz uplink band are limited to 3 watts ERP.

Band 2/25, 7, 38/41:

Mobile and portable stations are limited to 2 watts EIRP and the equipment must employ a means for limiting power to the minimum necessary for successful communications.

Band 4/66:

Fixed, mobile stations operating in the 1710-1755 MHz band and mobile in the 1695-1710 MHz and 1755-1780 MHz bands are limited to 1 watt EIRP.

5.4.2. Test Procedure

ANSI C63.26-2015 - Section 5.2

5.4.3. Test Setting

Average power measurements were performed only when the EUT was transmitting at its maximum power control level using a broadband power meter with a pulse sensor. The power meter implemented triggering and gating capabilities which were set up such that power measurements were recorded only during the ON time of the transmitter.

The relevant equation for determining the maximum ERP or EIRP from the measured RF output power is given in Equation (1) as follows:

$$\text{ERP or EIRP} = P_{\text{Meas}} + G_{\text{T}}$$

where

ERP or EIRP effective radiated power or equivalent isotropically radiated power, respectively (expressed in the same units as P_{Meas} , e.g., dBm or dBW)

P_{Meas} measured transmitter output power or PSD, in dBm or dBW

G_T gain of the transmitting antenna, in dBd (ERP) or dBi (EIRP)

$$\text{ERP} = \text{EIRP} - 2.15$$

5.4.4. Test Setup

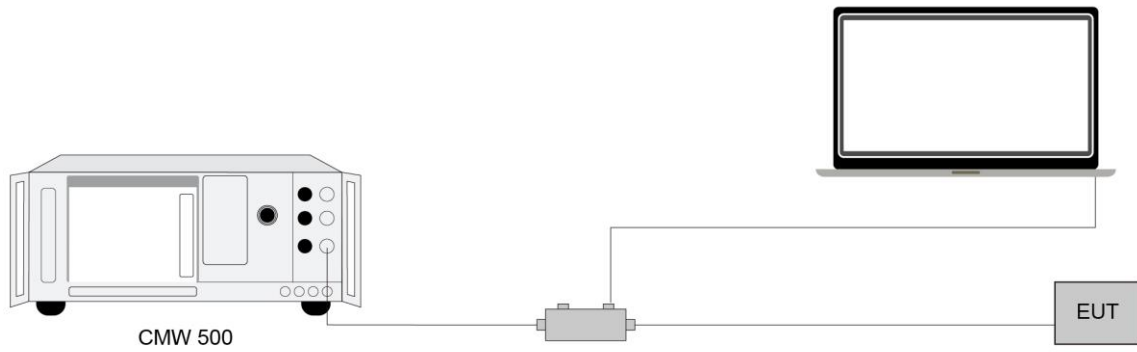

5.4.5. Test Result

Refer to Appendix A.3.

5.5. Band Edge Measurement

5.5.1. Test Limit

22.917(a), 24.238 (a), 27.53 (g) (h)

For operations in the 824 ~ 849 MHz, 1850 ~ 1910 MHz, 1930 ~ 1990 MHz, 600MHz & 698 ~ 746 MHz and 1710 ~ 1755 MHz, the FCC limit is $43 + 10\log_{10}(P_{\text{[Watts]}})$ dB below the transmitter power $P(\text{Watts})$ in a 1 MHz bandwidth. However, in the 1MHz bands immediately outside and adjacent to the licensee's frequency block, a resolution bandwidth of at least one percent of the emission bandwidth of the fundamental emission of the transmitter may be employed.

27.53 (c)

For operations in the 776-788 MHz band, the FCC limit is $43 + 10\log_{10}(P_{\text{[Watts]}})$ dB below the transmitter power $P(\text{Watts})$ in a 100 kHz bandwidth. However, in the 100 kHz bands immediately outside and adjacent to the frequency block, a resolution bandwidth of at least 30 kHz may be employed. In addition, the power of any unwanted emissions in any 6.25 kHz bandwidth for all frequencies between 763-775 MHz and 793-806 Hz shall be attenuated below the transmitter power, P (dBW), by at least $65 + 10 \log_{10} (P_{\text{[Watts]}})$, dB, for mobile and portable equipment.

27.53(m)(4)

For mobile digital stations, the attenuation factor shall be not less than $40 + 10 \log (P)$ dB on all frequencies between the channel edge and 5 megahertz from the channel edge, $43 + 10 \log (P)$ dB on all frequencies between 5 megahertz and X megahertz from the channel edge, and $55 + 10 \log (P)$ dB on all frequencies more than X megahertz from the channel edge, where X is the greater of 6 megahertz or the actual emission bandwidth as defined in paragraph (m)(6) of this section. In addition, the attenuation factor shall not be less than $43 + 10 \log (P)$ dB on all frequencies between 2490.5 MHz and 2496 MHz and $55 + 10 \log (P)$ dB at or below 2490.5 MHz. Mobile Satellite Service licensees operating on frequencies below 2495 MHz may also submit a documented interference complaint against BRS licensees operating on channel BRS Channel 1 on the same terms and conditions as adjacent channel BRS or EBS licensees.

5.5.2. Test Procedure

ANSI C63.26-2015 - Section 5.7

5.5.3. Test Setting

1. Set the analyzer frequency to low or high channel
2. $RBW \geq$ The nominal RBW shall be in the range of 1% of the anticipated OBW (in the 1MHz band immediately outside and adjacent to the band edge). For improvement of the accuracy in the measurement of the average power of a noise-like emission, a RBW narrower than the specified reference bandwidth can be used (generally limited to no less than 1% of the OBW), provided that a subsequent integration is performed over the full required measurement bandwidth. This integration should be performed using the spectrum analyzer's band power functions.
3. $VBW \geq 3*RBW$
4. Sweep time = auto
5. Detector = power averaging (rms)
6. Set sweep trigger to "free run."
7. User gate triggered such that the analyzer only sweeps when the device is transmitting at full power
8. Trace average at least 100 traces in power averaging (rms) mode if sweep is set to auto-couple. To accurately determine the average power over the on and off time of the transmitter, it can be necessary to increase the number of traces to be averaged above 100, or if using a manually configured sweep time, increase the sweep time.

5.5.4. Test Setup

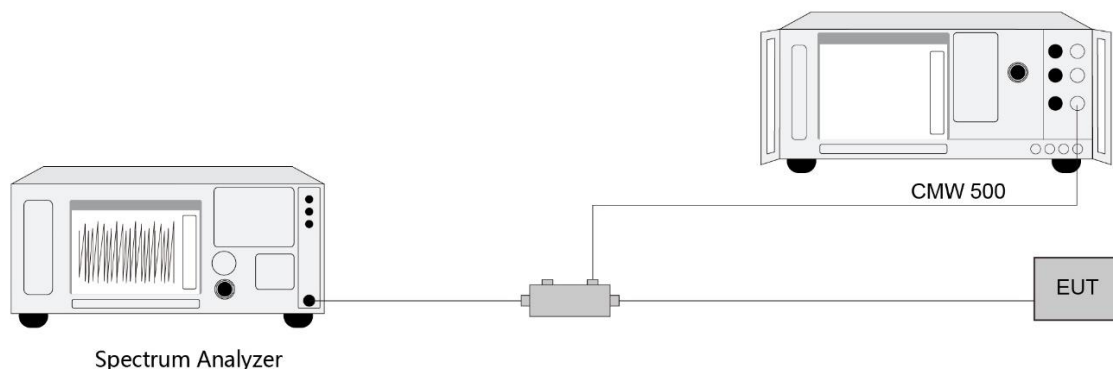

5.5.5. Test Result

Refer to Appendix A.4.

5.6. Peak to Average Ratio Measurement

5.6.1. Test Limit

A peak to average ratio measurement is performed at the conducted port of the EUT. The spectrum analyzers Complementary Cumulative Distribution Function (CCDF) measurement profile is used to determine the largest deviation between the average and the peak power of the EUT in a given bandwidth. The CCDF curve shows how much time the peak waveform spends at or above a given average power level. The percent of time the signal spends at or above the level defines the probability for that particular power level.

5.6.2. Test Procedure

ANSI C63.26-2015 - Section 5.2.3.4 (CCDF).

5.6.3. Test Setting

1. Set the resolution / measurement bandwidth \geq signal's occupied bandwidth
2. Set the number of counts to a value that stabilizes the measured CCDF curve
3. Record the maximum PARR level associated with a probability of 0.1%

5.6.4. Test Setup

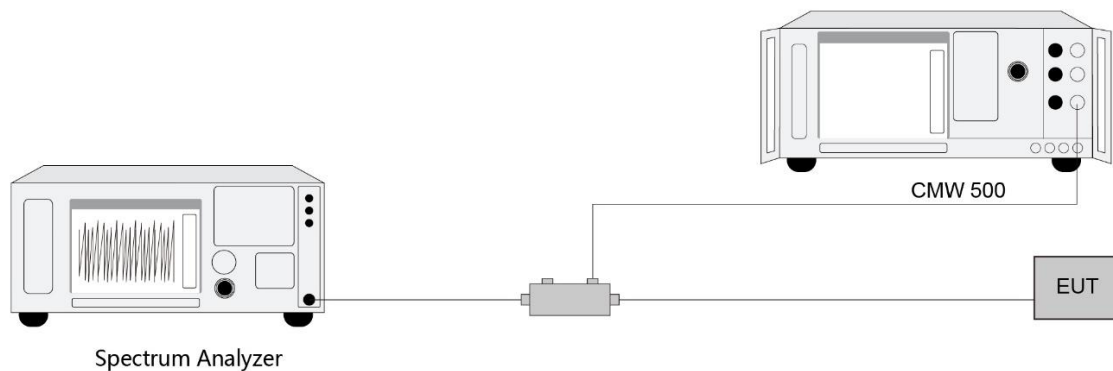

5.6.5. Test Result

Refer to Appendix A.5

5.7. Conducted Spurious Emissions Measurement

5.7.1. Test Limit

The level of the carrier and the various conducted spurious and harmonic frequencies is measured by means of a calibrated spectrum analyzer. The spectrum is scanned from the lowest frequency generated in the equipment up to a frequency including its 10th harmonic. All out of band emissions are measured with a spectrum analyzer connected to the antenna terminal of the EUT while the EUT is operating at its maximum duty cycle, at maximum power, and at the appropriate frequencies. All data rates were investigated to determine the worst-case configuration. All modes of operation were investigated and the worst-case configuration results are reported in this section.

The power of any emission outside of the authorized operating frequency ranges must be attenuated below the transmitting power (P) by a factor of at least $43 + 10 \log(P)$ dB.

For Band 7, 38/41 the power of any emission outside of the authorized operating frequency ranges must be attenuated below the transmitting power (P) by a factor of at least $55 + 10 \log(P)$ dB.

5.7.2. Test Procedure

ANSI C63.26-2015 - Section 5.7

5.7.3. Test Setting

1. Set the analyzer frequency to low, mid, high channel.
2. RBW = 1MHz
3. VBW $\geq 3 \cdot$ RBW
4. Sweep time = auto
5. Detector = power averaging (rms)
6. Set sweep trigger to "free run."
7. User gate triggered such that the analyzer only sweeps when the device is transmitting at full power.
8. Trace average at least 100 traces in power averaging (rms) mode if sweep is set to auto-couple. To accurately determine the average power over the on and off time of the transmitter, it can be necessary to increase the number of traces to be averaged above 100, or if using a manually configured sweep time, increase the sweep time.

5.7.4. Test Setup

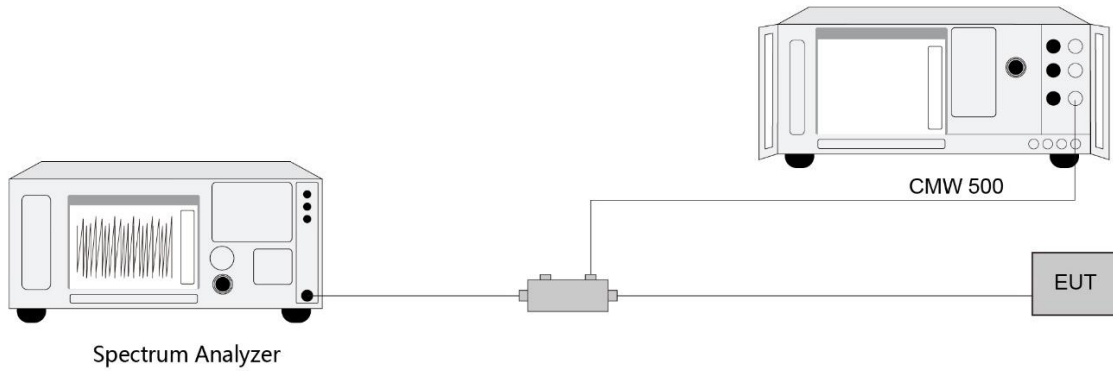

5.7.5. Test Result

Refer to Appendix A.6

5.8. Radiated Spurious Emissions Measurement

5.8.1. Test Limit

The power of any emission outside of the authorized operating frequency ranges must be attenuated below the transmitting power (P) by a factor of at least $43 + 10 \log(P)$ dB. The emission limit equal to -13dBm.

For Band 7, 38/41, the power of any emission outside of the authorized operating frequency ranges must be attenuated below the transmitting power (P) by a factor of at least $55 + 10 \log(P)$ dB. The emission limit equal to -25dBm.

For LTE Band 13, For operations in the 746-758 MHz, 775-788 MHz, and 805-806 MHz bands, emissions in the band 1559-1610 MHz shall be limited to -70 dBW/MHz (-40dBm/MHz) equivalent isotropically radiated power (EIRP) for wideband signals, and -80 dBW (-50dBm) EIRP for discrete emissions of less than 700 Hz bandwidth.

E (dB μ V/m) = EIRP (dBm) - 20 log D + 104.8; where D is the measurement distance in meters. The emission limit equal to 82.3dB μ V/m or 70.3dB μ V/m.

5.8.2. Test Procedure

ANSI C63.26-2015 - Section 5.2.7 & 5.5

5.8.3. Test Setting

1. RBW = 1MHz
2. VBW \geq 3*RBW
3. Sweep time \geq 10 \times (number of points in sweep) \times (transmission symbol period)
4. Detector = Peak
5. Trace mode = max hold
6. The trace was allowed to stabilize

5.8.4. Test Setup

Below 1GHz Test Setup:

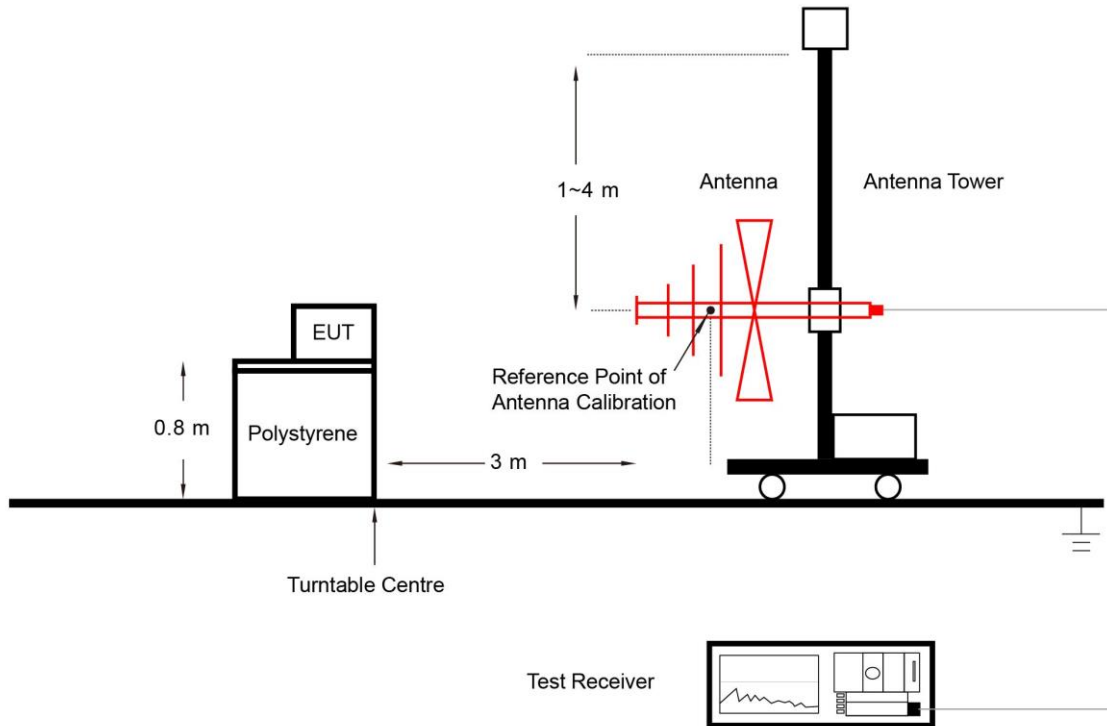

Above 1GHz Test Setup:

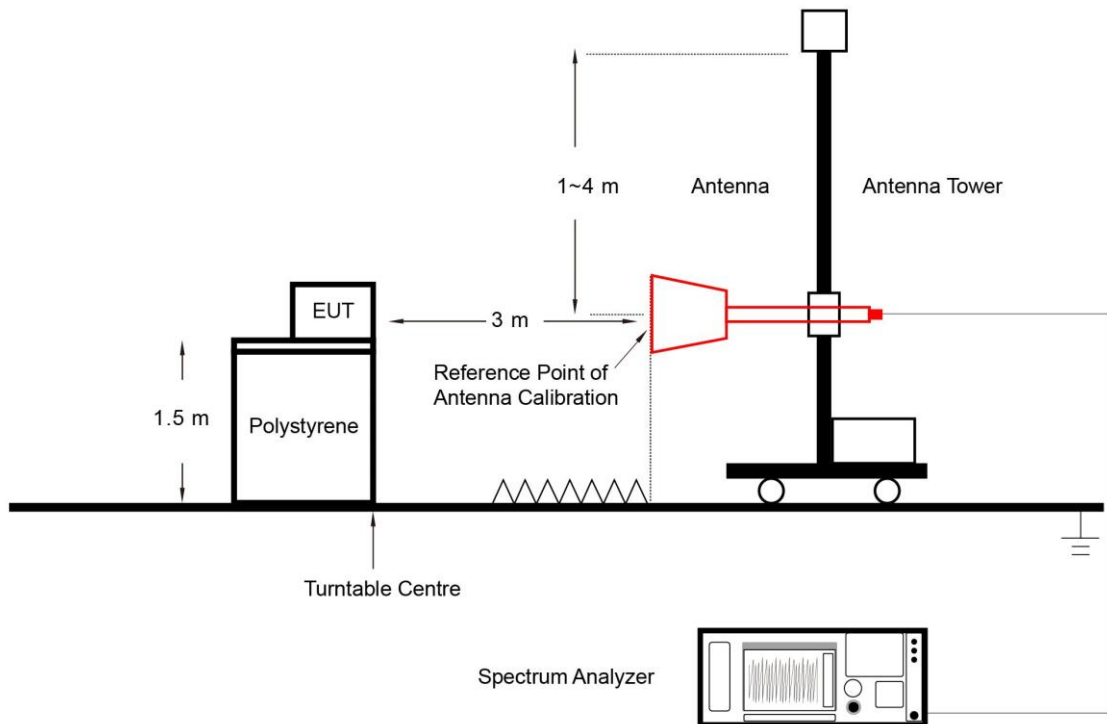

5.8.5. Test Result

Refer to Appendix A.7.

Appendix A - Test Result

A.1 Occupied Bandwidth Test Result

Test Site	SIP-SR1	Test Engineer	Allen Zou
Test Date	2022/05/11	Test Band	Band 2/25

Frequency (MHz)	Bandwidth (MHz)	99% Bandwidth (MHz)
QPSK		
1882.5	1.4	1.08
	3	2.69
	5	4.48
	10	8.95
	15	13.42
	20	17.87
16QAM		
1882.5	1.4	1.08
	3	2.69
	5	4.49
	10	8.95
	15	13.41
	20	17.89
64QAM		
1882.5	1.4	1.08
	3	2.69
	5	4.48
	10	8.95
	15	13.41
	20	17.87
256QAM		
1882.5	1.4	1.08
	3	2.68
	5	4.48
	10	8.94
	15	13.41
	20	17.88

99% Bandwidth - QPSK

1.4MHz Channel Bandwidth

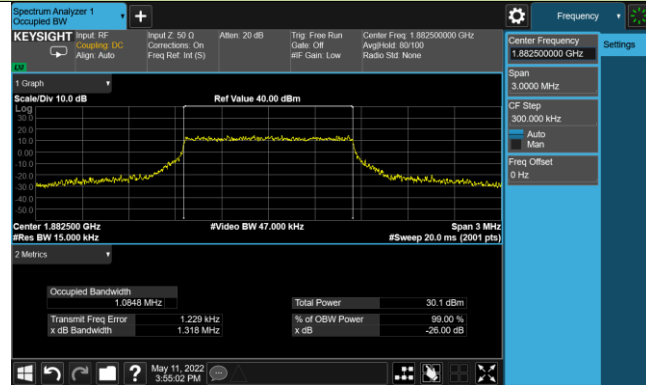

3MHz Channel Bandwidth

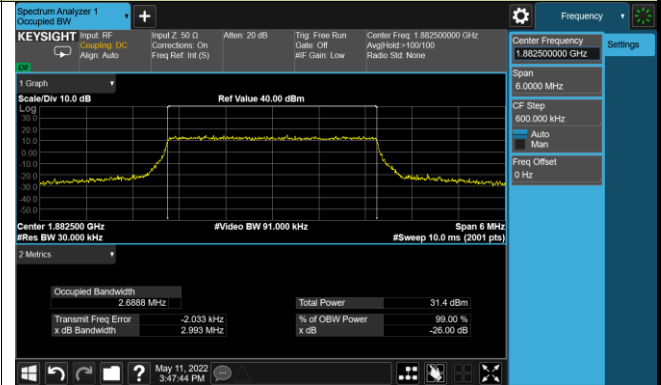

5MHz Channel Bandwidth

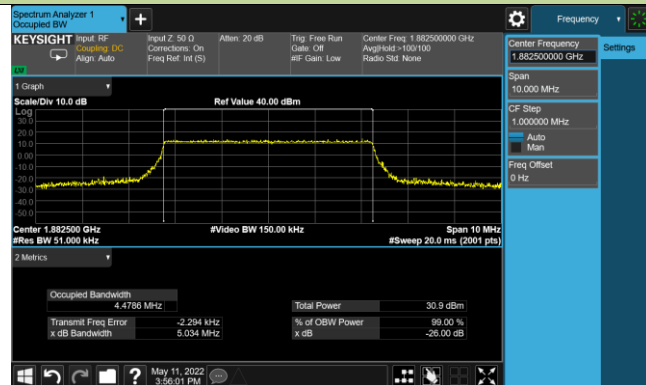

10MHz Channel Bandwidth

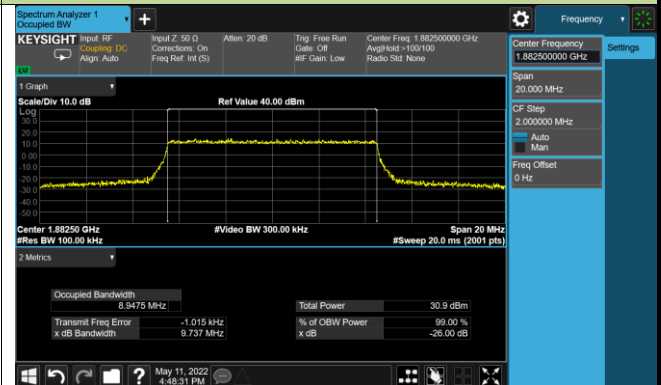

15MHz Channel Bandwidth

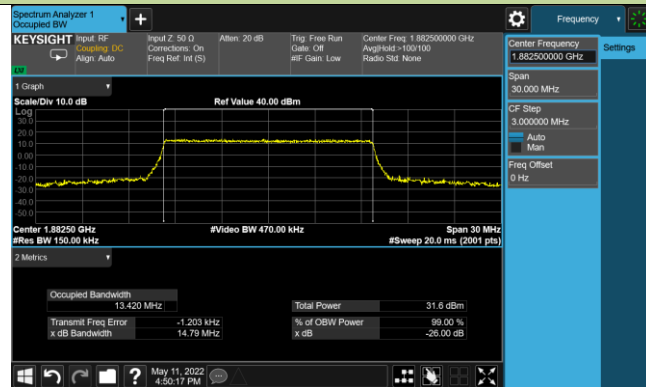

20MHz Channel Bandwidth

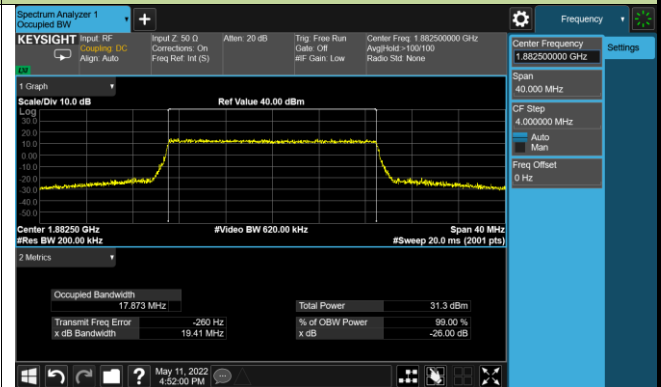

99% Bandwidth - 16QAM

1.4MHz Channel Bandwidth

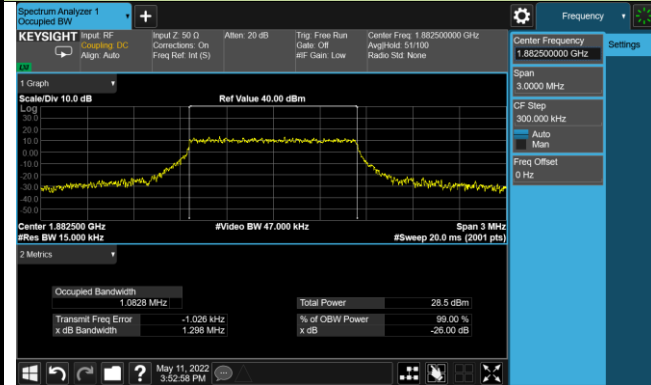

3MHz Channel Bandwidth

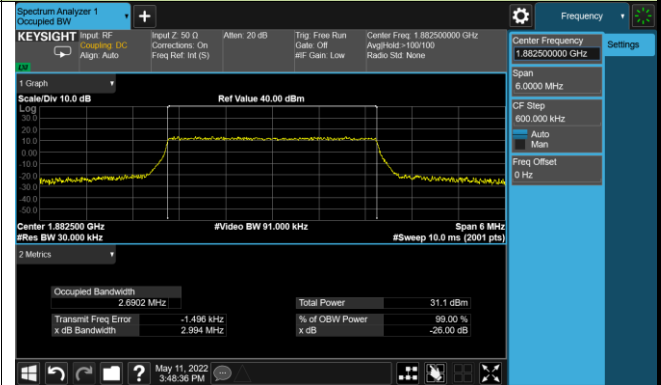

5MHz Channel Bandwidth

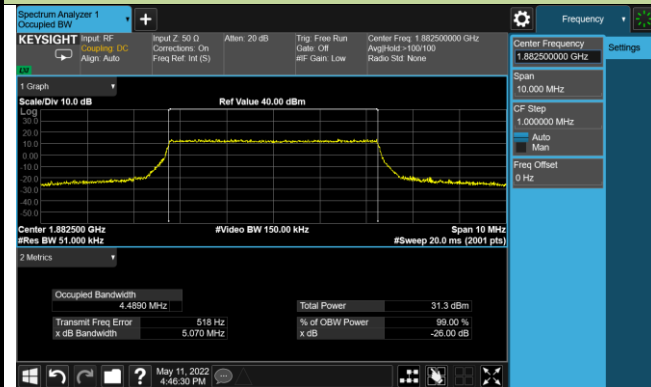

10MHz Channel Bandwidth

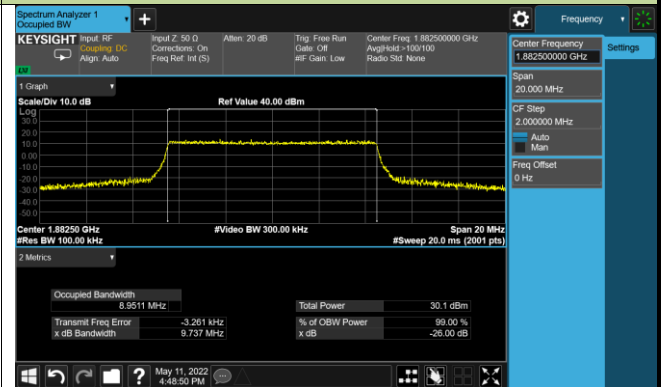

15MHz Channel Bandwidth

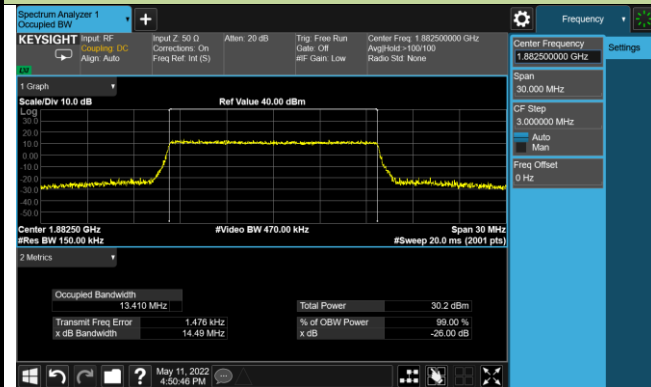

20MHz Channel Bandwidth

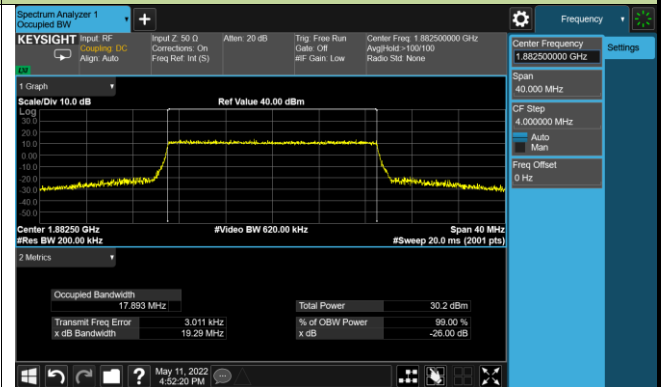

99% Bandwidth - 64QAM

1.4MHz Channel Bandwidth

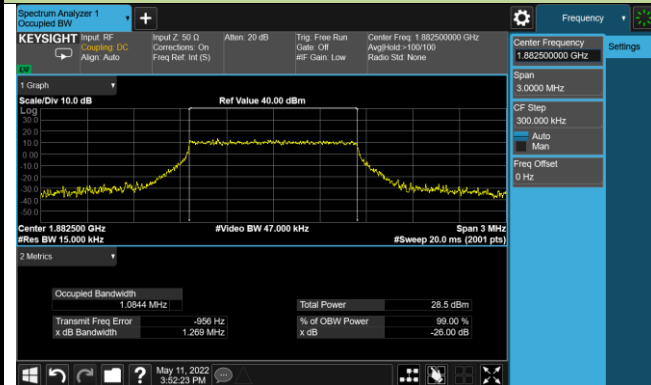

3MHz Channel Bandwidth

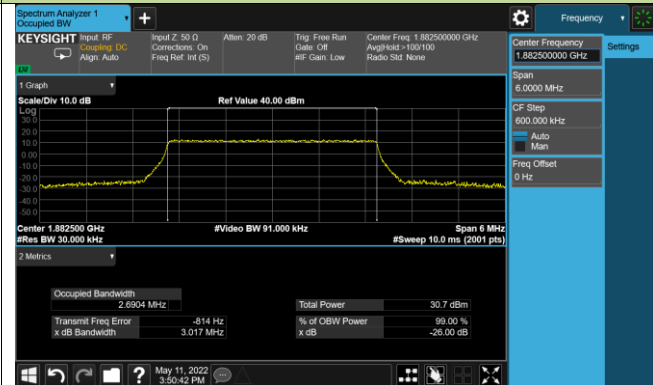

5MHz Channel Bandwidth

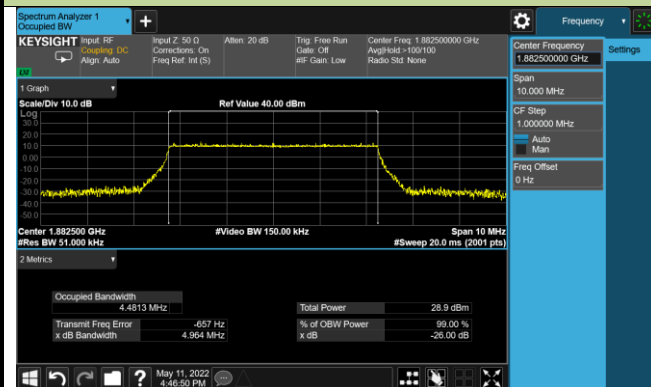

10MHz Channel Bandwidth

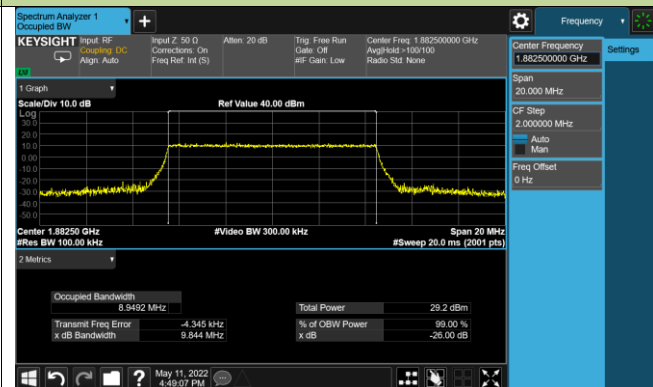

15MHz Channel Bandwidth

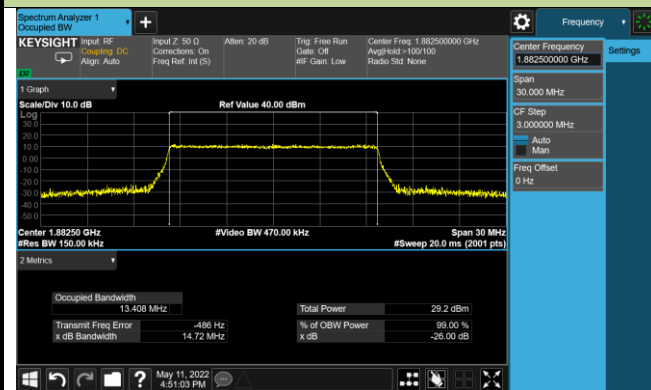

20MHz Channel Bandwidth

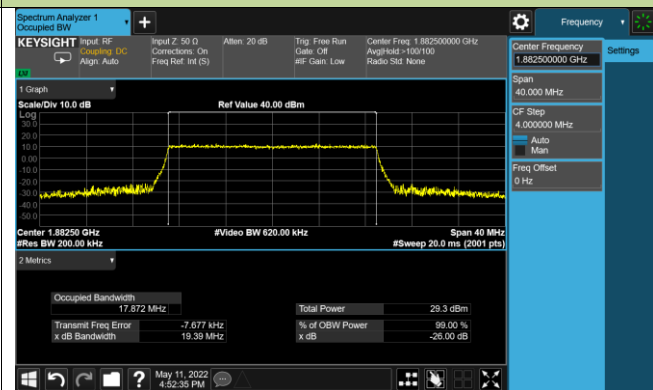

99% Bandwidth - 256QAM

1.4MHz Channel Bandwidth

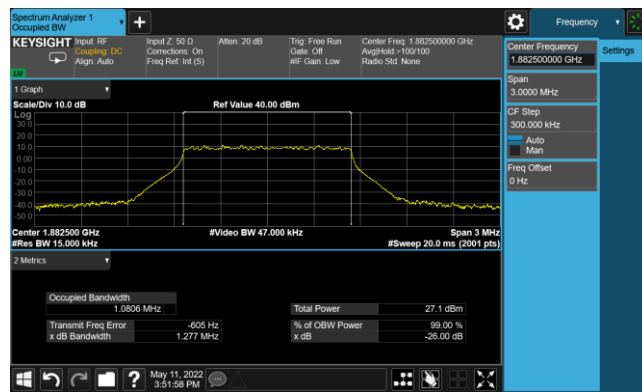

3MHz Channel Bandwidth

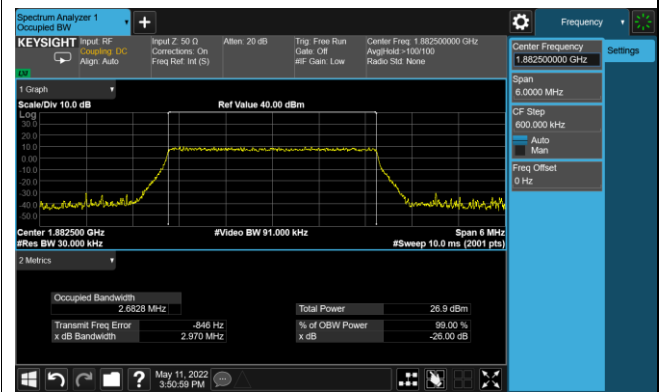

5MHz Channel Bandwidth

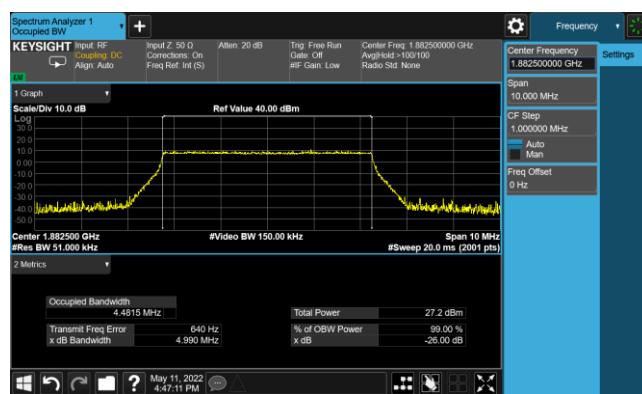

10MHz Channel Bandwidth

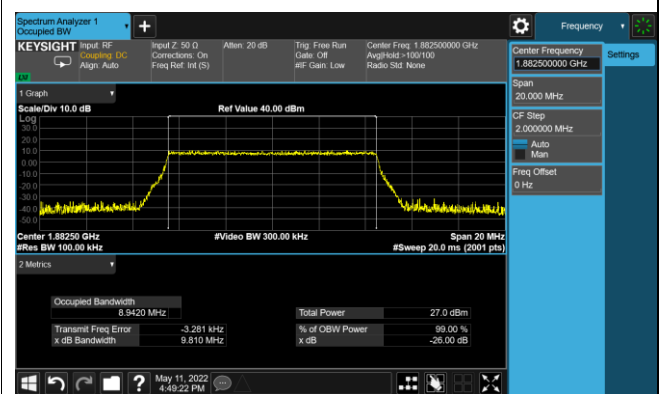

15MHz Channel Bandwidth



20MHz Channel Bandwidth

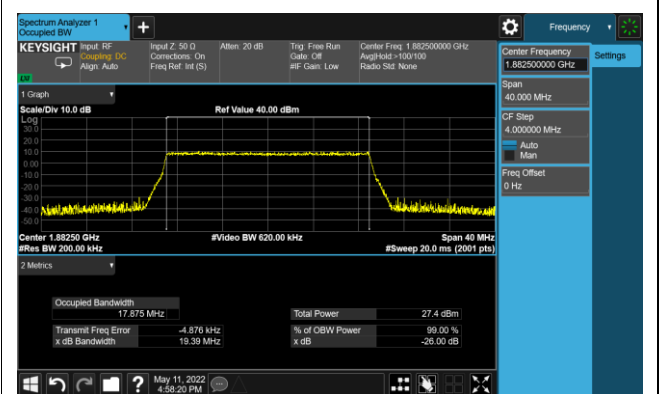

Test Site	SIP-SR1	Test Engineer	Allen Zou
Test Date	2022/05/11	Test Band	Band 4/66

Frequency (MHz)	Bandwidth (MHz)	99% Bandwidth (MHz)
QPSK		
1745.0	1.4	1.08
	3	2.69
	5	4.47
	10	8.93
	15	13.40
	20	17.85
16QAM		
1745.0	1.4	1.09
	3	2.68
	5	4.48
	10	8.94
	15	13.39
	20	17.89
64QAM		
1745.0	1.4	1.09
	3	2.68
	5	4.48
	10	8.94
	15	13.39
	20	17.85
256QAM		
1745.0	1.4	1.08
	3	2.69
	5	4.48
	10	8.93
	15	13.38
	20	17.86

99% Bandwidth - QPSK

1.4MHz Channel Bandwidth

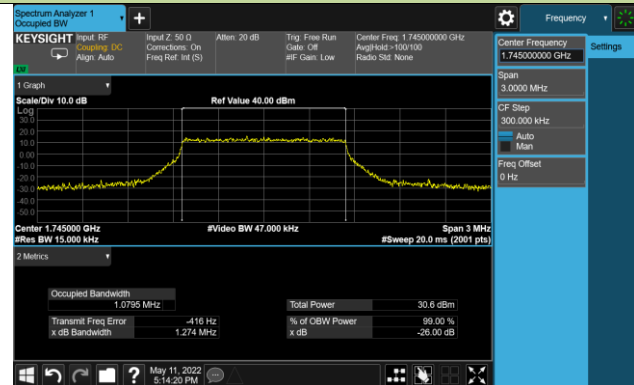

3MHz Channel Bandwidth

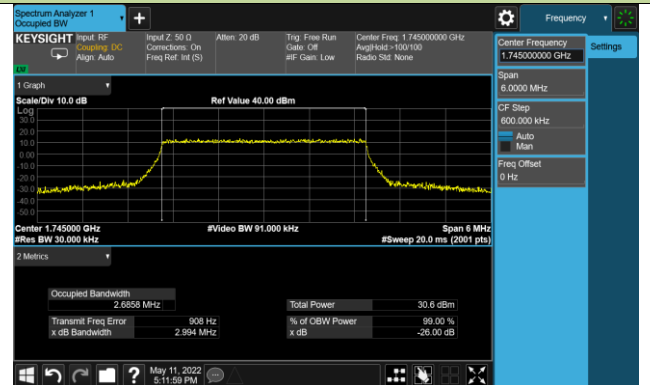

5MHz Channel Bandwidth

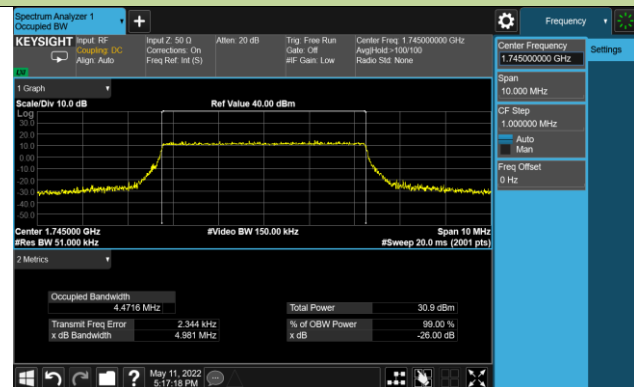

10MHz Channel Bandwidth

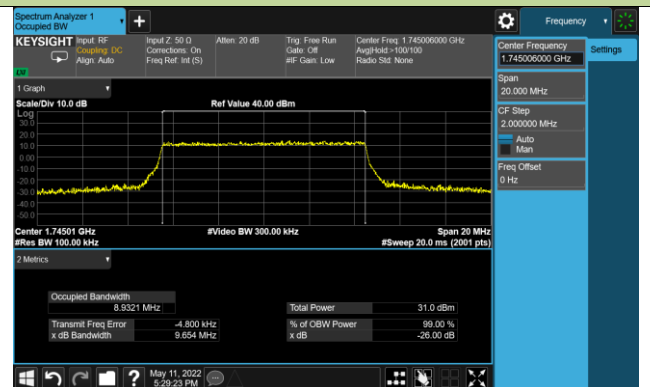

15MHz Channel Bandwidth

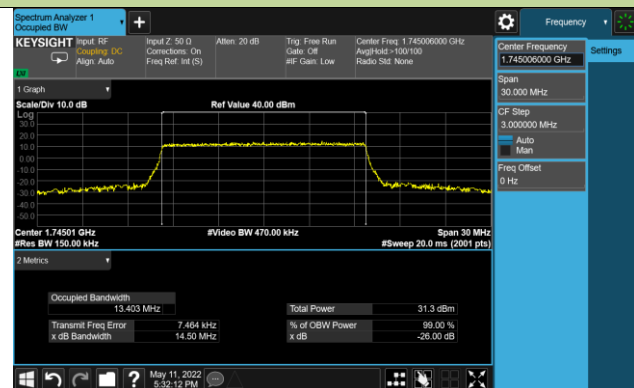

20MHz Channel Bandwidth

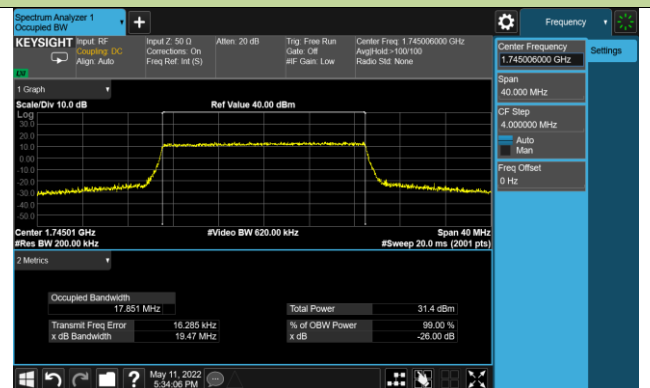

99% Bandwidth - 16QAM

1.4MHz Channel Bandwidth

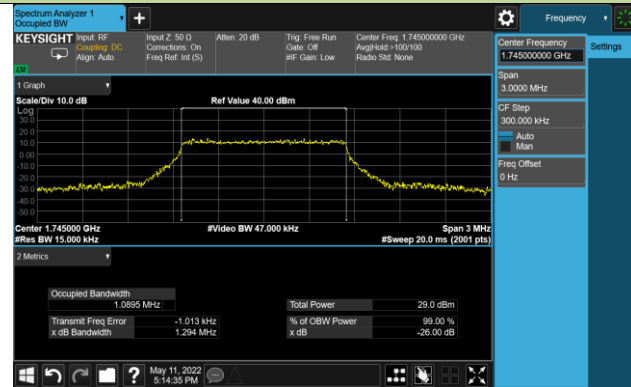

3MHz Channel Bandwidth

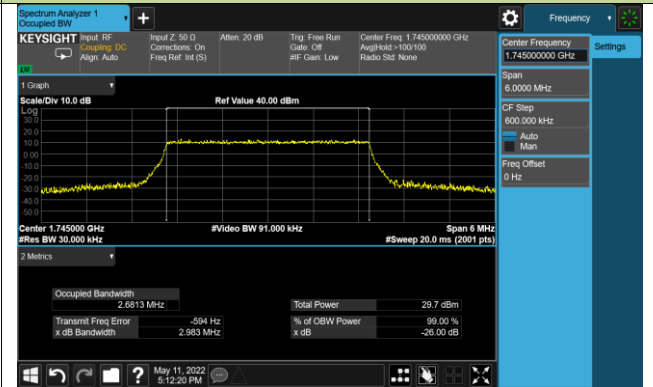

5MHz Channel Bandwidth

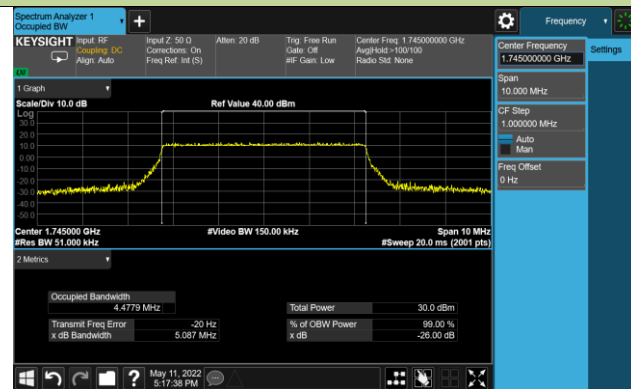

10MHz Channel Bandwidth

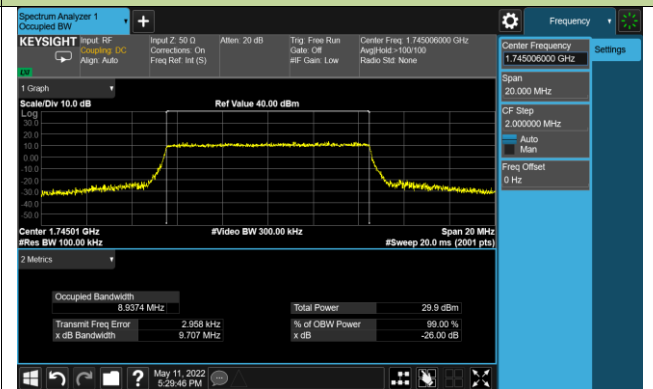

15MHz Channel Bandwidth

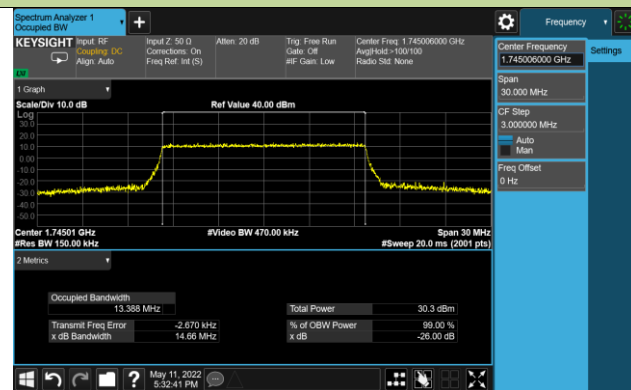

20MHz Channel Bandwidth

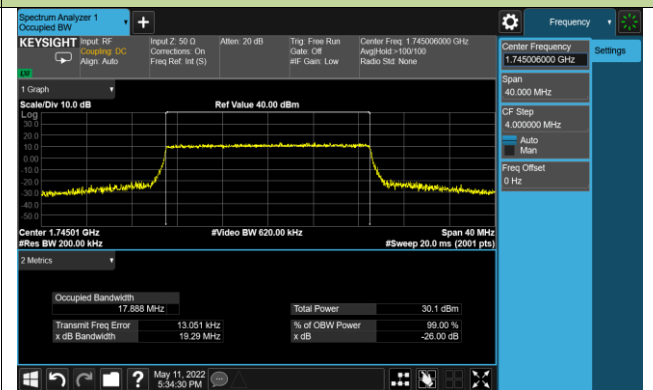

99% Bandwidth - 64QAM

1.4MHz Channel Bandwidth

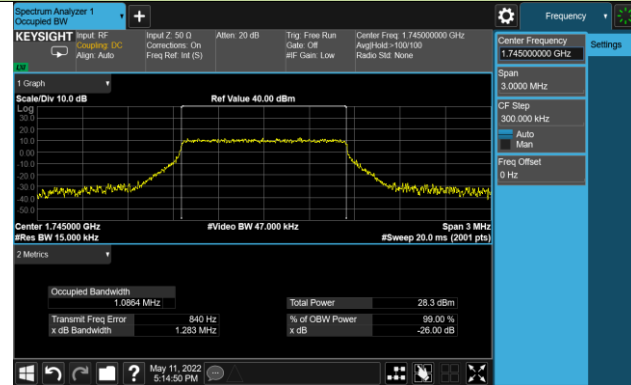

3MHz Channel Bandwidth

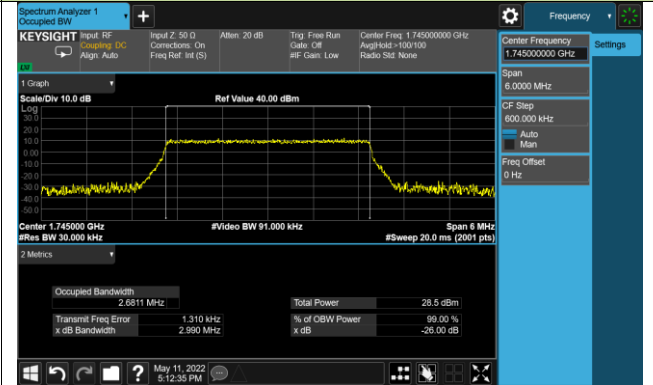

5MHz Channel Bandwidth

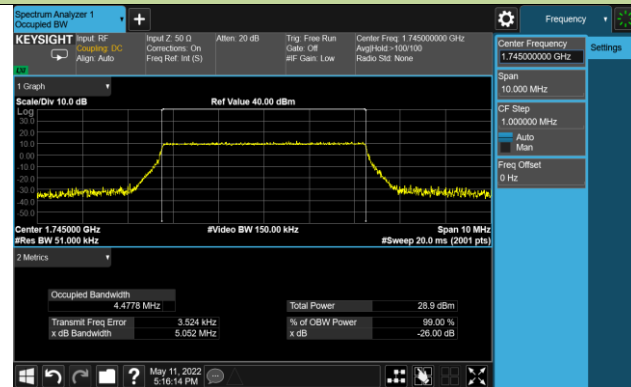

10MHz Channel Bandwidth

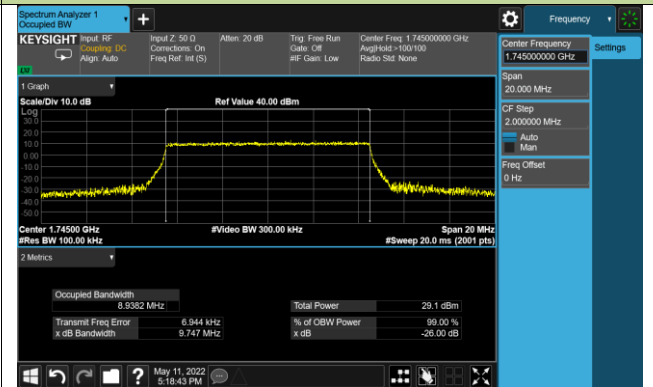

15MHz Channel Bandwidth

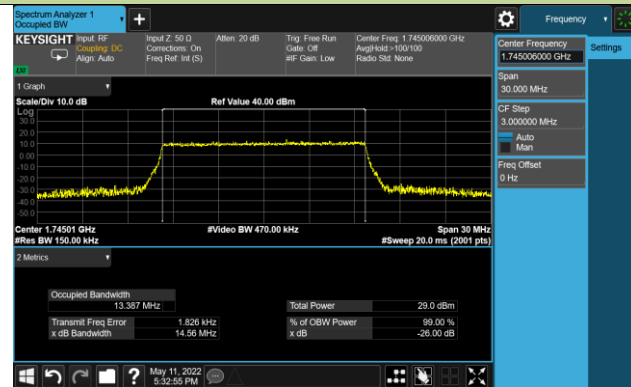

20MHz Channel Bandwidth

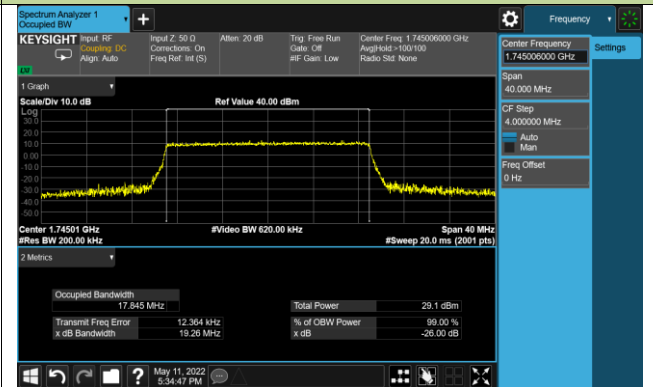

99% Bandwidth - 256QAM

1.4MHz Channel Bandwidth

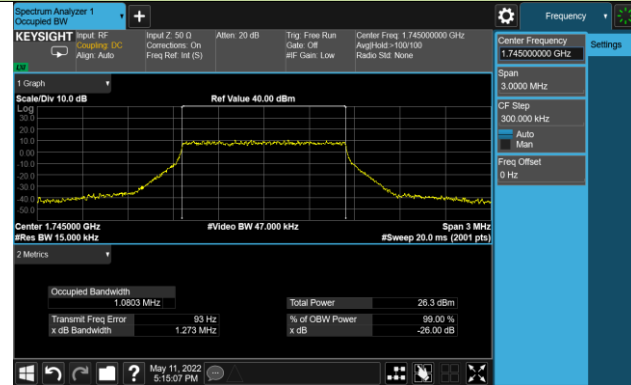

3MHz Channel Bandwidth

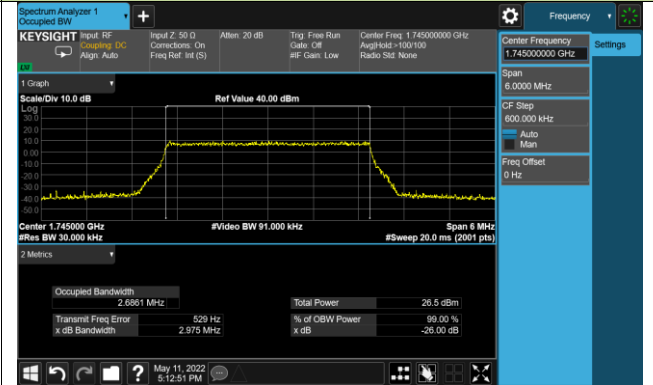

5MHz Channel Bandwidth

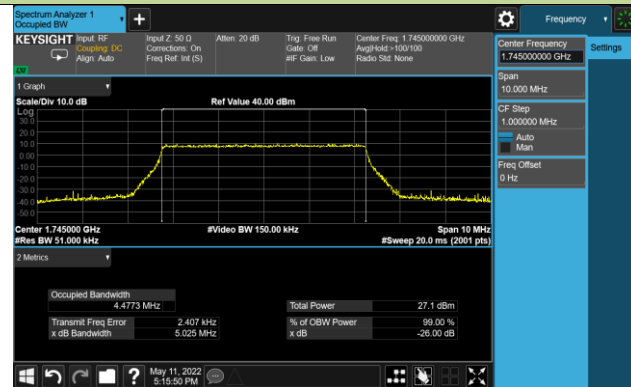

10MHz Channel Bandwidth

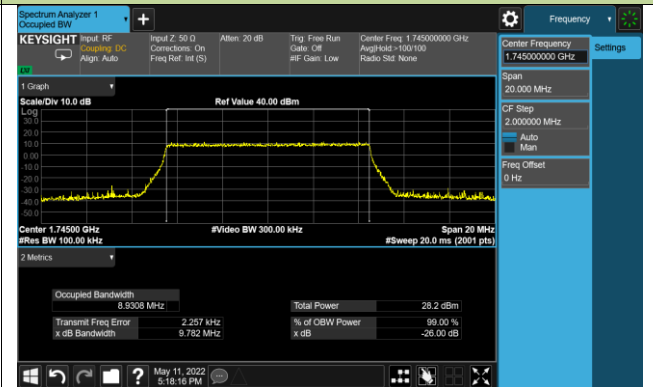

15MHz Channel Bandwidth

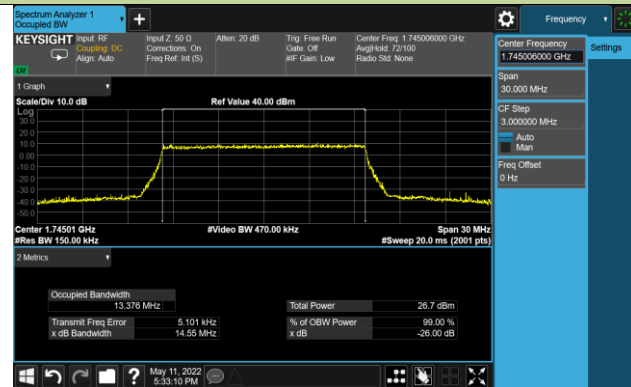

20MHz Channel Bandwidth

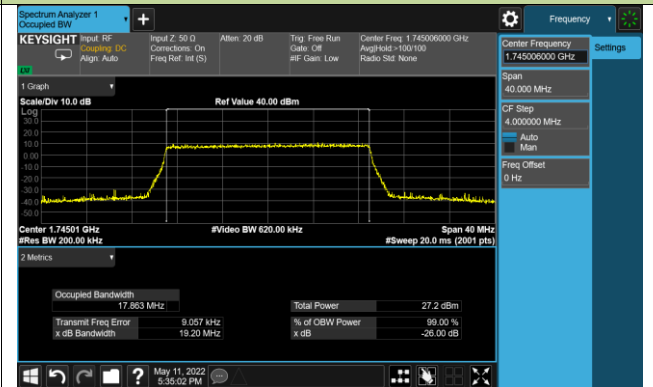

Test Site	SIP-SR1	Test Engineer	Allen Zou
Test Date	2022/05/11 ~ 2022/05/12	Test Band	Band 5/26

Frequency (MHz)	Bandwidth (MHz)	99% Bandwidth (MHz)
QPSK		
836.5	1.4	1.08
	3	2.69
	5	4.47
	10	8.93
	15	13.40
821.5	15	13.42
16QAM		
836.5	1.4	1.08
	3	2.69
	5	4.48
	10	8.94
	15	13.40
821.5	15	13.41
64QAM		
836.5	1.4	1.08
	3	2.69
	5	4.48
	10	8.94
	15	13.41
821.5	15	13.41
256QAM		
836.5	1.4	1.08
	3	2.69
	5	4.47
	10	8.94
	15	13.40
821.5	15	13.40

99% Bandwidth - QPSK

1.4MHz Channel Bandwidth

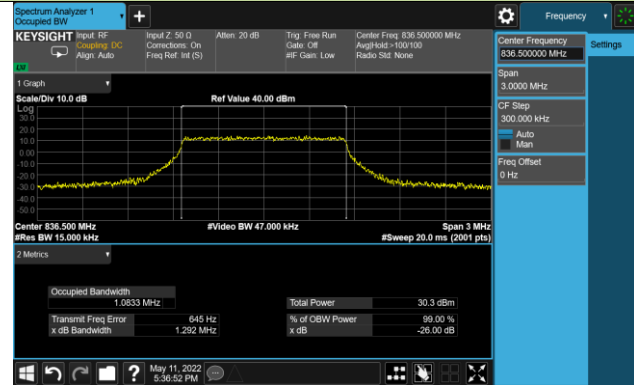

3MHz Channel Bandwidth

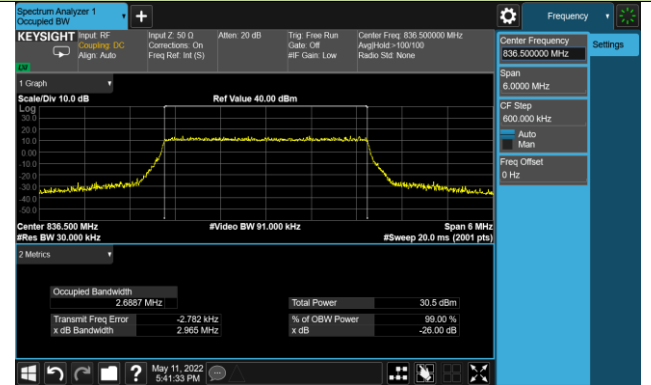

5MHz Channel Bandwidth

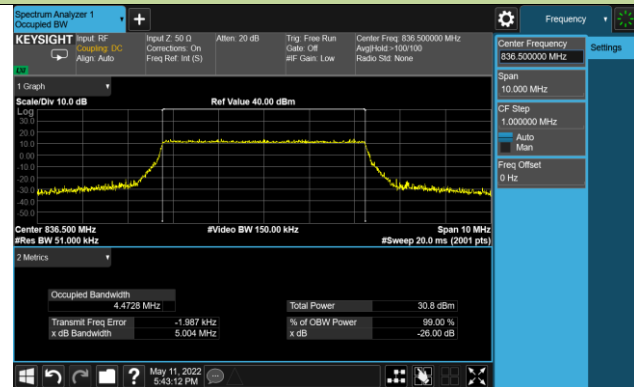

10MHz Channel Bandwidth

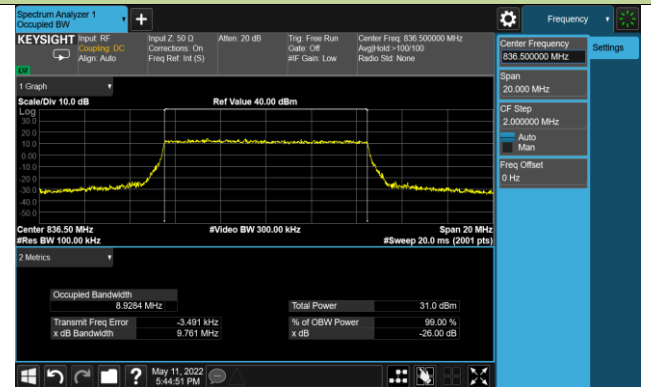

15MHz Channel Bandwidth

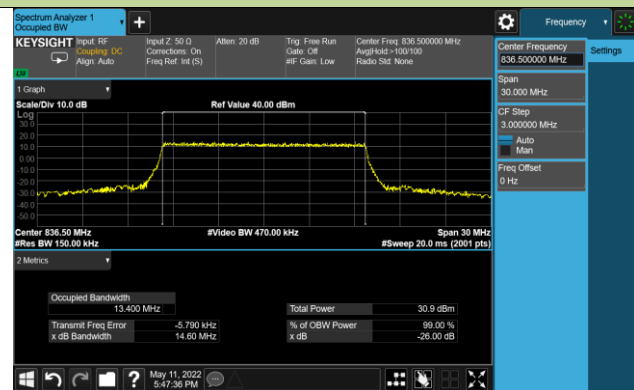

821.5MHz

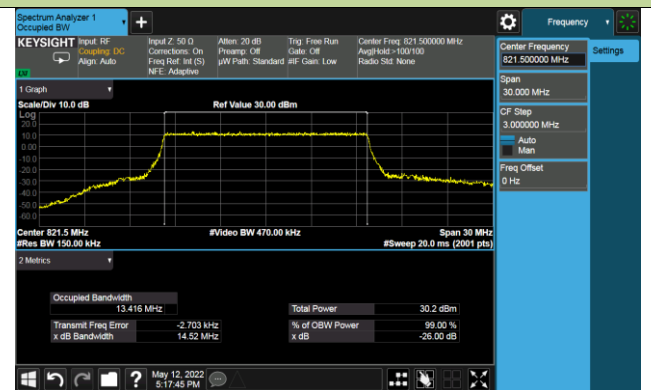

99% Bandwidth -16QAM

1.4MHz Channel Bandwidth

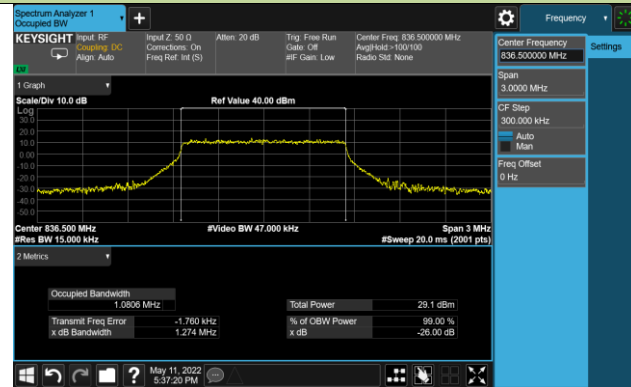

3MHz Channel Bandwidth

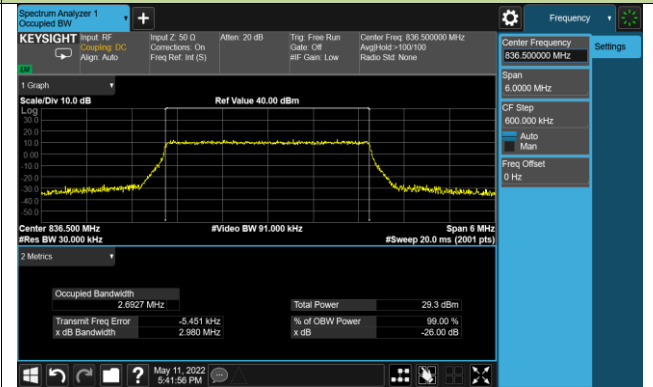

5MHz Channel Bandwidth

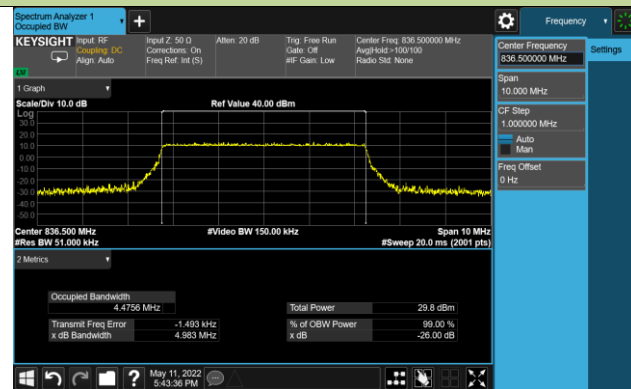

10MHz Channel Bandwidth

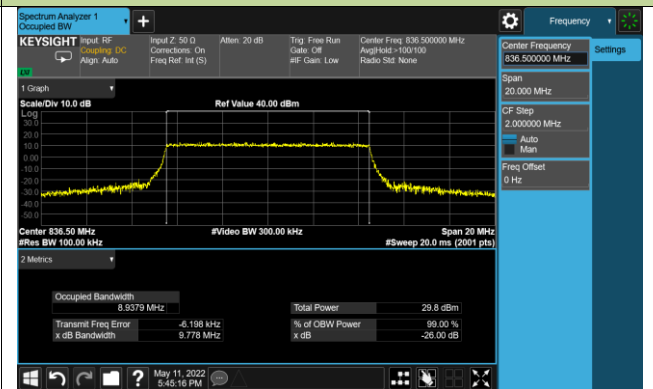

15MHz Channel Bandwidth

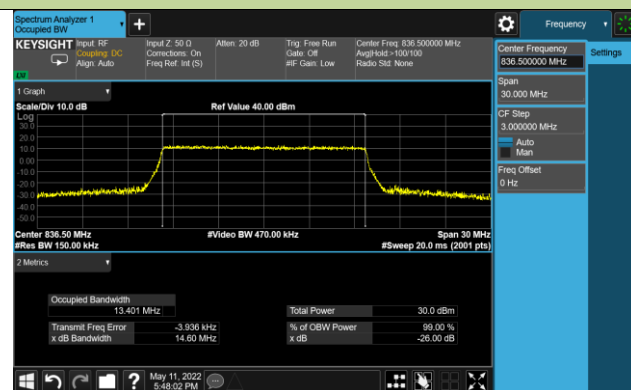

821.5MHz



99% Bandwidth - 64QAM

1.4MHz Channel Bandwidth

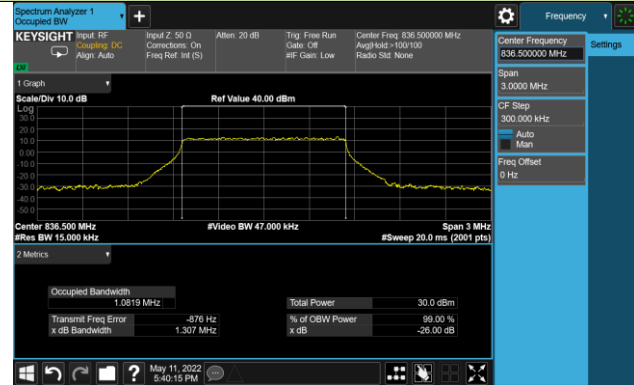

3MHz Channel Bandwidth

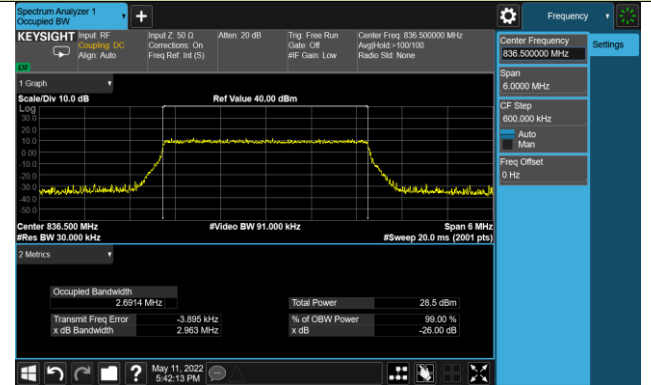

5MHz Channel Bandwidth

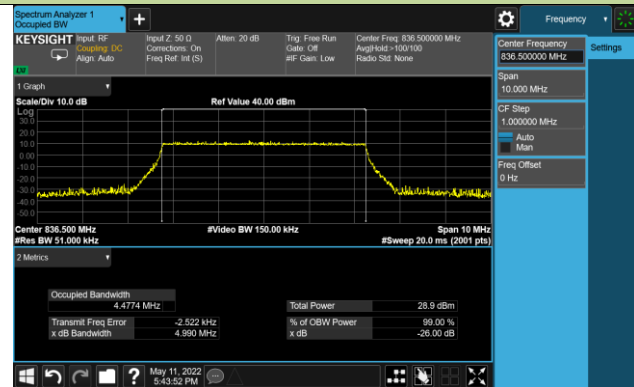

10MHz Channel Bandwidth

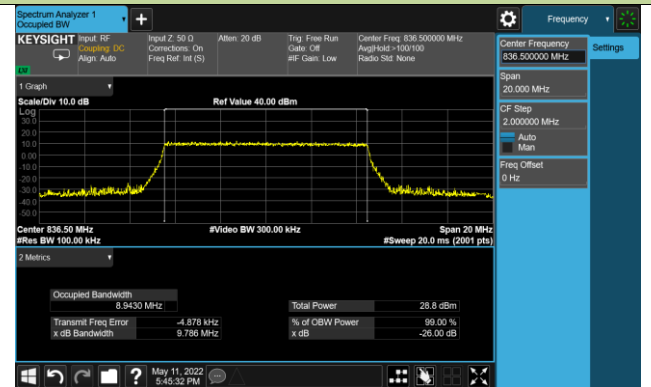

15MHz Channel Bandwidth

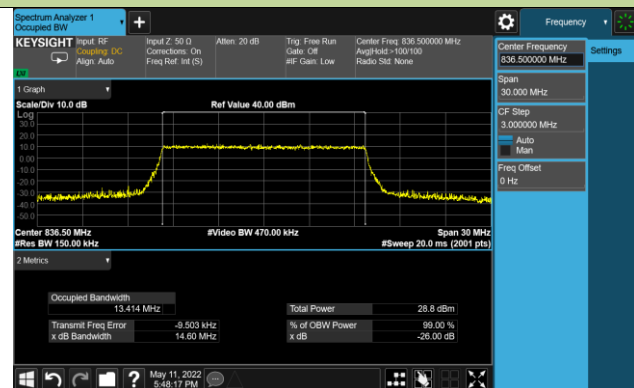

821.5MHz

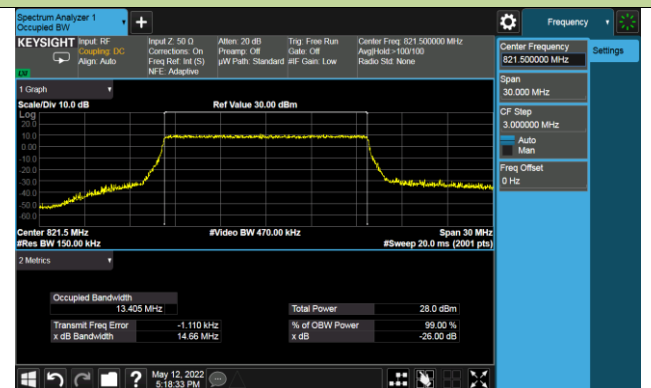

99% Bandwidth - 256QAM

1.4MHz Channel Bandwidth

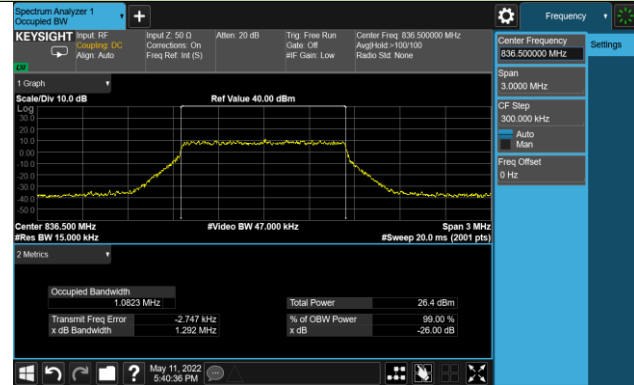

3MHz Channel Bandwidth

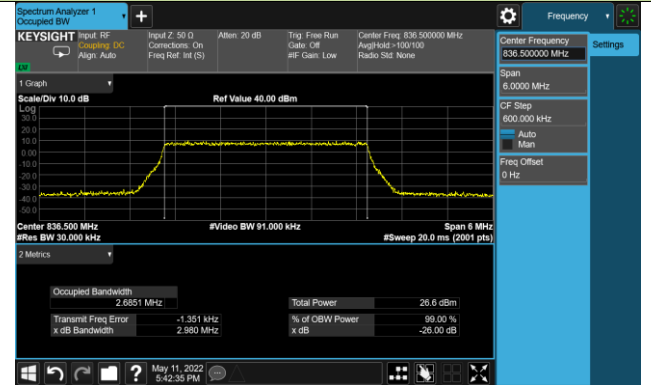

5MHz Channel Bandwidth

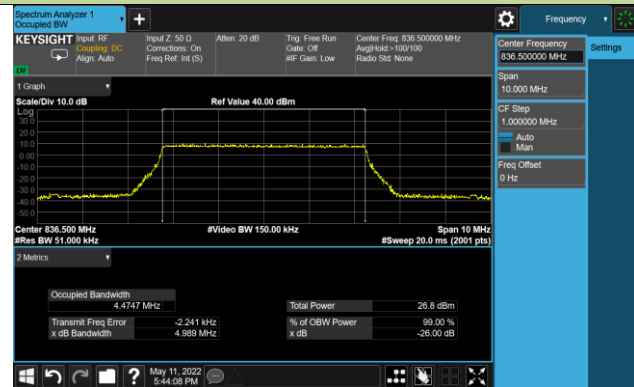

10MHz Channel Bandwidth

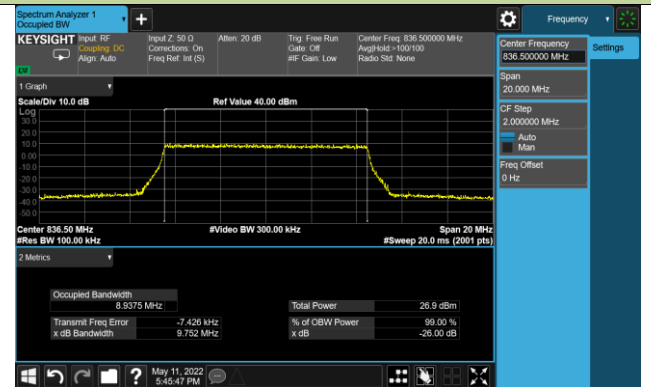

15MHz Channel Bandwidth

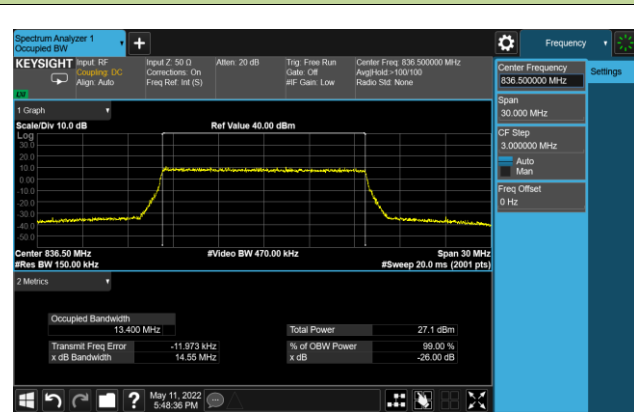

821.5MHz

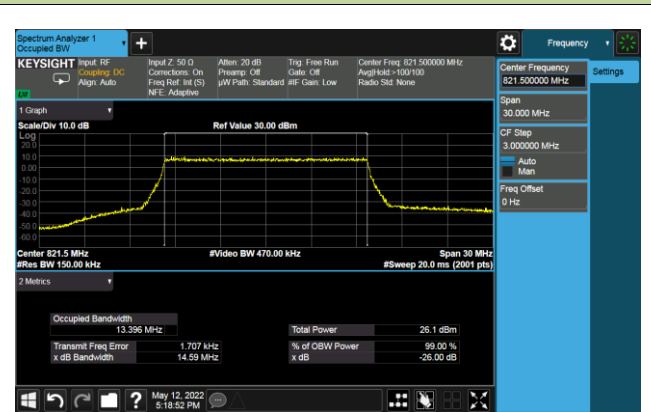

Test Site	SIP-SR1	Test Engineer	Allen Zou
Test Date	2022/05/11	Test Band	LTE Band 7

Frequency (MHz)	Bandwidth (MHz)	99% Bandwidth (MHz)
QPSK		
2535.0	5	4.48
	10	8.93
	15	13.42
	20	17.86
16QAM		
2535.0	5	4.47
	10	8.95
	15	13.41
	20	17.88
64QAM		
2535.0	5	4.48
	10	8.94
	15	13.40
	20	17.86
256QAM		
2535.0	5	4.48
	10	8.95
	15	13.41
	20	17.87

99% Bandwidth - QPSK

5MHz Channel Bandwidth

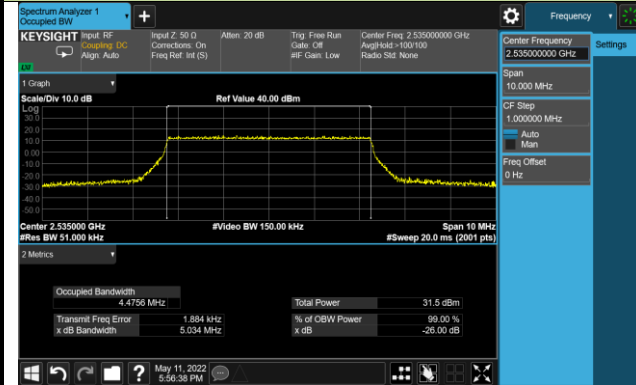

10MHz Channel Bandwidth

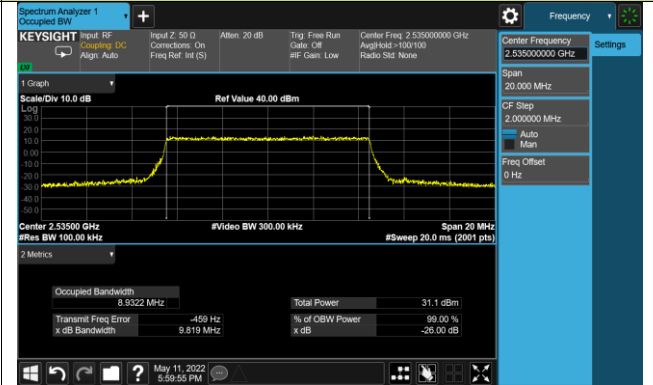

15MHz Channel Bandwidth

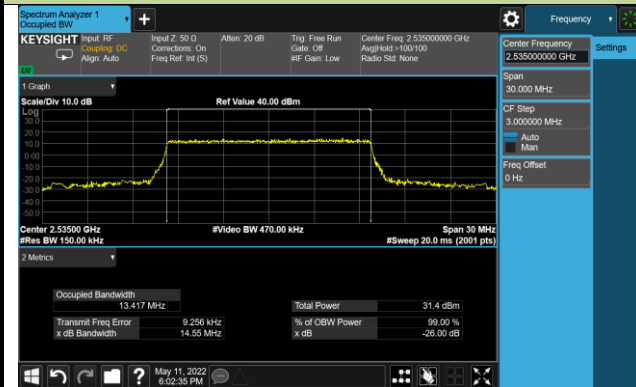

20MHz Channel Bandwidth

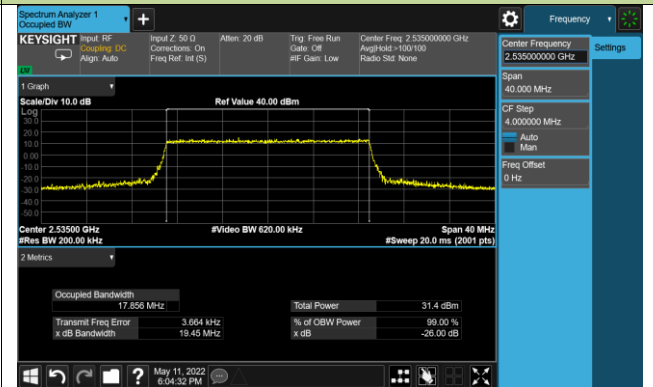

99% Bandwidth - 16QAM

5MHz Channel Bandwidth

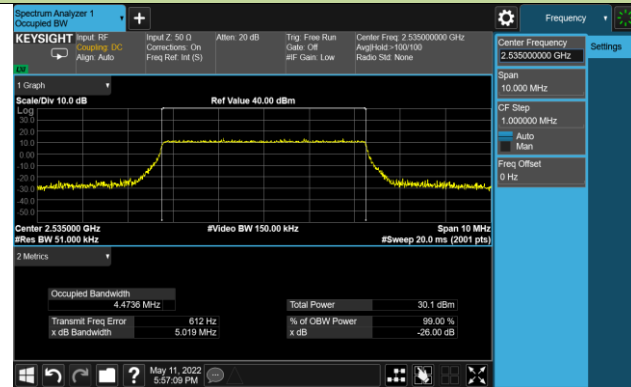

10MHz Channel Bandwidth

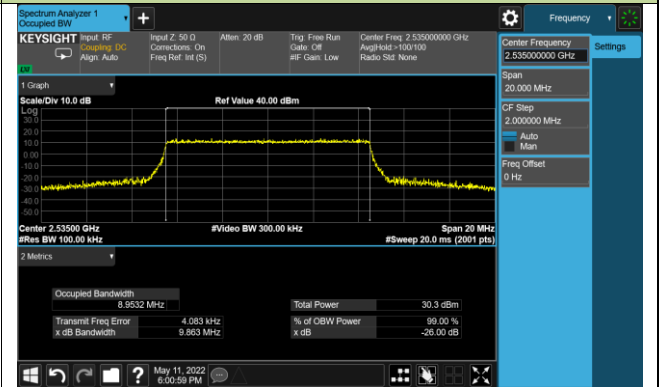

15MHz Channel Bandwidth

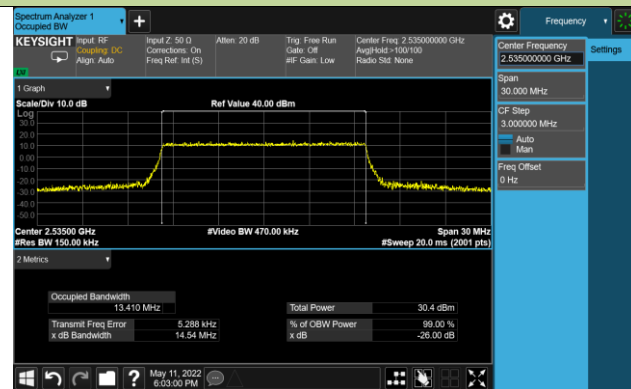

20MHz Channel Bandwidth

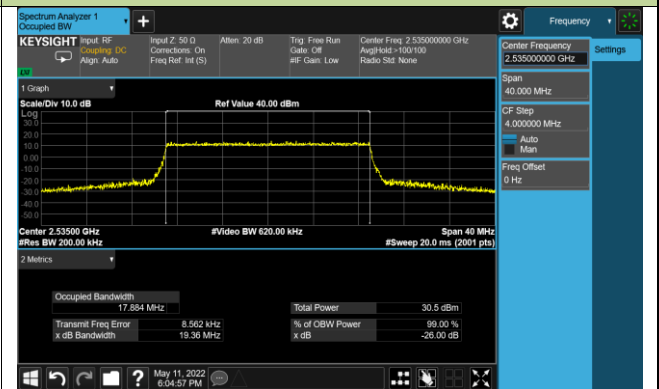

99% Bandwidth - 64QAM

5MHz Channel Bandwidth

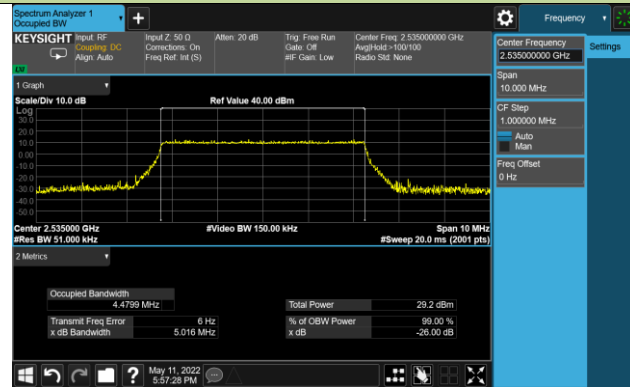

10MHz Channel Bandwidth

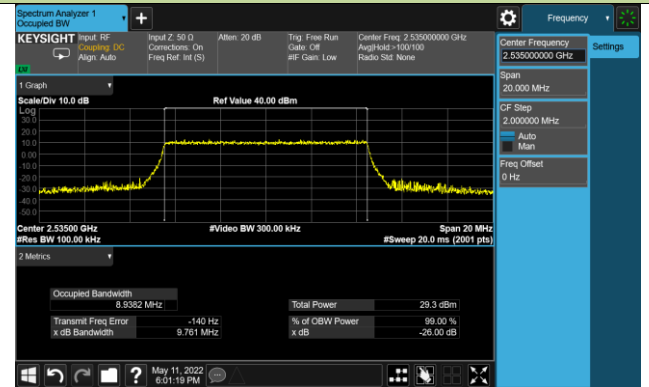

15MHz Channel Bandwidth

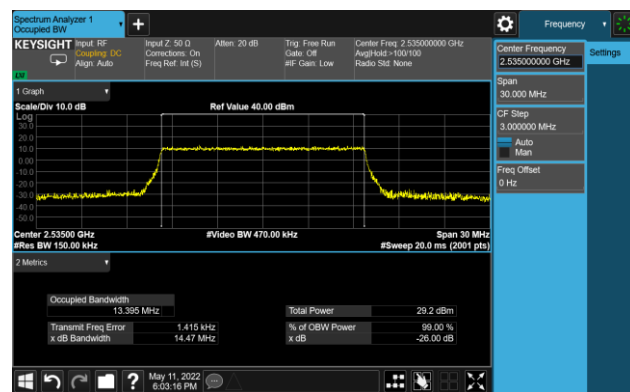

20MHz Channel Bandwidth

