



MEASUREMENT REPORT

FCC PART 96

FCC ID: XIA-CFW2591
Applicant: NetComm Wireless Pty Ltd
Application Type: Certification
Product: 5G High Power mmWave Outdoor CPE
Model No.: CFW-2591
Brand Name: Casa Systems
FCC Rule Part(s): Part 96
Test Procedure(s): ANSI C63.26: 2015
Test Date: October 25 ~ November 30, 2021

Reviewed By:

Sunny Sun

Approved By:

Robin Wu



The test results relate only to the samples tested.

This equipment has been shown to be capable of compliance with the applicable technical standards as indicated in the measurement report and was tested in accordance with the measurement procedures specified in ANSI C63.26-2015. Test results reported herein relate only to the item(s) tested.

The test report shall not be reproduced except in full without the written approval of MRT Technology (Suzhou) Co., Ltd.

Revision History

Report No.	Version	Description	Issue Date	Note
2110RSU037-U5	Rev. 01	Initial Report	12-08-2021	Valid

CONTENTS

Description	Page
1. GENERAL INFORMATION	5
1.1. Applicant	5
1.2. Manufacturer	5
1.3. Testing Facility	5
1.4. Product Information	6
1.5. Radio Specification under Test	6
1.6. Description of Available Antennas.....	6
1.7. Test Methodology	7
1.8. EMI Suppression Device(s)/Modifications.....	7
1.9. Maximum Power, Frequency Tolerance, and Emission Designator	7
1.10. Configuration of Tested System.....	8
1.11. Test Environment Condition.....	8
2. TEST EQUIPMENT CALIBRATION DATE.....	9
3. MEASUREMENT UNCERTAINTY	11
4. TEST RESULT	12
4.1. Summary.....	12
4.2. Occupied Bandwidth Measurement.....	13
4.2.1. Test Limit	13
4.2.2. Test Procedure	13
4.2.3. Test Setting.....	13
4.2.4. Test Setup	13
4.2.4.1. Test Result.....	14
4.3. Equivalent Isotropically Radiated Power Measurement	19
4.3.1. Test Limit	19
4.3.2. Test Procedure	19
4.3.3. Test Setting.....	19
4.3.4. Test Setup	20
4.3.5. Test Result.....	21
4.4. Band Edge Measurement.....	25
4.4.1. Test Limit	25
4.4.2. Test Procedure	25
4.4.3. Test Setting.....	25
4.4.4. Test Setup	26
4.4.5. Test Result.....	27
4.5. Conducted Spurious Emission Measurement	37

4.5.1.	Test Limit	37
4.5.2.	Test Procedure	37
4.5.3.	Test Setting.....	37
4.5.4.	Test Setup	38
4.5.5.	Test Result.....	39
5.	CONCLUSION	44
	Appendix A - Test Setup Photograph	45
	Appendix B - EUT Photograph.....	46

1.4. Product Information

Product Name	5G High Power mmWave Outdoor CPE
Model No.	CFW-2591
Brand Name	Casa Systems
IMEI	Conducted Measurement: 354796430000971 Radiated Measurement: 35479630001250
E-UTRA Band	Band 4, 5, 12, 17, 41, 48, 66
FR1 NR Band	n66
FR2 NR Band	n261
Bluetooth Specification	V4.1 BLE only
Antenna Information	Refer to section 1.6
Operating Temperature	-40 ~ 55 °C
Remark:	
1. The information of EUT was provided by the manufacturer, and the accuracy of the information shall be the responsibility of the manufacturer.	

1.5. Radio Specification under Test

Frequency Range	TDD Band 48: 3550 ~ 3700 MHz
Device Type	End User Device
Modulation	up to 256QAM

1.6. Description of Available Antennas

Technology	Frequency Range (MHz)	Antenna Type	Max Peak Gain (dBi)
LTE Band 4	1710 ~ 1755	Dipole	4.4
LTE Band 5	824 ~ 849		2.1
LTE Band 12	699 ~ 716		1.6
LTE Band 17	704 ~ 716		1.6
LTE Band 41	2496 ~ 2690		5.1
LTE Band 48	3550 ~ 3700		4.3
LTE/NR Band 66	1710 ~ 1780		4.4
Bluetooth	2402 ~ 2480		3.0

1.7. Test Methodology

According to the specifications of the manufacturer, the EUT must comply with the requirements of the following standards:

- ANSI C63.26:2015
- FCC CFR 47 Part 96
- FCC KDB 971168 D01 v03r01: Power Meas License Digital Systems
- FCC KDB 412172 D01 v01r01: Determining ERP and EIRP

1.8. EMI Suppression Device(s)/Modifications

No EMI suppression device(s) were added and/or no modifications were made during testing.

1.9. Maximum Power, Frequency Tolerance, and Emission Designator

Intra Band CA_48C		QPSK			16QAM		
BW (MHz)	BW (MHz)	Designator	Tolerance (ppm)	Max EIPR (W/10MHz)	Designator	Tolerance (ppm)	Max EIPR (W/10MHz)
5+20	3553.3 ~ 3690.0	22M8G7D	-	0.1261	22M8W7D	-	0.1013
20+5	3560.0 ~ 3698.7	22M8G7D	-	0.0692	22M8W7D	-	0.0555
10+20	3555.5 ~ 3690.0	27M6G7D	-	0.1174	27M7W7D	-	0.0940
20+10	3560.0 ~ 3694.5	27M8G7D	-	0.0674	27M7W7D	-	0.0545
15+20	3557.8 ~ 3690.0	32M6G7D	-	0.0862	32M6W7D	-	0.0683
20+15	3560.0 ~ 3692.2	32M6G7D	-	0.0671	32M6W7D	-	0.0536
20+20	3560.0 ~ 3690.0	37M6G7D	-	0.0684	37M5W7D	-	0.0541
Intra Band CA_48C		64QAM			256QAM		
BW (MHz)	BW (MHz)	Designator	Tolerance (ppm)	Max EIPR (W/10MHz)	Designator	Tolerance (ppm)	Max EIPR (W/10MHz)
5+20	3553.3 ~ 3690.0	22M8W7D	-	0.1019	22M8W7D	-	0.0649
20+5	3560.0 ~ 3698.7	22M9W7D	-	0.0556	22M8W7D	-	0.0348
10+20	3555.5 ~ 3690.0	27M8W7D	-	0.0974	27M6W7D	-	0.0600
20+10	3560.0 ~ 3694.5	27M7W7D	-	0.0543	27M6W7D	-	0.0339
15+20	3557.8 ~ 3690.0	32M6W7D	-	0.0685	32M6W7D	-	0.0433
20+15	3560.0 ~ 3692.2	32M6W7D	-	0.0545	32M6W7D	-	0.0342
20+20	3560.0 ~ 3690.0	37M5W7D	-	0.0549	37M6W7D	-	0.0347

1.10. Configuration of Tested System

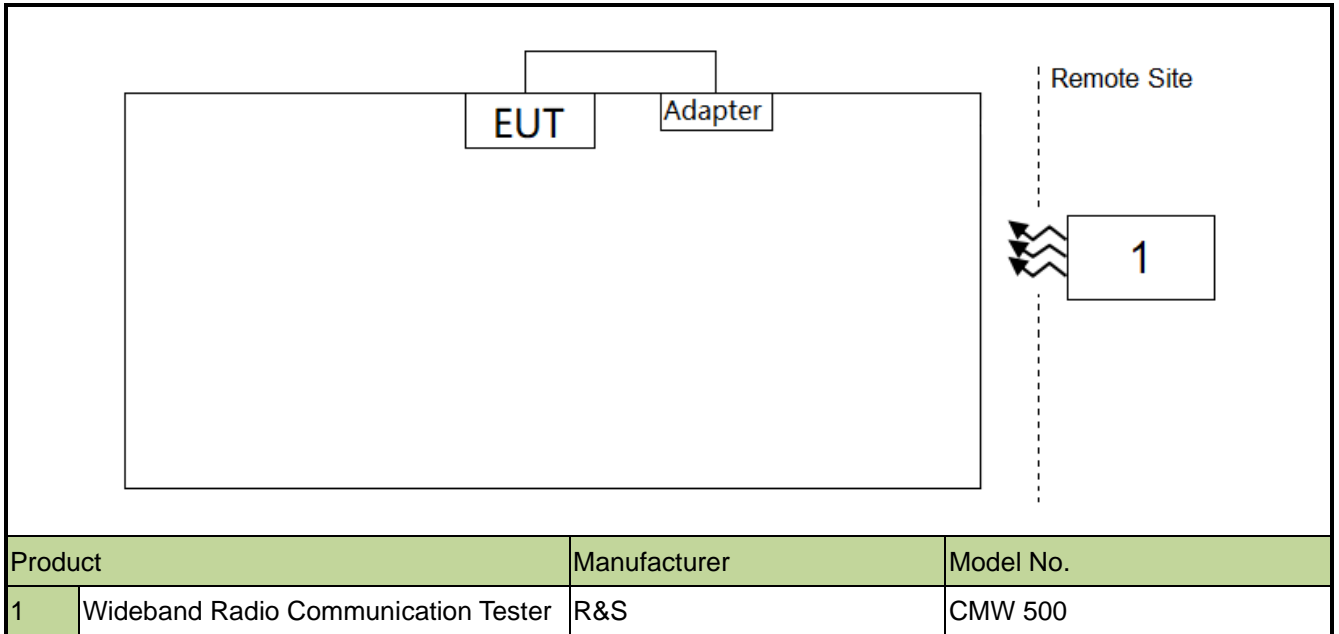

1.11. Test Environment Condition

Ambient Temperature	15 ~ 35°C
Relative Humidity	20% ~ 75%RH

2. TEST EQUIPMENT CALIBRATION DATE

Radiated Emission (WZ- AC1)

Instrument	Manufacturer	Type No.	Asset No.	Cali. Interval	Cali. Due Date
EMI Test Receiver	R&S	ESR7	MRTSUE06001	1 year	2022/01/04
Wideband Radio Communication Tester	R&S	CMW 500	MRTSUE06243	1 year	2022/10/10
PXA Signal Analyzer	Keysight	9030B	MRTSUE06395	1 year	2022/08/08
Loop Antenna	Schwarzbeck	FMZB 1519	MRTSUE06025	1 year	2022/10/28
Bilog Period Antenna	Schwarzbeck	VULB 9168	MRTSUE06172	1 year	2022/08/05
Broad Band Horn Antenna	Schwarzbeck	BBHA 9120D	MRTSUE06023	1 year	2022/09/16
Broad Band Horn Antenna	Schwarzbeck	BBHA 9170	MRTSUE06597	1 year	2021/12/14
Microwave System Amplifier	Agilent	83017A	MRTSUE06076	1 year	2022/11/14
Preamplifier	Schwarzbeck	BBV 9721	MRTSUE06121	1 year	2022/06/09
Thermohygrometer	Testo	608-H1	MRTSUE06403	1 year	2022/06/28
Anechoic Chamber	TDK	Chamber-AC1	MRTSUE06212	1 year	2022/04/29

Radiated Emission (WZ-AC2)

Instrument	Manufacturer	Type No.	Asset No.	Cali. Interval	Cali. Due Date
Spectrum Analyzer	Keysight	N9038A	MRTSUE06125	1 year	2022/06/24
Wideband Radio Communication Tester	R&S	CMW 500	MRTSUE06243	1 year	2022/10/10
Loop Antenna	Schwarzbeck	FMZB 1519	MRTSUE06025	1 year	2022/10/28
Bilog Period Antenna	Schwarzbeck	VULB 9162	MRTSUE06022	1 year	2022/05/24
Horn Antenna	Schwarzbeck	BBHA9120D	MRTSUE06171	1 year	2022/10/21
Broad Band Horn Antenna	Schwarzbeck	BBHA 9170	MRTSUE06597	1 year	2021/12/14
Broad Band Coaxial Preamplifier	Schwarzbeck	BBV 9718	MRTSUE06176	1 year	2022/11/14
Preamplifier	Schwarzbeck	BBV 9721	MRTSUE06121	1 year	2022/06/09
Temperature/Humidity Meter	Minggao	ETH529	MRTSUE06170	1 year	2021/12/15
Anechoic Chamber	RIKEN	Chamber-AC2	MRTSUE06213	1 year	2022/04/29

Conducted Test Equipment (WZ-SR6, WZ-TR3, SIP-SR1)

Instrument	Manufacturer	Type No.	Asset No.	Cali. Interval	Cali. Due Date
EXA Signal Analyzer	Agilent	N9020A	MRTSUE06106	1 year	2022/04/13
EXA Signal Analyzer	Keysight	N9010B	MRTSUE06457	1 year	2022/06/24
Signal Analyzer	R&S	FSV40	MRTSUE06218	1 year	2022/04/13
Wideband Radio Communication Tester	R&S	CMW 500	MRTSUE06243	1 year	2022/10/10
Power Meter	Agilent	U2021XA	MRTSUE06030	1 year	2022/10/10
DC Power Supply	GWINSTEK	DPS-3303C	MRTSUE06064	N/A	N/A
True RMS Clamp Meter	Fluke	319	MRTSUE06947	1 year	2022/05/05
Directional Coupler	Agilent	87301D	MRTSUE06082	1 year	2022/03/08
Dual Directional Coupler	Agilent	7778D	MRTSUE06083	1 year	2022/03/24
Attenuator	MVE	6dB	MRTSUE06534	N/A	N/A
Attenuator	MVE	10dB	MRTSUE06543	N/A	N/A
Temperature & Humidity Chamber	BAOYT	BYH-150CL	MRTSUE06051	1 year	2022/10/10
Thermohygrometer	testo	608-H1	MRTSUE06401	1 year	2022/06/28

Software	Version	Function
EMI Software	V3	EMI Test Software

3. MEASUREMENT UNCERTAINTY

Where relevant, the following test uncertainty levels have been estimated for tests performed on the EUT as specified in CISPR 16-4-2. This uncertainty represents an expanded uncertainty expressed at approximately the 95% confidence level using a coverage factor of $k = 2$.

Radiated Spurious Emissions
Measurement Uncertainty for a Level of Confidence of 95% ($U=2Uc(y)$): Horizontal: 9kHz ~ 300MHz: 5.04dB 300MHz ~ 1GHz: 4.95dB 1GHz ~ 40GHz: 6.40dB Vertical: 9kHz ~ 300MHz: 5.24dB 300MHz ~ 1GHz: 6.03dB 1GHz ~ 40GHz: 6.40dB
Conducted Spurious Emissions
Measuring Uncertainty for a Level of Confidence of 95% ($U=2Uc(y)$): 0.78dB
Output Power
Measuring Uncertainty for a Level of Confidence of 95% ($U=2Uc(y)$): 1.13dB
Occupied Bandwidth
Measuring Uncertainty for a Level of Confidence of 95% ($U=2Uc(y)$): 0.28%
Frequency Stability
Measuring Uncertainty for a Level of Confidence of 95% ($U=2Uc(y)$): 76.2Hz

4. TEST RESULT

4.1. Summary

FCC Part Section(s)	Test Description	Test Condition	Test Result	Reference
2.1049	Occupied Bandwidth	Conducted	Pass	Section 4.2
96.41(b)	Equivalent Isotropic Radiated Power		Pass	Section 4.3
2.1051 96.41(e)	Spurious Emission; Band Edge Emission		Pass	Section 4.4, 4.5

Notes:

- 1) The analyzer plots shown in this section were all taken with a correction table loaded into the analyzer. The correction table was used to account for the losses of the cables and attenuators used as part of the system to connect the EUT to the analyzer at all frequencies of interest.
- 2) Pre-Scan has been conducted to determine the worst-case mode from all possible combinations between available modulations the worst-case was found.
- 3) All supported modulation types were evaluated. The worst-case emission of modulation was selected. Therefore, Band Edge, Radiated & Conducted Spurious Emission were presented worst case in the test report.

4.2. Occupied Bandwidth Measurement

4.2.1. Test Limit

The occupied bandwidth, that is the frequency bandwidth such that, below its lower and above its upper frequency limits, the mean powers radiated are each equal to 0.5 percent of the total mean power radiated by a given emission shall be measured.

4.2.2. Test Procedure

ANSI C63.26-2015 - Section 5.4

4.2.3. Test Setting

1. Set center frequency to the nominal EUT channel center frequency
2. RBW = The nominal RBW shall be in the range of 1% to 5% of the anticipated OBW
3. VBW $\geq 3 \times$ RBW
4. Detector = Peak
5. Trace mode = max hold
6. Sweep = auto couple
7. Allow the trace to stabilize
8. Use the 99% power bandwidth function of the instrument and report the measured bandwidth.

4.2.4. Test Setup

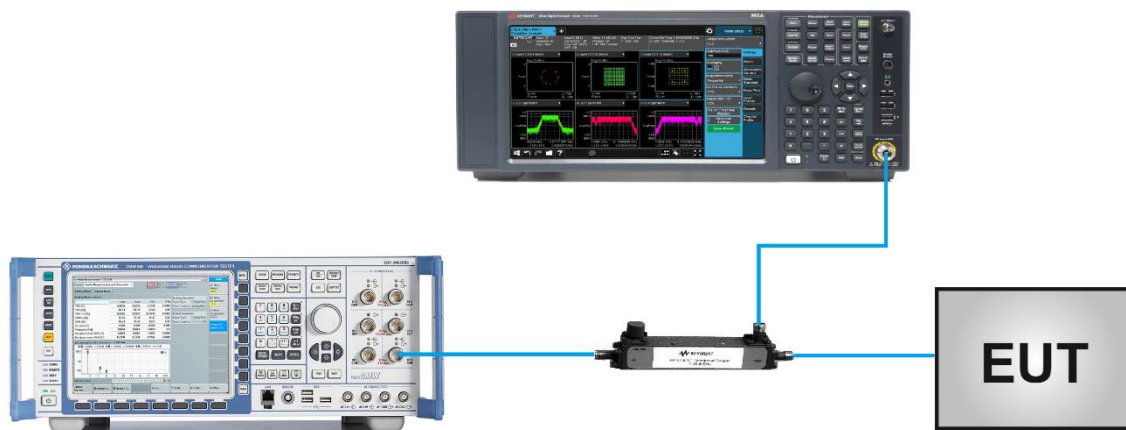

4.2.4.1. Test Result

Test Engineer	Candy Luo	Test Site	WZ-SR6
Test Band	LTE Band CA_48C	Test Date	2021/11/13

Modulation	Frequency (MHz)	Bandwidth (MHz)	99% Bandwidth (MHz)
QPSK	3615.8+3627.5	5+20	22.78
	3622.5+3634.2	20+5	22.79
	3615.6+3630.0	10+20	27.62
	3620.1+3634.5	20+10	27.75
	3615.3+3632.4	15+20	32.58
	3617.6+3634.7	20+15	32.62
	3615.1+3634.9	20+20	37.56
16QAM	3615.8+3627.5	5+20	22.81
	3622.5+3634.2	20+5	22.83
	3615.6+3630.0	10+20	27.68
	3620.1+3634.5	20+10	27.70
	3615.3+3632.4	15+20	32.63
	3617.6+3634.7	20+15	32.59
	3615.1+3634.9	20+20	37.53
64QAM	3615.8+3627.5	5+20	22.80
	3622.5+3634.2	20+5	22.85
	3615.6+3630.0	10+20	27.77
	3620.1+3634.5	20+10	27.72
	3615.3+3632.4	15+20	32.60
	3617.6+3634.7	20+15	32.60
	3615.1+3634.9	20+20	37.48
256QAM	3615.8+3627.5	5+20	22.75
	3622.5+3634.2	20+5	22.82
	3615.6+3630.0	10+20	27.62
	3620.1+3634.5	20+10	27.63
	3615.3+3632.4	15+20	32.58
	3617.6+3634.7	20+15	32.64
	3615.1+3634.9	20+20	37.58

99% Bandwidth - QPSK

5+20MHz Channel Bandwidth

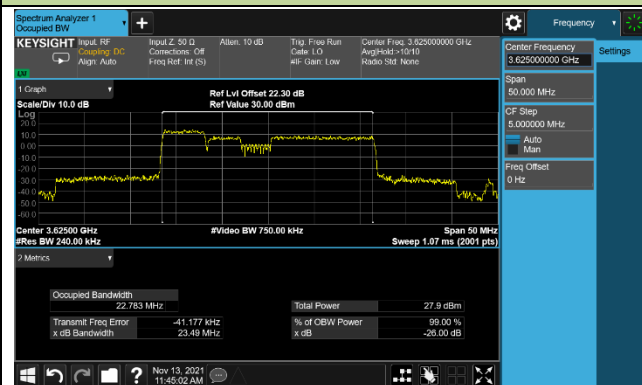

20+5MHz Channel Bandwidth

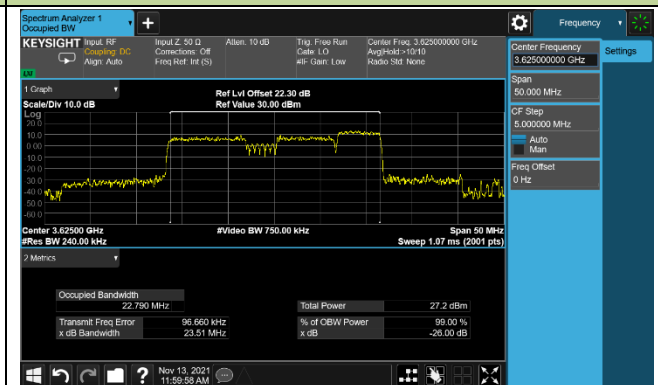

10+20MHz Channel Bandwidth

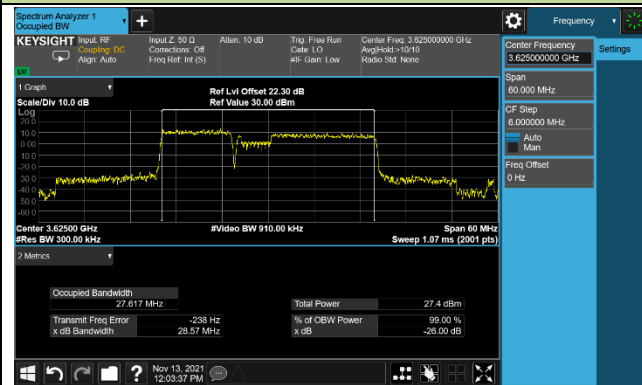

20+10MHz Channel Bandwidth

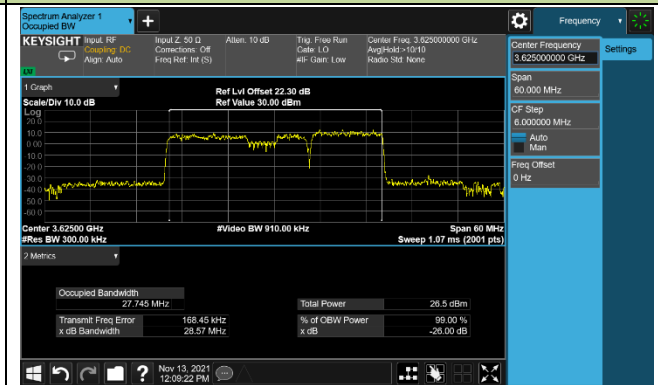

15+20MHz Channel Bandwidth

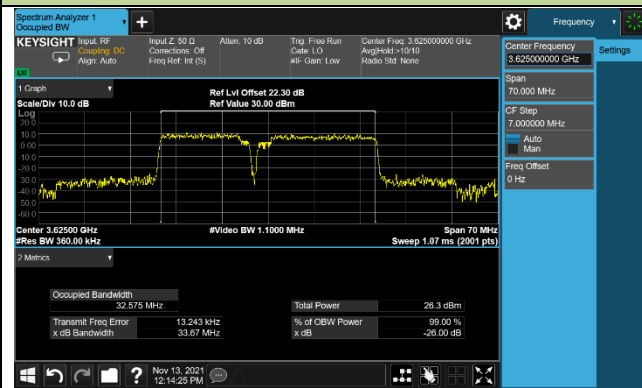

20+15MHz Channel Bandwidth

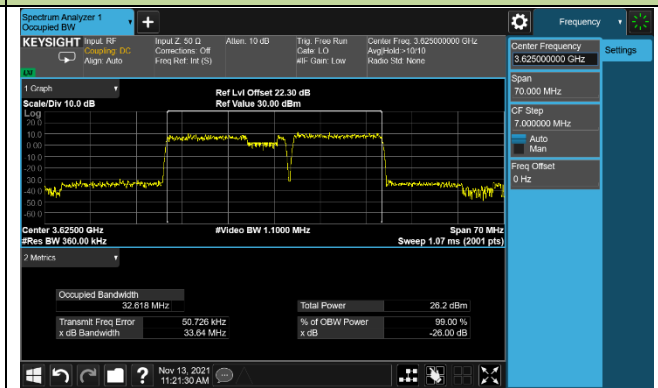

20+20MHz Channel Bandwidth

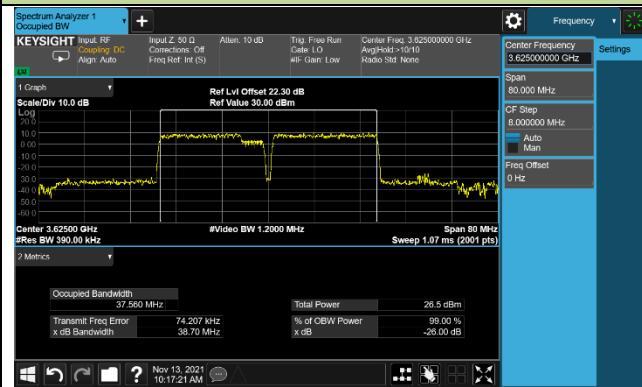

99% Bandwidth - 16QAM

5+20MHz Channel Bandwidth

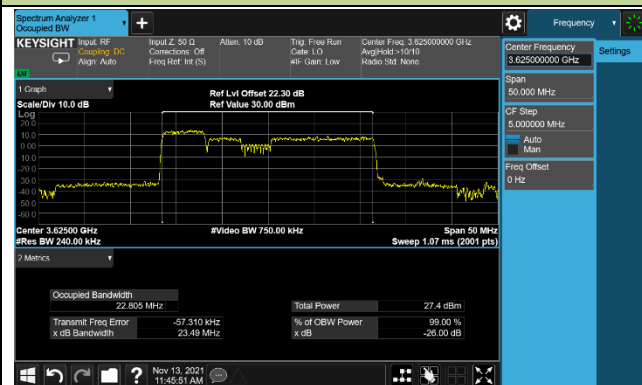

20+5MHz Channel Bandwidth

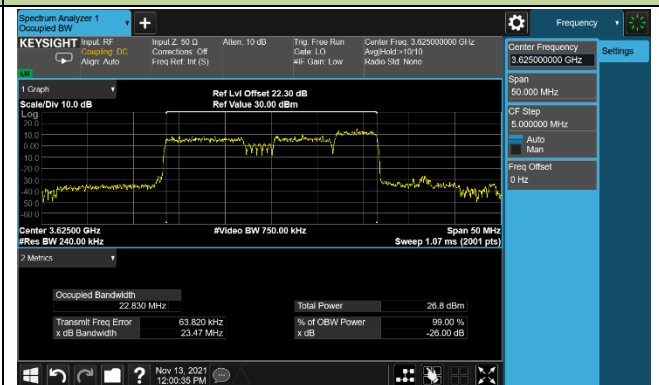

10+20MHz Channel Bandwidth

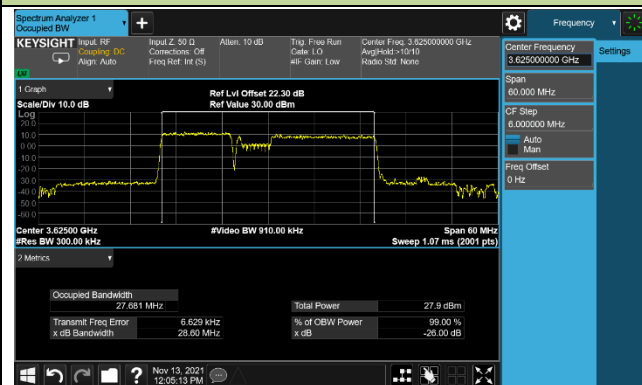

20+10MHz Channel Bandwidth

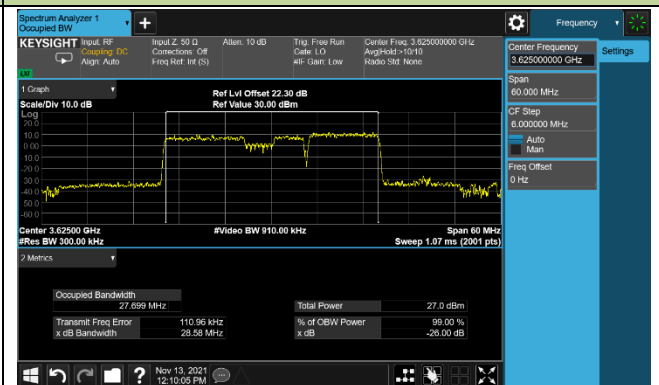

15+20MHz Channel Bandwidth

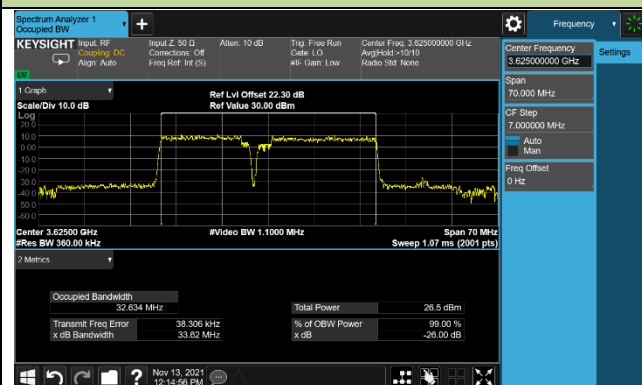

20+15MHz Channel Bandwidth

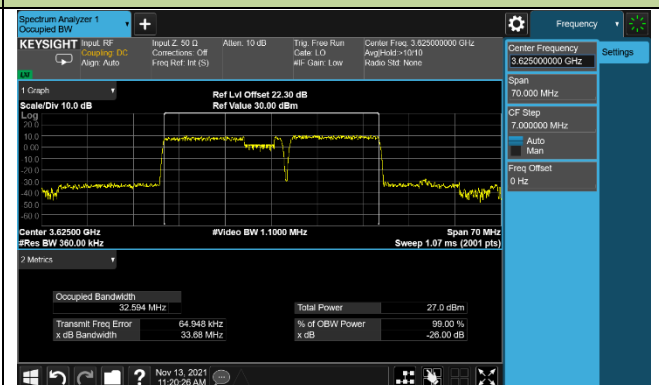

20+20MHz Channel Bandwidth

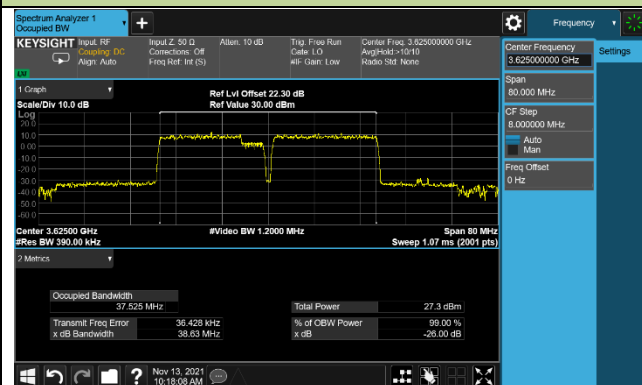

99% Bandwidth - 64QAM

5+20MHz Channel Bandwidth

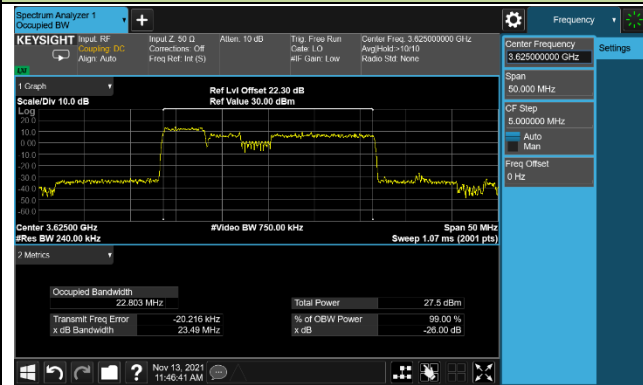

20+5MHz Channel Bandwidth

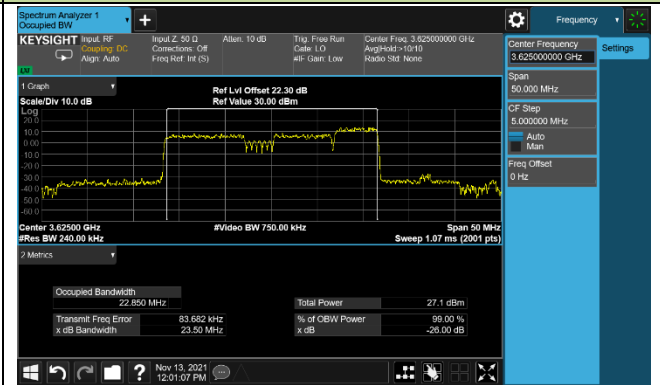

10+20MHz Channel Bandwidth

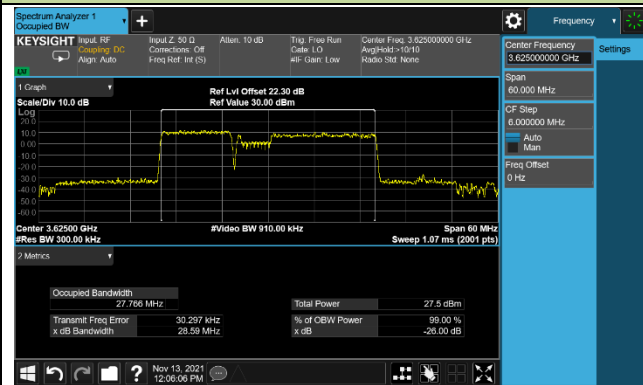

20+10MHz Channel Bandwidth

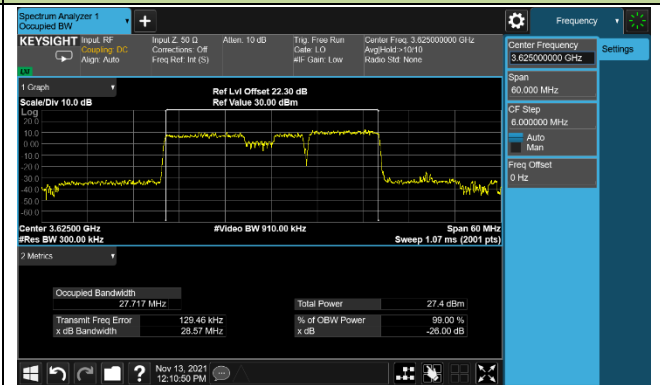

15+20MHz Channel Bandwidth

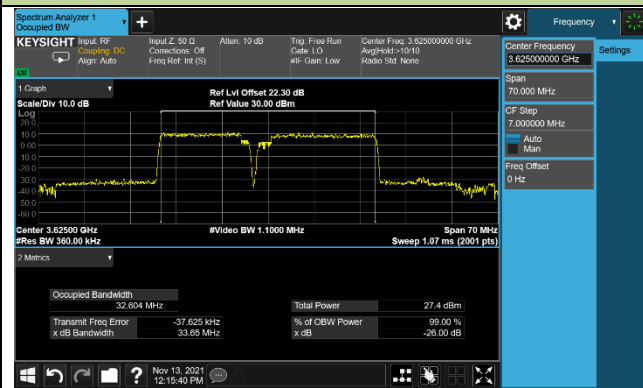

20+15MHz Channel Bandwidth

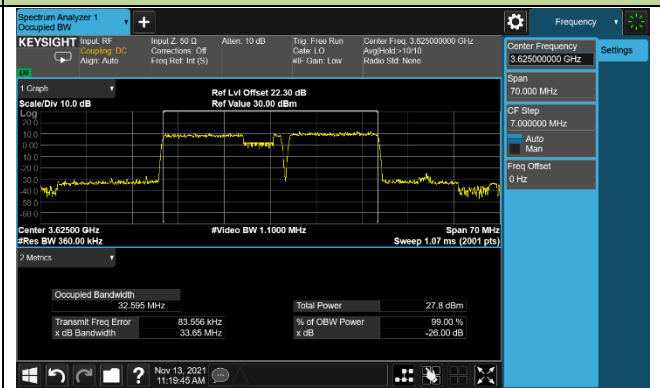

20+20MHz Channel Bandwidth

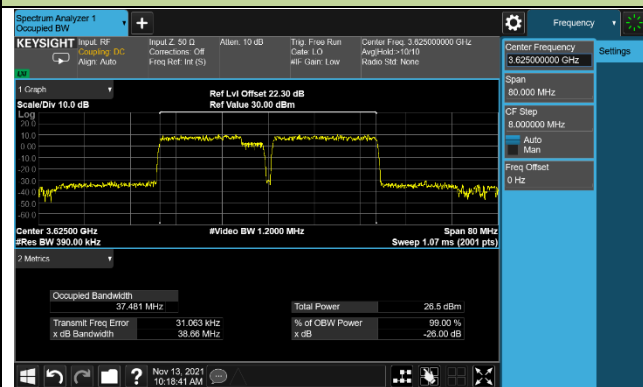

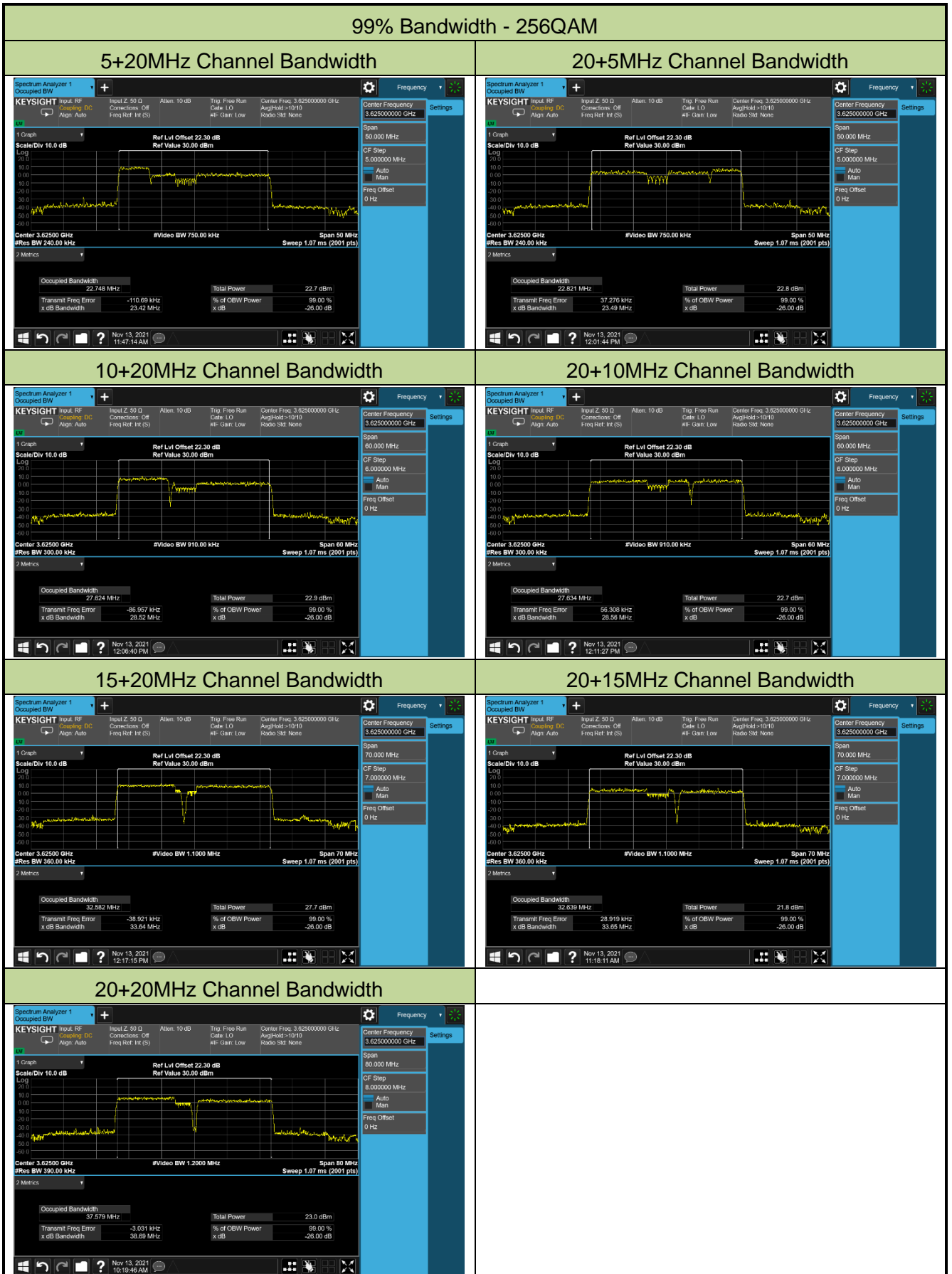

4.3. Equivalent Isotropically Radiated Power Measurement

4.3.1. Test Limit

The maximum effective isotropic radiated power (EIRP) End User Device is 23dBm/10MHz

4.3.2. Test Procedure

ANSI C63.26-2015 - Section 5.2.4.4.2 & 5.2.5.5

4.3.3. Test Setting

When the fundamental condition for average power measurements cannot be realized (i.e., the EUT can not be configured to transmit at full-power on a continuous basis (i.e., duty cycle < 98%) and the instrumentation cannot be configured to measure only during active full-power transmissions), then the following procedure can be used if the EUT duty cycle is constant (i.e., duty cycle variations are less than or equal to $\pm 2\%$).

- 1) Set span to 2 x to 3 x the OBW.
- 2) Set RBW = 1% to 5% of the OBW.
- 3) Set VBW $\geq 3 \times$ RBW.
- 4) Set number of measurement points in sweep $\geq 2 \times$ span / RBW.
- 5) Sweep time:
 - a) Set = auto-couple, or
 - b) Set $\geq [10 \times (\text{number of points in sweep}) \times (\text{transmission symbol period})]$ for single sweep (automation-compatible) measurement.
- 6) Detector = power averaging (rms).
- 7) Set sweep trigger to "free run."
- 8) Trace average at least 100 traces in power averaging (rms) mode if sweep is set to auto-couple. To accurately determine the average power over the on and off time of the transmitter, it can be necessary to increase the number of traces to be averaged above 100, or if using a manually configured sweep time, increase the sweep time.
- 9) Using the marker function to identify the maximum PSD.
- 10) Add $10 \log (1/\text{duty cycle})$ to the measured power level to compute the average power during continuous transmission. For example, add $[10 \log (1/0.25)] = 6 \text{ dB}$ if the duty cycle is a constant 25%.

The relevant equation for determining the maximum ERP or EIRP from the measured RF output

power is given in Equation (1) as follows:

$$\text{ERP or EIRP} = P_{\text{Meas}} + G_{\text{T}} \quad (1)$$

where

ERP or EIRP effective radiated power or equivalent isotropically radiated power, respectively (expressed in the same units as P_{Meas} , e.g., dBm or dBW)

P_{Meas} measured transmitter output power or PSD, in dBm or dBW

G_{T} gain of the transmitting antenna, in dBd (ERP) or dBi (EIRP)

For devices utilizing multiple antennas, see 6.4 for guidance with respect to determining the effective array transmit antenna gain term to be used in the above equation.

4.3.4. Test Setup

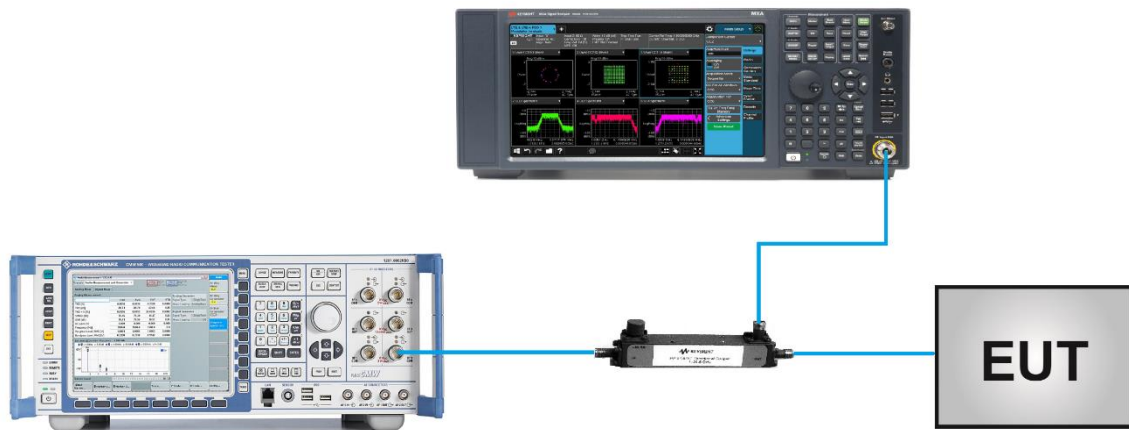

4.3.5.Test Result

Test Engineer	Candy Luo	Test Site	WZ-SR6
Test Band	LTE Band CA_48C	Test Date	2021/11/15

Frequency (MHz)		Channel Bandwidth (MHz)	PCC RB	SCC RB	Output Power (dBm/10MHz)	EIRP (dBm/10MHz)	Limit (dBm/10MHz)
PCC	SCC						
QPSK							
3553.3	3565.0	5+20	P_25@0	S_100@0	16.58	20.88	< 23.00
3615.8	3627.5				16.68	20.98	< 23.00
3678.3	3690.0				16.71	21.01	< 23.00
3560.0	3571.7	20+5	P_100@0	S_25@0	13.91	18.21	< 23.00
3622.5	3634.2				13.98	18.28	< 23.00
3685.0	3696.7				14.10	18.40	< 23.00
3555.5	3569.9	10+20	P_50@99	S_100@0	16.35	20.65	< 23.00
3615.6	3630.0				16.40	20.70	< 23.00
3675.6	3690.0				16.36	20.66	< 23.00
3560.0	3574.4	20+10	P_100@0	S_50@0	13.83	18.13	< 23.00
3620.1	3634.5				13.96	18.26	< 23.00
3680.1	3694.5				13.99	18.29	< 23.00
3557.8	3574.9	15+20	P_75@0	S_75@0	14.95	19.25	< 23.00
3615.3	3632.4				15.06	19.36	< 23.00
3672.9	3690.0				14.99	19.29	< 23.00
3560.0	3577.1	20+15	P_100@0	S_100@0	13.82	18.12	< 23.00
3617.6	3634.7				13.91	18.21	< 23.00
3675.1	3692.2				13.97	18.27	< 23.00
3560.0	3579.8	20+20	P_100@0	S_100@0	13.91	18.21	< 23.00
3615.1	3634.9				13.93	18.23	< 23.00
3670.2	3690.0				14.05	18.35	< 23.00

Note: The EIRP (dBm/10MHz) = Output Power (dBm/10MHz) + Antenna Gain (dBi)

Frequency (MHz)		Channel Bandwidth (MHz)	PCC RB	SCC RB	Output Power (dBm/10MHz)	EIRP (dBm/10MHz)	Limit (dBm/10MHz)
PCC	SCC						
16QAM							
3553.3	3565.0	5+20	P_25@0	S_100@0	15.51	19.81	< 23.00
3615.8	3627.5				15.69	19.99	< 23.00
3678.3	3690.0				15.76	20.06	< 23.00
3560.0	3571.7	20+5	P_100@0	S_25@0	12.90	17.20	< 23.00
3622.5	3634.2				13.02	17.32	< 23.00
3685.0	3696.7				13.14	17.44	< 23.00
3555.5	3569.9	10+20	P_50@99	S_100@0	15.37	19.67	< 23.00
3615.6	3630.0				15.43	19.73	< 23.00
3675.6	3690.0				15.39	19.69	< 23.00
3560.0	3574.4	20+10	P_100@0	S_50@0	12.95	17.25	< 23.00
3620.1	3634.5				12.93	17.23	< 23.00
3680.1	3694.5				13.06	17.36	< 23.00
3557.8	3574.9	15+20	P_75@0	S_75@0	14.05	18.35	< 23.00
3615.3	3632.4				14.03	18.33	< 23.00
3672.9	3690.0				14.04	18.34	< 23.00
3560.0	3577.1	20+15	P_100@0	S_100@0	12.89	17.19	< 23.00
3617.6	3634.7				12.94	17.24	< 23.00
3675.1	3692.2				12.99	17.29	< 23.00
3560.0	3579.8	20+20	P_100@0	S_100@0	12.99	17.29	< 23.00
3615.1	3634.9				13.00	17.30	< 23.00
3670.2	3690.0				13.03	17.33	< 23.00
Note: The EIRP (dBm/10MHz) = Output Power (dBm/10MHz) + Antenna Gain (dBi)							

Frequency (MHz)		Channel Bandwidth (MHz)	PCC RB	SCC RB	Output Power (dBm/10MHz)	EIRP (dBm/10MHz)	Limit (dBm/10MHz)
PCC	SCC						
64QAM							
3553.3	3565.0	5+20	P_25@0	S_100@0	15.57	19.87	< 23.00
3615.8	3627.5				15.66	19.96	< 23.00
3678.3	3690.0				15.78	20.08	< 23.00
3560.0	3571.7	20+5	P_100@0	S_25@0	12.98	17.28	< 23.00
3622.5	3634.2				13.07	17.37	< 23.00
3685.0	3696.7				13.15	17.45	< 23.00
3555.5	3569.9	10+20	P_50@99	S_100@0	15.39	19.69	< 23.00
3615.6	3630.0				15.59	19.89	< 23.00
3675.6	3690.0				15.55	19.85	< 23.00
3560.0	3574.4	20+10	P_100@0	S_50@0	12.95	17.25	< 23.00
3620.1	3634.5				13.03	17.33	< 23.00
3680.1	3694.5				13.05	17.35	< 23.00
3557.8	3574.9	15+20	P_75@0	S_75@0	14.06	18.36	< 23.00
3615.3	3632.4				14.03	18.33	< 23.00
3672.9	3690.0				14.06	18.36	< 23.00
3560.0	3577.1	20+15	P_100@0	S_100@0	12.93	17.23	< 23.00
3617.6	3634.7				12.99	17.29	< 23.00
3675.1	3692.2				13.06	17.36	< 23.00
3560.0	3579.8	20+20	P_100@0	S_100@0	12.99	17.29	< 23.00
3615.1	3634.9				13.01	17.31	< 23.00
3670.2	3690.0				13.10	17.40	< 23.00
Note: The EIRP (dBm/10MHz) = Output Power (dBm/10MHz) + Antenna Gain (dBi)							

Frequency (MHz)		Channel Bandwidth (MHz)	PCC RB	SCC RB	Output Power (dBm/10MHz)	EIRP (dBm/10MHz)	Limit (dBm/10MHz)
PCC	SCC						
256QAM							
3553.3	3565.0	5+20	P_25@0	S_100@0	13.55	17.85	< 23.00
3615.8	3627.5				13.66	17.96	< 23.00
3678.3	3690.0				13.82	18.12	< 23.00
3560.0	3571.7	20+5	P_100@0	S_25@0	10.95	15.25	< 23.00
3622.5	3634.2				11.12	15.42	< 23.00
3685.0	3696.7				11.06	15.36	< 23.00
3555.5	3569.9	10+20	P_50@99	S_100@0	13.39	17.69	< 23.00
3615.6	3630.0				13.48	17.78	< 23.00
3675.6	3690.0				13.45	17.75	< 23.00
3560.0	3574.4	20+10	P_100@0	S_50@0	10.92	15.22	< 23.00
3620.1	3634.5				11.00	15.30	< 23.00
3680.1	3694.5				11.00	15.30	< 23.00
3557.8	3574.9	15+20	P_75@0	S_75@0	12.07	16.37	< 23.00
3615.3	3632.4				12.06	16.36	< 23.00
3672.9	3690.0				12.07	16.37	< 23.00
3560.0	3577.1	20+15	P_100@0	S_100@0	10.91	15.21	< 23.00
3617.6	3634.7				10.88	15.18	< 23.00
3675.1	3692.2				11.04	15.34	< 23.00
3560.0	3579.8	20+20	P_100@0	S_100@0	11.06	15.36	< 23.00
3615.1	3634.9				11.04	15.34	< 23.00
3670.2	3690.0				11.11	15.41	< 23.00
Note: The EIRP (dBm/10MHz) = Output Power (dBm/10MHz) + Antenna Gain (dBi)							

4.4. Band Edge Measurement

4.4.1. Test Limit

All out of band emissions are measured with a spectrum analyzer connected to the antenna terminal of the EUT while the EUT is operating at its maximum duty cycle, at maximum power, and at the appropriate frequencies. All data rates were investigated to determine the worst-case configuration. All modes of operation were investigated, and the worst-case configuration results are reported in this section.

The conducted power of any emission outside the fundamental emission (whether in or outside of the authorized band) shall not exceed -13 dBm/MHz within 0-10 megahertz above the upper SAS-assigned channel edge and within 0-10 megahertz below the lower SAS-assigned channel edge. At all frequencies greater than 10 megahertz above the upper SAS assigned channel edge and less than 10 MHz below the lower SAS assigned channel edge, the conducted power of any emission shall not exceed -25 dBm/MHz.

The conducted power of any emissions below 3530 MHz or above 3720 MHz shall not exceed -40 dBm/MHz.

4.4.2. Test Procedure

ANSI C63.26-2015 - Section 5.7

4.4.3. Test Setting

1. Set the analyzer frequency to low, middle, high channel.
2. $RBW \geq$ The nominal RBW shall be in the range of 1% of the anticipated OBW (in the 1MHz band immediately outside and adjacent to the band edge). For improvement of the accuracy in the measurement of the average power of a noise-like emission, a RBW narrower than the specified reference bandwidth can be used (generally limited to no less than 1% of the OBW), provided that a subsequent integration is performed over the full required measurement bandwidth. This integration should be performed using the spectrum analyzer's band power functions.
3. $VBW \geq 3 * RBW$
4. Sweep time = auto
5. Detector = power averaging (rms)
6. Set sweep trigger to "free run."
7. User gate triggered such that the analyzer only sweeps when the device is transmitting at full

power

8. Trace average at least 100 traces in power averaging (rms) mode if sweep is set to auto-couple. To accurately determine the average power over the on and off time of the transmitter, it can be necessary to increase the number of traces to be averaged above 100, or if using a manually configured sweep time, increase the sweep time.
9. Used power integration when using a measurement bandwidth smaller than the specified bandwidth.

4.4.4. Test Setup

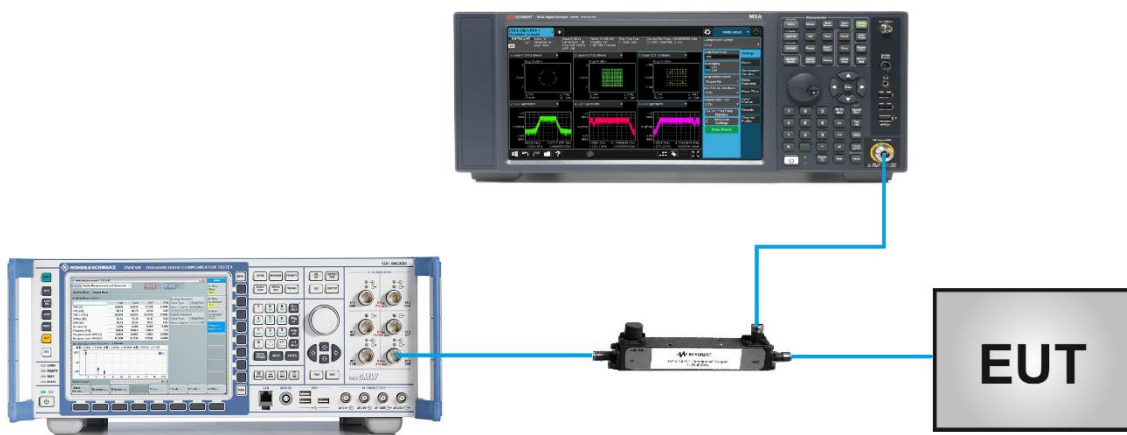

4.4.5. Test Result

Test Engineer	Candy Luo	Test Site	WZ-SR6
Test Band	LTE Band CA_48C_QPSK	Test Date	2021/11/25 ~ 2021/11/26

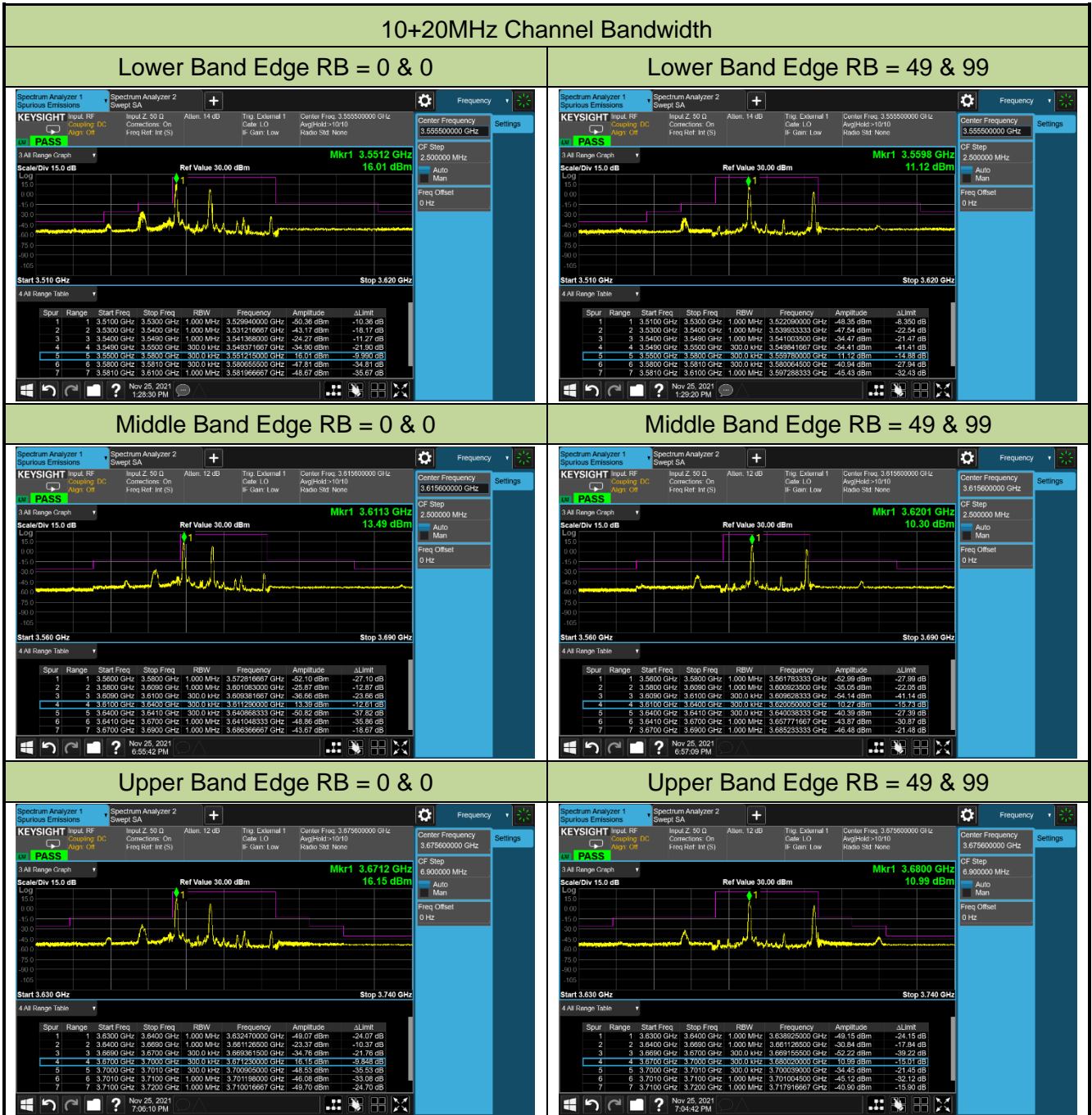

5+20MHz Channel Bandwidth

Lower Band Edge RB = 0 & 0

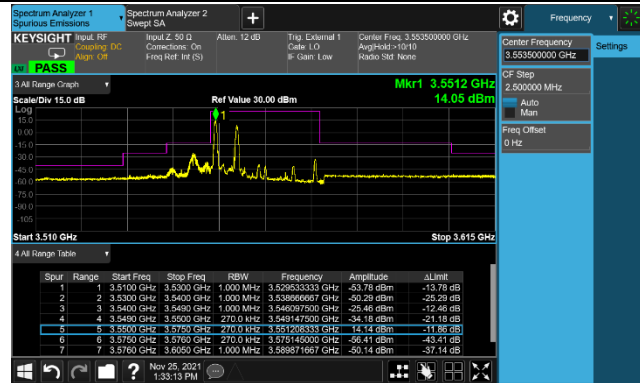

Lower Band Edge RB = 24 & 99

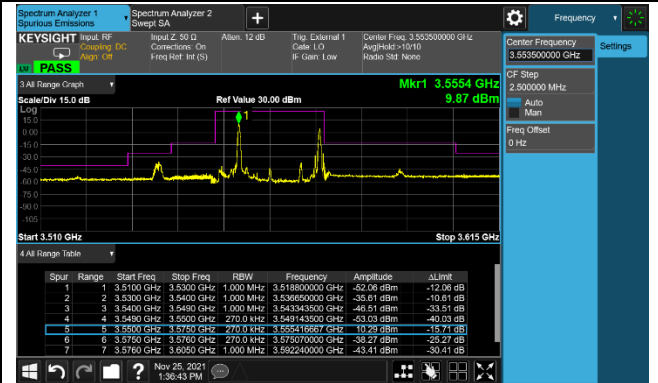

Middle Band Edge RB = 0 & 0

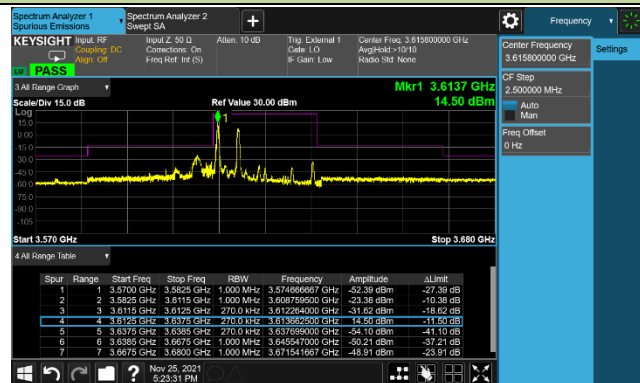

Middle Band Edge RB = 24 & 99

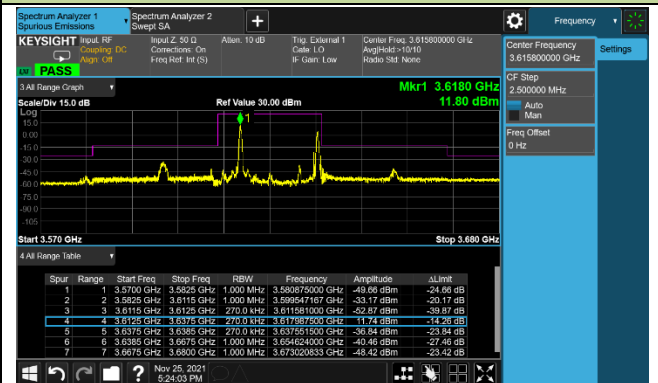

Upper Band Edge RB = 0 & 0

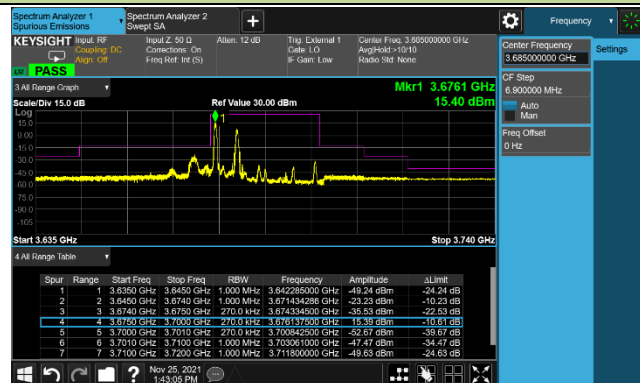

Upper Band Edge RB = 24 & 99

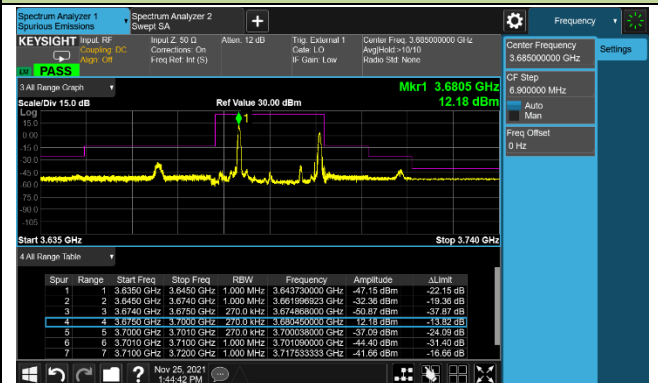

20+5MHz Channel Bandwidth

Lower Band Edge RB = 0 & 0

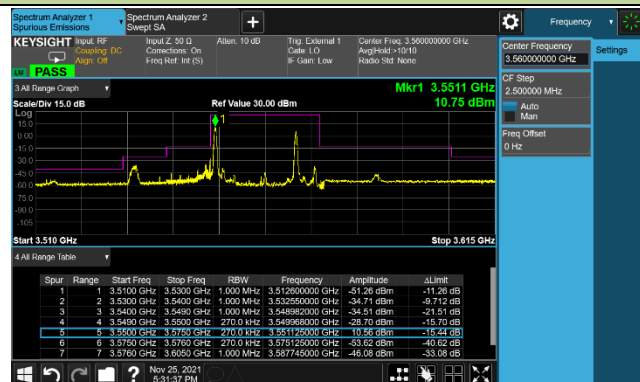

Lower Band Edge RB = 99 & 24

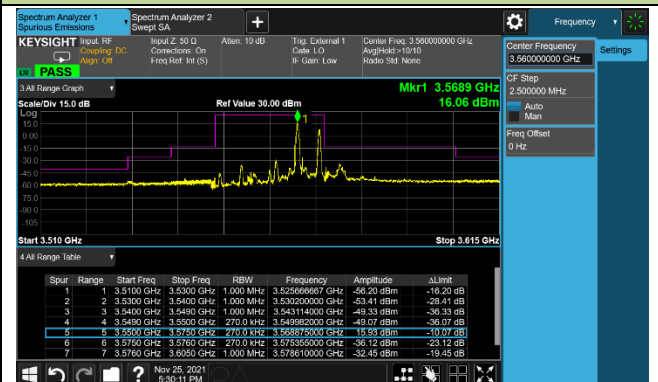

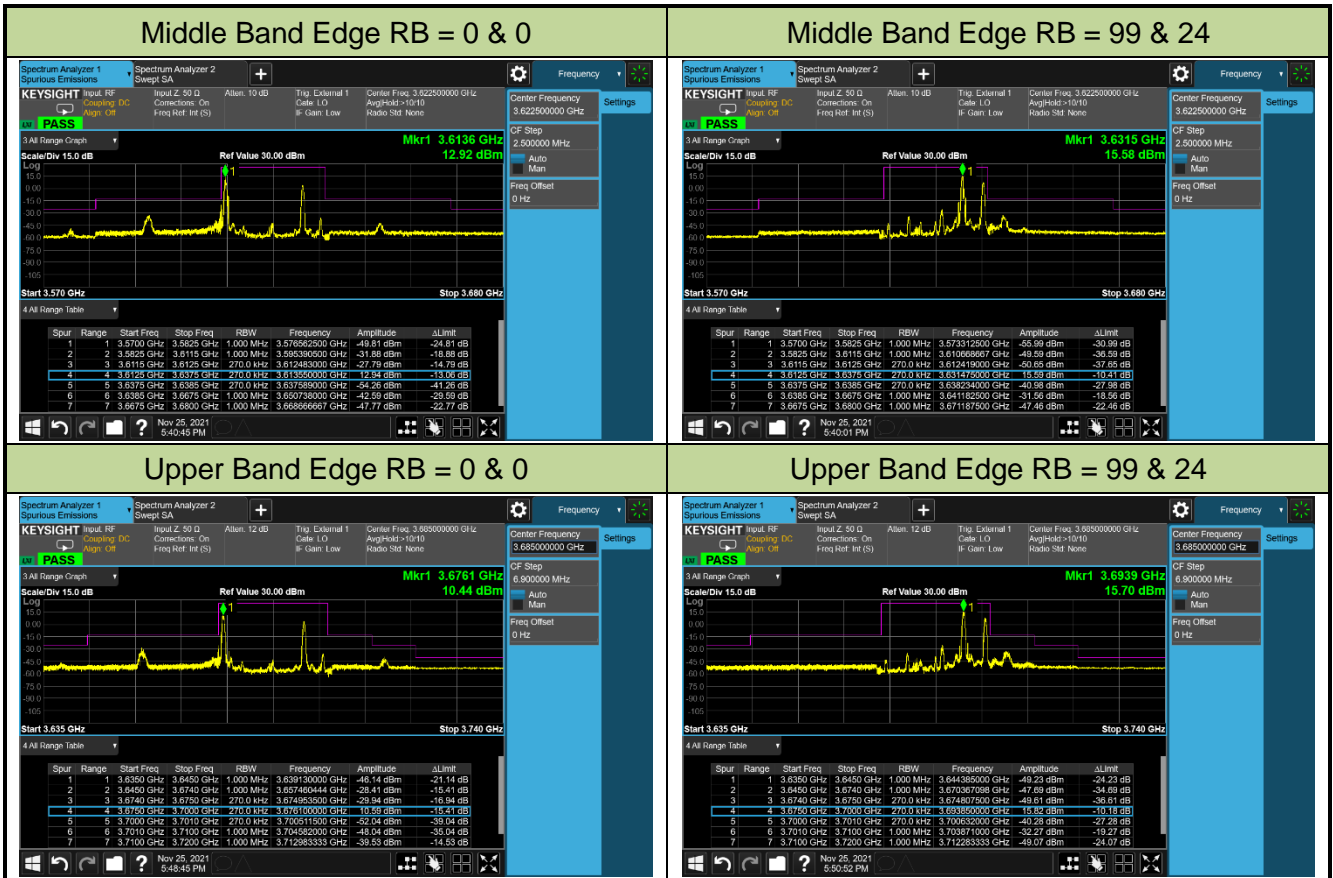

15+20MHz Channel Bandwidth

Lower Band Edge RB = 0 & 0

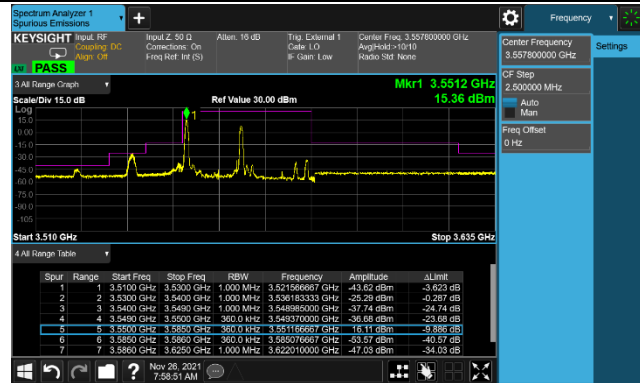

Lower Band Edge RB = 74 & 99

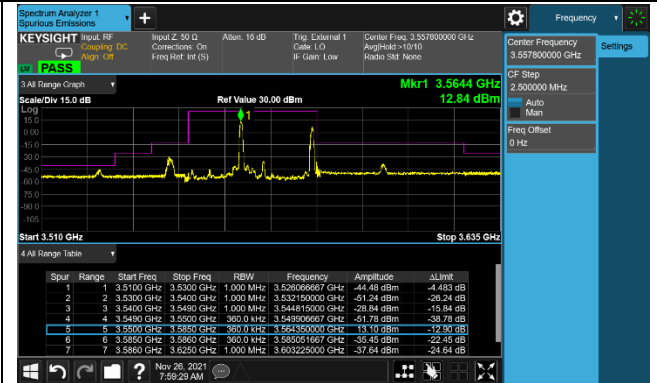

Middle Band Edge RB = 0 & 0

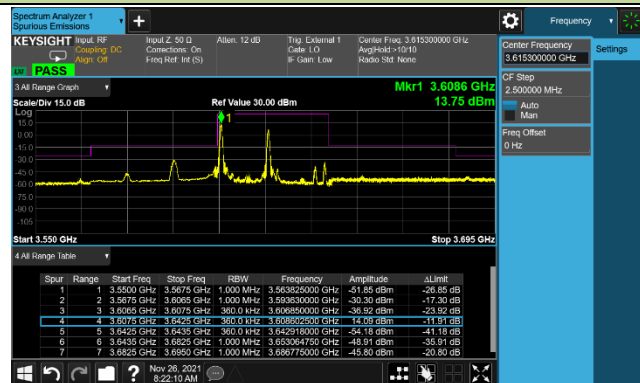

Middle Band Edge RB = 74 & 99

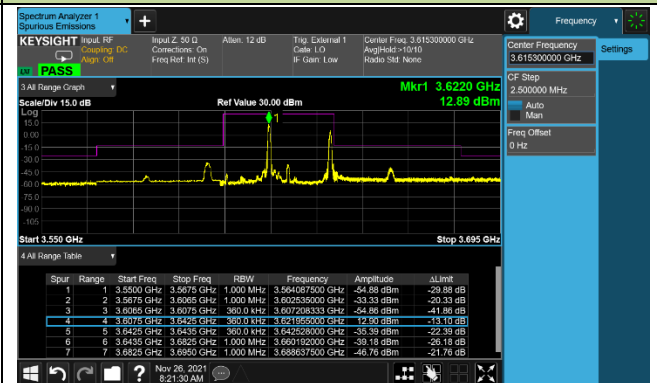

Upper Band Edge RB = 0 & 0

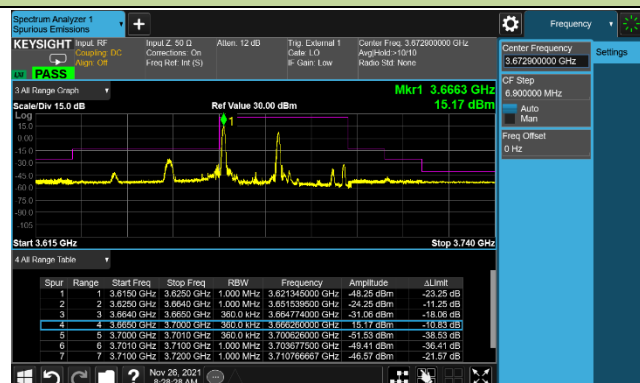

Upper Band Edge RB = 74 & 99

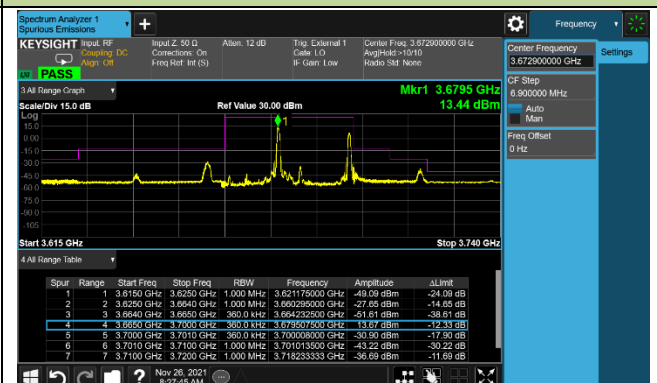

20+10MHz Channel Bandwidth

Lower Band Edge RB = 0 & 0

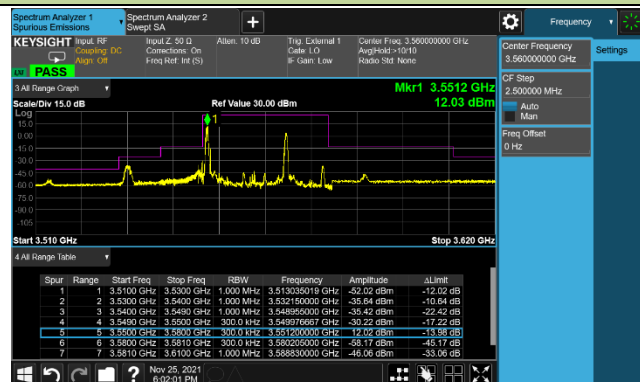

Lower Band Edge RB = 99 & 49

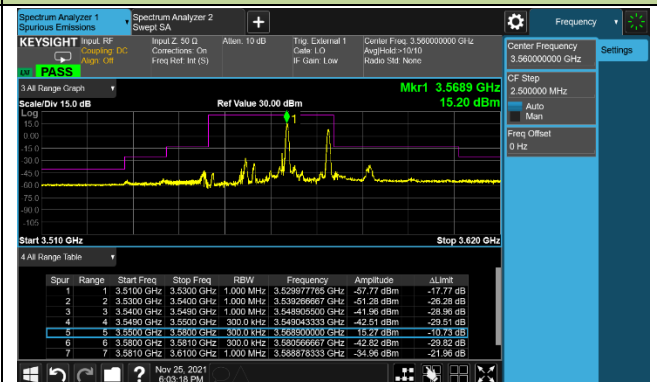

Middle Band Edge RB = 0 & 0 Middle Band Edge RB = 99 & 49

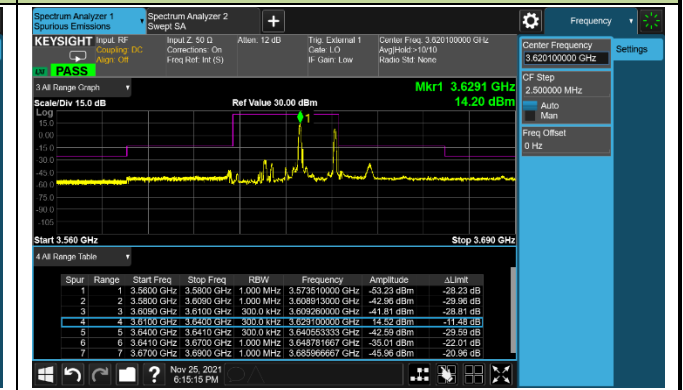
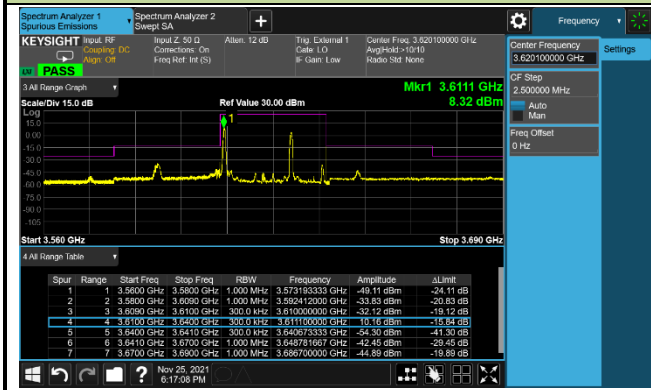

Upper Band Edge RB = 0 & 0 Upper Band Edge RB = 99 & 49

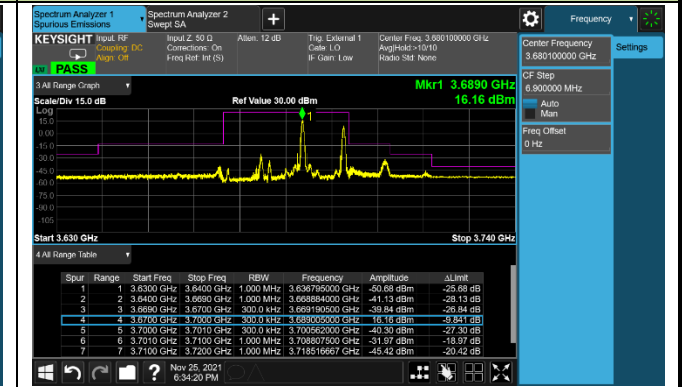
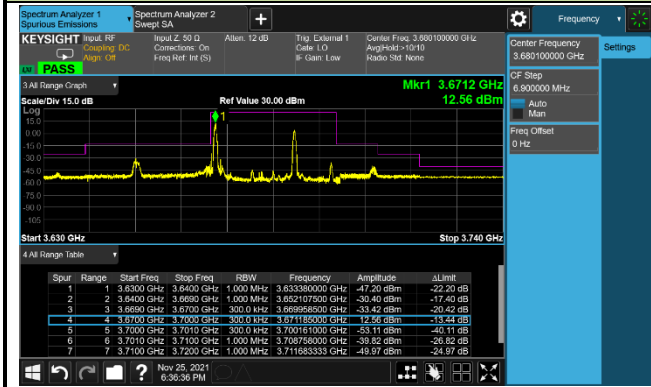

20+15MHz Channel Bandwidth

Lower Band Edge RB = 0 & 0 Lower Band Edge RB = 99 & 74

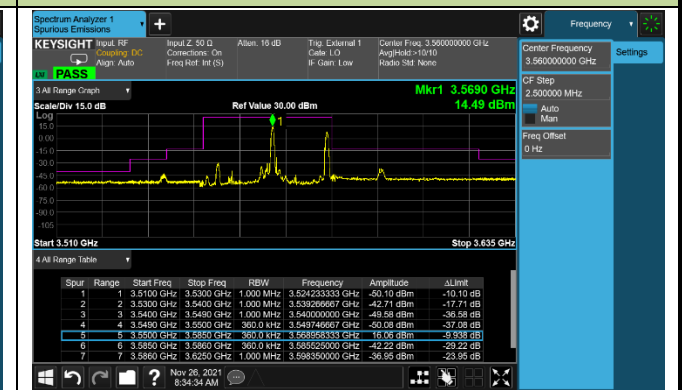
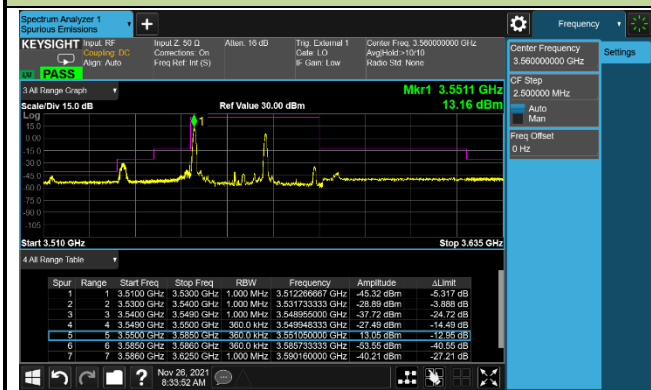

Middle Band Edge RB = 0 & 0 Middle Band Edge RB = 99 & 74

