



FCC RF Test Report

APPLICANT : NetComm Wireless Limited
EQUIPMENT : LTE WiFi Router (LTE Band 4/Band 17)
BRAND NAME : NetComm Wireless
MODEL NAME : 4G100W-01
MARKETING NAME : LTE WiFi Router
FCC ID : XIA-4G100W
STANDARD : FCC 47 CFR Part 2, 22(H), 24(E)
CLASSIFICATION : PCS Licensed Transmitter (PCB)

The product was received on Jul. 25, 2012 and completely tested on Aug. 13, 2012. We, SPORTON INTERNATIONAL INC., would like to declare that the tested sample has been evaluated in accordance with the procedures given in ANSI / TIA / EIA-603-C-2004 and shown compliance with the applicable technical standards.

The test results in this report apply exclusively to the tested model / sample. Without written approval of SPORTON INTERNATIONAL INC., the test report shall not be reproduced except in full.

Reviewed by:

Jones Tsai / Manager



SPORTON INTERNATIONAL INC.

No. 52, Hwa Ya 1st Rd., Hwa Ya Technology Park, Kwei-Shan Hsiang, Tao Yuan Hsien, Taiwan, R.O.C.

SPORTON INTERNATIONAL INC.

TEL : 886-3-327-3456

FAX : 886-3-328-4978

FCC ID : XIA-4G100W

Page Number : 1 of 97

Report Issued Date : Sep. 17, 2012

Report Version : Rev. 01



TABLE OF CONTENTS

REVISION HISTORY.....3

SUMMARY OF TEST RESULT4

1 GENERAL DESCRIPTION.....5

 1.1 Applicant.....5

 1.2 Manufacturer5

 1.3 Feature of Equipment Under Test.....6

 1.4 Maximum ERP/EIRP Power, Frequency Tolerance, and Emission Designator7

 1.5 Testing Site7

 1.6 Applied Standards8

 1.7 Ancillary Equipment List.....8

2 TEST CONFIGURATION OF EQUIPMENT UNDER TEST.....9

 2.1 Test Mode.....9

 2.2 Connection Diagram of Test System 10

3 TEST RESULT..... 11

 3.1 Conducted Output Power and ERP/EIRP Measurement..... 11

 3.2 Peak-to-Average Ratio..... 13

 3.3 Occupied Bandwidth and 26dB Bandwidth Measurement.....27

 3.4 Band Edge Measurement.....47

 3.5 Conducted Spurious Emission Measurement.....60

 3.6 Field Strength of Spurious Radiation Measurement76

 3.7 Frequency Stability Measurement.....91

4 LIST OF MEASURING EQUIPMENT96

5 UNCERTAINTY OF EVALUATION.....97

APPENDIX A. PHOTOGRAPHS OF EUT

APPENDIX B. SETUP PHOTOGRAPHS



REVISION HISTORY

REPORT NO.	VERSION	DESCRIPTION	ISSUED DATE
FG272508A	Rev. 01	Initial issue of report	Sep. 17, 2012



SUMMARY OF TEST RESULT

Report Section	FCC Rule	IC Rule	Description	Limit	Result	Remark
3.1	§2.1046	N/A	Conducted Output Power	N/A	PASS	-
3.1	§22.913(a)(2)	RSS-132(4.4) SRSP-503(5.1.3)	Effective Radiated Power	< 7 Watts	PASS	-
3.1	§24.232(c)	RSS-133 (6.4) SRSP-510(5.1.2)	Equivalent Isotropic Radiated Power	< 2 Watts	PASS	-
3.2	§24.232(d)	N/A	Peak-to-Average Ratio	< 13 dB	PASS	-
3.3	§2.1049 §22.917(a) §24.238(a)	N/A	Occupied Bandwidth	N/A	PASS	-
3.4	§2.1051 §22.917(a) §24.238(a)	RSS-132 (4.5.1) RSS-133 (6.5.1)	Band Edge Measurement	< 43+10log ₁₀ (P[Watts])	PASS	-
3.5	§2.1051 §22.917(a) §24.238(a)	RSS-132 (4.5.1) RSS-133 (6.5.1)	Conducted Spurious Emission	< 43+10log ₁₀ (P[Watts])	PASS	-
3.6	§2.1053 §22.917(a) §24.238(a)	RSS-132 (4.5.1) RSS-133 (6.5.1)	Field Strength of Spurious Radiation	< 43+10log ₁₀ (P[Watts])	PASS	Under limit 19.29 dB at 3760.000 MHz
3.7	§2.1055 §22.355 §24.235	RSS-132(4.3) RSS-133(6.3)	Frequency Stability for Temperature & Voltage	< 2.5 ppm	PASS	-



1 General Description

1.1 Applicant

NetComm Wireless Limited

Level 2, 18-20 Orion Road Lane Cove, NSW Australia

1.2 Manufacturer

NetComm Wireless Limited

Level 2, 18-20 Orion Road Lane Cove, NSW Australia

1.3 Feature of Equipment Under Test

Product Feature	
Equipment	LTE WiFi Router (LTE Band 4/Band 17)
Brand Name	NetComm Wireless
Model Name	4G100W-01
Marketing Name	LTE WiFi Router
FCC ID	XIA-4G100W
Integrated Module	Brand Name : Sierra Model Name : MC7700 FCC ID : N7NMC7700
EUT supports Radios application	GSM/EGPRS/WCDMA/HSPA/LTE/ WLAN 11bgn
HW Version	V1.10
SW Version	1.1.18.0
EUT Stage	Identical Prototype

Remark: The above EUT's information was declared by manufacturer. Please refer to the specifications or user's manual for more detailed description.

Product Specification subjective to this standard	
Tx Frequency	GSM850: 824.2 MHz ~ 848.8 MHz GSM1900: 1850.2 MHz ~ 1909.8MHz WCDMA Band V: 826.4 MHz ~ 846.6 MHz WCDMA Band II: 1852.4 MHz ~ 1907.6 MHz
Rx Frequency	GSM850: 869.2 MHz ~ 893.8 MHz GSM1900: 1930.2 MHz ~ 1989.8 MHz WCDMA Band V: 871.4 MHz ~ 891.6 MHz WCDMA Band II: 1932.4 MHz ~ 1987.6 MHz
Maximum Output Power to Antenna	GSM850 : 32.23 dBm GSM1900 : 29.15 dBm WCDMA Band V : 23.03 dBm WCDMA Band II : 23.06 dBm
Antenna Type	Fixed Internal Antenna
Type of Modulation	GSM: GMSK GPRS: GMSK EDGE: 8PSK WCDMA: QPSK (Uplink) HSDPA: QPSK (Uplink) HSUPA: QPSK (Uplink)

1.4 Maximum ERP/EIRP Power, Frequency Tolerance, and Emission Designator

FCC Rule	System	Type of Modulation	Maximum ERP/EIRP (W)	Frequency Tolerance (% , Hz, ppm)	Emission Designator
Part 22	GSM850 GPRS 8	GMSK	2.333	0.06 ppm	250KGXW
Part 22	GSM850 EDGE 8	GMSK / 8PSK	0.618	0.06 ppm	246KG7W
Part 22	WCDMA Band V RMC 12.2Kbps	QPSK	0.281	0.01 ppm	4M18F9W
Part 24	GSM1900 GPRS 8	GMSK	1.334	0.05 ppm	246KGXW
Part 24	GSM1900 EDGE 8	GMSK / 8PSK	0.607	0.05 ppm	248KG7W
Part 24	WCDMA Band II RMC 12.2Kbps	QPSK	0.328	0.01 ppm	4M16F9W

1.5 Testing Site

Test Site	SPORTON INTERNATIONAL INC.		
Test Site Location	No. 52, Hwa Ya 1 st Rd., Hwa Ya Technology Park, Kwei-Shan Hsiang, Tao Yuan Hsien, Taiwan, R.O.C. TEL: +886-3-327-3456 FAX: +886-3-328-4978		
Test Site No.	Sporton Site No.		FCC/IC Registration No.
	TH02-HY	03CH05-HY	722060/4086B-1



1.6 Applied Standards

According to the specifications of the manufacturer, the EUT must comply with the requirements of the following standards:

- Preliminary Guidance for Receiving Applications for Certification of 3G Device. May 9, 2006.
- FCC 47 CFR Part 2, 22(H), 24(E)
- FCC KDB 971168 D01 Power Meas. License Digital Systems v01
- FCC KDB 412172 D01 Determining ERP and EIRP v01
- IC RSS-132 Issue 2
- IC RSS-133 Issue 5

Remark:

1. All test items were verified and recorded according to the standards and without any deviation during the test.
2. This EUT has also been tested and complied with the requirements of FCC Part 15, Subpart B, recorded in a separate test report.

1.7 Ancillary Equipment List

Item	Equipment	Trade Name	Model No.	FCC ID	Data Cable	Power Cord
1.	System Simulator	R&S	CMU200	N/A	N/A	Unshielded, 1.8 m

2 Test Configuration of Equipment Under Test

2.1 Test Mode

During all testing, EUT is in link mode with base station emulator at maximum power level. The spurious emission measurements were carried out in semi-anechoic chamber with 3-meter test range.

Frequency range investigated for radiated emission is as follows:

1. 30 MHz to 9000 MHz for GSM850 and WCDMA Band V.
2. 30 MHz to 19000 MHz for GSM1900 and WCDMA Band II.

Test Modes		
Band	Radiated TCs	Conducted TCs
GSM 850	<ul style="list-style-type: none"> ■ GPRS 8 Link ■ EDGE 8 Link 	<ul style="list-style-type: none"> ■ GPRS 8 Link ■ EDGE 8 Link
GSM 1900	<ul style="list-style-type: none"> ■ GPRS 8 Link ■ EDGE 8 Link 	<ul style="list-style-type: none"> ■ GPRS 8 Link ■ EDGE 8 Link
WCDMA Band V	<ul style="list-style-type: none"> ■ RMC 12.2Kbps Link 	<ul style="list-style-type: none"> ■ RMC 12.2Kbps Link
WCDMA Band II	<ul style="list-style-type: none"> ■ RMC 12.2Kbps Link 	<ul style="list-style-type: none"> ■ RMC 12.2Kbps Link

Note:

1. The maximum power levels are GPRS multi-slot class 8 mode for GMSK link, EDGE multi-slot class 8 mode for 8PSK link, RMC 12.2Kbps mode for WCDMA band V, and RMC 12.2Kbps mode for WCDMA band II, only these modes were used for all tests.
2. Because there are individual antennas for each WWAN and WLAN, the co-location test modes are not required.

The conducted power tables are as follows:

Conducted Power (*Unit: dBm)						
Band	GSM850			GSM1900		
Channel	128	189	251	512	661	810
Frequency	824.2	836.4	848.8	1850.2	1880.0	1909.8
GPRS 8	32.20	32.23	32.07	29.02	29.07	29.15
GPRS 10	32.03	32.04	31.90	28.65	28.80	28.76
EGPRS 8	26.24	26.37	26.46	25.58	25.70	25.73
EGPRS 10	26.14	26.30	26.40	25.42	25.51	25.70
EGPRS 12	25.90	25.98	26.10	25.10	25.18	25.14

Conducted Power (*Unit: dBm)						
Band	WCDMA Band V			WCDMA Band II		
Channel	4132	4182	4233	9262	9400	9538
Frequency	826.4	836.4	846.6	1852.4	1880.0	1907.6
RMC 12.2K	23.03	22.87	22.90	22.93	23.06	22.80
HSDPA Subtest-1	22.50	22.33	22.26	22.42	22.60	22.11
HSDPA Subtest-2	22.49	22.25	22.32	22.40	22.50	22.12
HSDPA Subtest-3	22.06	21.80	21.82	22.03	22.03	21.55
HSDPA Subtest-4	22.01	21.79	21.74	21.88	21.98	21.56
HSUPA Subtest-1	22.10	22.80	21.95	22.17	22.59	22.22
HSUPA Subtest-2	20.85	20.83	20.65	20.88	21.07	21.00
HSUPA Subtest-3	21.23	21.18	21.09	21.16	21.35	21.20
HSUPA Subtest-4	20.95	20.90	20.85	21.06	21.20	21.09
HSUPA Subtest-5	22.33	22.31	22.22	22.43	22.65	22.50

2.2 Connection Diagram of Test System

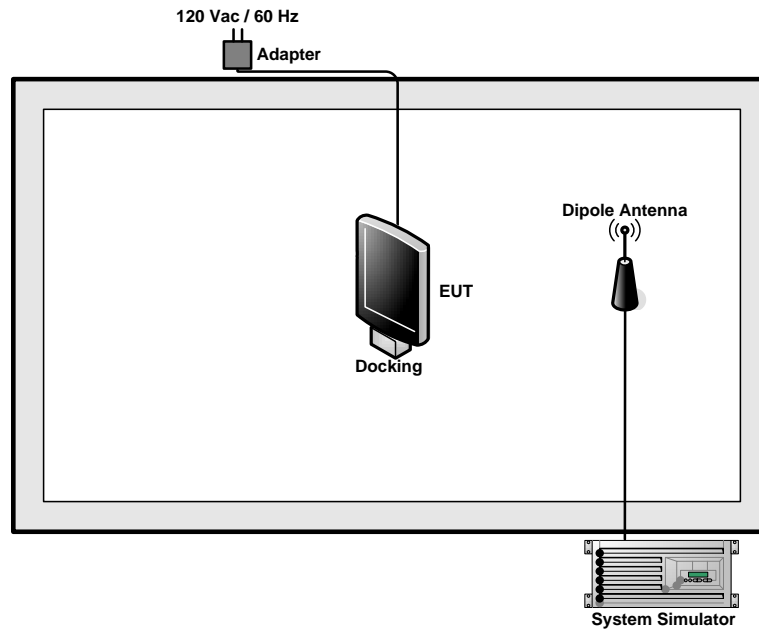

3 Test Result

3.1 Conducted Output Power and ERP/EIRP Measurement

3.1.1 Description of the Conducted Output Power and ERP/EIRP Measurement

A base station simulator was used to establish communication with the EUT. Its parameters were set to transmit the maximum power on the EUT. The measured power in the radio frequency on the transmitter output terminals shall be reported.

The ERP of mobile transmitters must not exceed 7 Watts and the EIRP of mobile transmitters are limited to 2 Watts. According to KDB 412172 D01 Power Approach,

$EIRP = P_T + G_T - L_C$, $ERP = EIRP - 2.15$, where

P_T = transmitter output power in dBm

G_T = gain of the transmitting antenna in dBi

L_C = signal attenuation in the connecting cable between the transmitter and antenna in dB

3.1.2 Measuring Instruments

See list of measuring instruments of this test report.

3.1.3 Test Procedures

1. The transmitter output port was connected to base station.
2. Set EUT at maximum power through base station.
3. Select lowest, middle, and highest channels for each band and different modulation.
4. Compare each band and different modulation combination to show the worst data rate.

3.1.4 Test Setup

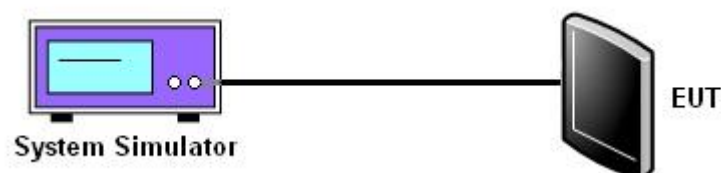

3.1.5 Test Result of Conducted Output Power

Cellular Band ($G_T - L_C = 3.6\text{dB}$)									
Modes	GSM850 (GPRS 8)			GSM850 (EDGE 8)			WCDMA Band V (RMC 12.2Kbps)		
Channel	128 (Low)	189 (Mid)	251 (High)	128 (Low)	189 (Mid)	251 (High)	4132 (Low)	4182 (Mid)	4233 (High)
Frequency (MHz)	824.2	836.4	848.8	824.2	836.4	848.8	826.4	836.4	846.6
Conducted Power (dBm)	32.20	32.23	32.07	26.24	26.37	26.46	23.03	22.87	22.90
Conducted Power (Watts)	1.66	1.67	1.61	0.42	0.43	0.44	0.20	0.19	0.19
ERP(dBm)	33.65	33.68	33.52	27.69	27.82	27.91	24.48	24.32	24.35
ERP(Watts)	2.317	2.333	2.249	0.587	0.605	0.618	0.281	0.270	0.272

PCS Band ($G_T - L_C = 2.1\text{dB}$)									
Modes	GSM1900 (GPRS 8)			GSM1900 (EDGE 8)			WCDMA Band II (RMC 12.2Kbps)		
Channel	512 (Low)	661 (Mid)	810 (High)	512 (Low)	661 (Mid)	810 (High)	9262 (Low)	9400 (Mid)	9538 (High)
Frequency (MHz)	1850.2	1880	1909.8	1850.2	1880	1909.8	1852.4	1880	1907.6
Conducted Power (dBm)	29.02	29.07	29.15	25.58	25.70	25.73	22.93	23.06	22.80
Conducted Power (Watts)	0.80	0.81	0.82	0.36	0.37	0.37	0.20	0.20	0.19
EIRP(dBm)	31.12	31.17	31.25	27.68	27.80	27.83	25.03	25.16	24.90
EIRP(Watts)	1.294	1.309	1.334	0.586	0.603	0.607	0.318	0.328	0.309

Note: maximum burst average power for GSM, and maximum average power for WCDMA.

$$\text{EIRP} = P_T + G_T - L_C, \text{ ERP} = \text{EIRP} - 2.15, \text{ where}$$

P_T = transmitter output power in dBm

G_T = gain of the transmitting antenna in dBi

L_C = signal attenuation in the connecting cable between the transmitter and antenna in dB

3.2 Peak-to-Average Ratio

3.2.1 Description of the PAR Measurement

Power Complementary Cumulative Distribution Function (CCDF) curves provide a means for characterizing the power peaks of a digitally modulated signal on a statistical basis. A CCDF curve depicts the probability of the peak signal amplitude exceeding the average power level. Most contemporary measurement instrumentation include the capability to produce CCDF curves for an input signal provided that the instrument's resolution bandwidth can be set wide enough to accommodate the entire input signal bandwidth. The following guidelines are offered for performing a CCDF measurement.

3.2.2 Measuring Instruments

See list of measuring instruments of this test report.

3.2.3 Test Procedures

1. The EUT was connected to Spectrum Analyzer and Base Station via power divider.
2. The CCDF (Complementary Cumulative Distribution Function) of the middle channel for the highest RF powers were measured.

3.2.4 Test Setup

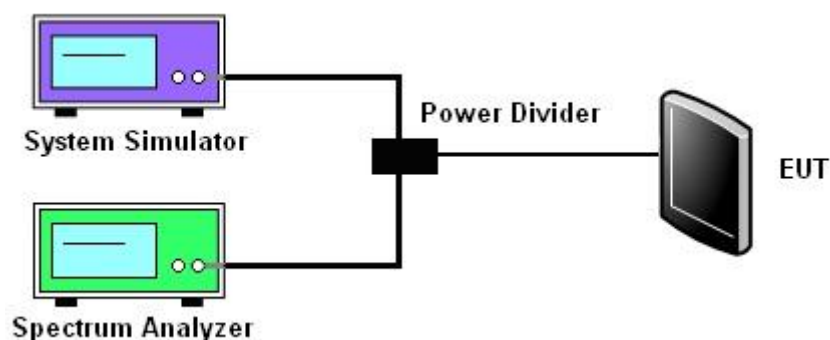



3.2.5 Test Result of Peak-to-Average Ratio

Cellular Band									
Modes	GSM850 (GPRS 8)			GSM850 (EDGE 8)			WCDMA Band V (RMC 12.2Kbps)		
Channel	128 (Low)	189 (Mid)	251 (High)	128 (Low)	189 (Mid)	251 (High)	4132 (Low)	4182 (Mid)	4233 (High)
Frequency (MHz)	824.2	836.4	848.8	824.2	836.4	848.8	826.4	836.4	846.6
Peak-to-Average Ratio (dB)	0.09	0.11	0.15	0.43	0.53	0.52	3.20	3.16	3.20

PCS Band									
Modes	GSM1900 (GPRS 8)			GSM1900 (EDGE 8)			WCDMA Band II (RMC 12.2Kbps)		
Channel	512 (Low)	661 (Mid)	810 (High)	512 (Low)	661 (Mid)	810 (High)	9262 (Low)	9400 (Mid)	9538 (High)
Frequency (MHz)	1850.2	1880	1909.8	1850.2	1880	1909.8	1852.4	1880	1907.6
Peak-to-Average Ratio (dB)	0.11	0.09	0.14	0.49	0.51	0.45	3.36	3.28	3.00



3.2.6 Test Result (Plots) of Peak-to-Average Ratio

Band :	GSM 850	Test Mode :	GPRS 8 Link
--------	---------	-------------	-------------

Peak-to-Average Ratio on Channel 128 (824.2 MHz)

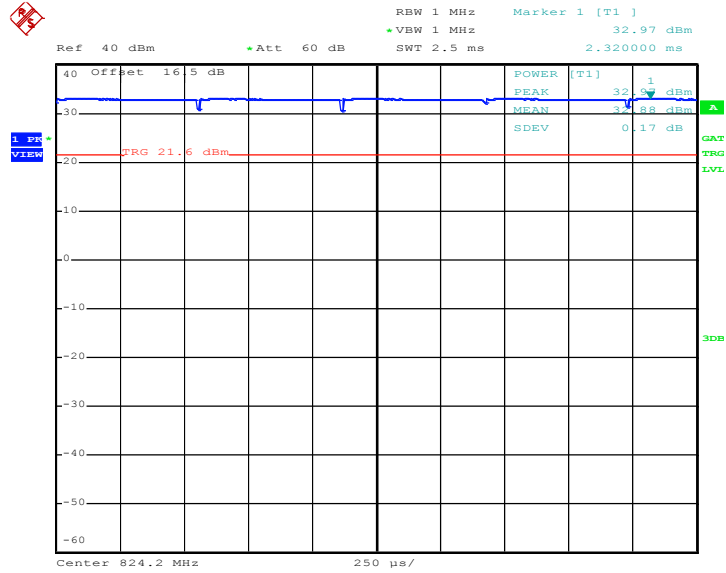

Date: 6.AUG.2012 10:06:51

Peak-to-Average Ratio on Channel 189 (836.4 MHz)

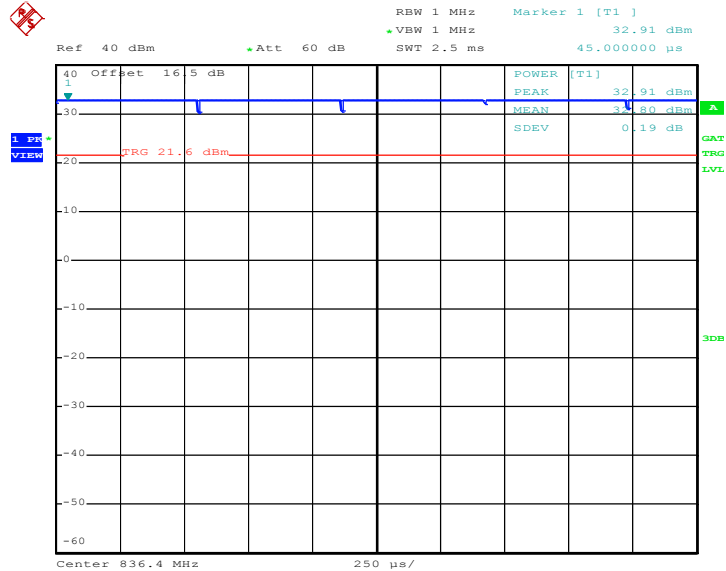

Date: 6.AUG.2012 10:07:24



Peak-to-Average Ratio on Channel 251 (848.8 MHz)

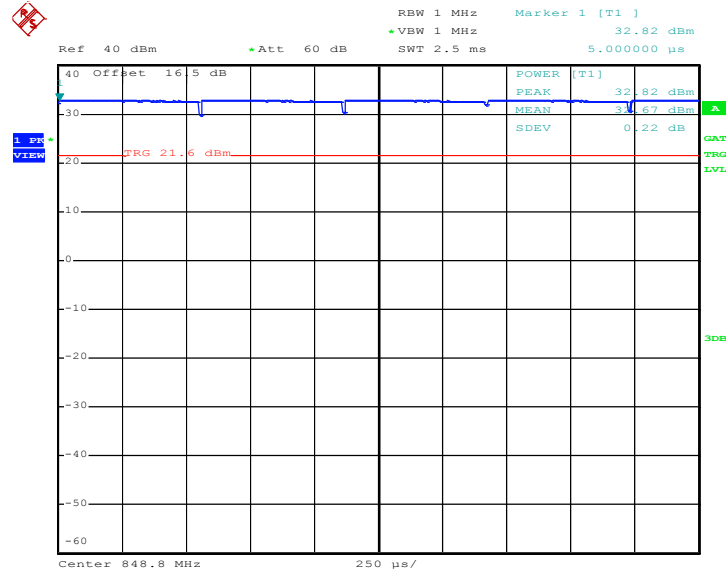

Date: 6.AUG.2012 10:07:54



Band :	GSM 850	Test Mode :	EDGE 8 Link
---------------	---------	--------------------	-------------

Peak-to-Average Ratio on Channel 128 (824.2 MHz)

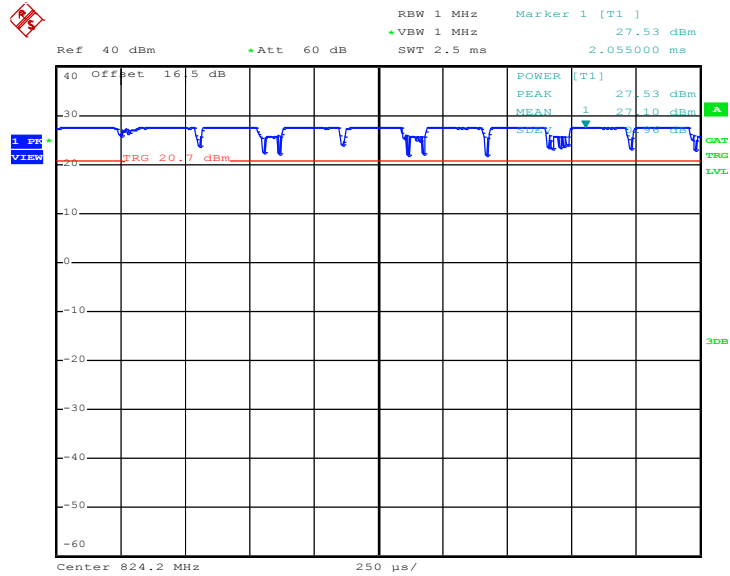

Date: 6.AUG.2012 10:23:56

Peak-to-Average Ratio on Channel 189 (836.4 MHz)

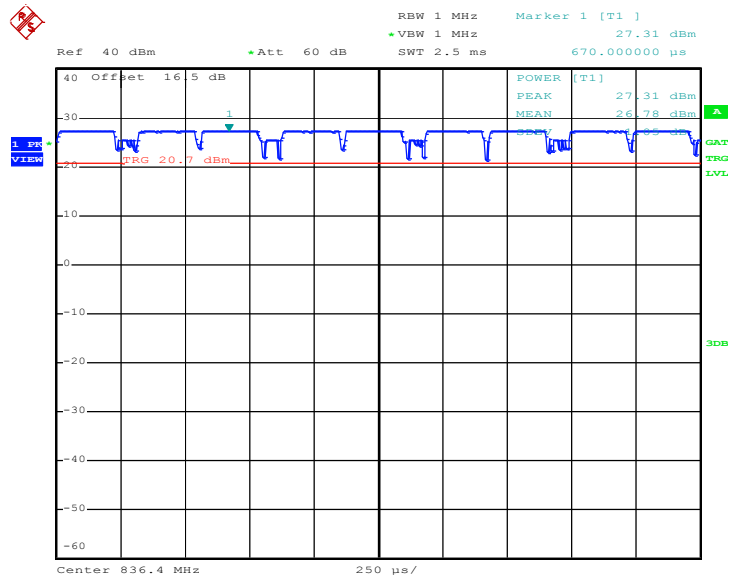

Date: 6.AUG.2012 10:24:26



Peak-to-Average Ratio on Channel 251 (848.8 MHz)

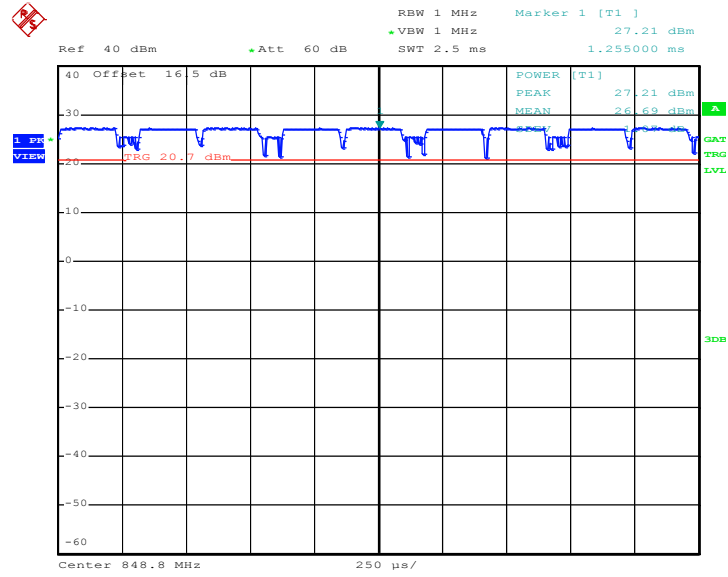

Date: 6.AUG.2012 10:25:03



Band :	GSM 1900	Test Mode :	GPRS 8 Link
--------	----------	-------------	-------------

Peak-to-Average Ratio on Channel 512 (1850.2 MHz)

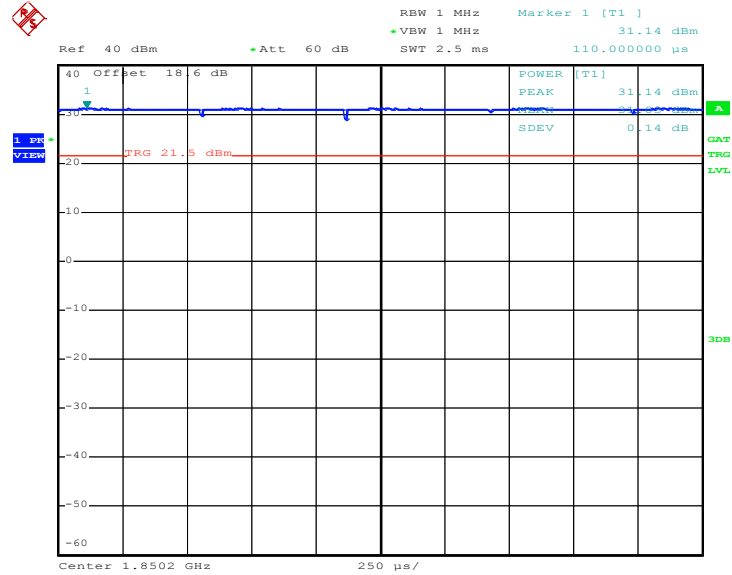

Date: 6.AUG.2012 14:23:53

Peak-to-Average Ratio on Channel 661 (1880.0 MHz)

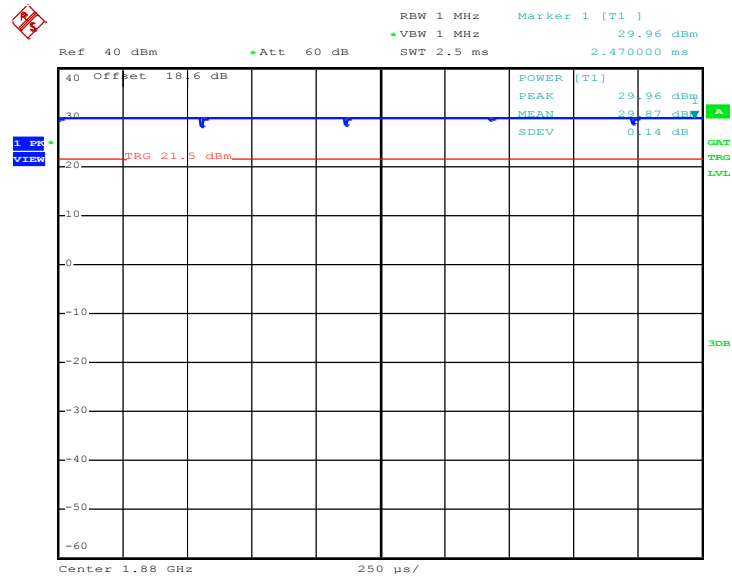

Date: 6.AUG.2012 14:23:15



Peak-to-Average Ratio on Channel 810 (1909.8 MHz)

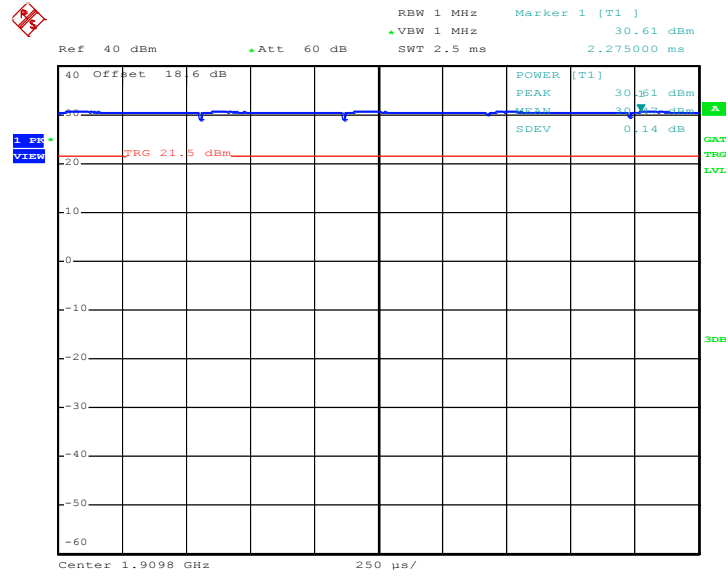

Date: 6.AUG.2012 14:22:42



Band :	GSM 1900	Test Mode :	EDGE 8 Link
--------	----------	-------------	-------------

Peak-to-Average Ratio on Channel 512 (1850.2 MHz)

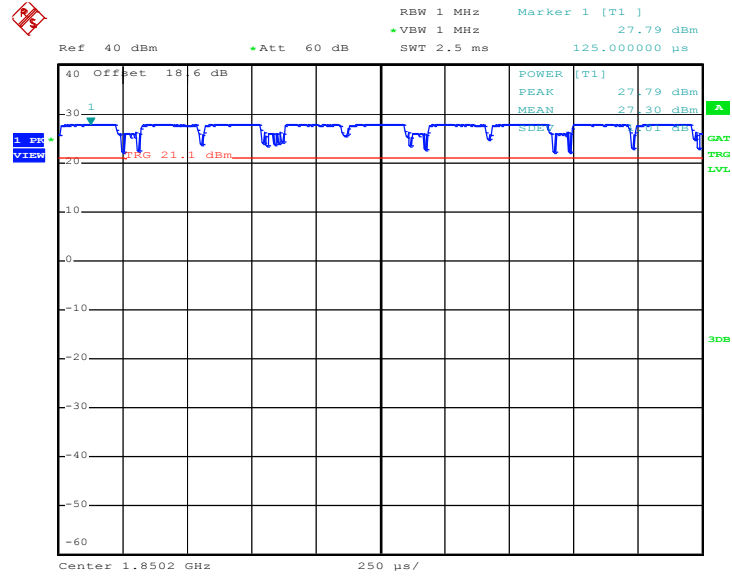

Date: 6.AUG.2012 13:43:14

Peak-to-Average Ratio on Channel 661 (1880.0 MHz)

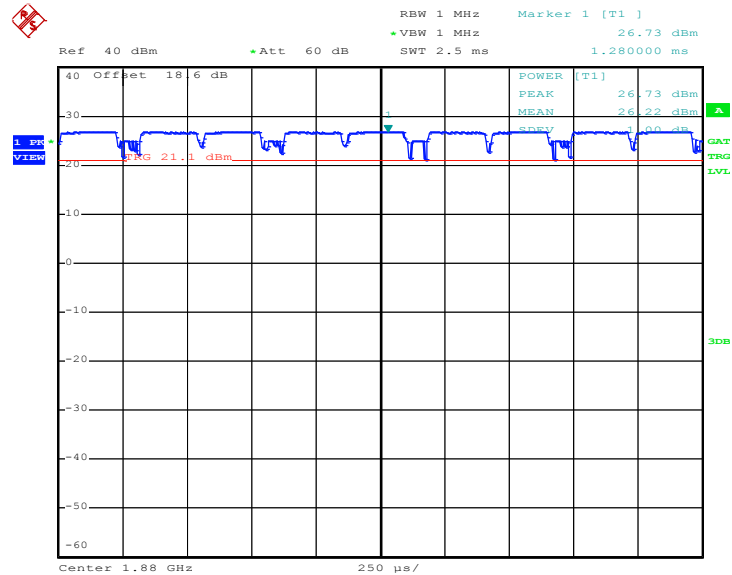

Date: 6.AUG.2012 13:42:27



Peak-to-Average Ratio on Channel 810 (1909.8 MHz)

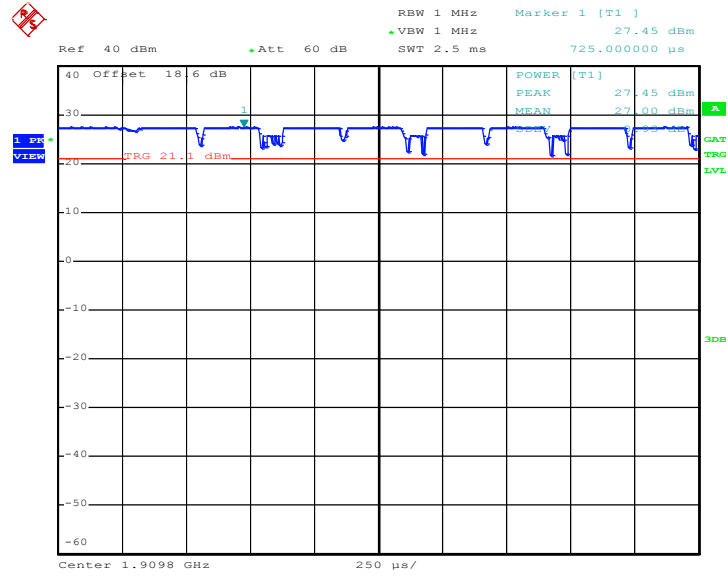

Date: 6.AUG.2012 13:41:36



Band :	WCDMA Band V	Test Mode :	RMC 12.2Kbps Link
---------------	--------------	--------------------	-------------------

Peak-to-Average Ratio on Channel 4132 (826.4 MHz)

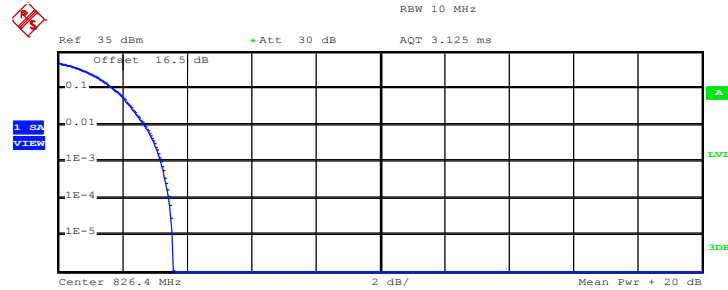

Complementary Cumulative Distribution Function (100000 samples)

Trace 1
Mean 23.33 dBm
Peak 26.93 dBm
Crest 3.60 dB

10 %	1.72 dB
1 %	2.72 dB
.1 %	3.20 dB
.01 %	3.44 dB

Date: 6.AUG.2012 10:57:38

Peak-to-Average Ratio on Channel 4182 (836.4 MHz)

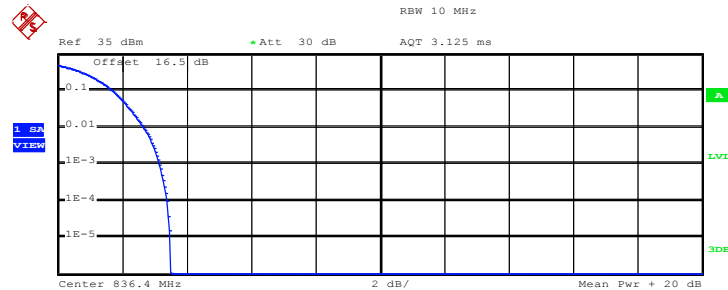

Complementary Cumulative Distribution Function (100000 samples)

Trace 1
Mean 23.78 dBm
Peak 27.28 dBm
Crest 3.50 dB

10 %	1.72 dB
1 %	2.68 dB
.1 %	3.16 dB
.01 %	3.40 dB

Date: 6.AUG.2012 10:56:54



Peak-to-Average Ratio on Channel 4233 (846.6 MHz)

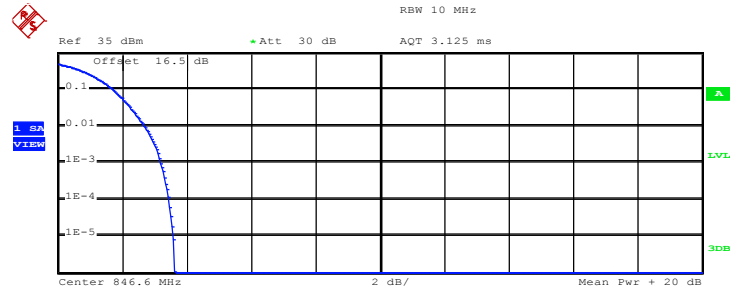

Complementary Cumulative Distribution Function (100000 samples)

Trace 1

Mean	23.10 dBm
Peak	26.72 dBm
Crest	3.62 dB
10 %	1.72 dB
1 %	2.72 dB
.1 %	3.20 dB
.01 %	3.44 dB

Date: 6.AUG.2012 10:55:54



Band :	WCDMA Band II	Test Mode :	RMC 12.2Kbps Link
---------------	---------------	--------------------	-------------------

Peak-to-Average Ratio on Channel 9262 (1852.4 MHz)

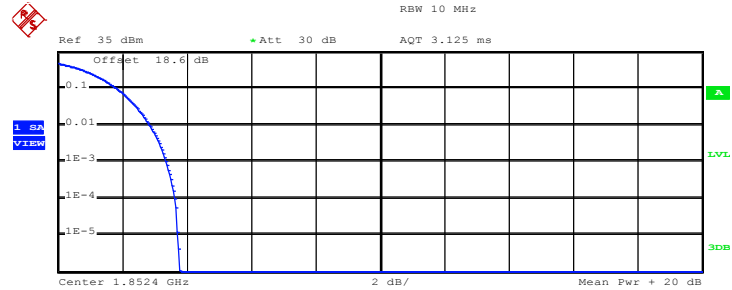

Complementary Cumulative Distribution Function (100000 samples)

Trace 1

Mean	23.71 dBm
Peak	27.49 dBm
Crest	3.79 dB
10 %	1.84 dB
1 %	2.88 dB
.1 %	3.36 dB
.01 %	3.64 dB

Date: 6.AUG.2012 15:07:24

Peak-to-Average Ratio on Channel 9400 (1880.0 MHz)

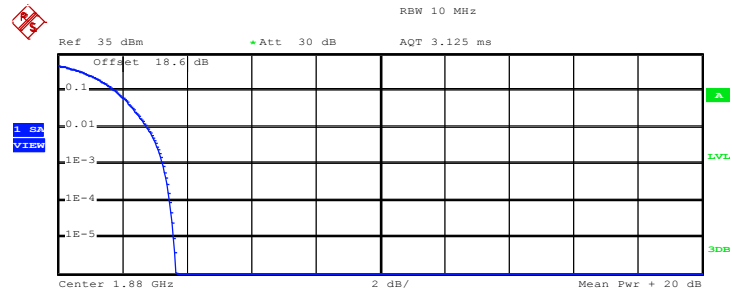

Complementary Cumulative Distribution Function (100000 samples)

Trace 1

Mean	23.97 dBm
Peak	27.63 dBm
Crest	3.66 dB
10 %	1.80 dB
1 %	2.76 dB
.1 %	3.28 dB
.01 %	3.48 dB

Date: 6.AUG.2012 15:06:44



Peak-to-Average Ratio on Channel 9538 (1907.6 MHz)

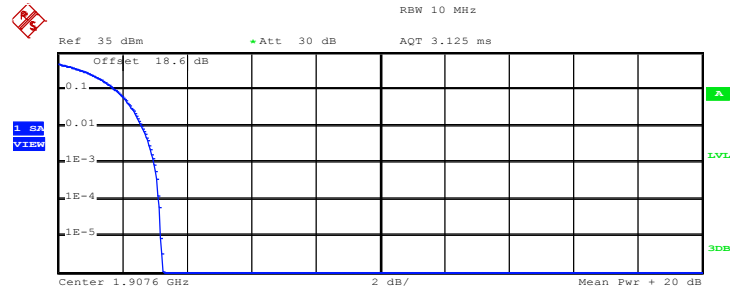

Complementary Cumulative Distribution Function (100000 samples)

Trace 1	
Mean	23.60 dBm
Peak	26.86 dBm
Crest	3.26 dB
10 %	1.80 dB
1 %	2.60 dB
.1 %	3.00 dB
.01 %	3.12 dB

Date: 6.AUG.2012 15:08:07

3.3 Occupied Bandwidth and 26dB Bandwidth Measurement

3.3.1 Description of Occupied Bandwidth and 26dB Bandwidth Measurement

The occupied bandwidth is the width of a frequency band such that, below the lower and above the upper frequency limits, the mean powers emitted are each equal to a specified percentage 0.5% of the total mean transmitted power.

The emission bandwidth is defined as the width of the signal between two points, located at the 2 sides of the carrier frequency, outside of which all emissions are attenuated at least 26 dB below the transmitter power.

3.3.2 Measuring Instruments

See list of measuring instruments of this test report.

3.3.3 Test Procedures

1. The EUT was connected to Spectrum Analyzer and Base Station via power divider.
2. The 99% occupied bandwidth and 26 dB bandwidth of the middle channel for the highest RF powers were measured.

3.3.4 Test Setup

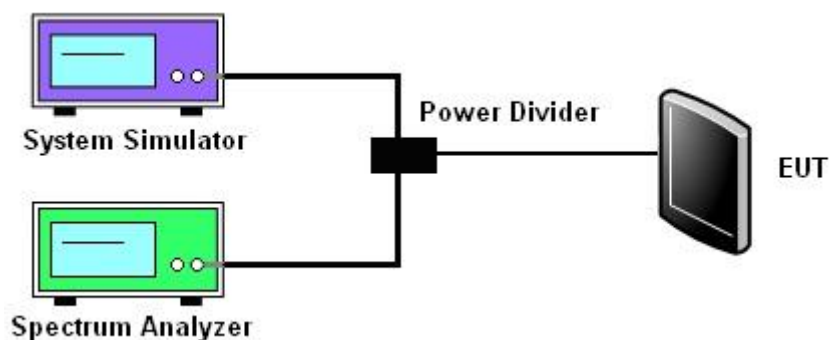

3.3.5 Test Result of Occupied Bandwidth and 26dB Bandwidth

Cellular Band						
Modes	GSM850 (GPRS 8)			GSM850 (EDGE 8)		
Channel	128 (Low)	189 (Mid)	251 (High)	128 (Low)	189 (Mid)	251 (High)
Frequency (MHz)	824.2	836.4	848.8	824.2	836.4	848.8
99% OBW (KHz)	250.00	242.00	246.00	246.00	236.00	246.00
26dB BW (KHz)	310.00	318.00	314.00	314.00	304.00	302.00

PCS Band						
Modes	GSM1900 (GPRS 8)			GSM1900 (EDGE 8)		
Channel	512 (Low)	661 (Mid)	810 (High)	512 (Low)	661 (Mid)	810 (High)
Frequency (MHz)	1850.2	1880	1909.8	1850.2	1880	1909.8
99% OBW (KHz)	242.00	244.00	246.00	248.00	238.00	242.00
26dB BW (KHz)	316.00	306.00	306.00	304.00	306.00	296.00

Cellular Band			
Modes	WCDMA Band V (RMC 12.2Kbps)		
Channel	4132 (Low)	4182 (Mid)	4233 (High)
Frequency (MHz)	826.4	836.4	846.6
99% OBW (MHz)	4.18	4.14	4.14
26dB BW (MHz)	4.68	4.68	4.66

PCS Band			
Modes	WCDMA Band II (RMC 12.2Kbps)		
Channel	9262 (Low)	9400 (Mid)	9538 (High)
Frequency (MHz)	1852.4	1880	1907.6
99% OBW (MHz)	4.16	4.14	4.16
26dB BW (MHz)	4.66	4.68	4.66



3.3.6 Test Result (Plots) of Occupied Bandwidth and 26dB Bandwidth

Band :	GSM 850	Test Mode :	GPRS 8 Link
--------	---------	-------------	-------------

99% Occupied Bandwidth Plot on Channel 128 (824.2 MHz)

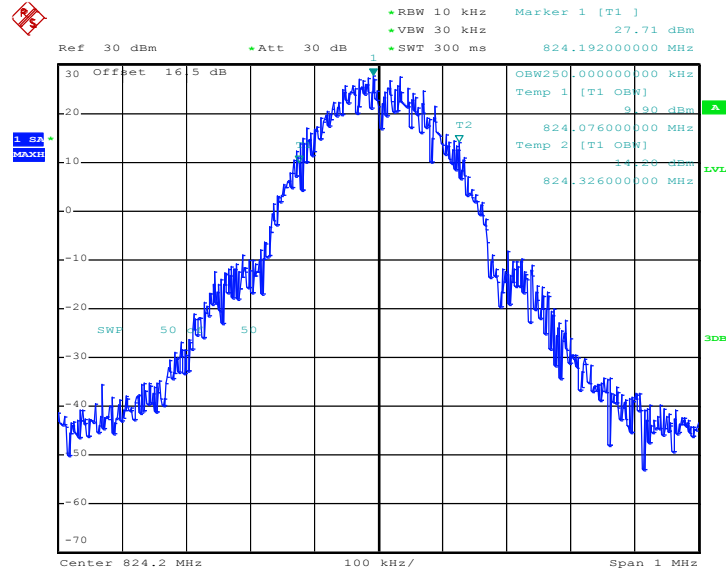

Date: 6.AUG.2012 10:12:07

26dB Bandwidth Plot on Channel 128 (824.2 MHz)

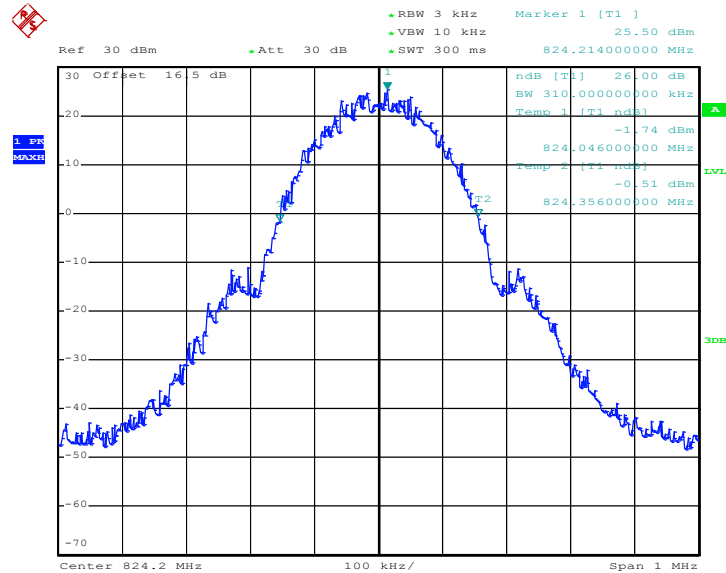

Date: 6.AUG.2012 10:09:37



99% Occupied Bandwidth Plot on Channel 189 (836.4 MHz)

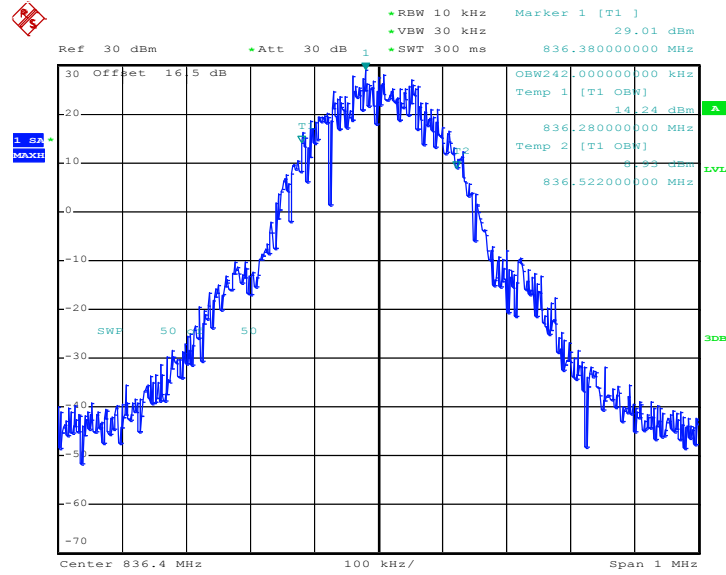

Date: 6.AUG.2012 10:12:27

26dB Bandwidth Plot on Channel 189 (836.4 MHz)

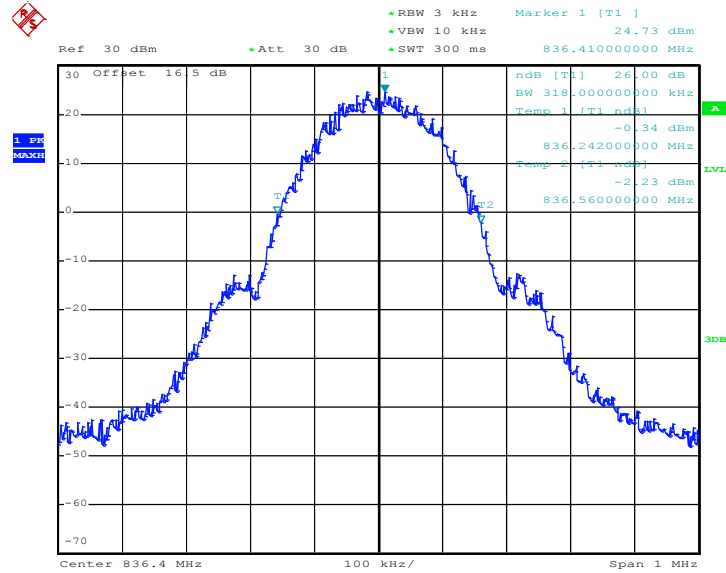

Date: 6.AUG.2012 10:10:03



99% Occupied Bandwidth Plot on Channel 251 (848.8 MHz)

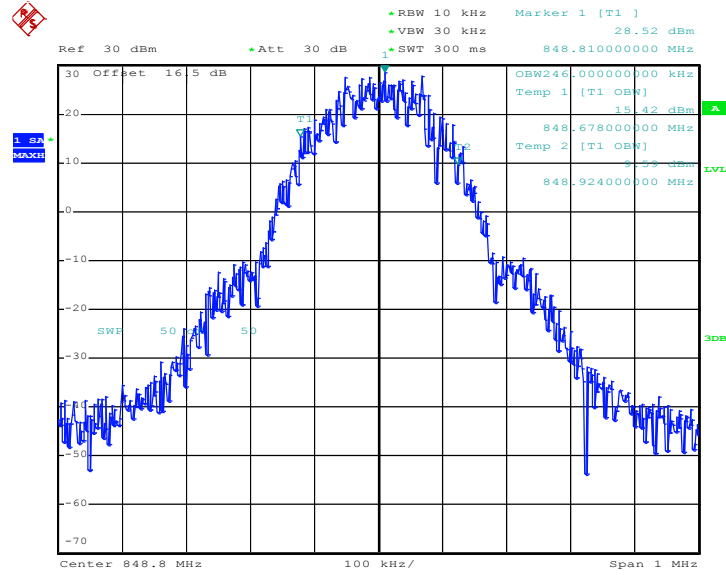

Date: 6.AUG.2012 10:12:47

26dB Bandwidth Plot on Channel 251 (848.8 MHz)

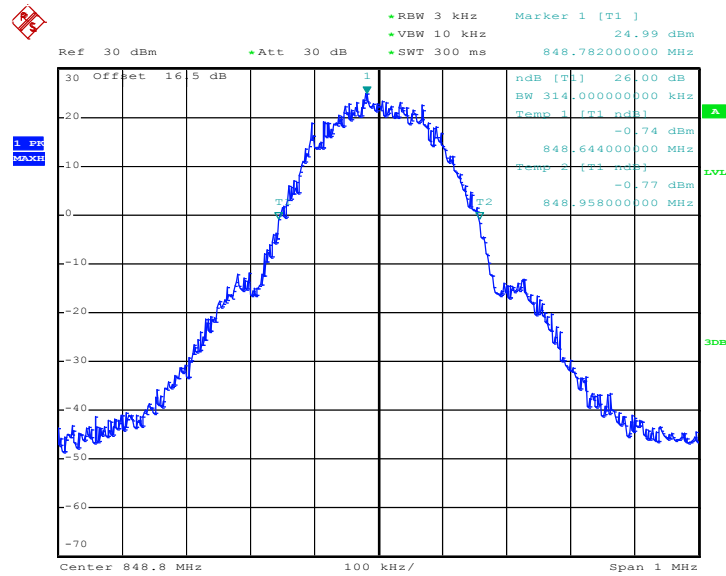

Date: 6.AUG.2012 10:10:29



Band :	GSM 850	Test Mode :	EDGE 8 Link
--------	---------	-------------	-------------

99% Occupied Bandwidth Plot on Channel 128 (824.2 MHz)

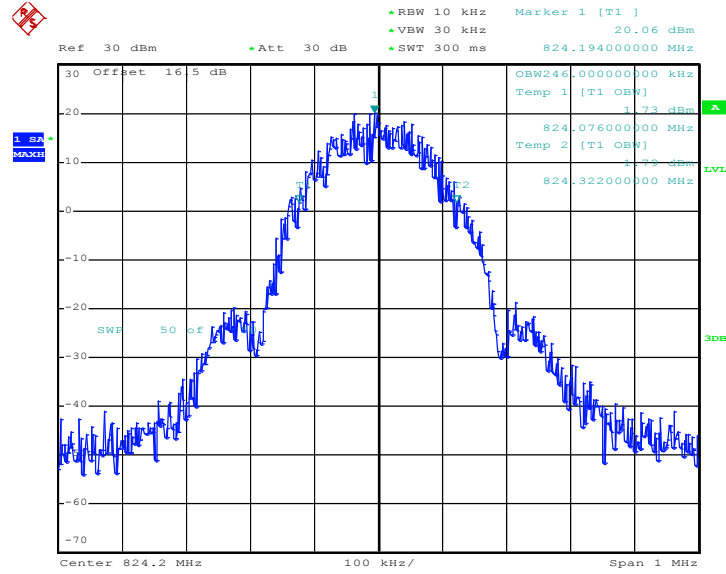

Date: 6.AUG.2012 10:28:32

26dB Bandwidth Plot on Channel 128 (824.2 MHz)

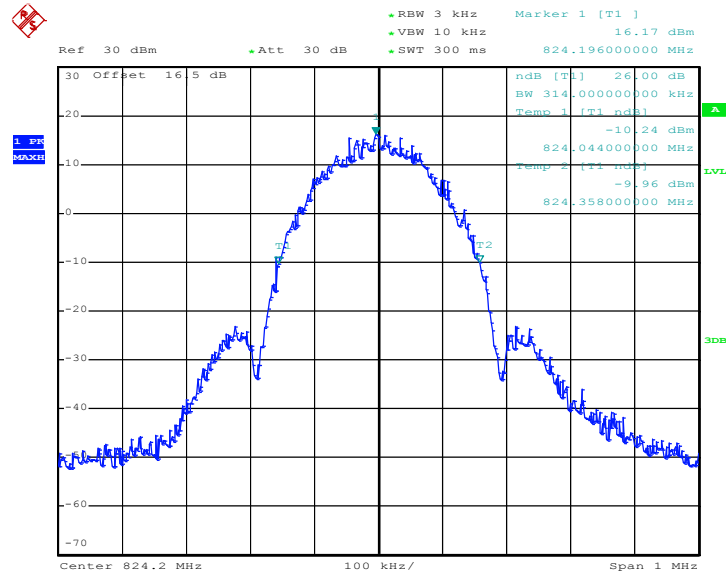

Date: 6.AUG.2012 10:26:01



99% Occupied Bandwidth Plot on Channel 189 (836.4 MHz)

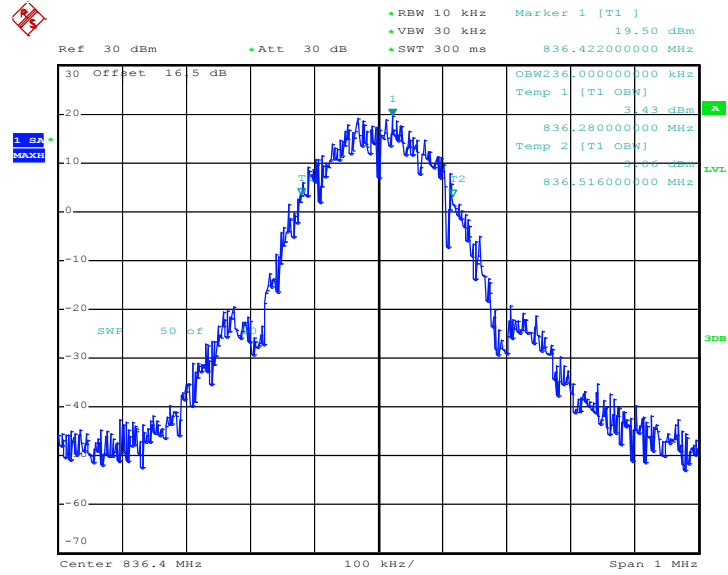

Date: 6.AUG.2012 10:28:52

26dB Bandwidth Plot on Channel 189 (836.4 MHz)

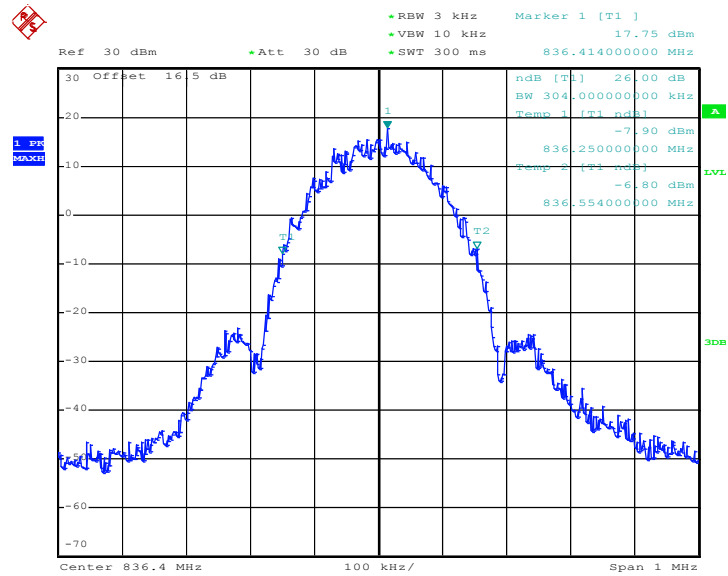

Date: 6.AUG.2012 10:26:28



99% Occupied Bandwidth Plot on Channel 251 (848.8 MHz)

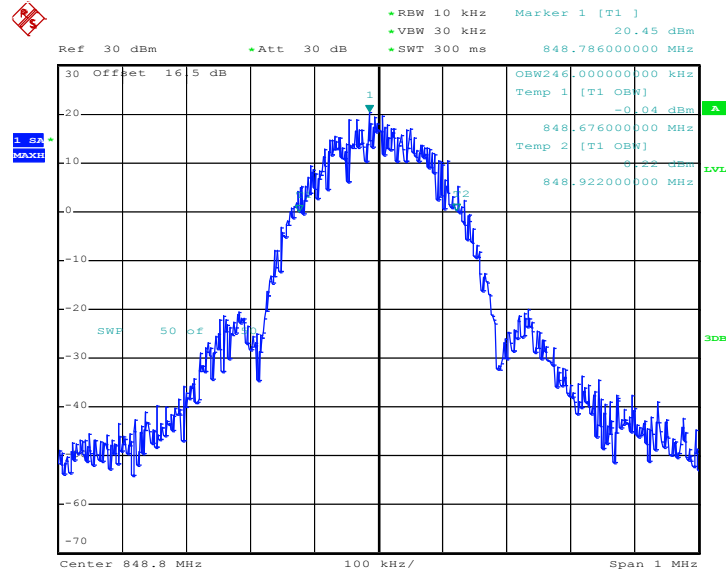

Date: 6.AUG.2012 10:29:11

26dB Bandwidth Plot on Channel 251 (848.8 MHz)

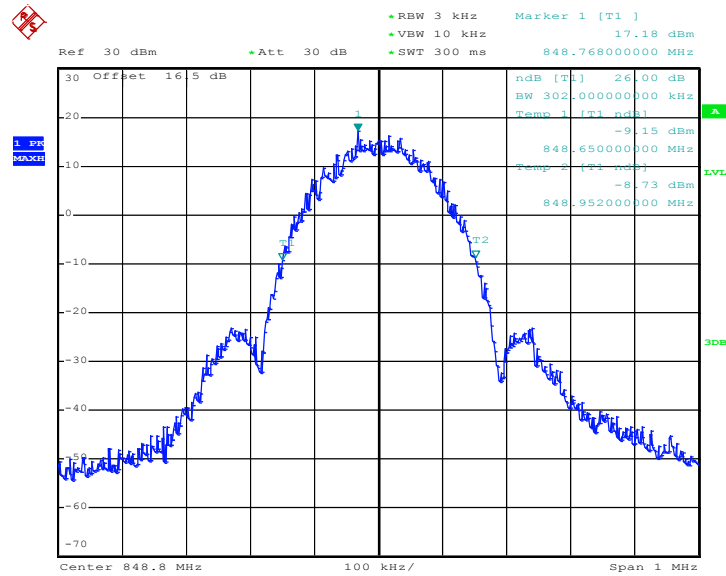

Date: 6.AUG.2012 10:26:54



Band :	GSM 1900	Test Mode :	GPRS 8 Link
--------	----------	-------------	-------------

99% Occupied Bandwidth Plot on Channel 512 (1850.2 MHz)

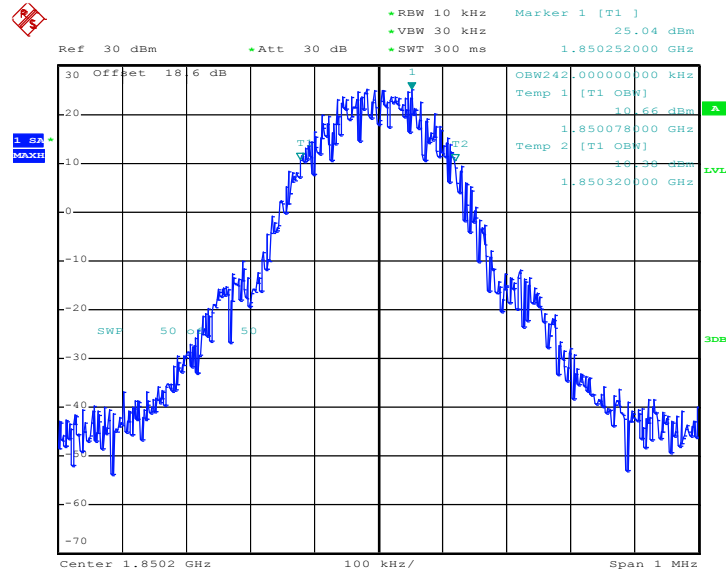

Date: 6.AUG.2012 14:34:47

26dB Bandwidth Plot on Channel 512 (1850.2 MHz)

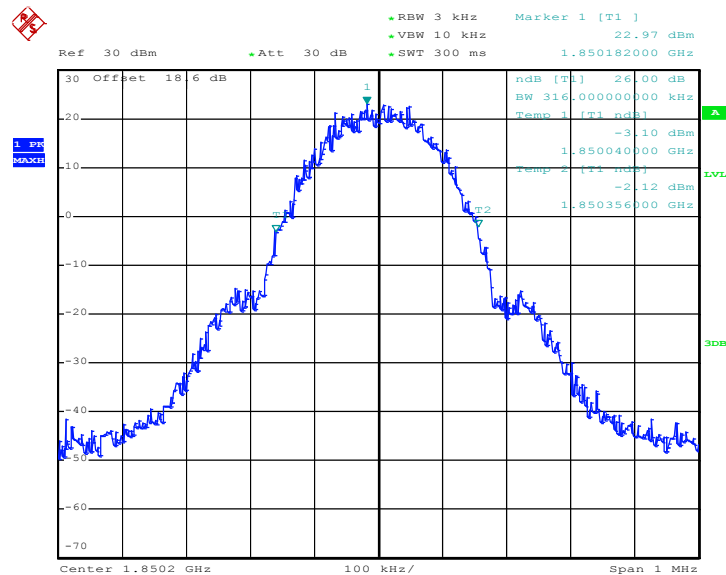

Date: 6.AUG.2012 14:26:52



99% Occupied Bandwidth Plot on Channel 661 (1880.0 MHz)

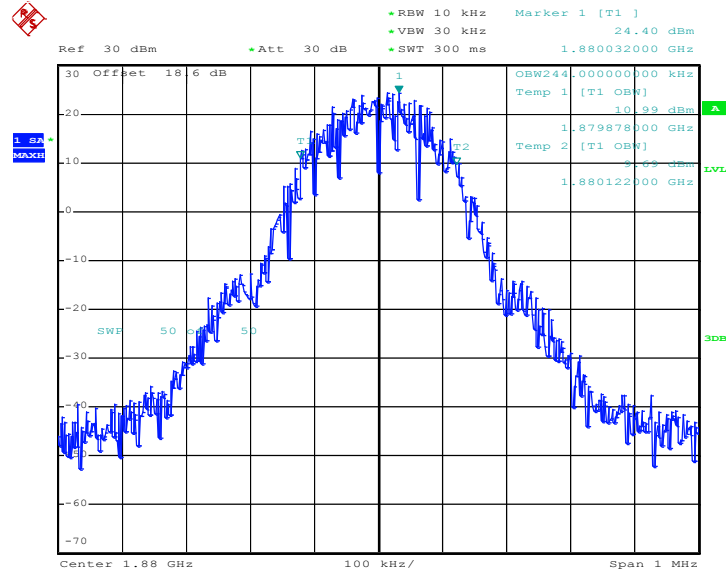

Date: 6.AUG.2012 14:35:06

26dB Bandwidth Plot on Channel 661 (1880.0 MHz)

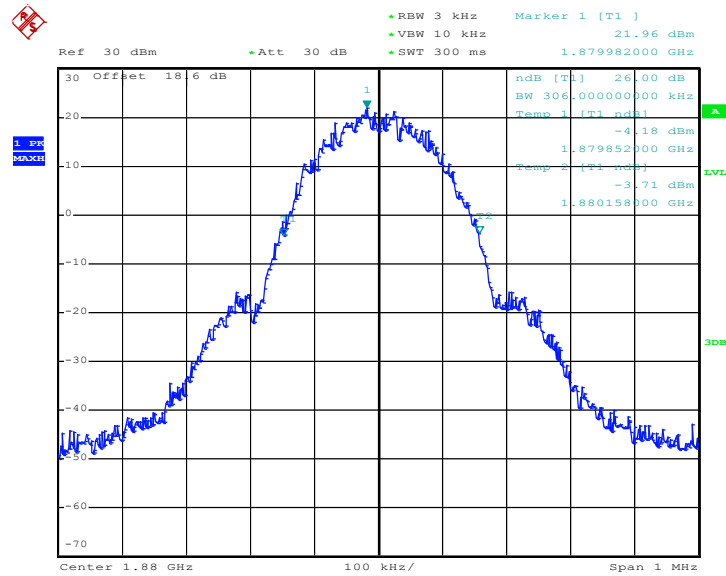

Date: 6.AUG.2012 14:27:18



99% Occupied Bandwidth Plot on Channel 810 (1909.8 MHz)

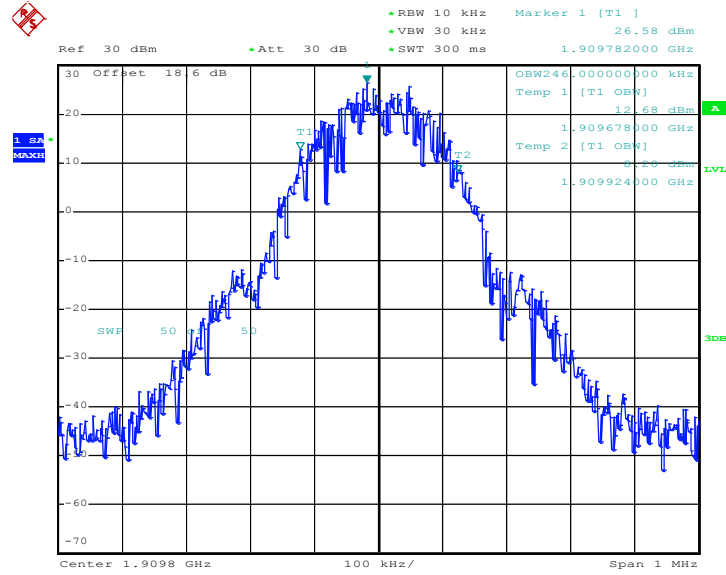

Date: 6.AUG.2012 14:35:26

26dB Bandwidth Plot on Channel 810 (1909.8 MHz)

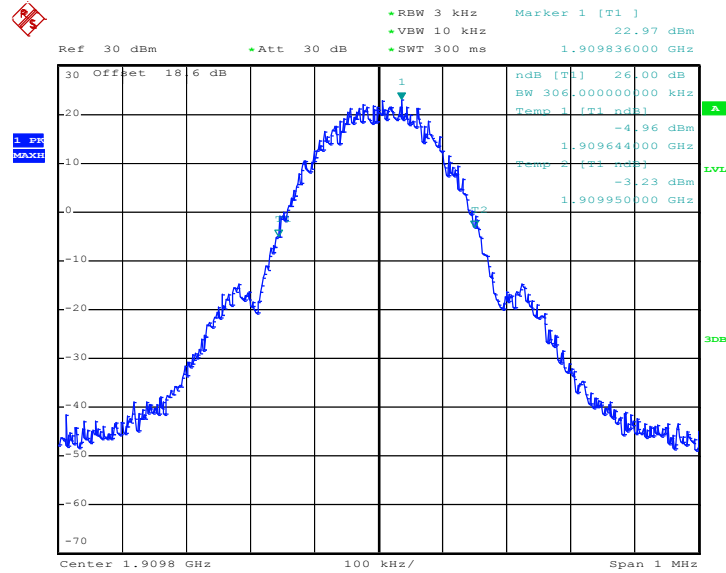

Date: 6.AUG.2012 14:27:44



Band :	GSM 1900	Test Mode :	EDGE 8 Link
--------	----------	-------------	-------------

99% Occupied Bandwidth Plot on Channel 512 (1850.2 MHz)

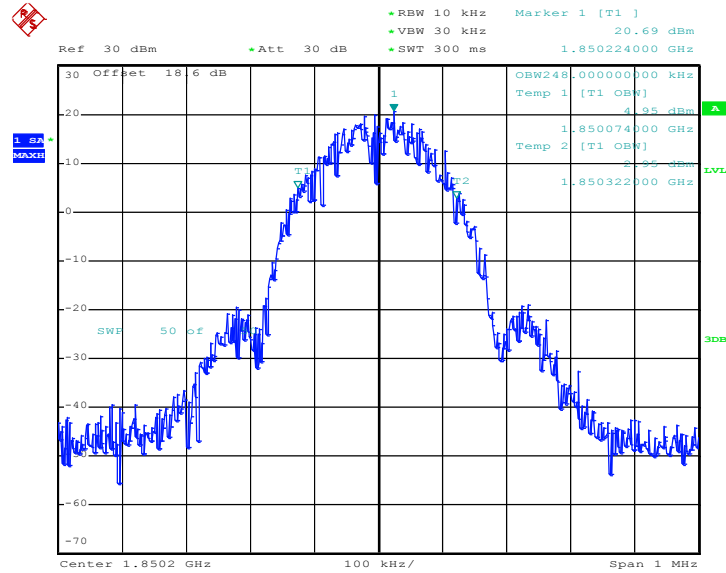

Date: 6.AUG.2012 13:38:41

26dB Bandwidth Plot on Channel 512 (1850.2 MHz)

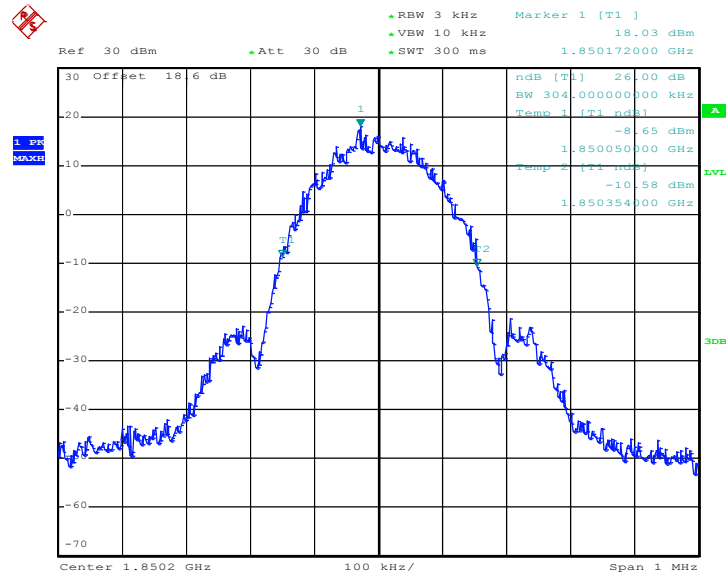

Date: 6.AUG.2012 13:33:02



99% Occupied Bandwidth Plot on Channel 661 (1880.0 MHz)

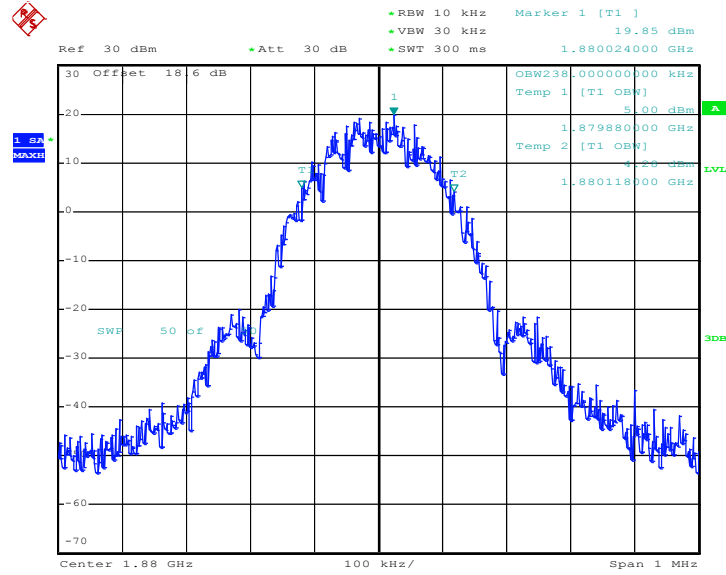

Date: 6.AUG.2012 13:39:01

26dB Bandwidth Plot on Channel 661 (1880.0 MHz)

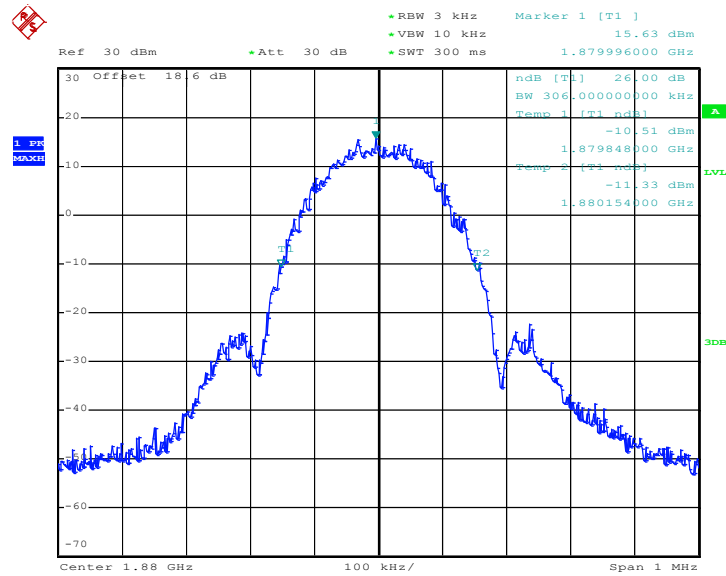

Date: 6.AUG.2012 13:33:29



99% Occupied Bandwidth Plot on Channel 810 (1909.8 MHz)

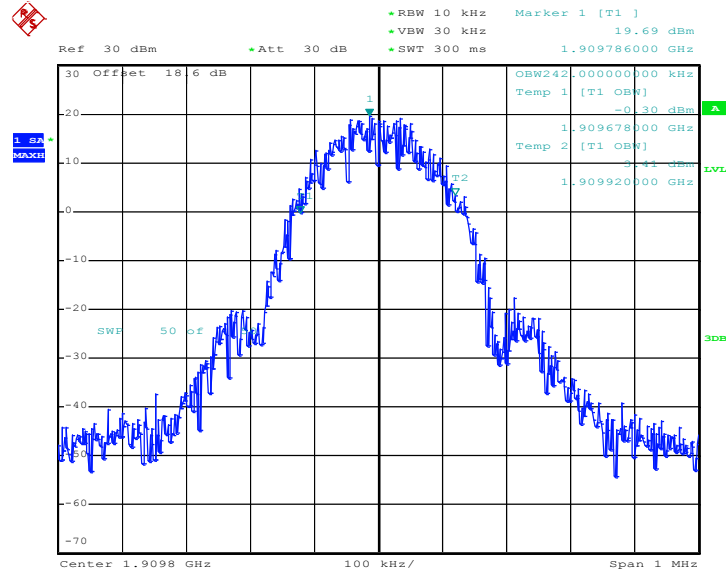

Date: 6.AUG.2012 13:39:20

26dB Bandwidth Plot on Channel 810 (1909.8 MHz)

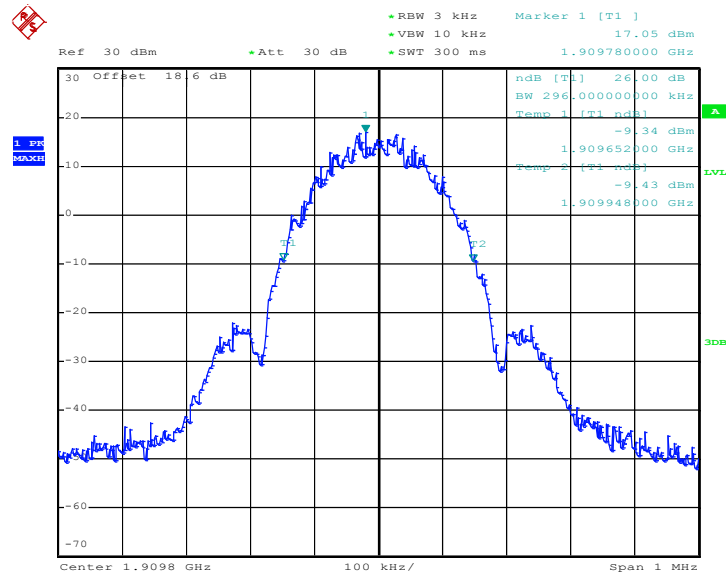

Date: 6.AUG.2012 13:33:55



Band :	WCDMA Band V	Test Mode :	RMC 12.2Kbps Link
--------	--------------	-------------	-------------------

99% Occupied Bandwidth Plot on Channel 4132 (826.4 MHz)

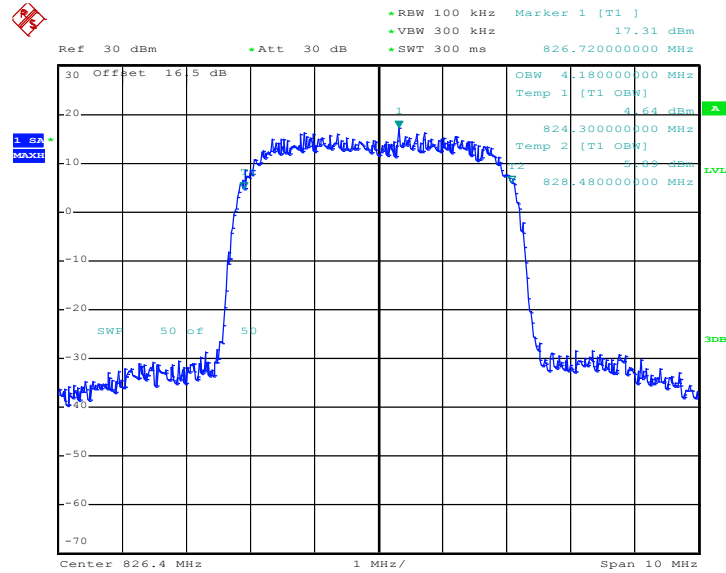

Date: 6.AUG.2012 10:51:38

26dB Bandwidth Plot on Channel 4132 (826.4 MHz)

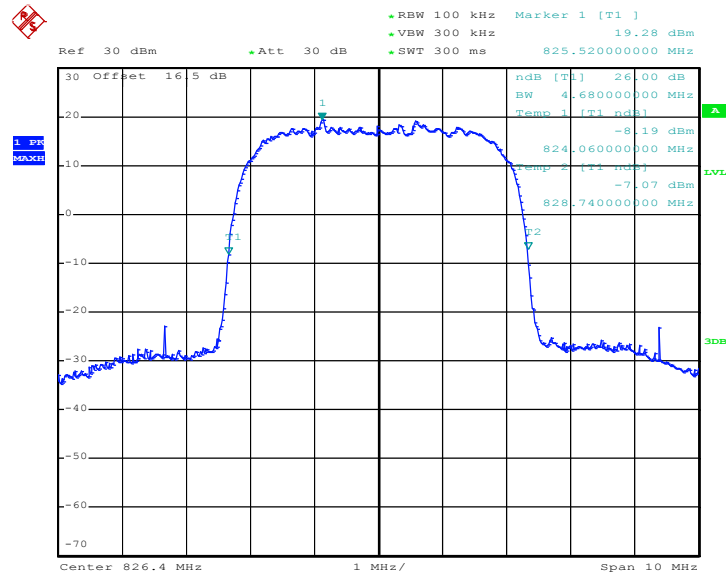

Date: 6.AUG.2012 10:49:07



99% Occupied Bandwidth Plot on Channel 4182 (836.4 MHz)

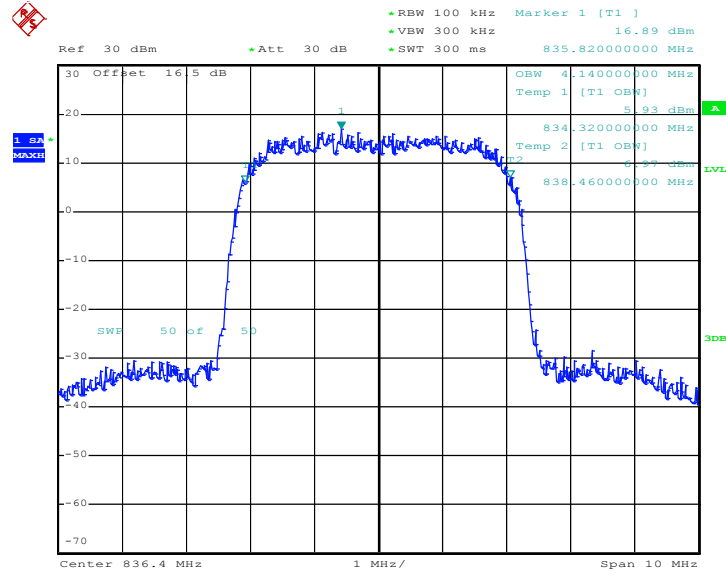

Date: 6.AUG.2012 10:51:59

26dB Bandwidth Plot on Channel 4182 (836.4 MHz)

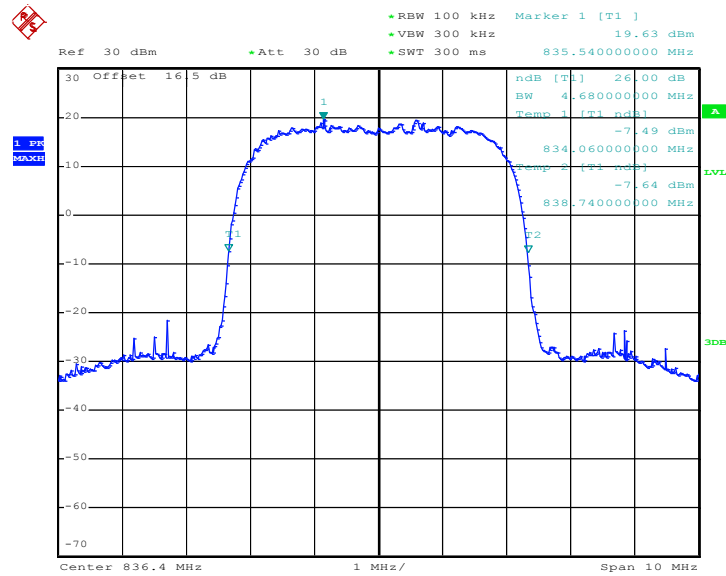

Date: 6.AUG.2012 10:49:33



99% Occupied Bandwidth Plot on Channel 4233 (846.6 MHz)

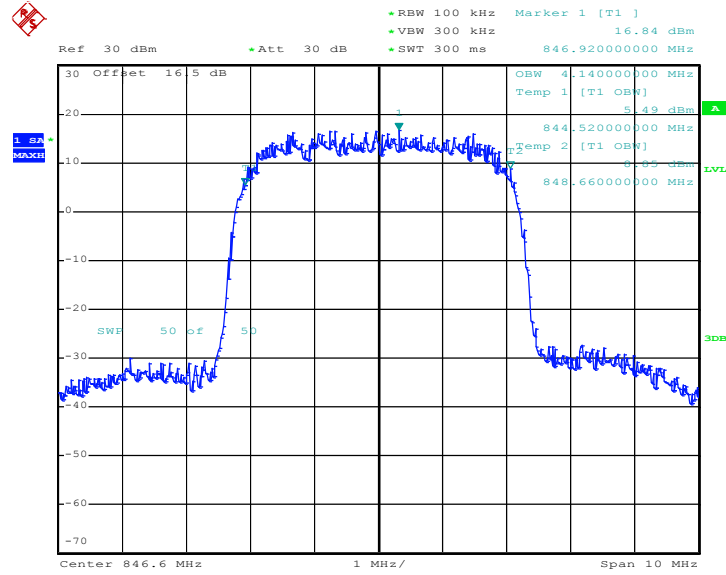

Date: 6.AUG.2012 10:52:19

26dB Bandwidth Plot on Channel 4233 (846.6 MHz)

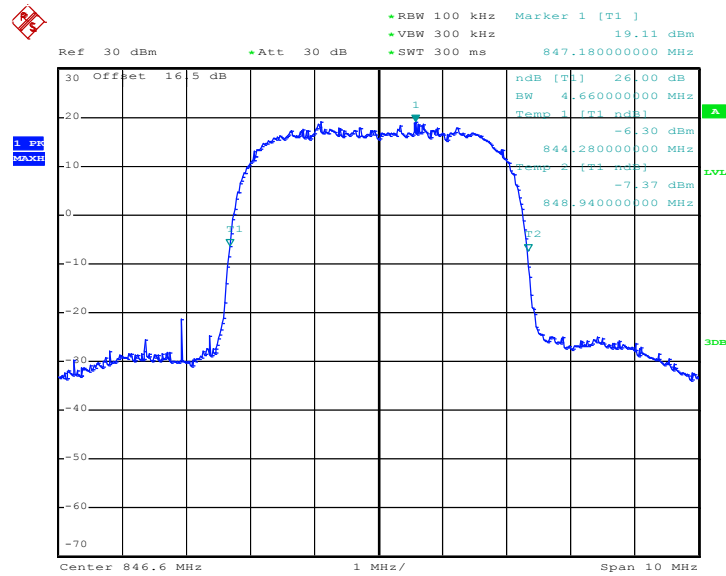

Date: 6.AUG.2012 10:50:00



Band :	WCDMA Band II	Test Mode :	RMC 12.2Kbps Link
--------	---------------	-------------	-------------------

99% Occupied Bandwidth Plot on Channel 9262 (1852.4 MHz)

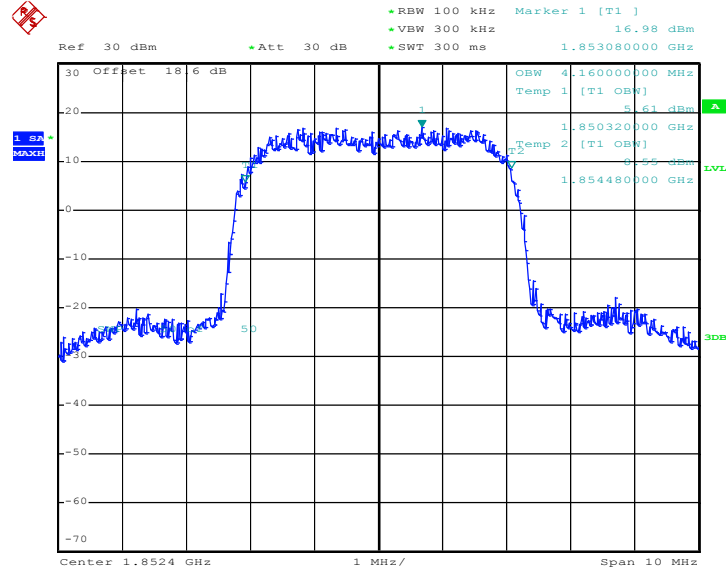

Date: 6.AUG.2012 15:02:12

26dB Bandwidth Plot on Channel 9262 (1852.4 MHz)

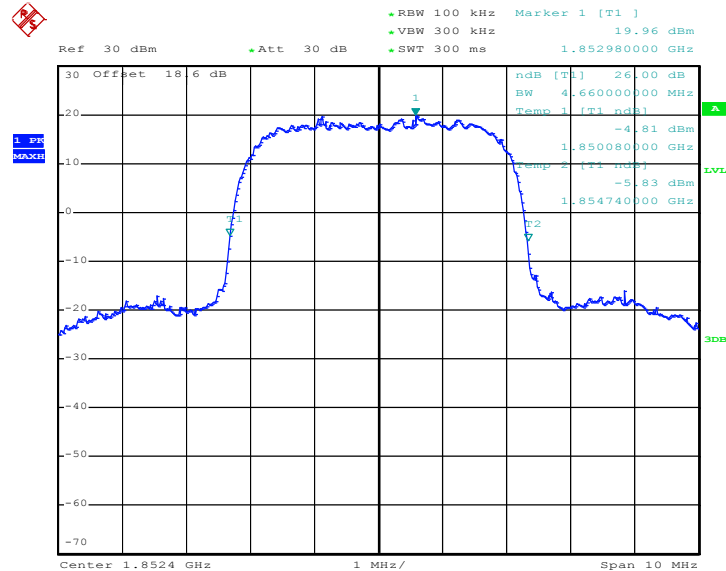

Date: 6.AUG.2012 14:59:41



99% Occupied Bandwidth Plot on Channel 9400 (1880.0 MHz)

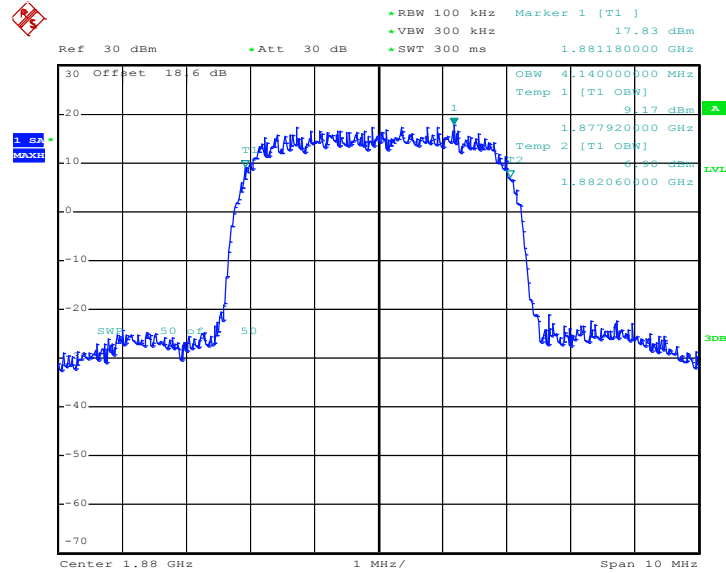

Date: 6.AUG.2012 15:02:32

26dB Bandwidth Plot on Channel 9400 (1880.0 MHz)

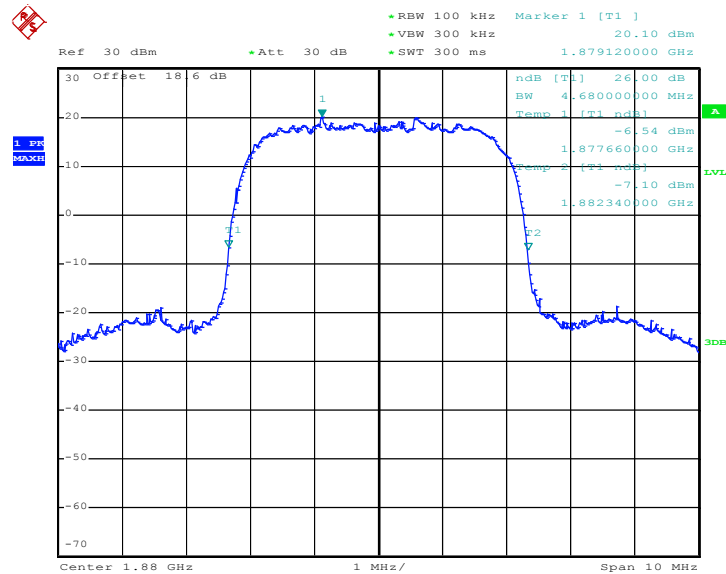

Date: 6.AUG.2012 15:00:07



99% Occupied Bandwidth Plot on Channel 9538 (1907.6 MHz)

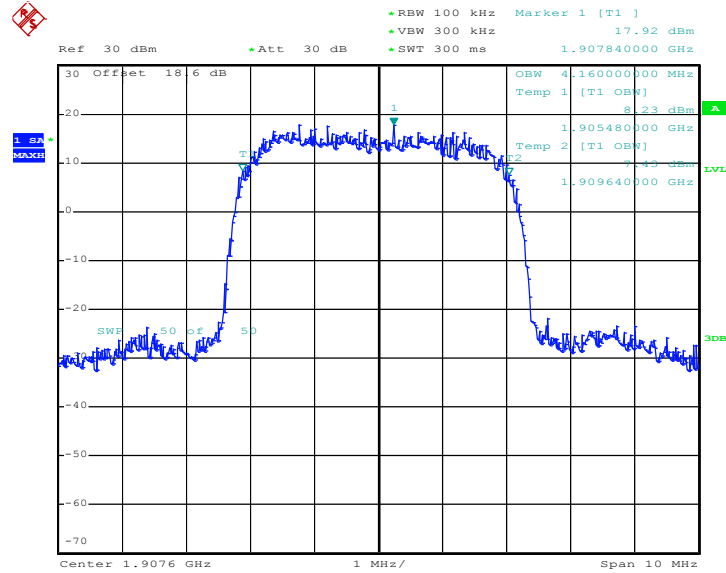

Date: 6.AUG.2012 15:02:53

26dB Bandwidth Plot on Channel 9538 (1907.6 MHz)

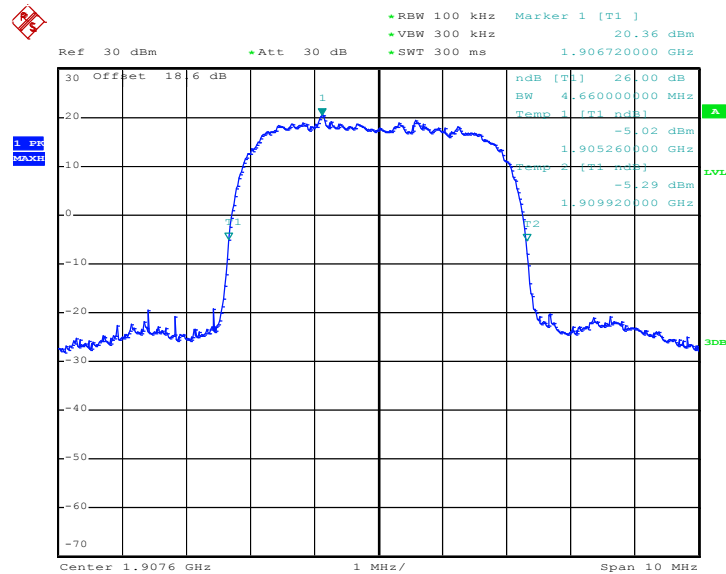

Date: 6.AUG.2012 15:00:33

3.4 Band Edge Measurement

3.4.1 Description of Band Edge Measurement

The power of any emission outside of the authorized operating frequency ranges must be lower than the transmitter power (P) by a factor of at least $43 + 10 \log (P)$ dB.

3.4.2 Measuring Instruments

See list of measuring instruments of this test report.

3.4.3 Test Procedures

1. The EUT was connected to Spectrum Analyzer and Base Station via power divider.
2. The band edges of low and high channels for the highest RF powers were measured. Setting RBW as roughly $BW/100$.

3.4.4 Test Setup

<Conducted Band Edge >

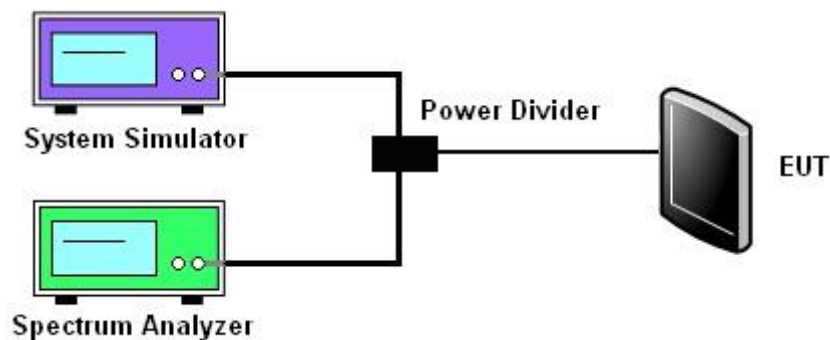

3.4.5 Test Result (Plots) of Conducted Band Edge

Band :	GSM850	Test Mode :	GPRS 8 Link
Correction Factor :	0.25dB	Maximum 26dB Bandwidth :	0.318MHz
Band Edge :	-15.97dBm	Measurement Value :	-16.22dBm

Lower Band Edge Plot on Channel 128 (824.2 MHz)

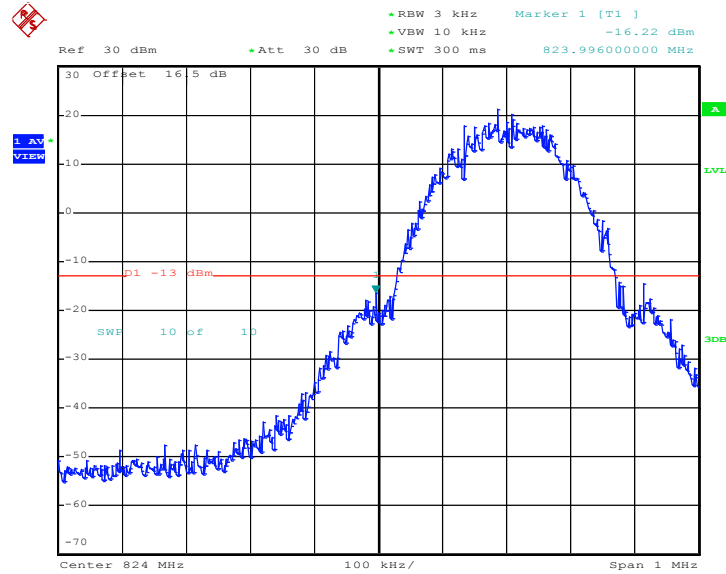

Date: 6.AUG.2012 10:14:09

1. Correction Factor(dB)= $10\log(1\% \text{ Emission BW/RBW})$
 2. Band Edge= Measurement Value + Correction Factor(dB)
- For example, $-16.22\text{dBm} + 0.25\text{dB} = -15.97\text{dBm}$



Band :	GSM850	Test Mode :	GPRS 8 Link
Correction Factor :	0.25dB	Maximum 26dB Bandwidth :	0.318MHz
Band Edge :	-14.63dBm	Measurement Value :	-14.88dBm

Higher Band Edge Plot on Channel 251 (848.8 MHz)

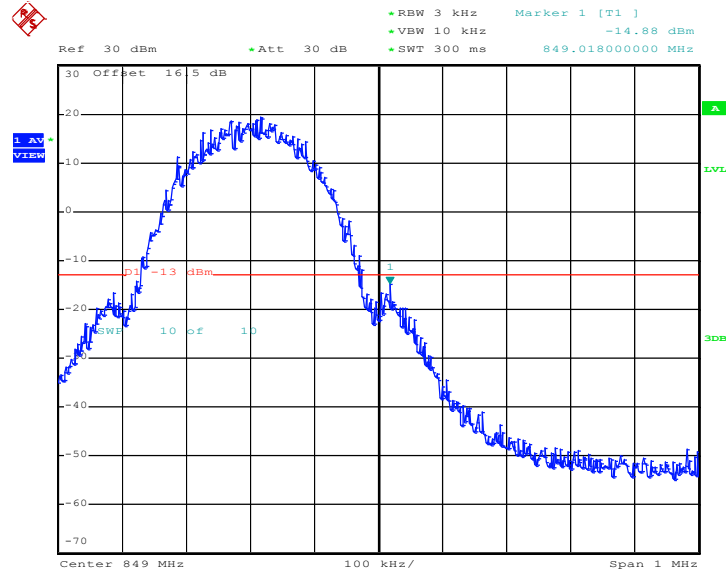

Date: 6.AUG.2012 10:14:39

1. Correction Factor(dB)= $10\log(1\% \text{ Emission BW/RBW})$
2. Band Edge= Measurement Value + Correction Factor(dB)



Band :	GSM850	Test Mode :	EDGE 8 Link
Correction Factor :	0.20dB	Maximum 26dB Bandwidth :	0.314MHz
Band Edge :	-27.25dBm	Measurement Value :	-27.45dBm

Lower Band Edge Plot on Channel 128 (824.2 MHz)

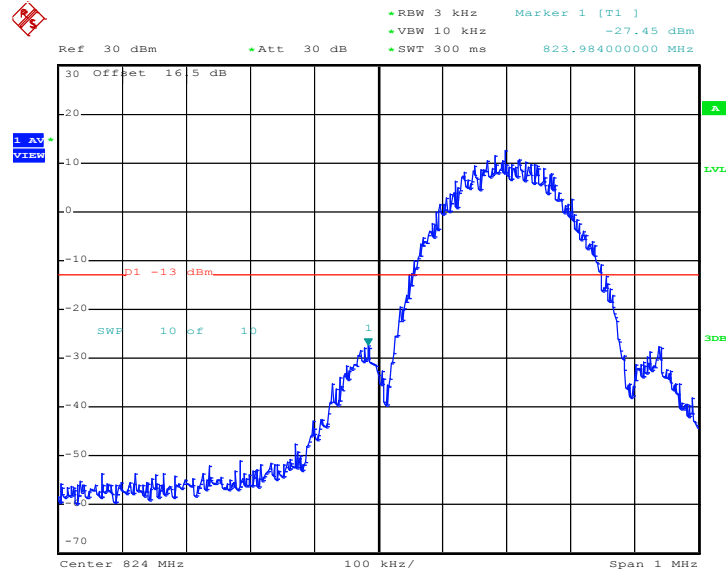

Date: 6.AUG.2012 10:30:34

1. Correction Factor(dB)= $10\log(1\% \text{ Emission BW/RBW})$
2. Band Edge= Measurement Value + Correction Factor(dB)



Band :	GSM850	Test Mode :	EDGE 8 Link
Correction Factor :	0.20dB	Maximum 26dB Bandwidth :	0.314MHz
Band Edge :	-28.32dBm	Measurement Value :	-28.52dBm

Higher Band Edge Plot on Channel 251 (848.8 MHz)

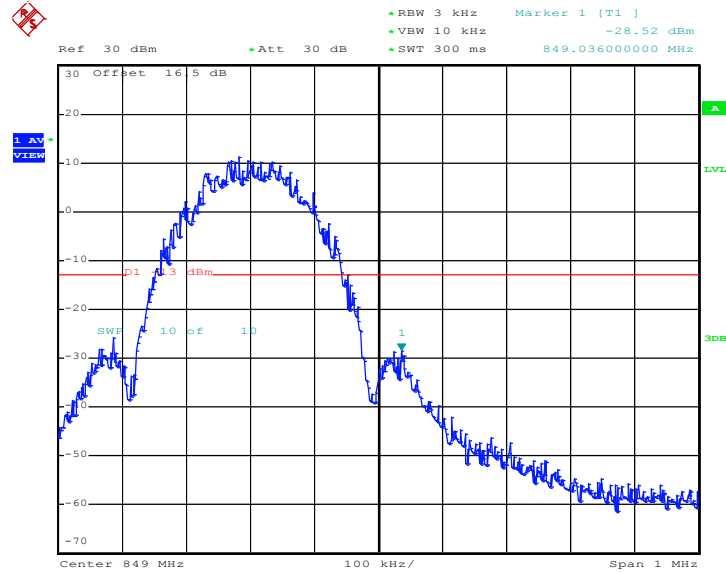

Date: 6.AUG.2012 10:31:03

1. Correction Factor(dB)= $10\log(1\% \text{ Emission BW/RBW})$
2. Band Edge= Measurement Value + Correction Factor(dB)



Band :	GSM1900	Test Mode :	GPRS 8 Link
Correction Factor :	0.23dB	Maximum 26dB Bandwidth :	0.316MHz
Band Edge :	-19.89dBm	Measurement Value :	-20.12dBm

Lower Band Edge Plot on Channel 512 (1850.2 MHz)

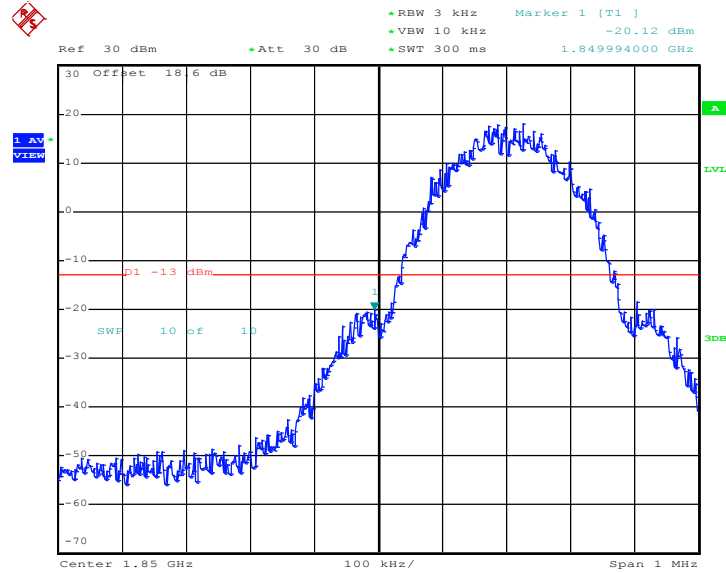

Date: 6.AUG.2012 14:31:24

1. Correction Factor(dB)= 10log(1% Emission BW/RBW)
2. Band Edge= Measurement Value + Correction Factor(dB)



Band :	GSM1900	Test Mode :	GPRS 8 Link
Correction Factor :	0.23dB	Maximum 26dB Bandwidth :	0.316MHz
Band Edge :	-20.08dBm	Measurement Value :	-20.31dBm

Higher Band Edge Plot on Channel 810 (1909.8 MHz)

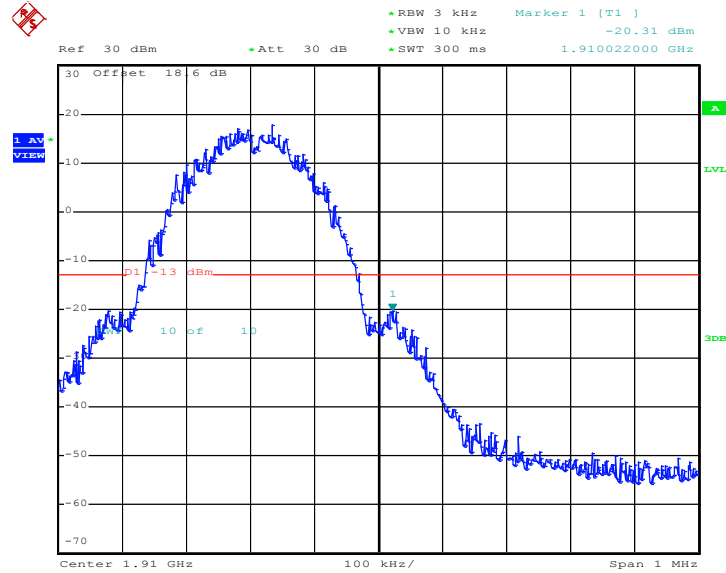

Date: 6.AUG.2012 14:31:54

1. Correction Factor(dB)= $10\log(1\% \text{ Emission BW/RBW})$
2. Band Edge= Measurement Value + Correction Factor(dB)



Band :	GSM1900	Test Mode :	EDGE 8 Link
Correction Factor :	0.09dB	Maximum 26dB Bandwidth :	0.306MHz
Band Edge :	-27.21dBm	Measurement Value :	-27.30dBm

Lower Band Edge Plot on Channel 512 (1850.2 MHz)

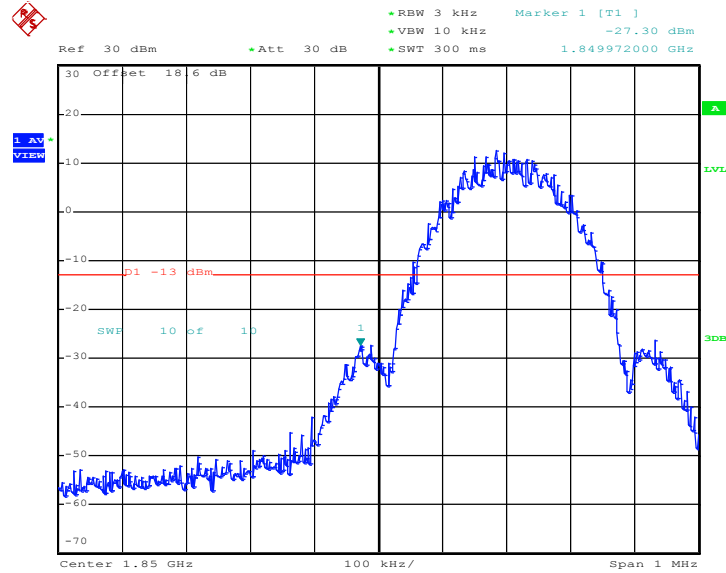

Date: 6.AUG.2012 13:37:35

1. Correction Factor(dB)= $10\log(1\% \text{ Emission BW/RBW})$
2. Band Edge= Measurement Value + Correction Factor(dB)



Band :	GSM1900	Test Mode :	EDGE 8 Link
Correction Factor :	0.09dB	Maximum 26dB Bandwidth :	0.306MHz
Band Edge :	-26.97dBm	Measurement Value :	-27.06dBm

Higher Band Edge Plot on Channel 810 (1909.8 MHz)

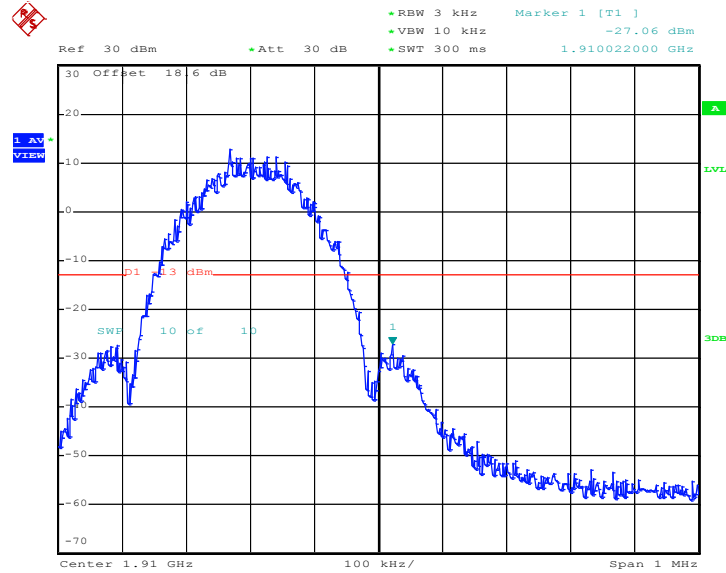

Date: 6.AUG.2012 13:38:04

1. Correction Factor(dB)= $10\log(1\% \text{ Emission BW/RBW})$
2. Band Edge= Measurement Value + Correction Factor(dB)



Band :	WCDMA Band V	Test Mode :	RMC 12.2Kbps Link
Correction Factor :	-3.30dB	Maximum 26dB Bandwidth :	4.680MHz
Band Edge :	-31.14dBm	Measurement Value :	-27.84dBm

Lower Band Edge Plot on Channel 4132 (826.4 MHz)

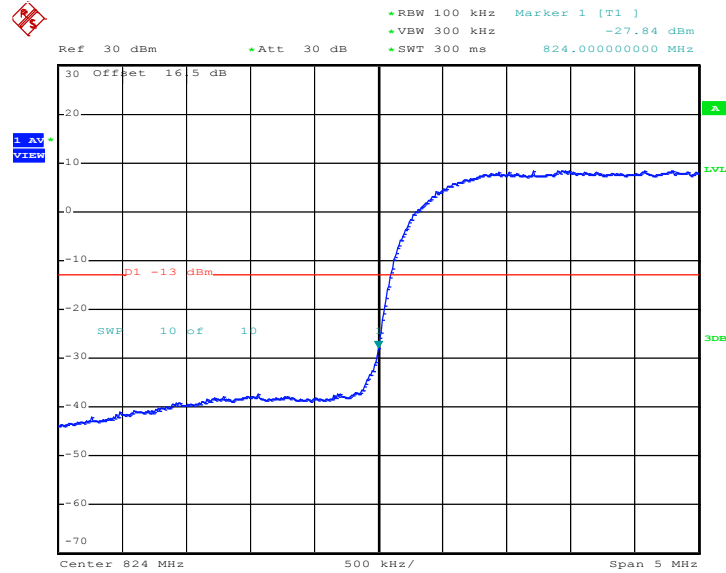

Date: 6.AUG.2012 10:53:42

1. Correction Factor(dB)= $10\log(1\% \text{ Emission BW/RBW})$
2. Band Edge= Measurement Value + Correction Factor(dB)



Band :	WCDMA Band V	Test Mode :	RMC 12.2Kbps Link
Correction Factor :	-3.30dB	Maximum 26dB Bandwidth :	4.680MHz
Band Edge :	-30.89dBm	Measurement Value :	-27.59dBm

Higher Band Edge Plot on Channel 4233 (846.6 MHz)

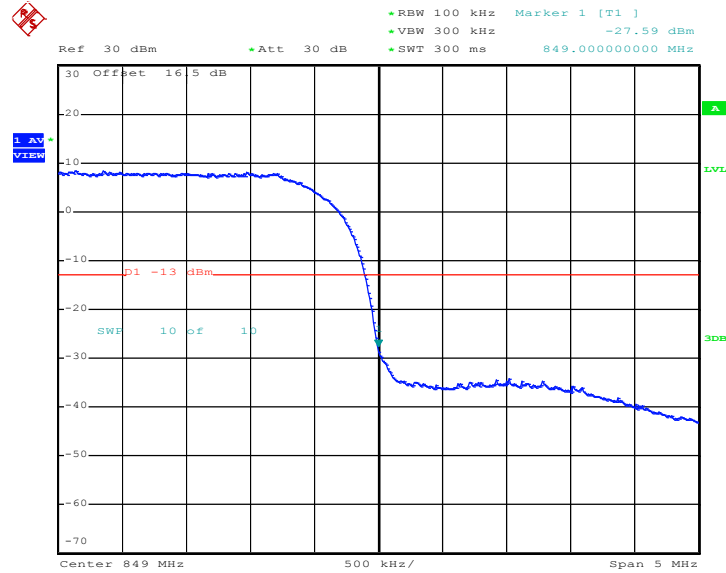

Date: 6.AUG.2012 10:54:11

1. Correction Factor(dB)= $10\log(1\% \text{ Emission BW/RBW})$
2. Band Edge= Measurement Value + Correction Factor(dB)



Band :	WCDMA Band II	Test Mode :	RMC 12.2Kbps Link
Correction Factor :	-3.30dB	Maximum 26dB Bandwidth :	4.680MHz
Band Edge :	-27.76dBm	Measurement Value :	-24.46dBm

Lower Band Edge Plot on Channel 9262 (1852.4 MHz)

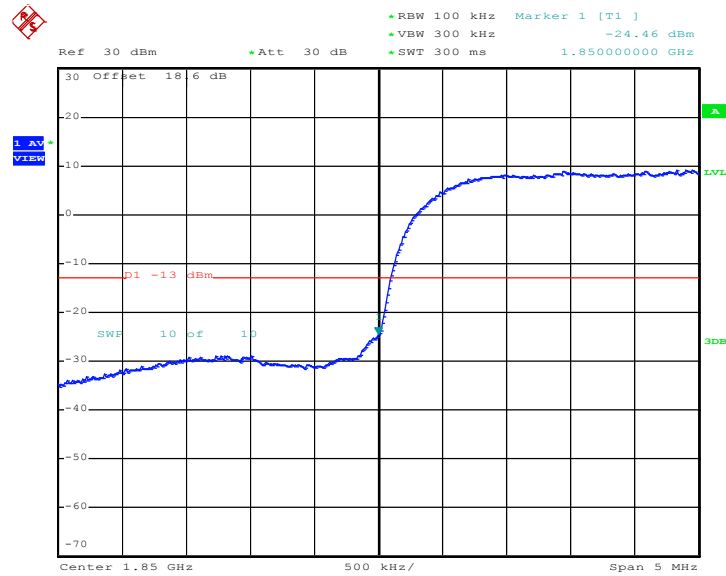

Date: 6.AUG.2012 15:04:16

1. Correction Factor(dB)= 10log(1% Emission BW/RBW)
2. Band Edge= Measurement Value + Correction Factor(dB)



Band :	WCDMA Band II	Test Mode :	RMC 12.2Kbps Link
Correction Factor :	-3.30dB	Maximum 26dB Bandwidth :	4.680MHz
Band Edge :	-30.27dBm	Measurement Value :	-26.97dBm

Higher Band Edge Plot on Channel 9538 (1907.6 MHz)

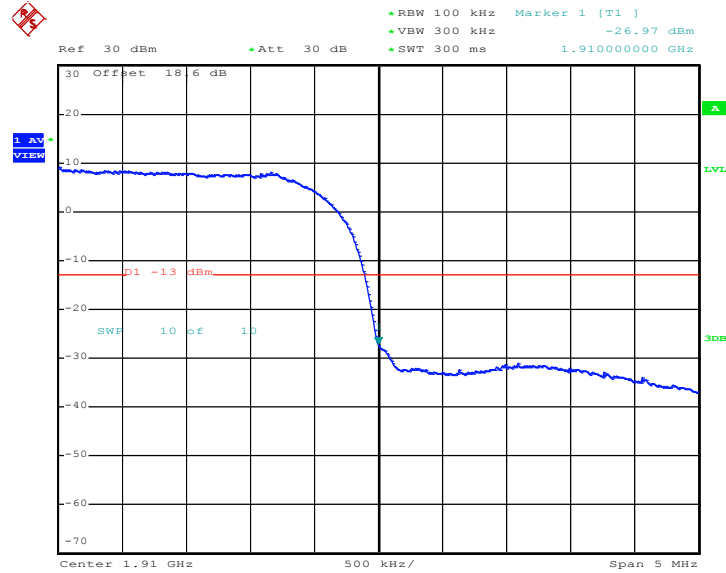

Date: 6.AUG.2012 15:04:45

1. Correction Factor(dB)= $10\log(1\% \text{ Emission BW/RBW})$
2. Band Edge= Measurement Value + Correction Factor(dB)

3.5 Conducted Spurious Emission Measurement

3.5.1 Description of Conducted Spurious Emission Measurement

The power of any emission outside of the authorized operating frequency ranges must be lower than the transmitter power (P) by a factor of at least $43 + 10 \log (P)$ dB.

It is measured by means of a calibrated spectrum analyzer and scanned from 30 MHz up to a frequency including its 10th harmonic.

3.5.2 Measuring Instruments

See list of measuring instruments of this test report.

3.5.3 Test Procedures

1. The EUT was connected to spectrum analyzer and base station via power divider.
2. The middle channel for the highest RF power within the transmitting frequency was measured.
3. The conducted spurious emission for the whole frequency range was taken.

3.5.4 Test Setup

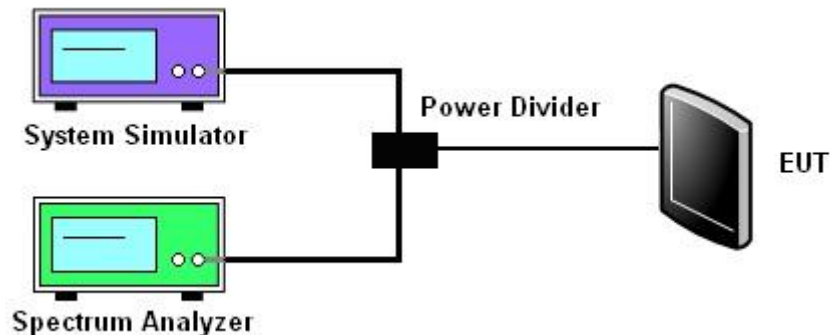



3.5.5 Test Result (Plots) of Conducted Spurious Emission

Band :	GSM850	Channel :	CH189
Test Mode :	GPRS 8 Link	Frequency :	836.4 MHz

Conducted Spurious Emission Plot between 30MHz ~ 1GHz

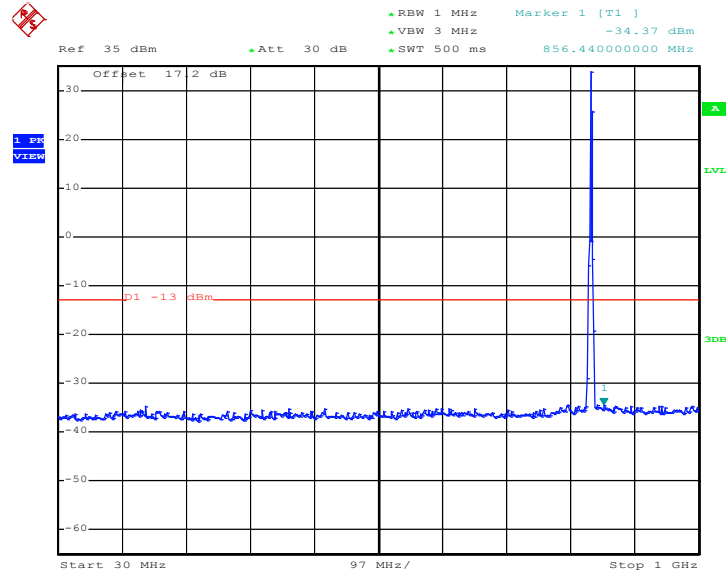

Date: 6.AUG.2012 09:59:46

Conducted Spurious Emission Plot between 1GHz ~ 3GHz

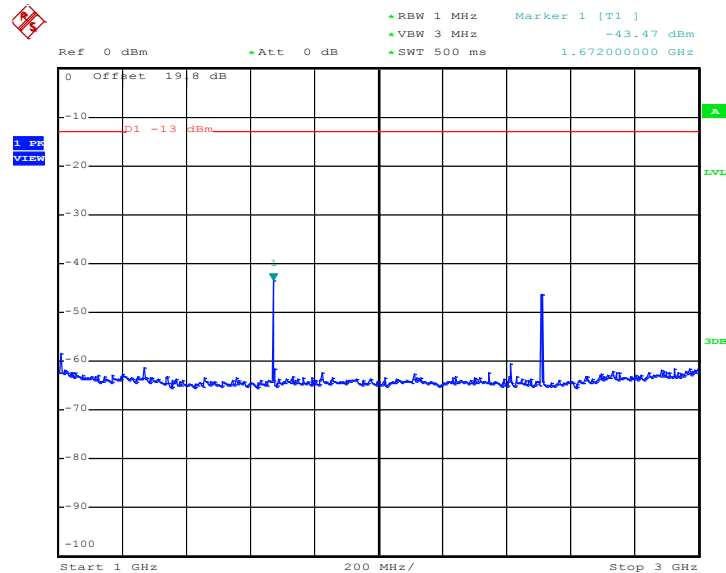

Date: 6.AUG.2012 10:00:04



Conducted Spurious Emission Plot between 3GHz ~ 7GHz

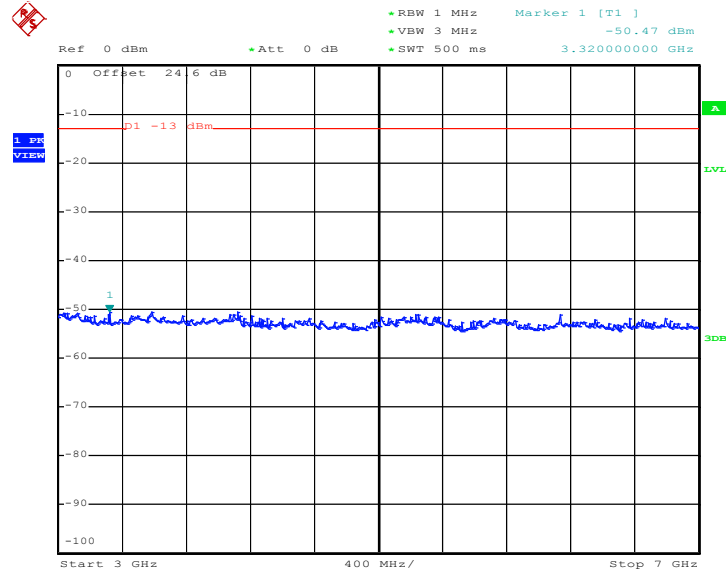

Date: 6.AUG.2012 10:00:16

Conducted Spurious Emission Plot between 7GHz ~ 9GHz

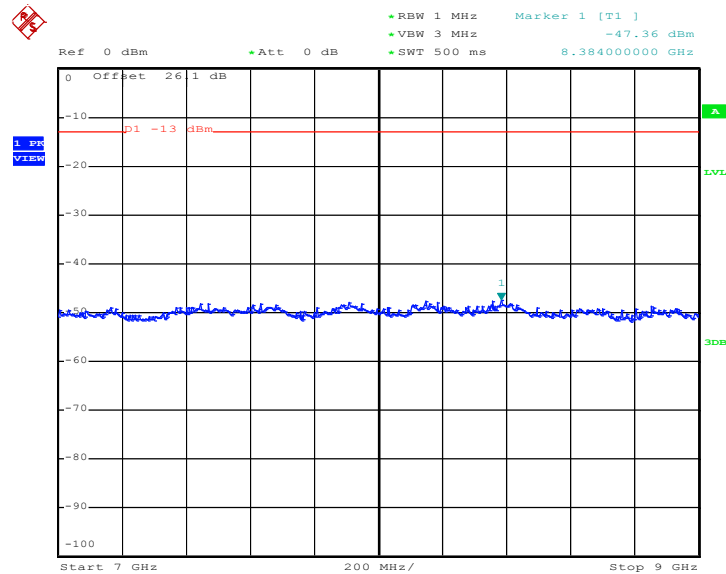

Date: 6.AUG.2012 10:00:29



Band :	GSM850	Channel :	CH189
Test Mode :	EDGE 8 Link	Frequency :	836.4 MHz

Conducted Spurious Emission Plot between 30MHz ~ 1GHz

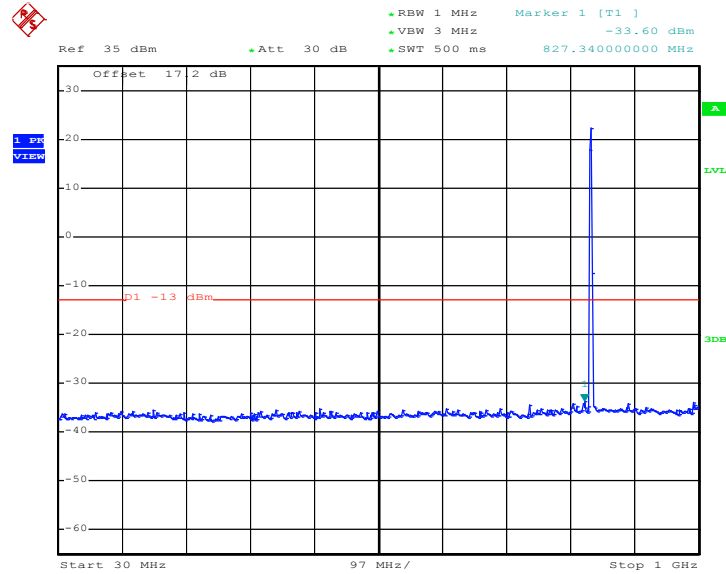

Date: 6.AUG.2012 10:19:22

Conducted Spurious Emission Plot between 1GHz ~ 3GHz

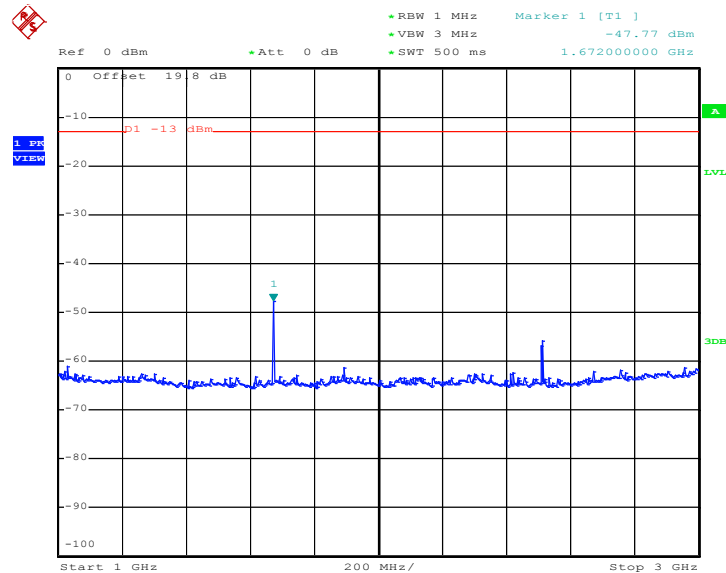

Date: 6.AUG.2012 10:20:36



Conducted Spurious Emission Plot between 3GHz ~ 7GHz

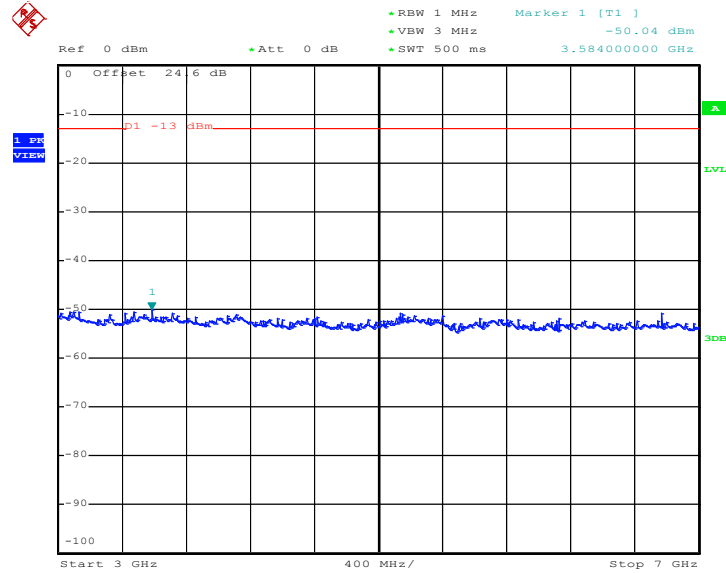

Date: 6.AUG.2012 10:20:48

Conducted Spurious Emission Plot between 7GHz ~ 9GHz

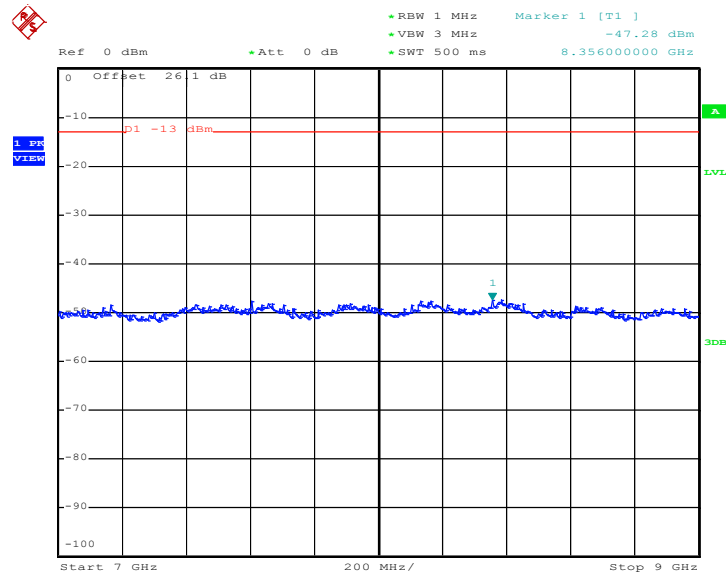

Date: 6.AUG.2012 10:21:01



Band :	GSM1900	Channel :	CH661
Test Mode :	GPRS 8 Link	Frequency :	1880.0 MHz

Conducted Spurious Emission Plot between 30MHz ~ 1GHz

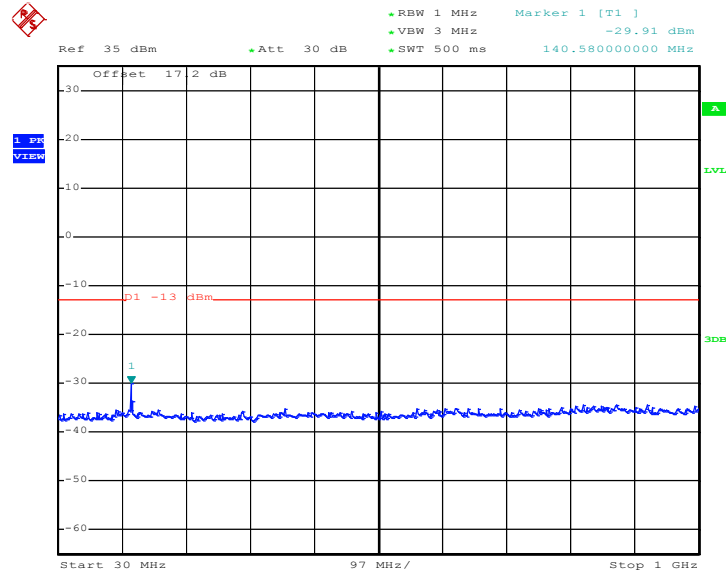

Date: 6.AUG.2012 14:24:50

Conducted Spurious Emission Plot between 1GHz ~ 3GHz

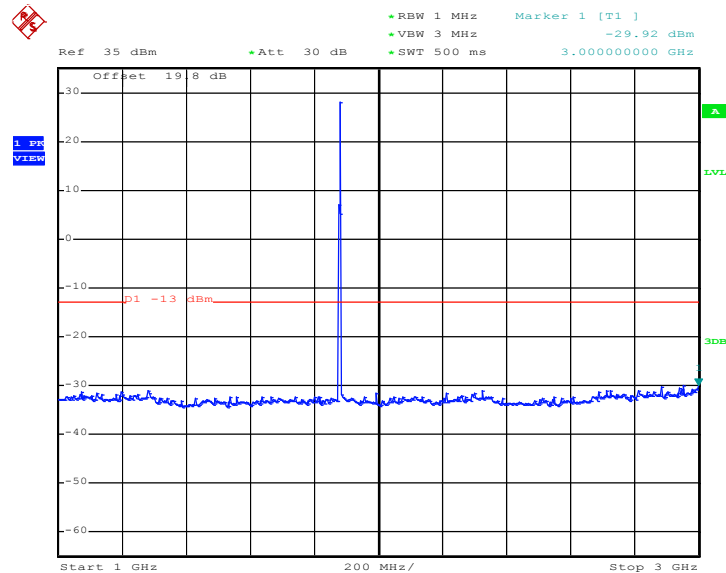

Date: 6.AUG.2012 14:25:03



Conducted Spurious Emission Plot between 3GHz ~ 7GHz

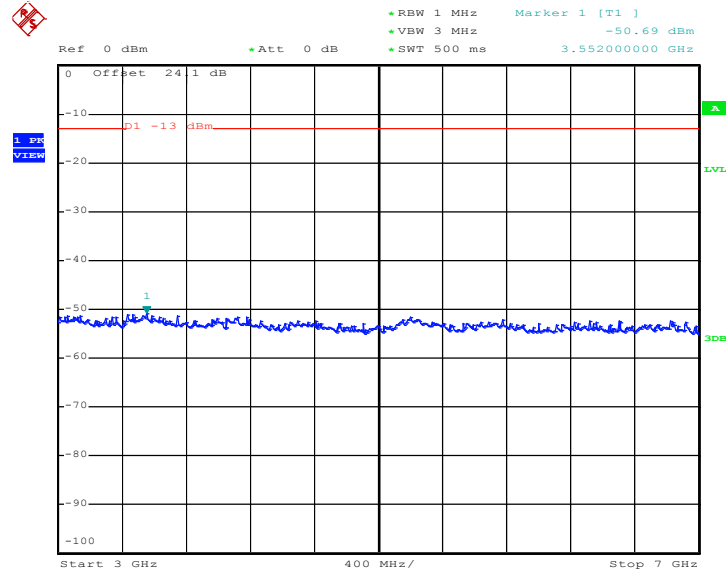

Date: 6.AUG.2012 14:25:24

Conducted Emission Plot between 7GHz ~ 13.6GHz

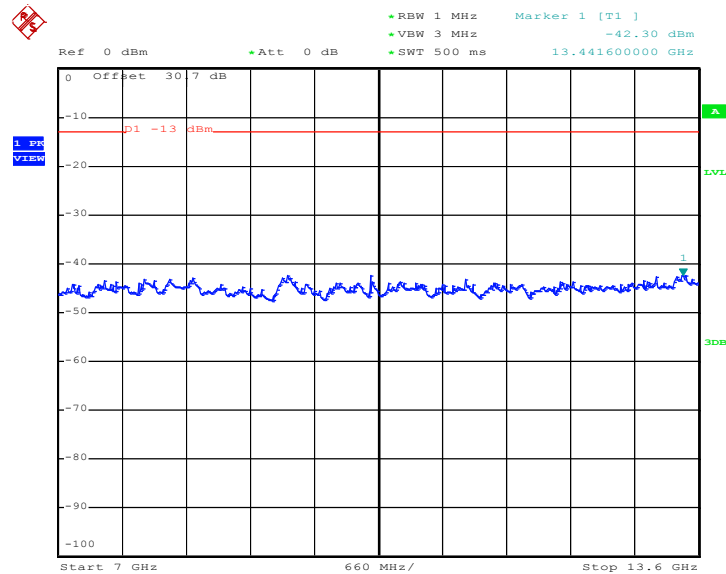

Date: 6.AUG.2012 14:25:36



Conducted Spurious Emission Plot between 13.6GHz ~ 19.1GHz

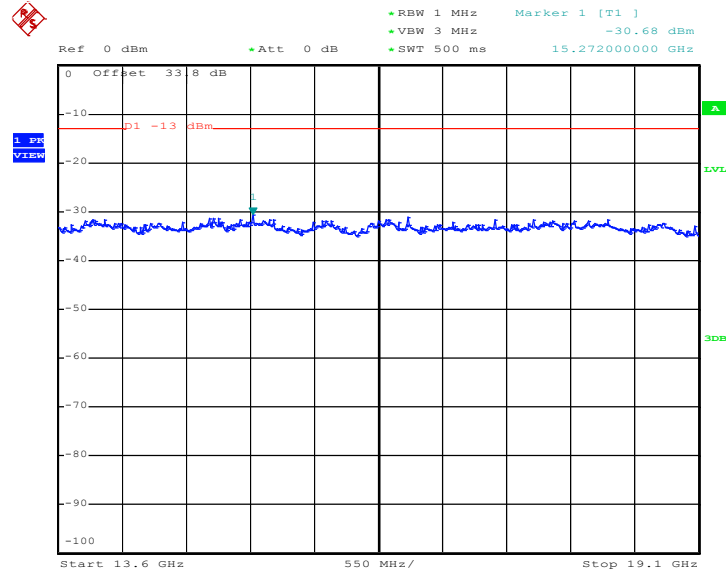

Date: 6.AUG.2012 14:25:49



Band :	GSM1900	Channel :	CH661
Test Mode :	EDGE 8 Link	Frequency :	1880.0 MHz

Conducted Spurious Emission Plot between 30MHz ~ 1GHz

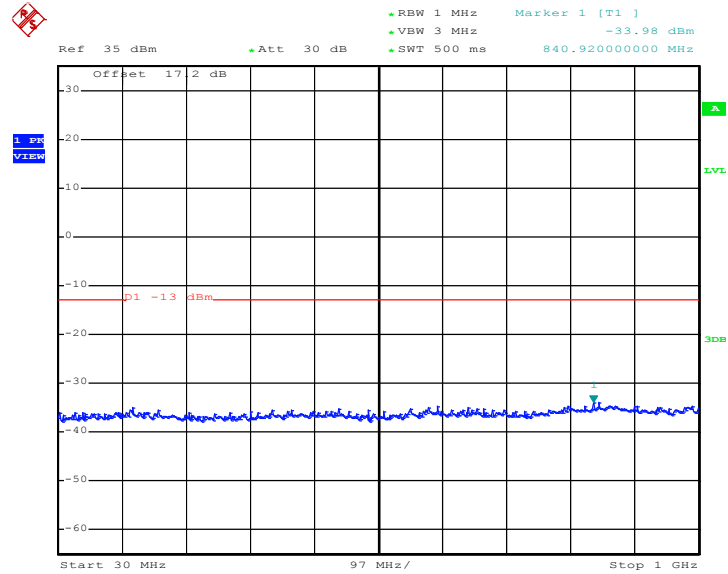

Date: 6.AUG.2012 11:59:46

Conducted Spurious Emission Plot between 1GHz ~ 3GHz

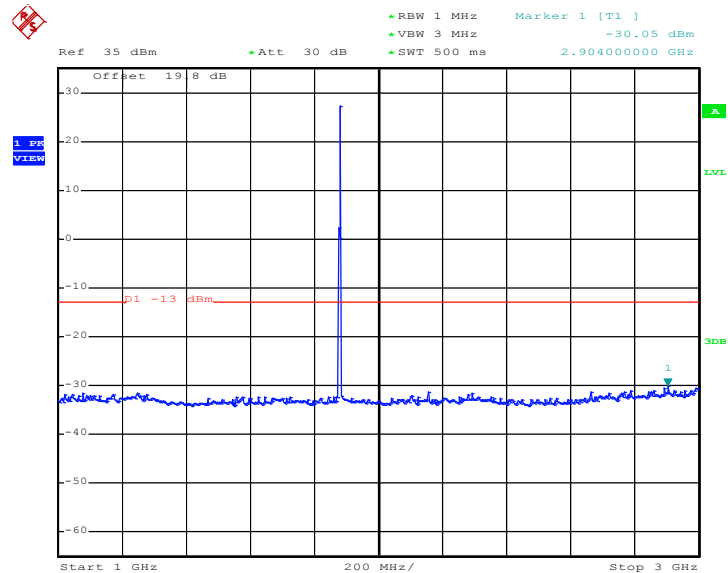

Date: 6.AUG.2012 11:59:58



Conducted Spurious Emission Plot between 3GHz ~ 7GHz

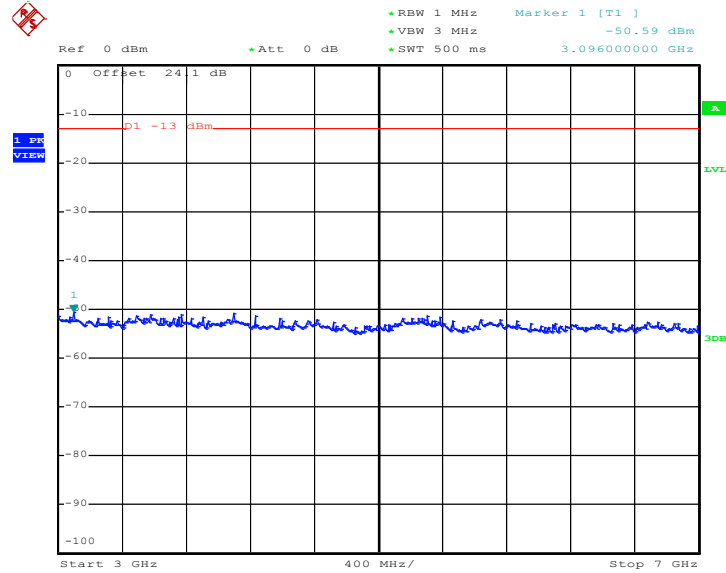

Date: 6.AUG.2012 12:00:16

Conducted Spurious Emission Plot between 7GHz ~ 13.6GHz

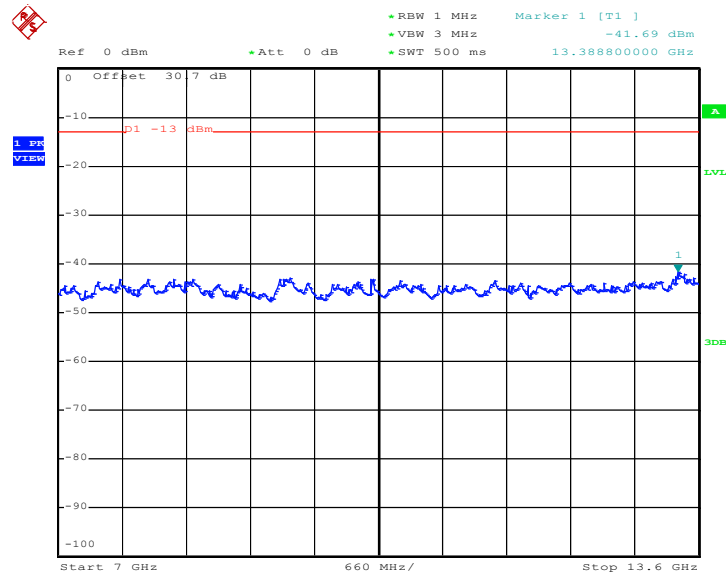

Date: 6.AUG.2012 12:00:28



Conducted Spurious Emission Plot between 13.6GHz ~ 19.1GHz

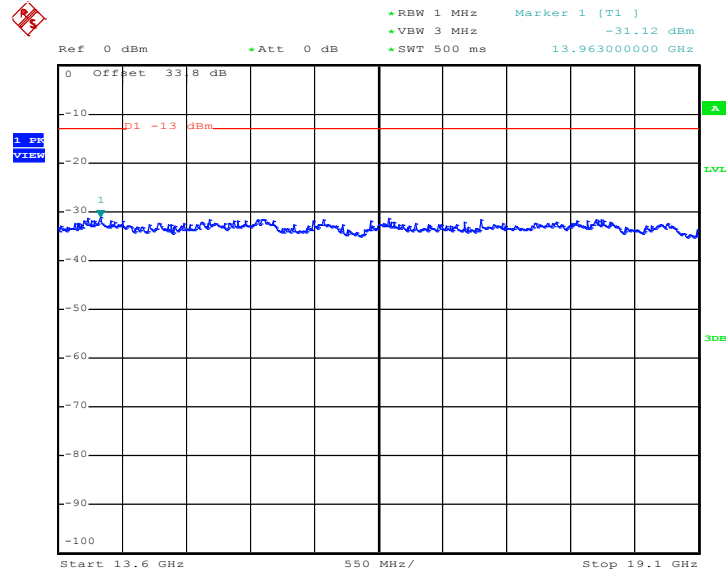

Date: 6.AUG.2012 12:00:41



Band :	WCDMA Band V	Channel :	CH4182
Test Mode :	RMC 12.2Kbps Link	Frequency :	836.4 MHz

Conducted Spurious Emission Plot between 30MHz ~ 1GHz

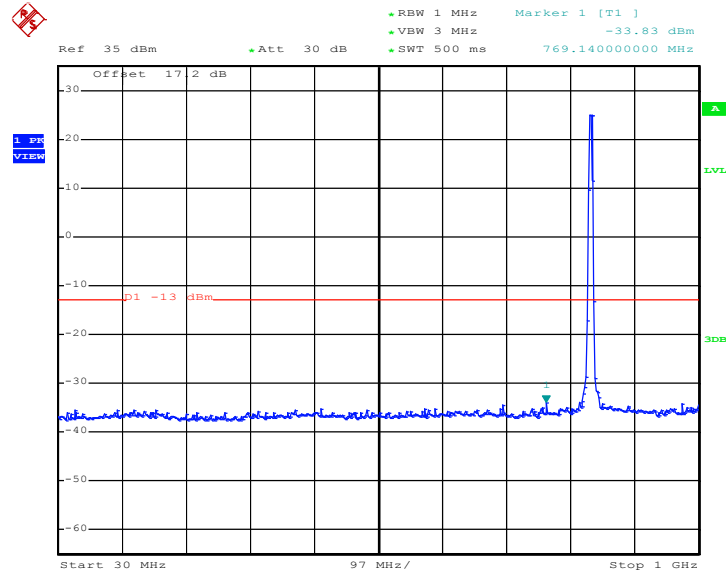

Date: 6.AUG.2012 10:47:46

Conducted Spurious Emission Plot between 1GHz ~ 3GHz

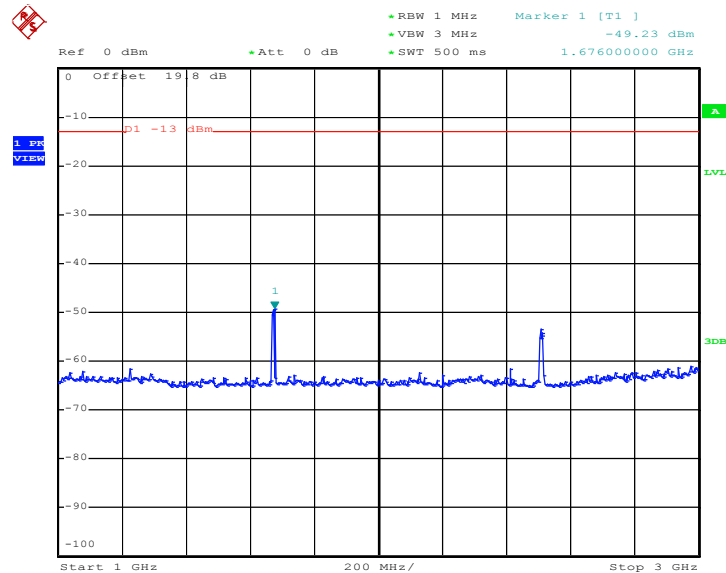

Date: 6.AUG.2012 10:48:00



Conducted Spurious Emission Plot between 3GHz ~ 7GHz

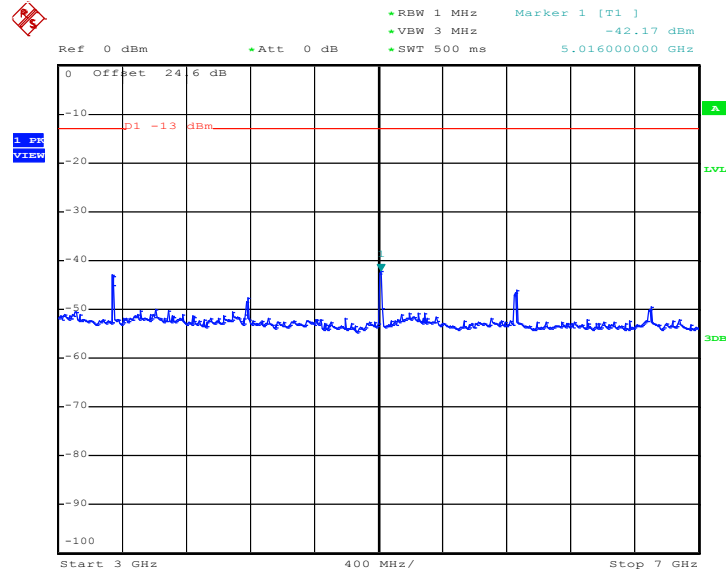

Date: 6.AUG.2012 10:48:13

Conducted Spurious Emission Plot between 7GHz ~ 9GHz

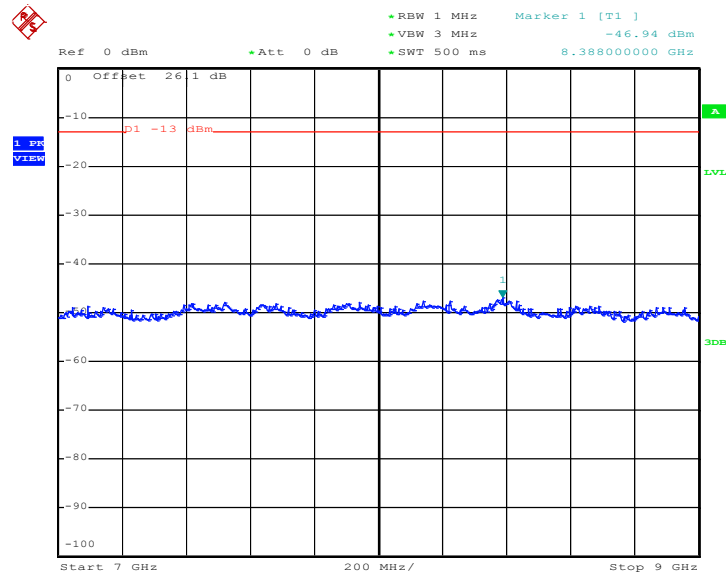

Date: 6.AUG.2012 10:48:25



Band :	WCDMA Band II	Channel :	CH9400
Test Mode :	RMC 12.2Kbps Link	Frequency :	1880.0 MHz

Conducted Spurious Emission Plot between 30MHz ~ 1GHz

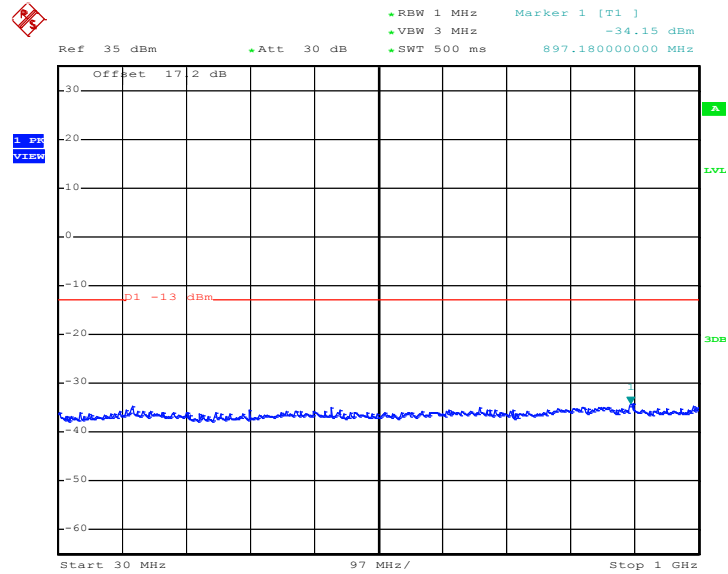

Date: 6.AUG.2012 14:57:53

Conducted Spurious Emission Plot between 1GHz ~ 3GHz

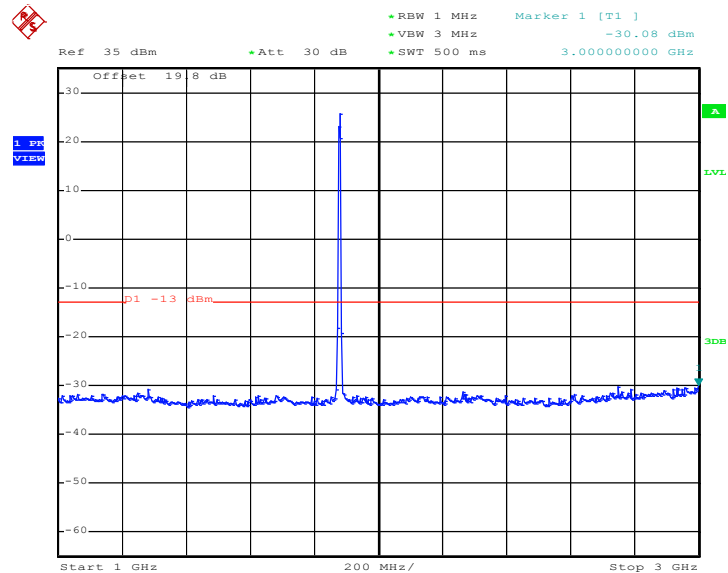

Date: 6.AUG.2012 14:58:06



Conducted Spurious Emission Plot between 3GHz ~ 7GHz

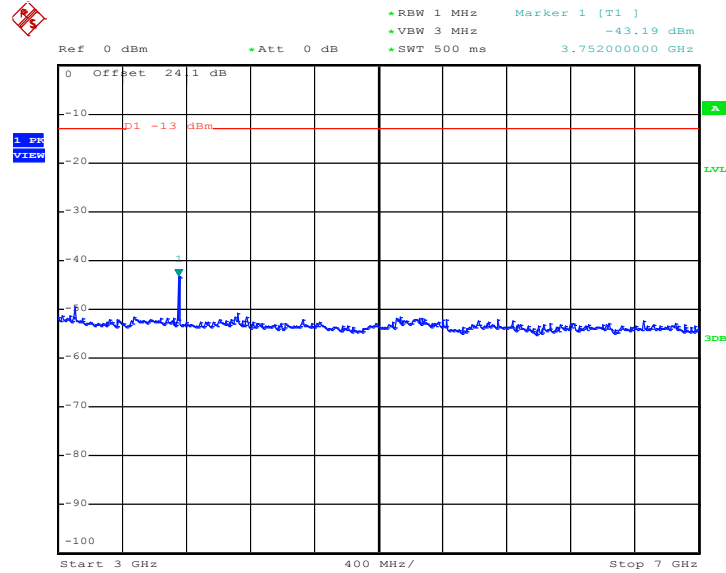

Date: 6.AUG.2012 14:58:26

Conducted Spurious Emission Plot between 7GHz ~ 13.6GHz

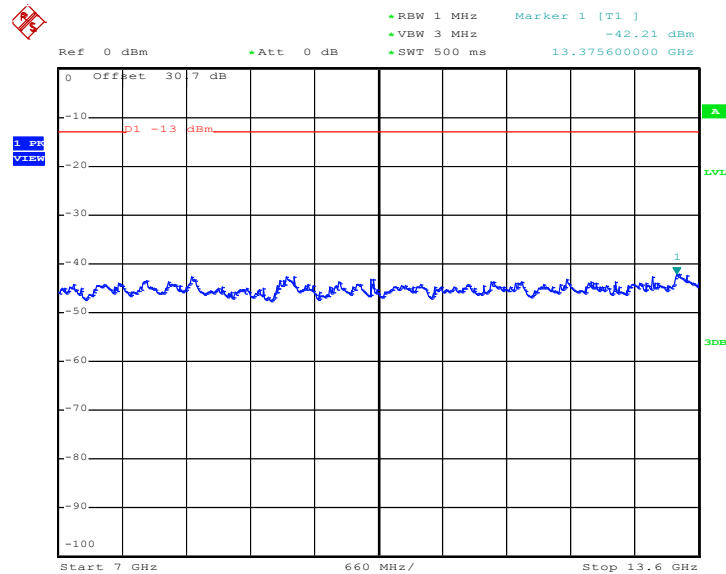

Date: 6.AUG.2012 14:58:38



Conducted Spurious Emission Plot between 13.6GHz ~ 19.1GHz

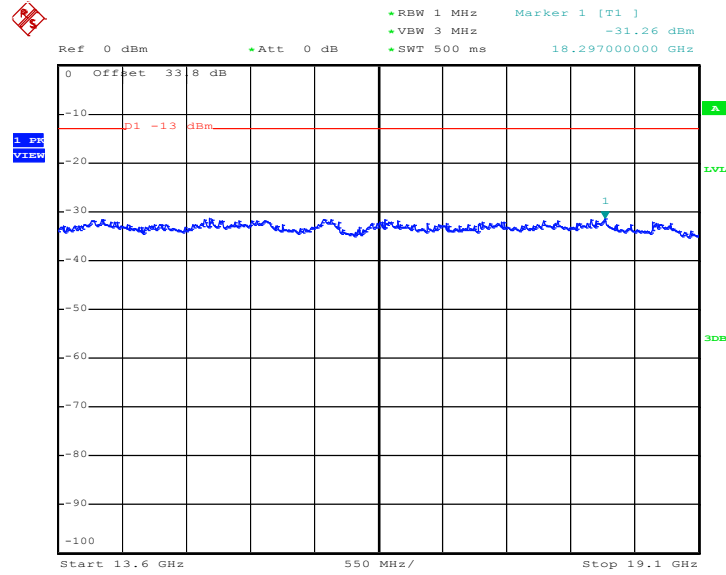

Date: 6.AUG.2012 14:58:51



3.6 Field Strength of Spurious Radiation Measurement

3.6.1 Description of Field Strength of Spurious Radiated Measurement

The radiated spurious emission was measured by substitution method according to ANSI / TIA / EIA-603-C-2004. The power of any emission outside of the authorized operating frequency ranges must be attenuated below the transmitter power (P) by a factor of at least $43 + 10 \log (P)$ dB. The spectrum is scanned from 30 MHz up to a frequency including its 10th harmonic.

3.6.2 Measuring Instruments

See list of measuring instruments of this test report.

3.6.3 Test Procedures

1. The EUT was placed on a rotatable wooden table with 0.8 meter above ground.
2. The EUT was set 3 meters from the receiving antenna, which was mounted on the antenna tower.
3. The table was rotated 360 degrees to determine the position of the highest spurious emission.
4. The height of the receiving antenna is varied between one meter and four meters to search the maximum spurious emission for both horizontal and vertical polarizations.
5. Make the measurement with the spectrum analyzer's RBW = 1MHz, VBW = 3MHz, taking the record of maximum spurious emission.
6. A horn antenna was substituted in place of the EUT and was driven by a signal generator.
7. Tune the output power of signal generator to the same emission level with EUT maximum spurious emission.
8. Taking the record of output power at antenna port.
9. Repeat step 7 to step 8 for another polarization.
10. $EIRP (dBm) = S.G. Power - Tx Cable Loss + Tx Antenna Gain$
11. $ERP (dBm) = EIRP - 2.15$

3.6.4 Test Setup

For radiated emissions below 30MHz

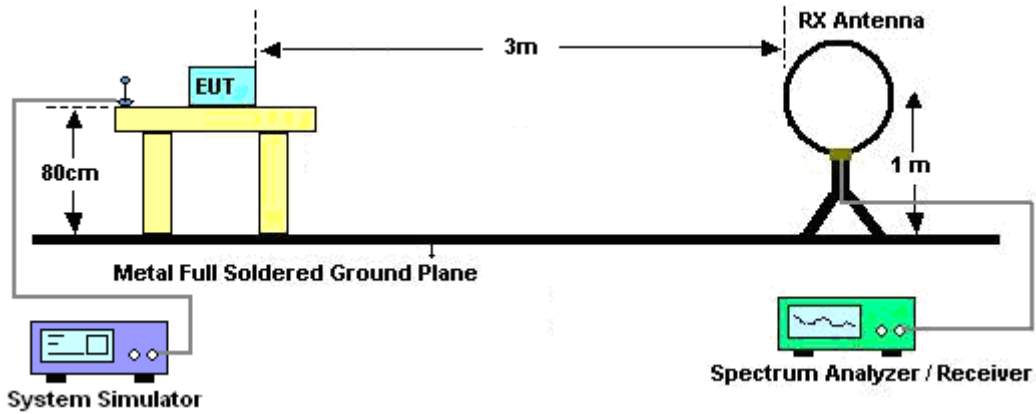

For radiated emissions from 30MHz to 1GHz

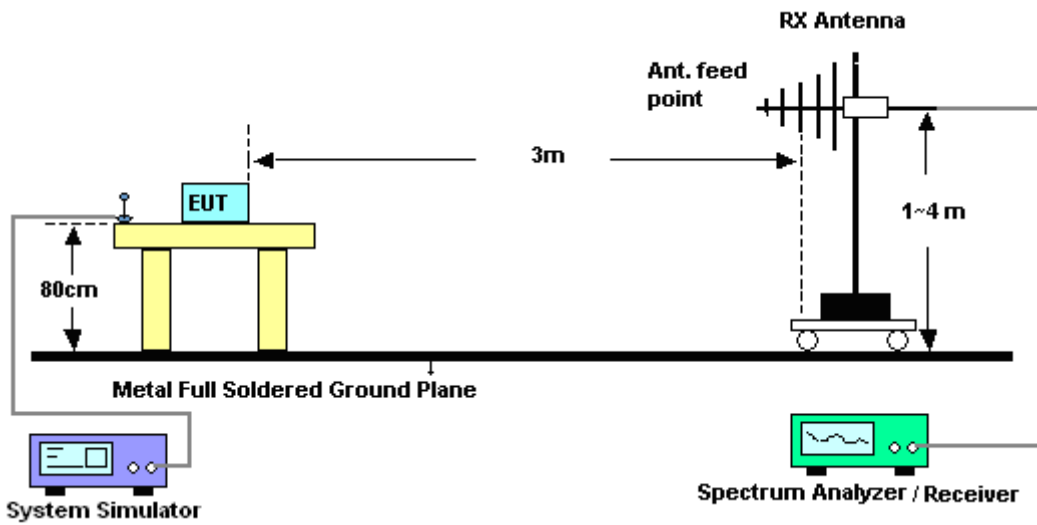

For radiated emissions above 1GHz

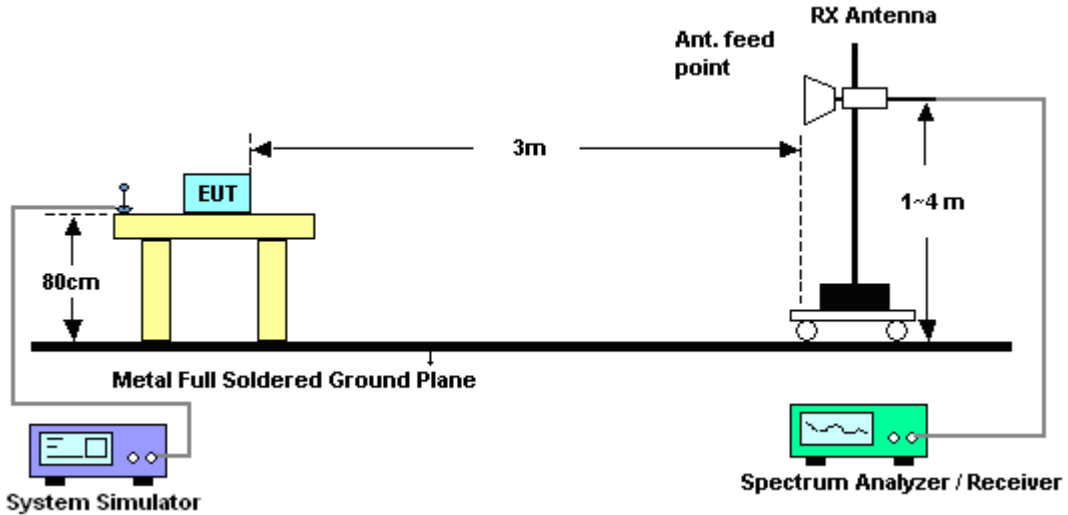

3.6.5 Test Results of Radiated Emissions (9 KHz ~ 30 MHz)

The low frequency, which started from 9 KHz to 30MHz, was pre-scanned and the result which was 20dB lower than the limit line per 15.31(o) was not reported.



3.6.6 Test Result of Field Strength of Spurious Radiated

Band :	GSM850	Temperature :	23~24°C
Test Mode :	GPRS 8 Link	Relative Humidity :	47~48%
Test Engineer :	Hayden Wu	Polarization :	Horizontal
Remark :	Spurious emissions within 30-1000MHz were found more than 20dB below limit line.		

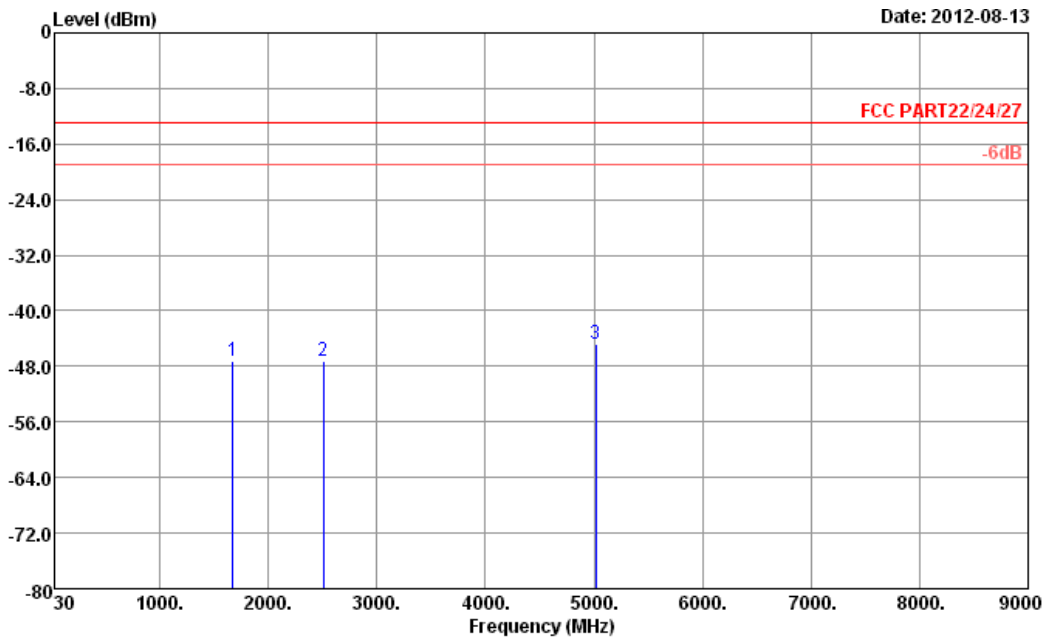

Site : 03CH05-HY
 Condition : FCC PART22/24/27 HF_EIRP_101221 HORIZONTAL

Frequency (MHz)	ERP (dBm)	Limit (dBm)	Over Limit (dB)	SPA Reading (dBm)	S.G. Power (dBm)	TX Cable loss (dB)	TX Antenna Gain (dBi)	Polarization (H/V)	Result
1672	-47.24	-13	-34.24	-53.45	-49	1.35	5.25	H	Pass
2509	-47.22	-13	-34.22	-56.47	-49.6	1.58	6.11	H	Pass
5015	-44.82	-13	-31.82	-62.03	-51	2.08	10.41	H	Pass



Band :	GSM850	Temperature :	23~24°C
Test Mode :	GPRS 8 Link	Relative Humidity :	47~48%
Test Engineer :	Hayden Wu	Polarization :	Vertical
Remark :	Spurious emissions within 30-1000MHz were found more than 20dB below limit line.		

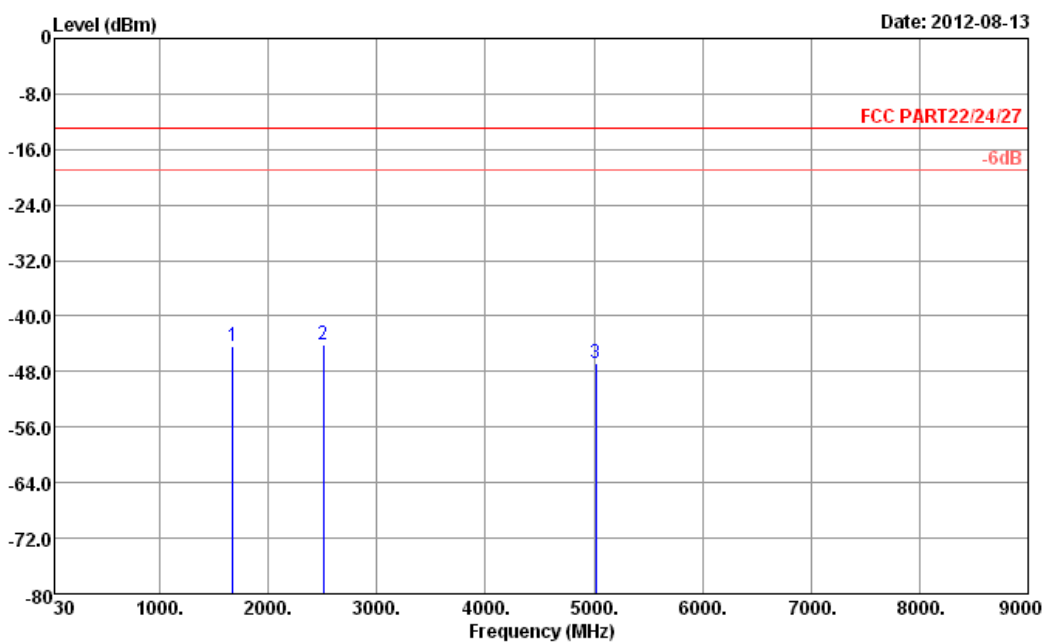

Site : 03CH05-HY
 Condition : FCC PART22/24/27 HF_EIRP_101221 VERTICAL

Frequency (MHz)	ERP (dBm)	Limit (dBm)	Over Limit (dB)	SPA Reading (dBm)	S.G. Power (dBm)	TX Cable loss (dB)	TX Antenna Gain (dBi)	Polarization (H/V)	Result
1672	-44.24	-13	-31.24	-50.91	-46	1.35	5.25	V	Pass
2509	-44.22	-13	-31.22	-53.61	-46.6	1.58	6.11	V	Pass
5015	-46.82	-13	-33.82	-64.03	-53	2.08	10.41	V	Pass



Band :	GSM850	Temperature :	23~24°C
Test Mode :	EDGE 8 Link	Relative Humidity :	47~48%
Test Engineer :	Hayden Wu	Polarization :	Horizontal
Remark :	Spurious emissions within 30-1000MHz were found more than 20dB below limit line.		

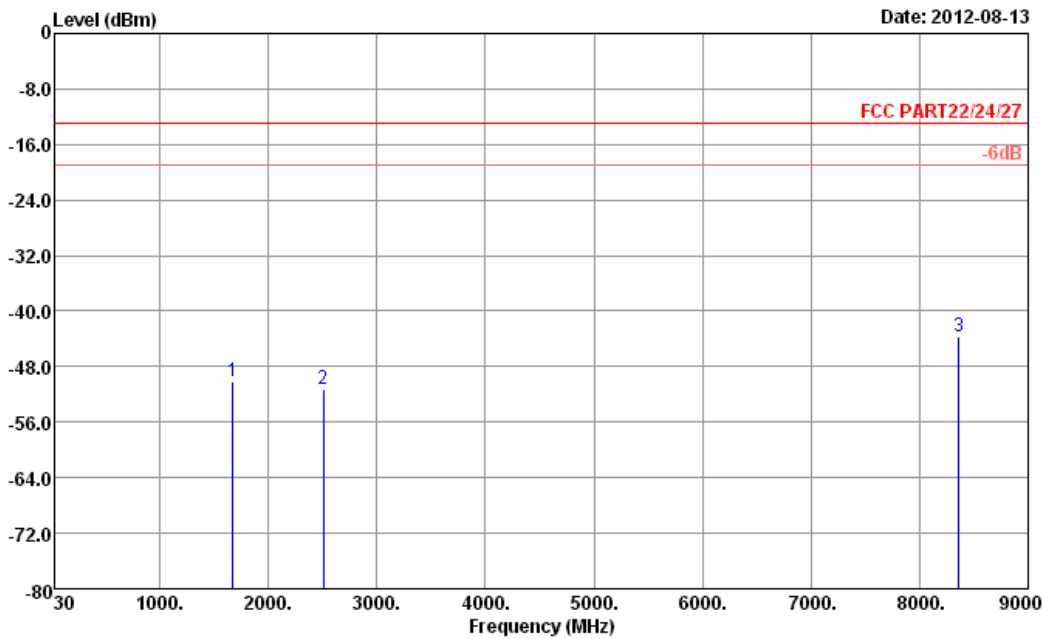

Site : 03CH05-HY
 Condition : FCC PART22/24/27 HF_EIRP_101221 HORIZONTAL

Frequency (MHz)	ERP (dBm)	Limit (dBm)	Over Limit (dB)	SPA Reading (dBm)	S.G. Power (dBm)	TX Cable loss (dB)	TX Antenna Gain (dBi)	Polarization (H/V)	Result
1672	-50.24	-13	-37.24	-56.86	-52	1.35	5.25	H	Pass
2509	-51.22	-13	-38.22	-60.46	-53.6	1.58	6.11	H	Pass
8360	-43.72	-13	-30.72	-66.93	-51.8	2.67	12.89	H	Pass



Band :	GSM850	Temperature :	23~24°C
Test Mode :	EDGE 8 Link	Relative Humidity :	47~48%
Test Engineer :	Hayden Wu	Polarization :	Vertical
Remark :	Spurious emissions within 30-1000MHz were found more than 20dB below limit line.		

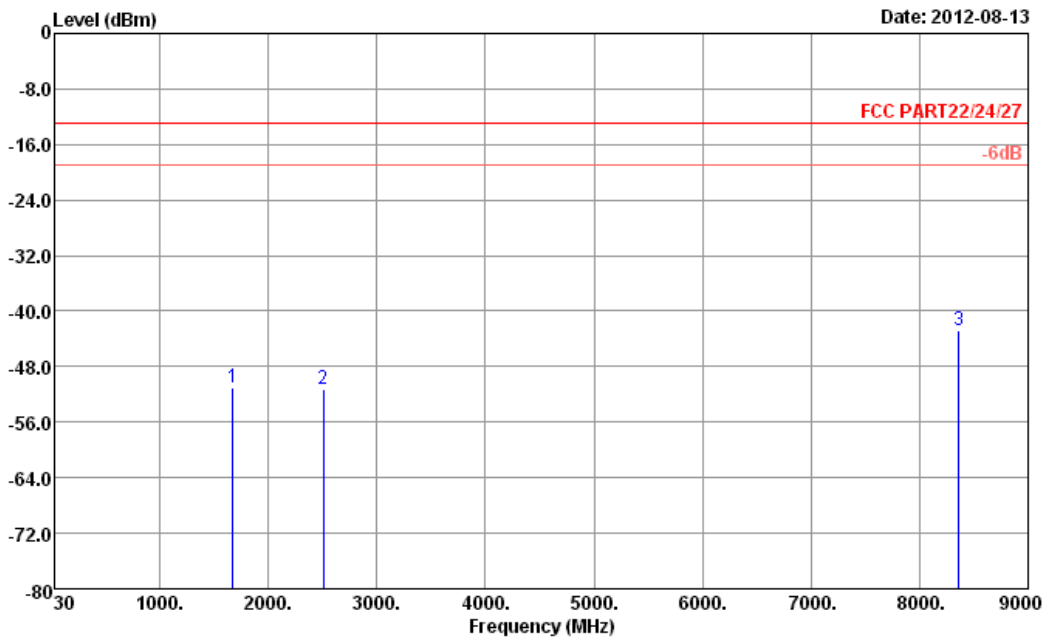

Site : 03CH05-HY
 Condition : FCC PART22/24/27 HF_EIRP_101221 VERTICAL

Frequency (MHz)	ERP (dBm)	Limit (dBm)	Over Limit (dB)	SPA Reading (dBm)	S.G. Power (dBm)	TX Cable loss (dB)	TX Antenna Gain (dBi)	Polarization (H/V)	Result
1672	-51.04	-13	-38.04	-57.04	-52.8	1.35	5.25	V	Pass
2509	-51.32	-13	-38.32	-60.6	-53.7	1.58	6.11	V	Pass
8360	-42.72	-13	-29.72	-66.02	-50.8	2.67	12.89	V	Pass



Band :	GSM1900	Temperature :	23~24°C
Test Mode :	GPRS 8 Link	Relative Humidity :	47~48%
Test Engineer :	Hayden Wu	Polarization :	Horizontal
Remark :	Spurious emissions within 30-1000MHz were found more than 20dB below limit line.		

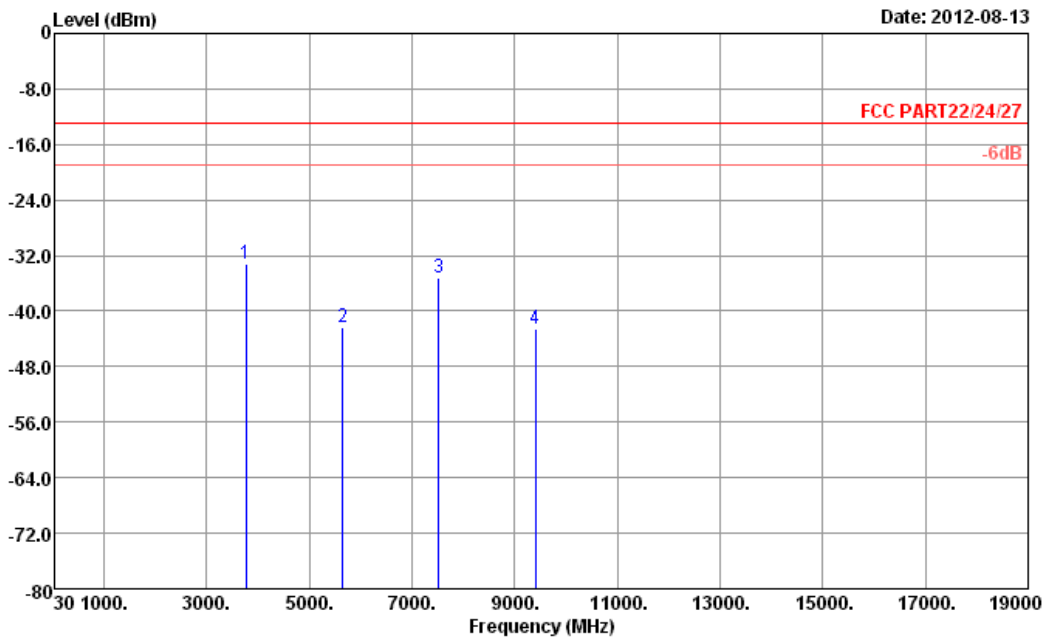

Site : 03CH05-HY
 Condition : FCC PART22/24/27 HF_EIRP_101221 HORIZONTAL

Frequency (MHz)	EIRP (dBm)	Limit (dBm)	Over Limit (dB)	SPA Reading (dBm)	S.G. Power (dBm)	TX Cable loss (dB)	TX Antenna Gain (dBi)	Polarization (H/V)	Result
3760	-33.19	-13	-20.19	-46.66	-39.9	2.00	8.71	H	Pass
5640	-42.36	-13	-29.36	-61.38	-51	2.13	10.77	H	Pass
7520	-35.26	-13	-22.26	-57.28	-44.8	2.68	12.22	H	Pass
9400	-42.49	-13	-29.49	-66.49	-53	2.87	13.38	H	Pass



Band :	GSM1900	Temperature :	23~24°C
Test Mode :	GPRS 8 Link	Relative Humidity :	47~48%
Test Engineer :	Hayden Wu	Polarization :	Vertical
Remark :	Spurious emissions within 30-1000MHz were found more than 20dB below limit line.		

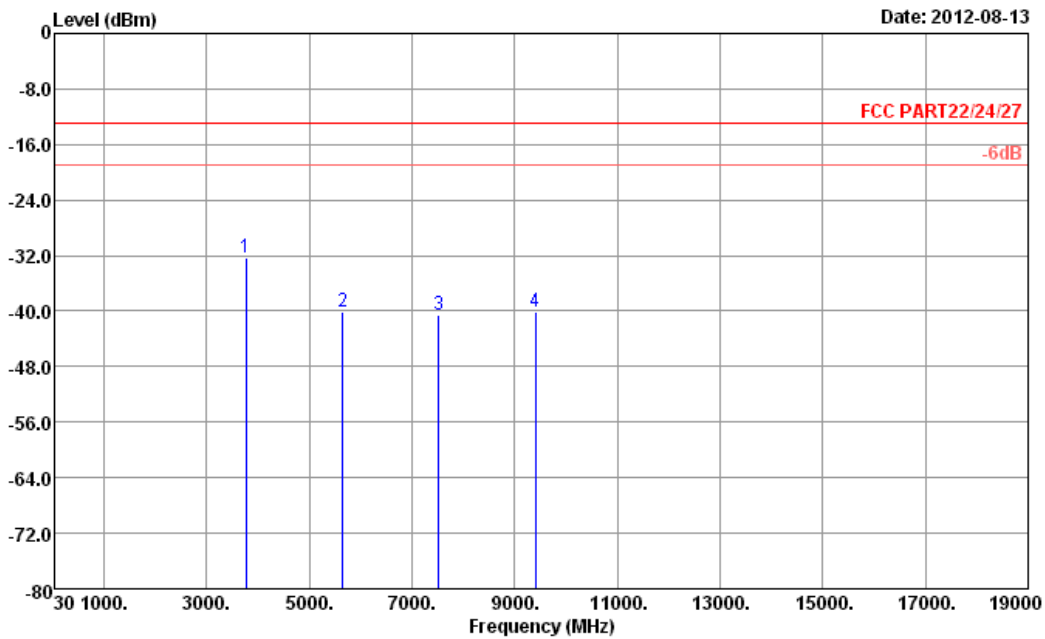

Site : 03CH05-HY
 Condition : FCC PART22/24/27 HF_EIRP_101221 VERTICAL

Frequency (MHz)	EIRP (dBm)	Limit (dBm)	Over Limit (dB)	SPA Reading (dBm)	S.G. Power (dBm)	TX Cable loss (dB)	TX Antenna Gain (dBi)	Polarization (H/V)	Result
3760	-32.29	-13	-19.29	-46.11	-39	2.00	8.71	V	Pass
5640	-40.06	-13	-27.06	-58.93	-48.7	2.13	10.77	V	Pass
7520	-40.46	-13	-27.46	-62.44	-50	2.68	12.22	V	Pass
9400	-40.19	-13	-27.19	-64.05	-50.7	2.87	13.38	V	Pass



Band :	GSM1900	Temperature :	23~24°C
Test Mode :	EDGE 8 Link	Relative Humidity :	47~48%
Test Engineer :	Hayden Wu	Polarization :	Horizontal
Remark :	Spurious emissions within 30-1000MHz were found more than 20dB below limit line.		

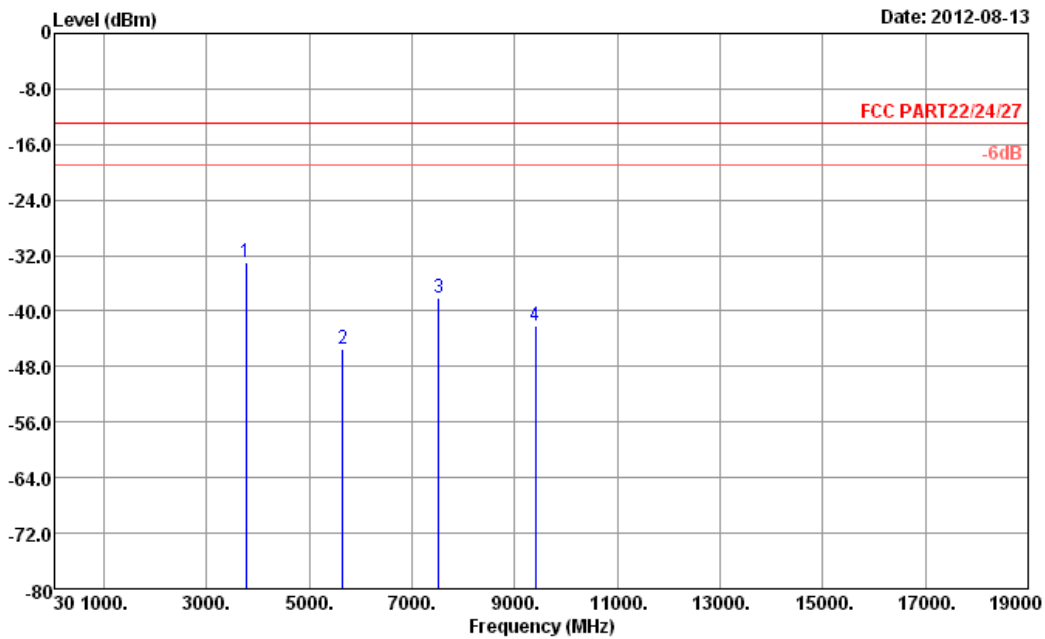

Site : 03CH05-HY
 Condition : FCC PART22/24/27 HF_EIRP_101221 HORIZONTAL

Frequency (MHz)	EIRP (dBm)	Limit (dBm)	Over Limit (dB)	SPA Reading (dBm)	S.G. Power (dBm)	TX Cable loss (dB)	TX Antenna Gain (dBi)	Polarization (H/V)	Result
3760	-33.09	-13	-20.09	-46.54	-39.8	2.00	8.71	H	Pass
5640	-45.36	-13	-32.36	-64.79	-54	2.13	10.77	H	Pass
7520	-38.06	-13	-25.06	-60.01	-47.6	2.68	12.22	H	Pass
9400	-42.09	-13	-29.09	-65.96	-52.6	2.87	13.38	H	Pass



Band :	GSM1900	Temperature :	23~24°C
Test Mode :	EDGE 8 Link	Relative Humidity :	47~48%
Test Engineer :	Hayden Wu	Polarization :	Vertical
Remark :	Spurious emissions within 30-1000MHz were found more than 20dB below limit line.		

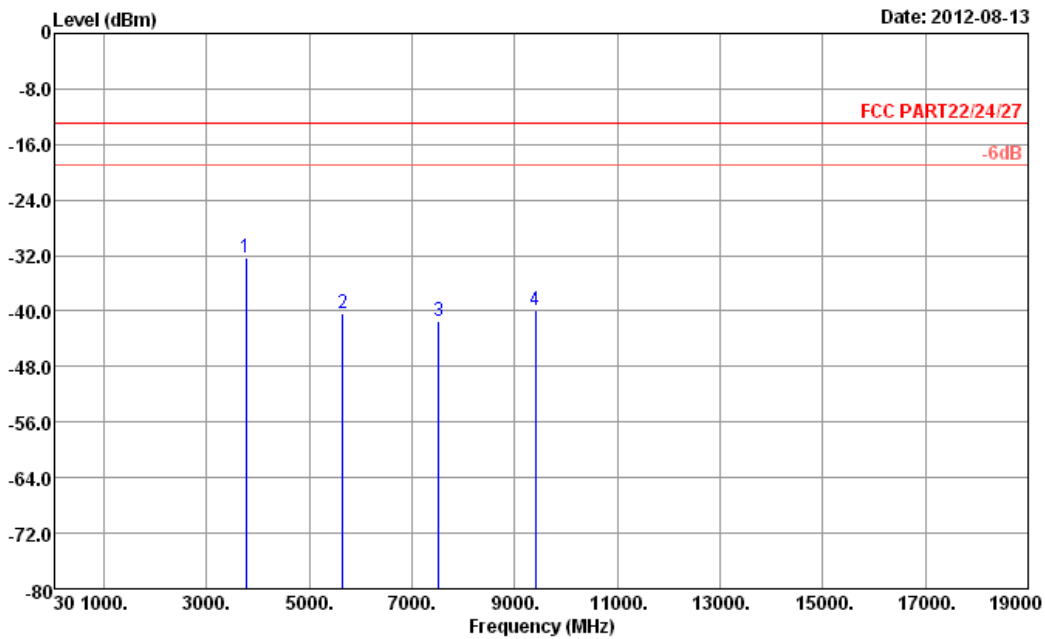

Site : 03CH05-HY
 Condition : FCC PART22/24/27 HF_EIRP_101221 VERTICAL

Frequency (MHz)	EIRP (dBm)	Limit (dBm)	Over Limit (dB)	SPA Reading (dBm)	S.G. Power (dBm)	TX Cable loss (dB)	TX Antenna Gain (dBi)	Polarization (H/V)	Result
3760	-32.29	-13	-19.29	-46.05	-39	2.00	8.71	V	Pass
5640	-40.26	-13	-27.26	-59.15	-48.9	2.13	10.77	V	Pass
7520	-41.46	-13	-28.46	-63.4	-51	2.68	12.22	V	Pass
9400	-39.99	-13	-26.99	-63.89	-50.5	2.87	13.38	V	Pass



Band :	WCDMA Band V	Temperature :	23~24°C
Test Mode :	RMC 12.2Kbps Link	Relative Humidity :	47~48%
Test Engineer :	Hayden Wu	Polarization :	Horizontal
Remark :	Spurious emissions within 30-1000MHz were found more than 20dB below limit line.		

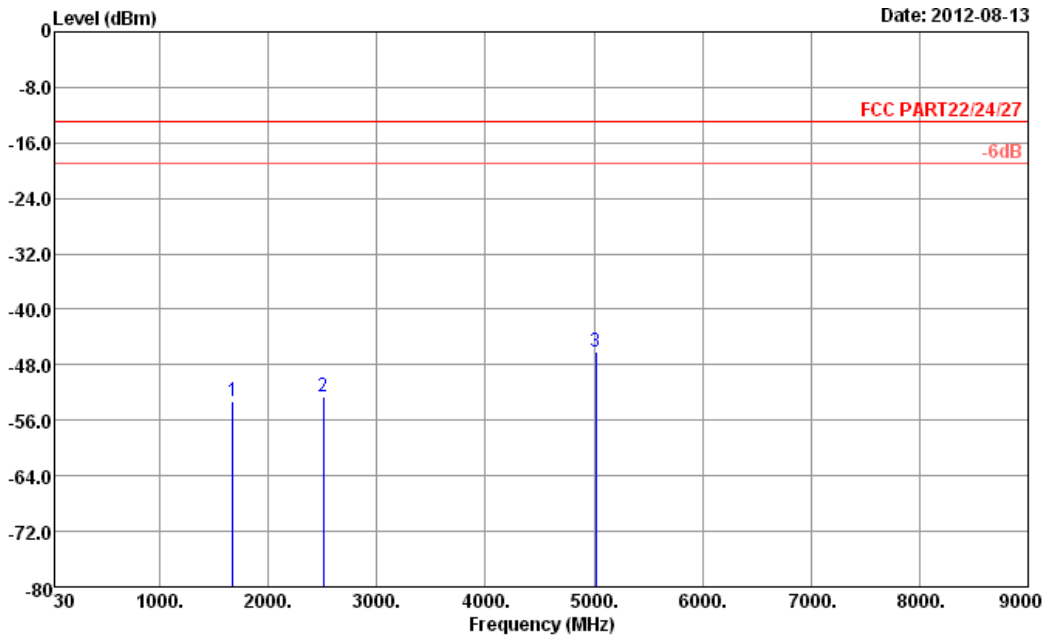

Site : 03CH05-HY
 Condition : FCC PART22/24/27 HF_EIRP_101221 HORIZONTAL

Frequency (MHz)	ERP (dBm)	Limit (dBm)	Over Limit (dB)	SPA Reading (dBm)	S.G. Power (dBm)	TX Cable loss (dB)	TX Antenna Gain (dBi)	Polarization (H/V)	Result
1672	-53.24	-13	-40.24	-59.67	-55	1.35	5.25	H	Pass
2509	-52.62	-13	-39.62	-62.22	-55	1.58	6.11	H	Pass
5015	-46.02	-13	-33.02	-63.2	-52.2	2.08	10.41	H	Pass



Band :	WCDMA Band V	Temperature :	23~24°C
Test Mode :	RMC 12.2Kbps Link	Relative Humidity :	47~48%
Test Engineer :	Hayden Wu	Polarization :	Vertical
Remark :	Spurious emissions within 30-1000MHz were found more than 20dB below limit line.		

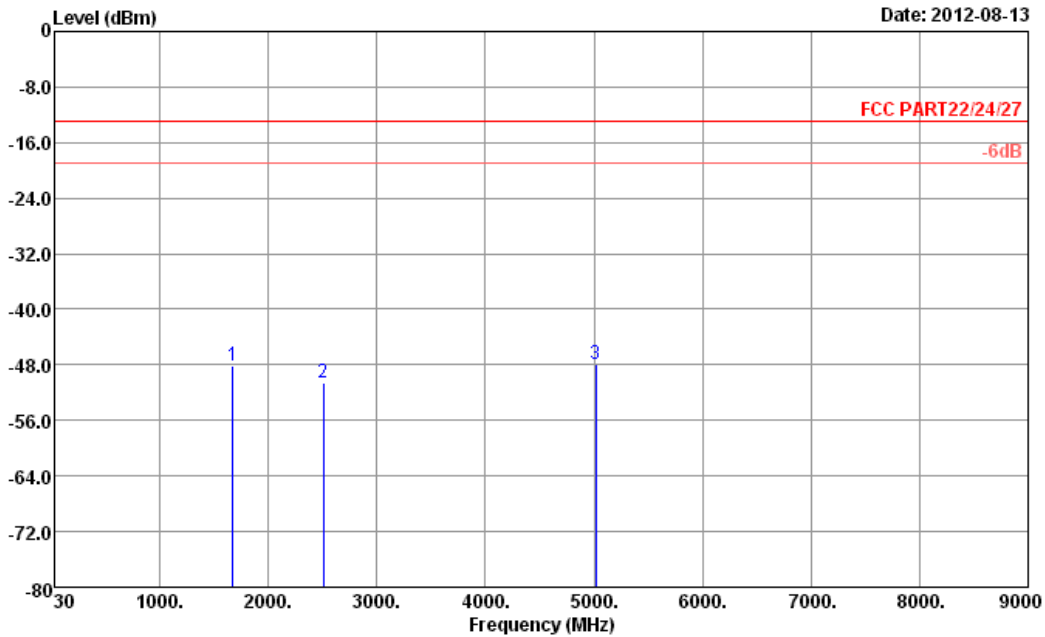

Site : 03CH05-HY
 Condition : FCC PART22/24/27 HF_EIRP_101221 VERTICAL

Frequency (MHz)	ERP (dBm)	Limit (dBm)	Over Limit (dB)	SPA Reading (dBm)	S.G. Power (dBm)	TX Cable loss (dB)	TX Antenna Gain (dBi)	Polarization (H/V)	Result
1672	-48.24	-13	-35.24	-54.76	-50	1.35	5.25	V	Pass
2509	-50.62	-13	-37.62	-60.14	-53	1.58	6.11	V	Pass
5015	-47.82	-13	-34.82	-65.06	-54	2.08	10.41	V	Pass



Band :	WCDMA Band II	Temperature :	23~24°C
Test Mode :	RMC 12.2Kbps Link	Relative Humidity :	47~48%
Test Engineer :	Hayden Wu	Polarization :	Horizontal
Remark :	Spurious emissions within 30-1000MHz were found more than 20dB below limit line.		

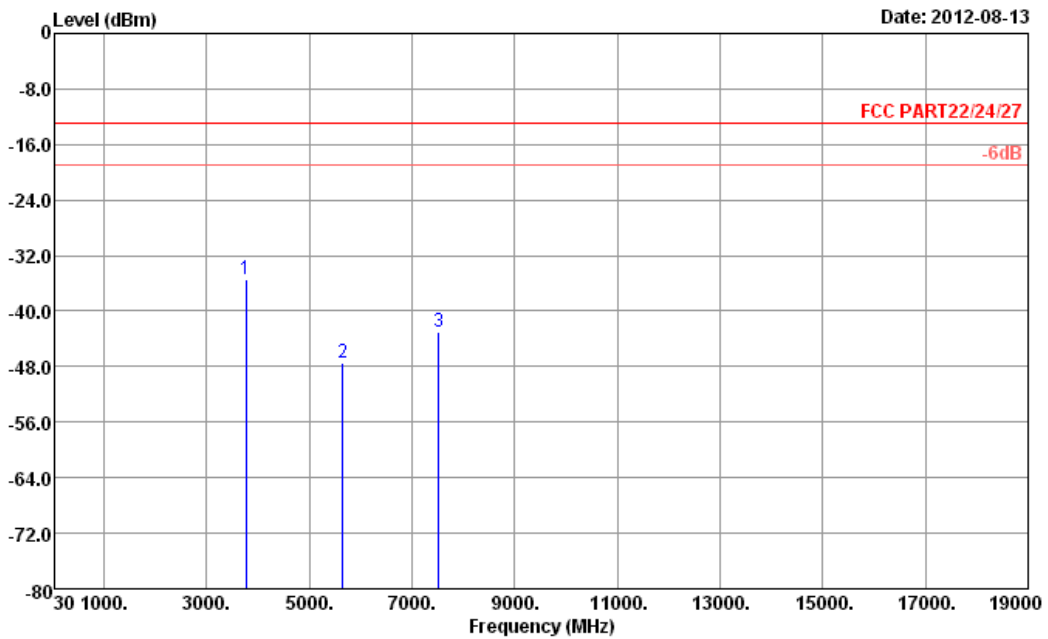

Site : 03CH05-HY
 Condition : FCC PART22/24/27 HF_EIRP_101221 HORIZONTAL

Frequency (MHz)	EIRP (dBm)	Limit (dBm)	Over Limit (dB)	SPA Reading (dBm)	S.G. Power (dBm)	TX Cable loss (dB)	TX Antenna Gain (dBi)	Polarization (H/V)	Result
3760	-35.39	-13	-22.39	-48.84	-42.1	2.00	8.71	H	Pass
5640	-47.56	-13	-34.56	-66.5	-56.2	2.13	10.77	H	Pass
7520	-43.01	-13	-30.01	-64.9	-52.55	2.68	12.22	H	Pass



Band :	WCDMA Band II	Temperature :	23~24°C
Test Mode :	RMC 12.2Kbps Link	Relative Humidity :	47~48%
Test Engineer :	Hayden Wu	Polarization :	Vertical
Remark :	Spurious emissions within 30-1000MHz were found more than 20dB below limit line.		

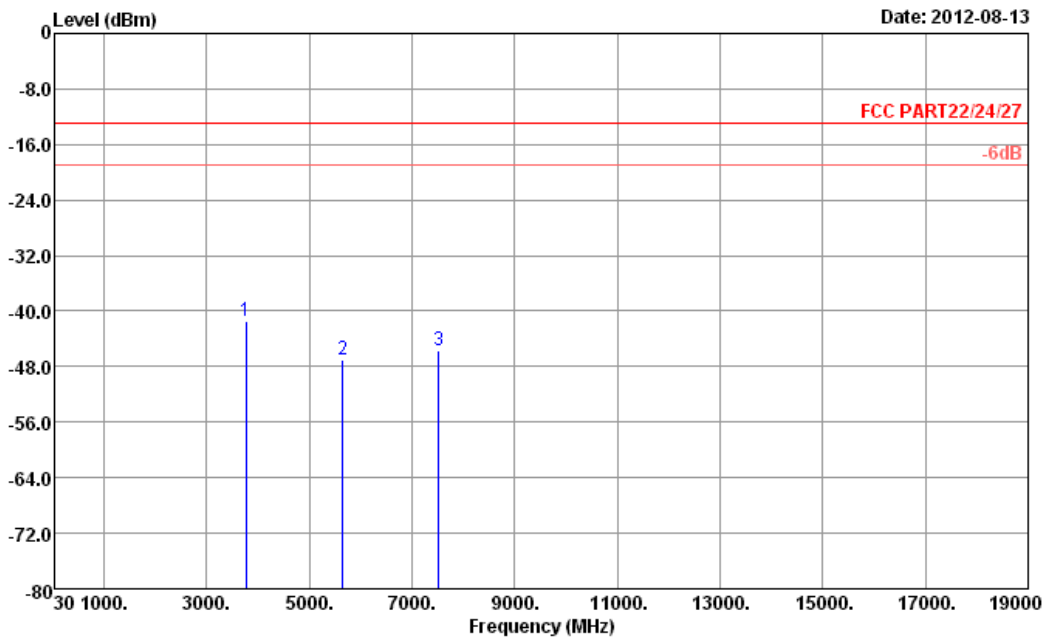

Site : 03CH05-HY
 Condition : FCC PART22/24/27 HF_EIRP_101221 VERTICAL

Frequency (MHz)	EIRP (dBm)	Limit (dBm)	Over Limit (dB)	SPA Reading (dBm)	S.G. Power (dBm)	TX Cable loss (dB)	TX Antenna Gain (dBi)	Polarization (H/V)	Result
3760	-41.39	-13	-28.39	-54.87	-48.1	2.00	8.71	V	Pass
5640	-47.00	-13	-34.00	-65.82	-55.64	2.13	10.77	V	Pass
7520	-45.76	-13	-32.76	-67.77	-55.3	2.68	12.22	V	Pass

3.7 Frequency Stability Measurement

3.7.1 Description of Frequency Stability Measurement

The frequency stability shall be measured by variation of ambient temperature and variation of primary supply voltage to ensure that the fundamental emission stays within the authorized frequency block. The frequency stability of the transmitter shall be maintained within $\pm 0.00025\%$ ($\pm 2.5\text{ppm}$) of the center frequency.

3.7.2 Measuring Instruments

See list of measuring instruments of this test report.

3.7.3 Test Procedures for Temperature Variation

1. The EUT was set up in the thermal chamber and connected with the base station.
2. With power OFF, the temperature was decreased to -30°C and the EUT was stabilized before testing. Power was applied and the maximum change in frequency was recorded within one minute.
3. With power OFF, the temperature was raised in 10°C step up to 50°C . The EUT was stabilized at each step for at least half an hour. Power was applied and the maximum frequency change was recorded within one minute.
4. If the EUT cannot be turned on at -30°C , the testing lowest temperature will be raised in 10°C step until the EUT can be turned on.

3.7.4 Test Procedures for Voltage Variation

1. The EUT was placed in a temperature chamber at $25\pm 5^{\circ}\text{C}$ and connected with the base station.
2. The power supply voltage to the EUT was varied from BEP to 115% of the nominal value measured at the input to the EUT.
3. The variation in frequency was measured for the worst case.

3.7.5 Test Setup

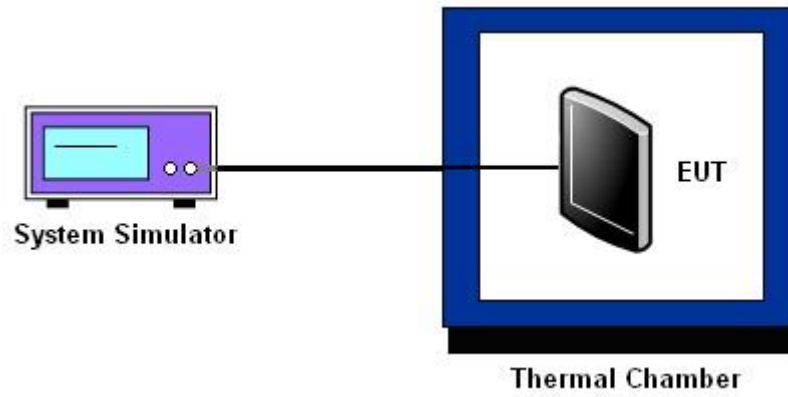



3.7.6 Test Result of Temperature Variation

Band :	GSM 850	Channel :	189
Limit (ppm) :	2.5	Frequency :	836.4 MHz

Temperature (°C)	GPRS 8		EDGE 8		Result
	Freq. Dev. (Hz)	Deviation (ppm)	Freq. Dev. (Hz)	Deviation (ppm)	
-30	40	0.05	51	0.06	PASS
-20	39	0.05	47	0.06	
-10	46	0.05	-44	-0.05	
0	52	0.06	48	0.06	
10	43	0.05	-37	-0.04	
20	32	0.04	38	0.04	
30	29	0.03	-33	-0.04	
40	28	0.03	-36	-0.04	
50	16	0.02	-35	-0.04	

Band :	GSM 1900	Channel :	661
Limit (ppm) :	2.5	Frequency :	1880.0 MHz

Temperature (°C)	GPRS 8		EDGE 8		Result
	Freq. Dev. (Hz)	Deviation (ppm)	Freq. Dev. (Hz)	Deviation (ppm)	
-30	86	0.05	91	0.05	PASS
-20	82	0.04	89	0.05	
-10	85	0.04	81	0.04	
0	89	0.05	94	0.05	
10	66	0.03	79	0.04	
20	56	0.03	66	0.03	
30	50	0.03	67	0.04	
40	55	0.03	74	0.04	
50	36	0.02	55	0.03	



Band :	WCDMA Band V	Channel :	4182
Limit (ppm) :	2.5	Frequency :	836.4 MHz

Temperature (°C)	RMC 12.2Kbps		Result
	Freq. Dev. (Hz)	Deviation (ppm)	
-30	-11	-0.01	PASS
-20	9	0.01	
-10	6	0.01	
0	11	0.01	
10	7	0.01	
20	7	0.01	
30	8	0.01	
40	8	0.01	
50	-7	-0.01	

Band :	WCDMA Band II	Channel :	9400
Limit (ppm) :	2.5	Frequency :	1880.0 MHz

Temperature (°C)	RMC 12.2Kbps		Result
	Freq. Dev. (Hz)	Deviation (ppm)	
-30	12	0.01	PASS
-20	10	0.01	
-10	11	0.01	
0	10	0.01	
10	11	0.01	
20	9	0.00	
30	11	0.01	
40	10	0.01	
50	12	0.01	



3.7.7 Test Result of Voltage Variation

Band & Channel	Mode	Voltage (Volt)	Freq. Dev. (Hz)	Deviation (ppm)	Limit (ppm)	Result
GSM 850 CH189	GPRS 8	12.0	28	0.03	2.5	PASS
		BEP	22	0.03		
		20.0	28	0.03		
	EDGE 8	12.0	21	0.02		
		BEP	-14	-0.02		
		20.0	34	0.04		
GSM 1900 CH661	GPRS 8	12.0	68	0.04		
		BEP	65	0.03		
		20.0	73	0.04		
	EDGE 8	12.0	65	0.03		
		BEP	62	0.03		
		20.0	69	0.04		
WCDMA Band V CH4182	RMC 12.2Kbps	12.0	6	0.01		
		BEP	5	0.01		
		20.0	-6	-0.01		
WCDMA Band II CH9400	RMC 12.2Kbps	12.0	10	0.01		
		BEP	8	0.00		
		20.0	11	0.01		

Note:

1. Normal Voltage = 12.0V.
2. Battery End Point (BEP) = 8.0 V.



4 List of Measuring Equipment

Instrument	Manufacturer	Model No.	Serial No.	Characteristics	Calibration Date	Test Date	Due Date	Remark
System Simulator	R&S	CMU200	117995	N/A	Jul. 30, 2012	Aug. 06, 2012	Jul. 29, 2013	Conducted (TH02-HY)
Spectrum Analyzer	R&S	FSP40	100055	9kHz~40GHz	Jun. 06, 2012	Aug. 06, 2012	Jun. 05, 2013	Conducted (TH02-HY)
Thermal Chamber	Ten Billion	TTH-D3SP	TBN-930701	N/A	Jul. 23, 2012	Aug. 06, 2012	Jul. 22, 2013	Conducted (TH02-HY)
Spectrum Analyzer	R&S	ESU26	100390	20Hz ~ 26.5GHz	Dec. 22, 2011	Aug. 13, 2012	Dec. 21, 2012	Radiation (03CH05-HY)
Bilog Antenna	SCHAFFNER	CBL6111C	2725	30MHz ~ 2GHz	Oct. 22, 2011	Aug. 13, 2012	Oct. 21, 2012	Radiation (03CH05-HY)
Turn Table	HD	Deis HD 2000	420/611	0 ~ 360 degree	N/A	Aug. 13, 2012	N/A	Radiation (03CH05-HY)
Antenna Mast	HD	MA 240	240/666	1 m ~ 4 m	N/A	Aug. 13, 2012	N/A	Radiation (03CH05-HY)
Horn Antenna	ESCO	3117	66584	1GHz~18GHz	Aug. 10, 2012	Aug. 13, 2012	Aug. 09, 2013	Radiation (03CH05-HY)
Pre Amplifier	COM-POWER	PA-103A	161075	10Hz ~ 1000MHz Gain:32dB	Feb. 27, 2012	Aug. 13, 2012	Feb. 26, 2013	Radiation (03CH05-HY)
Pre Amplifier	MITEQ	AMF-7D-00 101800-30-1	159087	1GHz~18GHz	Feb. 27, 2012	Aug. 13, 2012	Feb. 26, 2013	Radiation (03CH05-HY)
Pre Amplifier	Agilent	8449B	3008A01917	1GHz~26.5GHz	Aug. 30, 2011	Aug. 13, 2012	Aug. 29, 2012	Radiation (03CH05-HY)
SHF-EHF Horn Antenna	SCHWARZBECK	BBHA 9170	BBHA917025 1	15GHz ~ 40GHz	Oct. 21, 2011	Aug. 13, 2012	Oct. 20, 2012	Radiation (03CH05-HY)
Loop Antenna	R&S	HFH2-Z2	860004/001	9 kHz~30 MHz	Jul. 03, 2012	Aug. 13, 2012	Jul. 02, 2014	Radiation (03CH05-HY)
System Simulator	R&S	CMU200	117995	N/A	Jul. 28, 2011	Aug. 13, 2012	Jul. 27, 2013	Radiation (03CH05-HY)



5 Uncertainty of Evaluation

Uncertainty of Radiated Emission Measurement (30 MHz ~ 1000 MHz)

Measuring Uncertainty for a Level of Confidence of 95% (U = 2Uc(y))	2.54
---	------

Uncertainty of Radiated Emission Measurement (1 GHz ~ 40 GHz)

Measuring Uncertainty for a Level of Confidence of 95% (U = 2Uc(y))	4.72
---	------



Appendix A. Photographs of EUT

Please refer to Sporton report number EP272508 as below.