



FCC TEST REPORT (CO-LOCATED)

REPORT NO.: RF971218L04E-1

MODEL NO.: 3G17Wn

RECEIVED: Jun. 24, 2009

TESTED: Jul. 16 ~ Jul. 20, 2009

ISSUED: Jul. 24, 2009

APPLICANT: NetComm Limited

ADDRESS: 2-6 Orion Road, Lane Cove, NSW 2066 Sydney
Australia

ISSUED BY: Bureau Veritas Consumer Products Services (H.K.)
Ltd., Taoyuan Branch

LAB ADDRESS: No. 47, 14th Ling, Chia Pau Tsuen, Lin Kou Hsiang,
Taipei Hsien 244, Taiwan, R.O.C.

TEST LOCATION: No. 19, Hwa Ya 2nd Rd, Wen Hwa Tsuen, Kwei
Shan Hsiang, Taoyuan Hsien 333, Taiwan, R.O.C.

This test report consists of 40 pages in total. It may be duplicated completely for legal use with the approval of the applicant. It should not be reproduced except in full, without the written approval of our laboratory. The client should not use it to claim product endorsement by TAF or any government agencies. The test results in the report only apply to the tested sample.





A D T

TABLE OF CONTENTS

1.	CERTIFICATION.....	3
2.	SUMMARY OF TEST RESULTS.....	4
2.1	MEASUREMENT UNCERTAINTY	4
3.	GENERAL INFORMATION	5
3.1	GENERAL DESCRIPTION OF EUT.....	5
3.2	DESCRIPTION OF TEST MODES.....	7
3.2.1	CONFIGURATION OF SYSTEM UNDER TEST	7
3.2.2	TEST MODE APPLICABILITY AND TESTED CHANNEL DETAIL.....	7
3.3	GENERAL DESCRIPTION OF APPLIED STANDARDS	10
3.4	DESCRIPTION OF SUPPORT UNITS.....	10
4.	TEST TYPES AND RESULTS.....	11
4.1	RADIATED EMISSION MEASUREMENT	11
4.1.1	LIMITS OF RADIATED EMISSION MEASUREMENT	11
4.1.2	TEST INSTRUMENTS	12
4.1.3	TEST PROCEDURES.....	13
4.1.4	DEVIATION FROM TEST STANDARD	13
4.1.5	TEST SETUP.....	14
4.1.6	EUT OPERATING CONDITIONS.....	14
4.1.7	TEST RESULTS	15
4.2	CONDUCTED EMISSION MEASUREMENT	27
4.2.1	LIMITS OF CONDUCTED EMISSION MEASUREMENT	27
4.2.2	TEST INSTRUMENTS	27
4.2.3	TEST PROCEDURES.....	28
4.2.4	DEVIATION FROM TEST STANDARD	28
4.2.5	TEST SETUP.....	29
4.2.6	EUT OPERATING CONDITIONS.....	29
4.2.7	TEST RESULTS	30
5.	PHOTOGRAPHS OF THE TEST CONFIGURATION.....	38
6.	INFORMATION ON THE TESTING LABORATORIES	39
7.	APPENDIX A - MODIFICATIONS RECORDERS FOR ENGINEERING CHANGES TO THE EUT BY THE LAB.....	40



1. CERTIFICATION

PRODUCT: Wireless 3G Router
MODEL: 3G17Wn
BRAND: NetComm
APPLICANT: NetComm Limited
TEST SAMPLE: R&D SAMPLE
TESTED: Jul. 16 ~ Jul. 20, 2009
STANDARDS: **FCC Part 15, Subpart C (Section 15.247)**
ANSI C63.4-2003

The above equipment (Model: 3G17Wn) has been tested by **Bureau Veritas Consumer Products Services (H.K.) Ltd., Taoyuan Branch**, and found compliance with the requirement of the above standards. The test record, data evaluation & Equipment Under Test (EUT) configurations represented herein are true and accurate accounts of the measurements of the sample's EMC characteristics under the conditions specified in this report.

PREPARED BY :  , **DATE** : Jul. 24, 2009
Joanna Wang / Senior Specialist

TECHNICAL ACCEPTANCE :  , **DATE** : Jul. 24, 2009
Responsible for RF Long Chen / Senior Engineer

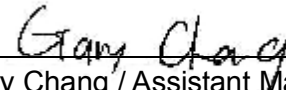
APPROVED BY :  , **DATE** : Jul. 24, 2009
Gary Chang / Assistant Manager

2. SUMMARY OF TEST RESULTS

The EUT has been tested according to the following specifications:

APPLIED STANDARD: FCC Part 15, Subpart C			
STANDARD SECTION	TEST TYPE AND LIMIT	RESULT	REMARK
15.207	AC Power Conducted Emission	PASS	Meet the requirement of limit. Minimum passing margin is -8.15dB at 0.369MHz.
15.247(d)	Radiated Emissions Limit: Table 15.209	PASS	Meet the requirement of limit. Minimum passing margin is -2.20dB at 2384.00MHz.

2.1 MEASUREMENT UNCERTAINTY

Where relevant, the following measurement uncertainty levels have been estimated for tests performed on the EUT as specified in CISPR 16-4-2:

MEASUREMENT	FREQUENCY	UNCERTAINTY
Conducted emissions	150kHz~30MHz	2.44dB
Radiated emissions	30MHz ~ 200MHz	2.93dB
	200MHz ~1000MHz	2.95dB
	1GHz ~ 18GHz	2.26dB
	18GHz ~ 40GHz	1.94dB

This uncertainty represents an expanded uncertainty expressed at approximately the 95% confidence level using a coverage factor of $k = 2$.



A D T

3. GENERAL INFORMATION

3.1 GENERAL DESCRIPTION OF EUT

PRODUCT	Wireless 3G Router
MODEL NO.	3G17Wn
FCC ID	XIA-3G17WN
POWER SUPPLY	12Vdc from adapter
MODULATION TYPE	CCK, DQPSK, DBPSK for DSSS 64QAM, 16QAM, QPSK, BPSK for OFDM
MODULATION TECHNOLOGY	DSSS, OFDM
TRANSFER RATE	802.11b: 11.0/ 5.5/ 2.0/ 1.0Mbps 802.11g: 54.0/ 48.0/ 36.0/ 24.0/ 18.0/ 12.0/ 9.0/ 6.0Mbps Draft 802.11n: up to 300Mbps
OPERATING FREQUENCY	2412MHz ~ 2462MHz
NUMBER OF CHANNEL	11 for 802.11b, 802.11g, draft 802.11n (20MHz) 7 for draft 802.11n (40MHz)
MAXIMUM OUTPUT POWER	338.065mW
ANTENNA TYPE	Dipole antenna with 2dBi gain
DATA CABLE	NA
I/O PORTS	RJ45, USB
ACCESSORY DEVICES	Adapter

NOTE:

1. The EUT provides one completed transmitter and one receiver.

MODULATION MODE	TX FUNCTION
802.11b	1TX
802.11g	1TX
Draft 802.11n (20MHz)	1TX
Draft 802.11n (40MHz)	1TX

2. The EUT was operated with following power adapters:

ADAPTER 1	
BRAND:	AMIGO
MODEL:	AMS6-1201000SU
INPUT:	120Vac, 60Hz, 0.5A
OUTPUT:	12Vdc, 1.0A
POWER LINE:	1.8m non-shielded cable without core



ADAPTER 2	
BRAND:	DVE
MODEL:	DSA-12G-12 FUS 120120
INPUT:	100-240Vac, 50/60Hz, 0.3A
OUTPUT:	12Vdc, 1.0A
POWER LINE:	1.8m non-shielded cable without core

ADAPTER 3	
BRAND:	Powertron
MODEL:	PA1015-2HU
INPUT:	100-240Vac, 50-60Hz, 0.4A
OUTPUT:	12Vdc, 1.25A
POWER LINE:	1.8m non-shielded cable without core

ADAPTER 4	
BRAND:	DVE
MODEL:	DSA-15P-12 US 120150
INPUT:	100-240Vac, 50/60Hz, 0.5A
OUTPUT:	12Vdc, 1.25A
POWER LINE:	1.8m non-shielded cable without core

3. USB port of EUT can support 3G Mobile USB dongle, we choice 3 typical dongle which have been sold to the market to confirm inter-modulation between 3G Mobile and 802.11 n.
4. The above EUT information was declared by manufacturer and for more detailed features description, please refer to the manufacturer's specifications or user's manual.

3.2 DESCRIPTION OF TEST MODES

11 channels are provided for 802.11b, 802.11g and draft 802.11n (20MHz):

CHANNEL	FREQUENCY	CHANNEL	FREQUENCY
1	2412MHz	7	2442MHz
2	2417MHz	8	2447MHz
3	2422MHz	9	2452MHz
4	2427MHz	10	2457MHz
5	2432MHz	11	2462MHz
6	2437MHz		

7 channels are provided for draft 802.11n (40MHz):

CHANNEL	FREQUENCY	CHANNEL	FREQUENCY
1	2422MHz	5	2442MHz
2	2427MHz	6	2447MHz
3	2432MHz	7	2452MHz
4	2437MHz		

3.2.1 CONFIGURATION OF SYSTEM UNDER TEST

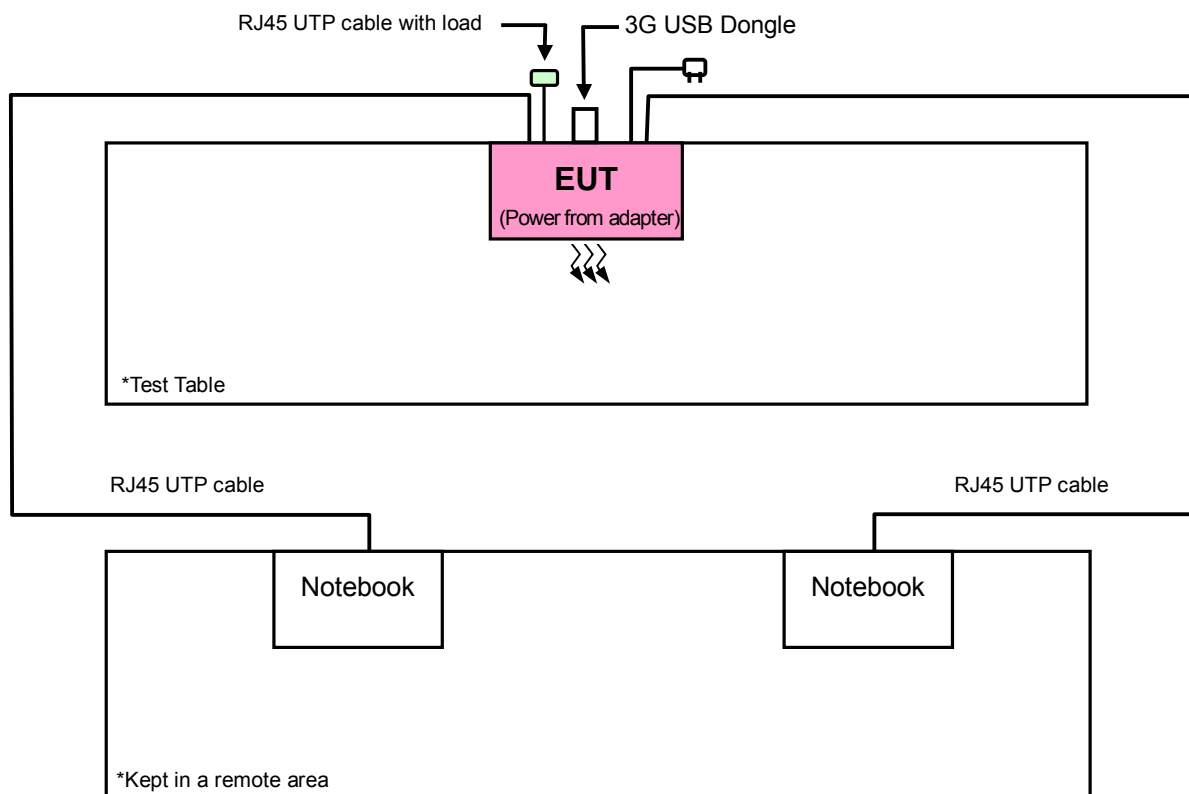

3.2.2 TEST MODE APPLICABILITY AND TESTED CHANNEL DETAIL

EUT CONFIGURE MODE	APPLICABLE TO			DESCRIPTION
	RE ³ 1G	RE<1G	CE	
A	√	√	√	3G USB Dongle Model: 888U (FCC ID: N7NC888)
B	√	√	√	3G USB Dongle Model: E176 (FCC ID: QISE176)
C	√	√	√	3G USB Dongle Model: MD300 (FCC ID: PY7F3232021)

Where **RE³1G**: Radiated Emission above 1GHz **RE<1G**: Radiated Emission below 1GHz
CE: Conducted Emission Measurement

NOTE: Test modes as below are composed of the max output power channel of each band.

RADIATED EMISSION TEST (ABOVE 1GHz):

- Pre-Scan has been conducted to determine the worst-case mode from all possible combinations between available modulations, data rates, XYZ axis and antenna ports (if EUT with antenna diversity architecture).
- Following channel(s) was (were) selected for the final test as listed below.

EUT CONFIGURE MODE	MODE	FREQ. RANGE (MHz)	AVAILABLE CHANNEL	TESTED CHANNEL	MODULATION TECHNOLOGY	MODULATION TYPE	DATA RATE (Mbps)	AXIS
A	802.11g + WCDMA850	2412-2462	1 to 11	6 + 4182	OFDM	BPSK	6.0	Z
		826.4~846.6	4132 to 4233		-	QPSK	-	
	802.11g + WCDMA1900	2412~2462	1 to 11	6 + 9262	OFDM	BPSK	6.0	Z
		1852.4~1907.6	9262 to 9538		-	QPSK	-	
B	802.11g + WCDMA850	2412~2462	1 to 11	6 + 4132	OFDM	BPSK	6.0	Z
		826.4~846.6	4132 to 4233		-	QPSK	-	
C	802.11g + WCDMA850	2412~2462	1 to 11	6 + 4182	OFDM	BPSK	6.0	Z
		826.4~846.6	4132 to 4233		-	QPSK	-	

RADIATED EMISSION TEST (BELOW 1GHz):

- Pre-Scan has been conducted to determine the worst-case mode from all possible combinations between available modulations, data rates, XYZ axis and antenna ports (if EUT with antenna diversity architecture).
- Following channel(s) was (were) selected for the final test as listed below.

EUT CONFIGURE MODE	MODE	FREQ. RANGE (MHz)	AVAILABLE CHANNEL	TESTED CHANNEL	MODULATION TECHNOLOGY	MODULATION TYPE	DATA RATE (Mbps)	AXIS
A	802.11g + WCDMA850	2412~2462	1 to 11	6 + 4182	OFDM	BPSK	6.0	Z
		826.4~846.6	4132 to 4233		-	QPSK	-	
	802.11g + WCDMA1900	2412~2462	1 to 11	6 + 9262	OFDM	BPSK	6.0	
		1852.4~1907.6	9262 to 9538		-	QPSK	-	
B	802.11g + WCDMA850	2412~2462	1 to 11	6 + 4132	OFDM	BPSK	6.0	
		826.4~846.6	4132 to 4233		-	QPSK	-	
C	802.11g + WCDMA850	2412~2462	1 to 11	6 + 4182	OFDM	BPSK	6.0	
		826.4~846.6	4132 to 4233		-	QPSK	-	

CONDUCTED EMISSION TEST:

- Pre-Scan has been conducted to determine the worst-case mode from all possible combinations between available modulations, data rates and antenna ports (if EUT with antenna diversity architecture).
- Following channel(s) was (were) selected for the final test as listed below.

EUT CONFIGURE MODE	MODE	FREQ. RANGE (MHz)	AVAILABLE CHANNEL	TESTED CHANNEL	MODULATION TECHNOLOGY	MODULATION TYPE	DATA RATE (Mbps)
A	802.11g + WCDMA850	2412~2462	1 to 11	6 + 4182	OFDM	BPSK	6.0
		826.4~846.6	4132 to 4233		-	QPSK	-
	802.11g + WCDMA1900	2412~2462	1 to 11	6 + 9262	OFDM	BPSK	6.0
		1852.4~1907.6	9262 to 9538		-	QPSK	-
B	802.11g + WCDMA850	2412~2462	1 to 11	6 + 4132	OFDM	BPSK	6.0
		826.4~846.6	4132 to 4233		-	QPSK	-
C	802.11g + WCDMA850	2412~2462	1 to 11	6 + 4182	OFDM	BPSK	6.0
		826.4~846.6	4132 to 4233		-	QPSK	-

3.3 GENERAL DESCRIPTION OF APPLIED STANDARDS

The EUT is a RF Product. According to the specifications of the manufacturer, it must comply with the requirements of the following standards:

FCC Part 15, Subpart C (Section 15.247)

ANSI C63.4-2003

All test items have been performed and recorded as per the above standards.

NOTE: The EUT is also considered as a kind of computer peripheral, because the connection to computer is necessary for typical use. It has been verified to comply with the requirements of FCC Part 15, Subpart B, Class B (DoC). The test report has been issued separately.

3.4 DESCRIPTION OF SUPPORT UNITS

The EUT has been tested as an independent unit together with other necessary accessories or support units. The following support units or accessories were used to form a representative test configuration during the tests.

NO.	PRODUCT	BRAND	MODEL NO.	SERIAL NO.	FCC ID
1	NOTEBOOK	DELL	PP05L	12130898320	E2K24CLNS
2	NOTEBOOK	DELL	PP05L	9954115984	E2K24CLNS
3	3G USB DONGLE	Sierra Aircard	888U	NA	N7NC888
4	3G USB DONGLE	HUAWEI	E176	NA	QISE176
5	3G USB DONGLE	Sony Ericsson	MD300	NA	PY7F3232021

NO.	SIGNAL CABLE DESCRIPTION OF THE ABOVE SUPPORT UNITS
1	10m UTP RJ45 cable
2	10m UTP RJ45 cable
3	NA
4	NA
5	NA

NOTE: 1. All power cords of the above support units are non shielded (1.8m).
 2. Item 1-2 acted as a communication partner to transfer data.
 3. Item 3-5 were provided by client.

4. TEST TYPES AND RESULTS

4.1 RADIATED EMISSION MEASUREMENT

4.1.1 LIMITS OF RADIATED EMISSION MEASUREMENT

Emissions radiated outside of the specified bands, shall be according to the general radiated limits in 15.209 as following:

FREQUENCIES (MHz)	FIELD STRENGTH (microvolts/meter)	MEASUREMENT DISTANCE (meters)
0.009 ~ 0.490	2400/F(kHz)	300
0.490 ~ 1.705	24000/F(kHz)	30
1.705 ~ 30.0	30	30
30 ~ 88	100	3
88 ~ 216	150	3
216 ~ 960	200	3
Above 960	500	3

NOTE:

1. The lower limit shall apply at the transition frequencies.
2. Emission level (dBuV/m) = 20 log Emission level (uV/m).
3. As shown in 15.35(b), for frequencies above 1000MHz, the field strength limits are based on average detector, however, the peak field strength of any emission shall not exceed the maximum permitted average limits, specified above by more than 20dB under any condition of modulation.



4.1.2 TEST INSTRUMENTS

DESCRIPTION & MANUFACTURER	MODEL NO.	SERIAL NO.	DATE OF CALIBRATION	DUE DATE OF CALIBRATION
Test Receiver ROHDE & SCHWARZ	ESIB7	100212	May 25, 2009	May 24, 2010
Spectrum Analyzer ROHDE & SCHWARZ	FSP40	100269	Aug. 08, 2008	Aug. 07, 2009
BILOG Antenna SCHWARZBECK	VULB9168	9168-156	Apr. 30, 2009	Apr. 29, 2010
HORN Antenna SCHWARZBECK	BBHA 9120 D	9120D-563	Aug. 06, 2008	Aug. 05, 2009
HORN Antenna SCHWARZBECK	BBHA 9170	BBHA9170242	Jan. 06, 2009	Jan. 05, 2010
Preamplifier Agilent	8449B	3008A01911	Sep. 10, 2008	Sep. 09, 2009
Preamplifier Agilent	8447D	2944A10638	Dec. 26, 2008	Dec. 25, 2009
RF signal cable HUBER+SUHNER	SUCOFLEX 104	218190/4 231241/4	May 13, 2009	May 12, 2010
RF signal cable Worken	8D-FB	Cable-HYCH9-01	Aug. 09, 2008	Aug. 08, 2009
Software	ADT_Radiated_ V7.6.15.9.2	NA	NA	NA
Antenna Tower EMCO	2070/2080	512.835.4684	NA	NA
Turn Table EMCO	2087-2.03	NA	NA	NA
Antenna Tower & Turn Table Controller EMCO	2090	NA	NA	NA

- NOTE:**
1. The calibration interval of the above test instruments is 12 months and the calibrations are traceable to NML/ROC and NIST/USA.
 2. The test was performed in HwaYa Chamber 9.
 3. The horn antenna and HP preamplifier (model: 8449B) are used only for the measurement of emission frequency above 1GHz if tested.
 4. The FCC Site Registration No. is 460141.
 5. The IC Site Registration No. is IC 7450F-4.

4.1.3 TEST PROCEDURES

- a. The EUT was placed on the top of a rotating table 0.8 meters above the ground at a 3 meters semi-anechoic chamber. The table was rotated 360 degrees to determine the position of the highest radiation.
- b. The EUT was set 3 meters away from the interference-receiving antenna, which was mounted on the top of a variable-height antenna tower.
- c. The antenna is a broadband antenna, and its height is varied from one meter to four meters above the ground to determine the maximum value of the field strength. Both horizontal and vertical polarizations of the antenna are set to make the measurement.
- d. For each suspected emission, the EUT was arranged to its worst case and then the antenna was tuned to heights from 1 meter to 4 meters and the rotatable table was turned from 0 degrees to 360 degrees to find the maximum reading.
- e. The test-receiver system was set to Peak Detect Function and Specified Bandwidth with Maximum Hold Mode.
- f. If the emission level of the EUT in peak mode was lower than the limit specified, then testing could be stopped and the peak values of the EUT would be reported. Otherwise the emissions would be re-tested one by one using peak, quasi-peak or average method as specified and then reported in a data sheet.

NOTE:

1. The resolution bandwidth and video bandwidth of test receiver/spectrum analyzer is 120kHz for Quasi-peak detection at frequency below 1GHz.
2. The resolution bandwidth of test receiver/spectrum analyzer is 1MHz and video bandwidth is 3MHz for Peak detection at frequency above 1GHz.
3. All modes of operation were investigated and the worst-case emissions are reported.

4.1.4 DEVIATION FROM TEST STANDARD

No deviation.

4.1.5 TEST SETUP

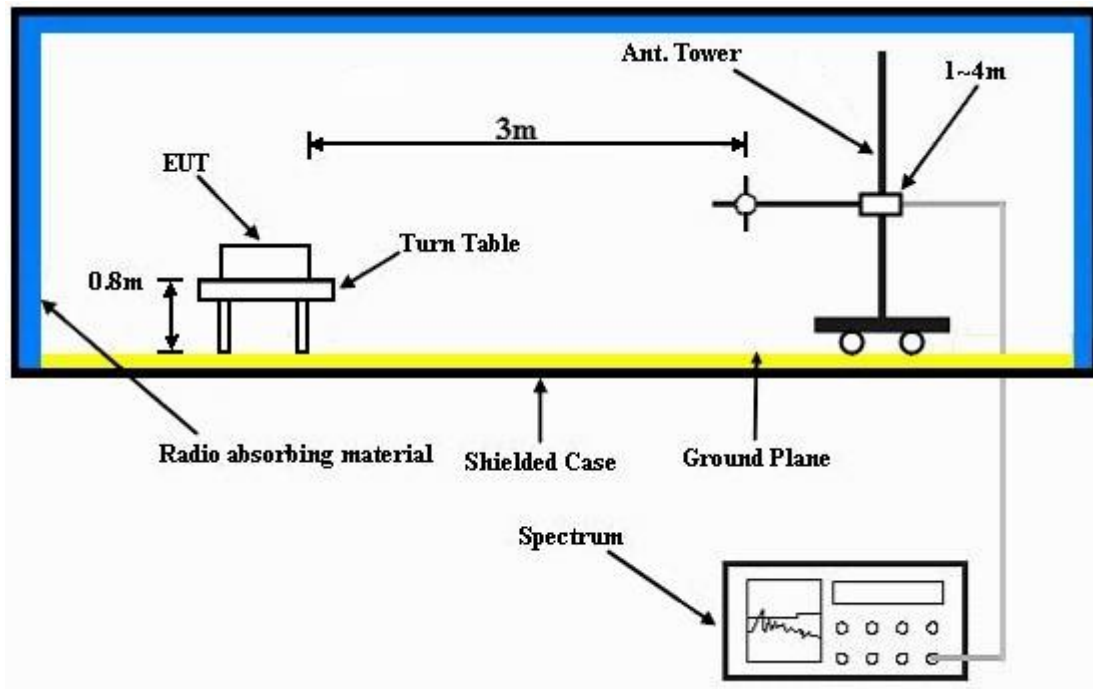

For the actual test configuration, please refer to the attached file (Test Setup Photo).

4.1.6 EUT OPERATING CONDITIONS

- a. Placed the EUT on the testing table.
- b. Prepared notebook systems to act as a communication partner and placed them outside of testing area.
- c. The communication partners connected with EUT via a RJ45 cable and run a test program (provided by manufacturer) to enable EUT under transmission condition continuously at specific channel frequency.
- d. The necessary accessories enable the EUT in full functions.

4.1.7 TEST RESULTS

802.11g OFDM MODULATION + WCDMA850

EUT TEST CONDITION		MEASUREMENT DETAIL	
CHANNEL	CH 6 + CH 4182	FREQUENCY RANGE	1 ~ 25GHz
INPUT POWER	120Vac, 60 Hz	DETECTOR FUNCTION	Peak (PK) Average (AV)
ENVIRONMENTAL CONDITIONS	23deg. C, 70%RH 1002 hPa	TESTED BY	Lori Chiu
TEST MODE	A		

ANTENNA POLARITY & TEST DISTANCE: HORIZONTAL AT 3 M								
No.	Freq. (MHz)	Emission Level (dBuV/m)	Limit (dBuV/m)	Margin (dB)	Antenna Height (m)	Table Angle (Degree)	Raw Value (dBuV)	Correction Factor (dB/m)
1	1672.80	45.54 PK	82.22	-36.68	1.00 H	4	15.75	29.79
2	2384.00	57.64 PK	74.00	-16.36	1.46 H	320	25.44	32.20
3	2384.00	47.49 AV	54.00	-6.51	1.46 H	320	15.29	32.20
4	*2437.00	107.44 PK			1.46 H	320	75.05	32.39
5	*2437.00	96.61 AV			1.46 H	320	64.22	32.39
6	2489.00	57.55 PK	74.00	-16.45	1.46 H	322	24.97	32.58
7	2489.00	46.90 AV	54.00	-7.10	1.46 H	322	14.32	32.58
8	#2506.00	64.12 PK	87.44	-23.32	1.00 H	339	31.48	32.64
9	#2506.00	51.52 AV	76.61	-25.09	1.00 H	339	18.88	32.64
10	3341.00	61.63 PK	82.22	-20.59	1.25 H	285	26.85	34.78
11	4874.00	51.54 PK	74.00	-22.46	1.06 H	60	13.13	38.41
12	4874.00	37.39 AV	54.00	-16.61	1.06 H	60	-1.02	38.41
13	7311.00	62.67 PK	74.00	-11.33	1.20 H	187	18.03	44.64
14	7311.00	48.37 AV	54.00	-5.63	1.20 H	187	3.73	44.64

- REMARKS:**
1. Emission level (dBuV/m) = Raw Value (dBuV) + Correction Factor (dB/m).
 2. Correction Factor (dB/m) = Antenna Factor (dB/m) + Cable Factor (dB).
 3. The other emission levels were very low against the limit.
 4. Margin value = Emission level – Limit value.
 5. “ * “: Fundamental frequency.
 6. The limit value of point 1 and point 10 is defined as per 22.917.
 7. “#”: The radiated frequency is out the restricted band.



A D T

EUT TEST CONDITION		MEASUREMENT DETAIL	
CHANNEL	CH 6 + CH 4182	FREQUENCY RANGE	1 ~ 25GHz
INPUT POWER	120Vac, 60 Hz	DETECTOR FUNCTION	Peak (PK) Average (AV)
ENVIRONMENTAL CONDITIONS	23deg. C, 70%RH 1002 hPa	TESTED BY	Lori Chiu
TEST MODE	A		

ANTENNA POLARITY & TEST DISTANCE: VERTICAL AT 3 M								
No.	Freq. (MHz)	Emission Level (dBuV/m)	Limit (dBuV/m)	Margin (dB)	Antenna Height (m)	Table Angle (Degree)	Raw Value (dBuV)	Correction Factor (dB/m)
1	1672.80	43.87 PK	82.22	-38.35	1.10 V	108	14.08	29.79
2	2384.00	63.92 PK	74.00	-10.08	1.02 V	130	31.72	32.20
3	2384.00	51.80 AV	54.00	-2.20	1.02 V	130	19.60	32.20
4	*2437.00	114.29 PK			1.02 V	130	81.90	32.39
5	*2437.00	104.31 AV			1.02 V	130	71.92	32.39
6	2489.00	64.94 PK	74.00	-9.06	1.02 V	133	32.36	32.58
7	2489.00	51.42 AV	54.00	-2.58	1.02 V	133	18.84	32.58
8	#2506.00	56.78 PK	94.29	-37.51	1.01 V	6	24.14	32.64
9	\$2506.00	44.52 AV	84.31	-39.79	1.01 V	6	11.88	32.64
10	3345.00	61.14 PK	82.22	-21.08	1.15 V	100	26.36	34.78
11	4874.00	51.76 PK	74.00	-22.24	1.21 V	71	13.35	38.41
12	4874.00	38.25 AV	54.00	-15.75	1.21 V	71	-0.16	38.41
13	7311.00	61.35 PK	74.00	-12.65	1.36 V	280	16.71	44.64
14	7311.00	47.11 AV	54.00	-6.89	1.36 V	280	2.47	44.64

- REMARKS:**
1. Emission level (dBuV/m) = Raw Value (dBuV) + Correction Factor (dB/m).
 2. Correction Factor (dB/m) = Antenna Factor (dB/m) + Cable Factor (dB).
 3. The other emission levels were very low against the limit.
 4. Margin value = Emission level – Limit value.
 5. “ * “: Fundamental frequency.
 6. The limit value of point 1 and point 10 is defined as per 22.917.
 7. “#”: The radiated frequency is out the restricted band.



A D T

EUT TEST CONDITION		MEASUREMENT DETAIL	
CHANNEL	CH 6 + CH 4132	FREQUENCY RANGE	1 ~ 25GHz
INPUT POWER	120Vac, 60 Hz	DETECTOR FUNCTION	Peak (PK) Average (AV)
ENVIRONMENTAL CONDITIONS	23deg. C, 70%RH 1002 hPa	TESTED BY	Lori Chiu
TEST MODE	B		

ANTENNA POLARITY & TEST DISTANCE: HORIZONTAL AT 3 M								
No.	Freq. (MHz)	Emission Level (dBuV/m)	Limit (dBuV/m)	Margin (dB)	Antenna Height (m)	Table Angle (Degree)	Raw Value (dBuV)	Correction Factor (dB/m)
1	1652.80	45.37 PK	82.22	-36.82	1.11 H	243	15.64	29.73
2	2384.00	57.55 PK	74.00	-16.45	1.00 H	20	25.35	32.20
3	2384.00	47.37 AV	54.00	-6.63	1.00 H	20	15.17	32.20
4	*2437.00	107.23 PK			1.00 H	20	74.84	32.39
5	*2437.00	96.40 AV			1.00 H	20	64.01	32.39
6	2479.20	46.55 PK	82.22	-35.67	1.20 H	354	14.00	32.55
7	2489.00	57.34 PK	74.00	-16.66	1.00 H	20	24.76	32.58
8	2489.00	46.71 AV	54.00	-7.29	1.00 H	20	14.13	32.58
9	3263.00	45.37 PK	74.00	-28.63	1.27 H	87	10.72	34.65
10	3263.00	34.77 AV	54.00	-19.23	1.27 H	87	0.12	34.65
11	4874.00	50.33 PK	74.00	-23.67	1.30 H	5	11.92	38.41
12	4874.00	36.91 AV	54.00	-17.09	1.30 H	5	-1.50	38.41
13	7311.00	62.67 PK	74.00	-11.33	1.07 H	169	18.03	44.64
14	7311.00	48.38 AV	54.00	-5.62	1.07 H	169	3.74	44.64

- REMARKS:**
1. Emission level (dBuV/m) = Raw Value (dBuV) + Correction Factor (dB/m).
 2. Correction Factor (dB/m) = Antenna Factor (dB/m) + Cable Factor (dB).
 3. The other emission levels were very low against the limit.
 4. Margin value = Emission level – Limit value.
 5. “ * ”: Fundamental frequency.
 6. The limit value of point 1 and point 6 are defined as per 22.917.



A D T

EUT TEST CONDITION		MEASUREMENT DETAIL	
CHANNEL	CH 6 + CH 4132	FREQUENCY RANGE	1 ~ 25GHz
INPUT POWER	120Vac, 60 Hz	DETECTOR FUNCTION	Peak (PK) Average (AV)
ENVIRONMENTAL CONDITIONS	23deg. C, 70%RH 1002 hPa	TESTED BY	Lori Chiu
TEST MODE	B		

ANTENNA POLARITY & TEST DISTANCE: VERTICAL AT 3 M								
No.	Freq. (MHz)	Emission Level (dBuV/m)	Limit (dBuV/m)	Margin (dB)	Antenna Height (m)	Table Angle (Degree)	Raw Value (dBuV)	Correction Factor (dB/m)
1	1652.00	43.79 PK	82.22	-38.43	1.11 V	153	14.06	29.73
2	2384.00	63.88 PK	74.00	-10.12	1.03 V	109	31.68	32.20
3	2384.00	51.62 AV	54.00	-2.38	1.03 V	109	19.42	32.20
4	*2437.00	114.17 PK			1.03 V	109	81.78	32.39
5	*2437.00	104.13 AV			1.03 V	109	71.74	32.39
6	2479.20	43.30 PK	82.22	-41.92	1.01 V	211	10.75	32.55
7	2489.00	64.21 PK	74.00	-9.79	1.03 V	109	31.63	32.58
8	2489.00	50.50 AV	54.00	-3.50	1.03 V	109	17.92	32.58
9	3263.00	46.31 PK	74.00	-27.69	1.02 V	310	11.66	34.65
10	3263.00	33.21 AV	54.00	-20.79	1.02 V	310	-1.44	34.65
11	4874.00	51.59 PK	74.00	-22.41	1.11 V	167	13.18	38.41
12	4874.00	38.02 AV	54.00	-15.98	1.11 V	167	-0.39	38.41
13	7311.00	61.33 PK	74.00	-12.67	1.00 V	100	16.69	44.64
14	7311.00	46.93 AV	54.00	-7.07	1.00 V	100	2.29	44.64

- REMARKS:**
1. Emission level (dBuV/m) = Raw Value (dBuV) + Correction Factor (dB/m).
 2. Correction Factor (dB/m) = Antenna Factor (dB/m) + Cable Factor (dB).
 3. The other emission levels were very low against the limit.
 4. Margin value = Emission level – Limit value.
 5. “ * “: Fundamental frequency.
 6. The limit value of point 1 and point 6 are defined as per 22.917.



A D T

EUT TEST CONDITION		MEASUREMENT DETAIL	
CHANNEL	CH 6 + CH 4182	FREQUENCY RANGE	1 ~ 25GHz
INPUT POWER	120Vac, 60 Hz	DETECTOR FUNCTION	Peak (PK) Average (AV)
ENVIRONMENTAL CONDITIONS	23deg. C, 70%RH 1002 hPa	TESTED BY	Lori Chiu
TEST MODE	C		

ANTENNA POLARITY & TEST DISTANCE: HORIZONTAL AT 3 M								
No.	Freq. (MHz)	Emission Level (dBuV/m)	Limit (dBuV/m)	Margin (dB)	Antenna Height (m)	Table Angle (Degree)	Raw Value (dBuV)	Correction Factor (dB/m)
1	#1280.00	54.40 PK	87.21	-32.81	1.05 H	227	26.03	28.37
2	#1280.00	44.85 AV	76.37	-31.52	1.05 H	227	16.48	28.37
3	1672.80	50.01 PK	82.22	-32.21	1.22 H	108	20.22	29.79
4	2384.00	57.66 PK	74.00	-16.34	1.09 H	61	25.46	32.20
5	2384.00	47.39 AV	54.00	-6.61	1.09 H	61	15.19	32.20
6	*2437.00	107.21 PK			1.11 H	350	74.82	32.39
7	*2437.00	96.37 AV			1.11 H	350	63.98	32.39
8	2489.00	57.41 PK	74.00	-16.59	1.11 H	350	24.83	32.58
9	2489.00	46.88 AV	54.00	-7.12	1.11 H	350	14.30	32.58
10	#2519.00	49.37 PK	87.21	-37.84	1.05 H	220	16.68	32.69
11	#2519.00	47.41 AV	76.37	-28.96	1.05 H	220	14.72	32.69
12	4874.00	51.37 PK	74.00	-22.63	1.26 H	319	12.96	38.41
13	4874.00	37.08 AV	54.00	-16.92	1.26 H	319	-1.33	38.41
14	7311.00	62.48 PK	74.00	-11.52	1.01 H	286	17.84	44.64
15	7311.00	48.34 AV	54.00	-5.66	1.01 H	286	3.70	44.64

- REMARKS:**
1. Emission level (dBuV/m) = Raw Value (dBuV) + Correction Factor (dB/m).
 2. Correction Factor (dB/m) = Antenna Factor (dB/m) + Cable Factor (dB).
 3. The other emission levels were very low against the limit.
 4. Margin value = Emission level – Limit value.
 5. “ * “: Fundamental frequency.
 6. The limit value of point 3 is defined as per 22.917.
 7. "#": The radiated frequency is out the restricted band.



A D T

EUT TEST CONDITION		MEASUREMENT DETAIL	
CHANNEL	CH 6 + CH 4182	FREQUENCY RANGE	1 ~ 25GHz
INPUT POWER	120Vac, 60 Hz	DETECTOR FUNCTION	Peak (PK) Average (AV)
ENVIRONMENTAL CONDITIONS	23deg. C, 70%RH 1002 hPa	TESTED BY	Lori Chiu
TEST MODE	C		

ANTENNA POLARITY & TEST DISTANCE: VERTICAL AT 3 M								
No.	Freq. (MHz)	Emission Level (dBuV/m)	Limit (dBuV/m)	Margin (dB)	Antenna Height (m)	Table Angle (Degree)	Raw Value (dBuV)	Correction Factor (dB/m)
1	#1280.00	54.76 PK	94.11	-39.35	1.01 V	115	26.39	28.37
2	#1280.00	43.20 AV	84.16	-40.96	1.01 V	115	14.83	28.37
3	1672.80	43.46 PK	82.22	-38.76	1.11 V	157	13.67	29.79
4	2384.00	63.74 PK	74.00	-10.26	1.00 V	97	31.54	32.20
5	2384.00	51.70 AV	54.00	-2.30	1.00 V	97	19.50	32.20
6	*2437.00	114.11 PK			1.00 V	97	81.72	32.39
7	*2437.00	104.16 AV			1.00 V	97	71.77	32.39
8	2489.00	64.86 PK	74.00	-9.14	1.00 V	97	32.28	32.58
9	2489.00	51.33 AV	54.00	-2.67	1.00 V	97	18.75	32.58
10	#2519.00	42.63 PK	94.11	-51.48	1.33 V	54	9.94	32.69
11	#2519.00	36.30 AV	84.16	-47.86	1.33 V	54	3.61	32.69
12	4874.00	51.74 PK	74.00	-22.26	1.05 V	268	13.33	38.41
13	4874.00	38.39 AV	54.00	-15.61	1.05 V	268	-0.02	38.41
14	7311.00	61.27 PK	74.00	-12.73	1.01 V	69	16.63	44.64
15	7311.00	46.90 AV	54.00	-7.10	1.01 V	69	2.26	44.64

- REMARKS:**
1. Emission level (dBuV/m) = Raw Value (dBuV) + Correction Factor (dB/m).
 2. Correction Factor (dB/m) = Antenna Factor (dB/m) + Cable Factor (dB).
 3. The other emission levels were very low against the limit.
 4. Margin value = Emission level – Limit value.
 5. " * ": Fundamental frequency.
 6. The limit value of point 3 is defined as per 22.917.
 7. "#": The radiated frequency is out the restricted band.

802.11g OFDM MODULATION + WCDMA1900

EUT TEST CONDITION		MEASUREMENT DETAIL	
CHANNEL	CH 6 + CH 9262	FREQUENCY RANGE	1 ~ 25GHz
INPUT POWER	120Vac, 60 Hz	DETECTOR FUNCTION	Peak (PK) Average (AV)
ENVIRONMENTAL CONDITIONS	23deg. C, 70%RH 1002 hPa	TESTED BY	Lori Chiu
TEST MODE	A		

ANTENNA POLARITY & TEST DISTANCE: HORIZONTAL AT 3 M								
No.	Freq. (MHz)	Emission Level (dBuV/m)	Limit (dBuV/m)	Margin (dB)	Antenna Height (m)	Table Angle (Degree)	Raw Value (dBuV)	Correction Factor (dB/m)
1	*1852.40	120.97 PK			1.24 H	51	90.67	30.30
2	2384.00	57.69 PK	74.00	-16.31	1.53 H	325	25.49	32.20
3	2384.00	47.52 AV	54.00	-6.48	1.53 H	325	15.32	32.20
4	*2437.00	107.46 PK			1.53 H	325	75.07	32.39
5	*2437.00	96.58 AV			1.53 H	325	64.19	32.39
6	2489.00	57.41 PK	74.00	-16.59	1.50 H	320	24.83	32.58
7	2489.00	46.80 AV	54.00	-7.20	1.50 H	320	14.22	32.58
8	3704.80	65.11 PK	82.22	-17.11	1.11 H	12	29.57	35.54
9	4874.00	51.67 PK	74.00	-22.33	1.36 H	208	13.26	38.41
10	4874.00	37.14 AV	54.00	-16.86	1.36 H	208	-1.27	38.41
11	7311.00	62.37 PK	74.00	-11.63	1.09 H	75	17.73	44.64
12	7311.00	48.09 AV	54.00	-5.91	1.09 H	75	3.45	44.64

- REMARKS:**
1. Emission level (dBuV/m) = Raw Value (dBuV) + Correction Factor (dB/m).
 2. Correction Factor (dB/m) = Antenna Factor (dB/m) + Cable Factor (dB).
 3. The other emission levels were very low against the limit.
 4. Margin value = Emission level – Limit value.
 5. “ * “: Fundamental frequency.
 6. The limit value of point 8 is defined as per 24.238.



A D T

EUT TEST CONDITION		MEASUREMENT DETAIL	
CHANNEL	CH 6 + CH 9262	FREQUENCY RANGE	1 ~ 25GHz
INPUT POWER	120Vac, 60 Hz	DETECTOR FUNCTION	Peak (PK) Average (AV)
ENVIRONMENTAL CONDITIONS	23deg. C, 70%RH 1002 hPa	TESTED BY	Lori Chiu
TEST MODE	A		

ANTENNA POLARITY & TEST DISTANCE: VERTICAL AT 3 M								
No.	Freq. (MHz)	Emission Level (dBuV/m)	Limit (dBuV/m)	Margin (dB)	Antenna Height (m)	Table Angle (Degree)	Raw Value (dBuV)	Correction Factor (dB/m)
1	*1852.40	118.71 PK			1.08 V	55	88.41	30.30
2	2384.00	63.61 PK	74.00	-10.39	1.01 V	100	31.41	32.20
3	2384.00	51.51 AV	54.00	-2.49	1.01 V	100	19.31	32.20
4	*2437.00	114.42 PK			1.01 V	100	82.03	32.39
5	*2437.00	104.20 AV			1.01 V	100	71.81	32.39
6	2489.00	64.88 PK	74.00	-9.12	1.01 V	105	32.30	32.58
7	2489.00	51.37 AV	54.00	-2.63	1.01 V	105	18.79	32.58
8	3704.80	62.70 PK	82.22	-19.52	1.00 V	188	27.16	35.54
9	4874.00	51.71 PK	74.00	-22.29	1.22 V	157	13.30	38.41
10	4874.00	38.20 AV	54.00	-15.80	1.22 V	157	-0.21	38.41
11	7311.00	61.31 PK	74.00	-12.69	1.20 V	354	16.67	44.64
12	7311.00	46.97 AV	54.00	-7.03	1.20 V	354	2.33	44.64

- REMARKS:**
1. Emission level (dBuV/m) = Raw Value (dBuV) + Correction Factor (dB/m).
 2. Correction Factor (dB/m) = Antenna Factor (dB/m) + Cable Factor (dB).
 3. The other emission levels were very low against the limit.
 4. Margin value = Emission level – Limit value.
 5. “ * “: Fundamental frequency.
 6. The limit value of point 8 is defined as per 24.238.

BELOW 1GHz DATA :

802.11g OFDM MODULATION + WCDMA850

EUT TEST CONDITION		MEASUREMENT DETAIL	
CHANNEL	CH 6 + CH 4182	FREQUENCY RANGE	Below 1000MHz
INPUT POWER	120Vac, 60 Hz	DETECTOR FUNCTION	Quasi-Peak (QP) Peak (PK)
ENVIRONMENTAL CONDITIONS	23deg. C, 70%RH 1002 hPa	TESTED BY	Lori Chiu
TEST MODE	A		

ANTENNA POLARITY & TEST DISTANCE: HORIZONTAL AT 3 M								
No.	Freq. (MHz)	Emission Level (dBuV/m)	Limit (dBuV/m)	Margin (dB)	Antenna Height (m)	Table Angle (Degree)	Raw Value (dBuV)	Correction Factor (dB/m)
1	249.60	34.75 QP	46.00	-11.25	1.00 H	277	21.93	12.81
2	426.53	30.72 QP	46.00	-15.28	1.00 H	142	13.78	16.94
3	533.47	34.40 QP	46.00	-11.60	1.25 H	238	14.14	20.26
4	640.41	36.75 QP	46.00	-9.25	1.25 H	46	14.52	22.24
5	747.34	30.95 QP	46.00	-15.05	1.00 H	10	7.07	23.88
6	854.28	42.19 QP	46.00	-3.81	1.00 H	154	16.52	25.67
7	*836.40	118.93 PK			1.02 H	334	93.38	25.55
ANTENNA POLARITY & TEST DISTANCE: VERTICAL AT 3 M								
No.	Freq. (MHz)	Emission Level (dBuV/m)	Limit (dBuV/m)	Margin (dB)	Antenna Height (m)	Table Angle (Degree)	Raw Value (dBuV)	Correction Factor (dB/m)
1	64.90	36.98 QP	40.00	-3.02	1.50 V	268	24.49	12.49
2	99.89	36.40 QP	43.50	-7.10	1.50 V	148	27.07	9.33
3	426.53	30.81 QP	46.00	-15.19	1.00 V	259	13.87	16.94
4	533.47	39.14 QP	46.00	-6.86	1.00 V	322	18.87	20.26
5	640.41	37.32 QP	46.00	-8.68	1.50 V	337	15.08	22.24
6	854.28	38.12 QP	46.00	-7.88	1.50 V	172	12.44	25.67
7	*836.40	114.15 PK			1.01 V	335	88.60	25.55

- REMARKS:**
1. Emission level(dBuV/m)=Raw Value(dBuV) + Correction Factor(dB/m)
 2. Correction Factor(dB/m) = Antenna Factor (dB/m) + Cable Factor (dB)
 3. The other emission levels were very low against the limit.
 4. Margin value = Emission level – Limit value.
 5. “ * “: Fundamental frequency.



A D T

EUT TEST CONDITION		MEASUREMENT DETAIL	
CHANNEL	CH 6 + CH 4132	FREQUENCY RANGE	Below 1000MHz
INPUT POWER	120Vac, 60 Hz	DETECTOR FUNCTION	Quasi-Peak (QP) Peak (PK)
ENVIRONMENTAL CONDITIONS	23deg. C, 70%RH 1002 hPa	TESTED BY	Lori Chiu
TEST MODE	B		

ANTENNA POLARITY & TEST DISTANCE: HORIZONTAL AT 3 M								
No.	Freq. (MHz)	Emission Level (dBuV/m)	Limit (dBuV/m)	Margin (dB)	Antenna Height (m)	Table Angle (Degree)	Raw Value (dBuV)	Correction Factor (dB/m)
1	119.34	31.10 QP	43.50	-12.40	1.75 H	259	19.43	11.67
2	144.61	35.73 QP	43.50	-7.77	2.00 H	109	22.57	13.16
3	249.60	35.70 QP	46.00	-10.30	1.00 H	277	22.89	12.81
4	533.47	37.25 QP	46.00	-8.75	1.50 H	337	16.99	20.26
5	640.41	37.06 QP	46.00	-8.94	1.25 H	46	14.82	22.24
6	854.28	39.74 QP	46.00	-6.26	1.00 H	61	14.07	25.67
7	*826.40	118.20 PK			1.00 H	118	92.72	25.48
ANTENNA POLARITY & TEST DISTANCE: VERTICAL AT 3 M								
No.	Freq. (MHz)	Emission Level (dBuV/m)	Limit (dBuV/m)	Margin (dB)	Antenna Height (m)	Table Angle (Degree)	Raw Value (dBuV)	Correction Factor (dB/m)
1	30.00	34.12 QP	40.00	-5.88	1.75 V	247	21.84	12.28
2	64.90	34.09 QP	40.00	-5.91	1.00 V	256	21.60	12.49
3	99.89	34.52 QP	43.50	-8.98	1.25 V	130	25.19	9.33
4	533.47	39.21 QP	46.00	-6.79	1.00 V	325	18.95	20.26
5	630.69	38.94 QP	46.00	-7.06	1.00 V	88	16.78	22.16
6	854.28	38.08 QP	46.00	-7.92	1.25 V	340	12.40	25.67
7	*836.40	112.63 PK			1.35 V	50	87.08	25.55

- REMARKS:**
1. Emission level(dBuV/m)=Raw Value(dBuV) + Correction Factor(dB/m)
 2. Correction Factor(dB/m) = Antenna Factor (dB/m) + Cable Factor (dB)
 3. The other emission levels were very low against the limit.
 4. Margin value = Emission level – Limit value.
 5. " * " : Fundamental frequency.



A D T

EUT TEST CONDITION		MEASUREMENT DETAIL	
CHANNEL	CH 6 + CH 4182	FREQUENCY RANGE	Below 1000MHz
INPUT POWER	120Vac, 60 Hz	DETECTOR FUNCTION	Quasi-Peak (QP) Peak (PK)
ENVIRONMENTAL CONDITIONS	23deg. C, 70%RH 1002 hPa	TESTED BY	Lori Chiu
TEST MODE	C		

ANTENNA POLARITY & TEST DISTANCE: HORIZONTAL AT 3 M								
No.	Freq. (MHz)	Emission Level (dBuV/m)	Limit (dBuV/m)	Margin (dB)	Antenna Height (m)	Table Angle (Degree)	Raw Value (dBuV)	Correction Factor (dB/m)
1	212.66	29.74 QP	43.50	-13.76	1.25 H	226	18.59	11.16
2	249.60	35.96 QP	46.00	-10.04	1.00 H	289	23.15	12.81
3	533.47	36.66 QP	46.00	-9.34	1.50 H	337	16.40	20.26
4	640.41	36.55 QP	46.00	-9.45	1.25 H	43	14.31	22.24
5	854.28	39.73 QP	46.00	-6.27	1.00 H	52	14.06	25.67
6	961.21	40.65 QP	54.00	-13.35	1.00 H	37	14.11	26.54
7	*836.40	120.33 PK			1.19 H	311	94.78	25.55
ANTENNA POLARITY & TEST DISTANCE: VERTICAL AT 3 M								
No.	Freq. (MHz)	Emission Level (dBuV/m)	Limit (dBuV/m)	Margin (dB)	Antenna Height (m)	Table Angle (Degree)	Raw Value (dBuV)	Correction Factor (dB/m)
1	55.18	32.29 QP	40.00	-7.71	1.75 V	76	18.75	13.53
2	64.90	32.68 QP	40.00	-7.32	1.50 V	223	20.19	12.49
3	99.89	33.98 QP	43.50	-9.52	1.00 V	142	24.65	9.33
4	533.47	39.06 QP	46.00	-6.94	1.00 V	325	18.80	20.26
5	640.41	37.67 QP	46.00	-8.33	1.50 V	334	15.43	22.24
6	854.28	38.16 QP	46.00	-7.84	1.00 V	124	12.49	25.67
7	*836.40	115.37 PK			1.06 V	360	89.82	25.55

- REMARKS:**
1. Emission level(dBuV/m)=Raw Value(dBuV) + Correction Factor(dB/m)
 2. Correction Factor(dB/m) = Antenna Factor (dB/m) + Cable Factor (dB)
 3. The other emission levels were very low against the limit.
 4. Margin value = Emission level – Limit value.
 5. " * " : Fundamental frequency.



A D T

802.11g OFDM MODULATION + WCDMA1900

EUT TEST CONDITION		MEASUREMENT DETAIL	
CHANNEL	CH 6 + CH 9262	FREQUENCY RANGE	Below 1000MHz
INPUT POWER	120Vac, 60 Hz	DETECTOR FUNCTION	Quasi-Peak (QP)
ENVIRONMENTAL CONDITIONS	23deg. C, 70%RH 1002 hPa	TESTED BY	Lori Chiu
TEST MODE	A		

ANTENNA POLARITY & TEST DISTANCE: HORIZONTAL AT 3 M

No.	Freq. (MHz)	Emission Level (dBuV/m)	Limit (dBuV/m)	Margin (dB)	Antenna Height (m)	Table Angle (Degree)	Raw Value (dBuV)	Correction Factor (dB/m)
1	64.90	25.41 QP	40.00	-14.59	1.50 H	256	12.92	12.49
2	249.60	35.79 QP	46.00	-10.21	1.00 H	280	22.98	12.81
3	533.47	36.70 QP	46.00	-9.30	1.50 H	343	16.44	20.26
4	640.41	36.19 QP	46.00	-9.81	1.50 H	46	13.96	22.24
5	747.34	31.18 QP	46.00	-14.82	1.00 H	10	7.30	23.88
6	854.28	42.56 QP	46.00	-3.44	1.00 H	58	16.89	25.67

ANTENNA POLARITY & TEST DISTANCE: VERTICAL AT 3 M

No.	Freq. (MHz)	Emission Level (dBuV/m)	Limit (dBuV/m)	Margin (dB)	Antenna Height (m)	Table Angle (Degree)	Raw Value (dBuV)	Correction Factor (dB/m)
1	55.18	31.80 QP	40.00	-8.20	1.00 V	10	18.27	13.53
2	66.84	36.43 QP	40.00	-3.57	1.00 V	262	24.30	12.13
3	99.89	35.39 QP	43.50	-8.11	1.00 V	139	26.06	9.33
4	533.47	39.25 QP	46.00	-6.75	1.00 V	322	18.99	20.26
5	640.41	37.60 QP	46.00	-8.40	1.50 V	340	15.36	22.24
6	854.28	35.85 QP	46.00	-10.15	1.50 V	187	10.18	25.67

- REMARKS:**
1. Emission level(dBuV/m)=Raw Value(dBuV) + Correction Factor(dB/m)
 2. Correction Factor(dB/m) = Antenna Factor (dB/m) + Cable Factor (dB)
 3. The other emission levels were very low against the limit.
 4. Margin value = Emission level – Limit value.

4.2 CONDUCTED EMISSION MEASUREMENT

4.2.1 LIMITS OF CONDUCTED EMISSION MEASUREMENT

FREQUENCY OF EMISSION (MHz)	CONDUCTED LIMIT (dB μ V)	
	Quasi-peak	Average
0.15-0.5	66 to 56	56 to 46
0.5-5	56	46
5-30	60	50

- NOTE:**
1. The lower limit shall apply at the transition frequencies.
 2. The limit decreases in line with the logarithm of the frequency in the range of 0.15 to 0.50 MHz.
 3. All emanations from a class A/B digital device or system, including any network of conductors and apparatus connected thereto, shall not exceed the level of field strengths specified above.

4.2.2 TEST INSTRUMENTS

DESCRIPTION & MANUFACTURER	MODEL NO.	SERIAL NO.	DATE OF CALIBRATION	DUE DATE OF CALIBRATION
Test Receiver ROHDE & SCHWARZ	ESCS30	100288	Sep. 22, 2008	Sep. 21, 2009
RF signal cable Woken	5D-FB	Cable-HYCO2-01	Dec. 31, 2008	Dec. 30, 2009
LISN ROHDE & SCHWARZ	ESH2-Z5	100100	Dec. 29, 2008	Dec. 28, 2009
LISN ROHDE & SCHWARZ	ESH3-Z5	100311	Jul. 30, 2008	Jul. 29, 2009
Software ADT	ADT_Cond_ V7.3.7	NA	NA	NA

- NOTE:**
1. The calibration interval of the above test instruments is 12 months and the calibrations are traceable to NML/ROC and NIST/USA.
 2. The test was performed in HwaYa Shielded Room 2.
 3. The VCCI Site Registration No. is C-2047.

4.2.3 TEST PROCEDURES

- a. The EUT was placed 0.4 meters from the conducting wall of the shielded room with EUT being connected to the power mains through a line impedance stabilization network (LISN). Other support units were connected to the power mains through another LISN. The two LISNs provide 50 ohm/ 50uH of coupling impedance for the measuring instrument.
- b. Both lines of the power mains connected to the EUT were checked for maximum conducted interference.
- c. The frequency range from 150kHz to 30MHz was searched. Emission levels under (Limit - 20dB) was not recorded.

NOTE: All modes of operation were investigated and the worst-case emissions are reported.

4.2.4 DEVIATION FROM TEST STANDARD

No deviation.

4.2.5 TEST SETUP

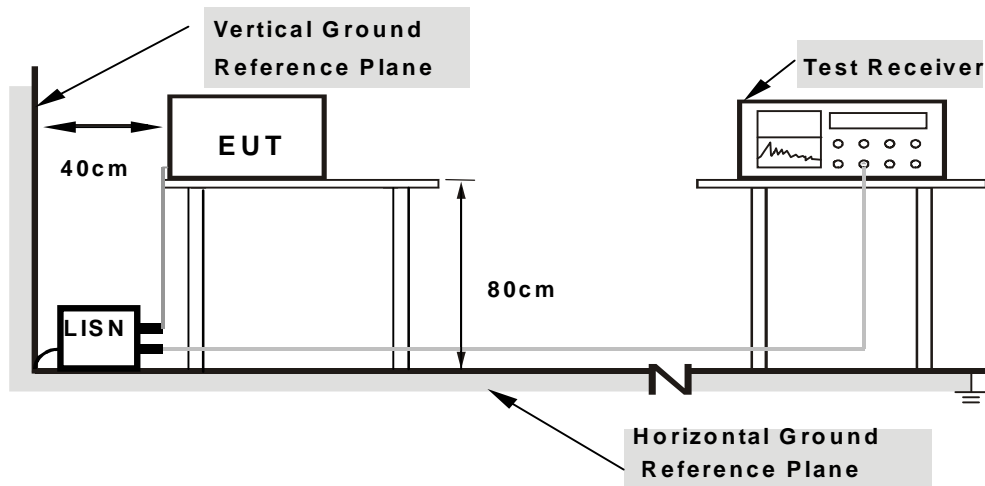

- Note:**
1. Support units were connected to second LISN.
 2. Both of LISNs (AMN) are 80 cm from EUT and at least 80 cm from other units and other metal planes

For the actual test configuration, please refer to the attached file (Test Setup Photo).

4.2.6 EUT OPERATING CONDITIONS

Same as 4.1.6.



A D T

4.2.7 TEST RESULTS

CONDUCTED WORST-CASE DATA: 802.11g OFDM MODULATION + WCDMA850

EUT TEST CONDITION		MEASUREMENT DETAIL	
CHANNEL	CH 6 + CH 4182	PHASE	Line 1
INPUT POWER	120Vac, 60Hz	6dB BANDWIDTH	9kHz
ENVIRONMENTAL CONDITIONS	20deg. C, 60%RH, 1007hPa	TESTED BY	Match Tsui
TEST MODE	A		

No	Freq. [MHz]	Corr. Factor (dB)	Reading Value [dB (uV)]		Emission Level [dB (uV)]		Limit [dB (uV)]		Margin (dB)	
			Q.P.	AV.	Q.P.	AV.	Q.P.	AV.	Q.P.	AV.
1	0.185	0.13	45.38	-	45.51	-	64.25	54.25	-18.74	-
2	0.369	0.14	49.30	40.07	49.44	40.21	58.53	48.53	-9.09	-8.32
3	0.982	0.17	37.78	-	37.95	-	56.00	46.00	-18.05	-
4	2.563	0.22	36.82	-	37.04	-	56.00	46.00	-18.96	-
5	4.098	0.28	34.43	-	34.71	-	56.00	46.00	-21.29	-
6	16.172	0.58	30.96	-	31.54	-	60.00	50.00	-28.46	-

- REMARKS:**
1. Q.P. and AV. are abbreviations of quasi-peak and average individually.
 2. "-": The Quasi-peak reading value also meets average limit and measurement with the average detector is unnecessary.
 3. The emission levels of other frequencies were very low against the limit.
 4. Margin value = Emission level - Limit value
 5. Correction factor = Insertion loss + Cable loss
 6. Emission Level = Correction Factor + Reading Value.

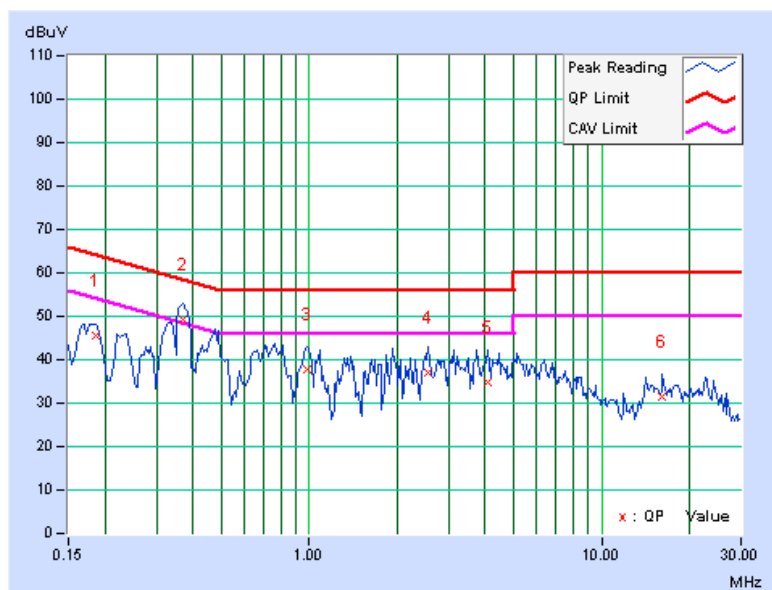



A D T

EUT TEST CONDITION		MEASUREMENT DETAIL	
CHANNEL	CH 6 + CH 4182	PHASE	Line 2
INPUT POWER	120Vac, 60Hz	6dB BANDWIDTH	9kHz
ENVIRONMENTAL CONDITIONS	20deg. C, 60%RH, 1007hPa	TESTED BY	Match Tsui
TEST MODE	A		

No	Freq. [MHz]	Corr. Factor (dB)	Reading Value [dB (uV)]		Emission Level [dB (uV)]		Limit [dB (uV)]		Margin (dB)	
			Q.P.	AV.	Q.P.	AV.	Q.P.	AV.	Q.P.	AV.
1	0.181	0.13	46.05	-	46.18	-	64.43	54.43	-18.25	-
2	0.361	0.15	45.40	-	45.55	-	58.71	48.71	-13.16	-
3	0.705	0.16	34.64	-	34.80	-	56.00	46.00	-21.20	-
4	1.625	0.19	34.09	-	34.28	-	56.00	46.00	-21.72	-
5	3.504	0.28	32.37	-	32.65	-	56.00	46.00	-23.35	-
6	14.352	0.64	28.30	-	28.94	-	60.00	50.00	-31.06	-

- REMARKS:**
1. Q.P. and AV. are abbreviations of quasi-peak and average individually.
 2. "-": The Quasi-peak reading value also meets average limit and measurement with the average detector is unnecessary.
 3. The emission levels of other frequencies were very low against the limit.
 4. Margin value = Emission level - Limit value
 5. Correction factor = Insertion loss + Cable loss
 6. Emission Level = Correction Factor + Reading Value.

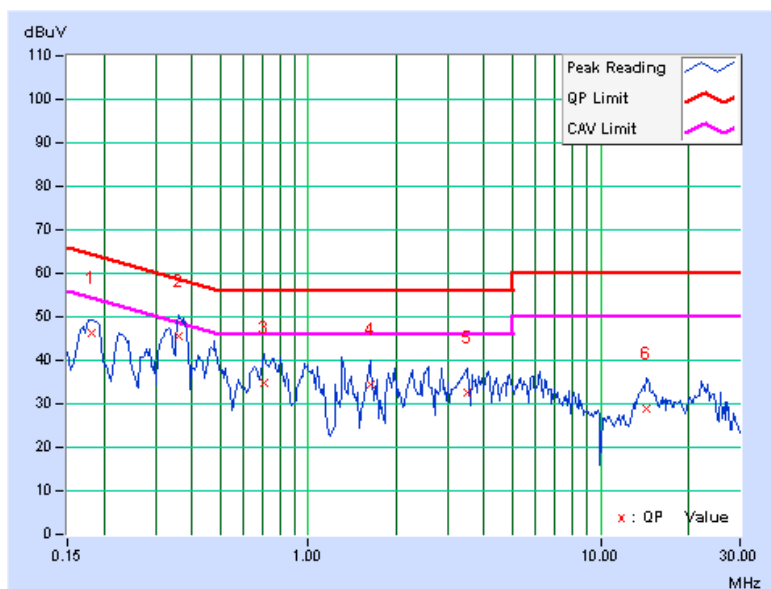



A D T

EUT TEST CONDITION		MEASUREMENT DETAIL	
CHANNEL	CH 6 + CH 4132	PHASE	Line 1
INPUT POWER	120Vac, 60Hz	6dB BANDWIDTH	9kHz
ENVIRONMENTAL CONDITIONS	20deg. C, 60%RH, 1007hPa	TESTED BY	Match Tsui
TEST MODE	B		

No	Freq. [MHz]	Corr. Factor (dB)	Reading Value [dB (uV)]		Emission Level [dB (uV)]		Limit [dB (uV)]		Margin (dB)	
			Q.P.	AV.	Q.P.	AV.	Q.P.	AV.	Q.P.	AV.
			1	0.185	0.13	46.29	-	46.42	-	64.25
2	0.365	0.14	49.34	39.34	49.48	39.48	58.62	48.62	-9.14	-9.14
3	0.998	0.17	38.43	-	38.60	-	56.00	46.00	-17.40	-
4	1.883	0.19	37.83	-	38.02	-	56.00	46.00	-17.98	-
5	2.871	0.23	36.50	-	36.73	-	56.00	46.00	-19.27	-
6	23.133	0.65	34.41	-	35.06	-	60.00	50.00	-24.94	-

- REMARKS:**
1. Q.P. and AV. are abbreviations of quasi-peak and average individually.
 2. "-": The Quasi-peak reading value also meets average limit and measurement with the average detector is unnecessary.
 3. The emission levels of other frequencies were very low against the limit.
 4. Margin value = Emission level - Limit value
 5. Correction factor = Insertion loss + Cable loss
 6. Emission Level = Correction Factor + Reading Value.

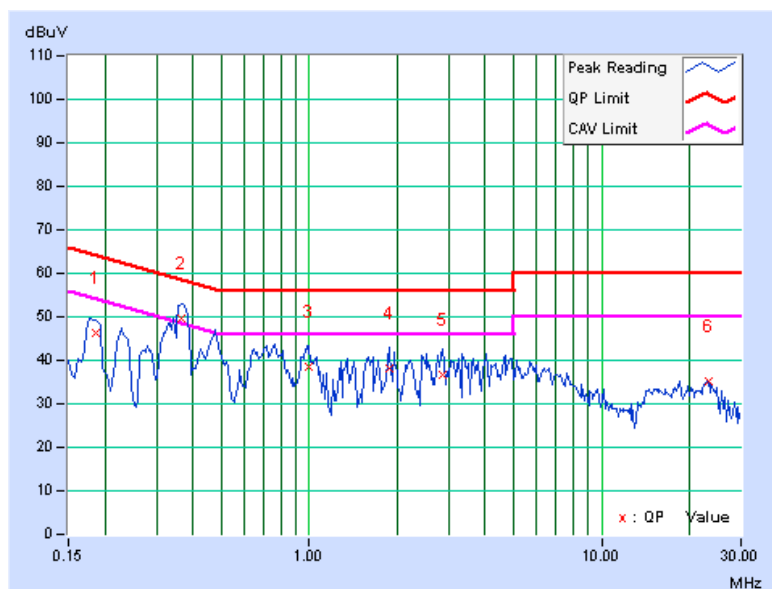



A D T

EUT TEST CONDITION		MEASUREMENT DETAIL	
CHANNEL	CH 6 + CH 4132	PHASE	Line 2
INPUT POWER	120Vac, 60Hz	6dB BANDWIDTH	9kHz
ENVIRONMENTAL CONDITIONS	20deg. C, 60%RH, 1007hPa	TESTED BY	Match Tsui
TEST MODE	B		

No	Freq. [MHz]	Corr. Factor (dB)	Reading Value [dB (uV)]		Emission Level [dB (uV)]		Limit [dB (uV)]		Margin (dB)	
			Q.P.	AV.	Q.P.	AV.	Q.P.	AV.	Q.P.	AV.
1	0.177	0.13	47.14	-	47.27	-	64.61	54.61	-17.34	-
2	0.373	0.15	45.28	-	45.43	-	58.44	48.44	-13.01	-
3	0.798	0.16	34.88	-	35.04	-	56.00	46.00	-20.96	-
4	1.953	0.20	33.42	-	33.62	-	56.00	46.00	-22.38	-
5	3.363	0.27	31.69	-	31.96	-	56.00	46.00	-24.04	-
6	14.590	0.65	27.85	-	28.50	-	60.00	50.00	-31.50	-

- REMARKS:**
1. Q.P. and AV. are abbreviations of quasi-peak and average individually.
 2. "-": The Quasi-peak reading value also meets average limit and measurement with the average detector is unnecessary.
 3. The emission levels of other frequencies were very low against the limit.
 4. Margin value = Emission level - Limit value
 5. Correction factor = Insertion loss + Cable loss
 6. Emission Level = Correction Factor + Reading Value.

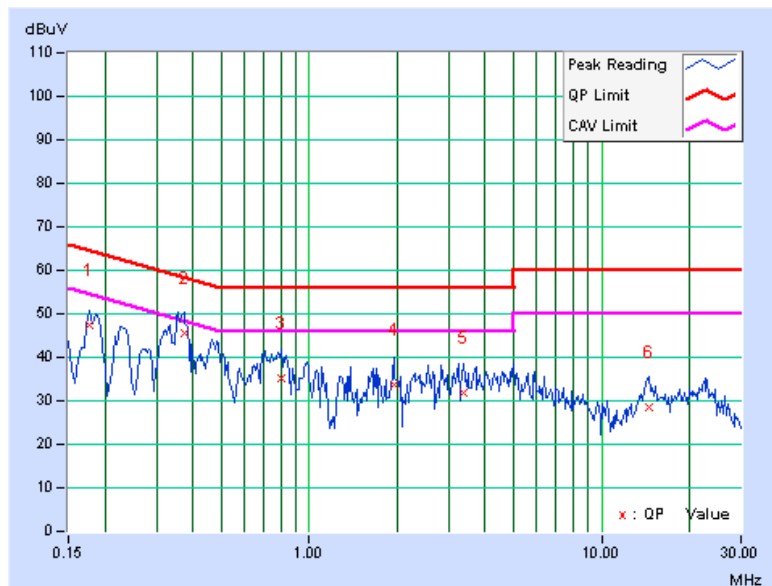



A D T

EUT TEST CONDITION		MEASUREMENT DETAIL	
CHANNEL	CH 6 + CH 4182	PHASE	Line 1
INPUT POWER	120Vac, 60Hz	6dB BANDWIDTH	9kHz
ENVIRONMENTAL CONDITIONS	20deg. C, 60%RH, 1007hPa	TESTED BY	Match Tsui
TEST MODE	C		

No	Freq. [MHz]	Corr. Factor (dB)	Reading Value [dB (uV)]		Emission Level [dB (uV)]		Limit [dB (uV)]		Margin (dB)	
			Q.P.	AV.	Q.P.	AV.	Q.P.	AV.	Q.P.	AV.
1	0.181	0.13	44.23	-	44.36	-	64.43	54.43	-20.07	-
2	0.369	0.14	49.40	40.24	49.54	40.38	58.53	48.53	-8.99	-8.15
3	0.767	0.16	39.45	-	39.61	-	56.00	46.00	-16.39	-
4	1.945	0.19	38.13	-	38.32	-	56.00	46.00	-17.68	-
5	3.477	0.26	35.78	-	36.04	-	56.00	46.00	-19.96	-
6	22.934	0.65	31.10	-	31.75	-	60.00	50.00	-28.25	-

- REMARKS:**
1. Q.P. and AV. are abbreviations of quasi-peak and average individually.
 2. "-": The Quasi-peak reading value also meets average limit and measurement with the average detector is unnecessary.
 3. The emission levels of other frequencies were very low against the limit.
 4. Margin value = Emission level - Limit value
 5. Correction factor = Insertion loss + Cable loss
 6. Emission Level = Correction Factor + Reading Value.

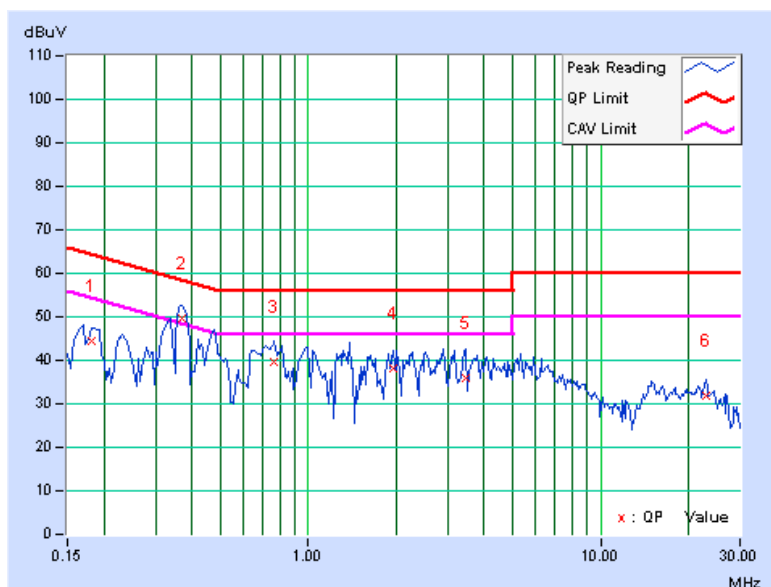



A D T

EUT TEST CONDITION		MEASUREMENT DETAIL	
CHANNEL	CH 6 + CH 4182	PHASE	Line 2
INPUT POWER	120Vac, 60Hz	6dB BANDWIDTH	9kHz
ENVIRONMENTAL CONDITIONS	20deg. C, 60%RH, 1007hPa	TESTED BY	Match Tsui
TEST MODE	C		

No	Freq. [MHz]	Corr. Factor (dB)	Reading Value [dB (uV)]		Emission Level [dB (uV)]		Limit [dB (uV)]		Margin (dB)	
			Q.P.	AV.	Q.P.	AV.	Q.P.	AV.	Q.P.	AV.
1	0.177	0.13	43.60	-	43.73	-	64.61	54.61	-20.88	-
2	0.367	0.15	45.50	-	45.65	-	58.56	48.56	-12.92	-
3	0.814	0.16	33.90	-	34.06	-	56.00	46.00	-21.94	-
4	2.219	0.21	33.48	-	33.69	-	56.00	46.00	-22.31	-
5	4.727	0.32	31.49	-	31.81	-	56.00	46.00	-24.19	-
6	22.586	0.80	29.17	-	29.97	-	60.00	50.00	-30.03	-

- REMARKS:**
1. Q.P. and AV. are abbreviations of quasi-peak and average individually.
 2. "-": The Quasi-peak reading value also meets average limit and measurement with the average detector is unnecessary.
 3. The emission levels of other frequencies were very low against the limit.
 4. Margin value = Emission level - Limit value
 5. Correction factor = Insertion loss + Cable loss
 6. Emission Level = Correction Factor + Reading Value.

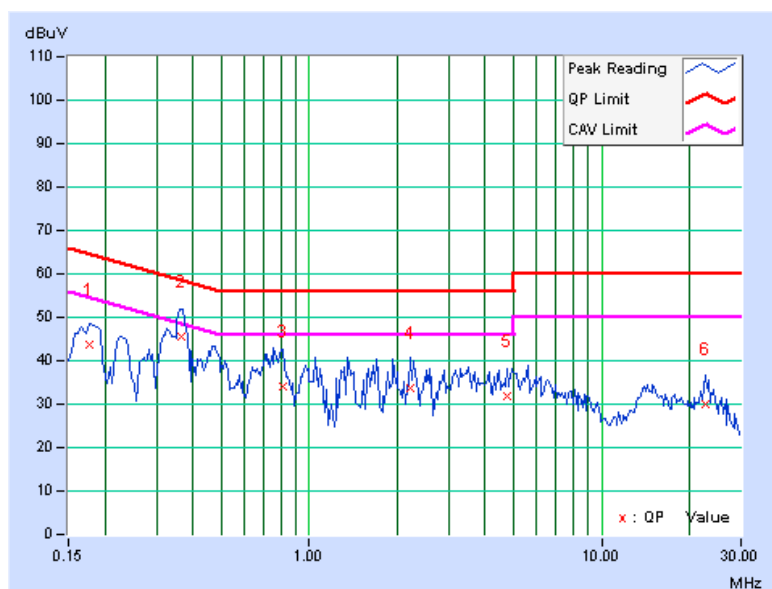



802.11g OFDM MODULATION + WCDMA1900

EUT TEST CONDITION		MEASUREMENT DETAIL	
CHANNEL	CH 6 + CH 4182	PHASE	Line 1
INPUT POWER	120Vac, 60Hz	6dB BANDWIDTH	9kHz
ENVIRONMENTAL CONDITIONS	20deg. C, 60%RH, 1007hPa	TESTED BY	Match Tsui
TEST MODE	A		

No	Freq. [MHz]	Corr. Factor (dB)	Reading Value [dB (uV)]		Emission Level [dB (uV)]		Limit [dB (uV)]		Margin (dB)	
			Q.P.	AV.	Q.P.	AV.	Q.P.	AV.	Q.P.	AV.
1	0.185	0.13	44.15	-	44.28	-	64.25	54.25	-19.97	-
2	0.377	0.14	45.08	-	45.22	-	58.35	48.35	-13.14	-
3	0.748	0.16	35.34	-	35.50	-	56.00	46.00	-20.50	-
4	1.594	0.18	33.38	-	33.56	-	56.00	46.00	-22.44	-
5	4.129	0.28	31.99	-	32.27	-	56.00	46.00	-23.73	-
6	14.355	0.54	27.90	-	28.44	-	60.00	50.00	-31.56	-

- REMARKS:**
1. Q.P. and AV. are abbreviations of quasi-peak and average individually.
 2. "-": The Quasi-peak reading value also meets average limit and measurement with the average detector is unnecessary.
 3. The emission levels of other frequencies were very low against the limit.
 4. Margin value = Emission level - Limit value
 5. Correction factor = Insertion loss + Cable loss
 6. Emission Level = Correction Factor + Reading Value.

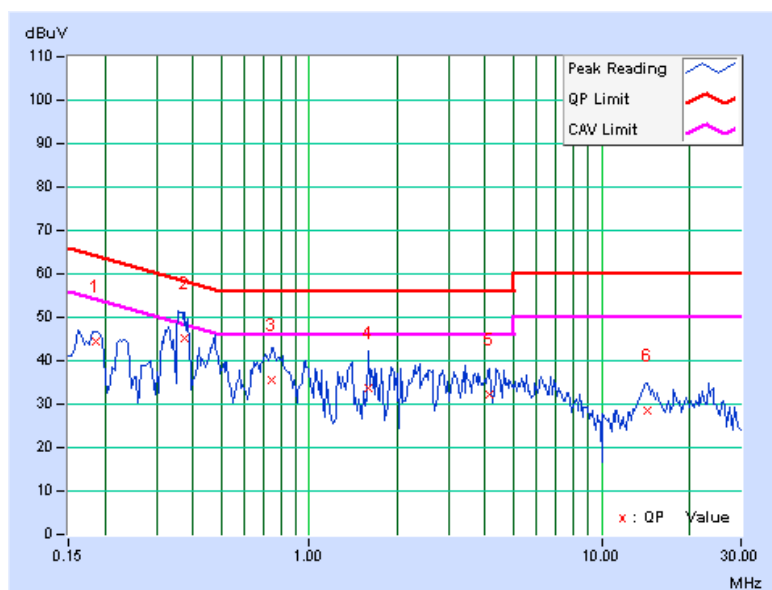



A D T

EUT TEST CONDITION		MEASUREMENT DETAIL	
CHANNEL	CH 6 + CH 4182	PHASE	Line 2
INPUT POWER	120Vac, 60Hz	6dB BANDWIDTH	9kHz
ENVIRONMENTAL CONDITIONS	20deg. C, 60%RH, 1007hPa	TESTED BY	Match Tsui
TEST MODE	A		

No	Freq. [MHz]	Corr. Factor (dB)	Reading Value [dB (uV)]		Emission Level [dB (uV)]		Limit [dB (uV)]		Margin (dB)	
			Q.P.	AV.	Q.P.	AV.	Q.P.	AV.	Q.P.	AV.
1	0.181	0.13	44.27	-	44.40	-	64.43	54.43	-20.03	-
2	0.380	0.15	44.43	-	44.58	-	58.27	48.27	-13.69	-
3	0.755	0.16	36.28	-	36.44	-	56.00	46.00	-19.56	-
4	2.219	0.21	33.60	-	33.81	-	56.00	46.00	-22.19	-
5	4.379	0.31	32.26	-	32.57	-	56.00	46.00	-23.43	-
6	23.133	0.80	33.09	-	33.89	-	60.00	50.00	-26.11	-

- REMARKS:**
1. Q.P. and AV. are abbreviations of quasi-peak and average individually.
 2. "-": The Quasi-peak reading value also meets average limit and measurement with the average detector is unnecessary.
 3. The emission levels of other frequencies were very low against the limit.
 4. Margin value = Emission level - Limit value
 5. Correction factor = Insertion loss + Cable loss
 6. Emission Level = Correction Factor + Reading Value.

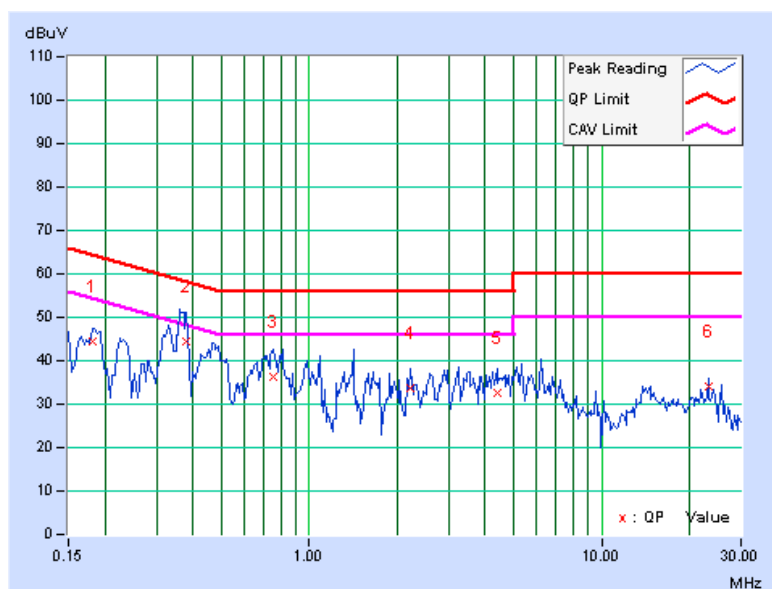



A D T

5. PHOTOGRAPHS OF THE TEST CONFIGURATION

Please refer to the attached file (Test Setup Photo).



6. INFORMATION ON THE TESTING LABORATORIES

We, Bureau Veritas Consumer Products Services (H.K.) Ltd., Taoyuan Branch, were founded in 1988 to provide our best service in EMC, Radio, Telecom and Safety consultation. Our laboratories are accredited and approved by the following approval agencies according to ISO/IEC 17025.

USA	FCC, NVLAP
Germany	TUV Rheinland
Japan	VCCI
Norway	NEMKO
Canada	INDUSTRY CANADA , CSA
R.O.C.	TAF, BSMI, NCC
Netherlands	Telefication
Singapore	GOST-ASIA(MOU)
Russia	CERTIS(MOU)

Copies of accreditation certificates of our laboratories obtained from approval agencies can be downloaded from our web site:

www.adt.com.tw/index.5/phtml. If you have any comments, please feel free to contact us at the following:

Linko EMC/RF Lab:

Tel: 886-2-26052180

Fax: 886-2-26051924

Hsin Chu EMC/RF Lab:

Tel: 886-3-5935343

Fax: 886-3-5935342

Hwa Ya EMC/RF/Safety Telecom Lab:

Tel: 886-3-3183232

Fax: 886-3-3185050

Web Site: www.adt.com.tw

The address and road map of all our labs can be found in our web site also.

7. APPENDIX A - MODIFICATIONS RECORDERS FOR ENGINEERING CHANGES TO THE EUT BY THE LAB

No any modifications are made to the EUT by the lab during the test.

---END---