



A D T

# FCC TEST REPORT

**REPORT NO.:** RF971218L04E

**MODEL NO.:** 3G17Wn

**RECEIVED:** Jun. 24, 2009

**TESTED:** Jul. 16 ~ Jul. 21, 2009

**ISSUED:** Jul. 24, 2009

**APPLICANT:** NetComm Limited

**ADDRESS:** 2-6 Orion Road, Lane Cove, NSW 2066 Sydney  
Australia

**ISSUED BY:** Bureau Veritas Consumer Products Services  
(H.K.) Ltd., Taoyuan Branch

**LAB ADDRESS:** No. 47, 14th Ling, Chia Pau Tsuen, Lin Kou  
Hsiang, Taipei Hsien 244, Taiwan, R.O.C.

**TEST LOCATION:** No. 19, Hwa Ya 2nd Rd, Wen Hwa Tsuen, Kwei  
Shan Hsiang, Taoyuan Hsien 333, Taiwan, R.O.C.

This test report consists of 87 pages in total. It may be duplicated completely for legal use with the approval of the applicant. It should not be reproduced except in full, without the written approval of our laboratory. The client should not use it to claim product endorsement by TAF or any government agencies. The test results in the report only apply to the tested sample.





A D T

## TABLE OF CONTENTS

1.	CERTIFICATION.....	4
2.	SUMMARY OF TEST RESULTS .....	5
2.1	MEASUREMENT UNCERTAINTY .....	5
3.	GENERAL INFORMATION .....	6
3.1	GENERAL DESCRIPTION OF EUT .....	6
3.2	DESCRIPTION OF TEST MODES .....	8
3.2.1	CONFIGURATION OF SYSTEM UNDER TEST .....	8
3.2.2	TEST MODE APPLICABILITY AND TESTED CHANNEL DETAIL .....	9
3.3	GENERAL DESCRIPTION OF APPLIED STANDARDS .....	11
3.4	DESCRIPTION OF SUPPORT UNITS .....	11
4.	TEST TYPES AND RESULTS .....	12
4.1	RADIATED EMISSION MEASUREMENT .....	12
4.1.1	LIMITS OF RADIATED EMISSION MEASUREMENT .....	12
4.1.2	TEST INSTRUMENTS.....	13
4.1.3	TEST PROCEDURES .....	14
4.1.4	DEVIATION FROM TEST STANDARD.....	14
4.1.5	TEST SETUP.....	15
4.1.6	EUT OPERATING CONDITIONS .....	15
4.1.7	TEST RESULTS .....	16
4.2	CONDUCTED EMISSION MEASUREMENT .....	32
4.2.1	LIMITS OF CONDUCTED EMISSION MEASUREMENT .....	32
4.2.2	TEST INSTRUMENTS.....	32
4.2.3	TEST PROCEDURES .....	33
4.2.4	DEVIATION FROM TEST STANDARD.....	33
4.2.5	TEST SETUP.....	34
4.2.6	EUT OPERATING CONDITIONS .....	34
4.2.7	TEST RESULTS .....	35
4.3	6dB BANDWIDTH MEASUREMENT .....	43
4.3.1	LIMITS OF 6dB BANDWIDTH MEASUREMENT .....	43
4.3.2	TEST INSTRUMENTS.....	43
4.3.3	TEST PROCEDURE.....	43
4.3.4	DEVIATION FROM TEST STANDARD.....	43
4.3.5	TEST SETUP.....	44
4.3.6	EUT OPERATING CONDITIONS .....	44
4.3.7	TEST RESULTS .....	45



A D T

4.4	MAXIMUM PEAK OUTPUT POWER.....	53
4.4.1	LIMITS OF MAXIMUM PEAK OUTPUT POWER MEASUREMENT .....	53
4.4.2	INSTRUMENTS .....	53
4.4.3	TEST PROCEDURES .....	53
4.4.4	DEVIATION FROM TEST STANDARD.....	54
4.4.5	TEST SETUP .....	54
4.4.6	EUT OPERATING CONDITIONS .....	54
4.4.7	TEST RESULTS .....	55
4.5	POWER SPECTRAL DENSITY MEASUREMENT .....	57
4.5.1	LIMITS OF POWER SPECTRAL DENSITY MEASUREMENT .....	57
4.5.2	TEST INSTRUMENTS.....	57
4.5.3	TEST PROCEDURE.....	57
4.5.4	DEVIATION FROM TEST STANDARD.....	58
4.5.5	TEST SETUP .....	58
4.5.6	EUT OPERATING CONDITION.....	58
4.5.7	TEST RESULTS .....	59
4.6	BAND EDGES MEASUREMENT .....	67
4.6.1	LIMITS OF BAND EDGES MEASUREMENT .....	67
4.6.2	TEST INSTRUMENTS.....	67
4.6.3	TEST PROCEDURE.....	67
4.6.4	DEVIATION FROM TEST STANDARD.....	67
4.6.5	EUT OPERATING CONDITION.....	67
4.6.6	TEST RESULTS .....	68
4.7	ANTENNA REQUIREMENT .....	84
4.7.1	STANDARD APPLICABLE .....	84
4.7.2	ANTENNA CONNECTED CONSTRUCTION .....	84
5.	PHOTOGRAPHS OF THE TEST CONFIGURATION .....	85
6.	INFORMATION ON THE TESTING LABORATORIES .....	86
7.	APPENDIX A - MODIFICATIONS RECORDERS FOR ENGINEERING CHANGES TO THE EUT BY THE LAB.....	87



A D T

## 1. CERTIFICATION

**PRODUCT:** Wireless 3G Router  
**MODEL:** 3G17Wn  
**BRAND:** NetComm  
**APPLICANT:** NetComm Limited  
**TEST SAMPLE:** R&D SAMPLE  
**TESTED:** Jul. 16 ~ Jul. 21, 2009  
**STANDARDS:** **FCC Part 15, Subpart C (Section 15.247)**  
ANSI C63.4-2003

The above equipment (Model: 3G17Wn) has been tested by **Bureau Veritas Consumer Products Services (H.K.) Ltd., Taoyuan Branch**, and found compliance with the requirement of the above standards. The test record, data evaluation & Equipment Under Test (EUT) configurations represented herein are true and accurate accounts of the measurements of the sample's EMC characteristics under the conditions specified in this report.

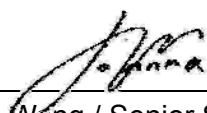
**PREPARED BY** :  , **DATE** : Jul. 24, 2009  
Joanna Wang / Senior Specialist

**TECHNICAL ACCEPTANCE** :  , **DATE** : Jul. 24, 2009  
Responsible for RF Long Chen / Senior Engineer

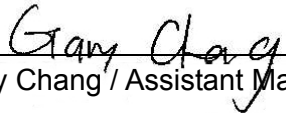
**APPROVED BY** :  , **DATE** : Jul. 24, 2009  
Gary Chang / Assistant Manager



## 2. SUMMARY OF TEST RESULTS

The EUT has been tested according to the following specifications:

APPLIED STANDARD: FCC PART 15, SUBPART C (SECTION 15.247)			
STANDARD SECTION	TEST TYPE AND LIMIT	RESULT	REMARK
15.207	AC Power Conducted Emission	PASS	Meet the requirement of limit. Minimum passing margin is -6.37dB at 0.365MHz.
15.247(a)(2)	Spectrum Bandwidth of a Direct Sequence Spread Spectrum System Limit: min. 500kHz	PASS	Meet the requirement of limit.
15.247(b)	Maximum Peak Output Power Limit: max. 30dBm	PASS	Meet the requirement of limit.
15.247(d)	Radiated Emissions Limit: Table 15.209	PASS	Meet the requirement of limit. Minimum passing margin is -2.31dB at 2384.00MHz.
15.247(e)	Power Spectral Density Limit: max. 8dBm	PASS	Meet the requirement of limit.
15.247(d)	Band Edge Measurement Limit: 20dB less than the peak value of fundamental frequency	PASS	Meet the requirement of limit.

### 2.1 MEASUREMENT UNCERTAINTY

Where relevant, the following measurement uncertainty levels have been estimated for tests performed on the EUT as specified in CISPR 16-4-2:

MEASUREMENT	FREQUENCY	UNCERTAINTY
Conducted emissions	150kHz~30MHz	2.44dB
Radiated emissions	30MHz ~ 200MHz	2.93dB
	200MHz ~1000MHz	2.95dB
	1GHz ~ 18GHz	2.26dB
	18GHz ~ 40GHz	1.94dB

This uncertainty represents an expanded uncertainty expressed at approximately the 95% confidence level using a coverage factor of k = 2.



### 3. GENERAL INFORMATION

#### 3.1 GENERAL DESCRIPTION OF EUT

<b>EUT</b>	Wireless 3G Router
<b>MODEL NO.</b>	3G17Wn
<b>FCC ID</b>	XIA-3G17WN
<b>POWER SUPPLY</b>	12Vdc from adapter
<b>MODULATION TYPE</b>	CCK, DQPSK, DBPSK for DSSS 64QAM, 16QAM, QPSK, BPSK for OFDM
<b>MODULATION TECHNOLOGY</b>	DSSS, OFDM
<b>TRANSFER RATE</b>	802.11b: 11.0/ 5.5/ 2.0/ 1.0Mbps 802.11g: 54.0/ 48.0/ 36.0/ 24.0/ 18.0/ 12.0/ 9.0/ 6.0Mbps Draft 802.11n: up to 300Mbps
<b>OPERATING FREQUENCY</b>	2412.0 ~ 2462.0MHz
<b>NUMBER OF CHANNEL</b>	11 for 802.11b, 802.11g, draft 802.11n (20MHz) 7 for draft 802.11n (40MHz)
<b>OUTPUT POWER</b>	338.065mW
<b>ANTENNA TYPE</b>	Dipole antenna with 2dBi gain
<b>DATA CABLE</b>	NA
<b>I/O PORTS</b>	RJ45, USB
<b>ACCESSORY DEVICES</b>	Adapter

**NOTE:**

1. The EUT provides one completed transmitter and one receiver.

<b>MODULATION MODE</b>	<b>TX FUNCTION</b>
802.11b	1TX
802.11g	1TX
Draft 802.11n (20MHz)	1TX
Draft 802.11n (40MHz)	1TX

2. The EUT was operated with following power adapters:

<b>ADAPTER 1</b>	
<b>BRAND:</b>	AMIGO
<b>MODEL:</b>	AMS6-1201000SU
<b>INPUT:</b>	120Vac, 60Hz, 0.5A
<b>OUTPUT:</b>	12Vdc, 1.0A
<b>POWER LINE:</b>	1.8m non-shielded cable without core



A D T

<b>ADAPTER 2</b>	
<b>BRAND:</b>	DVE
<b>MODEL:</b>	DSA-12G-12 FUS 120120
<b>INPUT:</b>	100-240Vac, 50/60Hz, 0.3A
<b>OUTPUT:</b>	12Vdc, 1.0A
<b>POWER LINE:</b>	1.8m non-shielded cable without core

<b>ADAPTER 3</b>	
<b>BRAND:</b>	Powertron
<b>MODEL:</b>	PA1015-2HU
<b>INPUT:</b>	100-240Vac, 50-60Hz, 0.4A
<b>OUTPUT:</b>	12Vdc, 1.25A
<b>POWER LINE:</b>	1.8m non-shielded cable without core

<b>ADAPTER 4</b>	
<b>BRAND:</b>	DVE
<b>MODEL:</b>	DSA-15P-12 US 120150
<b>INPUT:</b>	100-240Vac, 50/60Hz, 0.5A
<b>OUTPUT:</b>	12Vdc, 1.25A
<b>POWER LINE:</b>	1.8m non-shielded cable without core

3. The above EUT information was declared by manufacturer and for more detailed features description, please refer to the manufacturer's specifications or user's manual.

### 3.2 DESCRIPTION OF TEST MODES

11 channels are provided for 802.11b, 802.11g and draft 802.11n (20MHz):

CHANNEL	FREQUENCY	CHANNEL	FREQUENCY
1	2412MHz	7	2442MHz
2	2417MHz	8	2447MHz
3	2422MHz	9	2452MHz
4	2427MHz	10	2457MHz
5	2432MHz	11	2462MHz
6	2437MHz		

7 channels are provided for draft 802.11n (40MHz):

CHANNEL	FREQUENCY	CHANNEL	FREQUENCY
1	2422MHz	5	2442MHz
2	2427MHz	6	2447MHz
3	2432MHz	7	2452MHz
4	2437MHz		

#### 3.2.1 CONFIGURATION OF SYSTEM UNDER TEST

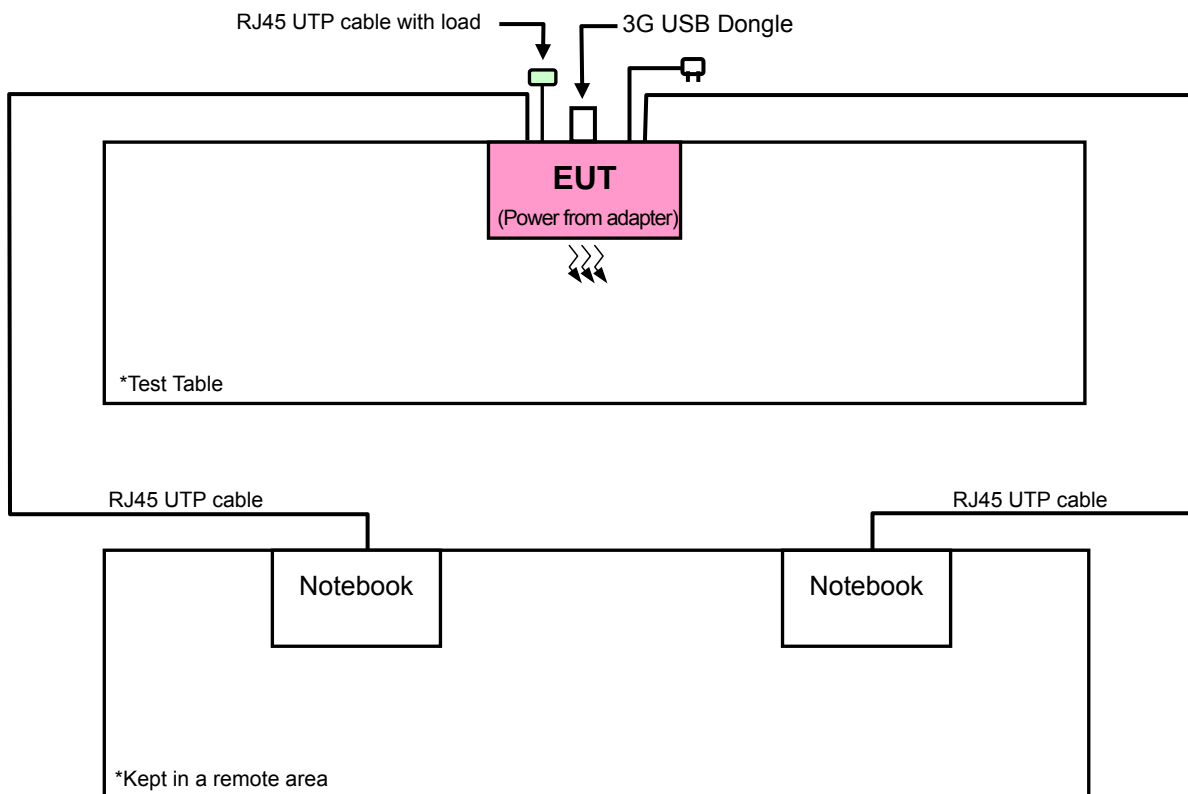



### 3.2.2 TEST MODE APPLICABILITY AND TESTED CHANNEL DETAIL

EUT CONFIGURE MODE	APPLICABLE TO				DESCRIPTION
	RE $\geq$ 1G	RE<1G	PLC	APCM	
A	-	√	√	-	Adapter: AMS6-1201000SU
B	-	√	√	-	Adapter: DSA-12G-12 FUS 120120
C	√	√	√	√	Adapter: PA1015-2HU
D	-	√	√	-	Adapter: DSA-15P-12 US 120150

Where **RE $\geq$ 1G**: Radiated Emission above 1GHz

**RE<1G**: Radiated Emission below 1GHz

**PLC**: Power Line Conducted Emission

**APCM**: Antenna Port Conducted Measurement

**Note**: "-" means no effect.

#### RADIATED EMISSION TEST (ABOVE 1GHz):

- Pre-Scan has been conducted to determine the worst-case mode from all possible combinations between available modulations, data rates, XYZ axis and antenna ports (if EUT with antenna diversity architecture).
- Following channel(s) was (were) selected for the final test as listed below.

EUT CONFIGURE MODE	MODE	AVAILABLE CHANNEL	TESTED CHANNEL	MODULATION TECHNOLOGY	MODULATION TYPE	DATA RATE (Mbps)	AXIS
C	802.11b	1 to 11	1, 6, 11	DSSS	DBPSK	1.0	Z
	802.11g	1 to 11	1, 6, 11	OFDM	BPSK	6.0	
	Draft 802.11n (20MHz)	1 to 11	1, 6, 11	OFDM	BPSK	7.2	
	Draft 802.11n (40MHz)	1 to 7	1, 4, 7	OFDM	BPSK	15.0	

#### RADIATED EMISSION TEST (BELOW 1GHz):

- Pre-Scan has been conducted to determine the worst-case mode from all possible combinations between available modulations, data rates, XYZ axis and antenna ports (if EUT with antenna diversity architecture).
- Following channel(s) was (were) selected for the final test as listed below.

EUT CONFIGURE MODE	MODE	AVAILABLE CHANNEL	TESTED CHANNEL	MODULATION TECHNOLOGY	MODULATION TYPE	DATA RATE (Mbps)	AXIS
A, B, C, D	802.11g	1 to 11	6	OFDM	BPSK	6.0	Z



**POWER LINE CONDUCTED EMISSION TEST:**

- Pre-Scan has been conducted to determine the worst-case mode from all possible combinations between available modulations, data rates and antenna ports (if EUT with antenna diversity architecture).
- Following channel(s) was (were) selected for the final test as listed below.

EUT CONFIGURE MODE	MODE	AVAILABLE CHANNEL	TESTED CHANNEL	MODULATION TECHNOLOGY	MODULATION TYPE	DATA RATE (Mbps)
A, B, C, D	802.11g	1 to 11	6	OFDM	BPSK	6.0

**BANDEDGE MEASUREMENT:**

- Pre-Scan has been conducted to determine the worst-case mode from all possible combinations between available modulations, data rates and antenna ports (if EUT with antenna diversity architecture).
- Following channel(s) was (were) selected for the final test as listed below.

EUT CONFIGURE MODE	MODE	AVAILABLE CHANNEL	TESTED CHANNEL	MODULATION TECHNOLOGY	MODULATION TYPE	DATA RATE (Mbps)
C	802.11b	1 to 11	1, 11	DSSS	DBPSK	1.0
	802.11g	1 to 11	1, 11	OFDM	BPSK	6.0
	Draft 802.11n (20MHz)	1 to 11	1, 11	OFDM	BPSK	7.2
	Draft 802.11n (40MHz)	1 to 7	1, 7	OFDM	BPSK	15.0

**ANTENNA PORT CONDUCTED MEASUREMENT:**

- Pre-Scan has been conducted to determine the worst-case mode from all possible combinations between available modulations, data rates and antenna ports (if EUT with antenna diversity architecture).
- Following channel(s) was (were) selected for the final test as listed below.

EUT CONFIGURE MODE	MODE	AVAILABLE CHANNEL	TESTED CHANNEL	MODULATION TECHNOLOGY	MODULATION TYPE	DATA RATE (Mbps)
C	802.11b	1 to 11	1, 6, 11	DSSS	DBPSK	1.0
	802.11g	1 to 11	1, 6, 11	OFDM	BPSK	6.0
	Draft 802.11n (20MHz)	1 to 11	1, 6, 11	OFDM	BPSK	7.2
	Draft 802.11n (40MHz)	1 to 7	1, 4, 7	OFDM	BPSK	15.0



### 3.3 GENERAL DESCRIPTION OF APPLIED STANDARDS

The EUT is a RF Product. According to the specifications of the manufacturer, it must comply with the requirements of the following standards:

#### FCC Part 15, Subpart C (15.247)

#### ANSI C63.4-2003

All test items have been performed and recorded as per the above standards.

**NOTE:** The EUT is also considered as a kind of computer peripheral, because the connection to computer is necessary for typical use. It has been verified to comply with the requirements of FCC Part 15, Subpart B, Class B (DoC). The test report has been issued separately.

### 3.4 DESCRIPTION OF SUPPORT UNITS

The EUT has been tested as an independent unit together with other necessary accessories or support units. The following support units or accessories were used to form a representative test configuration during the tests.

NO.	PRODUCT	BRAND	MODEL NO.	SERIAL NO.	FCC ID
1	NOTEBOOK	DELL	PP05L	12130898320	E2K24CLNS
2	NOTEBOOK	DELL	PP05L	9954115984	E2K24CLNS
3	3G USB DONGLE	Sierra Aircard	888U	NA	N7NC888

NO.	SIGNAL CABLE DESCRIPTION OF THE ABOVE SUPPORT UNITS
1	10m UTP RJ45 cable
2	10m UTP RJ45 cable
3	NA

**NOTE:** 1. All power cords of the above support units are non shielded (1.8m).  
2. Item 1-2 acted as a communication partners to transfer data.  
3. Item 3 was provided by client.



## 4. TEST TYPES AND RESULTS

### 4.1 RADIATED EMISSION MEASUREMENT

#### 4.1.1 LIMITS OF RADIATED EMISSION MEASUREMENT

Emissions radiated outside of the specified bands, shall be according to the general radiated limits in 15.209 as following:

FREQUENCIES (MHz)	FIELD STRENGTH (microvolts/meter)	MEASUREMENT DISTANCE (meters)
0.009 ~ 0.490	2400/F(kHz)	300
0.490 ~ 1.705	24000/F(kHz)	30
1.705 ~ 30.0	30	30
30 ~ 88	100	3
88 ~ 216	150	3
216 ~ 960	200	3
Above 960	500	3

**NOTE:**

1. The lower limit shall apply at the transition frequencies.
2. Emission level (dBuV/m) = 20 log Emission level (uV/m).
3. As shown in 15.35(b), for frequencies above 1000MHz, the field strength limits are based on average detector, however, the peak field strength of any emission shall not exceed the maximum permitted average limits, specified above by more than 20dB under any condition of modulation.



A D T

#### 4.1.2 TEST INSTRUMENTS

DESCRIPTION & MANUFACTURER	MODEL NO.	SERIAL NO.	DATE OF CALIBRATION	DUE DATE OF CALIBRATION
Test Receiver ROHDE & SCHWARZ	ESIB7	100212	May 25, 2009	May 24, 2010
Spectrum Analyzer ROHDE & SCHWARZ	FSP40	100269	Aug. 08, 2008	Aug. 07, 2009
BILOG Antenna SCHWARZBECK	VULB9168	9168-156	Apr. 30, 2009	Apr. 29, 2010
HORN Antenna SCHWARZBECK	BBHA 9120 D	9120D-563	Aug. 06, 2008	Aug. 05, 2009
HORN Antenna SCHWARZBECK	BBHA 9170	BBHA9170242	Jan. 06, 2009	Jan. 05, 2010
Preamplifier Agilent	8449B	3008A01911	Sep. 10, 2008	Sep. 09, 2009
Preamplifier Agilent	8447D	2944A10638	Dec. 26, 2008	Dec. 25, 2009
RF signal cable HUBER+SUHNNER	SUCOFLEX 104	218190/4 231241/4	May 13, 2009	May 12, 2010
RF signal cable Worken	8D-FB	Cable-HYCH9-01	Aug. 09, 2008	Aug. 08, 2009
Software	ADT_Radiated_ V7.6.15.9.2	NA	NA	NA
Antenna Tower EMCO	2070/2080	512.835.4684	NA	NA
Turn Table EMCO	2087-2.03	NA	NA	NA
Antenna Tower & Turn Table Controller EMCO	2090	NA	NA	NA

- NOTE:**
1. The calibration interval of the above test instruments is 12 months and the calibrations are traceable to NML/ROC and NIST/USA.
  2. The test was performed in HwaYa Chamber 9.
  3. The horn antenna and HP preamplifier (model: 8449B) are used only for the measurement of emission frequency above 1GHz if tested.
  4. The FCC Site Registration No. is 460141.
  5. The IC Site Registration No. is IC 7450F-4.



#### 4.1.3 TEST PROCEDURES

- a. The EUT was placed on the top of a rotating table 0.8 meters above the ground at a 3 meters semi-anechoic chamber. The table was rotated 360 degrees to determine the position of the highest radiation.
- b. The EUT was set 3 meters away from the interference-receiving antenna, which was mounted on the top of a variable-height antenna tower.
- c. The antenna is a broadband antenna, and its height is varied from one meter to four meters above the ground to determine the maximum value of the field strength. Both horizontal and vertical polarizations of the antenna are set to make the measurement.
- d. For each suspected emission, the EUT was arranged to its worst case and then the antenna was tuned to heights from 1 meter to 4 meters and the rotatable table was turned from 0 degrees to 360 degrees to find the maximum reading.
- e. The test-receiver system was set to Peak Detect Function and Specified Bandwidth with Maximum Hold Mode.
- f. If the emission level of the EUT in peak mode was lower than the limit specified, then testing could be stopped and the peak values of the EUT would be reported. Otherwise the emissions would be re-tested one by one using peak, quasi-peak or average method as specified and then reported in a data sheet.

**NOTE:**

1. The resolution bandwidth and video bandwidth of test receiver/spectrum analyzer is 120kHz for Quasi-peak detection at frequency below 1GHz.
2. The resolution bandwidth of test receiver/spectrum analyzer is 1MHz and video bandwidth is 3MHz for Peak detection at frequency above 1GHz.
3. The resolution bandwidth of test receiver/spectrum analyzer is 1MHz and the video bandwidth is 10Hz for Average detection (AV) at frequency above 1GHz.
4. All modes of operation were investigated and the worst-case emissions are reported.

#### 4.1.4 DEVIATION FROM TEST STANDARD

No deviation.

#### 4.1.5 TEST SETUP

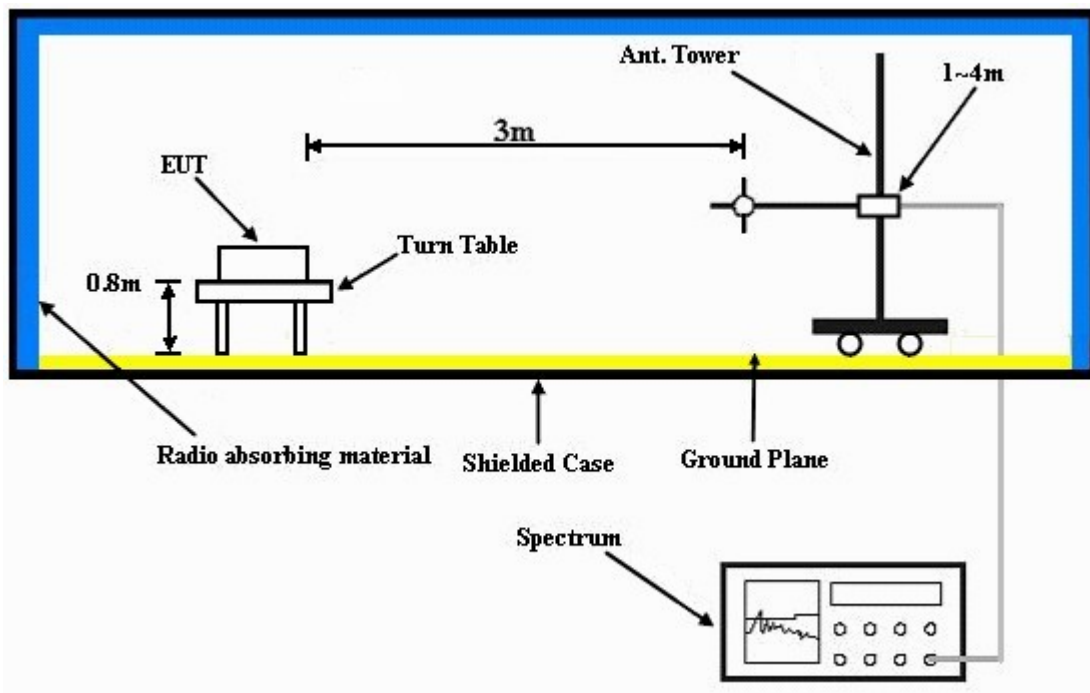

For the actual test configuration, please refer to the attached file (Test Setup Photo).

#### 4.1.6 EUT OPERATING CONDITIONS

- a. Placed the EUT on the testing table.
- b. Prepared notebook systems to act as a communication partner and placed them outside of testing area.
- c. The communication partners connected with EUT via a RJ45 cable and run a test program (provided by manufacturer) to enable EUT under transmission condition continuously at specific channel frequency.
- d. The necessary accessories enable the EUT in full functions.



A D T

#### 4.1.7 TEST RESULTS

##### 802.11b DSSS MODULATION

EUT TEST CONDITION		MEASUREMENT DETAIL	
CHANNEL	Channel 1	FREQUENCY RANGE	1 ~ 25GHz
INPUT POWER	120Vac, 60 Hz	DETECTOR FUNCTION	Peak (PK) Average (AV)
ENVIRONMENTAL CONDITIONS	23deg. C, 70%RH 1002 hPa	TESTED BY	Lori Chiu

ANTENNA POLARITY & TEST DISTANCE: HORIZONTAL AT 3 M								
NO.	FREQ. (MHz)	EMISSION LEVEL (dBuV/m)	LIMIT (dBuV/m)	MARGIN (dB)	ANTENNA HEIGHT (m)	TABLE ANGLE (Degree)	RAW VALUE (dBuV)	CORRECTION FACTOR (dB/m)
1	2386.00	56.62 PK	74.00	-17.38	1.01 H	220	24.41	32.21
2	2386.00	46.50 AV	54.00	-7.50	1.01 H	220	14.29	32.21
3	*2412.00	100.53 PK			1.00 H	220	68.23	32.30
4	*2412.00	97.10 AV			1.00 H	220	64.80	32.30
5	2491.00	57.70 PK	74.00	-16.30	1.01 H	221	25.11	32.59
6	2491.00	46.63 AV	54.00	-7.37	1.01 H	221	14.04	32.59
7	4824.00	49.57 PK	74.00	-24.43	1.52 H	51	11.24	38.33
8	4824.00	41.88 AV	54.00	-12.12	1.52 H	51	3.55	38.33
ANTENNA POLARITY & TEST DISTANCE: VERTICAL AT 3 M								
NO.	FREQ. (MHz)	EMISSION LEVEL (dBuV/m)	LIMIT (dBuV/m)	MARGIN (dB)	ANTENNA HEIGHT (m)	TABLE ANGLE (Degree)	RAW VALUE (dBuV)	CORRECTION FACTOR (dB/m)
1	2386.00	59.59 PK	74.00	-14.41	1.33 V	109	27.38	32.21
2	2386.00	49.18 AV	54.00	-4.82	1.33 V	109	16.97	32.21
3	*2412.00	108.69 PK			1.33 V	109	76.39	32.30
4	*2412.00	105.08 AV			1.33 V	109	72.78	32.30
5	2491.00	60.52 PK	74.00	-13.48	1.32 V	110	27.93	32.59
6	2491.00	50.28 AV	54.00	-3.72	1.32 V	110	17.69	32.59
7	4824.00	52.69 PK	74.00	-21.31	1.00 V	158	14.36	38.33
8	4824.00	47.66 AV	54.00	-6.34	1.00 V	158	9.33	38.33

- REMARKS:**
1. Emission level (dBuV/m) = Raw Value (dBuV) + Correction Factor (dB/m).
  2. Correction Factor (dB/m) = Antenna Factor (dB/m) + Cable Factor (dB).
  3. The other emission levels were very low against the limit.
  4. Margin value = Emission level – Limit value.
  5. “ \* “: Fundamental frequency.





A D T

EUT TEST CONDITION		MEASUREMENT DETAIL	
CHANNEL	Channel 6	FREQUENCY RANGE	1 ~ 25GHz
INPUT POWER	120Vac, 60 Hz	DETECTOR FUNCTION	Peak (PK) Average (AV)
ENVIRONMENTAL CONDITIONS	23deg. C, 70%RH 1002 hPa	TESTED BY	Lori Chiu

ANTENNA POLARITY & TEST DISTANCE: HORIZONTAL AT 3 M								
NO.	FREQ. (MHz)	EMISSION LEVEL (dBuV/m)	LIMIT (dBuV/m)	MARGIN (dB)	ANTENNA HEIGHT (m)	TABLE ANGLE (Degree)	RAW VALUE (dBuV)	CORRECTION FACTOR (dB/m)
1	*2437.00	100.46 PK			1.04 H	285	68.07	32.39
2	*2437.00	97.24 AV			1.04 H	285	64.85	32.39
3	4874.00	54.63 PK	74.00	-19.37	1.02 H	311	16.22	38.41
4	4874.00	49.92 AV	54.00	-4.08	1.02 H	311	11.51	38.41
ANTENNA POLARITY & TEST DISTANCE: VERTICAL AT 3 M								
NO.	FREQ. (MHz)	EMISSION LEVEL (dBuV/m)	LIMIT (dBuV/m)	MARGIN (dB)	ANTENNA HEIGHT (m)	TABLE ANGLE (Degree)	RAW VALUE (dBuV)	CORRECTION FACTOR (dB/m)
1	*2437.00	108.69 PK			1.16 V	219	76.30	32.39
2	*2437.00	105.33 AV			1.16 V	219	72.94	32.39
3	4874.00	52.54 PK	74.00	-21.46	1.36 V	177	14.13	38.41
4	4874.00	47.50 AV	54.00	-6.50	1.36 V	177	9.09	38.41

- REMARKS:**
1. Emission level (dBuV/m) = Raw Value (dBuV) + Correction Factor (dB/m).
  2. Correction Factor (dB/m) = Antenna Factor (dB/m) + Cable Factor (dB).
  3. The other emission levels were very low against the limit.
  4. Margin value = Emission level – Limit value.
  5. “ \* “: Fundamental frequency.



A D T

EUT TEST CONDITION		MEASUREMENT DETAIL	
CHANNEL	Channel 11	FREQUENCY RANGE	1 ~ 25GHz
INPUT POWER	120Vac, 60 Hz	DETECTOR FUNCTION	Peak (PK) Average (AV)
ENVIRONMENTAL CONDITIONS	23deg. C, 70%RH 1002 hPa	TESTED BY	Lori Chiu

ANTENNA POLARITY & TEST DISTANCE: HORIZONTAL AT 3 M								
NO.	FREQ. (MHz)	EMISSION LEVEL (dBuV/m)	LIMIT (dBuV/m)	MARGIN (dB)	ANTENNA HEIGHT (m)	TABLE ANGLE (Degree)	RAW VALUE (dBuV)	CORRECTION FACTOR (dB/m)
1	*2462.00	100.49 PK			1.18 H	330	68.01	32.48
2	*2462.00	97.22 AV			1.18 H	330	64.74	32.48
3	2483.50	57.85 PK	74.00	-16.15	1.18 H	330	25.29	32.56
4	2483.50	46.49 AV	54.00	-7.51	1.18 H	330	13.93	32.56
5	4924.00	50.19 PK	74.00	-23.81	1.45 H	103	11.68	38.51
6	4924.00	41.37 AV	54.00	-12.63	1.45 H	103	2.86	38.51
ANTENNA POLARITY & TEST DISTANCE: VERTICAL AT 3 M								
NO.	FREQ. (MHz)	EMISSION LEVEL (dBuV/m)	LIMIT (dBuV/m)	MARGIN (dB)	ANTENNA HEIGHT (m)	TABLE ANGLE (Degree)	RAW VALUE (dBuV)	CORRECTION FACTOR (dB/m)
1	*2462.00	108.76 PK			1.11 V	157	76.28	32.48
2	*2462.00	105.49 AV			1.11 V	157	73.01	32.48
3	2483.50	57.79 PK	74.00	-16.21	1.03 V	157	25.23	32.56
4	2483.50	47.69 AV	54.00	-6.31	1.03 V	157	15.13	32.56
5	4924.00	49.93 PK	74.00	-24.07	1.30 V	269	11.42	38.51
6	4924.00	42.13 AV	54.00	-11.87	1.30 V	269	3.62	38.51

- REMARKS:**
1. Emission level (dBuV/m) = Raw Value (dBuV) + Correction Factor (dB/m).
  2. Correction Factor (dB/m) = Antenna Factor (dB/m) + Cable Factor (dB).
  3. The other emission levels were very low against the limit.
  4. Margin value = Emission level – Limit value.
  5. “ \* “: Fundamental frequency.



A D T

**802.11g OFDM MODULATION**

EUT TEST CONDITION		MEASUREMENT DETAIL	
CHANNEL	Channel 1	FREQUENCY RANGE	1 ~ 25GHz
INPUT POWER	120Vac, 60 Hz	DETECTOR FUNCTION	Peak (PK) Average (AV)
ENVIRONMENTAL CONDITIONS	23deg. C, 70%RH 1002 hPa	TESTED BY	Lori Chiu

ANTENNA POLARITY & TEST DISTANCE: HORIZONTAL AT 3 M								
NO.	FREQ. (MHz)	EMISSION LEVEL (dBuV/m)	LIMIT (dBuV/m)	MARGIN (dB)	ANTENNA HEIGHT (m)	TABLE ANGLE (Degree)	RAW VALUE (dBuV)	CORRECTION FACTOR (dB/m)
1	2390.00	57.46 PK	74.00	-16.54	1.02 H	55	25.24	32.22
2	2390.00	47.32 AV	54.00	-6.68	1.02 H	55	15.10	32.22
3	*2412.00	104.21 PK			1.02 H	55	71.91	32.30
4	*2412.00	93.89 AV			1.02 H	55	61.59	32.30
5	4824.00	48.66 PK	74.00	-25.34	1.00 H	219	10.33	38.33
6	4824.00	36.59 AV	54.00	-17.41	1.00 H	219	-1.74	38.33
ANTENNA POLARITY & TEST DISTANCE: VERTICAL AT 3 M								
NO.	FREQ. (MHz)	EMISSION LEVEL (dBuV/m)	LIMIT (dBuV/m)	MARGIN (dB)	ANTENNA HEIGHT (m)	TABLE ANGLE (Degree)	RAW VALUE (dBuV)	CORRECTION FACTOR (dB/m)
1	2360.00	60.39 PK	74.00	-13.61	1.04 V	322	28.29	32.10
2	2360.00	48.88 AV	54.00	-5.12	1.04 V	322	16.78	32.10
3	2390.00	63.43 PK	74.00	-10.57	1.00 V	158	31.21	32.22
4	2390.00	50.71 AV	54.00	-3.29	1.00 V	158	18.49	32.22
5	*2412.00	111.37 PK			1.01 V	320	79.07	32.30
6	*2412.00	100.54 AV			1.01 V	320	68.24	32.30
7	4824.00	49.36 PK	74.00	-24.64	1.10 V	150	11.03	38.33
8	4824.00	37.58 AV	54.00	-16.42	1.10 V	150	-0.75	38.33

- REMARKS:**
1. Emission level (dBuV/m) = Raw Value (dBuV) + Correction Factor (dB/m).
  2. Correction Factor (dB/m) = Antenna Factor (dB/m) + Cable Factor (dB).
  3. The other emission levels were very low against the limit.
  4. Margin value = Emission level – Limit value.
  5. “ \* “: Fundamental frequency.



A D T

EUT TEST CONDITION		MEASUREMENT DETAIL	
CHANNEL	Channel 6	FREQUENCY RANGE	1 ~ 25GHz
INPUT POWER	120Vac, 60 Hz	DETECTOR FUNCTION	Peak (PK) Average (AV)
ENVIRONMENTAL CONDITIONS	23deg. C, 70%RH 1002 hPa	TESTED BY	Lori Chiu

ANTENNA POLARITY & TEST DISTANCE: HORIZONTAL AT 3 M								
NO.	FREQ. (MHz)	EMISSION LEVEL (dBuV/m)	LIMIT (dBuV/m)	MARGIN (dB)	ANTENNA HEIGHT (m)	TABLE ANGLE (Degree)	RAW VALUE (dBuV)	CORRECTION FACTOR (dB/m)
1	2384.00	57.86 PK	74.00	-16.14	1.34 H	271	25.66	32.20
2	2384.00	47.41 AV	54.00	-6.59	1.34 H	271	15.21	32.20
3	*2437.00	107.63 PK			1.34 H	270	75.24	32.39
4	*2437.00	96.72 AV			1.34 H	270	64.33	32.39
5	2489.00	57.41 PK	74.00	-16.59	1.34 H	270	24.83	32.58
6	2489.00	46.82 AV	54.00	-7.18	1.34 H	270	14.24	32.58
7	4874.00	51.29 PK	74.00	-22.71	1.20 H	218	12.88	38.41
8	4874.00	37.12 AV	54.00	-16.88	1.20 H	218	-1.29	38.41
9	7311.00	62.39 PK	74.00	-11.61	1.00 H	188	17.75	44.64
10	7311.00	48.25 AV	54.00	-5.75	1.00 H	188	3.61	44.64

ANTENNA POLARITY & TEST DISTANCE: VERTICAL AT 3 M								
NO.	FREQ. (MHz)	EMISSION LEVEL (dBuV/m)	LIMIT (dBuV/m)	MARGIN (dB)	ANTENNA HEIGHT (m)	TABLE ANGLE (Degree)	RAW VALUE (dBuV)	CORRECTION FACTOR (dB/m)
1	2384.00	63.92 PK	74.00	-10.08	1.10 V	225	31.72	32.20
2	2384.00	51.69 AV	54.00	-2.31	1.10 V	225	19.49	32.20
3	*2437.00	114.38 PK			1.13 V	215	81.99	32.39
4	*2437.00	104.25 AV			1.13 V	215	71.86	32.39
5	2489.00	64.87 PK	74.00	-9.13	1.13 V	215	32.29	32.58
6	2489.00	51.39 AV	54.00	-2.61	1.13 V	215	18.81	32.58
7	4874.00	51.82 PK	74.00	-22.18	1.11 V	323	13.41	38.41
8	4874.00	38.16 AV	54.00	-15.84	1.11 V	323	-0.25	38.41
9	7311.00	61.39 PK	74.00	-12.61	1.33 V	359	16.75	44.64
10	7311.00	47.12 AV	54.00	-6.88	1.33 V	359	2.48	44.64

- REMARKS:**
1. Emission level (dBuV/m) = Raw Value (dBuV) + Correction Factor (dB/m).
  2. Correction Factor (dB/m) = Antenna Factor (dB/m) + Cable Factor (dB).
  3. The other emission levels were very low against the limit.
  4. Margin value = Emission level – Limit value.
  5. “ \* “: Fundamental frequency.



A D T

EUT TEST CONDITION		MEASUREMENT DETAIL	
CHANNEL	Channel 11	FREQUENCY RANGE	1 ~ 25GHz
INPUT POWER	120Vac, 60 Hz	DETECTOR FUNCTION	Peak (PK) Average (AV)
ENVIRONMENTAL CONDITIONS	23deg. C, 70%RH 1002 hPa	TESTED BY	Lori Chiu

ANTENNA POLARITY & TEST DISTANCE: HORIZONTAL AT 3 M								
NO.	FREQ. (MHz)	EMISSION LEVEL (dBuV/m)	LIMIT (dBuV/m)	MARGIN (dB)	ANTENNA HEIGHT (m)	TABLE ANGLE (Degree)	RAW VALUE (dBuV)	CORRECTION FACTOR (dB/m)
1	*2462.00	103.74 PK			1.01 H	171	71.26	32.48
2	*2462.00	93.49 AV			1.01 H	171	61.01	32.48
3	2483.50	59.66 PK	74.00	-14.34	1.01 H	171	27.10	32.56
4	2483.50	46.87 AV	54.00	-7.13	1.01 H	171	14.31	32.56
5	4924.00	48.90 PK	74.00	-25.10	1.10 H	251	10.39	38.51
6	4924.00	36.69 AV	54.00	-17.31	1.10 H	251	-1.82	38.51
ANTENNA POLARITY & TEST DISTANCE: VERTICAL AT 3 M								
NO.	FREQ. (MHz)	EMISSION LEVEL (dBuV/m)	LIMIT (dBuV/m)	MARGIN (dB)	ANTENNA HEIGHT (m)	TABLE ANGLE (Degree)	RAW VALUE (dBuV)	CORRECTION FACTOR (dB/m)
1	*2462.00	110.60 PK			1.01 V	231	78.12	32.48
2	*2462.00	100.53 AV			1.01 V	231	68.05	32.48
3	2483.50	61.59 PK	74.00	-12.41	1.01 V	233	29.03	32.56
4	2483.50	49.22 AV	54.00	-4.78	1.01 V	233	16.66	32.56
5	4924.00	50.39 PK	74.00	-23.61	1.22 V	15	11.88	38.51
6	4924.00	37.83 AV	54.00	-16.17	1.22 V	15	-0.68	38.51

- REMARKS:**
1. Emission level (dBuV/m) = Raw Value (dBuV) + Correction Factor (dB/m).
  2. Correction Factor (dB/m) = Antenna Factor (dB/m) + Cable Factor (dB).
  3. The other emission levels were very low against the limit.
  4. Margin value = Emission level – Limit value.
  5. “ \* “: Fundamental frequency.



A D T

**DRAFT 802.11n (20MHz) OFDM MODULATION**

EUT TEST CONDITION		MEASUREMENT DETAIL	
CHANNEL	Channel 1	FREQUENCY RANGE	1 ~ 25GHz
INPUT POWER	120Vac, 60 Hz	DETECTOR FUNCTION	Peak (PK) Average (AV)
ENVIRONMENTAL CONDITIONS	23deg. C, 70%RH 1002 hPa	TESTED BY	Lori Chiu

ANTENNA POLARITY & TEST DISTANCE: HORIZONTAL AT 3 M								
NO.	FREQ. (MHz)	EMISSION LEVEL (dBuV/m)	LIMIT (dBuV/m)	MARGIN (dB)	ANTENNA HEIGHT (m)	TABLE ANGLE (Degree)	RAW VALUE (dBuV)	CORRECTION FACTOR (dB/m)
1	2390.00	59.63 PK	74.00	-14.37	1.33 H	321	27.41	32.22
2	2390.00	47.50 AV	54.00	-6.50	1.33 H	321	15.28	32.22
3	*2412.00	102.36 PK			1.33 H	325	70.06	32.30
4	*2412.00	92.34 AV			1.33 H	325	60.04	32.30
5	4824.00	48.92 PK	74.00	-25.08	1.01 H	118	10.59	38.33
6	4824.00	36.75 AV	54.00	-17.25	1.01 H	118	-1.58	38.33
ANTENNA POLARITY & TEST DISTANCE: VERTICAL AT 3 M								
NO.	FREQ. (MHz)	EMISSION LEVEL (dBuV/m)	LIMIT (dBuV/m)	MARGIN (dB)	ANTENNA HEIGHT (m)	TABLE ANGLE (Degree)	RAW VALUE (dBuV)	CORRECTION FACTOR (dB/m)
1	2360.00	59.12 PK	74.00	-14.88	1.11 V	250	27.02	32.10
2	2360.00	48.36 AV	54.00	-5.64	1.11 V	250	16.26	32.10
3	2390.00	68.50 PK	74.00	-5.50	1.23 V	248	36.28	32.22
4	2390.00	50.46 AV	54.00	-3.54	1.23 V	248	18.24	32.22
5	*2412.00	109.19 PK			1.11 V	248	76.89	32.30
6	*2412.00	99.28 AV			1.11 V	248	66.98	32.30
7	4824.00	50.33 PK	74.00	-23.67	1.00 V	199	12.00	38.33
8	4824.00	36.71 AV	54.00	-17.29	1.00 V	199	-1.62	38.33

- REMARKS:**
1. Emission level (dBuV/m) = Raw Value (dBuV) + Correction Factor (dB/m).
  2. Correction Factor (dB/m) = Antenna Factor (dB/m) + Cable Factor (dB).
  3. The other emission levels were very low against the limit.
  4. Margin value = Emission level – Limit value.
  5. “ \* “: Fundamental frequency.



A D T

EUT TEST CONDITION		MEASUREMENT DETAIL	
CHANNEL	Channel 6	FREQUENCY RANGE	1 ~ 25GHz
INPUT POWER	120Vac, 60 Hz	DETECTOR FUNCTION	Peak (PK) Average (AV)
ENVIRONMENTAL CONDITIONS	23deg. C, 70%RH 1002 hPa	TESTED BY	Lori Chiu

ANTENNA POLARITY & TEST DISTANCE: HORIZONTAL AT 3 M								
NO.	FREQ. (MHz)	EMISSION LEVEL (dBuV/m)	LIMIT (dBuV/m)	MARGIN (dB)	ANTENNA HEIGHT (m)	TABLE ANGLE (Degree)	RAW VALUE (dBuV)	CORRECTION FACTOR (dB/m)
1	2384.00	57.87 PK	74.00	-16.13	1.25 H	254	25.67	32.20
2	2384.00	47.70 AV	54.00	-6.30	1.25 H	254	15.50	32.20
3	*2437.00	107.62 PK			1.24 H	254	75.23	32.39
4	*2437.00	96.58 AV			1.24 H	254	64.19	32.39
5	2488.00	57.64 PK	74.00	-16.36	1.24 H	255	25.06	32.58
6	2488.00	46.49 AV	54.00	-7.51	1.24 H	255	13.91	32.58
7	4874.00	48.97 PK	74.00	-25.03	1.00 H	10	10.56	38.41
8	4874.00	37.62 AV	54.00	-16.38	1.00 H	10	-0.79	38.41
9	7311.00	62.87 PK	74.00	-11.13	1.22 H	208	18.23	44.64
10	7311.00	47.69 AV	54.00	-6.31	1.22 H	208	3.05	44.64
ANTENNA POLARITY & TEST DISTANCE: VERTICAL AT 3 M								
NO.	FREQ. (MHz)	EMISSION LEVEL (dBuV/m)	LIMIT (dBuV/m)	MARGIN (dB)	ANTENNA HEIGHT (m)	TABLE ANGLE (Degree)	RAW VALUE (dBuV)	CORRECTION FACTOR (dB/m)
1	2384.00	68.12 PK	74.00	-5.88	1.01 V	228	35.92	32.20
2	2384.00	51.62 AV	54.00	-2.38	1.01 V	228	19.42	32.20
3	*2437.00	114.10 PK			1.01 V	228	81.71	32.39
4	*2437.00	103.88 AV			1.01 V	228	71.49	32.39
5	2488.00	68.01 PK	74.00	-5.99	1.02 V	230	35.43	32.58
6	2488.00	51.69 AV	54.00	-2.31	1.02 V	230	19.11	32.58
7	4874.00	52.39 PK	74.00	-21.61	1.21 V	240	13.98	38.41
8	4874.00	37.41 AV	54.00	-16.59	1.21 V	240	-1.00	38.41
9	7311.00	58.36 PK	74.00	-15.64	1.50 V	287	13.72	44.64
10	7311.00	44.61 AV	54.00	-9.39	1.50 V	287	-0.03	44.64

- REMARKS:**
1. Emission level (dBuV/m) = Raw Value (dBuV) + Correction Factor (dB/m).
  2. Correction Factor (dB/m) = Antenna Factor (dB/m) + Cable Factor (dB).
  3. The other emission levels were very low against the limit.
  4. Margin value = Emission level – Limit value.
  5. “ \* “: Fundamental frequency.



A D T

EUT TEST CONDITION		MEASUREMENT DETAIL	
CHANNEL	Channel 11	FREQUENCY RANGE	1 ~ 25GHz
INPUT POWER	120Vac, 60 Hz	DETECTOR FUNCTION	Peak (PK) Average (AV)
ENVIRONMENTAL CONDITIONS	23deg. C, 70%RH 1002 hPa	TESTED BY	Lori Chiu

ANTENNA POLARITY & TEST DISTANCE: HORIZONTAL AT 3 M								
NO.	FREQ. (MHz)	EMISSION LEVEL (dBuV/m)	LIMIT (dBuV/m)	MARGIN (dB)	ANTENNA HEIGHT (m)	TABLE ANGLE (Degree)	RAW VALUE (dBuV)	CORRECTION FACTOR (dB/m)
1	*2462.00	103.49 PK			1.11 H	315	71.01	32.48
2	*2462.00	93.40 AV			1.11 H	315	60.92	32.48
3	2483.50	57.33 PK	74.00	-16.67	1.11 H	310	24.77	32.56
4	2483.50	46.89 AV	54.00	-7.11	1.11 H	310	14.33	32.56
5	4924.00	50.41 PK	74.00	-23.59	1.37 H	150	11.90	38.51
6	4924.00	36.66 AV	54.00	-17.34	1.37 H	150	-1.85	38.51
ANTENNA POLARITY & TEST DISTANCE: VERTICAL AT 3 M								
NO.	FREQ. (MHz)	EMISSION LEVEL (dBuV/m)	LIMIT (dBuV/m)	MARGIN (dB)	ANTENNA HEIGHT (m)	TABLE ANGLE (Degree)	RAW VALUE (dBuV)	CORRECTION FACTOR (dB/m)
1	*2462.00	110.31 PK			1.10 V	52	77.83	32.48
2	*2462.00	100.18 AV			1.10 V	52	67.70	32.48
3	2483.50	64.77 PK	74.00	-9.23	1.10 V	52	32.21	32.56
4	2483.50	49.63 AV	54.00	-4.37	1.10 V	52	17.07	32.56
5	4924.00	50.37 PK	74.00	-23.63	1.33 V	258	11.86	38.51
6	4924.00	36.88 AV	54.00	-17.12	1.33 V	258	-1.63	38.51

- REMARKS:**
1. Emission level (dBuV/m) = Raw Value (dBuV) + Correction Factor (dB/m).
  2. Correction Factor (dB/m) = Antenna Factor (dB/m) + Cable Factor (dB).
  3. The other emission levels were very low against the limit.
  4. Margin value = Emission level – Limit value.
  5. “ \* “: Fundamental frequency.





A D T

### DRAFT 802.11n (40MHz) OFDM MODULATION

EUT TEST CONDITION		MEASUREMENT DETAIL	
CHANNEL	Channel 1	FREQUENCY RANGE	1 ~ 25GHz
INPUT POWER	120Vac, 60 Hz	DETECTOR FUNCTION	Peak (PK) Average (AV)
ENVIRONMENTAL CONDITIONS	23deg. C, 70%RH 1002 hPa	TESTED BY	Lori Chiu

ANTENNA POLARITY & TEST DISTANCE: HORIZONTAL AT 3 M								
NO.	FREQ. (MHz)	EMISSION LEVEL (dBuV/m)	LIMIT (dBuV/m)	MARGIN (dB)	ANTENNA HEIGHT (m)	TABLE ANGLE (Degree)	RAW VALUE (dBuV)	CORRECTION FACTOR (dB/m)
1	2390.00	56.71 PK	74.00	-17.29	1.01 H	0	24.49	32.22
2	2390.00	46.82 AV	54.00	-7.18	1.01 H	0	14.60	32.22
3	*2422.00	94.21 PK			1.01 H	360	61.87	32.34
4	*2422.00	84.60 AV			1.01 H	360	52.26	32.34
5	4844.00	47.89 PK	74.00	-26.11	1.10 H	76	9.53	38.36
6	4844.00	36.27 AV	54.00	-17.73	1.10 H	76	-2.09	38.36
ANTENNA POLARITY & TEST DISTANCE: VERTICAL AT 3 M								
NO.	FREQ. (MHz)	EMISSION LEVEL (dBuV/m)	LIMIT (dBuV/m)	MARGIN (dB)	ANTENNA HEIGHT (m)	TABLE ANGLE (Degree)	RAW VALUE (dBuV)	CORRECTION FACTOR (dB/m)
1	2390.00	60.99 PK	74.00	-13.01	1.06 V	101	28.77	32.22
2	2390.00	49.60 AV	54.00	-4.40	1.06 V	101	17.38	32.22
3	*2422.00	102.12 PK			1.06 V	100	69.78	32.34
4	*2422.00	92.27 AV			1.06 V	100	59.93	32.34
5	4844.00	48.10 PK	74.00	-25.90	1.22 V	359	9.74	38.36
6	4844.00	35.62 AV	54.00	-18.38	1.22 V	359	-2.74	38.36

- REMARKS:**
1. Emission level (dBuV/m) = Raw Value (dBuV) + Correction Factor (dB/m).
  2. Correction Factor (dB/m) = Antenna Factor (dB/m) + Cable Factor (dB).
  3. The other emission levels were very low against the limit.
  4. Margin value = Emission level – Limit value.
  5. “ \* “: Fundamental frequency.



A D T

EUT TEST CONDITION		MEASUREMENT DETAIL	
CHANNEL	Channel 4	FREQUENCY RANGE	1 ~ 25GHz
INPUT POWER	120Vac, 60 Hz	DETECTOR FUNCTION	Peak (PK) Average (AV)
ENVIRONMENTAL CONDITIONS	23deg. C, 70%RH 1002 hPa	TESTED BY	Lori Chiu

ANTENNA POLARITY & TEST DISTANCE: HORIZONTAL AT 3 M								
NO.	FREQ. (MHz)	EMISSION LEVEL (dBuV/m)	LIMIT (dBuV/m)	MARGIN (dB)	ANTENNA HEIGHT (m)	TABLE ANGLE (Degree)	RAW VALUE (dBuV)	CORRECTION FACTOR (dB/m)
1	*2437.00	98.63 PK			1.22 H	158	66.24	32.39
2	*2437.00	89.27 AV			1.22 H	158	56.88	32.39
3	4874.00	48.37 PK	74.00	-25.63	1.20 H	6	9.96	38.41
4	4874.00	37.37 AV	54.00	-16.63	1.20 H	6	-1.04	38.41
ANTENNA POLARITY & TEST DISTANCE: VERTICAL AT 3 M								
NO.	FREQ. (MHz)	EMISSION LEVEL (dBuV/m)	LIMIT (dBuV/m)	MARGIN (dB)	ANTENNA HEIGHT (m)	TABLE ANGLE (Degree)	RAW VALUE (dBuV)	CORRECTION FACTOR (dB/m)
1	*2437.00	106.72 PK			1.11 V	290	74.33	32.39
2	*2437.00	97.10 AV			1.11 V	290	64.71	32.39
3	4874.00	48.02 PK	74.00	-25.98	1.20 V	50	9.61	38.41
4	4874.00	37.22 AV	54.00	-16.78	1.20 V	50	-1.19	38.41

- REMARKS:**
1. Emission level (dBuV/m) = Raw Value (dBuV) + Correction Factor (dB/m).
  2. Correction Factor (dB/m) = Antenna Factor (dB/m) + Cable Factor (dB).
  3. The other emission levels were very low against the limit.
  4. Margin value = Emission level – Limit value.
  5. “ \* “: Fundamental frequency.



A D T

EUT TEST CONDITION		MEASUREMENT DETAIL	
CHANNEL	Channel 7	FREQUENCY RANGE	1 ~ 25GHz
INPUT POWER	120Vac, 60 Hz	DETECTOR FUNCTION	Peak (PK) Average (AV)
ENVIRONMENTAL CONDITIONS	23deg. C, 70%RH 1002 hPa	TESTED BY	Lori Chiu

ANTENNA POLARITY & TEST DISTANCE: HORIZONTAL AT 3 M								
NO.	FREQ. (MHz)	EMISSION LEVEL (dBuV/m)	LIMIT (dBuV/m)	MARGIN (dB)	ANTENNA HEIGHT (m)	TABLE ANGLE (Degree)	RAW VALUE (dBuV)	CORRECTION FACTOR (dB/m)
1	*2452.00	95.69 PK			1.08 H	252	63.24	32.45
2	*2452.00	85.53 AV			1.08 H	252	53.08	32.45
3	2483.50	56.48 PK	74.00	-17.52	1.10 H	255	23.92	32.56
4	2483.50	46.93 AV	54.00	-7.07	1.10 H	255	14.37	32.56
5	4904.00	47.97 PK	74.00	-26.03	1.05 H	234	9.51	38.46
6	4904.00	36.49 AV	54.00	-17.51	1.05 H	234	-1.97	38.46
ANTENNA POLARITY & TEST DISTANCE: VERTICAL AT 3 M								
NO.	FREQ. (MHz)	EMISSION LEVEL (dBuV/m)	LIMIT (dBuV/m)	MARGIN (dB)	ANTENNA HEIGHT (m)	TABLE ANGLE (Degree)	RAW VALUE (dBuV)	CORRECTION FACTOR (dB/m)
1	*2452.00	103.22 PK			1.24 V	5	70.77	32.45
2	*2452.00	93.37 AV			1.24 V	5	60.92	32.45
3	2483.50	61.55 PK	74.00	-12.45	1.25 V	5	28.99	32.56
4	2483.50	50.37 AV	54.00	-3.63	1.25 V	5	17.81	32.56
5	4904.00	48.33 PK	74.00	-25.67	1.08 V	287	9.87	38.46
6	4904.00	35.73 AV	54.00	-18.27	1.08 V	287	-2.73	38.46

- REMARKS:**
1. Emission level (dBuV/m) = Raw Value (dBuV) + Correction Factor (dB/m).
  2. Correction Factor (dB/m) = Antenna Factor (dB/m) + Cable Factor (dB).
  3. The other emission levels were very low against the limit.
  4. Margin value = Emission level – Limit value.
  5. “ \* “: Fundamental frequency.



A D T

**BELOW 1GHz WORST-CASE DATA : 802.11g OFDM MODULATION**

EUT TEST CONDITION		MEASUREMENT DETAIL	
CHANNEL	Channel 6	FREQUENCY RANGE	Below 1000MHz
INPUT POWER	120Vac, 60 Hz	DETECTOR FUNCTION	Quasi-Peak
ENVIRONMENTAL CONDITIONS	23deg. C, 70%RH 1002 hPa	TESTED BY	Lori Chiu
TEST MODE	A		

ANTENNA POLARITY & TEST DISTANCE: HORIZONTAL AT 3 M								
NO.	FREQ. (MHz)	EMISSION LEVEL (dBuV/m)	LIMIT (dBuV/m)	MARGIN (dB)	ANTENNA HEIGHT (m)	TABLE ANGLE (Degree)	RAW VALUE (dBuV)	CORRECTION FACTOR (dB/m)
1	99.89	32.92 QP	43.50	-10.58	1.50 H	238	23.59	9.33
2	185.44	29.87 QP	43.50	-13.63	1.50 H	94	18.11	11.76
3	426.53	33.67 QP	46.00	-12.33	2.00 H	37	16.73	16.94
4	533.47	37.11 QP	46.00	-8.89	1.50 H	355	16.85	20.26
5	640.41	37.58 QP	46.00	-8.42	1.25 H	325	15.34	22.24
6	854.28	40.64 QP	46.00	-5.36	1.50 H	268	14.96	25.67
ANTENNA POLARITY & TEST DISTANCE: VERTICAL AT 3 M								
NO.	FREQ. (MHz)	EMISSION LEVEL (dBuV/m)	LIMIT (dBuV/m)	MARGIN (dB)	ANTENNA HEIGHT (m)	TABLE ANGLE (Degree)	RAW VALUE (dBuV)	CORRECTION FACTOR (dB/m)
1	41.57	35.86 QP	40.00	-4.14	1.00 V	76	23.39	12.48
2	64.90	35.60 QP	40.00	-4.40	1.00 V	199	23.11	12.49
3	99.89	39.01 QP	43.50	-4.49	1.00 V	241	29.68	9.33
4	533.47	37.74 QP	46.00	-8.26	1.00 V	268	17.48	20.26
5	640.41	37.19 QP	46.00	-8.81	1.75 V	301	14.95	22.24
6	854.28	36.43 QP	46.00	-9.57	1.25 V	316	10.76	25.67

- REMARKS:**
1. Emission level (dBuV/m) = Raw Value (dBuV) + Correction Factor (dB/m).
  2. Correction Factor (dB/m) = Antenna Factor (dB/m) + Cable Factor (dB).
  3. The other emission levels were very low against the limit.
  4. Margin value = Emission level – Limit value.



A D T

EUT TEST CONDITION		MEASUREMENT DETAIL	
CHANNEL	Channel 6	FREQUENCY RANGE	Below 1000MHz
INPUT POWER	120Vac, 60 Hz	DETECTOR FUNCTION	Quasi-Peak
ENVIRONMENTAL CONDITIONS	23deg. C, 70%RH 1002 hPa	TESTED BY	Lori Chiu
TEST MODE	B		

ANTENNA POLARITY & TEST DISTANCE: HORIZONTAL AT 3 M								
NO.	FREQ. (MHz)	EMISSION LEVEL (dBuV/m)	LIMIT (dBuV/m)	MARGIN (dB)	ANTENNA HEIGHT (m)	TABLE ANGLE (Degree)	RAW VALUE (dBuV)	CORRECTION FACTOR (dB/m)
1	99.89	32.81 QP	43.50	-10.69	2.00 H	244	23.48	9.33
2	426.53	33.30 QP	46.00	-12.70	2.00 H	25	16.36	16.94
3	533.47	37.07 QP	46.00	-8.93	1.75 H	352	16.81	20.26
4	640.41	37.54 QP	46.00	-8.46	1.25 H	46	15.30	22.24
5	854.28	38.47 QP	46.00	-7.53	1.50 H	61	12.79	25.67
6	961.21	40.37 QP	54.00	-13.63	1.50 H	7	13.83	26.54
ANTENNA POLARITY & TEST DISTANCE: VERTICAL AT 3 M								
NO.	FREQ. (MHz)	EMISSION LEVEL (dBuV/m)	LIMIT (dBuV/m)	MARGIN (dB)	ANTENNA HEIGHT (m)	TABLE ANGLE (Degree)	RAW VALUE (dBuV)	CORRECTION FACTOR (dB/m)
1	55.18	35.54 QP	40.00	-4.46	1.00 V	319	22.00	13.53
2	64.90	35.26 QP	40.00	-4.74	1.00 V	181	22.77	12.49
3	99.89	37.96 QP	43.50	-5.54	1.25 V	265	28.63	9.33
4	533.47	37.56 QP	46.00	-8.44	1.00 V	283	17.30	20.26
5	630.69	39.76 QP	46.00	-6.24	1.50 V	163	17.60	22.16
6	854.28	36.21 QP	46.00	-9.79	1.25 V	319	10.54	25.67

- REMARKS:**
1. Emission level (dBuV/m) = Raw Value (dBuV) + Correction Factor (dB/m).
  2. Correction Factor (dB/m) = Antenna Factor (dB/m) + Cable Factor (dB).
  3. The other emission levels were very low against the limit.
  4. Margin value = Emission level – Limit value.



A D T

EUT TEST CONDITION		MEASUREMENT DETAIL	
CHANNEL	Channel 6	FREQUENCY RANGE	Below 1000MHz
INPUT POWER	120Vac, 60 Hz	DETECTOR FUNCTION	Quasi-Peak
ENVIRONMENTAL CONDITIONS	23deg. C, 70%RH 1002 hPa	TESTED BY	Lori Chiu
TEST MODE	C		

ANTENNA POLARITY & TEST DISTANCE: HORIZONTAL AT 3 M								
NO.	FREQ. (MHz)	EMISSION LEVEL (dBuV/m)	LIMIT (dBuV/m)	MARGIN (dB)	ANTENNA HEIGHT (m)	TABLE ANGLE (Degree)	RAW VALUE (dBuV)	CORRECTION FACTOR (dB/m)
1	30.00	24.57 QP	40.00	-15.43	2.00 H	334	12.29	12.28
2	99.89	31.61 QP	43.50	-11.89	1.75 H	259	22.28	9.33
3	426.53	31.64 QP	46.00	-14.36	1.00 H	175	14.70	16.94
4	533.47	37.30 QP	46.00	-8.70	1.50 H	184	17.04	20.26
5	640.41	41.71 QP	46.00	-4.29	1.25 H	145	19.47	22.24
6	854.28	38.67 QP	46.00	-7.33	1.75 H	286	12.99	25.67
ANTENNA POLARITY & TEST DISTANCE: VERTICAL AT 3 M								
NO.	FREQ. (MHz)	EMISSION LEVEL (dBuV/m)	LIMIT (dBuV/m)	MARGIN (dB)	ANTENNA HEIGHT (m)	TABLE ANGLE (Degree)	RAW VALUE (dBuV)	CORRECTION FACTOR (dB/m)
1	41.57	36.26 QP	40.00	-3.74	1.25 V	121	23.79	12.48
2	99.89	40.97 QP	43.50	-2.53	1.00 V	250	31.64	9.33
3	506.25	33.40 QP	46.00	-12.60	1.00 V	259	13.97	19.43
4	533.47	31.55 QP	46.00	-14.45	1.00 V	97	11.29	20.26
5	640.41	35.11 QP	46.00	-10.89	1.00 V	106	12.87	22.24
6	854.28	40.08 QP	46.00	-5.92	1.25 V	268	14.41	25.67

- REMARKS:**
1. Emission level (dBuV/m) = Raw Value (dBuV) + Correction Factor (dB/m).
  2. Correction Factor (dB/m) = Antenna Factor (dB/m) + Cable Factor (dB).
  3. The other emission levels were very low against the limit.
  4. Margin value = Emission level – Limit value.



A D T

EUT TEST CONDITION		MEASUREMENT DETAIL	
CHANNEL	Channel 6	FREQUENCY RANGE	Below 1000MHz
INPUT POWER	120Vac, 60 Hz	DETECTOR FUNCTION	Quasi-Peak
ENVIRONMENTAL CONDITIONS	23deg. C, 70%RH 1002 hPa	TESTED BY	Lori Chiu
TEST MODE	D		

ANTENNA POLARITY & TEST DISTANCE: HORIZONTAL AT 3 M								
NO.	FREQ. (MHz)	EMISSION LEVEL (dBuV/m)	LIMIT (dBuV/m)	MARGIN (dB)	ANTENNA HEIGHT (m)	TABLE ANGLE (Degree)	RAW VALUE (dBuV)	CORRECTION FACTOR (dB/m)
1	99.89	33.06 QP	43.50	-10.44	1.75 H	274	23.73	9.33
2	175.72	30.11 QP	43.50	-13.39	1.50 H	283	17.59	12.52
3	426.53	33.60 QP	46.00	-12.40	2.00 H	34	16.66	16.94
4	533.47	37.43 QP	46.00	-8.57	1.50 H	46	17.17	20.26
5	640.41	37.65 QP	46.00	-8.35	1.25 H	34	15.41	22.24
6	854.28	38.39 QP	46.00	-7.61	1.00 H	61	12.72	25.67
7	961.21	40.03 QP	54.00	-13.97	1.50 H	34	13.49	26.54
ANTENNA POLARITY & TEST DISTANCE: VERTICAL AT 3 M								
NO.	FREQ. (MHz)	EMISSION LEVEL (dBuV/m)	LIMIT (dBuV/m)	MARGIN (dB)	ANTENNA HEIGHT (m)	TABLE ANGLE (Degree)	RAW VALUE (dBuV)	CORRECTION FACTOR (dB/m)
1	30.00	35.85 QP	40.00	-4.15	1.00 V	160	23.57	12.28
2	64.90	35.86 QP	40.00	-4.14	1.00 V	238	23.37	12.49
3	99.89	38.51 QP	43.50	-4.99	1.25 V	262	29.18	9.33
4	533.47	37.74 QP	46.00	-8.26	1.00 V	286	17.47	20.26
5	640.41	37.32 QP	46.00	-8.68	1.75 V	307	15.08	22.24
6	854.28	36.90 QP	46.00	-9.10	1.25 V	319	11.23	25.67

- REMARKS:**
1. Emission level (dBuV/m) = Raw Value (dBuV) + Correction Factor (dB/m).
  2. Correction Factor (dB/m) = Antenna Factor (dB/m) + Cable Factor (dB).
  3. The other emission levels were very low against the limit.
  4. Margin value = Emission level – Limit value.



A D T

## 4.2 CONDUCTED EMISSION MEASUREMENT

### 4.2.1 LIMITS OF CONDUCTED EMISSION MEASUREMENT

FREQUENCY OF EMISSION (MHz)	CONDUCTED LIMIT (dB $\mu$ V)	
	Quasi-peak	Average
0.15 ~ 0.5	66 to 56	56 to 46
0.5 ~ 5	56	46
5 ~ 30	60	50

- NOTE:** 1. The lower limit shall apply at the transition frequencies.  
2. The limit decreases in line with the logarithm of the frequency in the range of 0.15 to 0.50MHz.  
3. All emanations from a class A/B digital device or system, including any network of conductors and apparatus connected thereto, shall not exceed the level of field strengths specified above.

### 4.2.2 TEST INSTRUMENTS

DESCRIPTION & MANUFACTURER	MODEL NO.	SERIAL NO.	DATE OF CALIBRATION	DUE DATE OF CALIBRATION
Test Receiver ROHDE & SCHWARZ	ESCS30	100288	Sep. 22, 2008	Sep. 21, 2009
RF signal cable Woken	5D-FB	Cable-HYCO2-01	Dec. 31, 2008	Dec. 30, 2009
LISN ROHDE & SCHWARZ	ESH2-Z5	100100	Dec. 29, 2008	Dec. 28, 2009
LISN ROHDE & SCHWARZ	ESH3-Z5	100311	Jul. 30, 2008	Jul. 29, 2009
Software ADT	ADT_Cond_ V7.3.7	NA	NA	NA

- NOTE:** 1. The calibration interval of the above test instruments is 12 months and the calibrations are traceable to NML/ROC and NIST/USA.  
2. The test was performed in HwaYa Shielded Room 2.  
3. The VCCI Site Registration No. is C-2047.





#### 4.2.3 TEST PROCEDURES

- a. The EUT was placed 0.4 meters from the conducting wall of the shielded room with EUT being connected to the power mains through a line impedance stabilization network (LISN). Other support units were connected to the power mains through another LISN. The two LISNs provide 50 ohm/ 50uH of coupling impedance for the measuring instrument.
- b. Both lines of the power mains connected to the EUT were checked for maximum conducted interference.
- c. The frequency range from 150kHz to 30MHz was searched. Emission levels under (Limit - 20dB) was not recorded.

**NOTE:** All modes of operation were investigated and the worst-case emissions are reported.

#### 4.2.4 DEVIATION FROM TEST STANDARD

No deviation.

#### 4.2.5 TEST SETUP

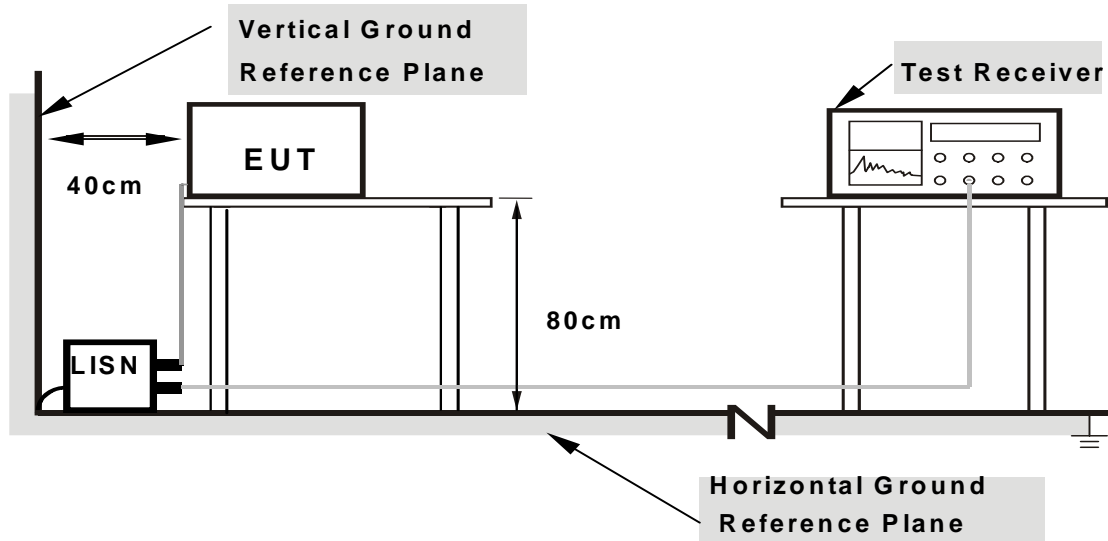

- Note:**
1. Support units were connected to second LISN.
  2. Both of LISNs (AMN) are 80 cm from EUT and at least 80 from other units and other metal planes

For the actual test configuration, please refer to the attached file (Test Setup Photo).

#### 4.2.6 EUT OPERATING CONDITIONS

Same as 4.1.6.

### 4.2.7 TEST RESULTS

#### CONDUCTED WORST-CASE DATA : 802.11g OFDM MODULATION

EUT TEST CONDITION		MEASUREMENT DETAIL	
CHANNEL	Channel 6	PHASE	Line 1
MODULATION TYPE	BPSK	INPUT POWER	120Vac, 60Hz
TRANSFER RATE	6.0Mbps	6dB BANDWIDTH	9kHz
ENVIRONMENTAL CONDITIONS	20deg. C, 60%RH, 1007hPa	TESTED BY	Match Tsui
TEST MODE	A		

No	Freq. [MHz]	Corr. Factor (dB)	Reading Value [dB (uV)]		Emission Level [dB (uV)]		Limit [dB (uV)]		Margin (dB)	
			Q.P.	AV.	Q.P.	AV.	Q.P.	AV.	Q.P.	AV.
1	0.189	0.13	26.89	-	27.02	-	64.08	54.08	-37.06	-
2	0.267	0.13	26.83	-	26.96	-	61.20	51.20	-34.24	-
3	0.927	0.17	29.23	-	29.40	-	56.00	46.00	-26.60	-
4	2.961	0.23	35.26	-	35.49	-	56.00	46.00	-20.51	-
5	6.242	0.34	43.98	-	44.32	-	60.00	50.00	-15.68	-
6	16.230	0.58	35.64	-	36.22	-	60.00	50.00	-23.78	-

- REMARKS:**
1. Q.P. and AV. are abbreviations of quasi-peak and average individually.
  2. "-": The Quasi-peak reading value also meets average limit and measurement with the average detector is unnecessary.
  3. The emission levels of other frequencies were very low against the limit.
  4. Margin value = Emission level - Limit value
  5. Correction factor = Insertion loss + Cable loss
  6. Emission Level = Correction Factor + Reading Value.

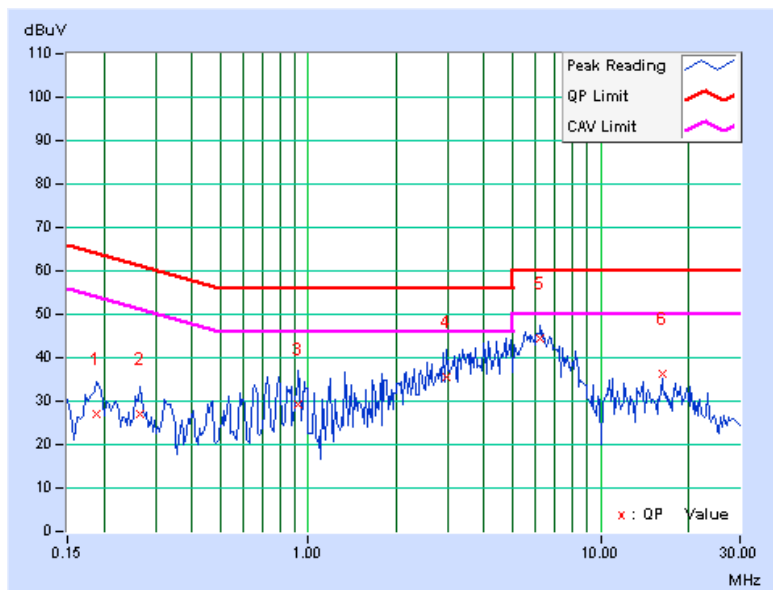

EUT TEST CONDITION		MEASUREMENT DETAIL	
CHANNEL	Channel 6	PHASE	Line 2
MODULATION TYPE	BPSK	INPUT POWER	120Vac, 60Hz
TRANSFER RATE	6.0Mbps	6dB BANDWIDTH	9kHz
ENVIRONMENTAL CONDITIONS	20deg. C, 60%RH, 1007hPa	TESTED BY	Match Tsui
TEST MODE	A		

No	Freq. [MHz]	Corr. Factor (dB)	Reading Value [dB (uV)]		Emission Level [dB (uV)]		Limit [dB (uV)]		Margin (dB)	
			Q.P.	AV.	Q.P.	AV.	Q.P.	AV.	Q.P.	AV.
			1	0.263	0.14	32.95	-	33.09	-	61.33
2	0.463	0.15	31.38	-	31.53	-	56.65	46.65	-25.12	-
3	0.728	0.16	31.92	-	32.08	-	56.00	46.00	-23.92	-
4	3.301	0.27	35.17	-	35.44	-	56.00	46.00	-20.56	-
5	5.680	0.36	38.65	-	39.01	-	60.00	50.00	-20.99	-
6	16.230	0.70	35.42	-	36.12	-	60.00	50.00	-23.88	-

- REMARKS:**
1. Q.P. and AV. are abbreviations of quasi-peak and average individually.
  2. "-": The Quasi-peak reading value also meets average limit and measurement with the average detector is unnecessary.
  3. The emission levels of other frequencies were very low against the limit.
  4. Margin value = Emission level - Limit value
  5. Correction factor = Insertion loss + Cable loss
  6. Emission Level = Correction Factor + Reading Value.

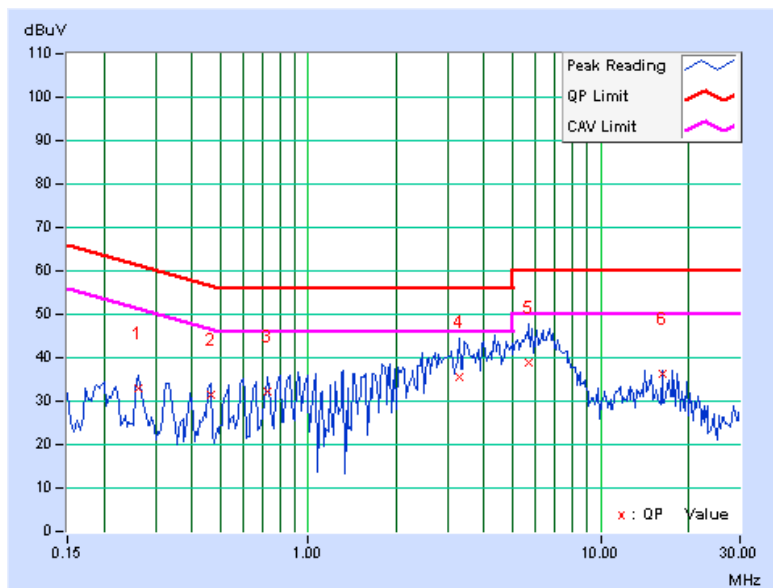

EUT TEST CONDITION		MEASUREMENT DETAIL	
CHANNEL	Channel 6	PHASE	Line 1
MODULATION TYPE	BPSK	INPUT POWER	120Vac, 60Hz
TRANSFER RATE	6.0Mbps	6dB BANDWIDTH	9kHz
ENVIRONMENTAL CONDITIONS	20deg. C, 60%RH, 1007hPa	TESTED BY	Match Tsui
TEST MODE	B		

No	Freq. [MHz]	Corr. Factor (dB)	Reading Value [dB (uV)]		Emission Level [dB (uV)]		Limit [dB (uV)]		Margin (dB)	
			Q.P.	AV.	Q.P.	AV.	Q.P.	AV.	Q.P.	AV.
1	0.173	0.13	40.43	-	40.56	-	64.79	54.79	-24.23	-
2	0.271	0.13	44.12	-	44.25	-	61.08	51.08	-16.83	-
3	0.720	0.16	34.00	-	34.16	-	56.00	46.00	-21.84	-
4	3.480	0.26	34.58	-	34.84	-	56.00	46.00	-21.16	-
5	4.789	0.30	38.01	-	38.31	-	56.00	46.00	-17.69	-
6	9.484	0.42	35.18	-	35.60	-	60.00	50.00	-24.40	-

- REMARKS:**
1. Q.P. and AV. are abbreviations of quasi-peak and average individually.
  2. "-": The Quasi-peak reading value also meets average limit and measurement with the average detector is unnecessary.
  3. The emission levels of other frequencies were very low against the limit.
  4. Margin value = Emission level - Limit value
  5. Correction factor = Insertion loss + Cable loss
  6. Emission Level = Correction Factor + Reading Value.

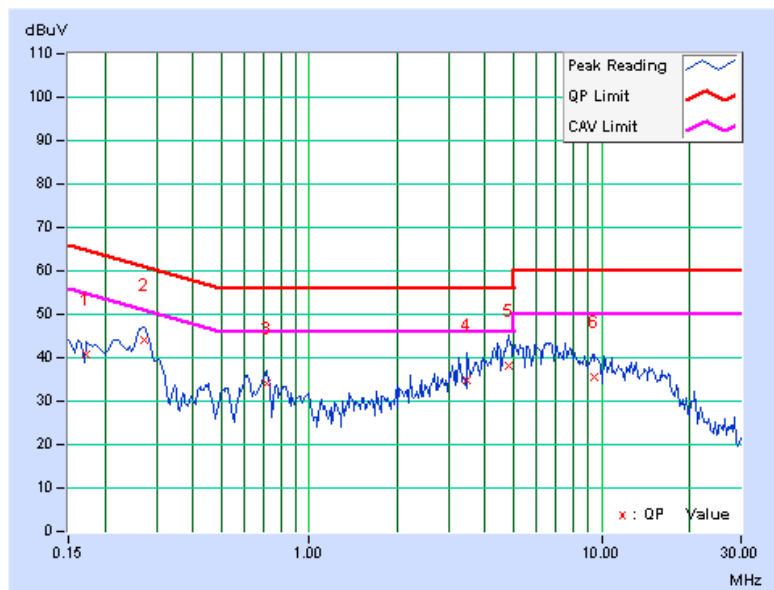

EUT TEST CONDITION		MEASUREMENT DETAIL	
CHANNEL	Channel 6	PHASE	Line 2
MODULATION TYPE	BPSK	INPUT POWER	120Vac, 60Hz
TRANSFER RATE	6.0Mbps	6dB BANDWIDTH	9kHz
ENVIRONMENTAL CONDITIONS	20deg. C, 60%RH, 1007hPa	TESTED BY	Match Tsui
TEST MODE	B		

No	Freq. [MHz]	Corr. Factor (dB)	Reading Value [dB (uV)]		Emission Level [dB (uV)]		Limit [dB (uV)]		Margin (dB)	
			Q.P.	AV.	Q.P.	AV.	Q.P.	AV.	Q.P.	AV.
1	0.162	0.13	41.92	-	42.05	-	65.38	55.38	-23.33	-
2	0.267	0.14	40.75	-	40.89	-	61.20	51.20	-20.32	-
3	0.720	0.16	27.24	-	27.40	-	56.00	46.00	-28.60	-
4	3.605	0.28	30.71	-	30.99	-	56.00	46.00	-25.01	-
5	6.113	0.37	33.73	-	34.10	-	60.00	50.00	-25.90	-
6	15.699	0.69	27.96	-	28.65	-	60.00	50.00	-31.35	-

- REMARKS:**
1. Q.P. and AV. are abbreviations of quasi-peak and average individually.
  2. "-": The Quasi-peak reading value also meets average limit and measurement with the average detector is unnecessary.
  3. The emission levels of other frequencies were very low against the limit.
  4. Margin value = Emission level - Limit value
  5. Correction factor = Insertion loss + Cable loss
  6. Emission Level = Correction Factor + Reading Value.

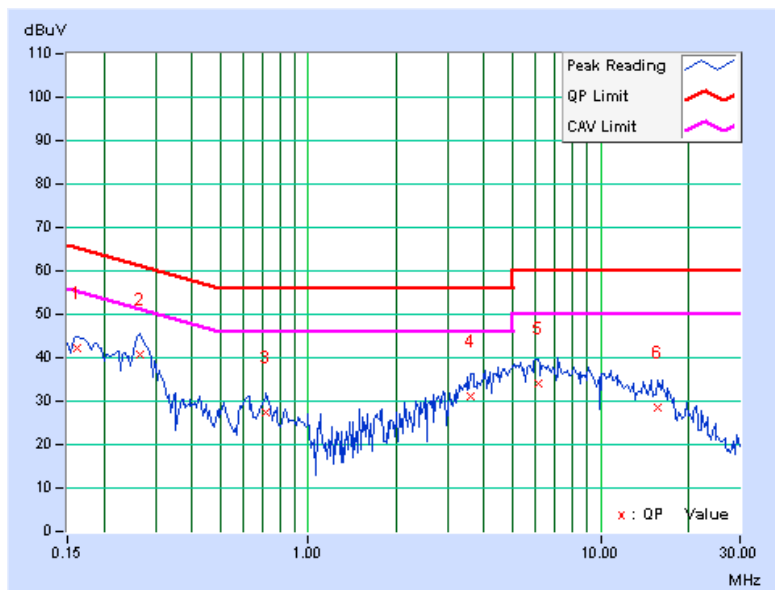



A D T

EUT TEST CONDITION		MEASUREMENT DETAIL	
CHANNEL	Channel 6	PHASE	Line 1
MODULATION TYPE	BPSK	INPUT POWER	120Vac, 60Hz
TRANSFER RATE	6.0Mbps	6dB BANDWIDTH	9kHz
ENVIRONMENTAL CONDITIONS	20deg. C, 60%RH, 1007hPa	TESTED BY	Match Tsui
TEST MODE	C		

No	Freq. [MHz]	Corr. Factor (dB)	Reading Value [dB (uV)]		Emission Level [dB (uV)]		Limit [dB (uV)]		Margin (dB)	
			Q.P.	AV.	Q.P.	AV.	Q.P.	AV.	Q.P.	AV.
1	0.181	0.13	42.46	-	42.59	-	64.43	54.43	-21.84	-
2	0.365	0.14	52.11	41.14	52.25	41.28	58.62	48.62	-6.37	-7.34
3	0.982	0.17	37.13	-	37.30	-	56.00	46.00	-18.70	-
4	2.219	0.20	35.51	-	35.71	-	56.00	46.00	-20.29	-
5	3.191	0.24	35.72	-	35.96	-	56.00	46.00	-20.04	-
6	23.129	0.65	36.16	-	36.81	-	60.00	50.00	-23.19	-

- REMARKS:**
1. Q.P. and AV. are abbreviations of quasi-peak and average individually.
  2. "-": The Quasi-peak reading value also meets average limit and measurement with the average detector is unnecessary.
  3. The emission levels of other frequencies were very low against the limit.
  4. Margin value = Emission level - Limit value
  5. Correction factor = Insertion loss + Cable loss
  6. Emission Level = Correction Factor + Reading Value.

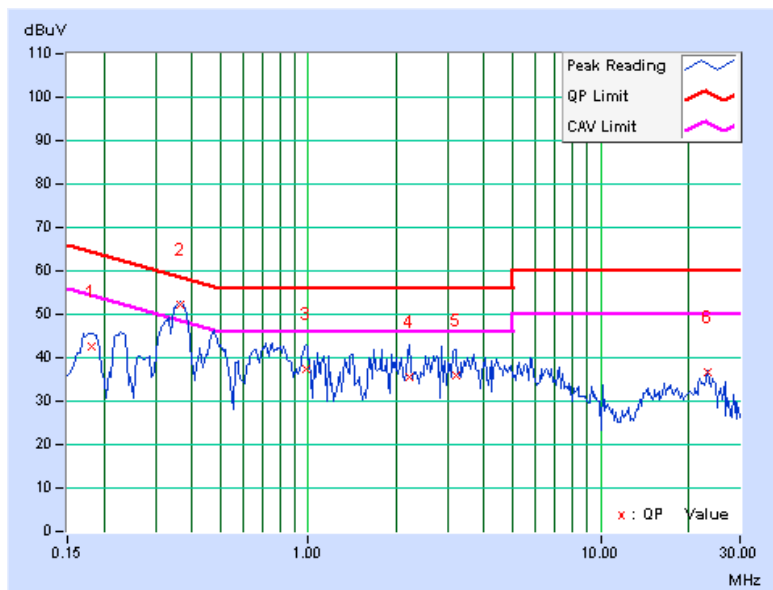

EUT TEST CONDITION		MEASUREMENT DETAIL	
CHANNEL	Channel 6	PHASE	Line 2
MODULATION TYPE	BPSK	INPUT POWER	120Vac, 60Hz
TRANSFER RATE	6.0Mbps	6dB BANDWIDTH	9kHz
ENVIRONMENTAL CONDITIONS	20deg. C, 60%RH, 1007hPa	TESTED BY	Match Tsui
TEST MODE	C		

No	Freq. [MHz]	Corr. Factor (dB)	Reading Value [dB (uV)]		Emission Level [dB (uV)]		Limit [dB (uV)]		Margin (dB)	
			Q.P.	AV.	Q.P.	AV.	Q.P.	AV.	Q.P.	AV.
1	0.177	0.13	43.03	-	43.16	-	64.61	54.61	-21.45	-
2	0.361	0.15	46.19	-	46.34	-	58.71	48.71	-12.37	-
3	0.791	0.16	34.70	-	34.86	-	56.00	46.00	-21.14	-
4	2.102	0.21	32.61	-	32.82	-	56.00	46.00	-23.18	-
5	3.047	0.25	32.18	-	32.43	-	56.00	46.00	-23.57	-
6	23.129	0.80	35.27	-	36.07	-	60.00	50.00	-23.93	-

- REMARKS:**
1. Q.P. and AV. are abbreviations of quasi-peak and average individually.
  2. "-": The Quasi-peak reading value also meets average limit and measurement with the average detector is unnecessary.
  3. The emission levels of other frequencies were very low against the limit.
  4. Margin value = Emission level - Limit value
  5. Correction factor = Insertion loss + Cable loss
  6. Emission Level = Correction Factor + Reading Value.

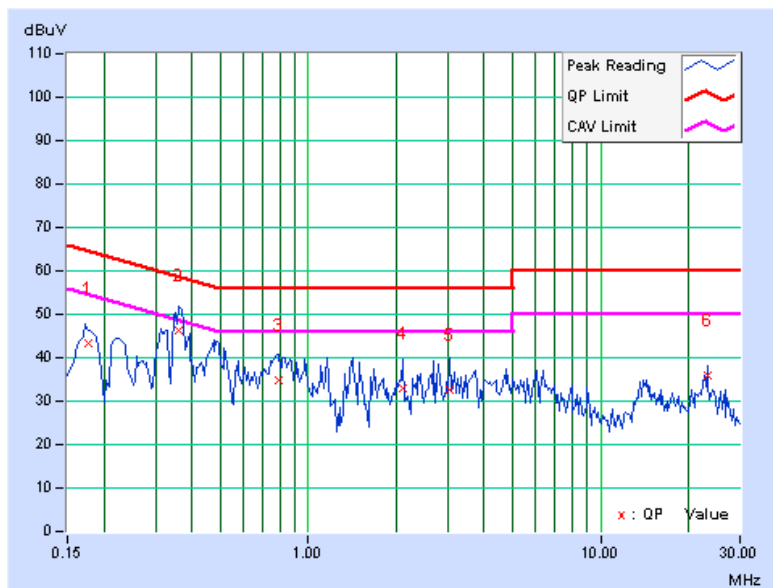



EUT TEST CONDITION		MEASUREMENT DETAIL	
CHANNEL	Channel 6	PHASE	Line 1
MODULATION TYPE	BPSK	INPUT POWER	120Vac, 60Hz
TRANSFER RATE	6.0Mbps	6dB BANDWIDTH	9kHz
ENVIRONMENTAL CONDITIONS	20deg. C, 60%RH, 1007hPa	TESTED BY	Match Tsui
TEST MODE	D		

No	Freq. [MHz]	Corr. Factor (dB)	Reading Value [dB (uV)]		Emission Level [dB (uV)]		Limit [dB (uV)]		Margin (dB)	
			Q.P.	AV.	Q.P.	AV.	Q.P.	AV.	Q.P.	AV.
1	0.150	0.13	32.51	-	32.64	-	66.00	56.00	-33.36	-
2	0.298	0.13	41.53	-	41.66	-	60.29	50.29	-18.62	-
3	0.908	0.17	30.41	-	30.58	-	56.00	46.00	-25.42	-
4	1.844	0.19	30.36	-	30.55	-	56.00	46.00	-25.45	-
5	10.887	0.45	34.00	-	34.45	-	60.00	50.00	-25.55	-
6	15.180	0.56	35.36	-	35.92	-	60.00	50.00	-24.08	-

- REMARKS:**
1. Q.P. and AV. are abbreviations of quasi-peak and average individually.
  2. "-": The Quasi-peak reading value also meets average limit and measurement with the average detector is unnecessary.
  3. The emission levels of other frequencies were very low against the limit.
  4. Margin value = Emission level - Limit value
  5. Correction factor = Insertion loss + Cable loss
  6. Emission Level = Correction Factor + Reading Value.

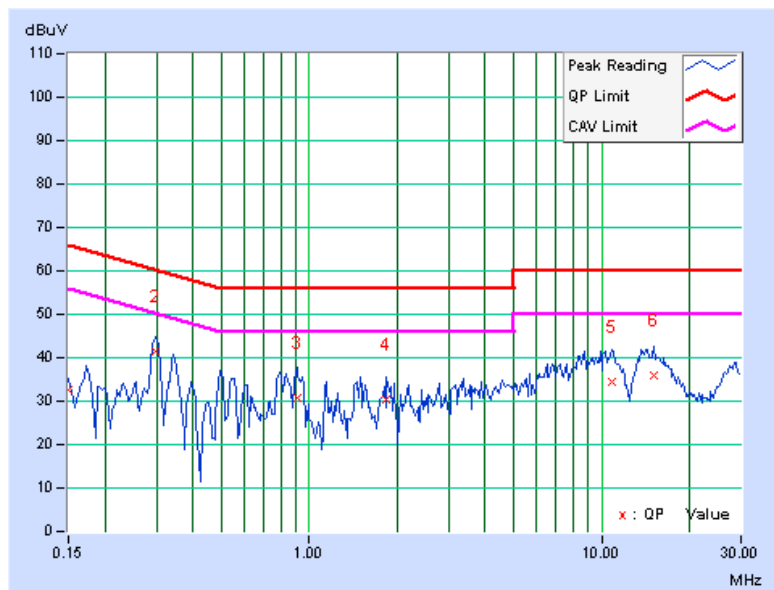

EUT TEST CONDITION		MEASUREMENT DETAIL	
CHANNEL	Channel 6	PHASE	Line 2
MODULATION TYPE	BPSK	INPUT POWER	120Vac, 60Hz
TRANSFER RATE	6.0Mbps	6dB BANDWIDTH	9kHz
ENVIRONMENTAL CONDITIONS	20deg. C, 60%RH, 1007hPa	TESTED BY	Match Tsui
TEST MODE	D		

No	Freq. [MHz]	Corr. Factor (dB)	Reading Value [dB (uV)]		Emission Level [dB (uV)]		Limit [dB (uV)]		Margin (dB)	
			Q.P.	AV.	Q.P.	AV.	Q.P.	AV.	Q.P.	AV.
1	0.150	0.13	32.88	-	33.01	-	66.00	56.00	-32.99	-
2	0.296	0.14	39.62	-	39.76	-	60.36	50.36	-20.60	-
3	0.904	0.17	28.69	-	28.86	-	56.00	46.00	-27.14	-
4	1.531	0.19	27.00	-	27.19	-	56.00	46.00	-28.81	-
5	10.098	0.50	30.83	-	31.33	-	60.00	50.00	-28.67	-
6	14.105	0.64	31.94	-	32.58	-	60.00	50.00	-27.42	-

- REMARKS:**
1. Q.P. and AV. are abbreviations of quasi-peak and average individually.
  2. "-": The Quasi-peak reading value also meets average limit and measurement with the average detector is unnecessary.
  3. The emission levels of other frequencies were very low against the limit.
  4. Margin value = Emission level - Limit value
  5. Correction factor = Insertion loss + Cable loss
  6. Emission Level = Correction Factor + Reading Value.

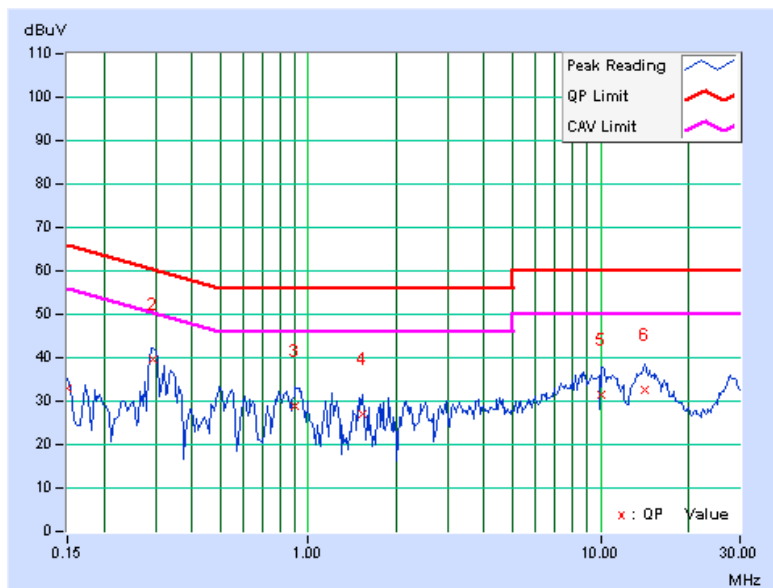

### 4.3 6dB BANDWIDTH MEASUREMENT

#### 4.3.1 LIMITS OF 6dB BANDWIDTH MEASUREMENT

The minimum of 6dB Bandwidth Measurement is 0.5 MHz.

#### 4.3.2 TEST INSTRUMENTS

DESCRIPTION & MANUFACTURER	MODEL NO.	SERIAL NO.	DATE OF CALIBRATION	DUE DATE OF CALIBRATION
R&S SPECTRUM ANALYZER	FSP40	100041	May 13, 2009	May 12, 2010

**NOTE:** The calibration interval of the above test instruments is 12 months and the calibrations are traceable to NML/ROC and NIST/USA.

#### 4.3.3 TEST PROCEDURE

The transmitter output was connected to the spectrum analyzer through an attenuator. The bandwidth of the fundamental frequency was measured by spectrum analyzer with 100kHz RBW and 300kHz VBW. The 6dB bandwidth is defined as the total spectrum the power of which is higher than peak power minus 6dB.

#### 4.3.4 DEVIATION FROM TEST STANDARD

No deviation.

#### 4.3.5 TEST SETUP

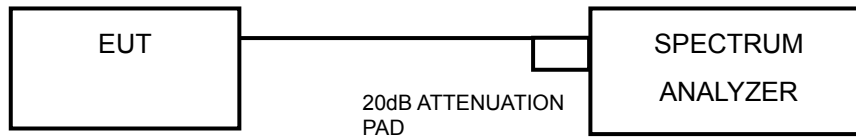

#### 4.3.6 EUT OPERATING CONDITIONS

The software provided by client to enable the EUT under transmission condition continuously at lowest, middle and highest channel frequencies individually.



A D T

### 4.3.7 TEST RESULTS

#### 802.11b DSSS MODULATION

<b>MODULATION TYPE</b>	DBPSK	<b>TRANSFER RATE</b>	1.0Mbps
<b>INPUT POWER</b>	120Vac, 60Hz	<b>ENVIRONMENTAL CONDITIONS</b>	23deg.C, 70%RH, 1009hPa
<b>TESTED BY</b>	Lori Chiu		

CHANNEL	CHANNEL FREQUENCY (MHz)	6dB BANDWIDTH (MHz)	MINIMUM LIMIT (MHz)	PASS / FAIL
1	2412	12.17	0.5	PASS
6	2437	12.15	0.5	PASS
11	2462	12.14	0.5	PASS

#### CH 1

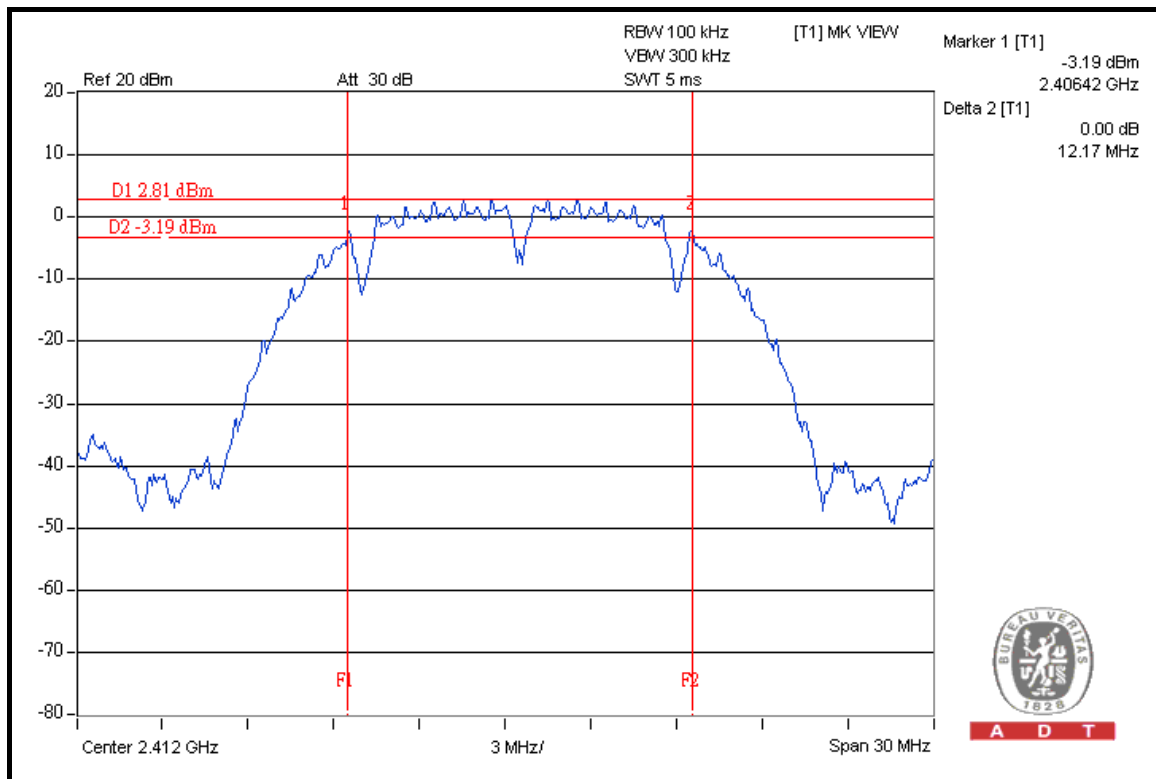



A D T

### CH 6

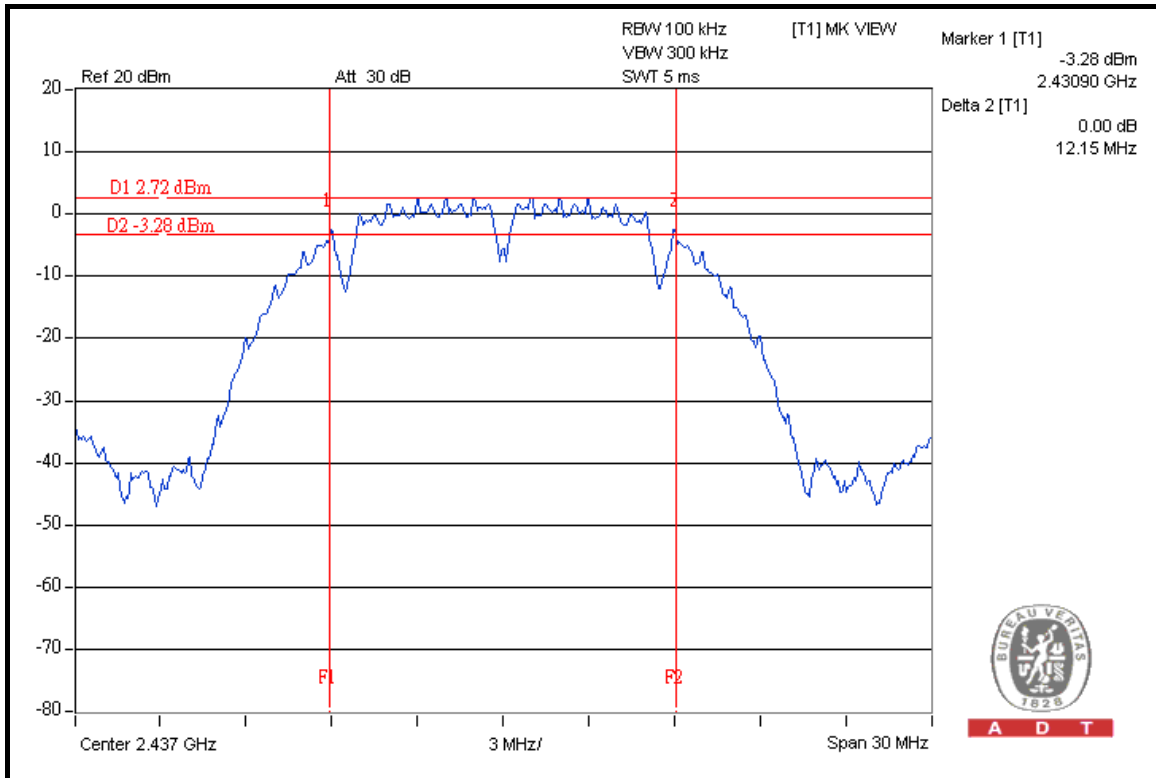

### CH 11

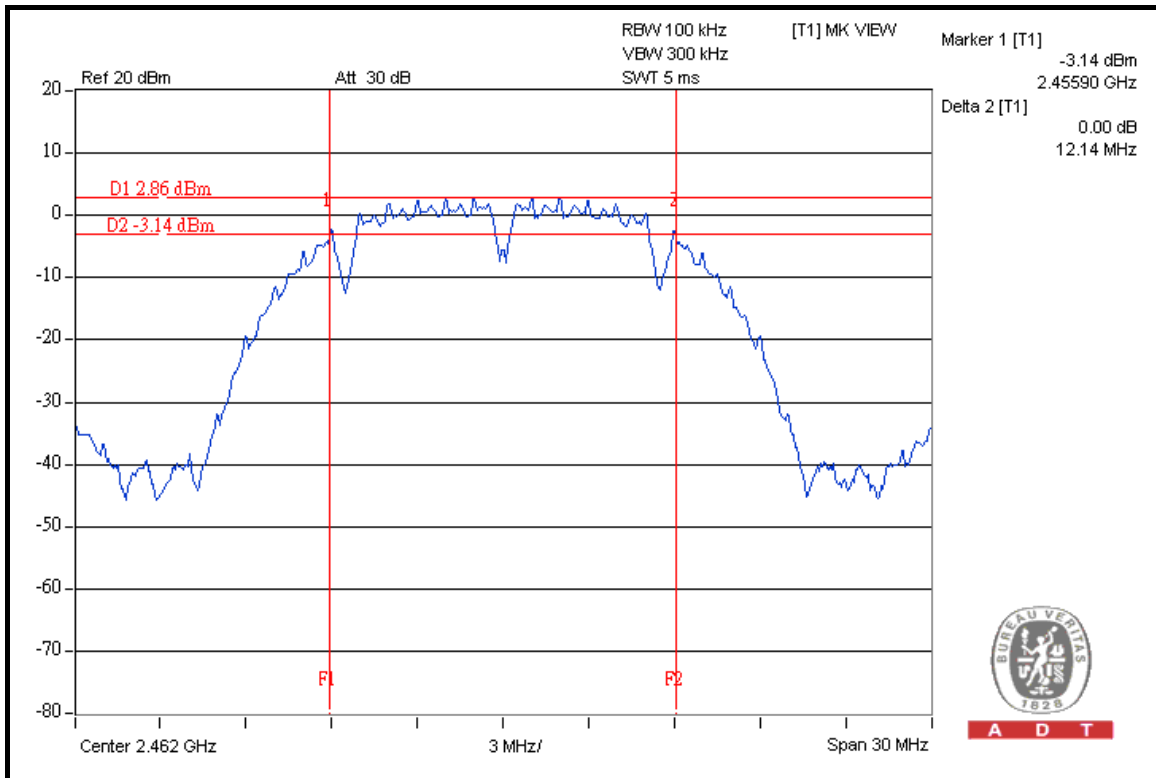



A D T

### 802.11g OFDM MODULATION

<b>MODULATION TYPE</b>	BPSK	<b>TRANSFER RATE</b>	6.0Mbps
<b>INPUT POWER</b>	120Vac, 60Hz	<b>ENVIRONMENTAL CONDITIONS</b>	23deg.C, 70%RH, 1009hPa
<b>TESTED BY</b>	Lori Chiu		

CHANNEL	CHANNEL FREQUENCY (MHz)	6dB BANDWIDTH (MHz)	MINIMUM LIMIT (MHz)	PASS / FAIL
1	2412	16.58	0.5	PASS
6	2437	16.49	0.5	PASS
11	2462	16.57	0.5	PASS

### CH 1

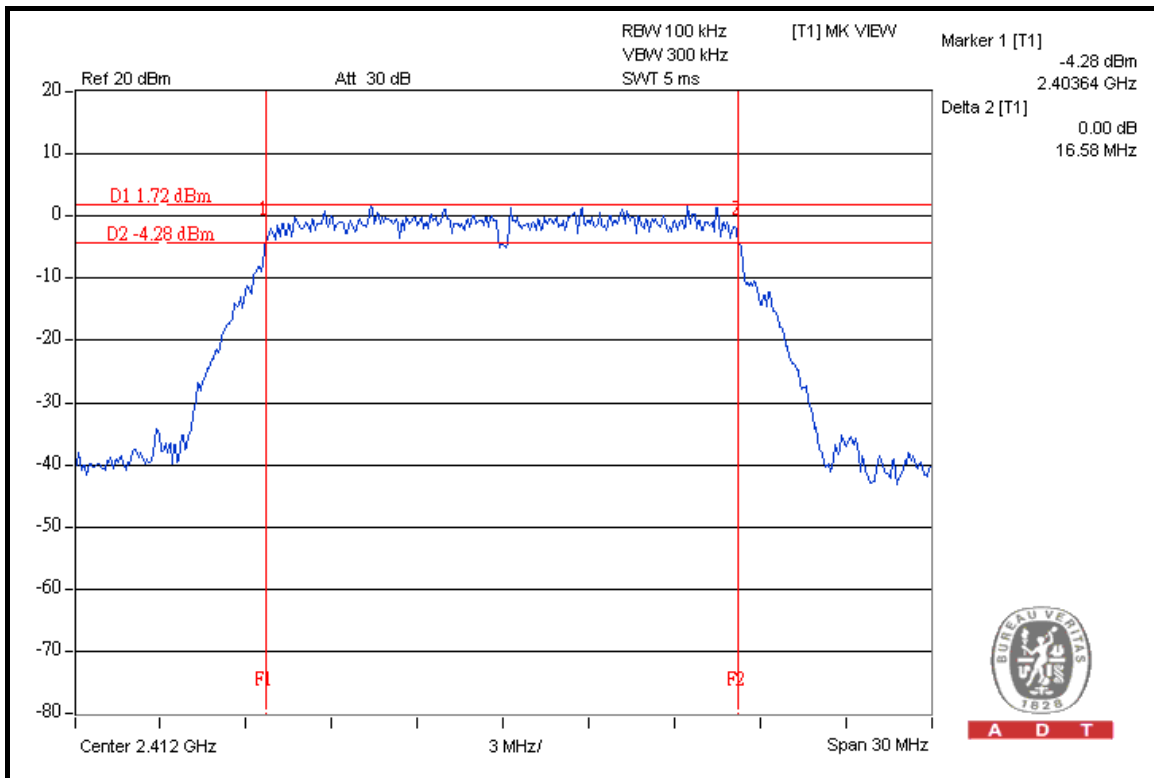



A D T

### CH 6

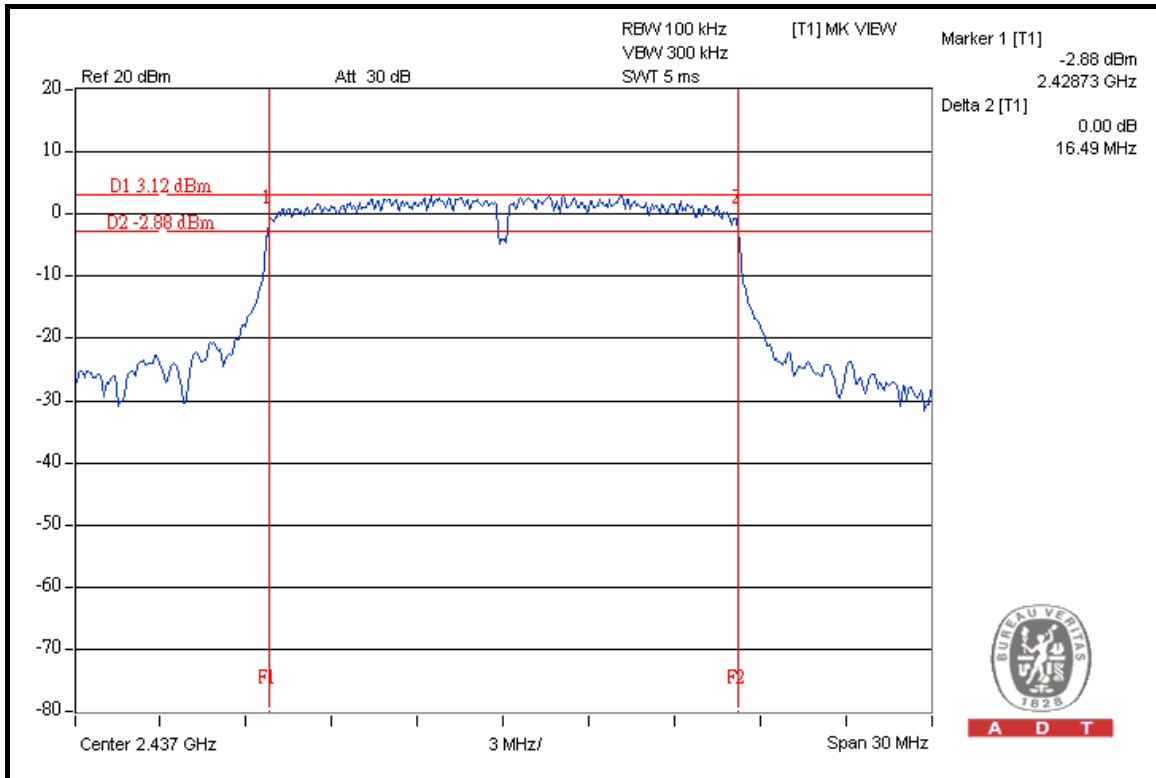

A D T

### CH 11

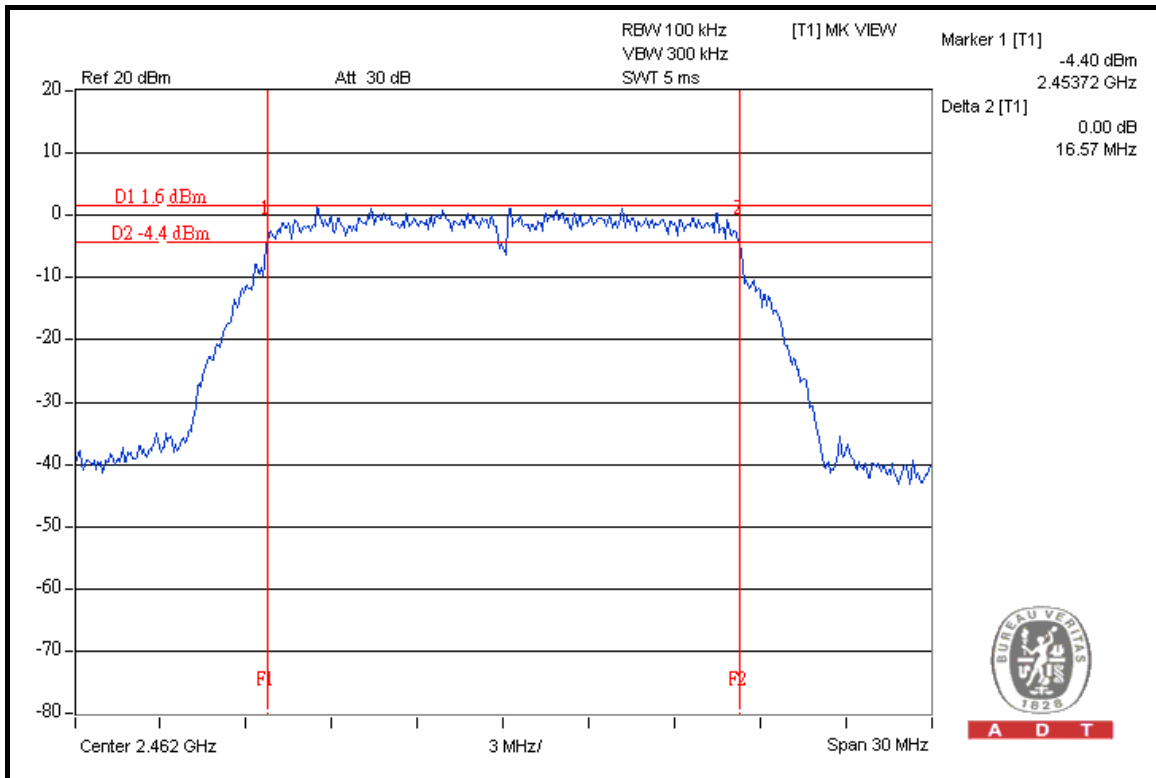

A D T





A D T

**DRAFT 802.11n (20MHz) OFDM MODULATION**

<b>MODULATION TYPE</b>	BPSK	<b>TRANSFER RATE</b>	7.2Mbps
<b>INPUT POWER</b>	120Vac, 60Hz	<b>ENVIRONMENTAL CONDITIONS</b>	23deg.C, 70%RH, 1009hPa
<b>TESTED BY</b>	Lori Chiu		

CHANNEL	CHANNEL FREQUENCY (MHz)	6dB BANDWIDTH (MHz)	MINIMUM LIMIT (MHz)	PASS / FAIL
1	2412	17.38	0.5	PASS
6	2437	17.21	0.5	PASS
11	2462	17.59	0.5	PASS

**CH 1**

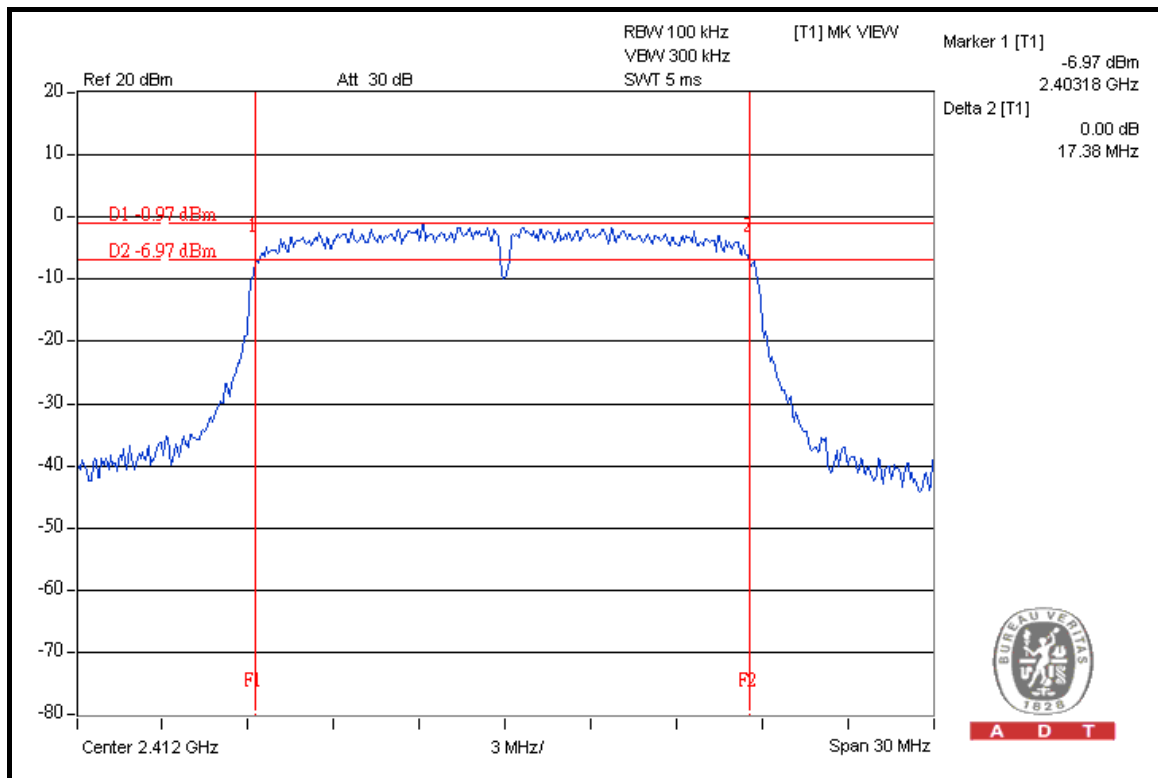

A D T



A D T

### CH 6

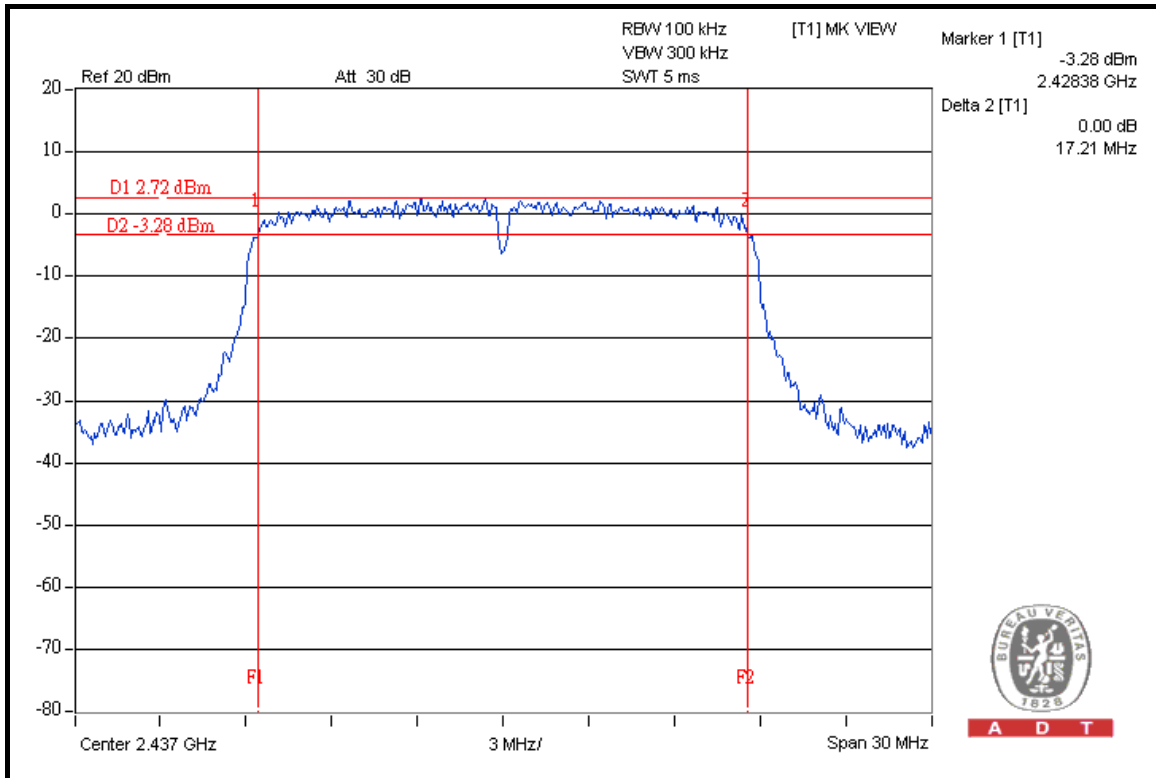

### CH 11

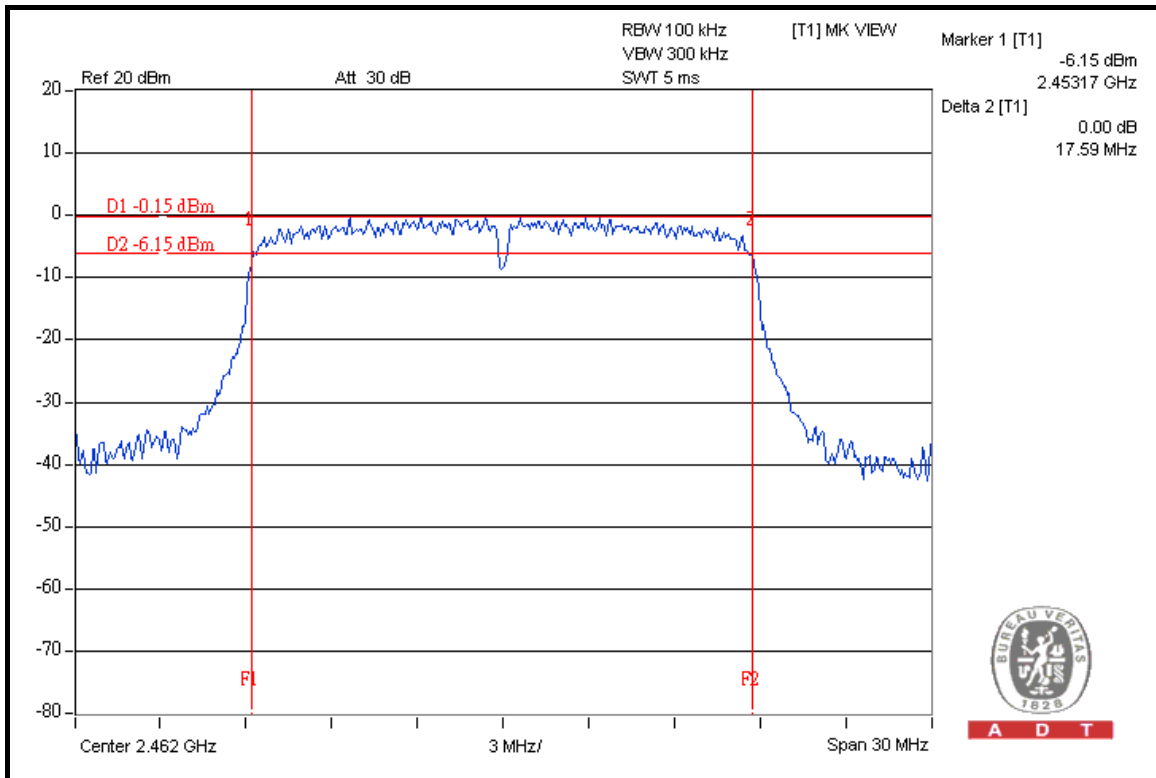



A D T

### DRAFT 802.11n (40MHz) OFDM MODULATION

<b>MODULATION TYPE</b>	BPSK	<b>TRANSFER RATE</b>	15.0Mbps
<b>INPUT POWER</b>	120Vac, 60Hz	<b>ENVIRONMENTAL CONDITIONS</b>	23deg.C, 70%RH, 1009hPa
<b>TESTED BY</b>	Lori Chiu		

CHANNEL	CHANNEL FREQUENCY (MHz)	6dB BANDWIDTH (MHz)	MINIMUM LIMIT (MHz)	PASS / FAIL
1	2422	36.18	0.5	PASS
4	2437	35.85	0.5	PASS
7	2452	35.90	0.5	PASS

### CH 1

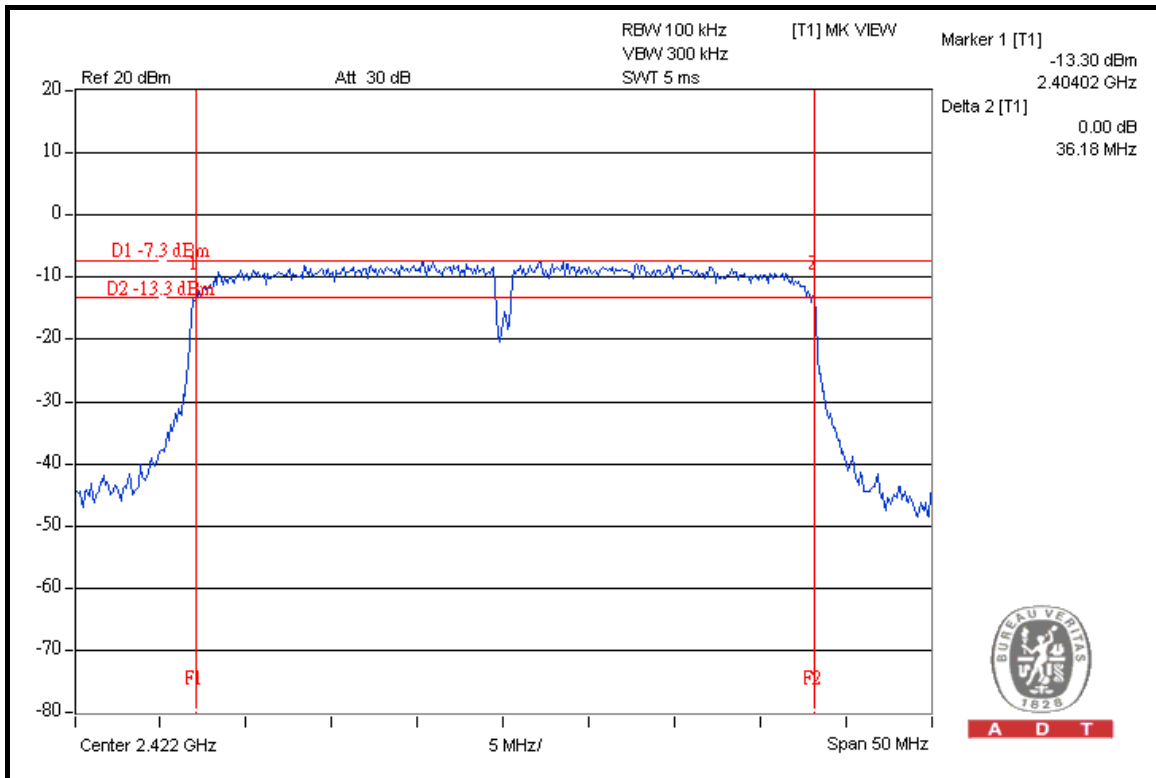

A D T



A D T

### CH 4

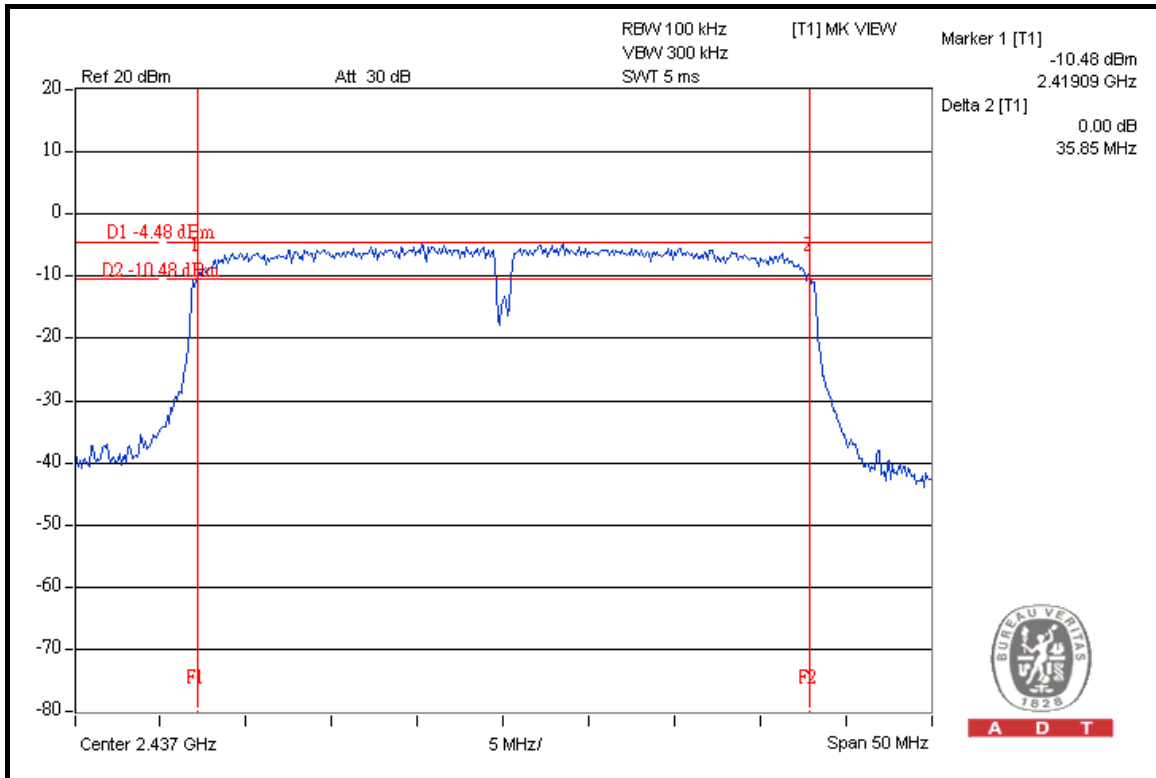

### CH 7

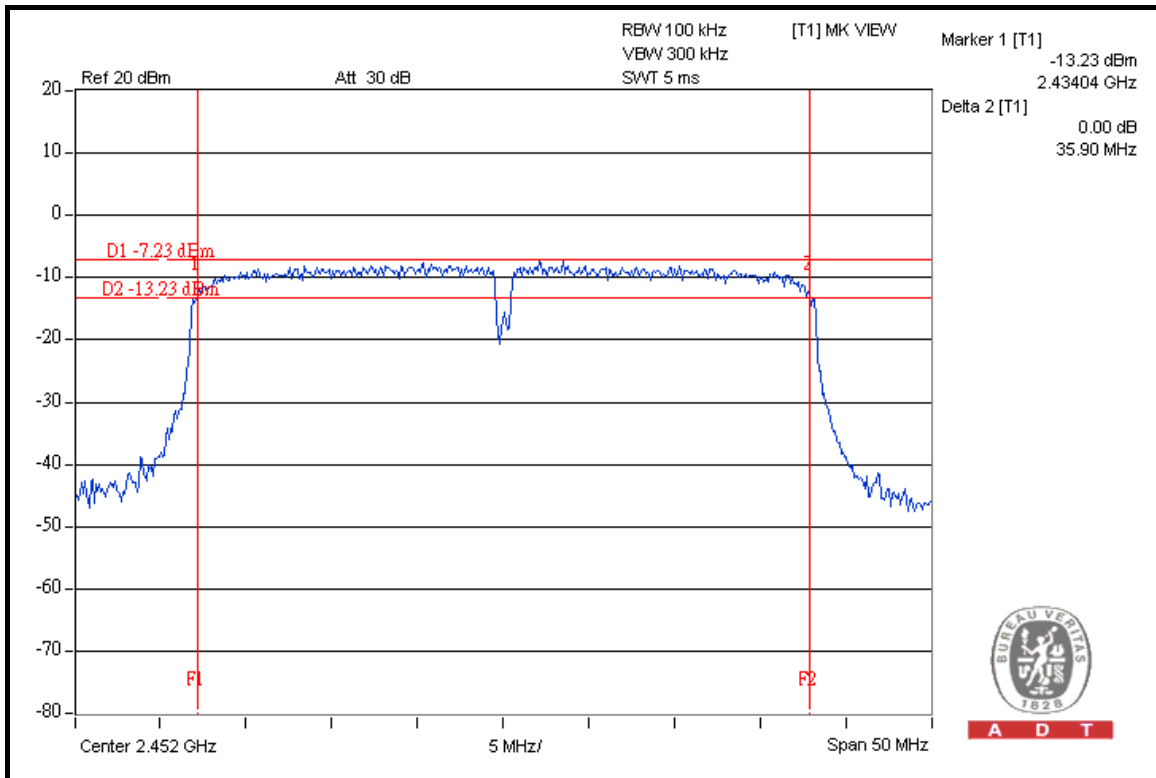



A D T

## 4.4 MAXIMUM PEAK OUTPUT POWER

### 4.4.1 LIMITS OF MAXIMUM PEAK OUTPUT POWER MEASUREMENT

The Maximum Peak Output Power Measurement is 30dBm.

### 4.4.2 INSTRUMENTS

DESCRIPTION & MANUFACTURER	MODEL NO.	SERIAL NO.	DATE OF CALIBRATION	DUE DATE OF CALIBRATION
High Speed Peak Power Meter	ML2495A	0824012	Aug. 04, 2008	Aug. 03, 2009
Power Sensor	MA2411B	0738138	Aug. 04, 2008	Aug. 03, 2009

**NOTE:**

1. The calibration interval of the above test instruments is 12 months and the calibrations are traceable to NML/ROC and NIST/USA.
2. Measurement Bandwidth of ML2495A is 65MHz greater than 6dB bandwidth of emission.

### 4.4.3 TEST PROCEDURES

A power sensor was used on the output port of the EUT. A power meter was used to read the response of the power sensor. Record the power level.

#### 4.4.4 DEVIATION FROM TEST STANDARD

No deviation.

#### 4.4.5 TEST SETUP

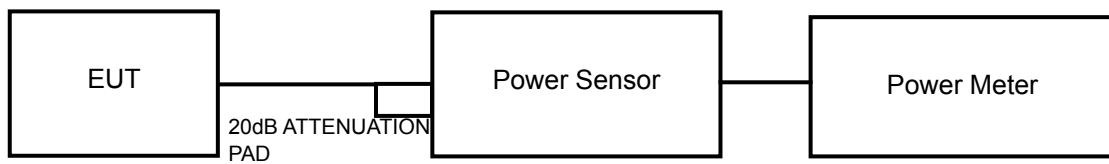

#### 4.4.6 EUT OPERATING CONDITIONS

Same as Item 4.3.6.



#### 4.4.7 TEST RESULTS

##### 802.11b DSSS MODULATION

<b>MODULATION TYPE</b>	DBPSK	<b>TRANSFER RATE</b>	1.0Mbps
<b>INPUT POWER</b>	120Vac, 60Hz	<b>ENVIRONMENTAL CONDITIONS</b>	23deg.C, 70%RH, 1009hPa
<b>TESTED BY</b>	Lori Chiu		

CHAN	CHANNEL FREQUENCY (MHz)	PEAK POWER OUTPUT (mW)	PEAK POWER OUTPUT (dBm)	PEAK POWER LIMIT (dBm)	PASS/FAIL
1	2412	53.951	17.32	30	PASS
6	2437	54.325	17.35	30	PASS
11	2462	55.719	17.46	30	PASS

##### 802.11g OFDM MODULATION

<b>MODULATION TYPE</b>	BPSK	<b>TRANSFER RATE</b>	6.0Mbps
<b>INPUT POWER</b>	120Vac, 60Hz	<b>ENVIRONMENTAL CONDITIONS</b>	23deg.C, 70%RH, 1009hPa
<b>TESTED BY</b>	Lori Chiu		

CHAN	CHANNEL FREQUENCY (MHz)	PEAK POWER OUTPUT (mW)	PEAK POWER OUTPUT (dBm)	PEAK POWER LIMIT (dBm)	PASS/FAIL
1	2412	165.196	22.18	30	PASS
6	2437	338.065	25.29	30	PASS
11	2462	167.109	22.23	30	PASS



A D T

#### DRAFT 802.11n (20MHz) OFDM MODULATION

<b>MODULATION TYPE</b>	BPSK	<b>TRANSFER RATE</b>	7.2Mbps
<b>INPUT POWER</b>	120Vac, 60Hz	<b>ENVIRONMENTAL CONDITIONS</b>	23deg.C, 70%RH, 1009hPa
<b>TESTED BY</b>	Lori Chiu		

CHAN	CHANNEL FREQUENCY (MHz)	PEAK POWER OUTPUT (mW)	PEAK POWER OUTPUT (dBm)	PEAK POWER LIMIT (dBm)	PASS/FAIL
1	2412	132.434	21.22	30	PASS
6	2437	327.341	25.15	30	PASS
11	2462	165.577	22.19	30	PASS

#### DRAFT 802.11n (40MHz) OFDM MODULATION

<b>MODULATION TYPE</b>	BPSK	<b>TRANSFER RATE</b>	15.0Mbps
<b>INPUT POWER</b>	120Vac, 60Hz	<b>ENVIRONMENTAL CONDITIONS</b>	23deg.C, 70%RH, 1009hPa
<b>TESTED BY</b>	Lori Chiu		

CHAN	CHANNEL FREQUENCY (MHz)	PEAK POWER OUTPUT (mW)	PEAK POWER OUTPUT (dBm)	PEAK POWER LIMIT (dBm)	PASS/FAIL
1	2422	64.863	18.12	30	PASS
4	2437	130.918	21.17	30	PASS
7	2452	66.527	18.23	30	PASS





A D T

## 4.5 POWER SPECTRAL DENSITY MEASUREMENT

### 4.5.1 LIMITS OF POWER SPECTRAL DENSITY MEASUREMENT

The Maximum of Power Spectral Density Measurement is 8dBm.

### 4.5.2 TEST INSTRUMENTS

DESCRIPTION & MANUFACTURER	MODEL NO.	SERIAL NO.	DATE OF CALIBRATION	DUE DATE OF CALIBRATION
R&S SPECTRUM ANALYZER	FSP40	100041	May 13, 2009	May 12, 2010

**NOTE:** The calibration interval of the above test instruments is 12 months and the calibrations are traceable to NML/ROC and NIST/USA.

### 4.5.3 TEST PROCEDURE

The transmitter output was connected to the spectrum analyzer through an attenuator, the bandwidth of the fundamental frequency was measured with the spectrum analyzer using 3kHz RBW and 30kHz VBW, set sweep time = span/3kHz. The power spectral density was measured and recorded.

The sweep time is allowed to be longer than span/3kHz for a full response of the mixer in the spectrum analyzer.

#### 4.5.4 DEVIATION FROM TEST STANDARD

No deviation.

#### 4.5.5 TEST SETUP

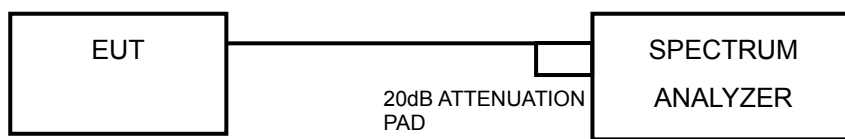

#### 4.5.6 EUT OPERATING CONDITION

Same as Item 4.3.6.



A D T

### 4.5.7 TEST RESULTS

#### 802.11b DSSS MODULATION

<b>MODULATION TYPE</b>	DBPSK	<b>TRANSFER RATE</b>	1.0Mbps
<b>INPUT POWER</b>	120Vac, 60Hz	<b>ENVIRONMENTAL CONDITIONS</b>	23deg.C, 70%RH, 1009hPa
<b>TESTED BY</b>	Lori Chiu		

CHANNEL	CHANNEL FREQUENCY (MHz)	RF POWER LEVEL IN 3 kHz BW (dBm)	MAXIMUM LIMIT (dBm)	PASS/FAIL
1	2412	-15.30	8	PASS
6	2437	-15.36	8	PASS
11	2462	-15.23	8	PASS

#### CH 1

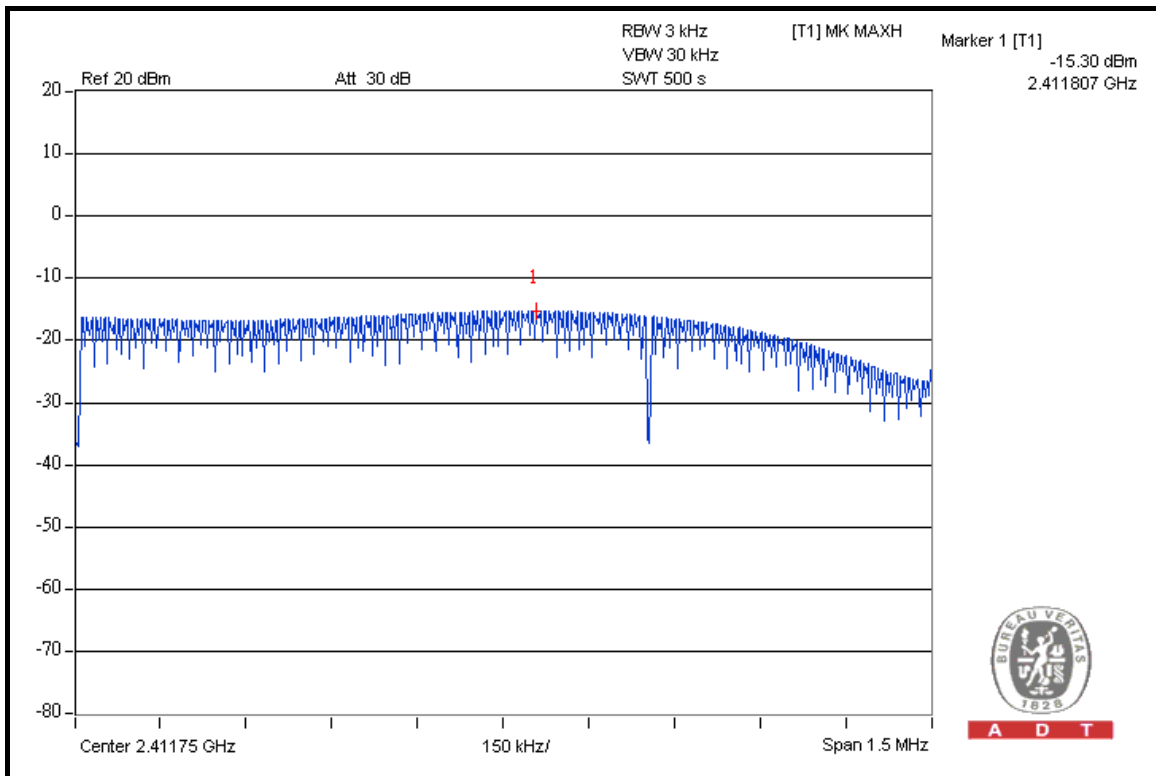

A D T



A D T

### CH 6

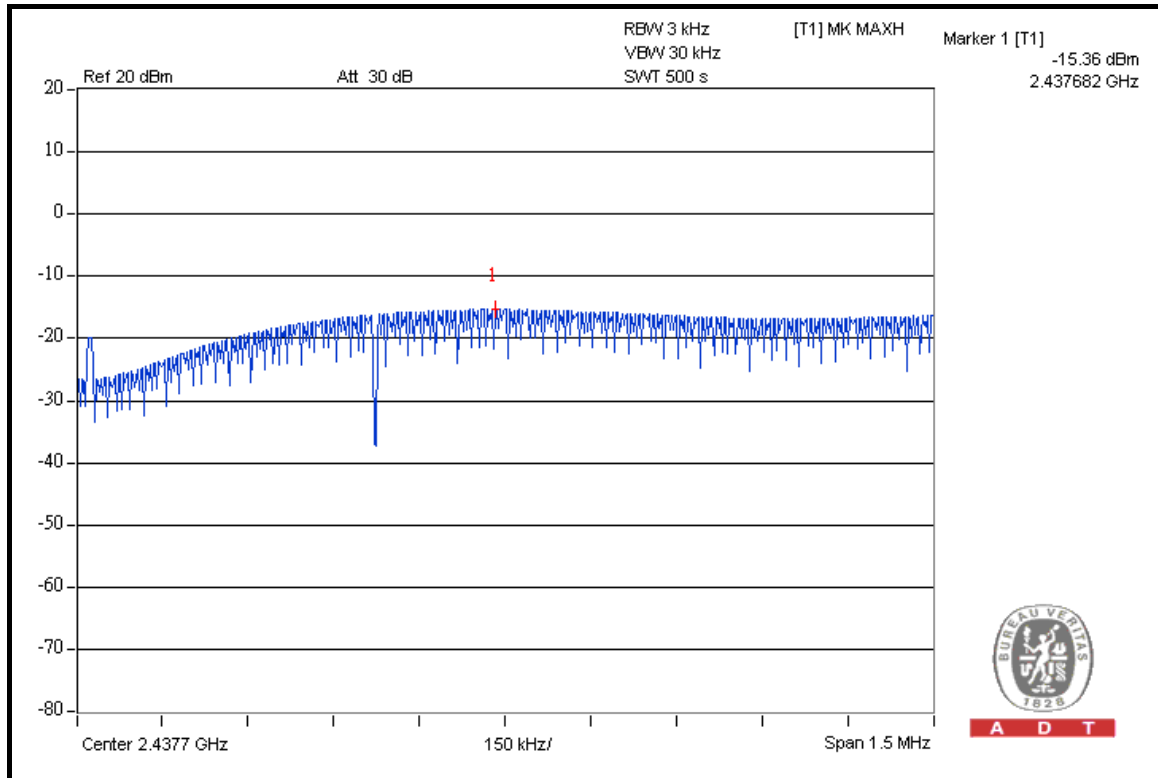

### CH 11

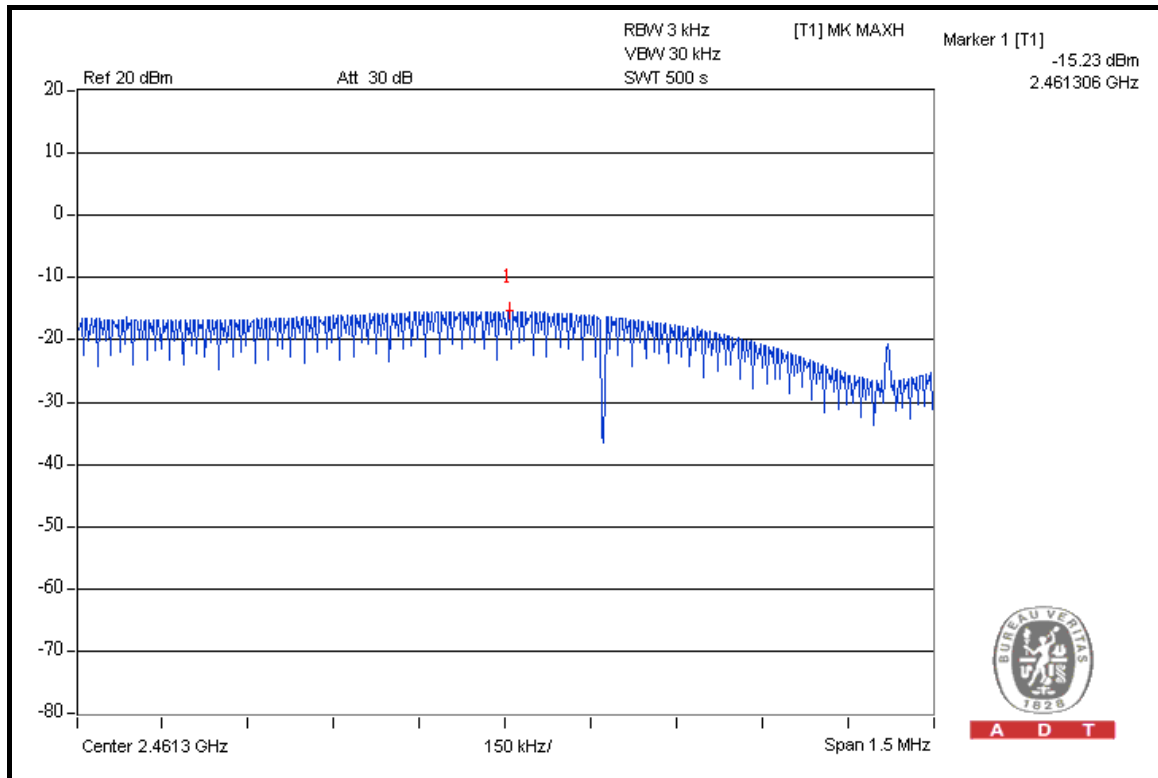



A D T

### 802.11g OFDM MODULATION

<b>MODULATION TYPE</b>	BPSK	<b>TRANSFER RATE</b>	6.0Mbps
<b>INPUT POWER</b>	120Vac, 60Hz	<b>ENVIRONMENTAL CONDITIONS</b>	23deg.C, 70%RH, 1009hPa
<b>TESTED BY</b>	Lori Chiu		

CHANNEL	CHANNEL FREQUENCY (MHz)	RF POWER LEVEL IN 3 kHz BW (dBm)	MAXIMUM LIMIT (dBm)	PASS/FAIL
1	2412	-13.64	8	PASS
6	2437	-11.03	8	PASS
11	2462	-13.89	8	PASS

### CH 1

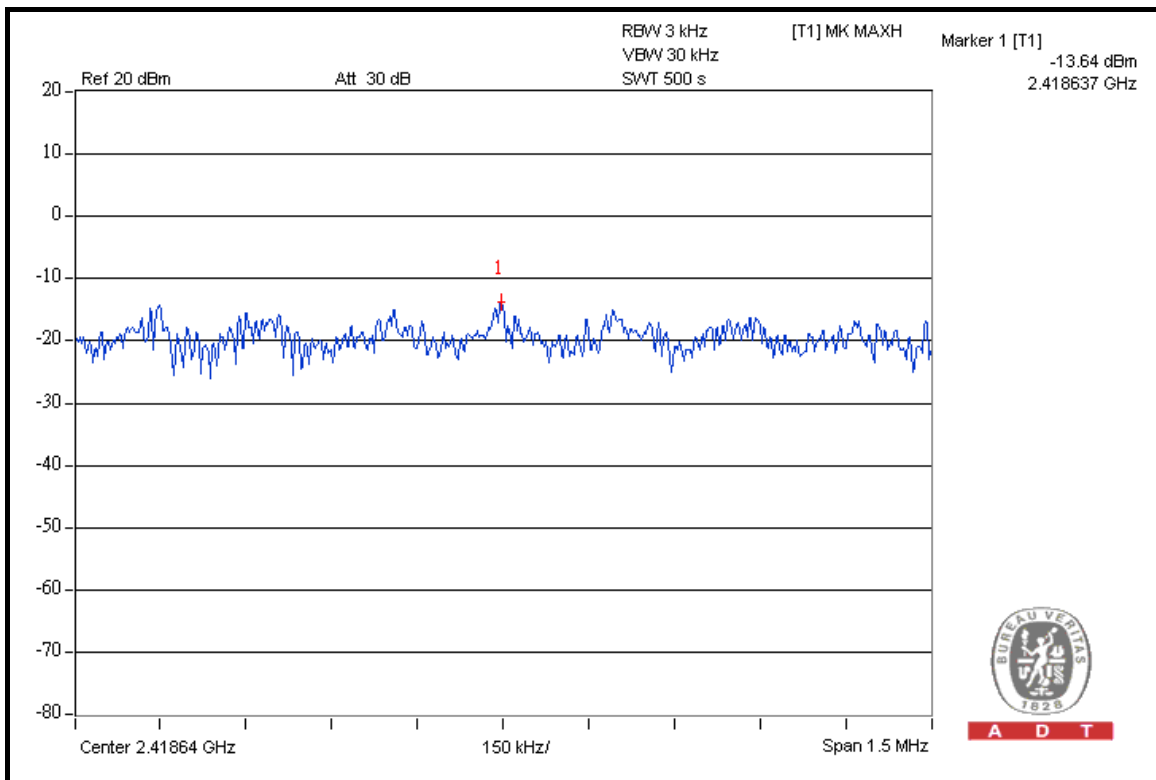

A D T



A D T

### CH 6

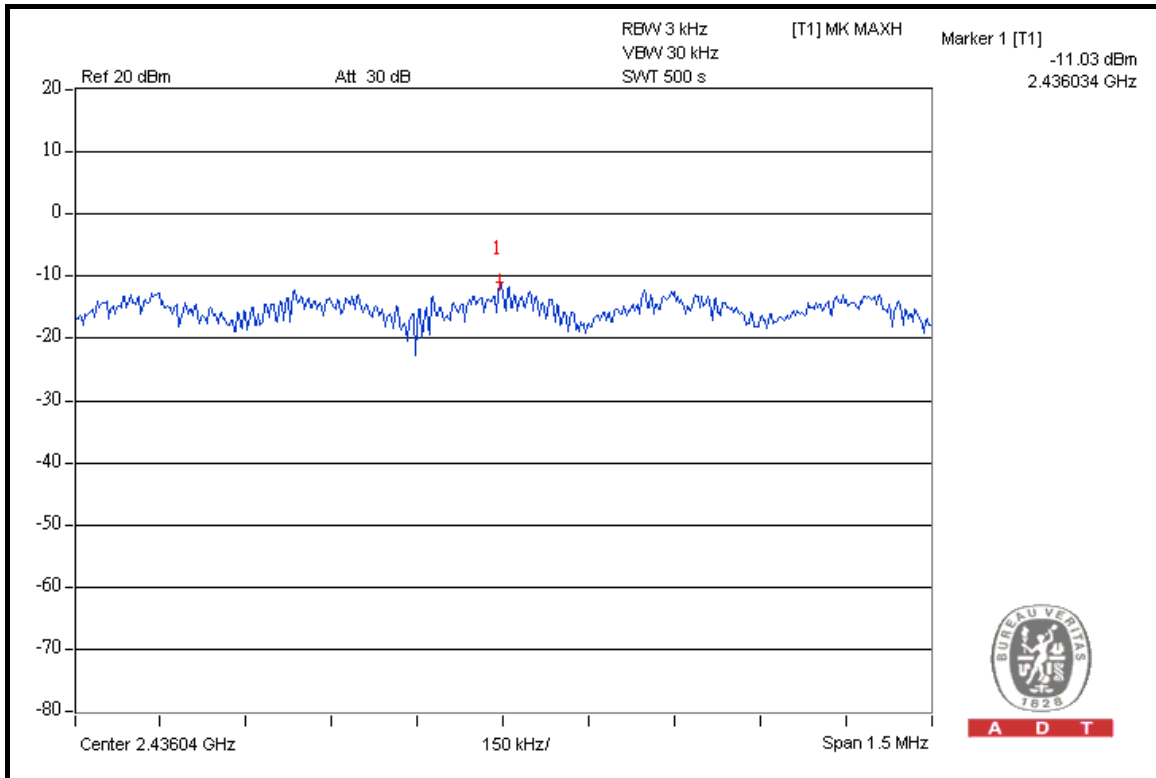

A D T

### CH 11

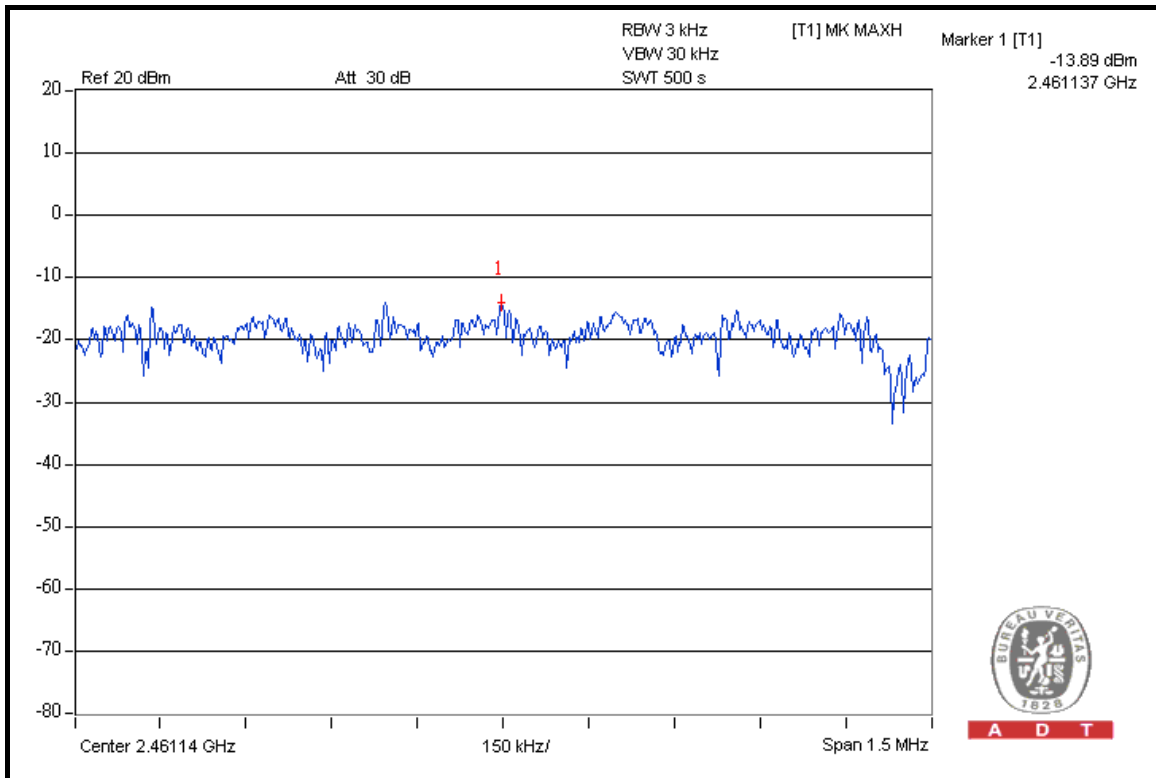

A D T



A D T

### DRAFT 802.11n (20MHz) OFDM MODULATION

<b>MODULATION TYPE</b>	BPSK	<b>TRANSFER RATE</b>	7.2Mbps
<b>INPUT POWER</b>	120Vac, 60Hz	<b>ENVIRONMENTAL CONDITIONS</b>	23deg.C, 70%RH, 1009hPa
<b>TESTED BY</b>	Lori Chiu		

CHANNEL	CHANNEL FREQUENCY (MHz)	RF POWER LEVEL IN 3 kHz BW (dBm)	MAXIMUM LIMIT (dBm)	PASS/FAIL
1	2412	-14.40	8	PASS
6	2437	-10.36	8	PASS
11	2462	-13.24	8	PASS

### CH 1

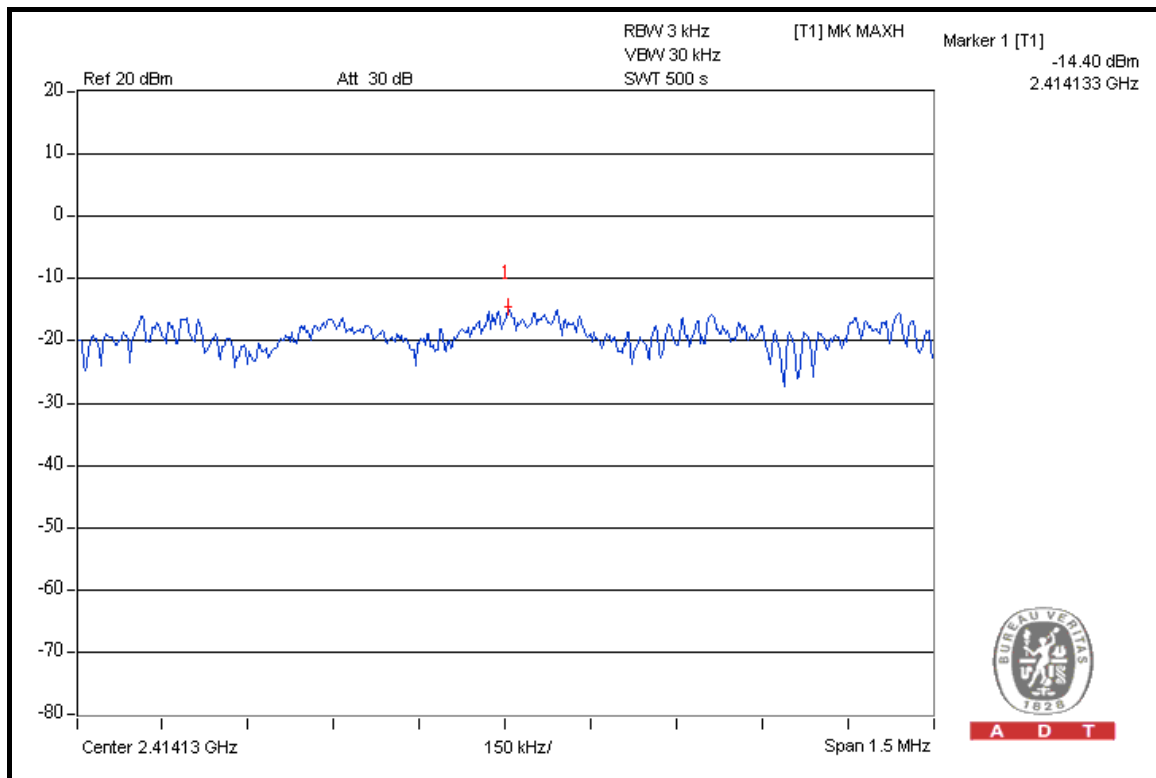

A D T







A D T

### DRAFT 802.11n (40MHz) OFDM MODULATION

<b>MODULATION TYPE</b>	BPSK	<b>TRANSFER RATE</b>	15.0Mbps
<b>INPUT POWER</b>	120Vac, 60Hz	<b>ENVIRONMENTAL CONDITIONS</b>	23deg.C, 70%RH, 1009hPa
<b>TESTED BY</b>	Lori Chiu		

CHANNEL	CHANNEL FREQUENCY (MHz)	RF POWER LEVEL IN 3 kHz BW (dBm)	MAXIMUM LIMIT (dBm)	PASS/FAIL
1	2422	-19.34	8	PASS
4	2437	-16.31	8	PASS
7	2452	-19.05	8	PASS

### CH 1

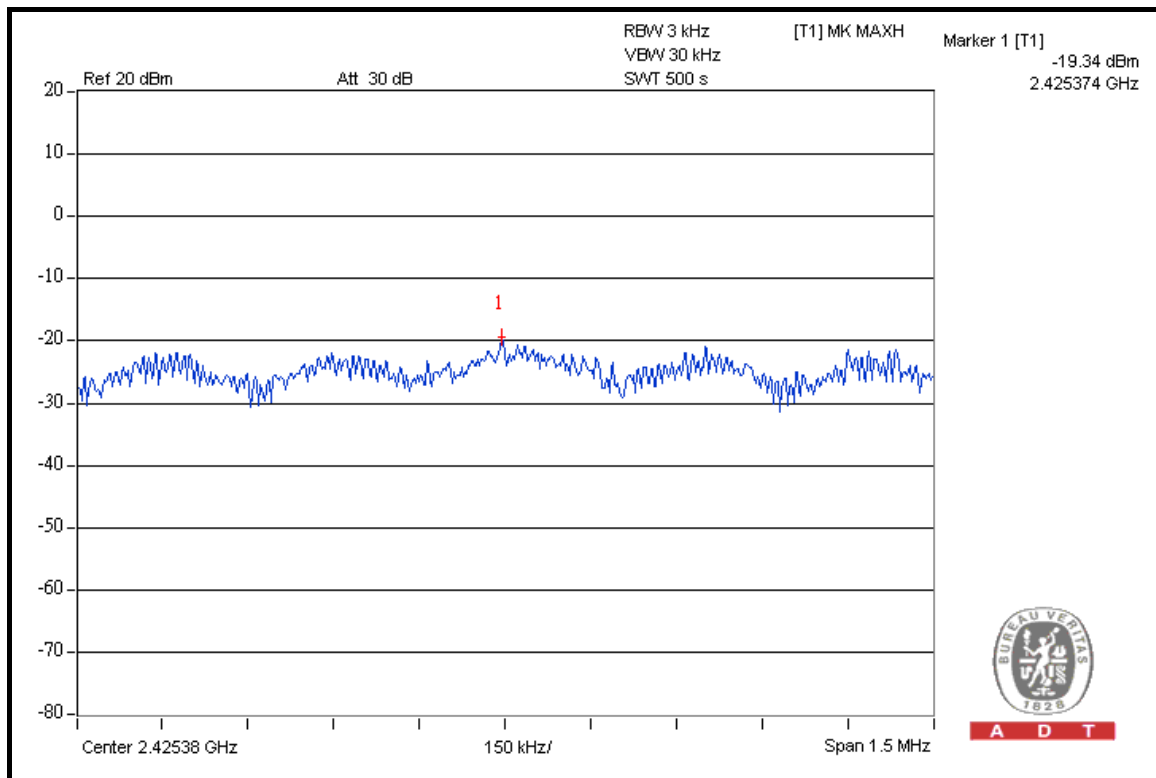

A D T





A D T

## 4.6 BAND EDGES MEASUREMENT

### 4.6.1 LIMITS OF BAND EDGES MEASUREMENT

Below  $-20\text{dB}$  of the highest emission level of operating band (in 100kHz Resolution Bandwidth).

### 4.6.2 TEST INSTRUMENTS

DESCRIPTION & MANUFACTURER	MODEL NO.	SERIAL NO.	DATE OF CALIBRATION	DUE DATE OF CALIBRATION
R&S SPECTRUM ANALYZER	FSP40	100041	May 13, 2009	May 12, 2010

**NOTE:** The calibration interval of the above test instruments is 12 months and the calibrations are traceable to NML/ROC and NIST/USA.

### 4.6.3 TEST PROCEDURE

The transmitter output was connected to the spectrum analyzer via a low loss cable. Set both RBW and VBW of spectrum analyzer to 100kHz and 300kHz with suitable frequency span including 100MHz bandwidth from band edge. The band edges was measured and recorded.

The spectrum plots (Peak RBW = 100kHz, VBW = 300kHz; Average RBW = 1MHz, VBW = 10Hz) are attached on the following pages.

### 4.6.4 DEVIATION FROM TEST STANDARD

No deviation.

### 4.6.5 EUT OPERATING CONDITION

Same as Item 4.3.6.

#### 4.6.6 TEST RESULTS

The spectrum plots are attached on the following pages. D1 line indicates the highest level, and D2 line indicates the 20dB offset below D1. It shows compliance with the requirement in part 15.247(d).

#### 802.11b DSSS MODULATION

**NOTE 1:** The band edge emission plot on the next page shows 50.58dBuV between carrier maximum power and local maximum emission in restrict band (2.38700GHz). The emission of carrier strength list in the test result of channel 1 at the item 4.1.7 is 108.69dBuV/m (Peak), so the maximum field strength in restrict band is  $108.69 - 50.58 = 58.11$ dBuV/m which is under 74dBuV/m limit.

The band edge emission plot of on the next page shows 57.53dBuV between carrier maximum power and local maximum emission in restrict band (2.38720GHz). The emission of carrier strength list in the test result of channel 1 at the item 4.1.7 is 105.08dBuV/m (Average), so the maximum field strength in restrict band is  $105.08 - 57.53 = 47.55$ dBuV/m which is under 54dBuV/m limit.

**NOTE 2:** The band edge emission plot on the next second page shows 50.28dBuV between carrier maximum power and local maximum emission in restrict band (2.48820GHz). The emission of carrier strength list in the test result of channel 11 at the item 4.1.7 is 108.76dBuV/m (Peak), so the maximum field strength in restrict band is  $108.76 - 50.28 = 58.48$ dBuV/m which is under 74dBuV/m limit.

The band edge emission plot on the next third page shows 56.47dBuV between carrier maximum power and local maximum emission in restrict band (2.48760GHz). The emission of carrier strength list in the test result of channel 11 at the item 4.1.7 is 105.49dBuV/m (Average), so the maximum field strength in restrict band is  $105.49 - 56.47 = 49.02$ dBuV/m which is under 54dBuV/m limit.



A D T

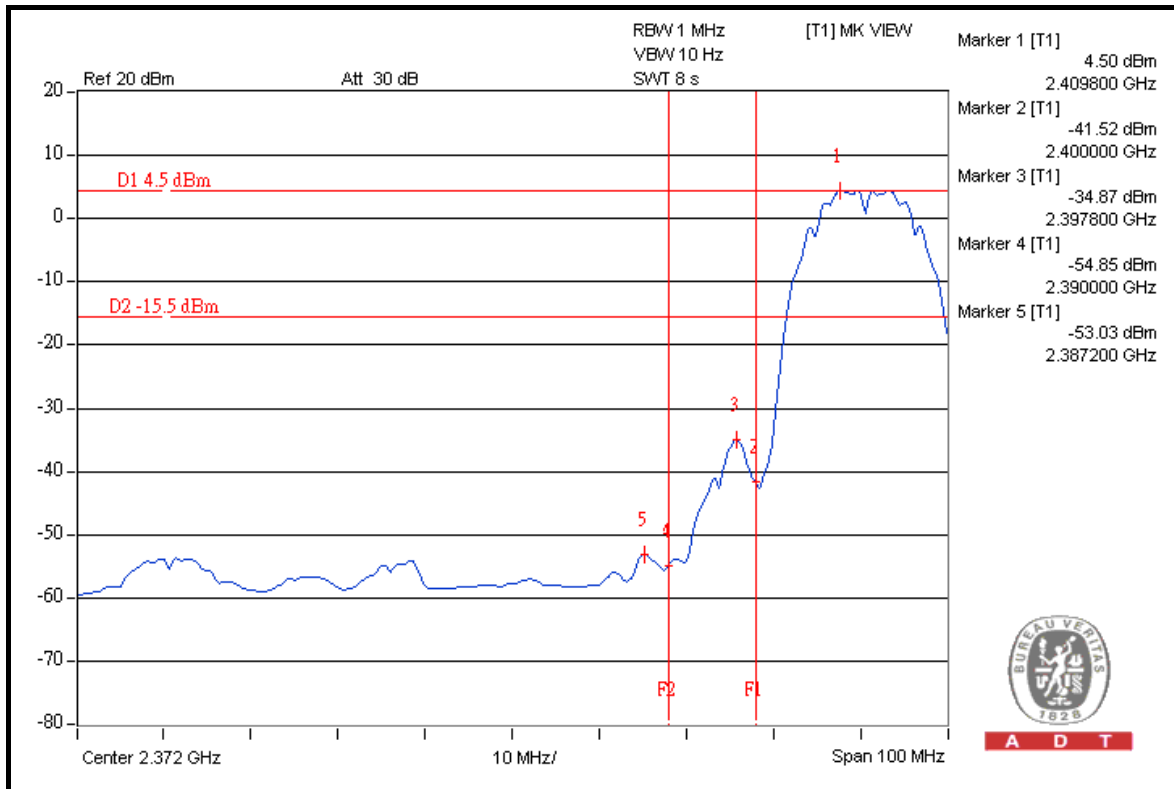
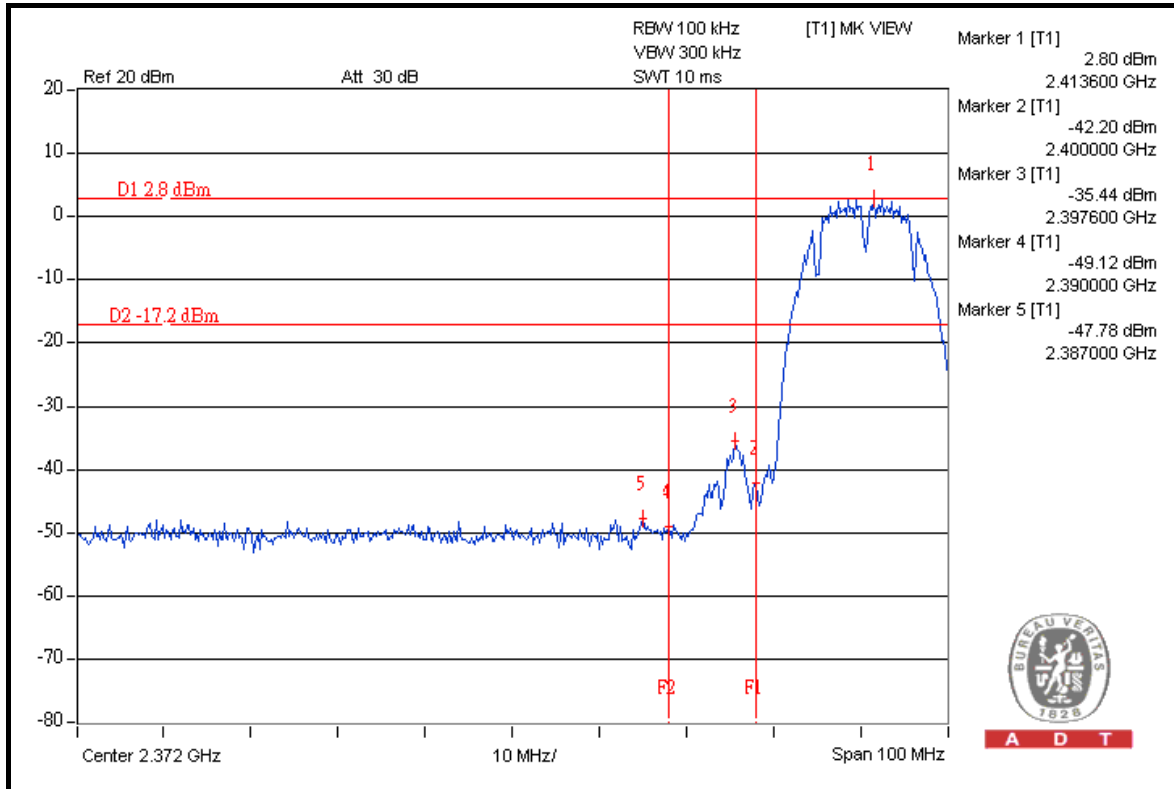



A D T

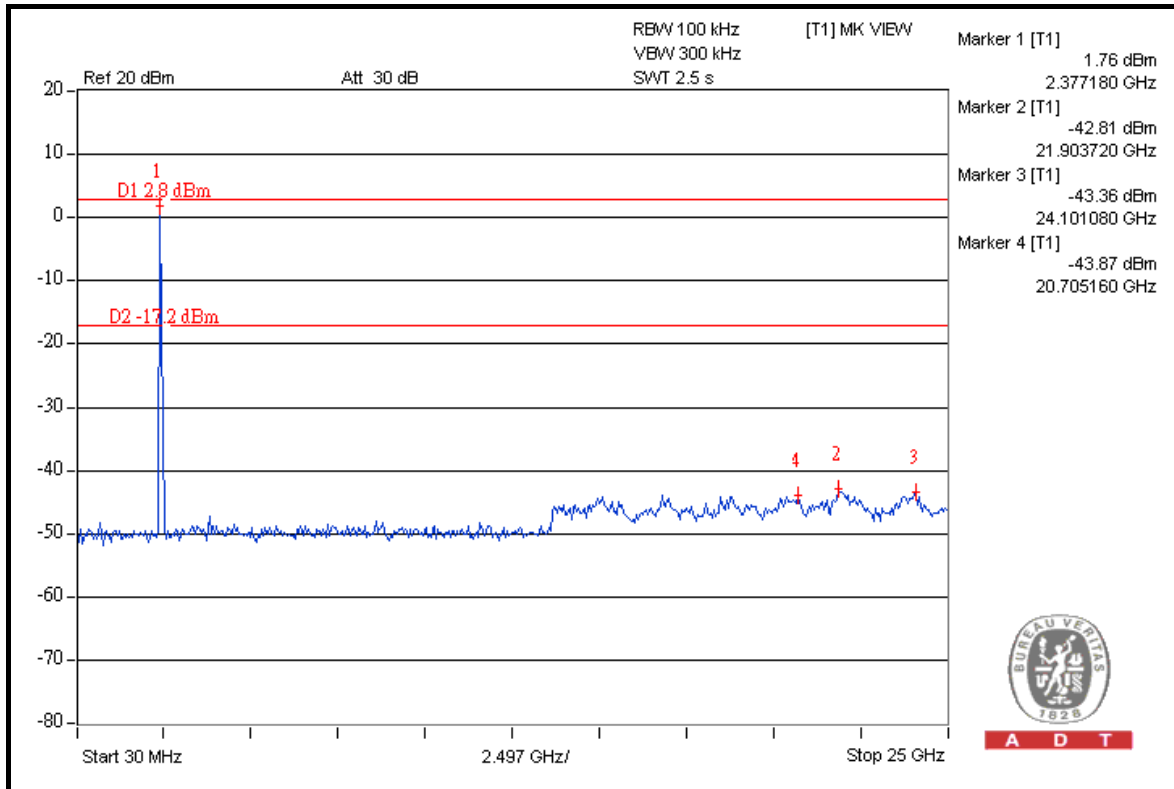

A D T

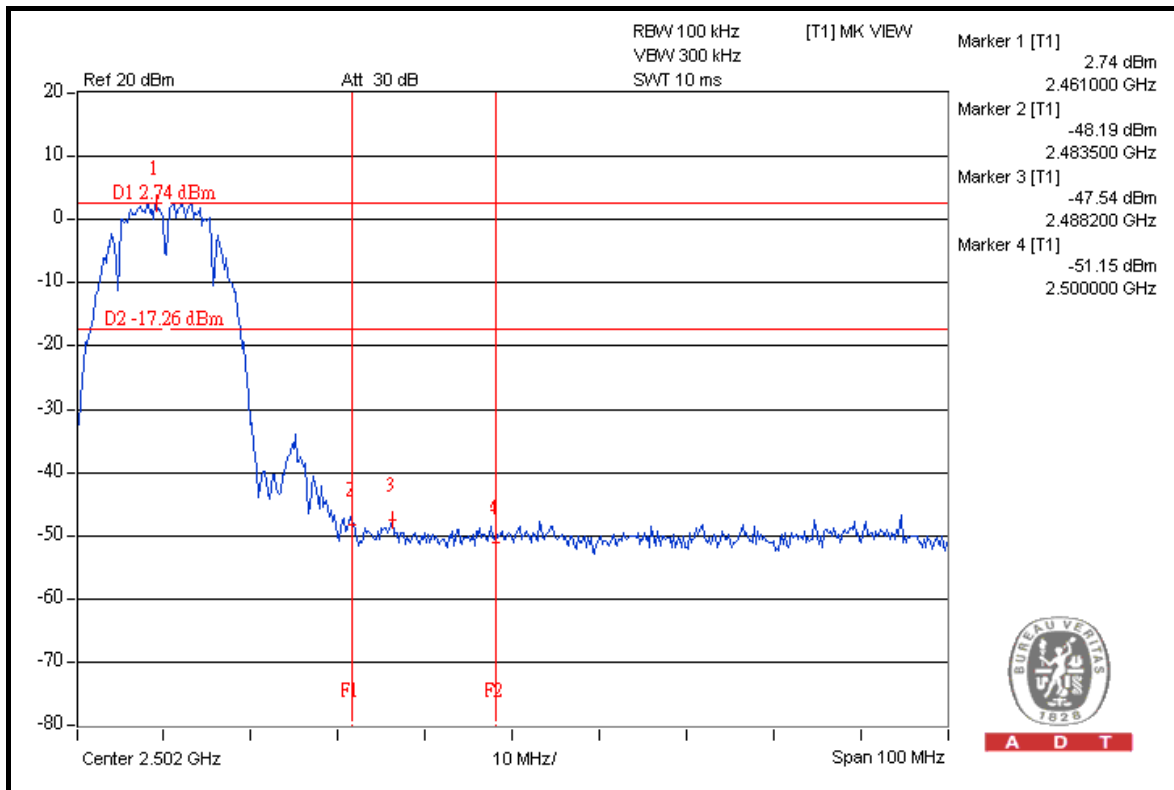

A D T



A D T

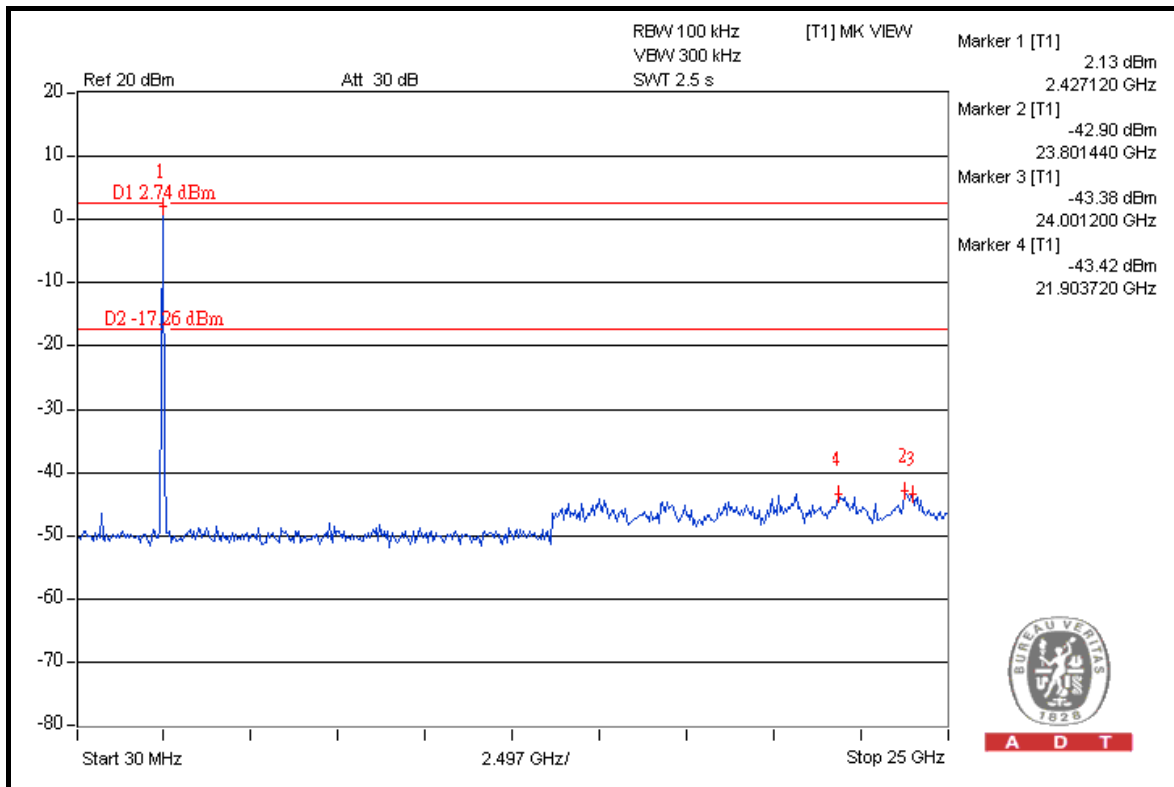
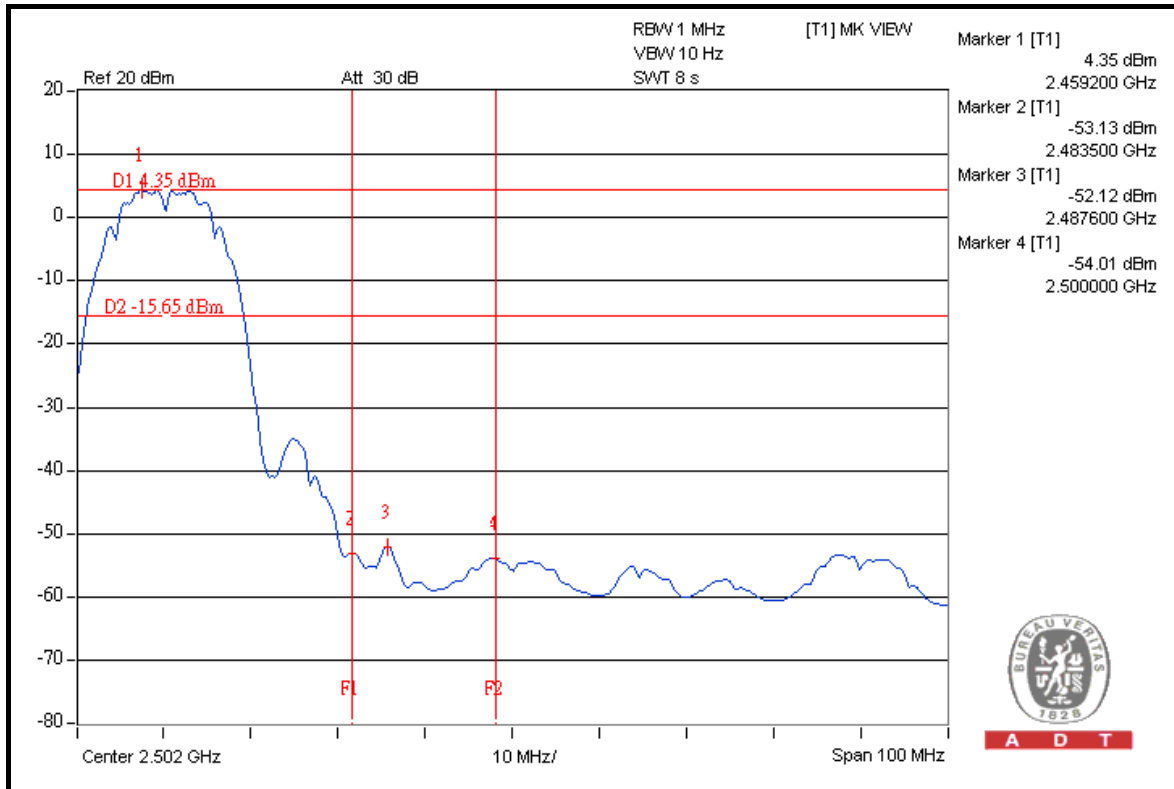



## 802.11g OFDM MODULATION

**NOTE 1:** The band edge emission plot on the next page shows 45.91dBuV between carrier maximum power and local maximum emission in restrict band (2.38960GHz). The emission of carrier strength list in the test result of channel 1 at the item 4.1.7 is 111.37dBuV/m (Peak), so the maximum field strength in restrict band is  $111.37 - 45.91 = 65.46$ dBuV/m which is under 74dBuV/m limit.

The band edge emission plot of on the next page shows 50.76dBuV between carrier maximum power and local maximum emission in restrict band (2.39000GHz). The emission of carrier strength list in the test result of channel 1 at the item 4.1.7 is 100.54dBuV/m (Average), so the maximum field strength in restrict band is  $100.54 - 50.76 = 49.78$ dBuV/m which is under 54dBuV/m limit.

**NOTE 2:** The band edge emission plot on the next second page shows 47.88dBuV between carrier maximum power and local maximum emission in restrict band (2.48440GHz). The emission of carrier strength list in the test result of channel 11 at the item 4.1.7 is 110.60dBuV/m (Peak), so the maximum field strength in restrict band is  $110.60 - 47.88 = 62.72$ dBuV/m which is under 74dBuV/m limit.

The band edge emission plot on the next third page shows 51.34dBuV between carrier maximum power and local maximum emission in restrict band (2.48350GHz). The emission of carrier strength list in the test result of channel 11 at the item 4.1.7 is 100.53dBuV/m (Average), so the maximum field strength in restrict band is  $100.53 - 51.34 = 49.19$ dBuV/m which is under 54dBuV/m limit.





A D T

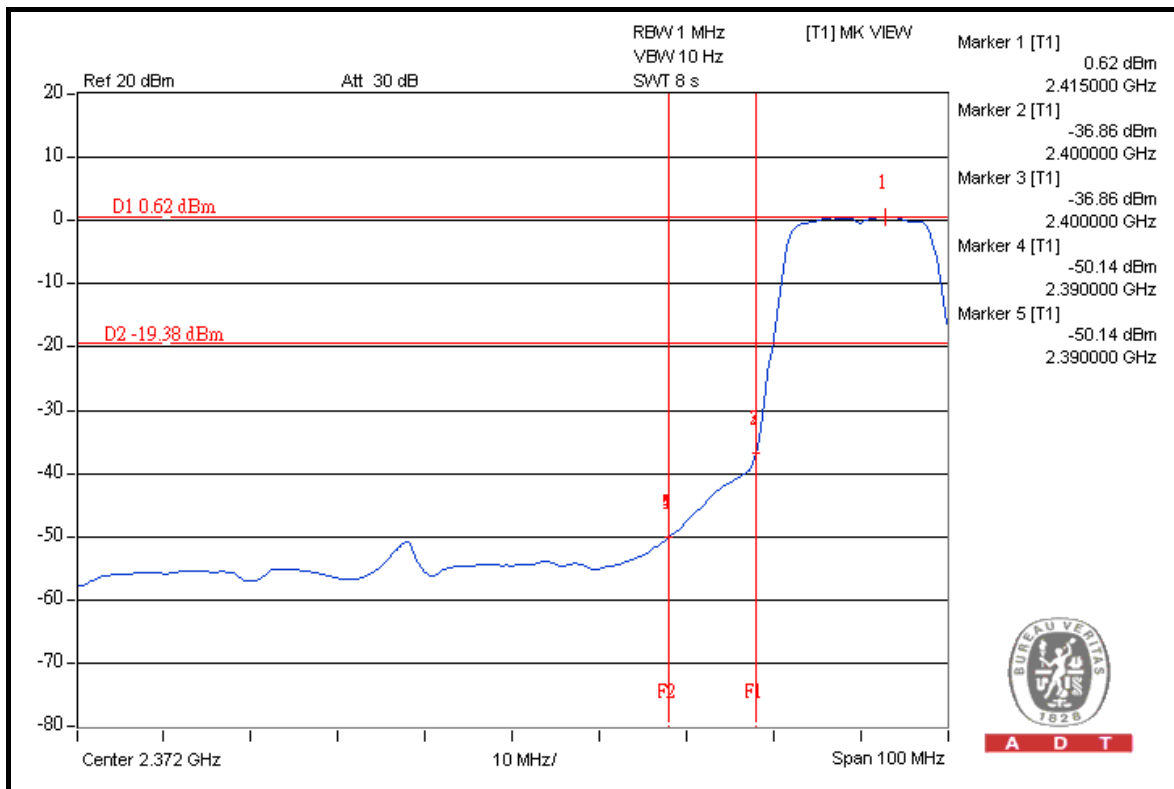
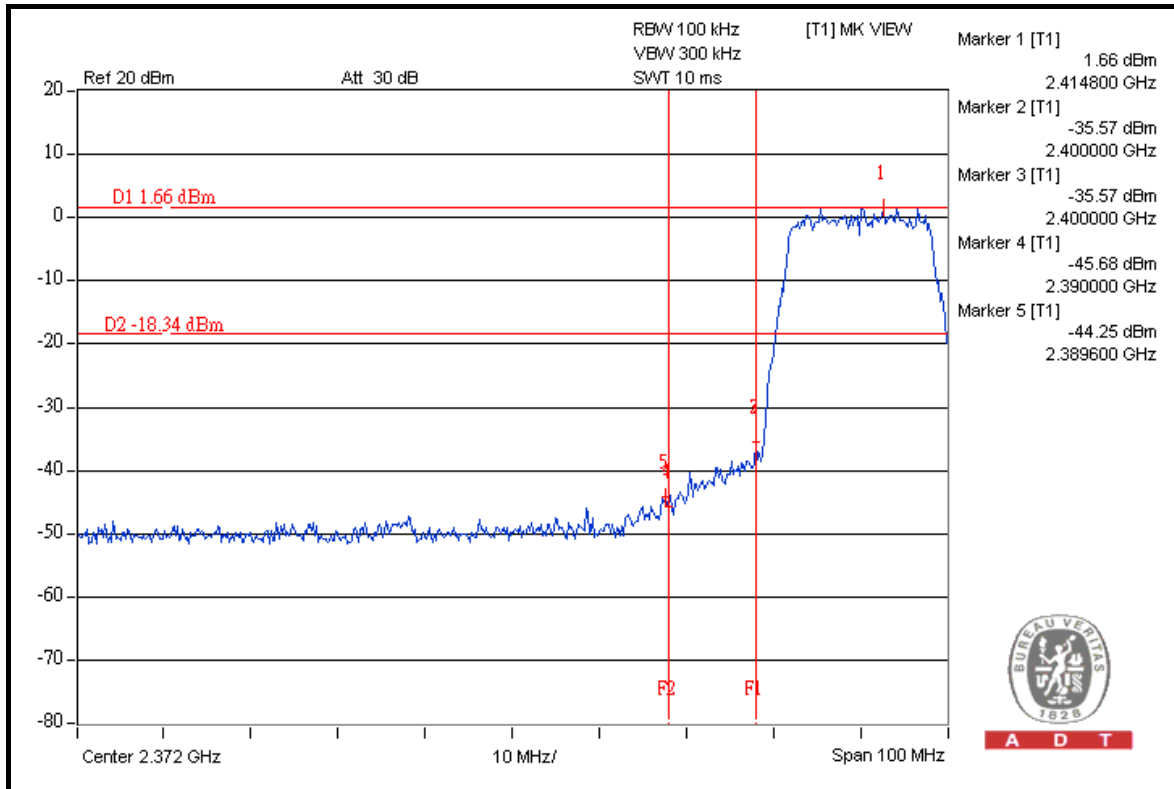



A D T

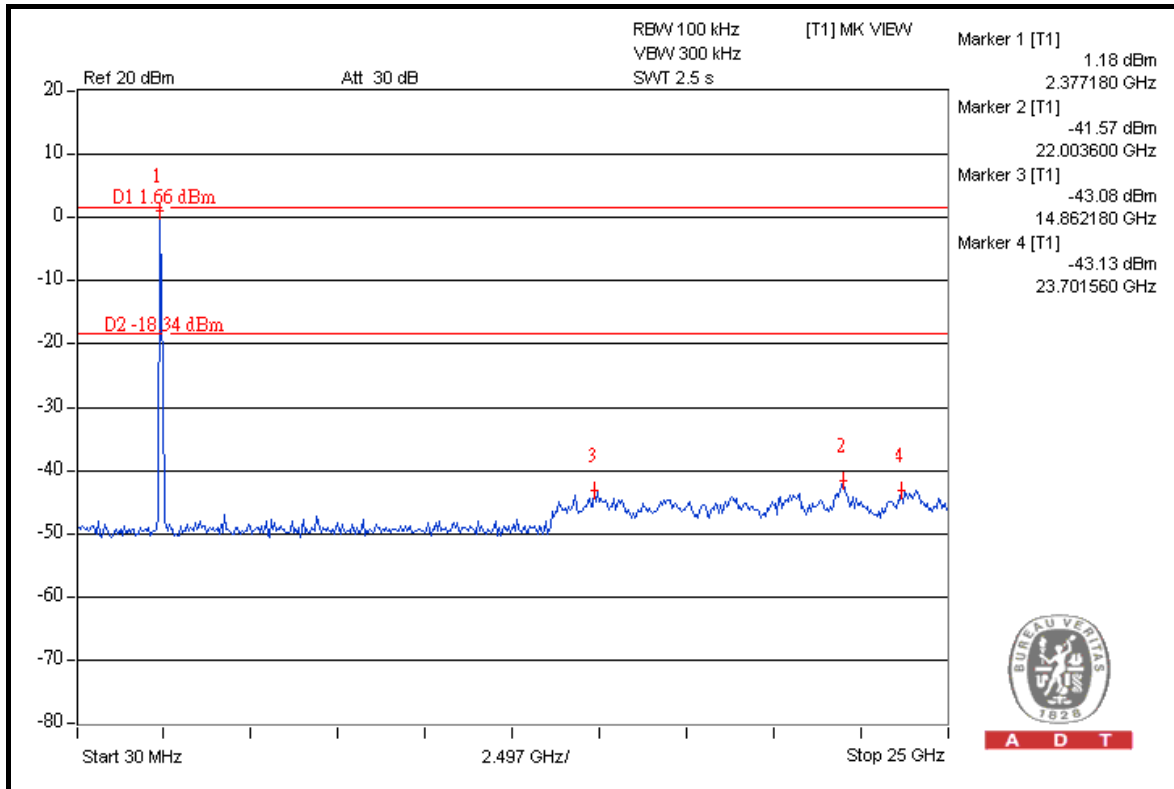

A D T

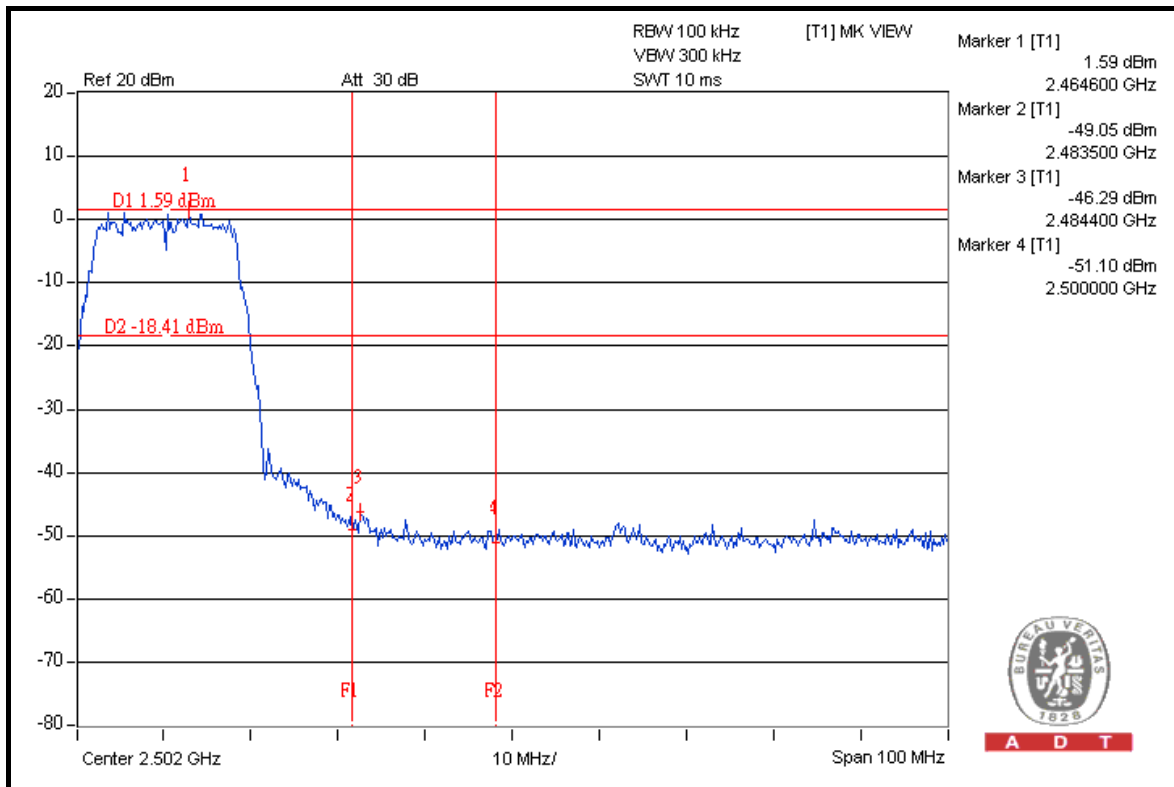

A D T



A D T

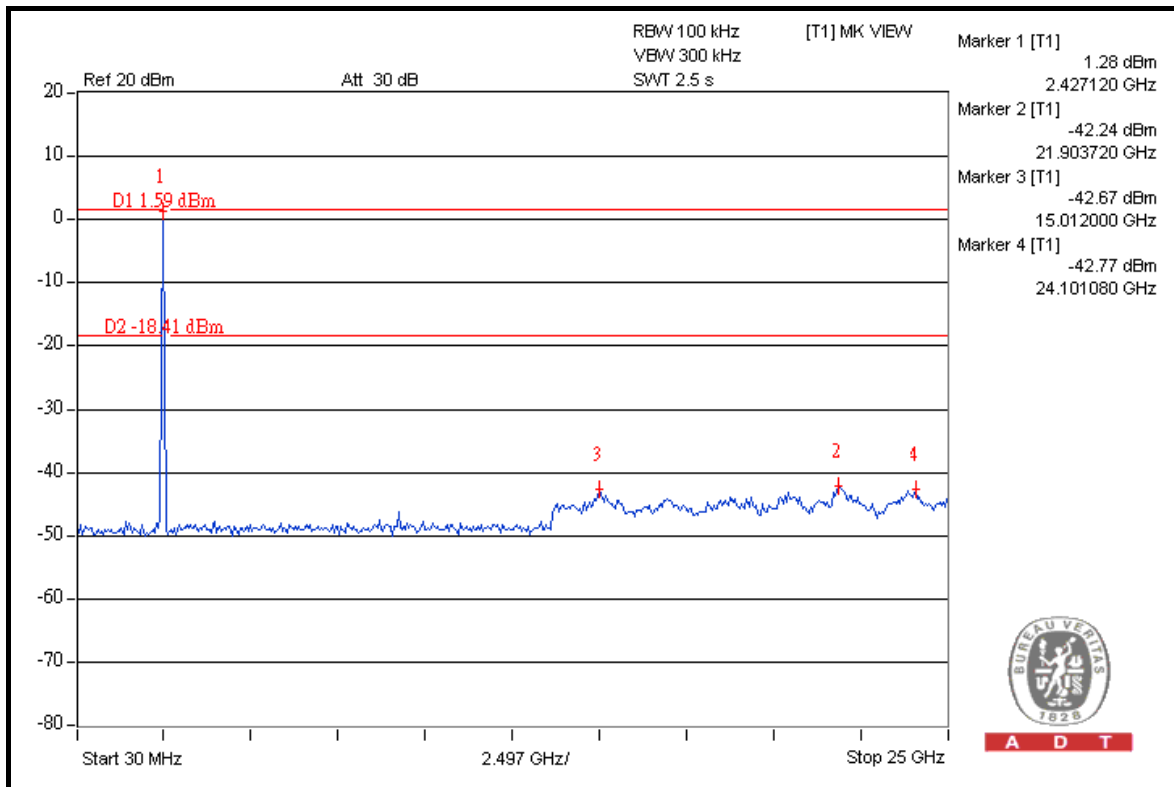
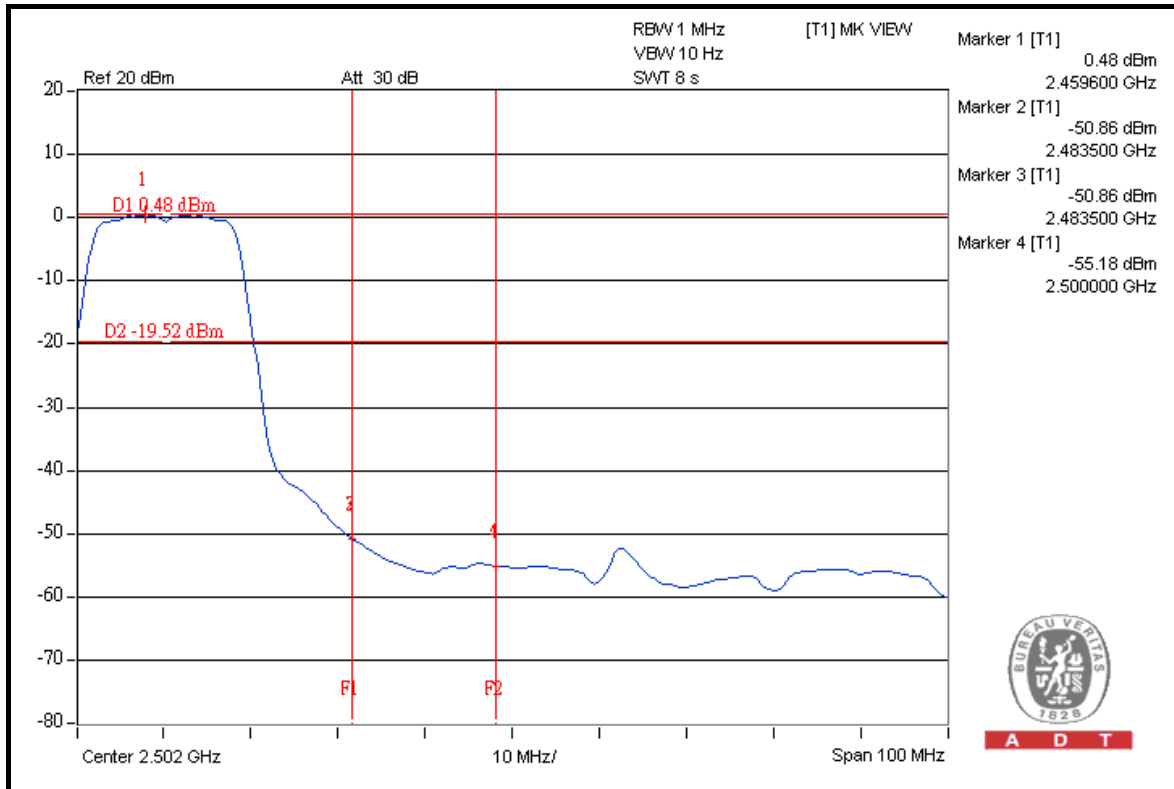



## DRAFT 802.11n (20MHz) OFDM MODULATION

**NOTE 1:** The band edge emission plot on the next page shows 45.53dBuV between carrier maximum power and local maximum emission in restrict band (2.38980GHz). The emission of carrier strength list in the test result of channel 1 at the item 4.1.7 is 109.19dBuV/m (Peak), so the maximum field strength in restrict band is  $109.19 - 45.53 = 63.66$ dBuV/m which is under 74dBuV/m limit.

The band edge emission plot of on the next page shows 49.53dBuV between carrier maximum power and local maximum emission in restrict band (2.39000GHz). The emission of carrier strength list in the test result of channel 1 at the item 4.1.7 is 99.28dBuV/m (Average), so the maximum field strength in restrict band is  $99.28 - 49.53 = 49.75$ dBuV/m which is under 54dBuV/m limit.

**NOTE 2:** The band edge emission plot on the next second page shows 46.76dBuV between carrier maximum power and local maximum emission in restrict band (2.48960GHz). The emission of carrier strength list in the test result of channel 11 at the item 4.1.7 is 110.31dBuV/m (Peak), so the maximum field strength in restrict band is  $110.31 - 46.76 = 63.55$ dBuV/m which is under 74dBuV/m limit.

The band edge emission plot on the next third page shows 50.64dBuV between carrier maximum power and local maximum emission in restrict band (2.48350GHz). The emission of carrier strength list in the test result of channel 11 at the item 4.1.7 is 100.18dBuV/m (Average), so the maximum field strength in restrict band is  $100.18 - 50.64 = 49.54$ dBuV/m which is under 54dBuV/m limit.



A D T

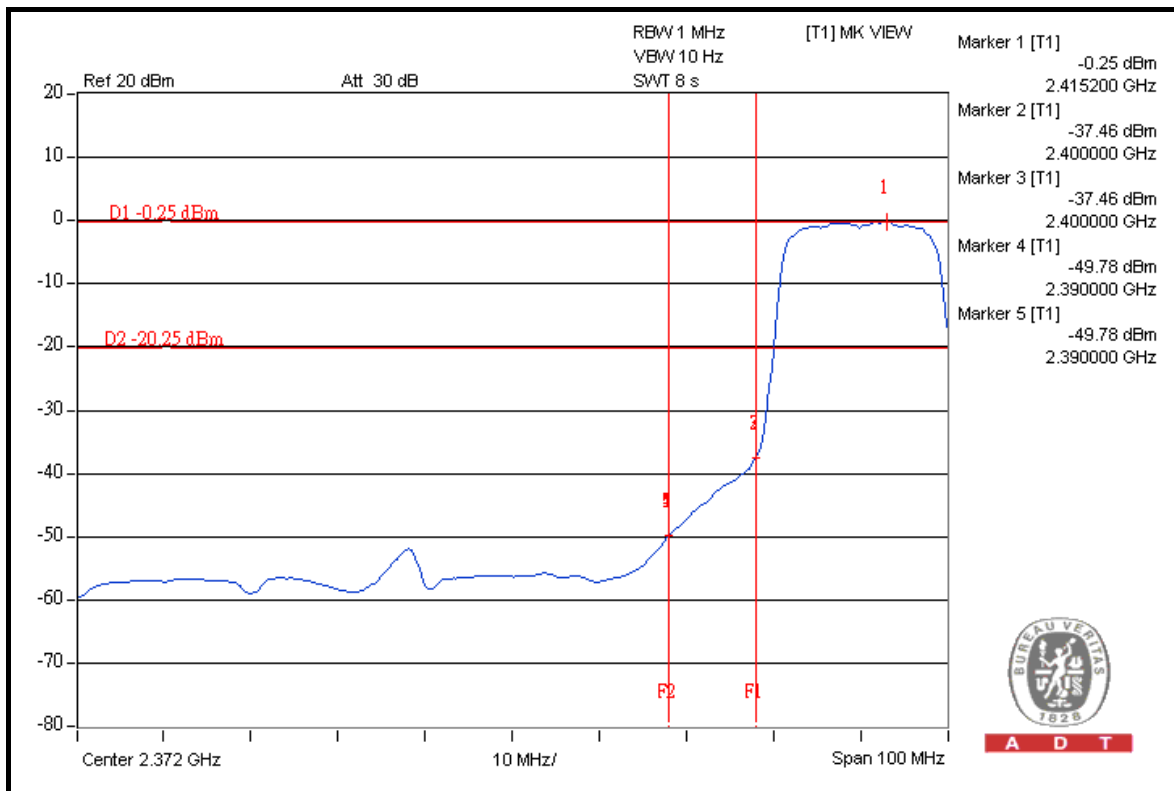
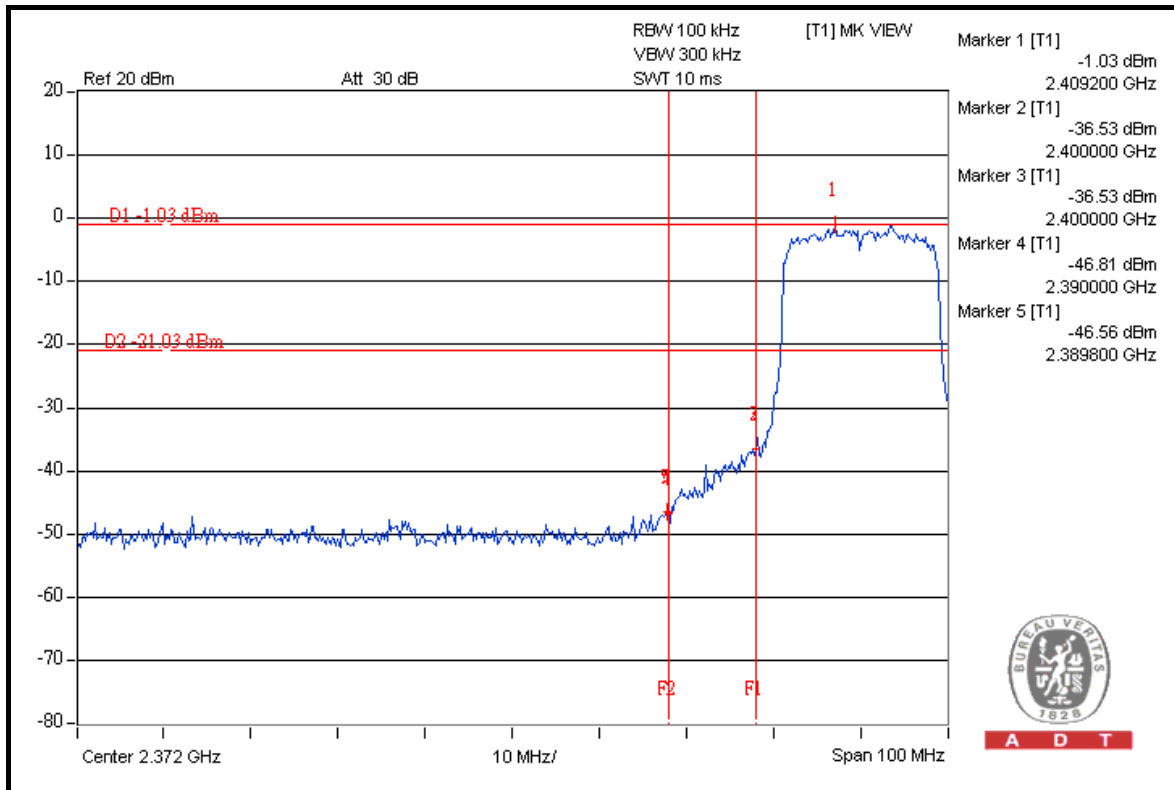



A D T

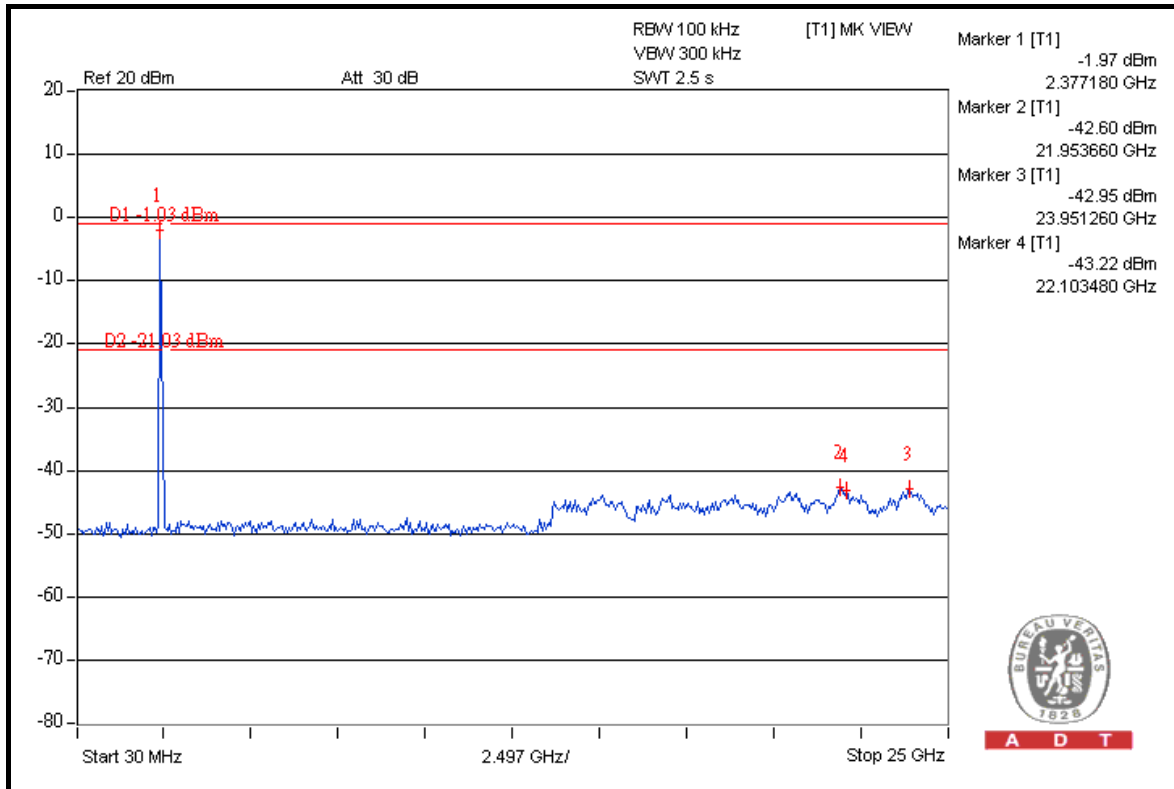

A D T

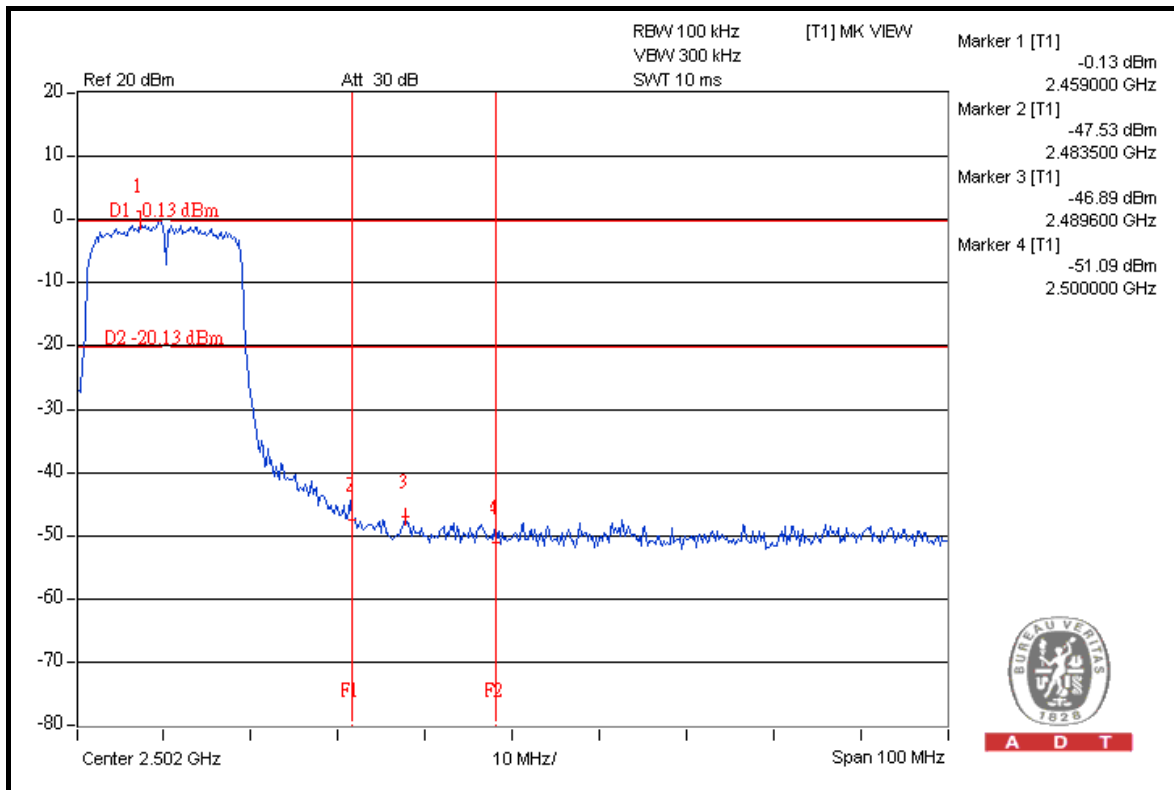

A D T



A D T

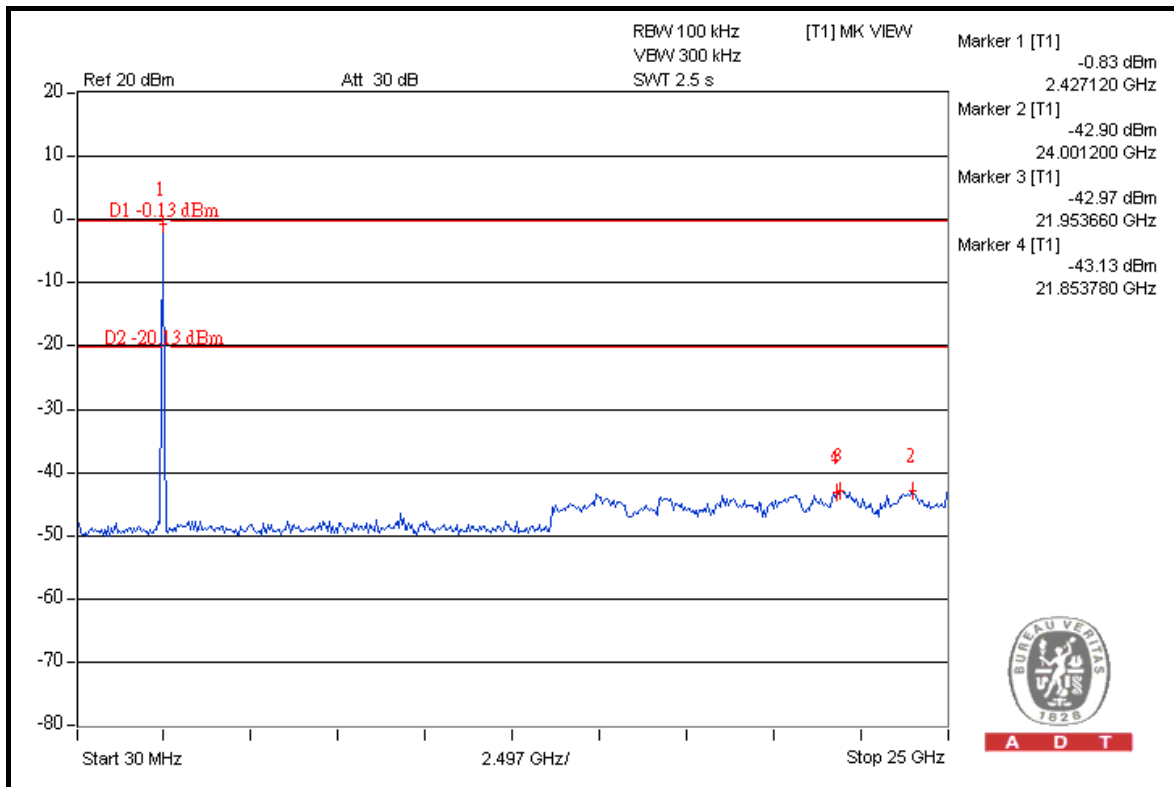
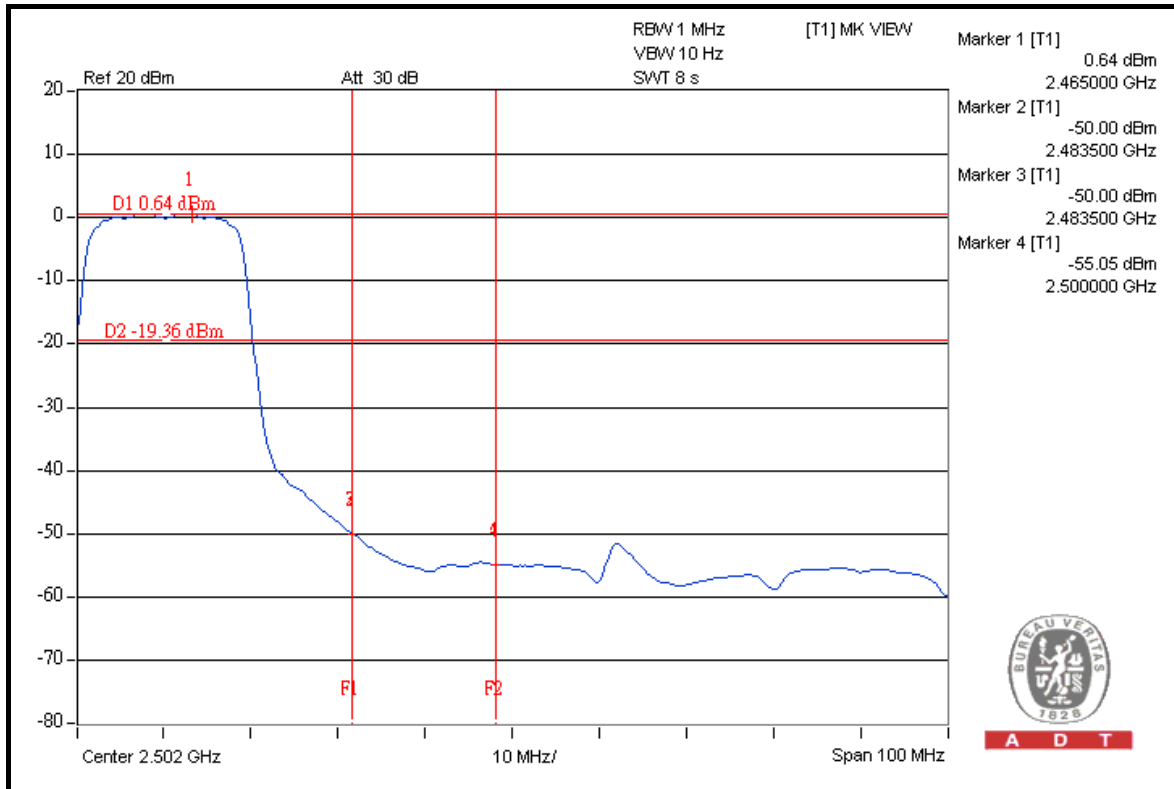



A D T

## DRAFT 802.11n (40MHz) OFDM MODULATION

**NOTE 1:** The band edge emission plot on the next page shows 37.83dBuV between carrier maximum power and local maximum emission in restrict band (2.38880GHz). The emission of carrier strength list in the test result of channel 1 at the item 4.1.7 is 102.12dBuV/m (Peak), so the maximum field strength in restrict band is  $102.12 - 37.83 = 64.29$ dBuV/m which is under 74dBuV/m limit.

The band edge emission plot of on the next page shows 42.61dBuV between carrier maximum power and local maximum emission in restrict band (2.39000GHz). The emission of carrier strength list in the test result of channel 1 at the item 4.1.7 is 92.27dBuV/m (Average), so the maximum field strength in restrict band is  $92.27 - 42.61 = 49.66$ dBuV/m which is under 54dBuV/m limit.

**NOTE 2:** The band edge emission plot on the next second page shows 38.02dBuV between carrier maximum power and local maximum emission in restrict band (2.48560GHz). The emission of carrier strength list in the test result of channel 7 at the item 4.1.7 is 103.22dBuV/m (Peak), so the maximum field strength in restrict band is  $103.22 - 38.02 = 65.20$ dBuV/m which is under 74dBuV/m limit.

The band edge emission plot on the next third page shows 44.69dBuV between carrier maximum power and local maximum emission in restrict band (2.48350GHz). The emission of carrier strength list in the test result of channel 7 at the item 4.1.7 is 93.37dBuV/m (Average), so the maximum field strength in restrict band is  $93.37 - 44.69 = 48.68$ dBuV/m which is under 54dBuV/m limit.





A D T

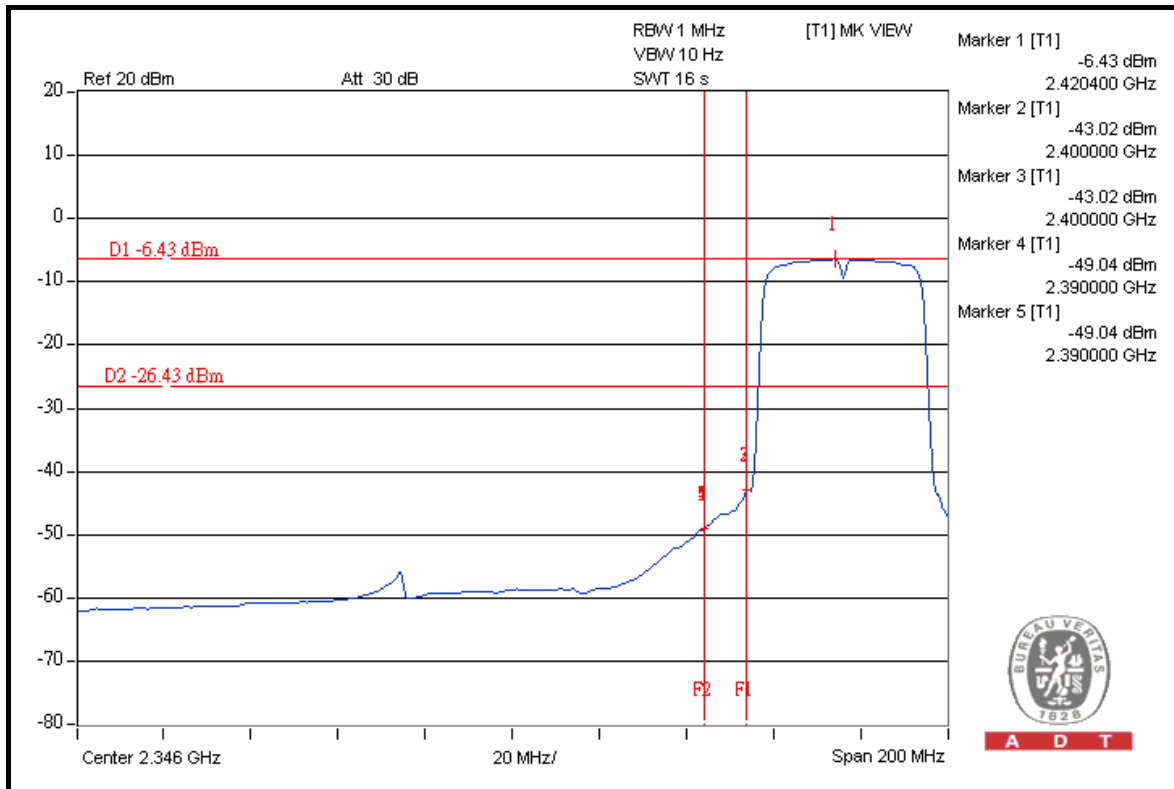
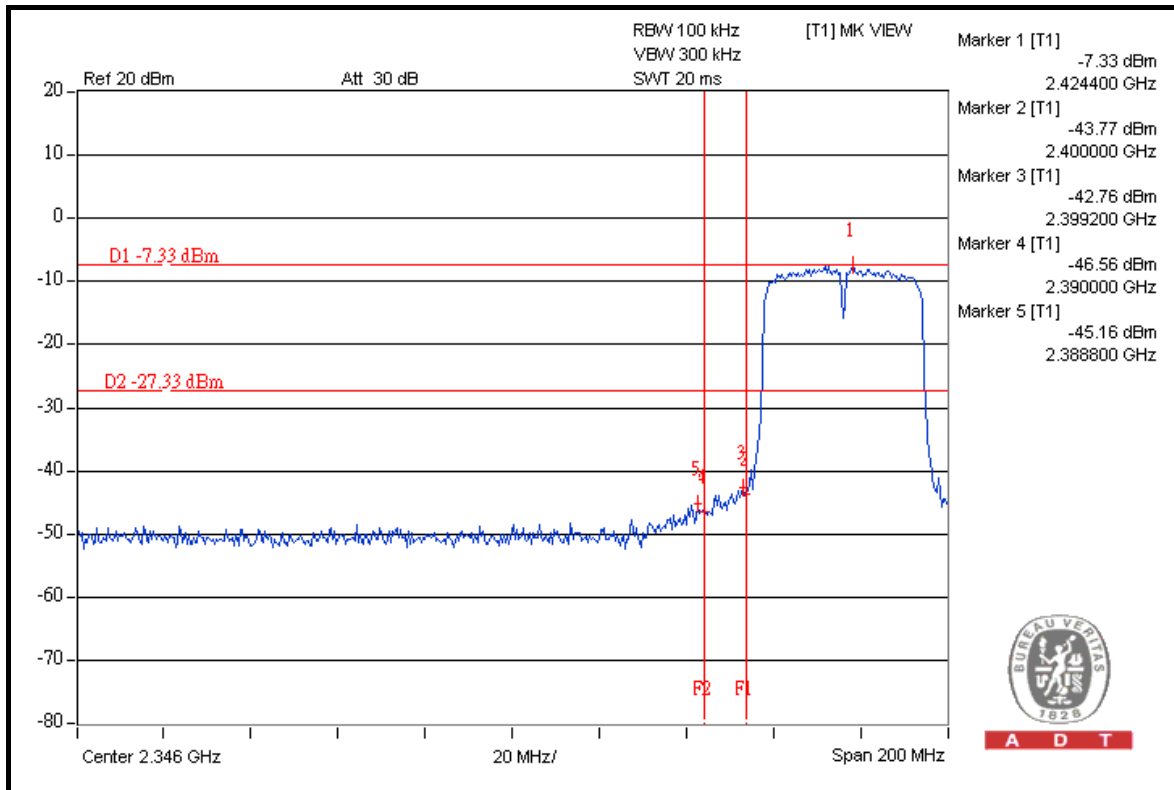



A D T

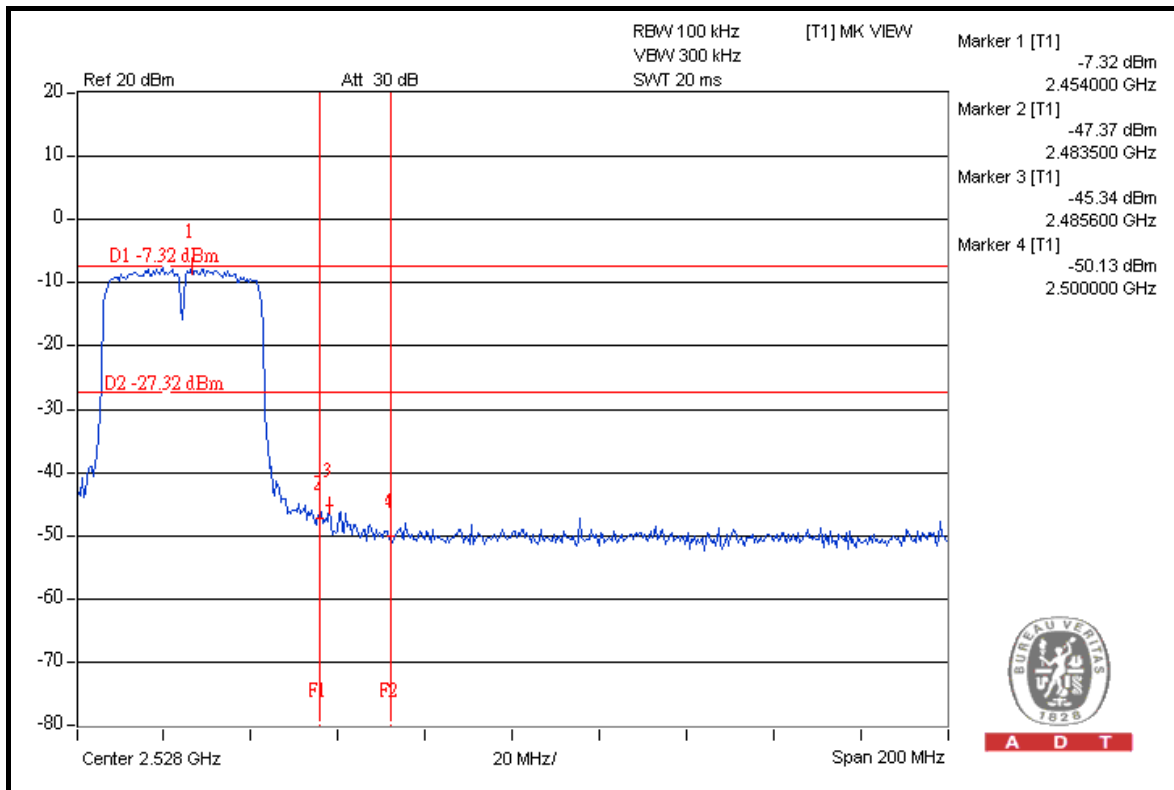
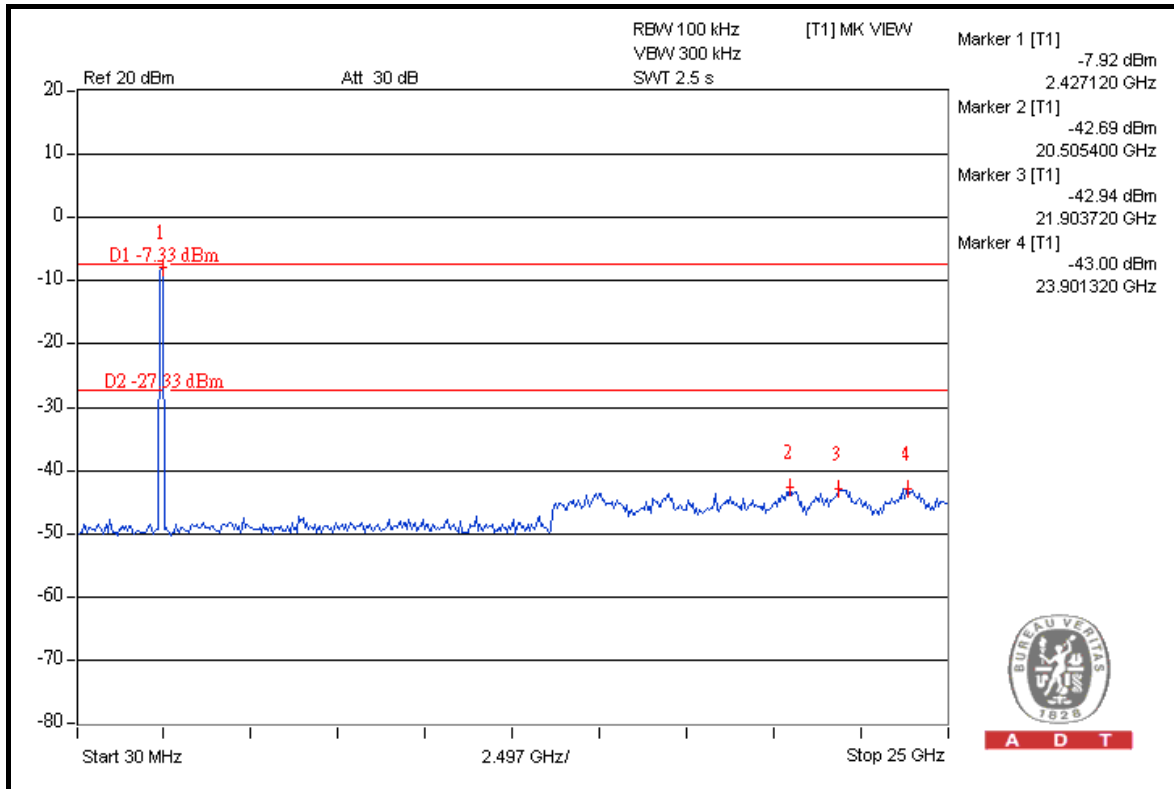



A D T

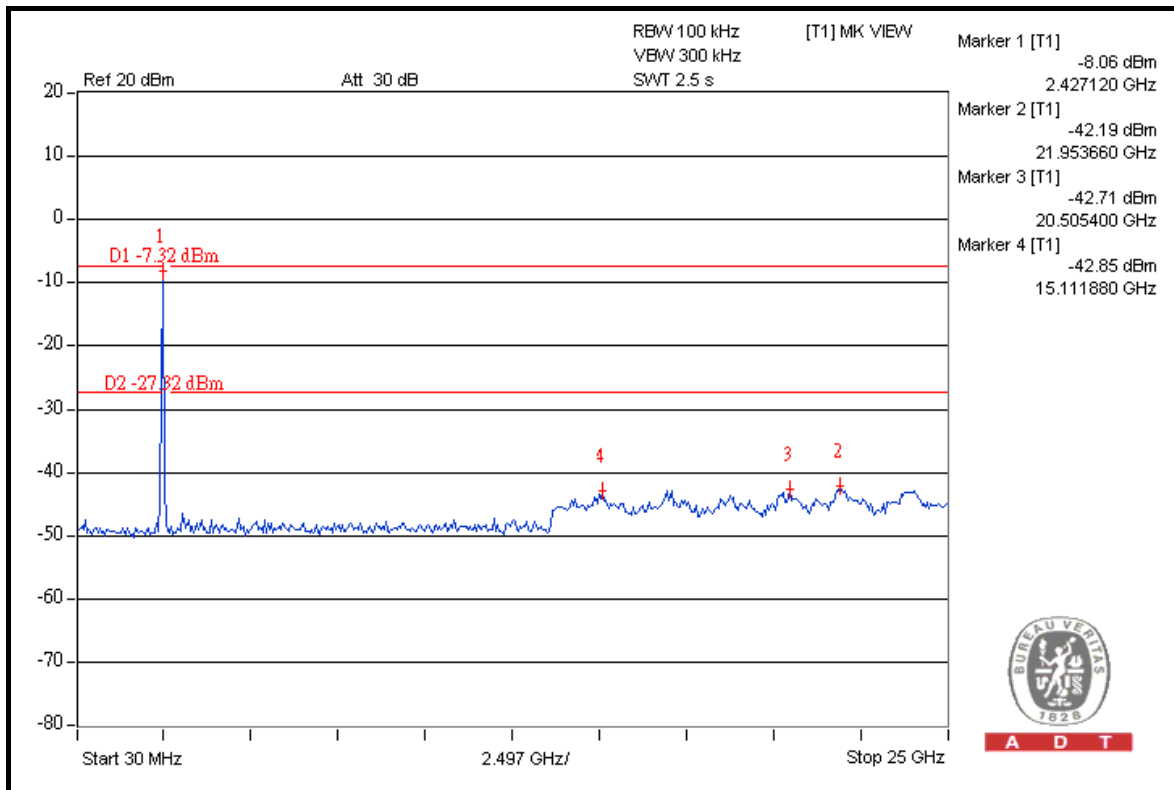
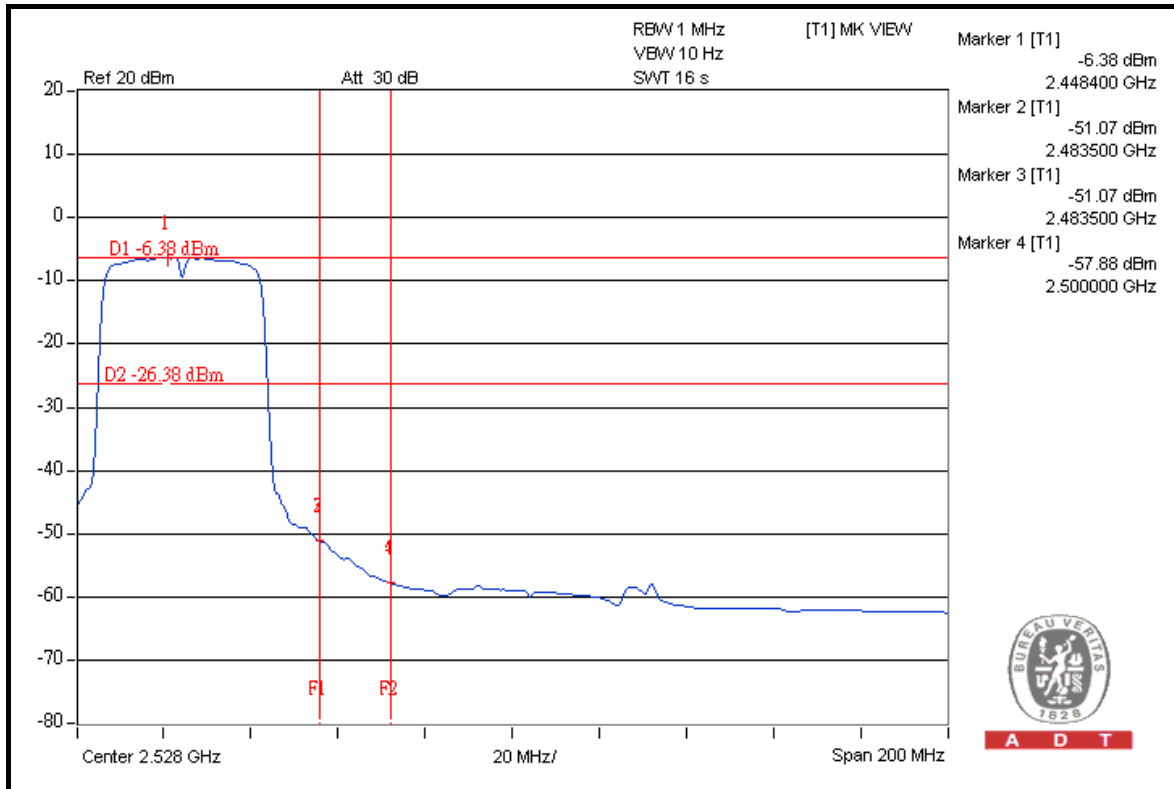



A D T

## 4.7 ANTENNA REQUIREMENT

### 4.7.1 STANDARD APPLICABLE

For intentional device, according to FCC 47 CFR Section 15.203, an intentional radiator shall be designed to ensure that no antenna other than that furnished by the responsible party shall be used with the device.

And according to FCC 47 CFR Section 15.247 (b), if transmitting antennas of directional gain greater than 6dBi are used, the power shall be reduced by the amount in dB that the directional gain of the antenna exceeds 6dBi.

### 4.7.2 ANTENNA CONNECTED CONSTRUCTION

The antenna used in this product is Dipole antenna with R-SMA connector. The maximum gain of the antenna is 2dBi.



A D T

## 5. PHOTOGRAPHS OF THE TEST CONFIGURATION

Please refer to the attached file (Test Setup Photo).



A D T

## 6. INFORMATION ON THE TESTING LABORATORIES

We, Bureau Veritas Consumer Products Services (H.K.) Ltd., Taoyuan Branch, were founded in 1988 to provide our best service in EMC, Radio, Telecom and Safety consultation. Our laboratories are accredited and approved by the following approval agencies according to ISO/IEC 17025.

<b>USA</b>	FCC, NVLAP
<b>Germany</b>	TUV Rheinland
<b>Japan</b>	VCCI
<b>Norway</b>	NEMKO
<b>Canada</b>	INDUSTRY CANADA, CSA
<b>R.O.C.</b>	TAF, BSMI, NCC
<b>Netherlands</b>	Telefication
<b>Singapore</b>	GOST-ASIA(MOU)
<b>Russia</b>	CERTIS(MOU)

Copies of accreditation certificates of our laboratories obtained from approval agencies can be downloaded from our web site:

[www.adt.com.tw/index.5/phtml](http://www.adt.com.tw/index.5/phtml). If you have any comments, please feel free to contact us at the following:

**Linko EMC/RF Lab:**

Tel: 886-2-26052180  
Fax: 886-2-26051924

**Hsin Chu EMC/RF Lab:**

Tel: 886-3-5935343  
Fax: 886-3-5935342

**Hwa Ya EMC/RF/Safety Telecom Lab:**

Tel: 886-3-3183232  
Fax: 886-3-3185050

**Web Site:** [www.adt.com.tw](http://www.adt.com.tw)

The address and road map of all our labs can be found in our web site also.



A D T

## **7. APPENDIX A - MODIFICATIONS RECORDERS FOR ENGINEERING CHANGES TO THE EUT BY THE LAB**

No any modifications are made to the EUT by the lab during the test.

**---END---**