



FCC RADIO TEST REPORT

FCC ID: XHWEGS004

Product : 7inch tablet
Trade Name : Ematic
Model Name : EGS004
Serial Model : EGS004-GR,EGS004-BL,EGS004-PR,EGS004-PN,
EGS004-BU,EGS004-RD
Report No. : NTEK- 2013NT0123034F

Prepared for

E-matic

3435 Ocean Park Blvd #107 PMB # 444, Santa Monica CA 90405, Los Angeles, California, United States

Prepared by

Shenzhen NTEK Testing Technology Co., Ltd.
1/F, Building E, Fenda Science Park, Sanwei Community, Xixiang Street
Bao'an District, Shenzhen P.R. China
Tel.: +86-0755-61156588 Fax.: +86-0755-61156599
Website: www.ntek.org.cn

TEST RESULT CERTIFICATION

Applicant's name : E-matic
Address : 3435 Ocean Park Blvd #107 PMB # 444, Santa Monica CA
90405, Los Angeles, California, United States
Manufacturer's Name : Acuce Co., Ltd.
Address : 630-632, Block A, Huameiju Business Building, Baoan District,
Shenzhen 518133, China

Product description

Product name : 7inch tablet
Model and/or type reference : EGS004
Serial Model : EGS004-GR, EGS004-BL, EGS004-PR, EGS004-PN,
EGS004-BU, EGS004-RD

Standards : FCC Part15.247

Test procedure ANSI C63.4-2003

This device described above has been tested by NTEK, and the test results show that the equipment under test (EUT) is in compliance with the FCC requirements. And it is applicable only to the tested sample identified in the report.

This report shall not be reproduced except in full, without the written approval of NTEK, this document may be altered or revised by NTEK, personal only, and shall be noted in the revision of the document.

Date of Test :

Date (s) of performance of tests : 14 Jan. 2013 ~20 Jan. 2013

Date of Issue : 23 Jan. 2013

Test Result : **Pass**

Testing Engineer : Apple Huang
(Apple Huang)

Technical Manager : Tom Zhang
(Tom Zhang)

Authorized Signatory : Bovey Yang
(Bovey Yang)

Table of Contents

	Page
1 . SUMMARY OF TEST RESULTS	5
1.1 TEST FACILITY	6
1.2 MEASUREMENT UNCERTAINTY	6
2 . GENERAL INFORMATION	7
2.1 GENERAL DESCRIPTION OF EUT	7
2.2 DESCRIPTION OF TEST MODES	9
2.3 BLOCK DIGRAM SHOWING THE CONFIGURATION OF SYSTEM TESTED	10
2.4 DESCRIPTION OF SUPPORT UNITS(CONDUCTED MODE)	11
2.5 EQUIPMENTS LIST FOR ALL TEST ITEMS	12
3 . EMC EMISSION TEST	13
3.1 CONDUCTED EMISSION MEASUREMENT	13
3.1.1 POWER LINE CONDUCTED EMISSION LIMITS	13
3.1.2 TEST PROCEDURE	14
3.1.3 DEVIATION FROM TEST STANDARD	14
3.1.4 TEST SETUP	14
3.1.5 EUT OPERATING CONDITIONS	14
3.1.6 TEST RESULTS	15
3.2 RADIATED EMISSION MEASUREMENT	17
3.2.1 RADIATED EMISSION LIMITS	17
3.2.2 TEST PROCEDURE	18
3.2.3 DEVIATION FROM TEST STANDARD	18
3.2.4 TEST SETUP	19
3.2.5 EUT OPERATING CONDITIONS	20
3.2.6 TEST RESULTS (BETWEEN 9KHZ – 30 MHZ)	21
3.2.7 TEST RESULTS (BETWEEN 30MHZ – 1GHZ)	22
3.2.8 TEST RESULTS (ABOVE 1000 MHZ)	24
4 . POWER SPECTRAL DENSITY TEST	54
4.1 APPLIED PROCEDURES / LIMIT	54
4.1.1 TEST PROCEDURE	54
4.1.2 DEVIATION FROM STANDARD	54
4.1.3 TEST SETUP	54
4.1.4 EUT OPERATION CONDITIONS	54
4.1.5 TEST RESULTS	55
5 . BANDWIDTH TEST	61
5.1 APPLIED PROCEDURES / LIMIT	61
5.1.1 TEST PROCEDURE	61

Table of Contents

	Page
5.1.2 DEVIATION FROM STANDARD	61
5.1.3 TEST SETUP	61
5.1.4 EUT OPERATION CONDITIONS	61
5.1.5 TEST RESULTS	62
6 . PEAK OUTPUT POWER TEST	68
6.1 APPLIED PROCEDURES / LIMIT	68
6.1.1 TEST PROCEDURE	68
6.1.2 DEVIATION FROM STANDARD	68
6.1.3 TEST SETUP	68
6.1.4 EUT OPERATION CONDITIONS	68
6.1.5 TEST RESULTS	69
7 . ANTENNA REQUIREMENT	70
7.1 STANDARD REQUIREMENT	70
7.2 EUT ANTENNA	70
8 . EUT TEST PHOTO	71
APPENDIX-PHOTOGRAPHS OF EUT CONSTRUCTIONAL DETAILS	

1. SUMMARY OF TEST RESULTS

Test procedures according to the technical standards:

FCC Part15 (15.247) , Subpart C			
Standard Section	Test Item	Judgment	Remark
15.207	Conducted Emission	PASS	
15.247 (a)(2)	6dB Bandwidth	PASS	
15.247 (b)	Peak Output Power	PASS	
15.247 (c)	Radiated Spurious Emission	PASS	
15.247 (d)	Power Spectral Density	PASS	
15.205	Band Edge Emission	PASS	
15.203	Antenna Requirement	PASS	

NOTE:

(1) "N/A" denotes test is not applicable in this Test Report

1.1 TEST FACILITY

NTEK Testing Technology Co., Ltd
 Add.:1/F, Building E, Fenda Science Park, Sanwei Community, Xixiang Street, Bao'an District, Shenzhen P.R. China.
 FCC Registration No.:238937; IC Registration No.:9270A-1
 CNAS Registration No.:L5516

1.2 MEASUREMENT UNCERTAINTY

The reported uncertainty of measurement $y \pm U$, where expanded uncertainty U is based on a standard uncertainty multiplied by a coverage factor of $k=2$, providing a level of confidence of approximately 95 %.

No.	Item	Uncertainty
1	Conducted Emission Test	$\pm 1.38\text{dB}$
2	RF power,conducted	$\pm 0.16\text{dB}$
3	Spurious emissions,conducted	$\pm 0.21\text{dB}$
4	All emissions,radiated(<1G)	$\pm 4.68\text{dB}$
5	All emissions,radiated(>1G)	$\pm 4.89\text{dB}$
6	Temperature	$\pm 0.5^{\circ}\text{C}$
7	Humidity	$\pm 2\%$

2. GENERAL INFORMATION

2.1 GENERAL DESCRIPTION OF EUT

Equipment	7inch tablet	
Trade Name	Ematic	
Model Name	EGS004	
Serial Model	EGS004-GR,EGS004-BL,EGS004-PR,EGS004-PN,EGS004-BU,EGS004-RD	
Model Difference	All the model are the same circuit and RF module,except the color.	
Product Description	The EUT is a 7inch tablet	
	Operation Frequency:	802.11b/g/n:2412~2462 MHz
	Modulation Type:	CCK/OFDM/DBPSK/DAPSK
	Bit Rate of Transmitter	802.11b:11/5.5/2/1 Mbps 802.11g:54/48/36/24/18/12/9/6 Mbps 802.11n:72.2/52/6.5 Mbps
	Number Of Channel	802.11b/g/n: 11CH
	Antenna Designation:	Please see Note 3.
	Output Power(Conducted):	802.11b: 11.95 dBm (Max.) 802.11g: 9.87 dBm (Max.) 802.11n: 8.97 dBm (Max.)
	Antenna Gain (dBi)	1.0dbi
	Based on the application, features, or specification exhibited in User's Manual, the EUT is considered as an ITE/Computing Device. More details of EUT technical specification, please refer to the User's Manual.	
Channel List	Please refer to the Note 2.	
Ratings	DC 3.7V	
Adapter	N/A	
Battery	Rated Voltage: 3.7V	
	Charge Limit: 4.2V	
	Capacity :2400mAh	
Connecting I/O Port(s)	Please refer to the User's Manual	

Note:

1. For a more detailed features description, please refer to the manufacturer's specifications or the User's Manual.

2.

Channel List for 802.11b/g/n							
Channel	Frequency (MHz)	Channel	Frequency (MHz)	Channel	Frequency (MHz)	Channel	Frequency (MHz)
01	2412	04	2427	07	2442	10	2457
02	2417	05	2432	08	2447	11	2462
03	2422	06	2437	09	2452		

3.

Table for Filed Antenna

Ant	Brand	Model Name	Antenna Type	Connector	Gain (dBi)	NOTE
A	N/A	N/A	FPCB Antenna	N/A	1.0	N/A

2.2 DESCRIPTION OF TEST MODES

To investigate the maximum EMI emission characteristics generates from EUT, the test system was pre-scanning tested base on the consideration of following EUT operation mode or test configuration mode which possible have effect on EMI emission level. Each of these EUT operation mode(s) or test configuration mode(s) mentioned above was evaluated respectively.

Pretest Mode	Description
Mode 1	802.11b CH1/ CH6/ CH11
Mode 2	802.11g CH1/ CH6/ CH11
Mode 3	802.11n CH1/ CH6/ CH11
Mode 4	Link Mode

For Conducted Emission	
Final Test Mode	Description
Mode 4	Link Mode

For Radiated Emission	
Final Test Mode	Description
Mode 1	802.11b CH1/ CH6/ CH11
Mode 2	802.11g CH1/ CH6/ CH11
Mode 3	802.11n CH1/ CH6/ CH11

Note:

- (1) The measurements are performed at the highest, middle, lowest available channels.
- (2) The measurements are performed at all Bit Rate of Transmitter, the worst data was reported

2.3 BLOCK DIGRAM SHOWING THE CONFIGURATION OF SYSTEM TESTED

Conducted Emission Test

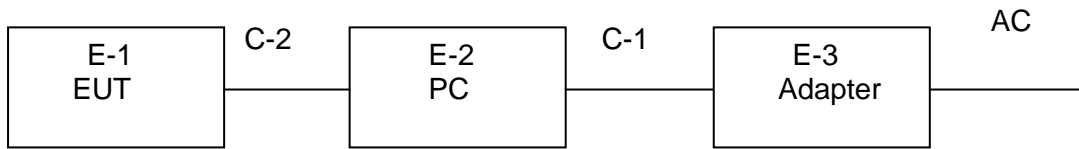

Radiated Spurious Emission Test

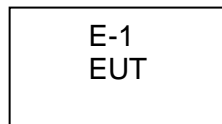

2.4 DESCRIPTION OF SUPPORT UNITS(CONDUCTED MODE)

The EUT has been tested as an independent unit together with other necessary accessories or support units. The following support units or accessories were used to form a representative test configuration during the tests.

Item	Equipment	Mfr/Brand	Model/Type No.	Series No.	Note
E-1	7inch tablet	Ematic	EGS004	N/A	EUT
E-2	PC	IBM	S328	N/A	
E-3	Adapter	N/A	KSAS0100500200HU	N/A	

Item	Shielded Type	Ferrite Core	Length	Note
C-1	NO	NO	0.8M	
C-2	NO	NO	1.0M	

Note:

- (1) The support equipment was authorized by Declaration of Confirmation.
- (2) For detachable type I/O cable should be specified the length in cm in 『Length』 column.

2.5 EQUIPMENTS LIST FOR ALL TEST ITEMS

Radiation Test equipment

Item	Kind of Equipment	Manufacturer	Type No.	Serial No.	Last calibration	Calibrated until	Calibration period
1	Spectrum Analyzer	Agilent	E4407B	MY45108040	2012.07.06	2013.07.05	1 year
2	Test Receiver	R&S	ESPI	101318	2012.06.07	2013.06.06	1 year
3	Bilog Antenna	TESEQ	CBL6111D	31216	2012.07.06	2013.07.05	1 year
4	50Ω Coaxial Switch	Anritsu	MP59B	6200264416	2012.06.07	2013.06.06	1 year
5	Spectrum Analyzer	ADVANTEST	R3132	150900201	2012.06.07	2013.06.06	1 year
6	Horn Antenna	EM	EM-AH-10180	2011071402	2012.07.06	2013.07.05	1 year
7	Horn Ant	Schwarzbeck	BBHA 9170	9170-181	2012.07.06	2013.07.05	1 year
8	Amplifier	EM	EM-30180	060538	2011.12.22	2012.12.21	1 year
9	Loop Antenna	ARA	PLA-1030/B	1029	2012.06.08	2013.06.07	1 year
10	Power Meter	R&S	NRVS	100696	2012.07.06	2013.07.05	1 year
11	Power Sensor	R&S	URV5-Z4	0395.1619.05	2012.07.06	2013.07.05	1 year

Conduction Test equipment

Item	Kind of Equipment	Manufacturer	Type No.	Serial No.	Last calibration	Calibrated until	Calibration period
1	Test Receiver	R&S	ESCI	101160	2012.06.06	2013.06.05	1 year
2	LISN	R&S	ENV216	101313	2012.08.24	2013.08.23	1 year
3	LISN	EMCO	3816/2	00042990	2012.08.24	2013.08.23	1 year
4	50Ω Coaxial Switch	Anritsu	MP59B	6200264417	2012.06.07	2013.06.06	1 year
5	Passive Voltage Probe	R&S	ESH2-Z3	100196	2012.06.07	2013.06.06	1 year
6	Absorbing clamp	R&S	MOS-21	100423	2012.06.08	2013.06.07	1 year

3. EMC EMISSION TEST

3.1 CONDUCTED EMISSION MEASUREMENT

3.1.1 POWER LINE CONDUCTED EMISSION Limits (Frequency Range 150KHz-30MHz)

FREQUENCY (MHz)	Class A (dBuV)		Class B (dBuV)		Standard
	Quasi-peak	Average	Quasi-peak	Average	
0.15 -0.5	79.00	66.00	66 - 56 *	56 - 46 *	CISPR
0.50 -5.0	73.00	60.00	56.00	46.00	CISPR
5.0 -30.0	73.00	60.00	60.00	50.00	CISPR

0.15 -0.5	79.00	66.00	66 - 56 *	56 - 46 *	FCC
0.50 -5.0	73.00	60.00	56.00	46.00	FCC
5.0 -30.0	73.00	60.00	60.00	50.00	FCC

Note:

- (1) The tighter limit applies at the band edges.
- (2) The limit of " * " marked band means the limitation decreases linearly with the logarithm of the frequency in the range.

The following table is the setting of the receiver

Receiver Parameters	Setting
Attenuation	10 dB
Start Frequency	0.15 MHz
Stop Frequency	30 MHz
IF Bandwidth	9 kHz

3.1.2 TEST PROCEDURE

- a. The EUT was placed 0.4 meters from the horizontal ground plane with EUT being connected to the power mains through a line impedance stabilization network (LISN). All other support equipments powered from additional LISN(s). The LISN provide 50 Ohm/ 50uH of coupling impedance for the measuring instrument.
- b. Interconnecting cables that hang closer than 40 cm to the ground plane shall be folded back and forth in the center forming a bundle 30 to 40 cm long.
- c. I/O cables that are not connected to a peripheral shall be bundled in the center. The end of the cable may be terminated, if required, using the correct terminating impedance. The overall length shall not exceed 1 m.
- d. LISN at least 80 cm from nearest part of EUT chassis.
- e. For the actual test configuration, please refer to the related Item –EUT Test Photos.

3.1.3 DEVIATION FROM TEST STANDARD

No deviation

3.1.4 TEST SETUP

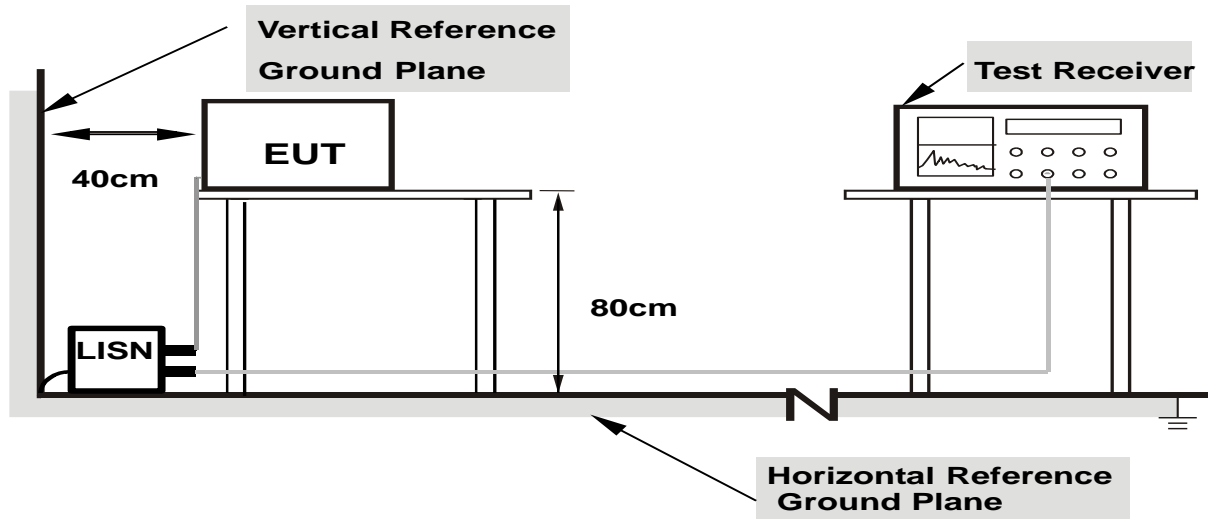

- Note: 1.Support units were connected to second LISN.**
2.Both of LISNs (AMN) are 80 cm from EUT and at least 80 from other units and other metal planes

3.1.5 EUT OPERATING CONDITIONS

The EUT was configured for testing in a typical fashion (as a customer would normally use it). The EUT has been programmed to continuously transmit during test. This operating condition was tested and used to collect the included data.

3.1.6 TEST RESULTS

EUT :	7inch tablet	Model Name. :	EGS004
Temperature :	26 °C	Relative Humidity :	54%
Pressure :	1010hPa	Phase :	L
Test Voltage :	DC 5.0V from PC AC120V/60Hz	Test Mode :	Mode 4

Frequency (MHz)	Meter Reading (dBμV)	Factor (dB)	Emission Level (dBμV)	Limits (dBμV)	Margin (dB)	Detector Type
0.202	46.65	10.2	56.85	63.52	-6.67	QP
0.202	37.39	10.2	47.59	53.52	-5.93	AVG
0.294	38.27	10.2	48.47	60.41	-11.94	QP
0.306	25.89	10.2	36.09	50.08	-13.99	AVG
16.0539	24.95	10.57	35.52	50	-14.48	AVG
16.3699	36.38	10.6	46.98	60	-13.02	QP

Remark:

1. All readings are Quasi-Peak and Average values.
2. Factor = Insertion Loss + Cable Loss.

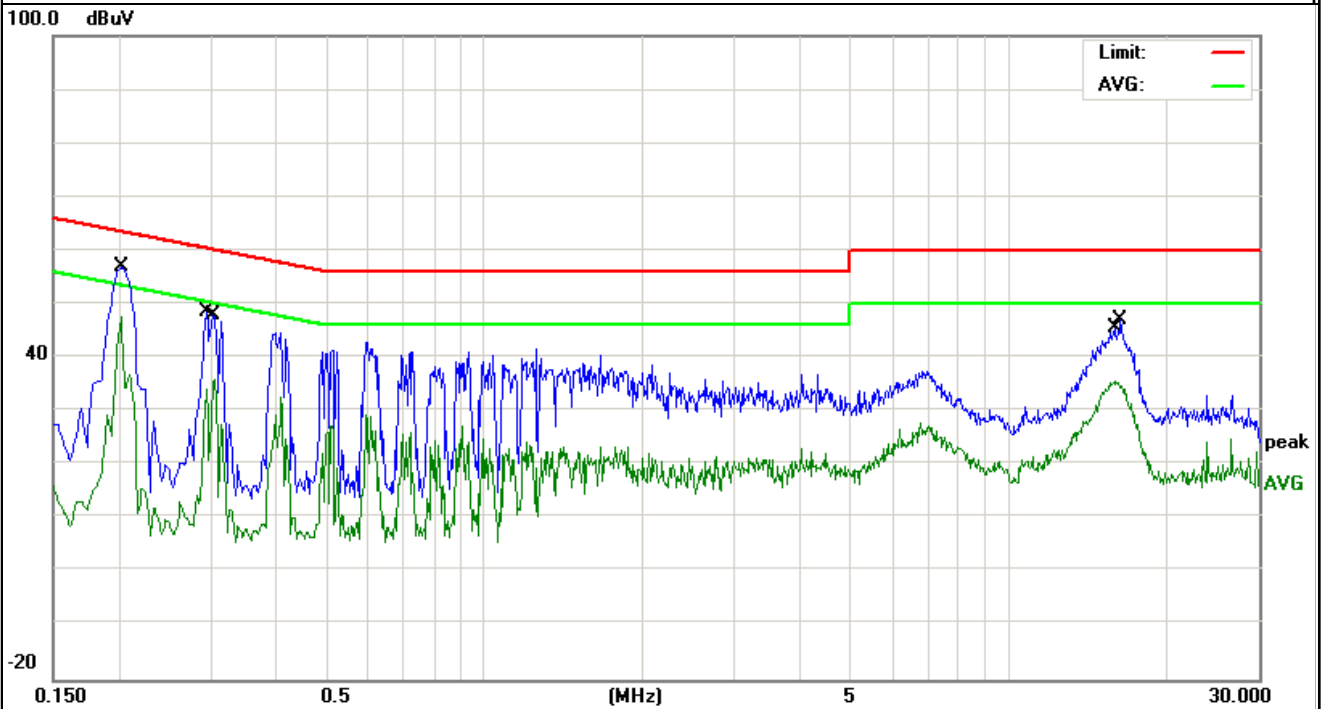

EUT :	7inch tablet	Model Name. :	EGS004
Temperature :	26 °C	Relative Humidity :	54%
Pressure :	1010hPa	Phase :	N
Test Voltage :	DC 5.0V from PC AC120V/60Hz	Test Mode :	Mode 4

Frequency (MHz)	Meter Reading (dBμV)	Factor (dB)	Emission Level (dBμV)	Limits (dBμV)	Margin (dB)	Detector Type
0.198	45.72	10.19	55.91	63.69	-7.78	QP
0.202	31.59	10.2	41.79	53.52	-11.73	AVG
0.294	37.68	10.2	47.88	60.41	-12.53	QP
0.306	21.88	10.2	32.08	50.08	-18	AVG
15.6099	29.77	10.55	40.32	60	-19.68	QP
15.9259	18.81	10.57	29.38	50	-20.62	AVG

Remark:

1. All readings are Quasi-Peak and Average values.
2. Factor = Insertion Loss + Cable Loss.

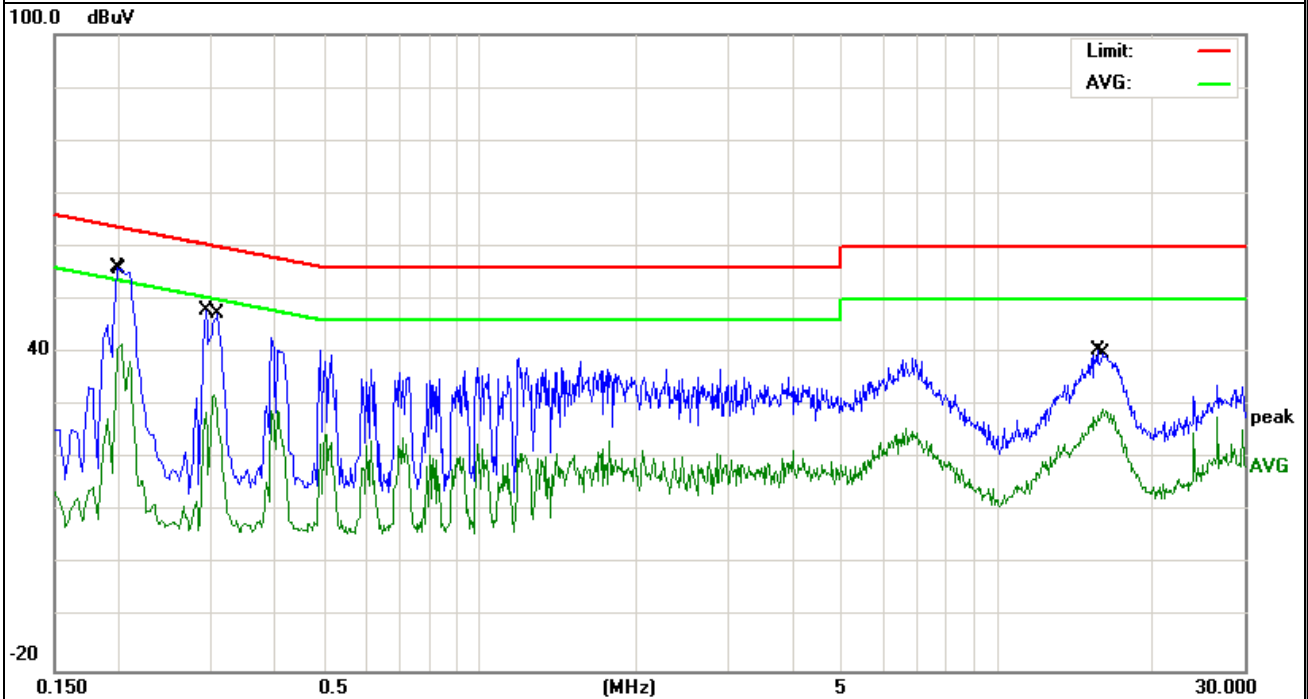

3.2 RADIATED EMISSION MEASUREMENT

3.2.1 RADIATED EMISSION LIMITS (Frequency Range 9kHz-1000MHz)

20dBc in any 100 kHz bandwidth outside the operating frequency band. In case the emission fall within the restricted band specified on 15.205(a), then the 15.209(a) limit in the table below has to be followed.

Frequencies (MHz)	Field Strength (microrvolts/meter)	Measurement Distance (meters)
0.009~0.490	2400/F(KHz)	300
0.490~1.705	24000/F(KHz)	30
1.705~30.0	30	30
30~88	100	3
88~216	150	3
216~960	200	3
Above 960	500	3

LIMITS OF RADIATED EMISSION MEASUREMENT (Above 1000MHz)

FREQUENCY (MHz)	Class A (dBuV/m) (at 3M)		Class B (dBuV/m) (at 3M)	
	PEAK	AVERAGE	PEAK	AVERAGE
Above 1000	80	60	74	54

Notes:

- (1) The limit for radiated test was performed according to FCC PART 15C.
- (2) The tighter limit applies at the band edges.
- (3) Emission level (dBuV/m)=20log Emission level (uV/m).

Spectrum Parameter	Setting
Attenuation	Auto
Start Frequency	1000 MHz
Stop Frequency	10th carrier harmonic
RB / VB (emission in restricted band)	1 MHz / 1 MHz for Peak, 1 MHz / 10Hz for Average

Receiver Parameter	Setting
Attenuation	Auto
Start ~ Stop Frequency	9kHz~150kHz / RB 200Hz for QP
Start ~ Stop Frequency	150kHz~30MHz / RB 9kHz for QP
Start ~ Stop Frequency	30MHz~1000MHz / RB 120kHz for QP

3.2.2 TEST PROCEDURE

- a. The measuring distance of at 3 m shall be used for measurements at frequency up to 1GHz. For frequencies above 1GHz, any suitable measuring distance may be used.
- b. The EUT was placed on the top of a rotating table 0.8 meters above the ground at a 3 meter open area test site. The table was rotated 360 degrees to determine the position of the highest radiation.
- c. The height of the equipment or of the substitution antenna shall be 0.8 m; the height of the test antenna shall vary between 1 m to 4 m. Both horizontal and vertical polarizations of the antenna are set to make the measurement.
- d. The initial step in collecting conducted emission data is a spectrum analyzer peak detector mode pre-scanning the measurement frequency range. Significant peaks are then marked and then Quasi Peak detector mode re-measured.
- e. If the Peak Mode measured value compliance with and lower than Quasi Peak Mode Limit, the EUT shall be deemed to meet QP Limits and then no additional QP Mode measurement performed.
- f. For the actual test configuration, please refer to the related Item –EUT Test Photos.

Note:

Both horizontal and vertical antenna polarities were tested and performed pretest to three orthogonal axis. The worst case emissions were reported

3.2.3 DEVIATION FROM TEST STANDARD

No deviation

3.2.4 TEST SETUP

(A) Radiated Emission Test-Up Frequency Below 30MHz

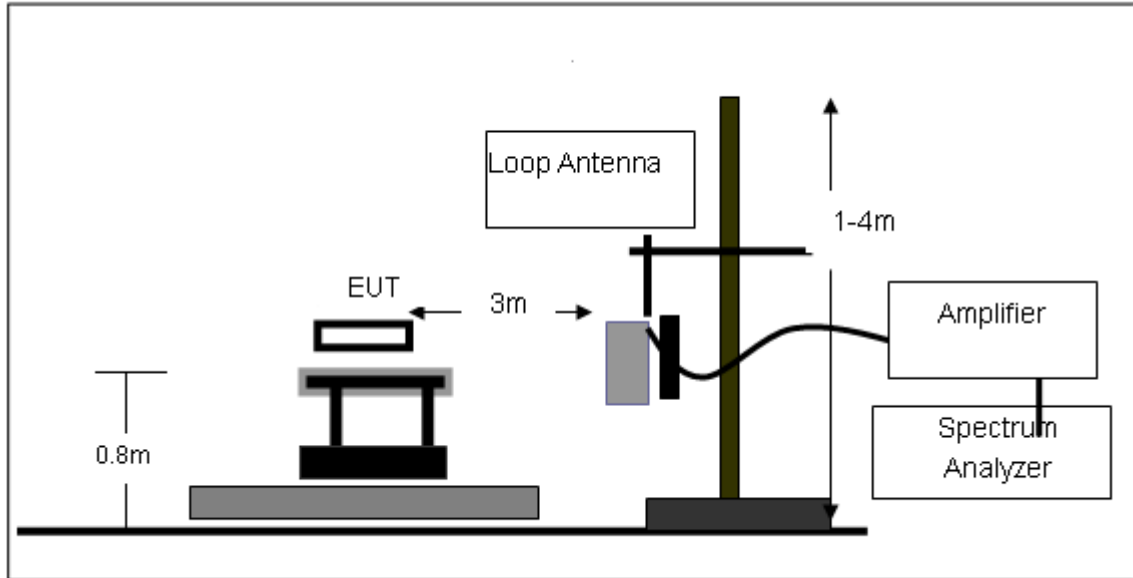

(B) Radiated Emission Test-Up Frequency 30MHz~1GHz

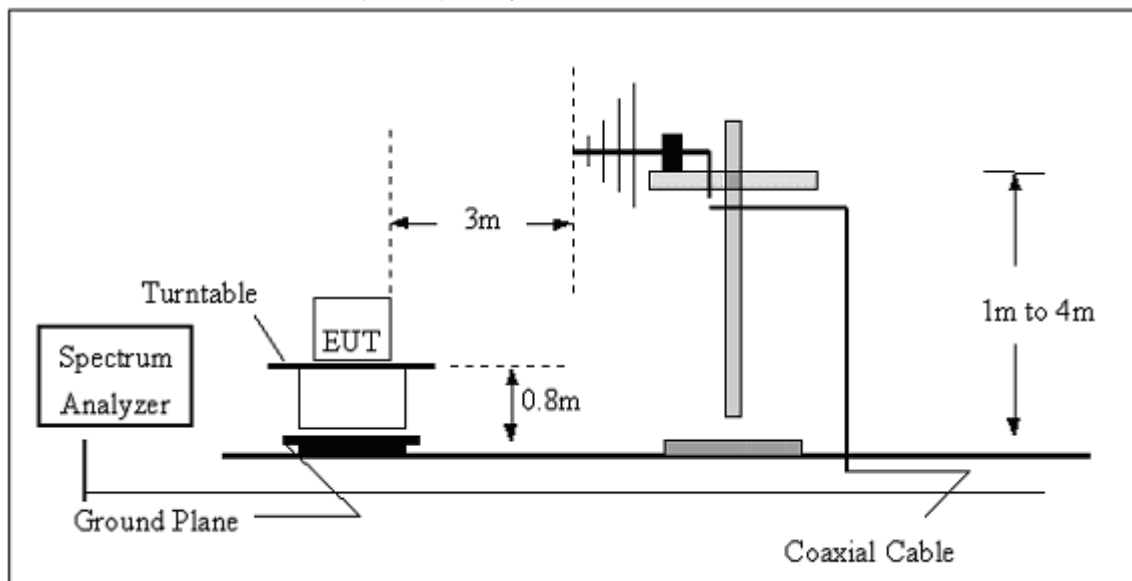

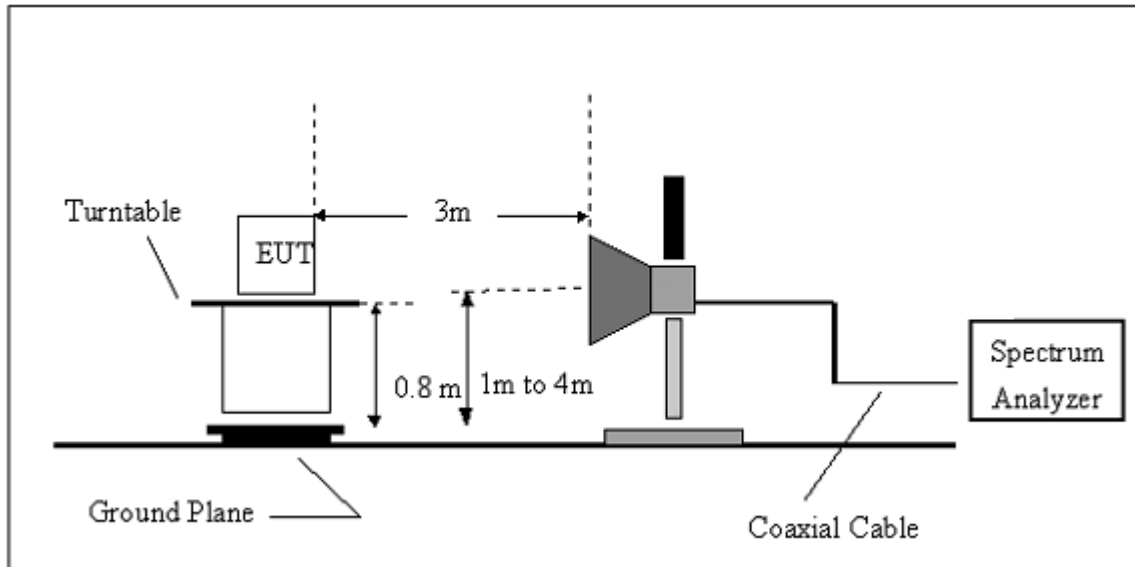
(C) Radiated Emission Test-Up Frequency Above 1GHz**3.2.5 EUT OPERATING CONDITIONS**

The EUT tested system was configured as the statements of 2.4 Unless otherwise a special operating condition is specified in the follows during the testing.

3.2.6 TEST RESULTS (BETWEEN 9KHZ – 30 MHZ)

EUT:	7inch tablet	Model Name. :	EGS004
Temperature:	20 °C	Relative Humidity:	48%
Pressure:	1010 hPa	Test Voltage :	DC 3.7V
Test Mode :	TX	Polarization :	--

Freq. (MHz)	Reading (dBuV/m)	Limit (dBuV/m)	Margin (dB)	State P/F
--	--	--	--	PASS
--	--	--	--	PASS

NOTE:

The amplitude of spurious emissions which are attenuated by more than 20dB below the permissible value has no need to be reported.

Distance extrapolation factor = $20 \log (\text{specific distance}/\text{test distance})(\text{dB})$;

Limit line = specific limits(dBuv) + distance extrapolation factor.

3.2.7 TEST RESULTS (BETWEEN 30MHZ – 1GHZ)

EUT :	7inch tablet	Model Name :	EGS004
Temperature :	20 °C	Relative Humidity :	48%
Pressure :	1010 hPa	Test Voltage :	DC 3.7V
Test Mode :	TX	Polarization :	Horizontal

Frequency (MHz)	Meter Reading (dBμV)	Factor (dB)	Emission Level (dBμV/m)	Limits (dBμV/m)	Margin (dB)	Detector Type
167.8242	27.86	10.59	38.45	43.5	-5.05	QP
312.1792	25.85	15.13	40.98	46	-5.02	QP
390.7225	23.69	17.78	41.47	46	-4.53	QP
721.7259	15.49	25.59	41.08	46	-4.92	QP

Remark:
Factor = Antenna Factor + Cable Loss – Pre-amplifier.

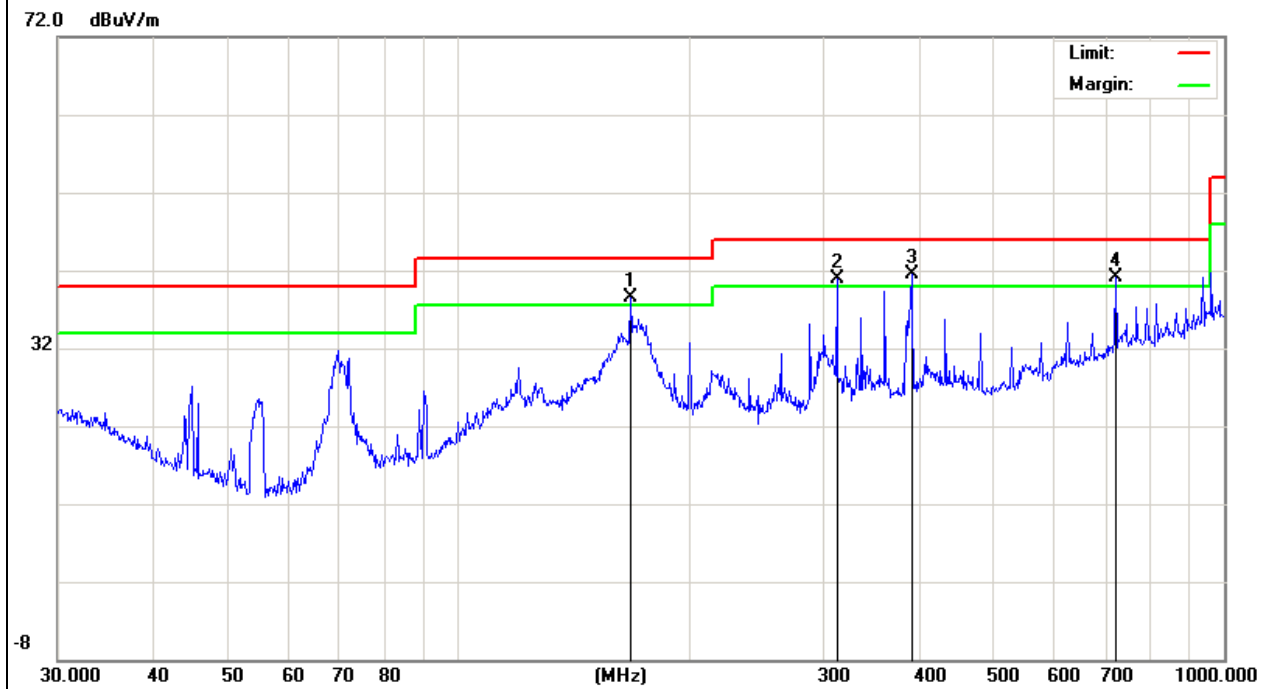

EUT :	7inch tablet	Model Name :	EGS004
Temperature :	20 °C	Relative Humidity :	48%
Pressure :	1010 hPa	Test Voltage :	DC 3.7V
Test Mode :	TX	Polarization :	Vertical

Frequency (MHz)	Meter Reading (dBμV)	Factor (dB)	Emission Level (dBμV/m)	Limits (dBμV/m)	Margin (dB)	Detector Type
33.4448	18.56	16.67	35.23	40	-4.77	QP
119.8555	25.82	12.09	37.91	43.5	-5.59	QP
167.824	24.66	10.59	35.25	43.5	-8.25	QP
721.7259	13.14	25.59	38.73	46	-7.27	QP

Remark:

Factor = Antenna Factor + Cable Loss – Pre-amplifier.

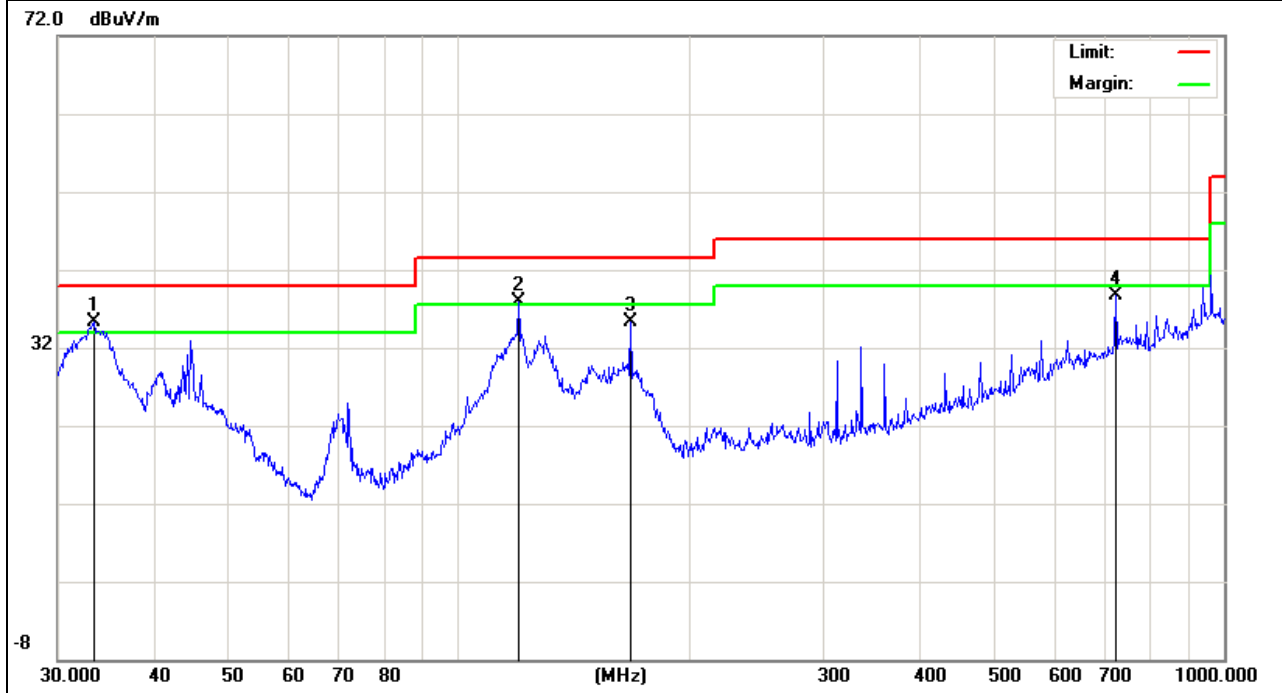

3.2.8 TEST RESULTS (ABOVE 1000 MHZ)

EUT :	7inch tablet	Model Name :	EGS004
Temperature :	20 °C	Relative Humidity :	48%
Pressure :	1010 hPa	Test Voltage :	DC 3.7V
Test Mode :	CH1 (802.11b Mode)/2412	Polarization :	Horizontal

Frequency (MHz)	Meter Reading (dBμV)	Factor (dB)	Emission Level (dBμV/m)	Limits (dBμV/m)	Margin (dB)	Detector Type
4824.133	51.19	10.44	61.63	74	-12.37	peak
4824.133	33.3	10.44	43.74	54	-10.26	AVG
7236.152	44.23	12.39	56.62	74	-17.38	peak
7236.152	28.99	12.39	41.38	54	-12.62	AVG

Remark:
Factor = Antenna Factor + Cable Loss – Pre-amplifier.

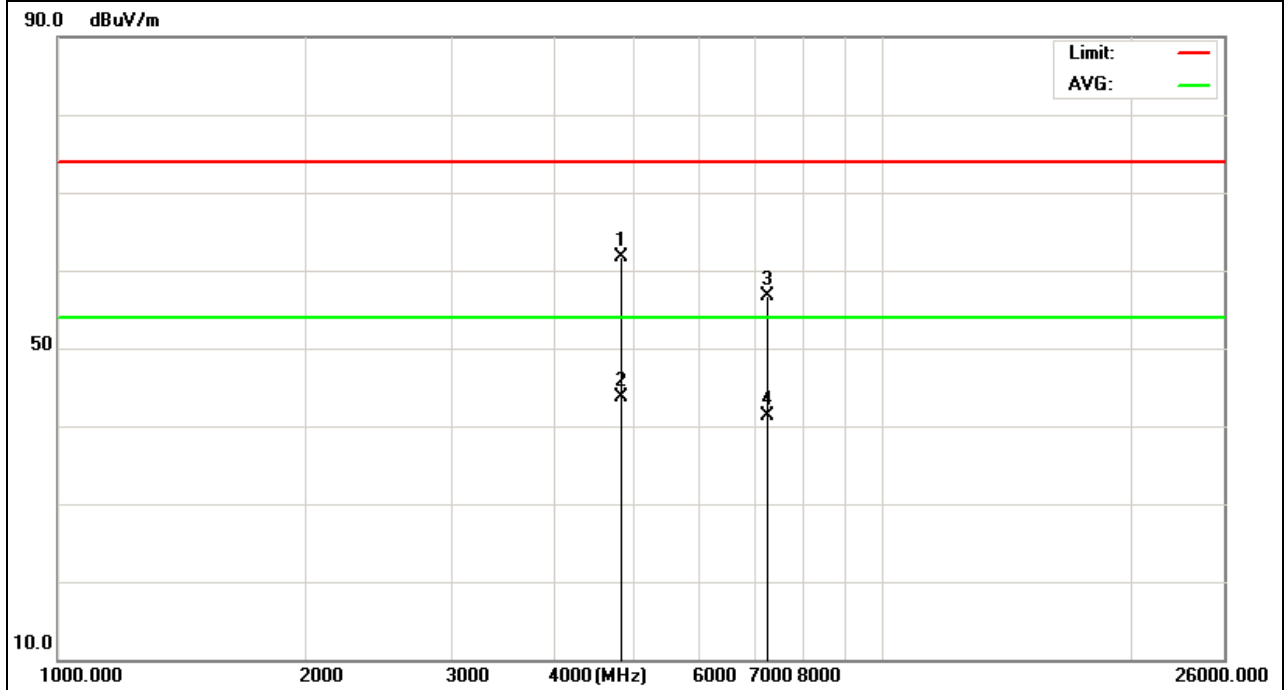

EUT :	7inch tablet	Model Name :	EGS004
Temperature :	20 °C	Relative Humidity :	48%
Pressure :	1010 hPa	Test Voltage :	DC 3.7V
Test Mode :	CH1 (802.11b Mode)/2412	Polarization :	Vertical

Frequency (MHz)	Meter Reading (dBμV)	Factor (dB)	Emission Level (dBμV/m)	Limits (dBμV/m)	Margin (dB)	Detector Type
4874.167	51.29	10.4	61.69	74	-12.31	peak
4874.167	32.44	10.4	42.84	54	-11.16	AVG
7311.158	42.56	12.75	55.31	74	-18.69	peak
7311.158	27.52	12.75	40.27	54	-13.73	AVG

Remark:
 Factor = Antenna Factor + Cable Loss – Pre-amplifier.

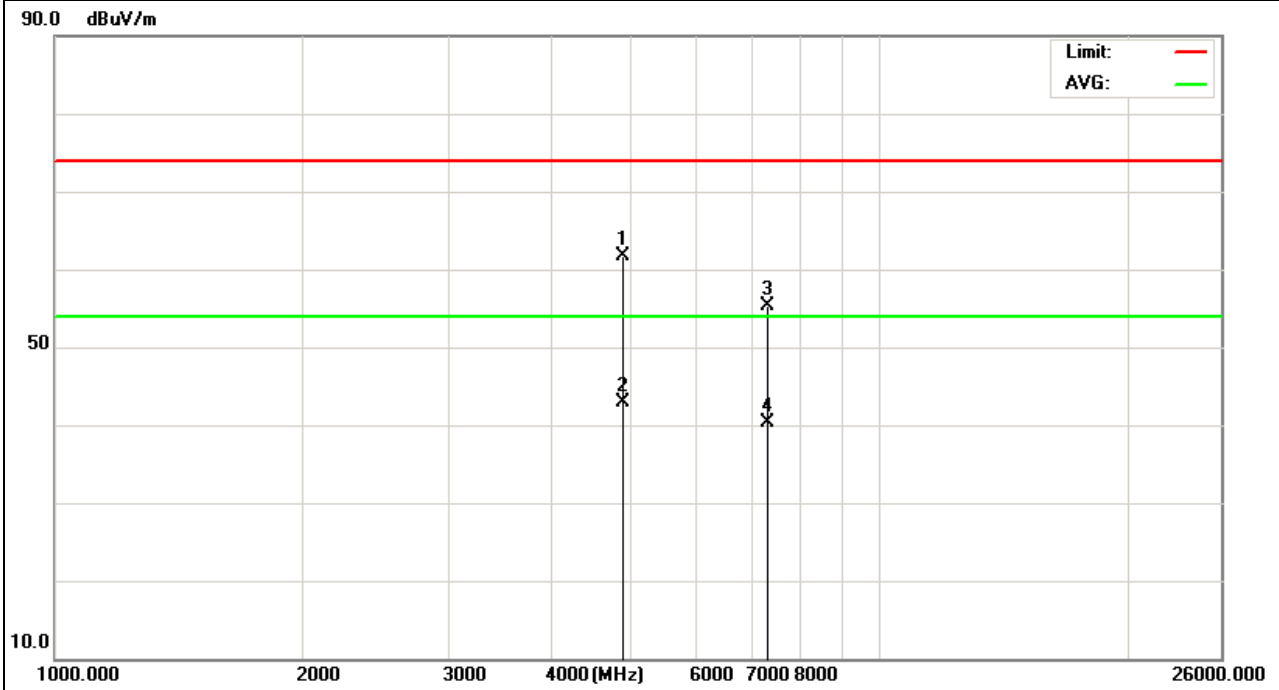

EUT :	7inch tablet	Model Name :	EGS004
Temperature :	20 °C	Relative Humidity :	48%
Pressure :	1010 hPa	Test Voltage :	DC 3.7V
Test Mode :	CH6 (802.11b Mode)/2437	Polarization :	Horizontal

Frequency (MHz)	Meter Reading (dBμV)	Factor (dB)	Emission Level (dBμV/m)	Limits (dBμV/m)	Margin (dB)	Detector Type
4874.149	50.18	10.4	60.58	74	-13.42	peak
4874.149	33.2	10.4	43.6	54	-10.4	AVG
7311.126	42.42	12.75	55.17	74	-18.83	peak
7311.126	27.53	12.75	40.28	54	-13.72	AVG

Remark:
Factor = Antenna Factor + Cable Loss – Pre-amplifier.

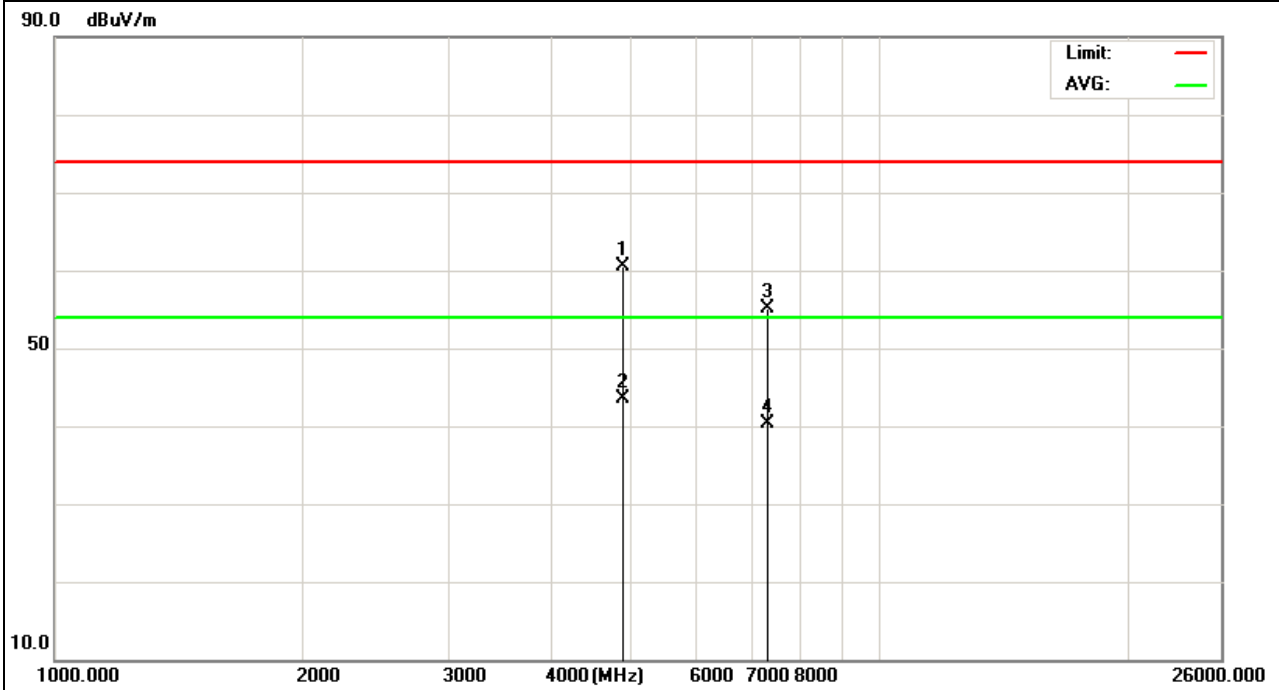

EUT :	7inch tablet	Model Name :	EGS004
Temperature :	20 °C	Relative Humidity :	48%
Pressure :	1010 hPa	Test Voltage :	DC 3.7V
Test Mode :	CH6 (802.11b Mode)/2437	Polarization :	Vertical

Frequency (MHz)	Meter Reading (dBμV)	Factor (dB)	Emission Level (dBμV/m)	Limits (dBμV/m)	Margin (dB)	Detector Type
4924.164	52.23	10.39	62.62	74	-11.38	peak
4934.164	33.13	10.44	43.57	54	-10.43	AVG
7386.122	42.8	12.68	55.48	74	-18.52	peak
7386.122	28.67	12.68	41.35	54	-12.65	AVG

Remark:

- Factor = Antenna Factor + Cable Loss – Pre-amplifier.
- No emission detected above 18GHz

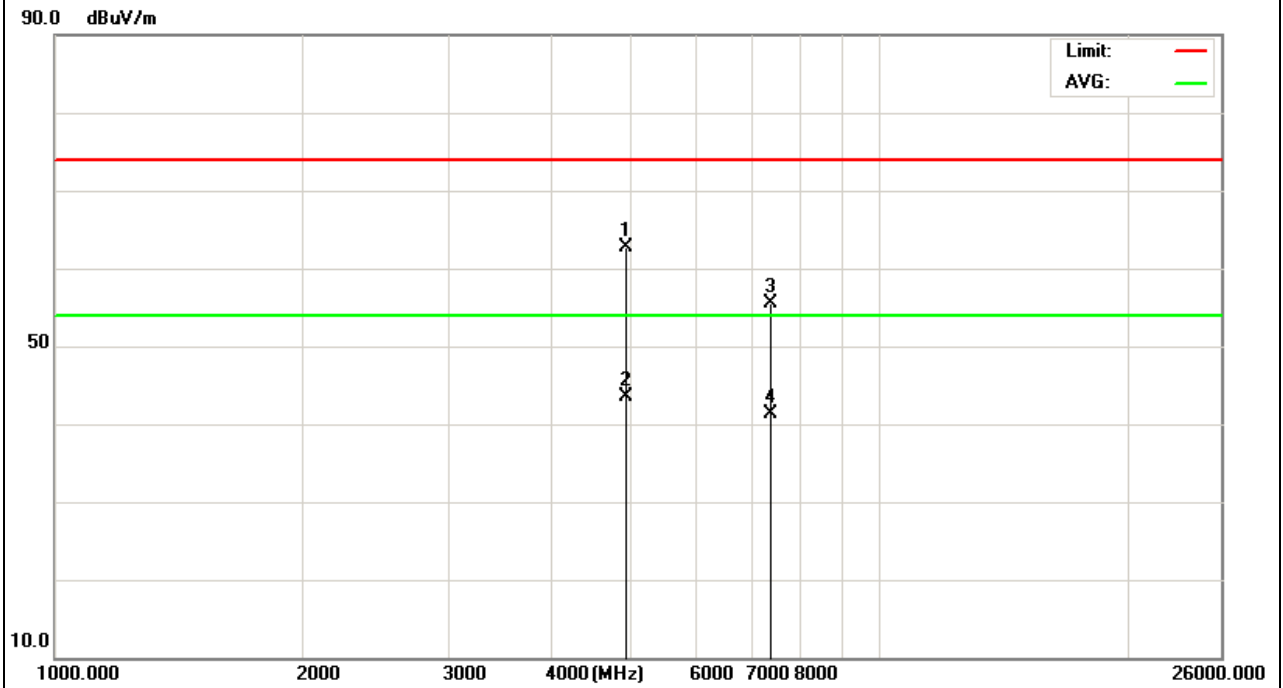

EUT :	7inch tablet	Model Name :	EGS004
Temperature :	20 °C	Relative Humidity :	48%
Pressure :	1010 hPa	Test Voltage :	DC 3.7V
Test Mode :	CH11 (802.11b Mode)/2462	Polarization :	Horizontal

Frequency (MHz)	Meter Reading (dBμV)	Factor (dB)	Emission Level (dBμV/m)	Limits (dBμV/m)	Margin (dB)	Detector Type
4924.142	51.15	10.39	61.54	74	-12.46	peak
4924.142	32.98	10.39	43.37	54	-10.63	AVG
7386.138	42.54	12.68	55.22	74	-18.78	peak
7386.138	27.95	12.68	40.63	54	-13.37	AVG

Remark:

- Factor = Antenna Factor + Cable Loss – Pre-amplifier.
- No emission detected above 18GHz

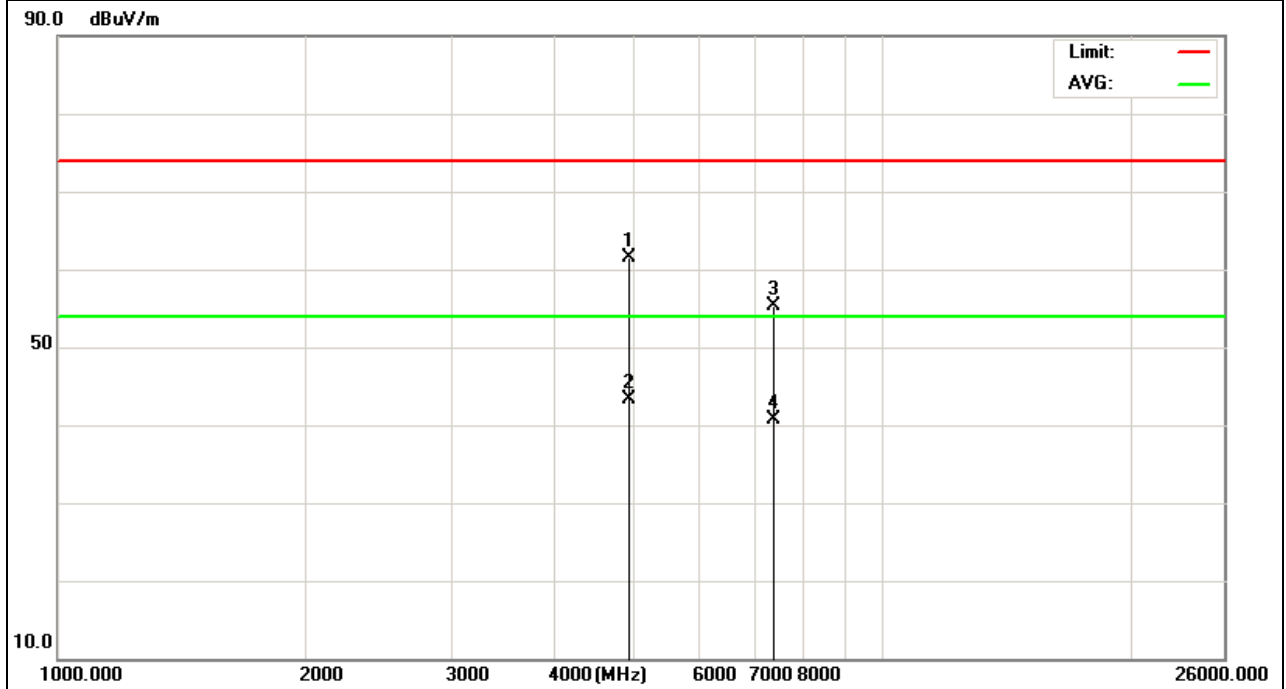

EUT :	7inch tablet	Model Name :	EGS004
Temperature :	20 °C	Relative Humidity :	48%
Pressure :	1010 hPa	Test Voltage :	DC 3.7V
Test Mode :	CH11 (802.11b Mode)/2462	Polarization :	Vertical

Frequency (MHz)	Meter Reading (dBμV)	Factor (dB)	Emission Level (dBμV/m)	Limits (dBμV/m)	Margin (dB)	Detector Type
4924.118	51.77	10.39	62.16	74	-11.84	peak
4924.118	31.96	10.39	42.35	54	-11.65	AVG
7386.14	42.76	12.68	55.44	74	-18.56	peak
7386.14	28.04	12.68	40.72	54	-13.28	AVG

Remark:
Factor = Antenna Factor + Cable Loss – Pre-amplifier.

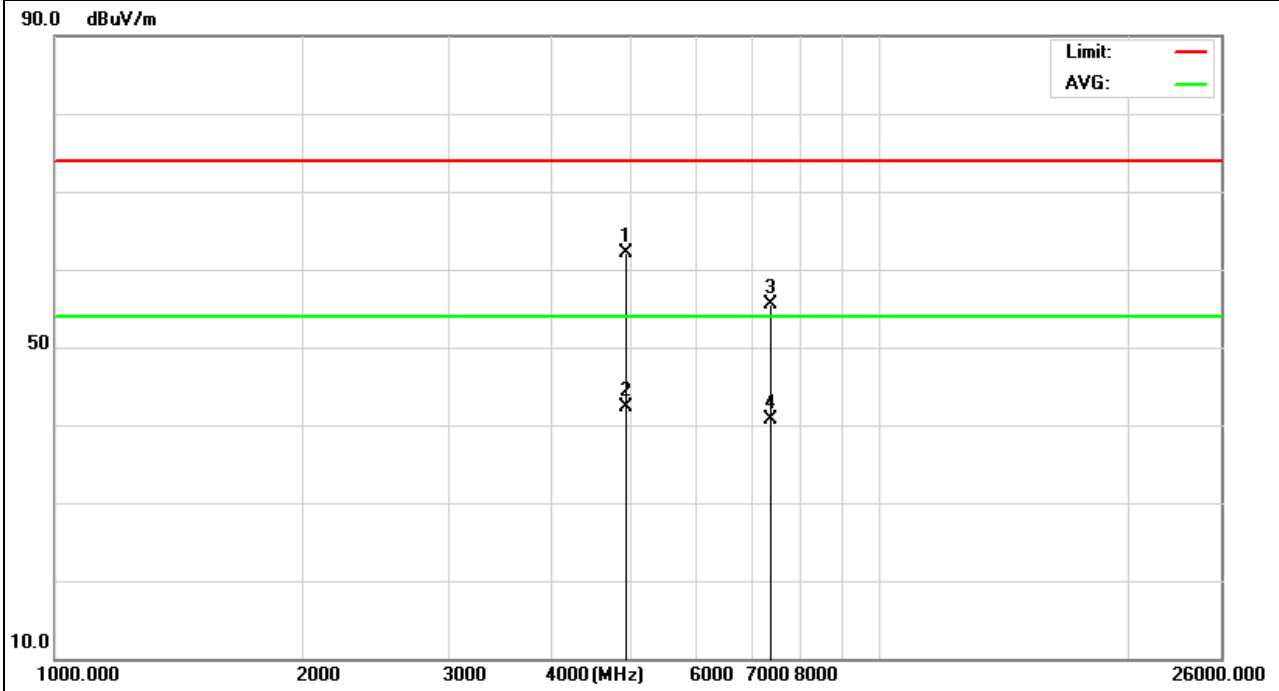

EUT :	7inch tablet	Model Name :	EGS004
Temperature :	20 °C	Relative Humidity :	48%
Pressure :	1010 hPa	Test Voltage :	DC 3.7V
Test Mode :	CH1 (802.11g Mode)/2412	Polarization :	Horizontal

Frequency (MHz)	Meter Reading (dBμV)	Factor (dB)	Emission Level (dBμV/m)	Limits (dBμV/m)	Margin (dB)	Detector Type
4824.165	46.92	10.44	57.36	74	-16.64	peak
4824.165	31.1	10.44	41.54	54	-12.46	AVG
7236.121	40.84	12.39	53.23	74	-20.77	peak
7236.121	26.06	12.39	38.45	54	-15.55	AVG

Remark:
Factor = Antenna Factor + Cable Loss – Pre-amplifier.

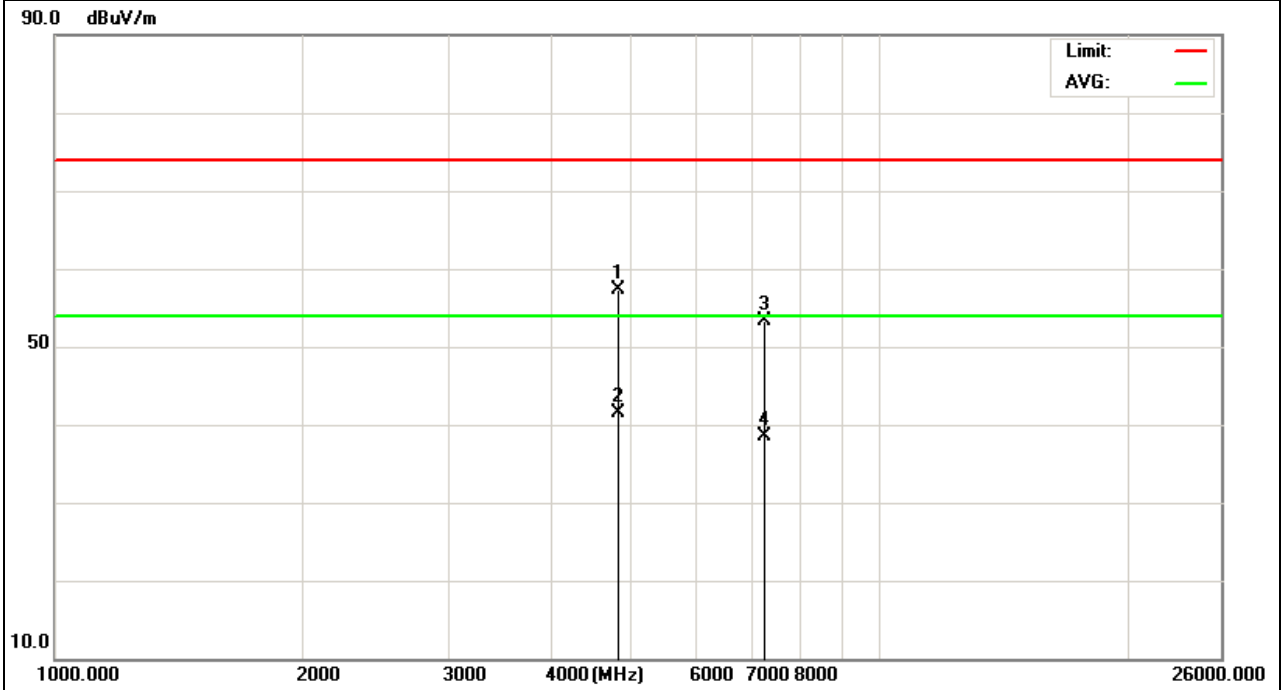

EUT :	7inch tablet	Model Name :	EGS004
Temperature :	20 °C	Relative Humidity :	48%
Pressure :	1010 hPa	Test Voltage :	DC 3.7V
Test Mode :	CH1 (802.11g Mode)/2412	Polarization :	Vertical

Frequency (MHz)	Meter Reading (dBμV)	Factor (dB)	Emission Level (dBμV/m)	Limits (dBμV/m)	Margin (dB)	Detector Type
4824.154	48.01	10.44	58.45	74	-15.55	peak
4824.154	32.08	10.44	42.52	54	-11.48	AVG
7236.138	41.93	12.39	54.32	74	-19.68	peak
7236.138	27.95	12.39	40.34	54	-13.66	AVG

Remark:
Factor = Antenna Factor + Cable Loss – Pre-amplifier.

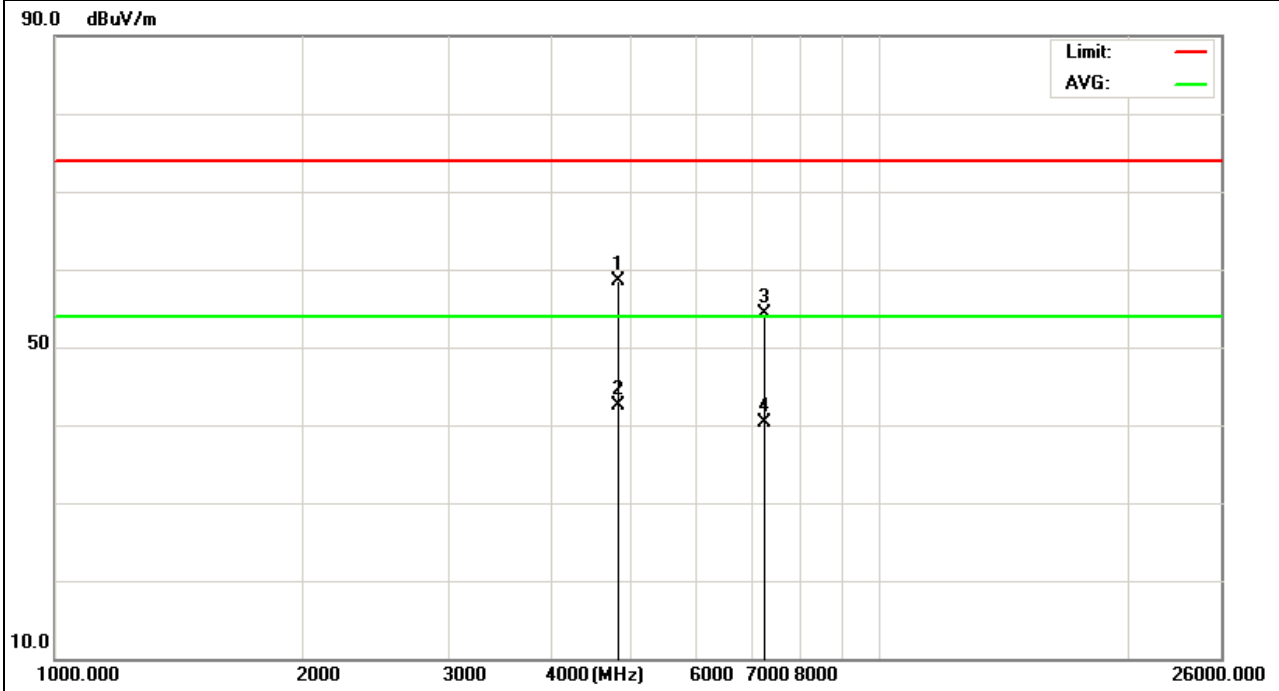

EUT :	7inch tablet	Model Name :	EGS004
Temperature :	20 °C	Relative Humidity :	48%
Pressure :	1010 hPa	Test Voltage :	DC 3.7V
Test Mode :	CH6 (802.11g Mode)/2437	Polarization :	Horizontal

Frequency (MHz)	Meter Reading (dBμV)	Factor (dB)	Emission Level (dBμV/m)	Limits (dBμV/m)	Margin (dB)	Detector Type
4874.13	48.15	10.4	58.55	74	-15.45	peak
4874.13	31.58	10.4	41.98	54	-12.02	AVG
7311.168	41.84	12.75	54.59	74	-19.41	peak
7311.168	27.12	12.75	39.87	54	-14.13	AVG

Remark:
 Factor = Antenna Factor + Cable Loss – Pre-amplifier.

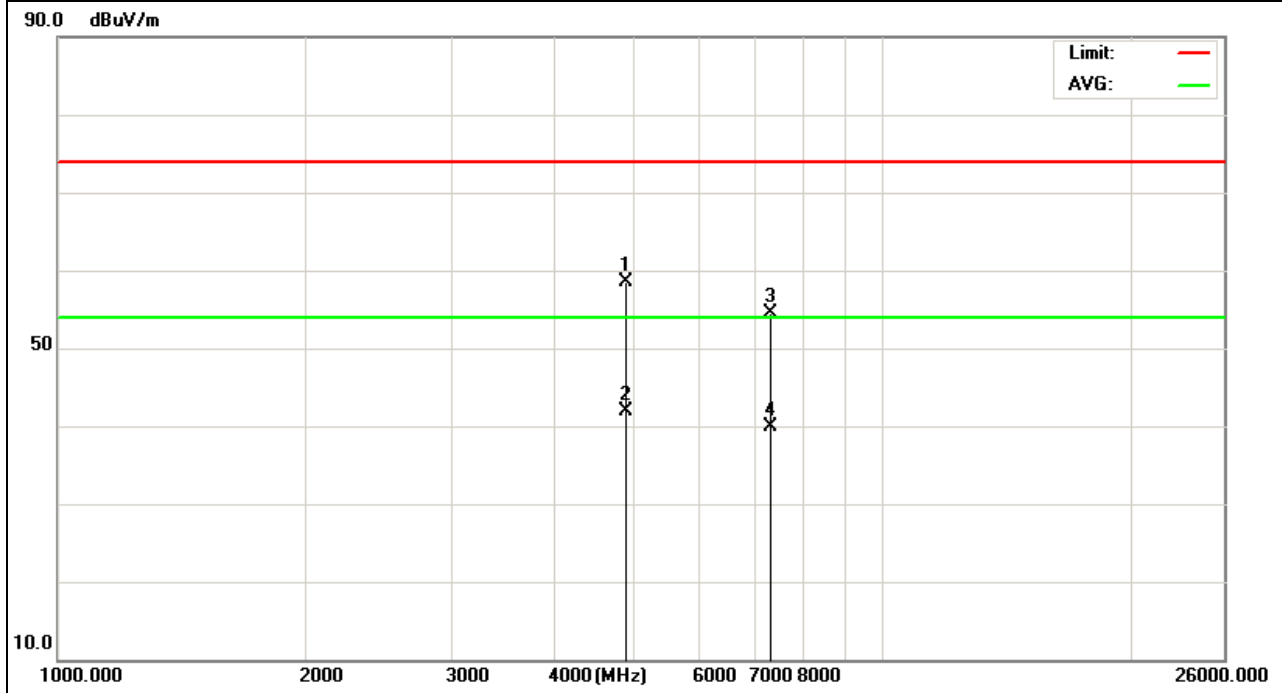

EUT :	7inch tablet	Model Name :	EGS004
Temperature :	20 °C	Relative Humidity :	48%
Pressure :	1010 hPa	Test Voltage :	DC 3.7V
Test Mode :	CH6 (802.11g Mode)/2437	Polarization :	Vertical

Frequency (MHz)	Meter Reading (dBμV)	Factor (dB)	Emission Level (dBμV/m)	Limits (dBμV/m)	Margin (dB)	Detector Type
4874.164	48.3	10.4	58.7	74	-15.3	peak
4874.164	32.18	10.4	42.58	54	-11.42	AVG
7311.125	42.79	12.75	55.54	74	-18.46	peak
7311.125	28.03	12.75	40.78	54	-13.22	AVG

Remark:
 Factor = Antenna Factor + Cable Loss – Pre-amplifier.

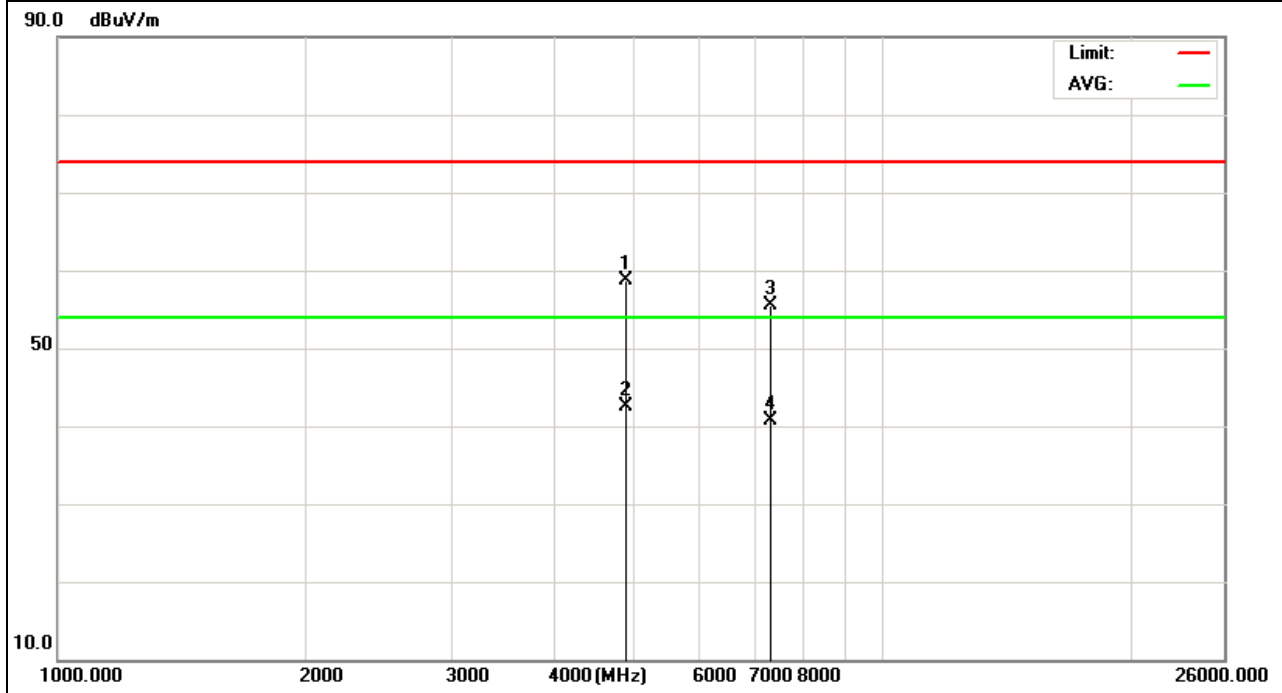

EUT :	7inch tablet	Model Name :	EGS004
Temperature :	20 °C	Relative Humidity :	48%
Pressure :	1010 hPa	Test Voltage :	DC 3.7V
Test Mode :	CH11 (802.11g Mode)/2462	Polarization :	Horizontal

Frequency (MHz)	Meter Reading (dBμV)	Factor (dB)	Emission Level (dBμV/m)	Limits (dBμV/m)	Margin (dB)	Detector Type
4924.134	48.28	10.39	58.67	74	-15.33	peak
4924.134	33.13	10.39	43.52	54	-10.48	AVG
7386.142	42.66	12.68	55.34	74	-18.66	peak
7386.142	28.13	12.68	40.81	54	-13.19	AVG

Remark:
Factor = Antenna Factor + Cable Loss – Pre-amplifier.

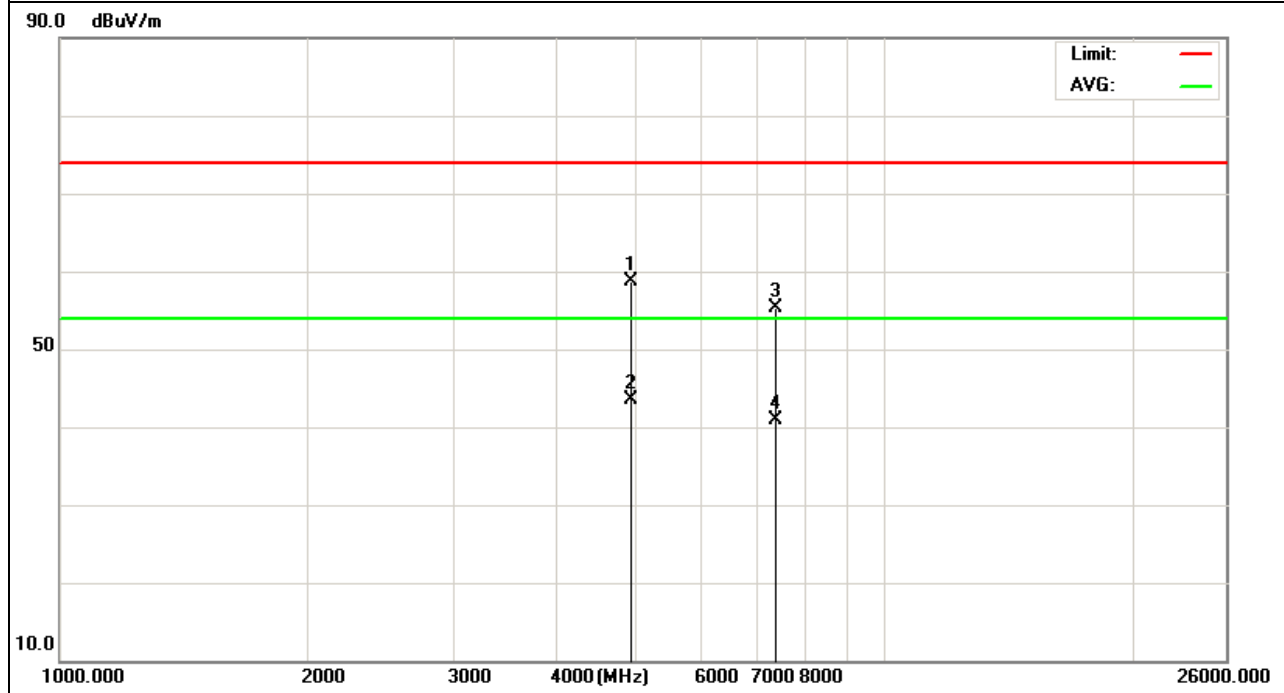

EUT :	7inch tablet	Model Name :	EGS004
Temperature :	20 °C	Relative Humidity :	48%
Pressure :	1010 hPa	Test Voltage :	DC 3.7V
Test Mode :	CH11(802.11g Mode)/2462	Polarization :	Vertical

Frequency (MHz)	Meter Reading (dBμV)	Factor (dB)	Emission Level (dBμV/m)	Limits (dBμV/m)	Margin (dB)	Detector Type
4924.146	47.13	10.39	57.52	74	-16.48	peak
4924.146	31.96	10.39	42.35	54	-11.65	AVG
7386.125	41.98	12.68	54.66	74	-19.34	peak
7386.125	27.85	12.68	40.53	54	-13.47	AVG

Remark:
 Factor = Antenna Factor + Cable Loss – Pre-amplifier.

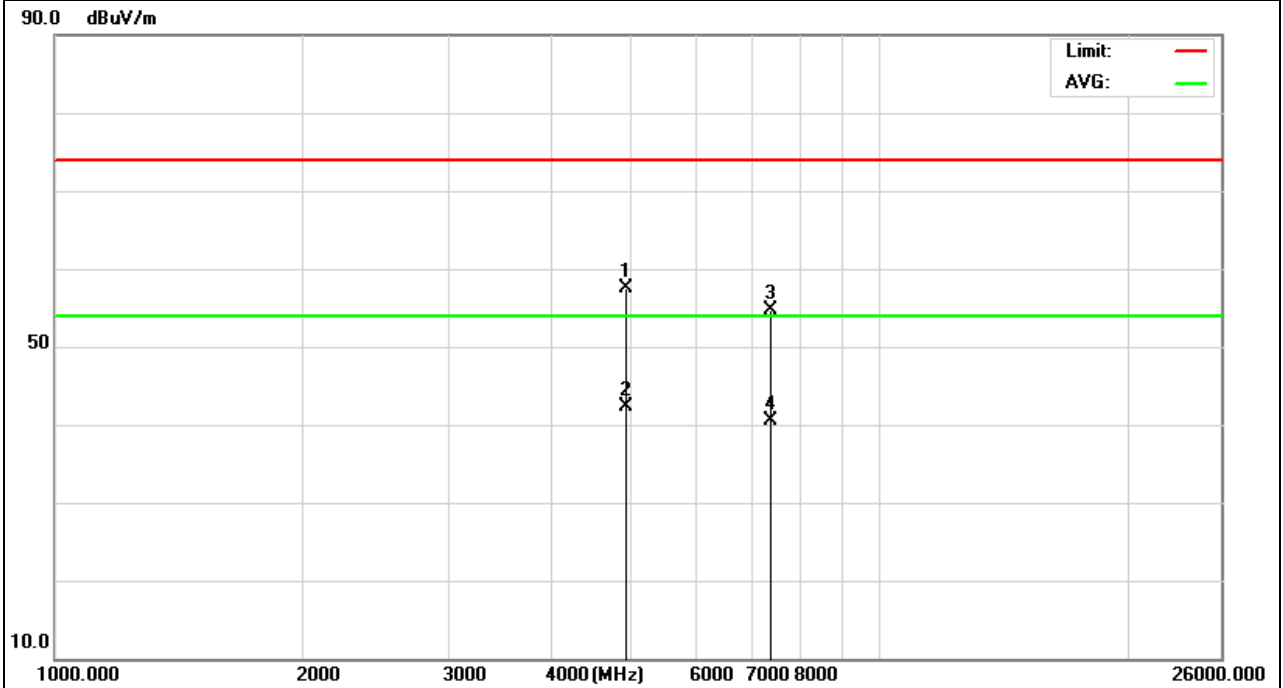

EUT :	7inch tablet	Model Name :	EGS004
Temperature :	20 °C	Relative Humidity :	48%
Pressure :	1010 hPa	Test Voltage :	DC 3.7V
Test Mode :	CH1(802.11n Mode)/2412	Polarization :	Horizontal

Frequency (MHz)	Meter Reading (dBμV)	Factor (dB)	Emission Level (dBμV/m)	Limits (dBμV/m)	Margin (dB)	Detector Type
4824.137	49.02	10.44	59.46	74	-14.54	peak
4824.137	33.1	10.44	43.54	54	-10.46	AVG
7236.125	41.48	12.39	53.87	74	-20.13	peak
7236.125	29.4	12.39	41.79	54	-12.21	AVG

Remark:
 Factor = Antenna Factor + Cable Loss – Pre-amplifier.

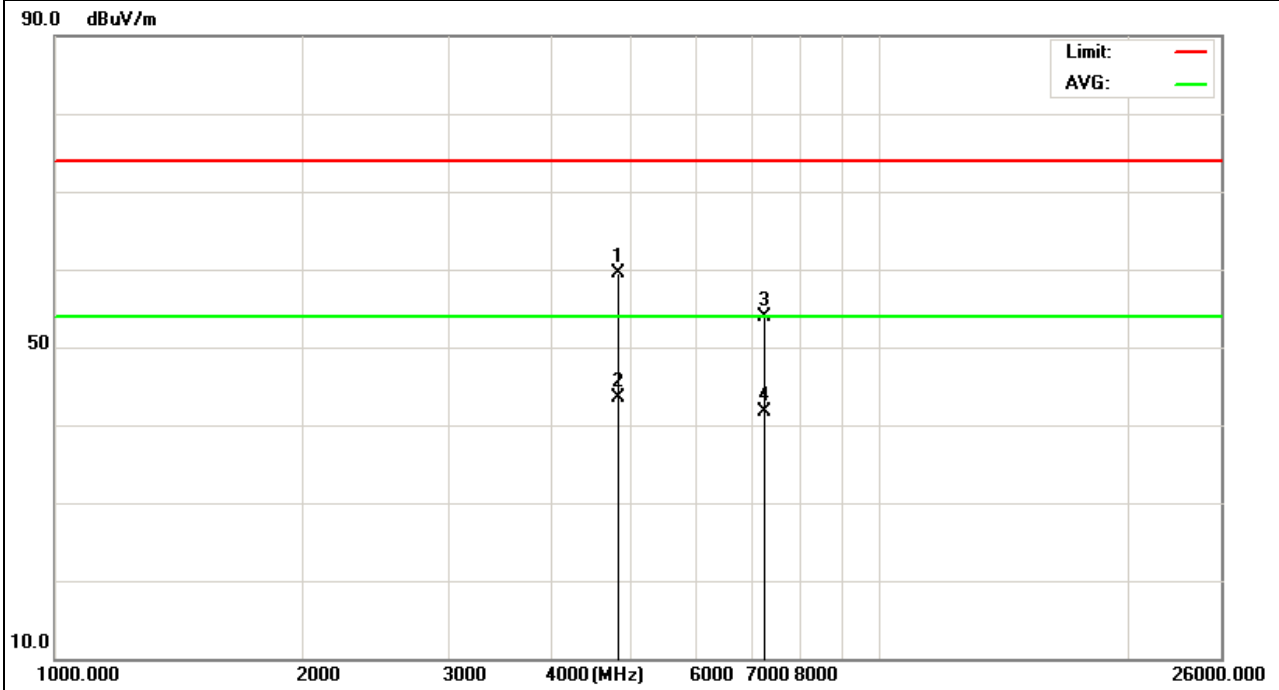

EUT :	7inch tablet	Model Name :	EGS004
Temperature :	20 °C	Relative Humidity :	48%
Pressure :	1010 hPa	Test Voltage :	DC 3.7V
Test Mode :	CH1(802.11n Mode)/2412	Polarization :	Vertical

Frequency (MHz)	Meter Reading (dBμV)	Factor (dB)	Emission Level (dBμV/m)	Limits (dBμV/m)	Margin (dB)	Detector Type
4824.158	48.33	10.44	58.77	74	-15.23	peak
4824.158	32.02	10.44	42.46	54	-11.54	AVG
7236.144	42.19	12.39	54.58	74	-19.42	peak
7236.144	28.11	12.39	40.5	54	-13.5	AVG

Remark:
Factor = Antenna Factor + Cable Loss – Pre-amplifier.

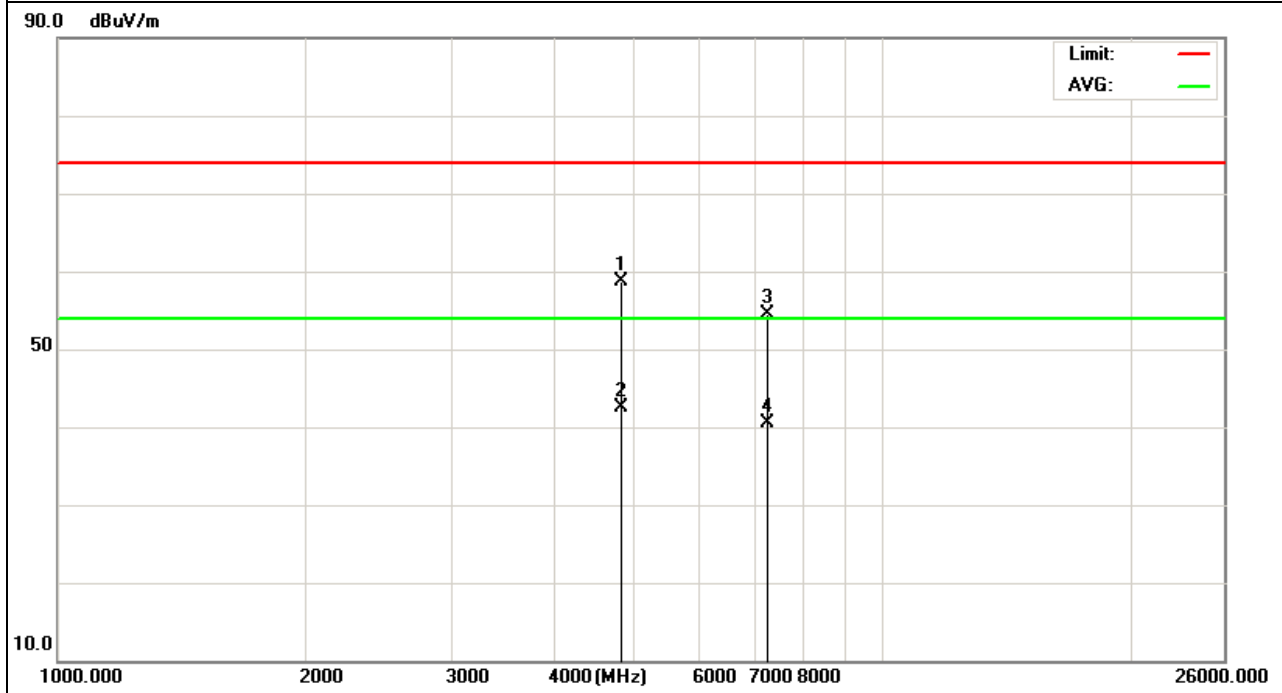

EUT :	7inch tablet	Model Name :	EGS004
Temperature :	20 °C	Relative Humidity :	48%
Pressure :	1010 hPa	Test Voltage :	DC 3.7V
Test Mode :	CH6(802.11n Mode)/2437	Polarization :	Horizontal

Frequency (MHz)	Meter Reading (dBμV)	Factor (dB)	Emission Level (dBμV/m)	Limits (dBμV/m)	Margin (dB)	Detector Type
4874.154	48.35	10.4	58.75	74	-15.25	peak
4874.154	31.16	10.4	41.56	54	-12.44	AVG
7311.176	41.71	12.75	54.46	74	-19.54	peak
7311.176	26.89	12.75	39.64	54	-14.36	AVG

Remark:
Factor = Antenna Factor + Cable Loss – Pre-amplifier.

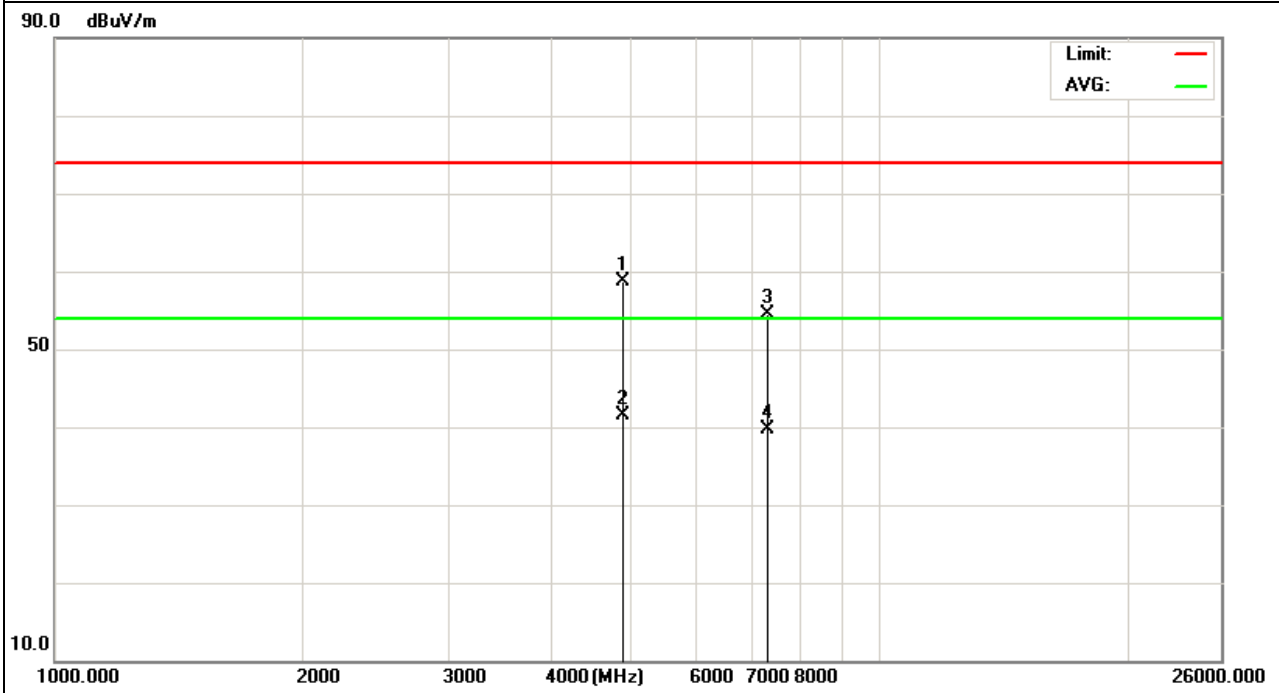

EUT :	7inch tablet	Model Name :	EGS004
Temperature :	20 °C	Relative Humidity :	48%
Pressure :	1010 hPa	Test Voltage :	DC 3.7V
Test Mode :	CH6(802.11n Mode)/2437	Polarization :	Vertical

Frequency (MHz)	Meter Reading (dBμV)	Factor (dB)	Emission Level (dBμV/m)	Limits (dBμV/m)	Margin (dB)	Detector Type
4874.155	47.86	10.4	58.26	74	-15.74	peak
4874.155	31.28	10.4	41.68	54	-12.32	AVG
7311.163	41.73	12.75	54.48	74	-19.52	peak
7311.163	26.82	12.75	39.57	54	-14.43	AVG

Remark:
 Factor = Antenna Factor + Cable Loss – Pre-amplifier.

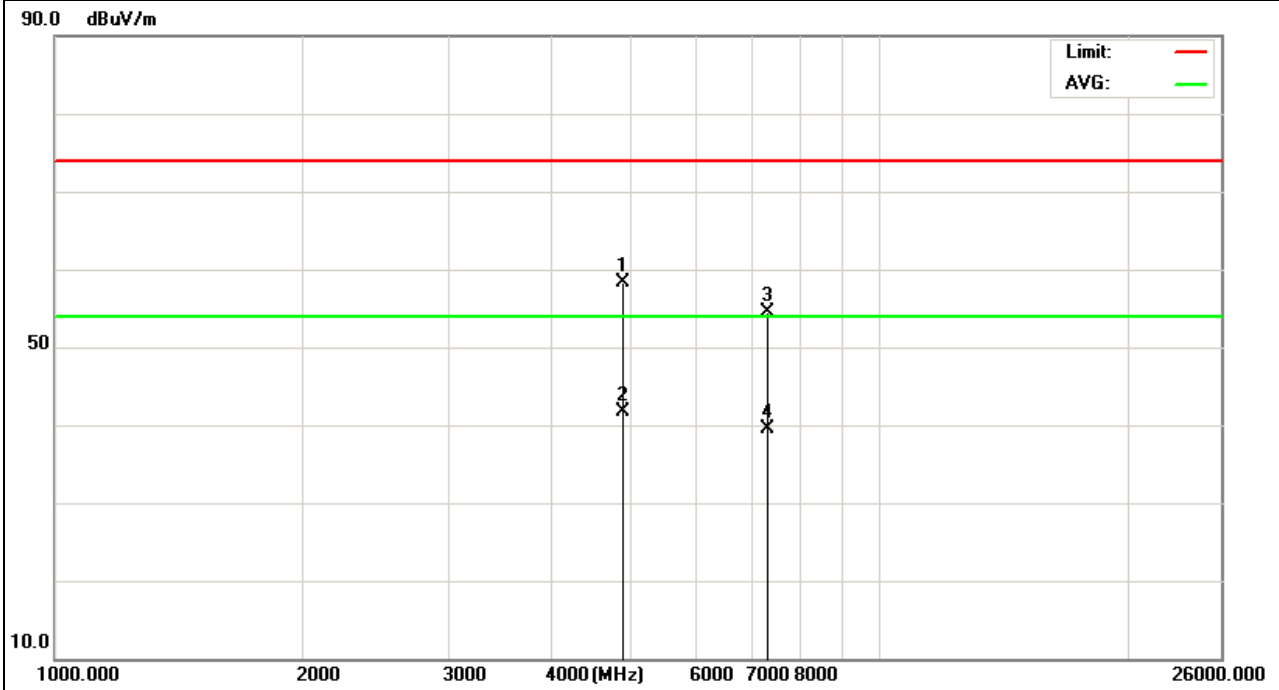

EUT :	7inch tablet	Model Name :	EGS004
Temperature :	20 °C	Relative Humidity :	48%
Pressure :	1010 hPa	Test Voltage :	DC 3.7V
Test Mode :	CH11(802.11n Mode)/2462	Polarization :	Horizontal

Frequency (MHz)	Meter Reading (dBμV)	Factor (dB)	Emission Level (dBμV/m)	Limits (dBμV/m)	Margin (dB)	Detector Type
4924.135	49.07	10.39	59.46	74	-14.54	peak
4924.135	31.19	10.39	41.58	54	-12.42	AVG
7386.174	42.12	12.68	54.8	74	-19.2	peak
7386.174	26.69	12.68	39.37	54	-14.63	AVG

Remark:
 Factor = Antenna Factor + Cable Loss – Pre-amplifier.

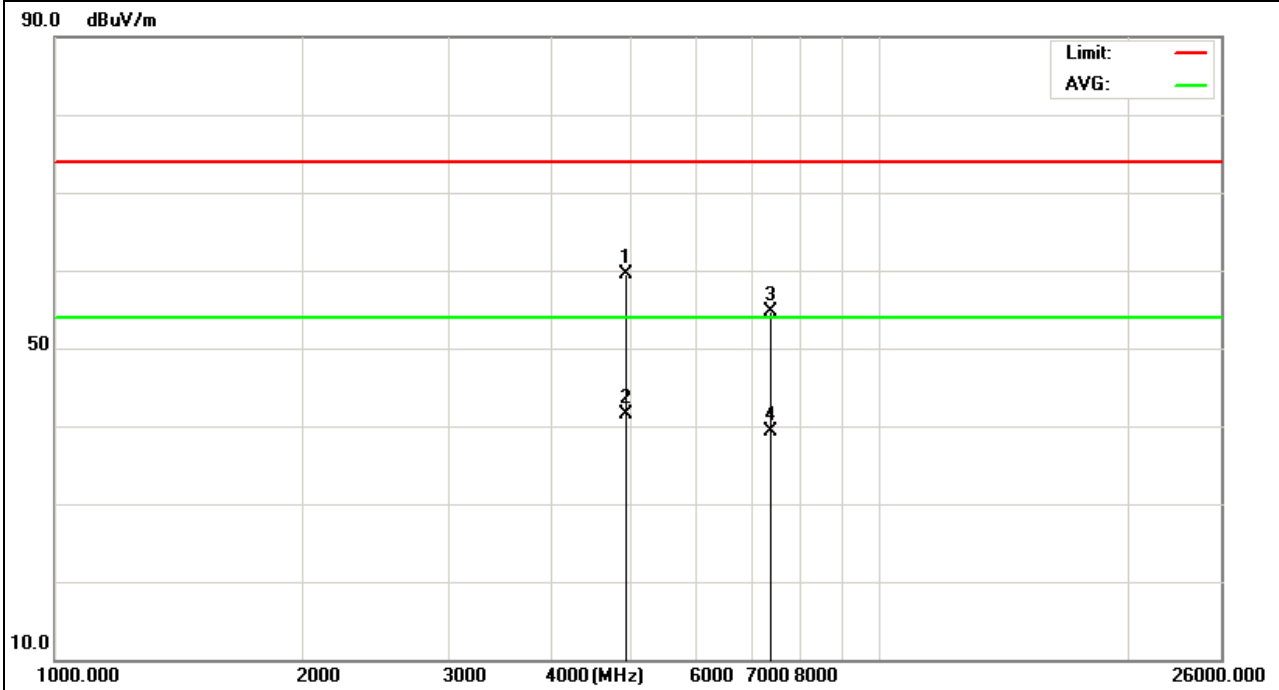

EUT :	7inch tablet	Model Name :	EGS004
Temperature :	20 °C	Relative Humidity :	48%
Pressure :	1010 hPa	Test Voltage :	DC 3.7V
Test Mode :	CH11(802.11n Mode)/2462	Polarization :	Vertical

Frequency (MHz)	Meter Reading (dBμV)	Factor (dB)	Emission Level (dBμV/m)	Limits (dBμV/m)	Margin (dB)	Detector Type
4924.142	49.33	10.39	59.72	74	-14.28	peak
4924.142	32.27	10.39	42.66	54	-11.34	AVG
7386.168	43.91	12.68	56.59	74	-17.41	peak
7386.168	28.29	12.68	40.97	54	-13.03	AVG

Remark:
 Factor = Antenna Factor + Cable Loss – Pre-amplifier.

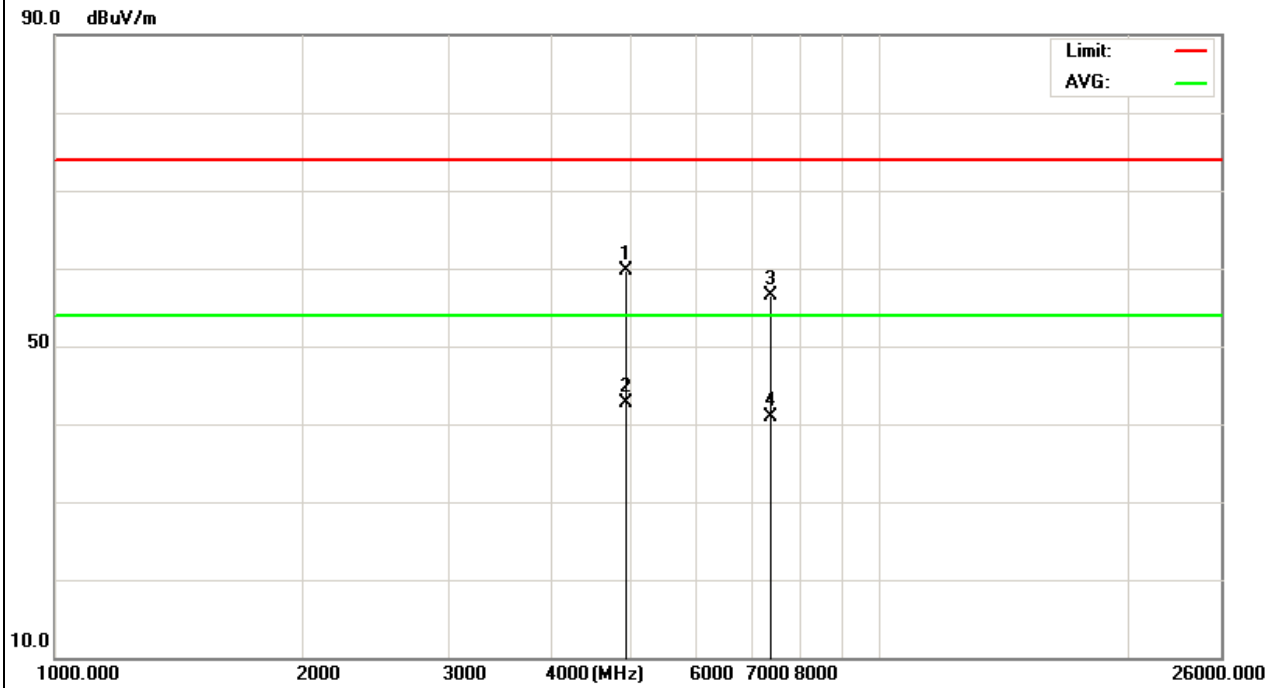

EUT :	7inch tablet	Model Name :	EGS004
Temperature :	20 °C	Relative Humidity :	48%
Pressure :	1010 hPa	Test Voltage :	DC 3.7V
Test Mode :	CH1(802.11b Mode)	Polarization :	Horizontal

Frequency (MHz)	Meter Reading (dBμV)	Factor (dB)	Emission Level (dBμV/m)	Limits (dBμV/m)	Margin (dB)	Detector Type
2400	83.19	-12.99	70.2	74	-3.8	peak
2400	59.3	-12.99	46.31	54	-7.69	AVG

Remark:
 Factor = Antenna Factor + Cable Loss – Pre-amplifier.

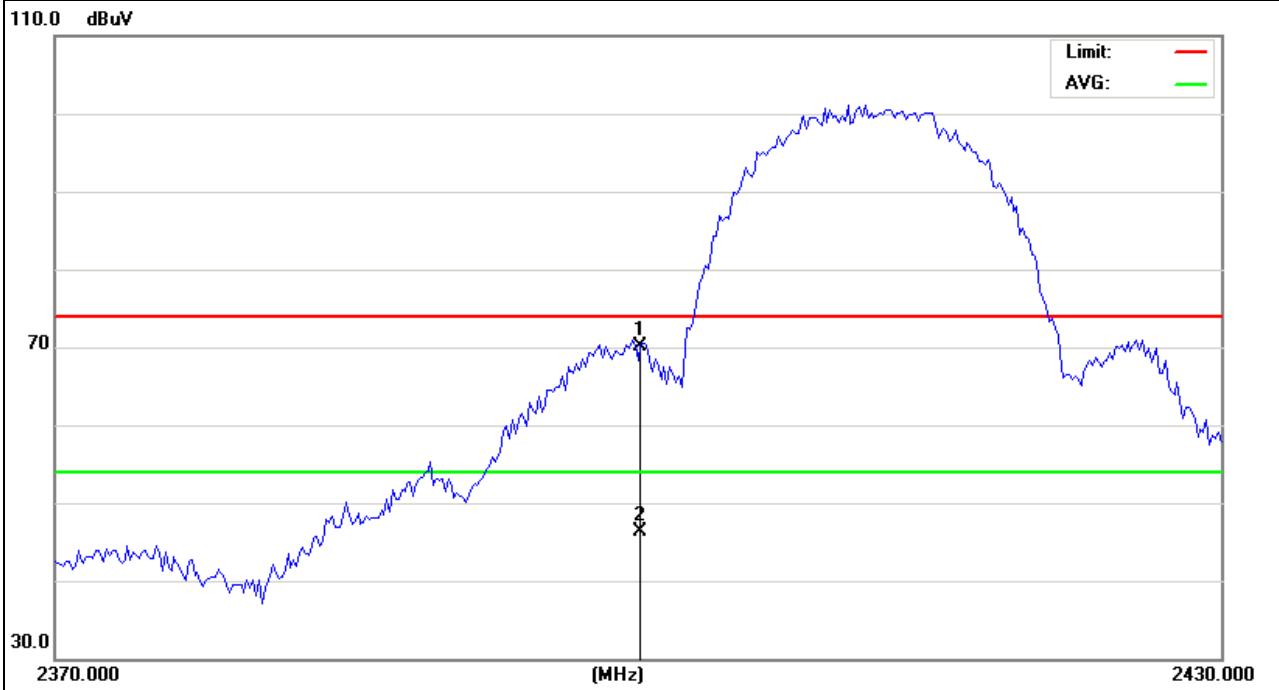

EUT :	7inch tablet	Model Name :	EGS004
Temperature :	20 °C	Relative Humidity :	48%
Pressure :	1010 hPa	Test Voltage :	DC 3.7V
Test Mode :	CH1(802.11b Mode)	Polarization :	Vertical

Frequency (MHz)	Meter Reading (dBμV)	Factor (dB)	Emission Level (dBμV/m)	Limits (dBμV/m)	Margin (dB)	Detector Type
2400	82.29	-12.99	69.3	74	-4.7	peak
2400	58.96	-12.99	45.97	54	-8.03	AVG

Remark:
Factor = Antenna Factor + Cable Loss – Pre-amplifier.

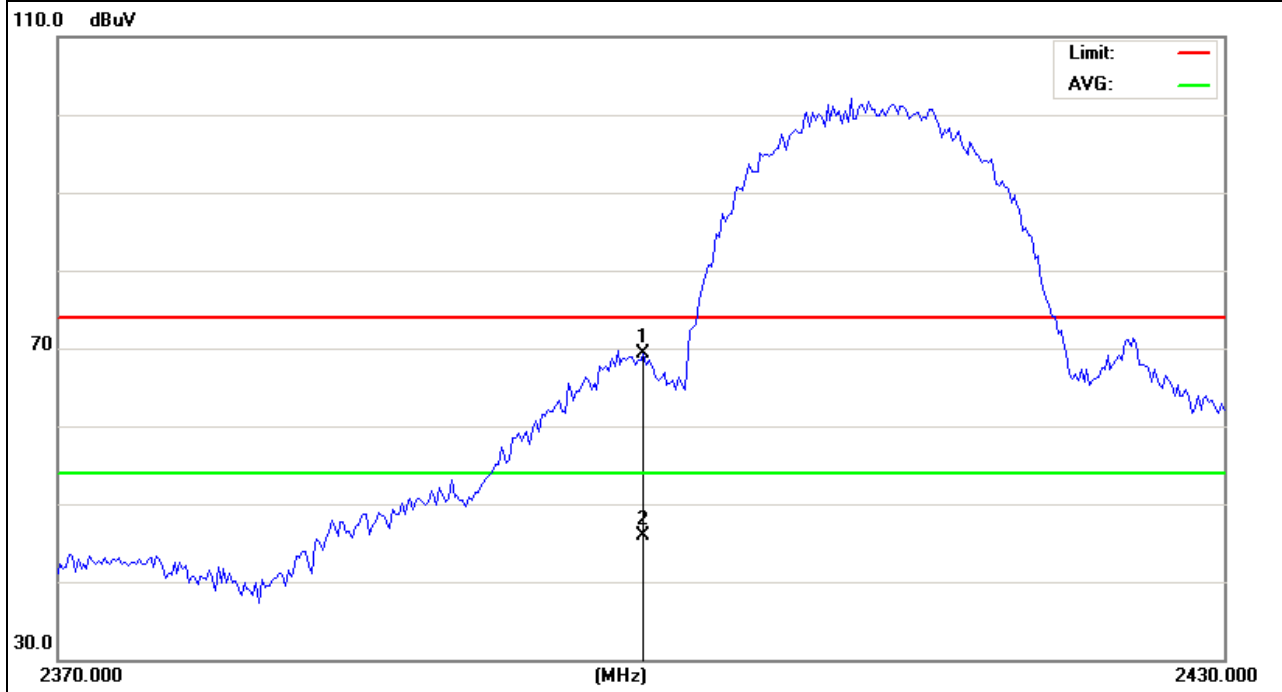

EUT :	7inch tablet	Model Name :	EGS004
Temperature :	20 °C	Relative Humidity :	48%
Pressure :	1010 hPa	Test Voltage :	DC 3.7V
Test Mode :	CH11(802.11b Mode)	Polarization :	Horizontal

Frequency (MHz)	Meter Reading (dBμV)	Factor (dB)	Emission Level (dBμV/m)	Limits (dBμV/m)	Margin (dB)	Detector Type
2483.5	61.68	-12.78	48.9	74	-25.1	peak

Remark:
Factor = Antenna Factor + Cable Loss – Pre-amplifier.

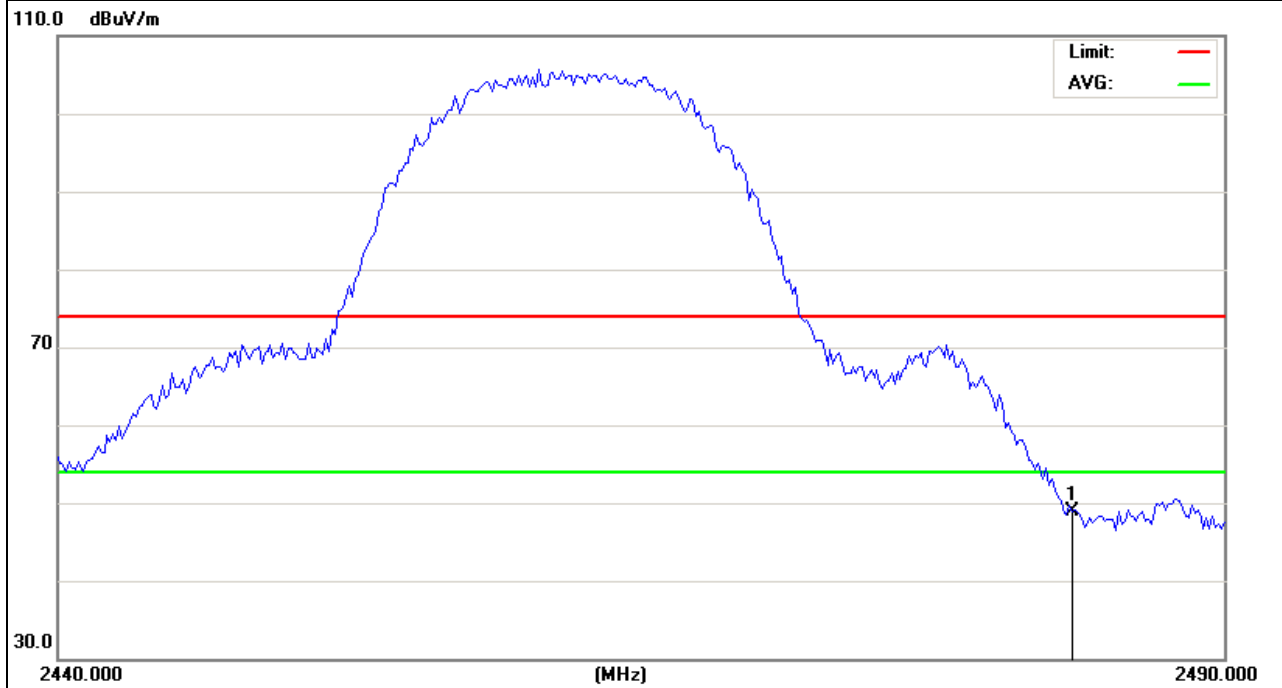

EUT :	7inch tablet	Model Name :	EGS004
Temperature :	20 °C	Relative Humidity :	48%
Pressure :	1010 hPa	Test Voltage :	DC 3.7V
Test Mode :	CH11(802.11b Mode)	Polarization :	Vertical

Frequency (MHz)	Meter Reading (dBμV)	Factor (dB)	Emission Level (dBμV/m)	Limits (dBμV/m)	Margin (dB)	Detector Type
2483.5	62.18	-12.78	49.4	74	-24.6	peak

Remark:
Factor = Antenna Factor + Cable Loss – Pre-amplifier.

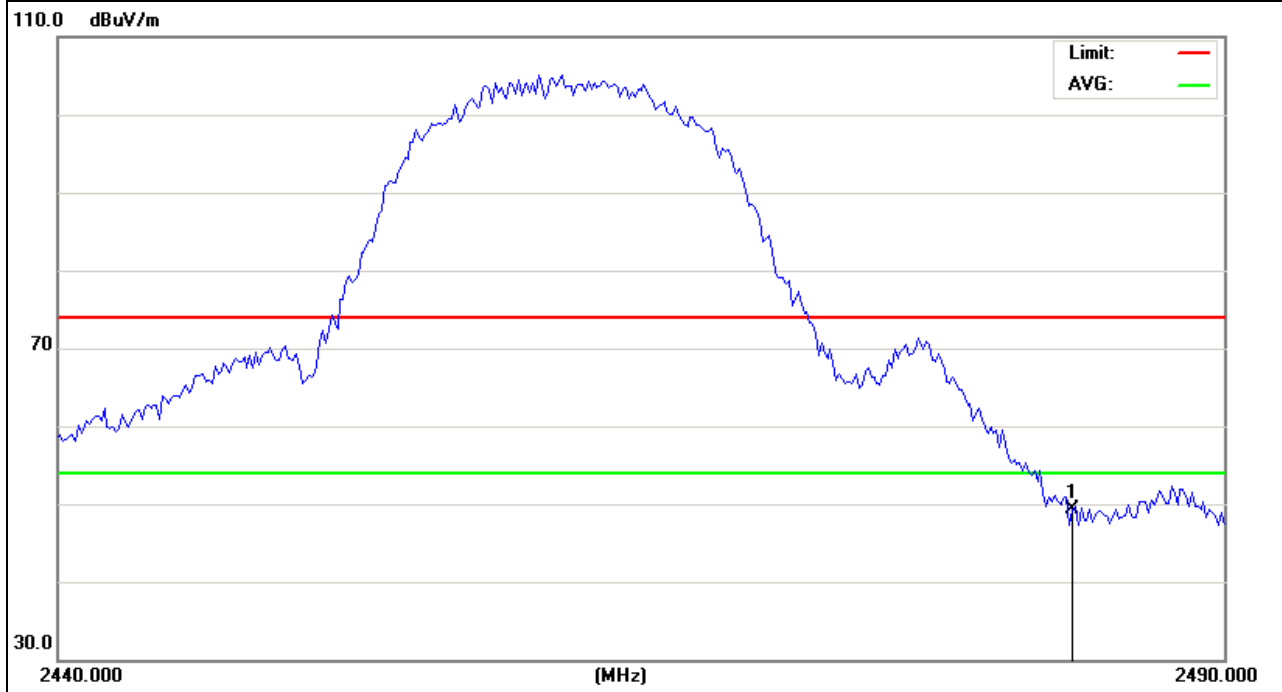

EUT :	7inch tablet	Model Name :	EGS004
Temperature :	20 °C	Relative Humidity :	48%
Pressure :	1010 hPa	Test Voltage :	DC 3.7V
Test Mode :	CH1(802.11g Mode)	Polarization :	Horizontal

Frequency (MHz)	Meter Reading (dBμV)	Factor (dB)	Emission Level (dBμV/m)	Limits (dBμV/m)	Margin (dB)	Detector Type
2400	79.62	-12.99	66.63	74	-7.37	peak
2400	57.57	-12.99	44.58	54	-9.42	AVG

Remark:
 Factor = Antenna Factor + Cable Loss – Pre-amplifier.

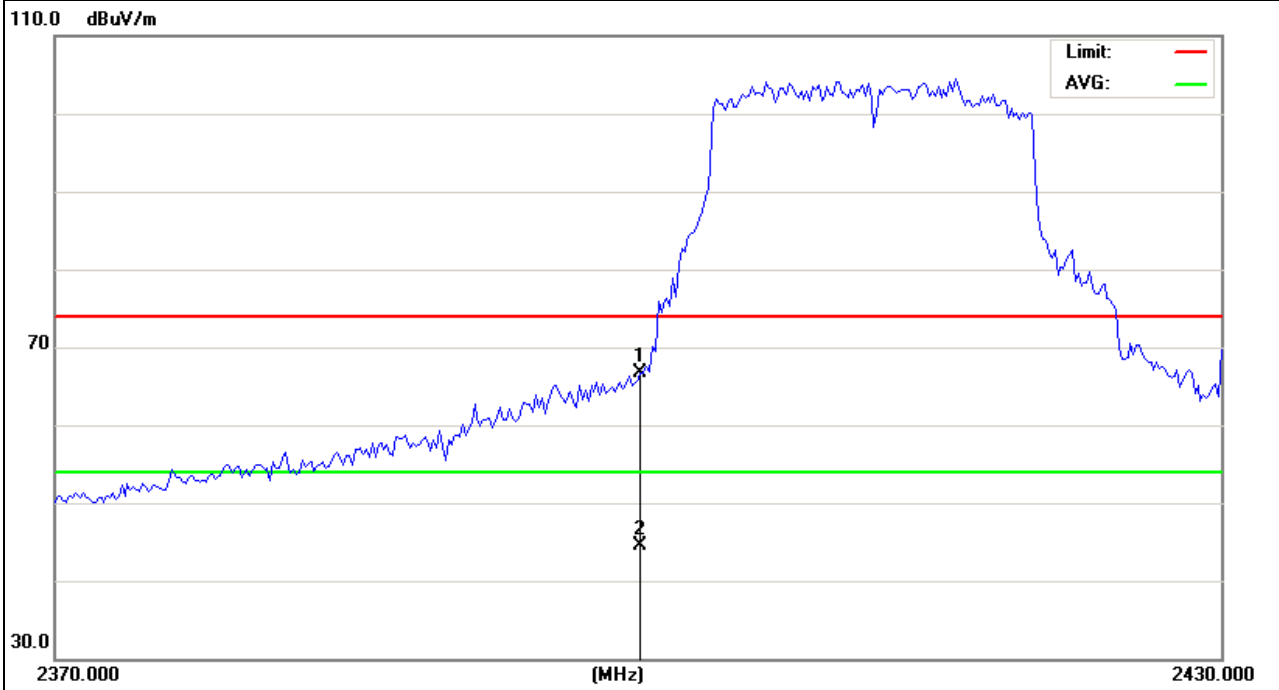

EUT :	7inch tablet	Model Name :	EGS004
Temperature :	20 °C	Relative Humidity :	48%
Pressure :	1010 hPa	Test Voltage :	DC 3.7V
Test Mode :	CH1(802.11gMode)	Polarization :	Vertical

Frequency (MHz)	Meter Reading (dBμV)	Factor (dB)	Emission Level (dBμV/m)	Limits (dBμV/m)	Margin (dB)	Detector Type
2400	82.09	-12.99	69.1	74	-4.9	peak
2400	58.87	-12.99	45.88	54	-8.12	AVG

Remark:
Factor = Antenna Factor + Cable Loss – Pre-amplifier.

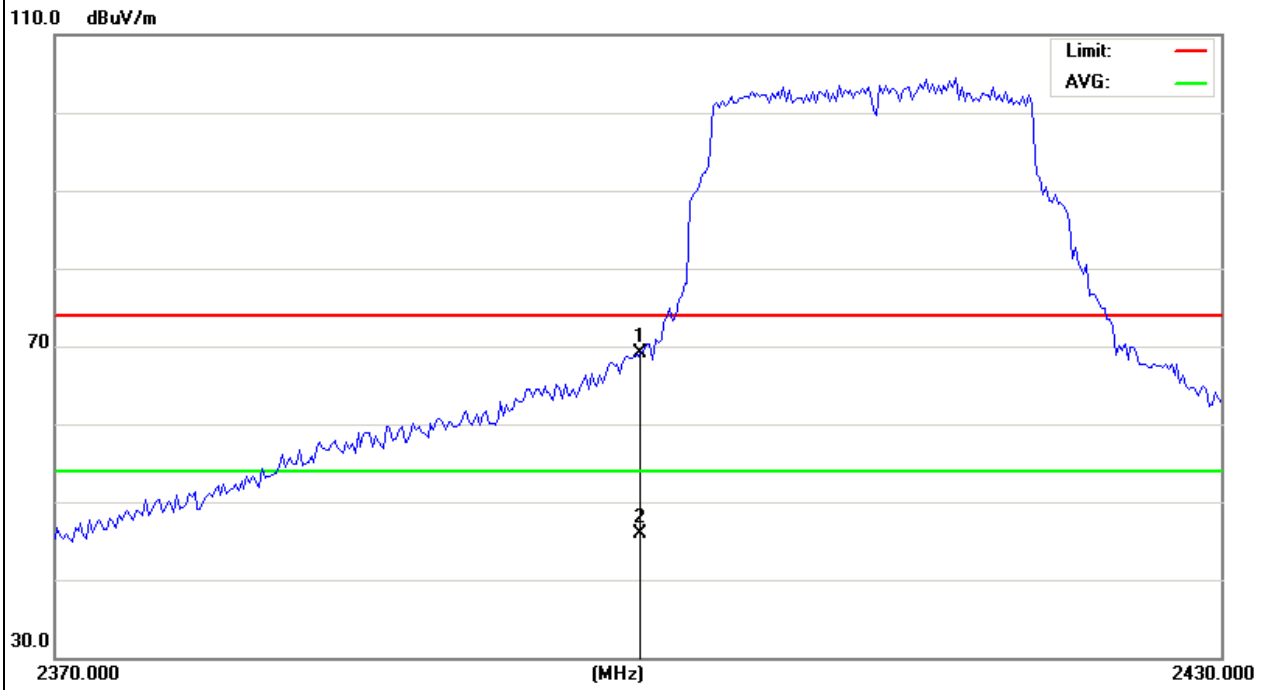

EUT :	7inch tablet	Model Name :	EGS004
Temperature :	20 °C	Relative Humidity :	48%
Pressure :	1010 hPa	Test Voltage :	DC 3.7V
Test Mode :	CH11(802.11g Mode)	Polarization :	Horizontal

Frequency (MHz)	Meter Reading (dBμV)	Factor (dB)	Emission Level (dBμV/m)	Limits (dBμV/m)	Margin (dB)	Detector Type
2483.5	64.18	-12.78	51.4	74	-22.6	peak

Remark:
Factor = Antenna Factor + Cable Loss – Pre-amplifier.

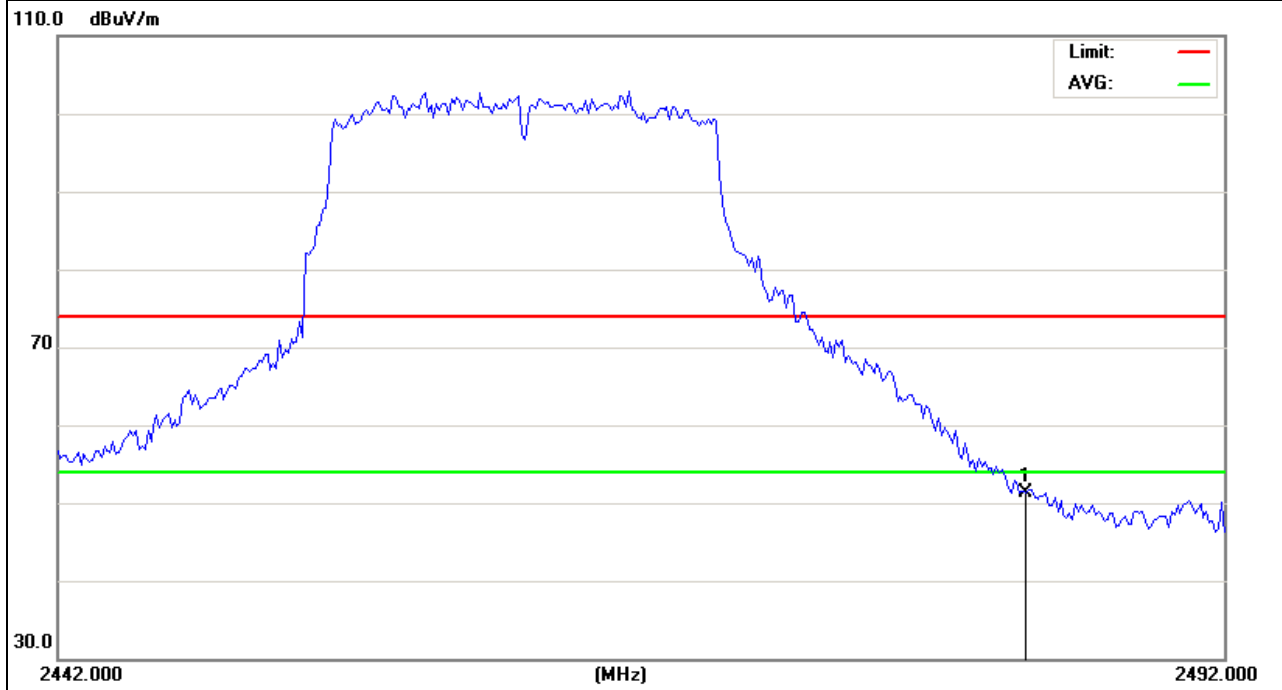

EUT :	7inch tablet	Model Name :	EGS004
Temperature :	20 °C	Relative Humidity :	48%
Pressure :	1010 hPa	Test Voltage :	DC 3.7V
Test Mode :	CH11(802.11g Mode)	Polarization :	Vertical

Frequency (MHz)	Meter Reading (dBμV)	Factor (dB)	Emission Level (dBμV/m)	Limits (dBμV/m)	Margin (dB)	Detector Type
2483.5	80.7	-12.78	67.92	74	-6.08	peak
2483.5	60.45	-12.78	47.67	54	-6.33	AVG

Remark:
Factor = Antenna Factor + Cable Loss – Pre-amplifier.

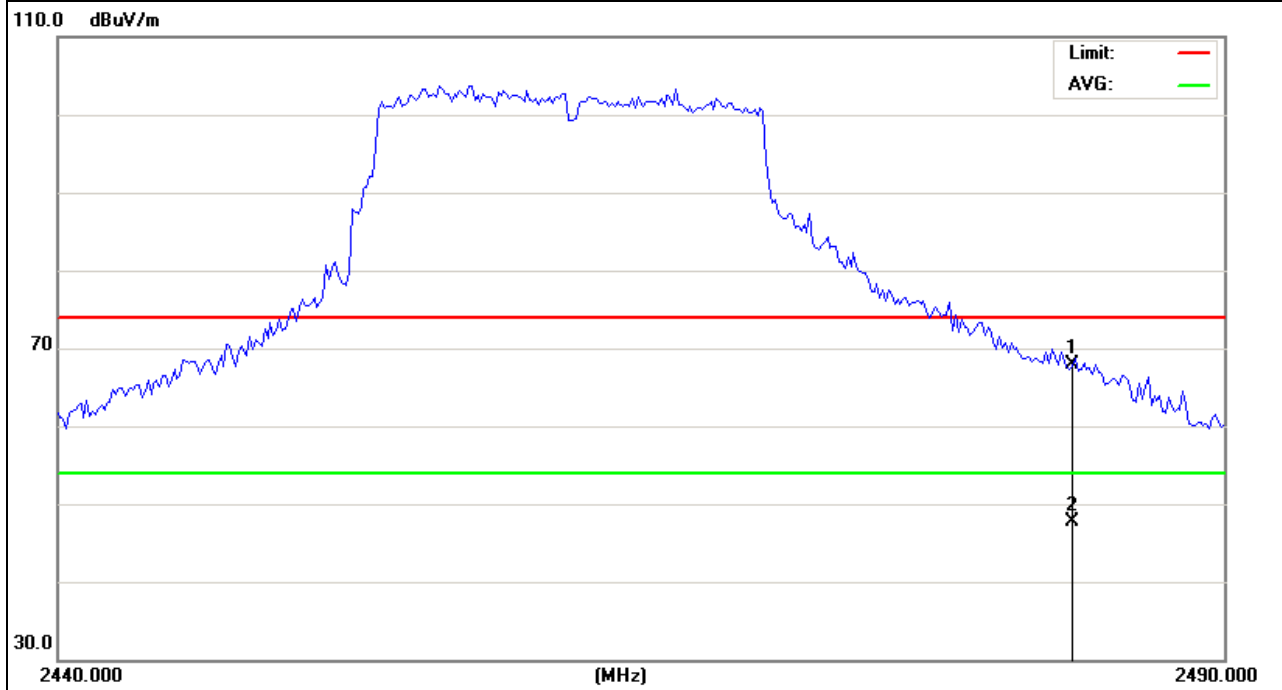

EUT :	7inch tablet	Model Name :	EGS004
Temperature :	20 °C	Relative Humidity :	48%
Pressure :	1010 hPa	Test Voltage :	DC 3.7V
Test Mode :	CH1(802.11N Mode)	Polarization :	Horizontal

Frequency (MHz)	Meter Reading (dBμV)	Factor (dB)	Emission Level (dBμV/m)	Limits (dBμV/m)	Margin (dB)	Detector Type
2400	84.49	-12.99	71.5	74	-2.5	peak
2400	61.04	-12.99	48.05	54	-5.95	AVG

Remark:
Factor = Antenna Factor + Cable Loss – Pre-amplifier.

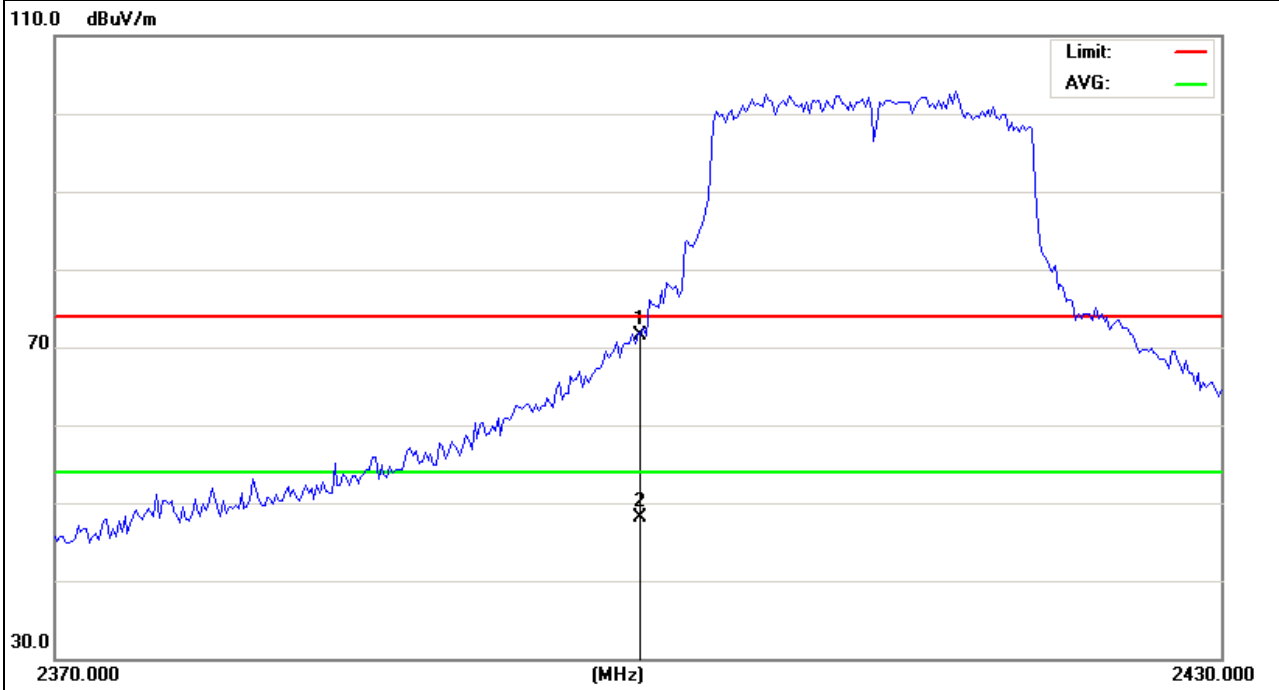

EUT :	7inch tablet	Model Name :	EGS004
Temperature :	20 °C	Relative Humidity :	48%
Pressure :	1010 hPa	Test Voltage :	DC 3.7V
Test Mode :	CH1(802.11N Mode)	Polarization :	Vertical

Frequency (MHz)	Meter Reading (dBμV)	Factor (dB)	Emission Level (dBμV/m)	Limits (dBμV/m)	Margin (dB)	Detector Type
2400	78.79	-12.99	65.8	74	-8.2	peak
2400	54.74	-12.99	41.75	54	-12.25	AVG

Remark:
Factor = Antenna Factor + Cable Loss – Pre-amplifier.

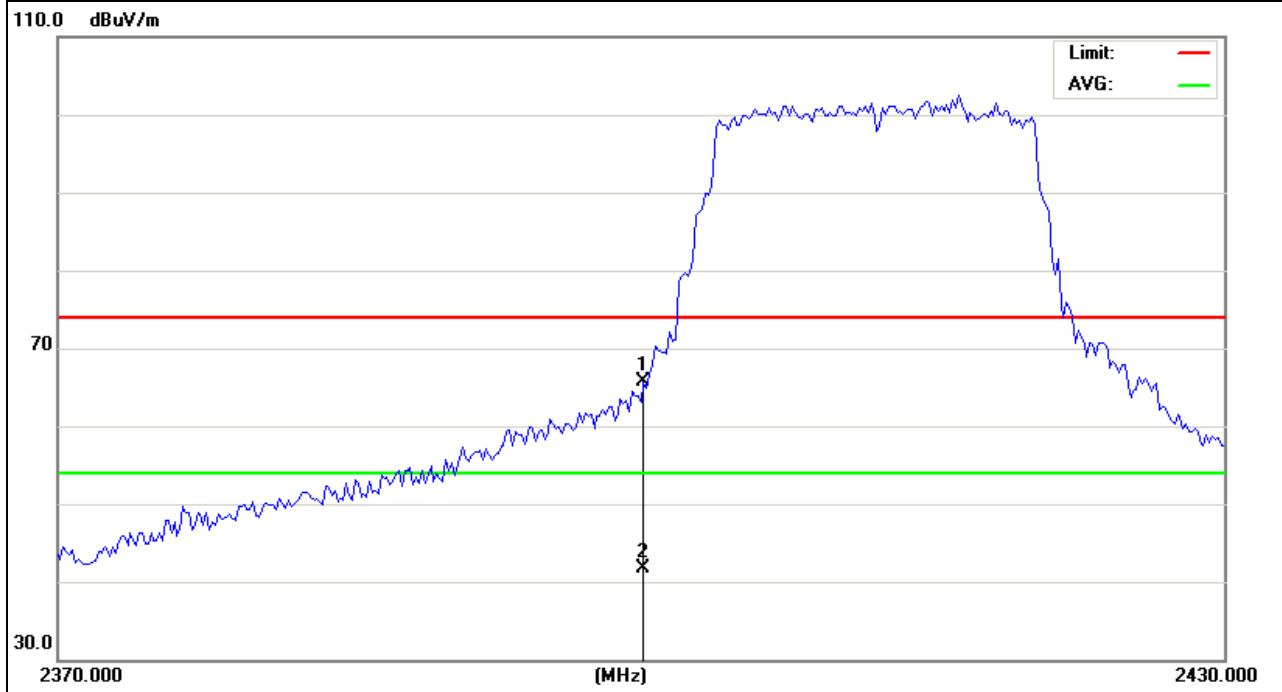

EUT :	7inch tablet	Model Name :	EGS004
Temperature :	20 °C	Relative Humidity :	48%
Pressure :	1010 hPa	Test Voltage :	DC 3.7V
Test Mode :	CH11(802.11N Mode)	Polarization :	Horizontal

Frequency (MHz)	Meter Reading (dBμV)	Factor (dB)	Emission Level (dBμV/m)	Limits (dBμV/m)	Margin (dB)	Detector Type
2483.5	78.31	-12.78	65.53	74	-8.47	peak
2483.5	57.39	-12.78	44.61	54	-9.39	AVG

Remark:
Factor = Antenna Factor + Cable Loss – Pre-amplifier.

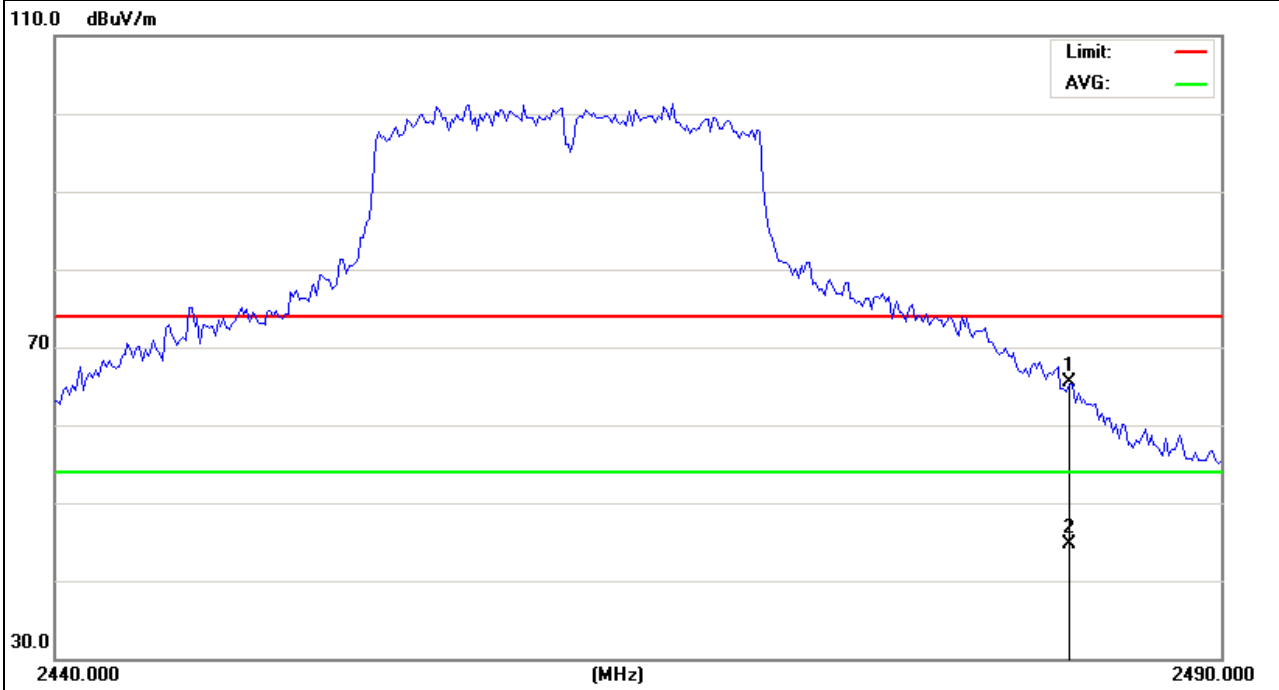

EUT :	7inch tablet	Model Name :	EGS004
Temperature :	20 °C	Relative Humidity :	48%
Pressure :	1010 hPa	Test Voltage :	DC 3.7V
Test Mode :	CH11(802.11N Mode)	Polarization :	Vertical

Frequency (MHz)	Meter Reading (dBμV)	Factor (dB)	Emission Level (dBμV/m)	Limits (dBμV/m)	Margin (dB)	Detector Type
2483.5	79.04	-12.78	66.26	74	-7.74	peak
2483.5	58.96	-12.78	46.18	54	-7.82	AVG

Remark:
Factor = Antenna Factor + Cable Loss – Pre-amplifier.

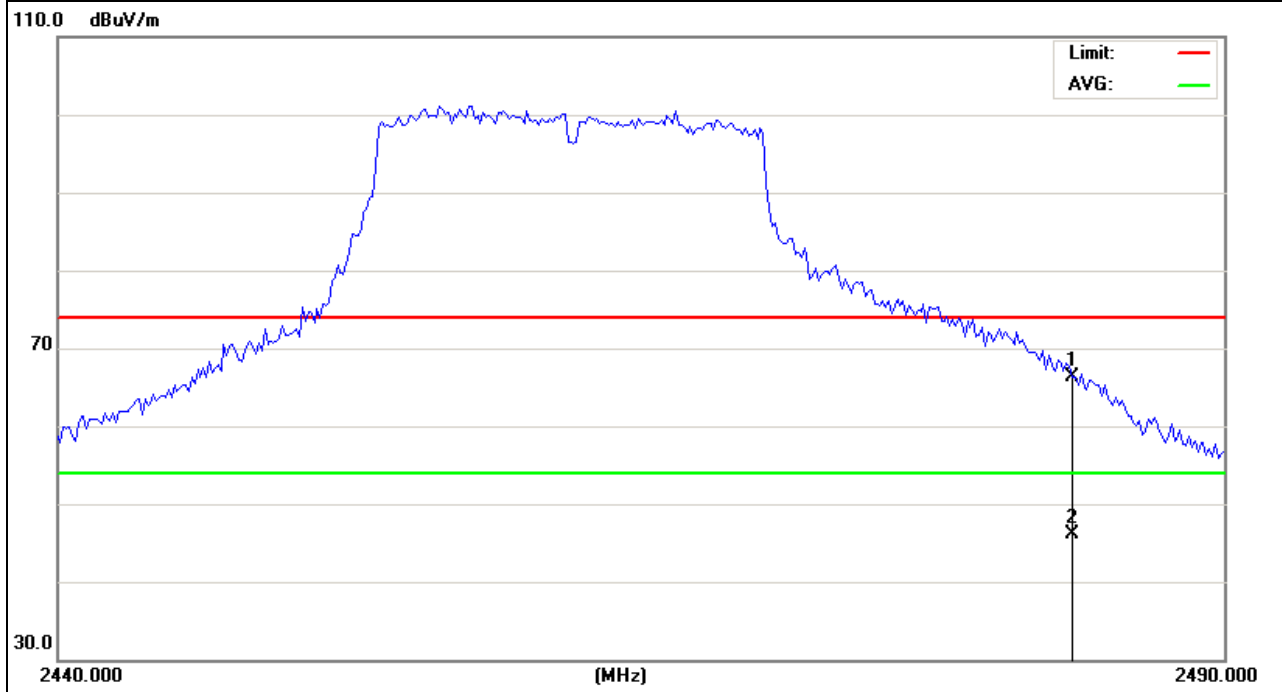

4. POWER SPECTRAL DENSITY TEST

4.1 APPLIED PROCEDURES / LIMIT

FCC Part15 (15.247) , Subpart C				
Section	Test Item	Limit	Frequency Range (MHz)	Result
15.247	Power Spectral Density	8 dBm (in any 3KHz)	2400-2483.5	PASS

4.1.1 TEST PROCEDURE

1. Set analyzer center frequency to DTS channel center frequency.
2. Set the span to 1.5 times the DTS channel bandwidth.
3. Set the RBW \geq 3 kHz.
4. Set the VBW \geq 3 x RBW.
5. Detector = peak.
6. Sweep time = auto couple.
7. Trace mode = max hold.
8. Allow trace to fully stabilize.
9. Use the peak marker function to determine the maximum amplitude level.
10. If measured value exceeds limit, reduce RBW (no less than 3 kHz) and repeat.

4.1.2 DEVIATION FROM STANDARD

No deviation.

4.1.3 TEST SETUP



4.1.4 EUT OPERATION CONDITIONS

The EUT tested system was configured as the statements of 2.1 Unless otherwise a special operating condition is specified in the follows during the testing.

4.1.5 TEST RESULTS

EUT :	7inch tablet	Model Name :	EGS004
Temperature :	25 °C	Relative Humidity :	60%
Pressure :	1015 hPa	Test Voltage :	DC 3.7V
Test Mode :	TX b Mode /CH01, CH06, CH11		

Frequency	Power Density (dBm)	Limit (dBm)	Result
2412 MHz	-7.972	8	PASS
2437 MHz	-8.298	8	PASS
2462 MHz	-9.719	8	PASS

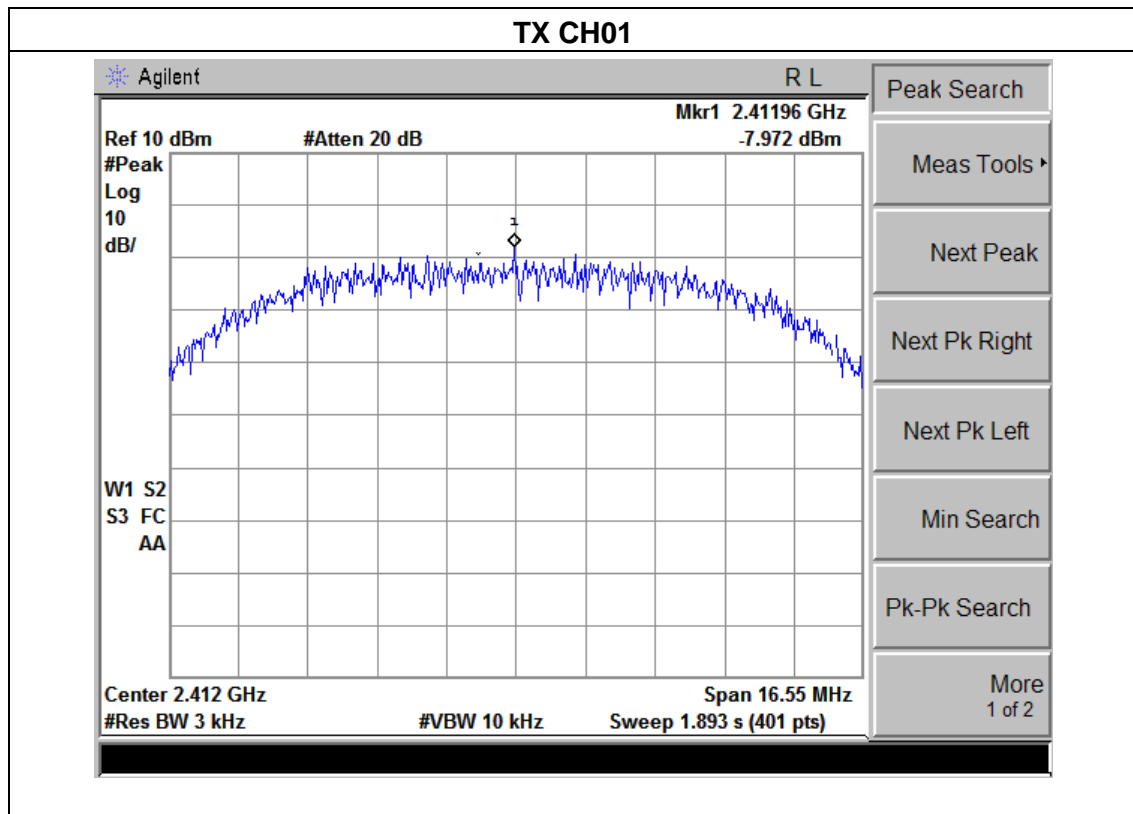

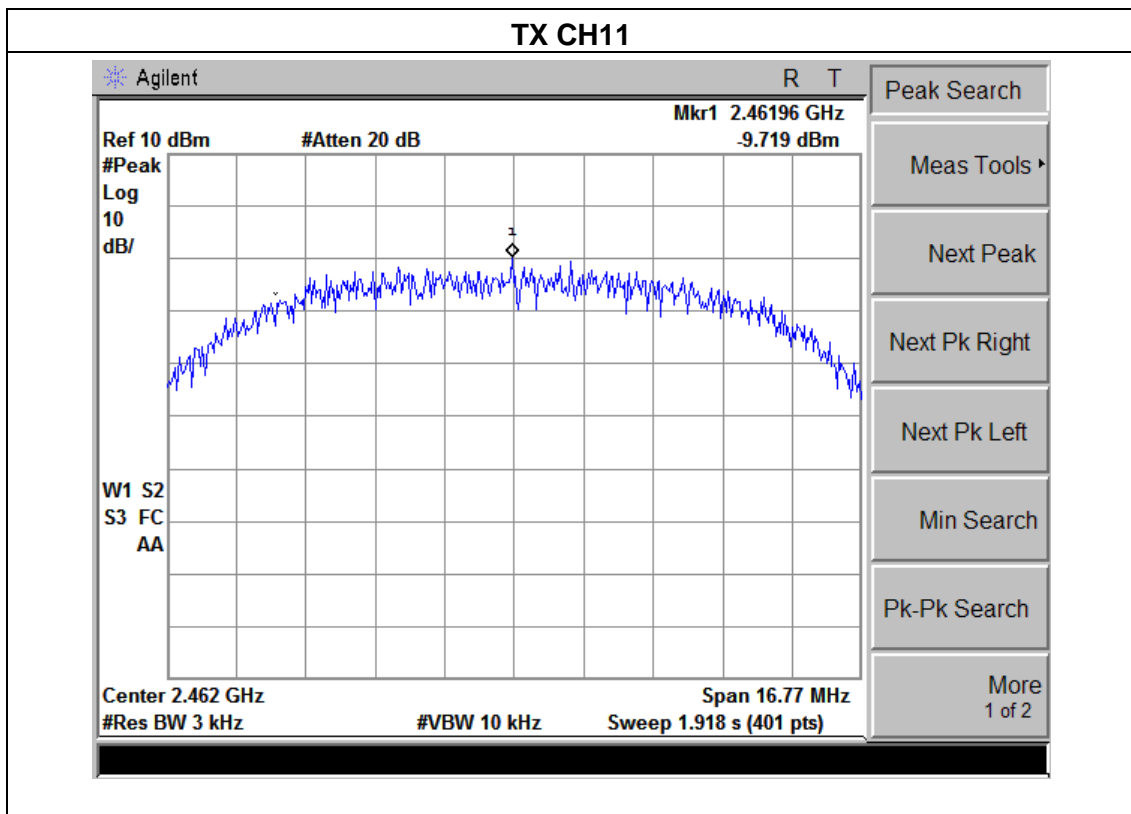
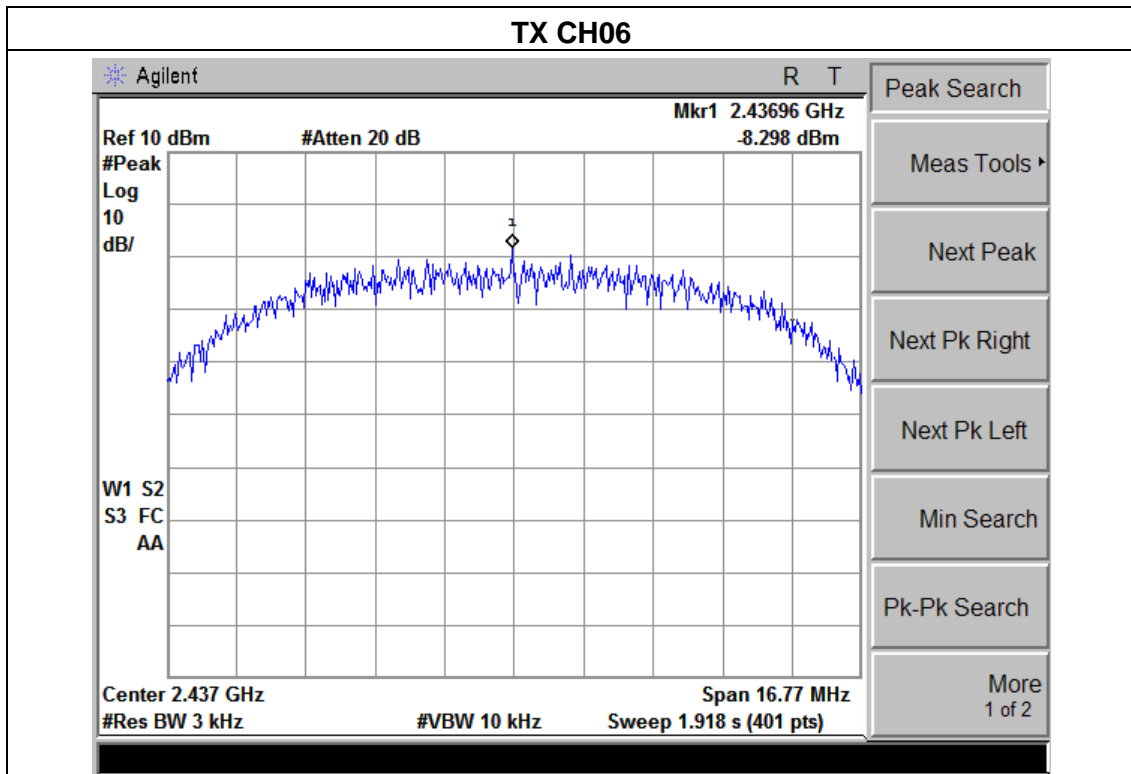

EUT :	7inch tablet	Model Name :	EGS004
Temperature :	25 °C	Relative Humidity :	60%
Pressure :	1015 hPa	Test Voltage :	DC 3.7V
Test Mode :	TX g Mode /CH01, CH06, CH11		

Frequency	Power Density (dBm)	Limit (dBm)	Result
2412 MHz	-10.27	8	PASS
2437 MHz	-10.94	8	PASS
2462 MHz	-10.87	8	PASS

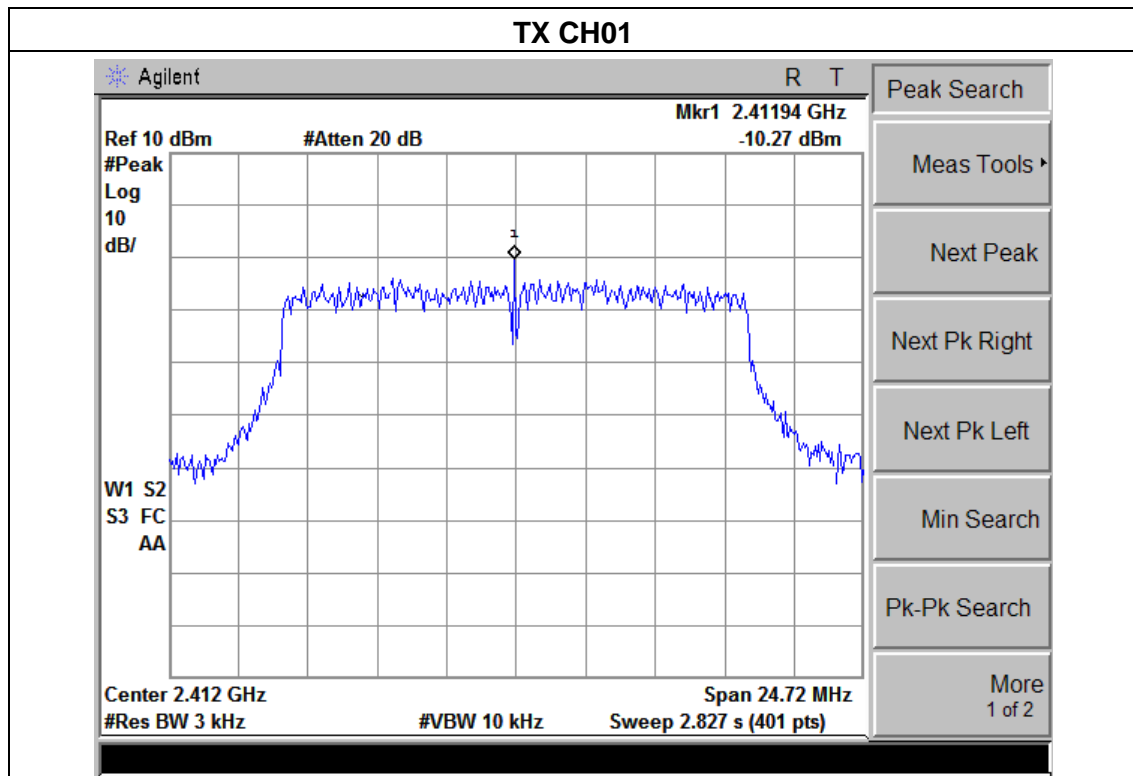

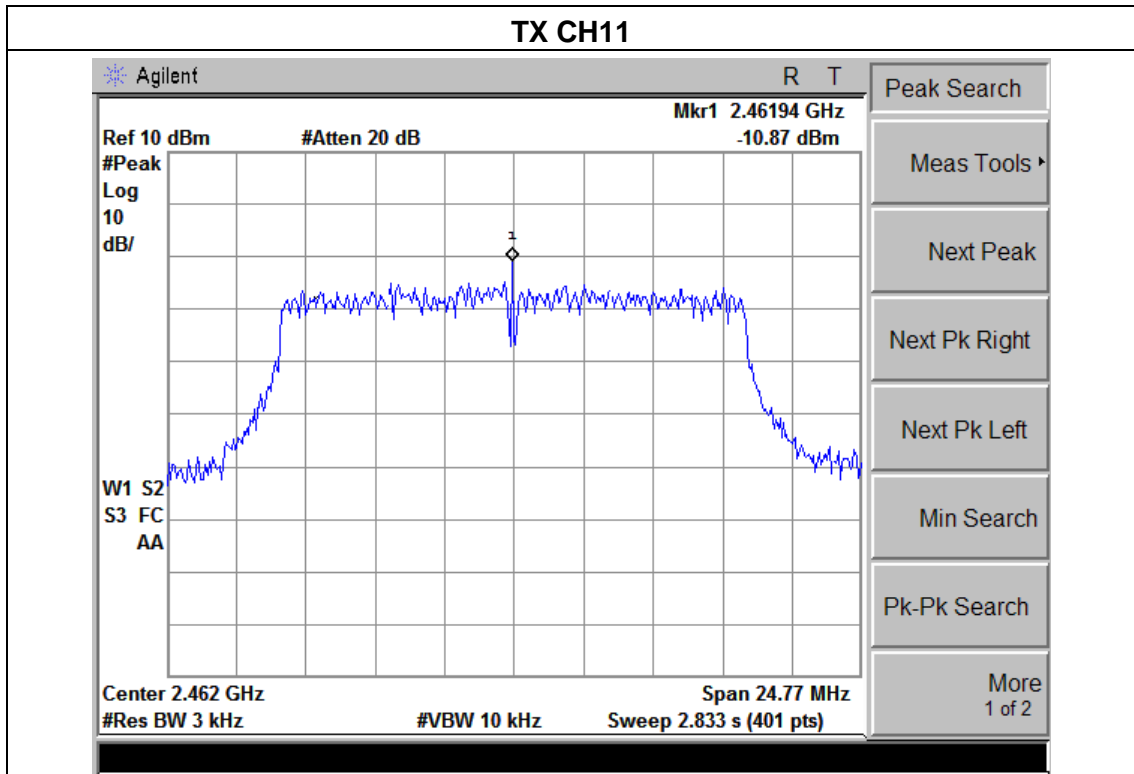
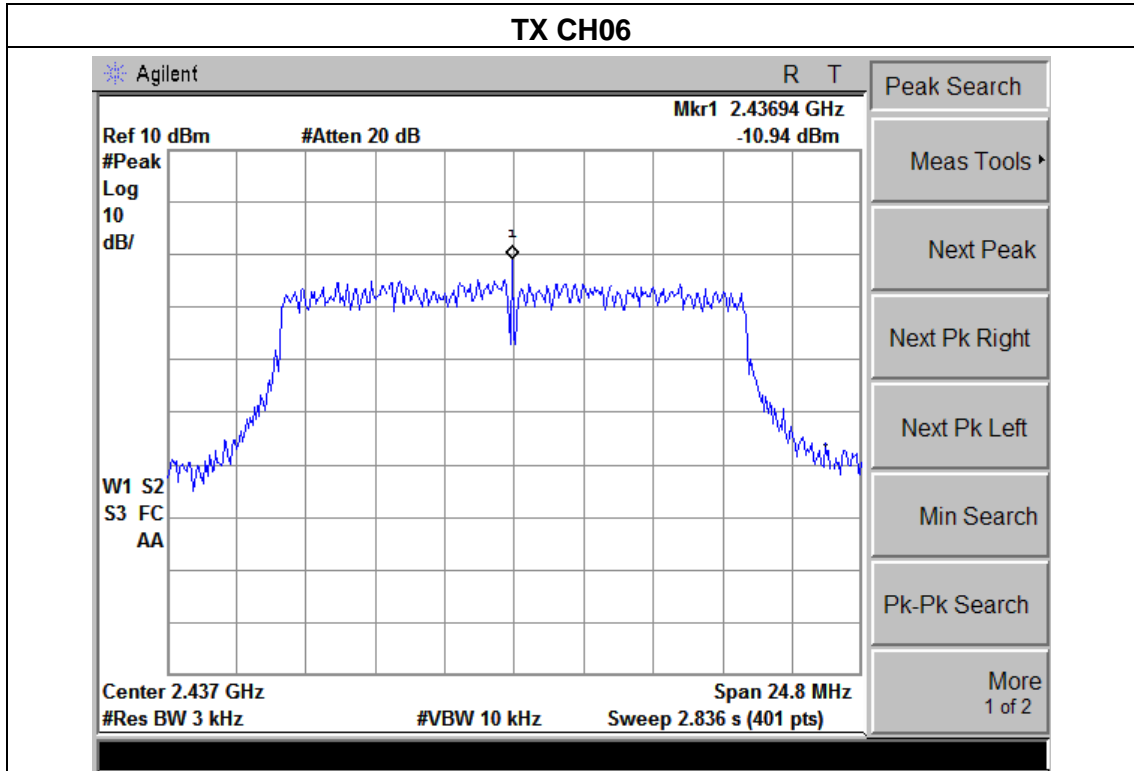

EUT :	7inch tablet	Model Name :	EGS004
Temperature :	25 °C	Relative Humidity :	60%
Pressure :	1015 hPa	Test Voltage :	DC 3.7V
Test Mode :	TX n Mode /CH01, CH06, CH11		

Frequency	Power Density (dBm)	Limit (dBm)	Result
2412 MHz	-10.32	8	PASS
2437 MHz	-10.94	8	PASS
2462 MHz	-11.97	8	PASS

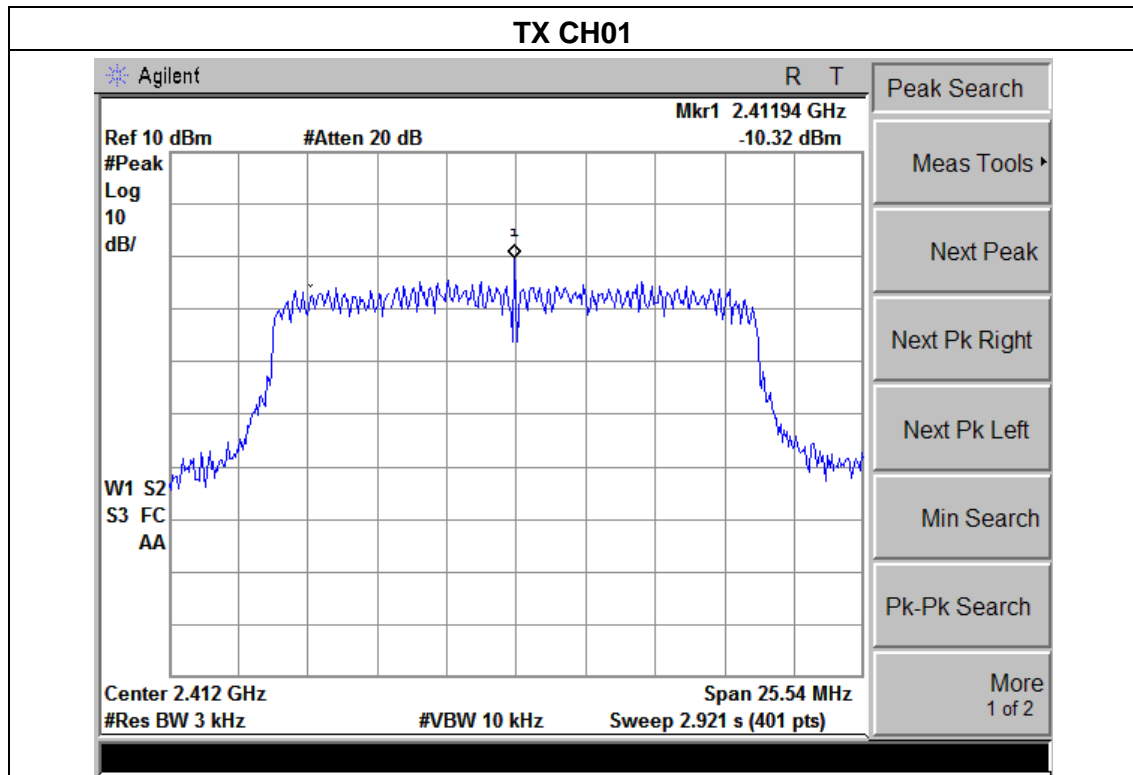

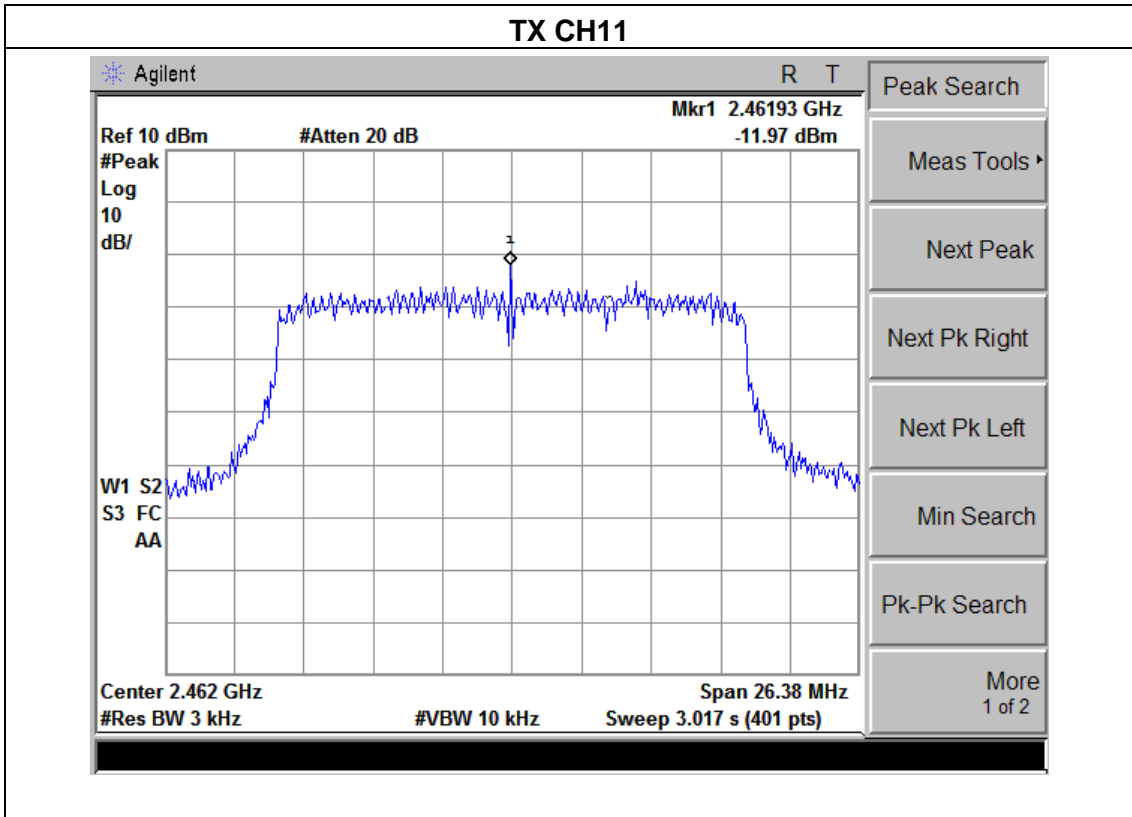
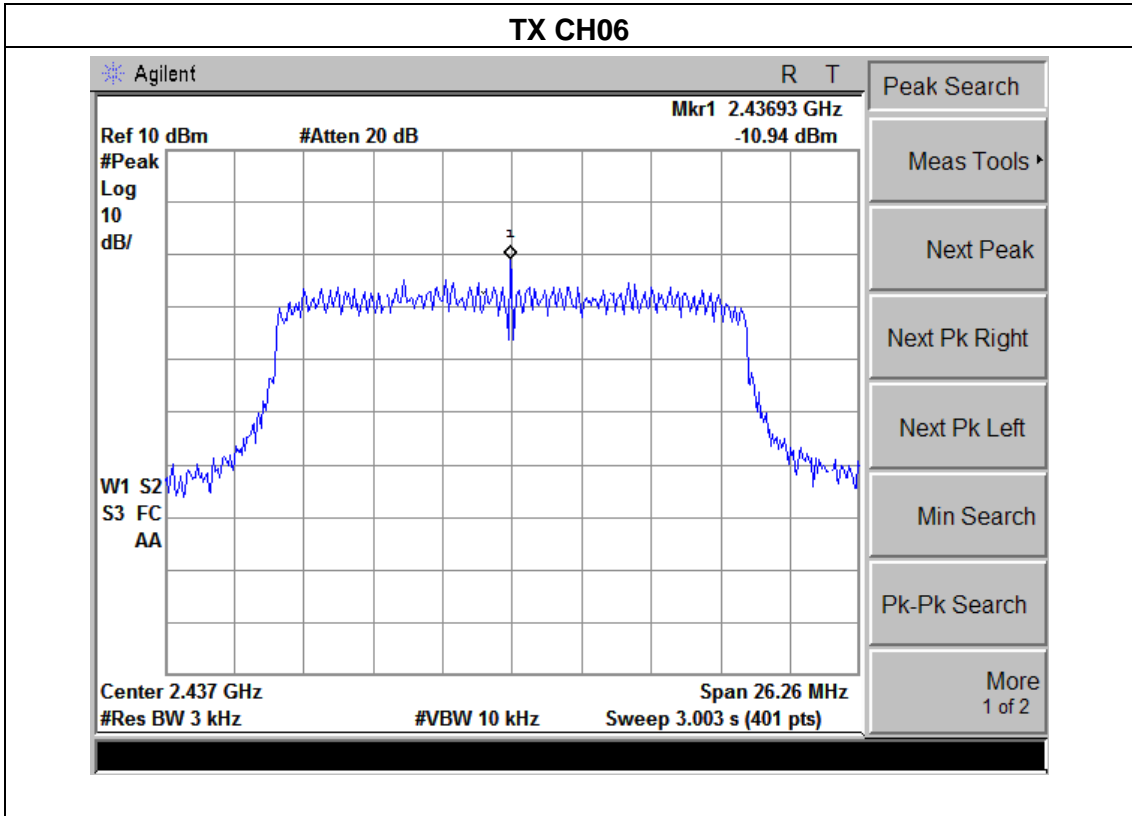

5. BANDWIDTH TEST

5.1 APPLIED PROCEDURES / LIMIT

FCC Part15 (15.247) , Subpart C				
Section	Test Item	Limit	Frequency Range (MHz)	Result
15.247(a)(2)	Bandwidth	$\geq 500\text{KHz}$ (6dB bandwidth)	2400-2483.5	PASS

5.1.1 TEST PROCEDURE

1. Set resolution bandwidth (RBW) = 1-5% or DTS BW, not to exceed 100 kHz.
2. Set the video bandwidth (VBW) $\geq 3 \times$ RBW.
3. Detector = Peak.
4. Trace mode = max hold.
5. Sweep = auto couple.
6. Allow the trace to stabilize.
7. Measure the maximum width of the emission that is constrained by the frequencies associated with the two outermost amplitude points (upper and lower) that are attenuated by 6 dB relative to the maximum level measured in the fundamental emission.

5.1.2 DEVIATION FROM STANDARD

No deviation.

5.1.3 TEST SETUP



5.1.4 EUT OPERATION CONDITIONS

The EUT tested system was configured as the statements of 2.4 Unless otherwise a special operating condition is specified in the follows during the testing.

5.1.5 TEST RESULTS

EUT :	7inch tablet	Model Name :	EGS004
Temperature :	25 °C	Relative Humidity :	60%
Pressure :	1012 hPa	Test Voltage :	DC 3.7V
Test Mode :	TX b Mode /CH01, CH06, CH11		

Frequency	6dB Bandwidth (MHz)	Channel Separation (MHz)	Result
2412 MHz	11.03	>=500KHz	PASS
2437 MHz	11.18	>=500KHz	PASS
2462 MHz	11.09	>=500KHz	PASS

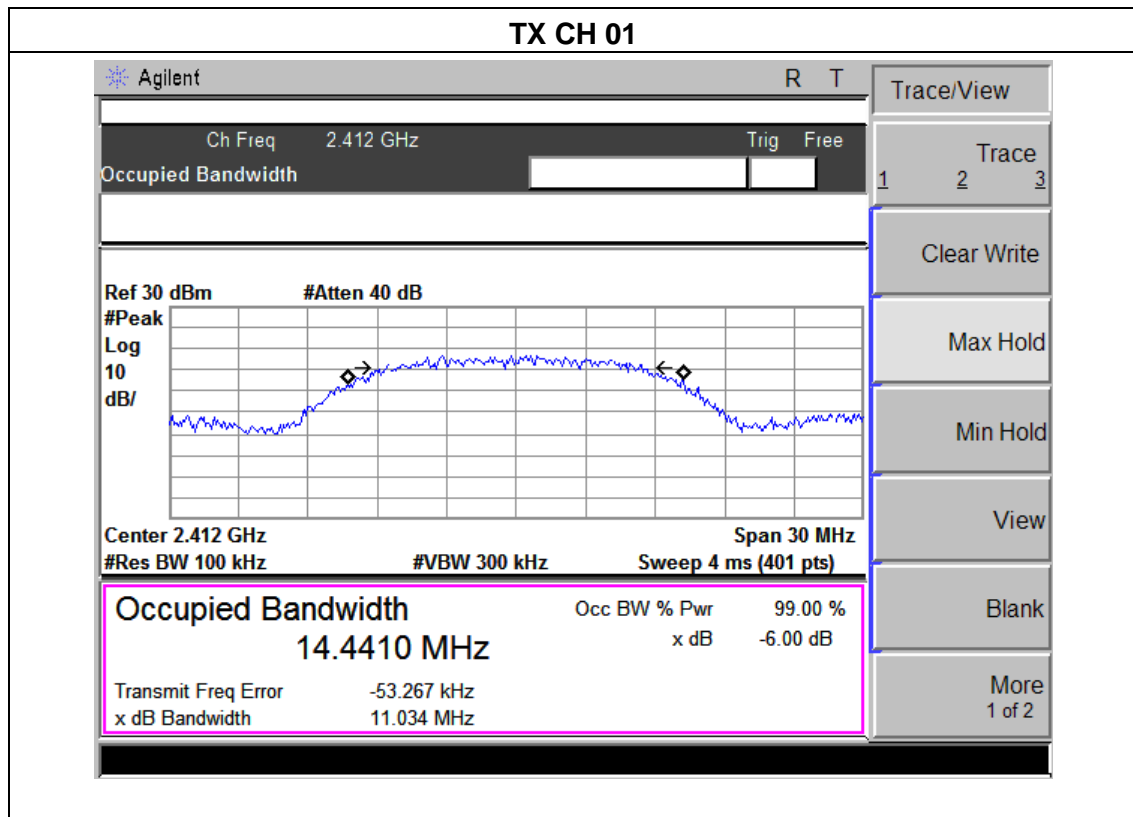

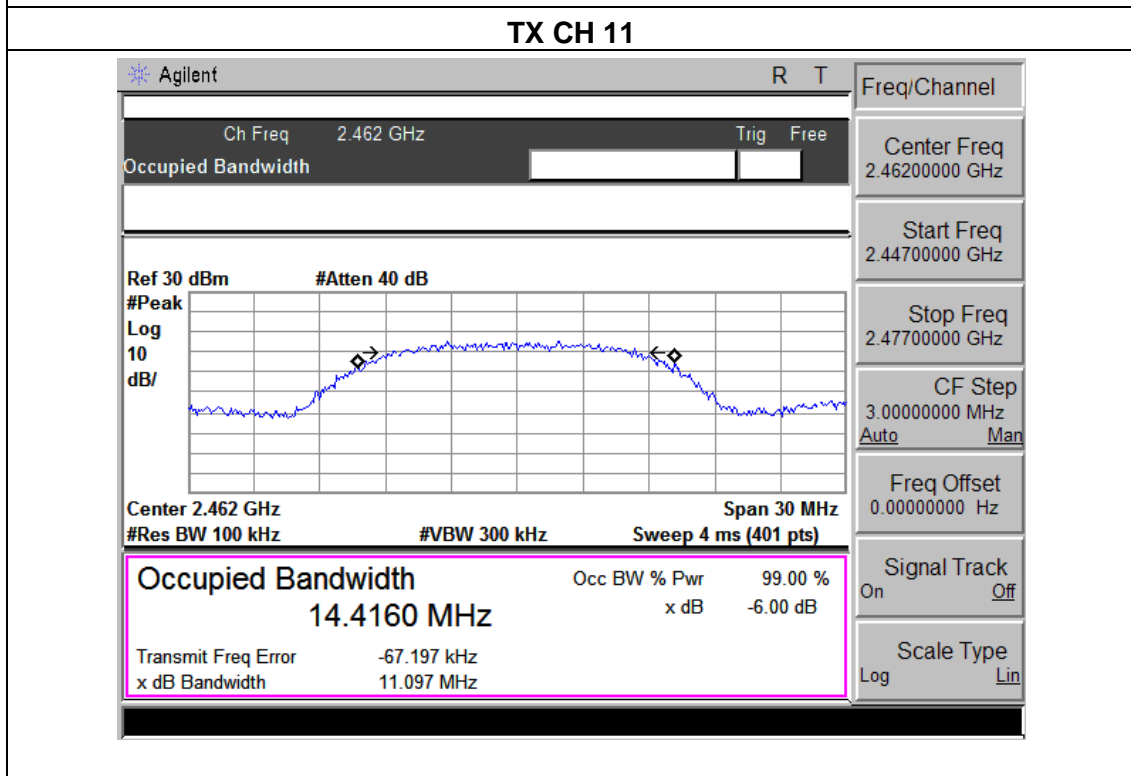
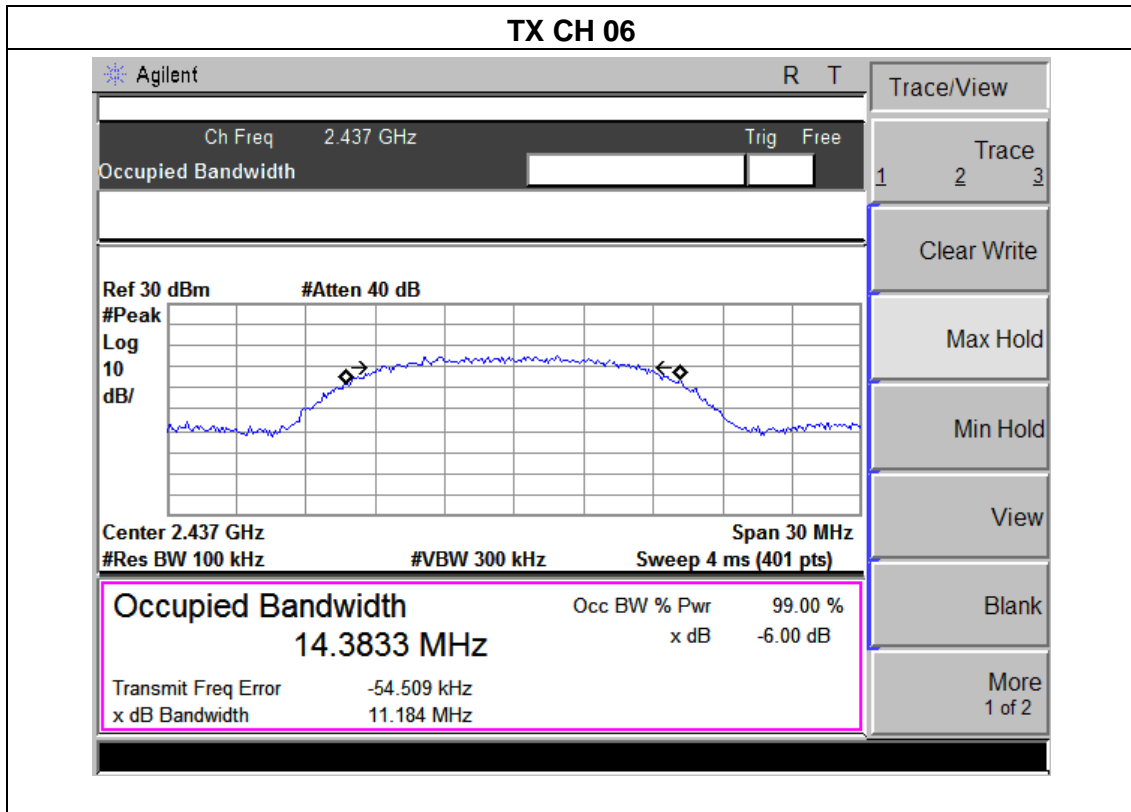

EUT :	7inch tablet	Model Name :	EGS004
Temperature :	25 °C	Relative Humidity :	60%
Pressure :	1012 hPa	Test Voltage :	DC 3.7V
Test Mode :	TX g Mode /CH01, CH06, CH11		

Frequency	6dB Bandwidth (MHz)	Channel Separation (MHz)	Result
2412 MHz	16.46	>=500KHz	PASS
2437 MHz	16.54	>=500KHz	PASS
2462 MHz	16.51	>=500KHz	PASS

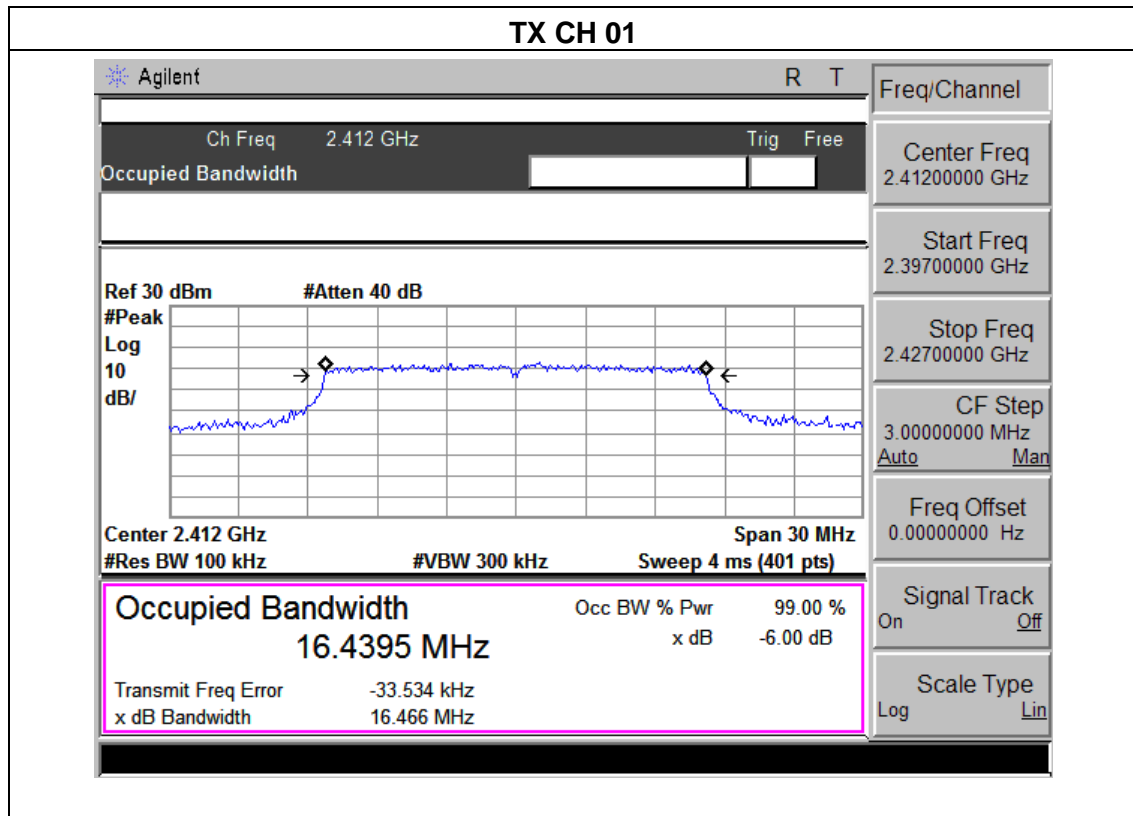

TX CH 06

Agilent
R T

Ch Freq 2.437 GHz
Trig Free

Occupied Bandwidth

Ref 30 dBm
#Atten 40 dB

#Peak

Log

10

dB/

Freq/Channel

Center Freq 2.43700000 GHz

Start Freq 2.42200000 GHz

Stop Freq 2.45200000 GHz

CF Step 3.00000000 MHz

Auto Man

Freq Offset 0.00000000 Hz

Signal Track On Off

Scale Type Log Lin

Center 2.437 GHz
Span 30 MHz

#Res BW 100 kHz
#VBW 300 kHz
Sweep 4 ms (401 pts)

Occupied Bandwidth	Occ BW % Pwr	99.00 %
16.4341 MHz	x dB	-6.00 dB
Transmit Freq Error	-36.686 kHz	
x dB Bandwidth	16.543 MHz	

TX CH 11

Agilent
R T

Ch Freq 2.462 GHz
Trig Free

Occupied Bandwidth

Ref 30 dBm
#Atten 40 dB

#Peak

Log

10

dB/

Trace/View

Trace 1 2 3

Clear Write

Max Hold

Min Hold

View

Blank

More 1 of 2

Center 2.462 GHz
Span 30 MHz

#Res BW 100 kHz
#VBW 300 kHz
Sweep 4 ms (401 pts)

Occupied Bandwidth	Occ BW % Pwr	99.00 %
16.4081 MHz	x dB	-6.00 dB
Transmit Freq Error	-40.877 kHz	
x dB Bandwidth	16.510 MHz	

EUT :	7inch tablet	Model Name :	EGS004
Temperature :	25 °C	Relative Humidity :	60%
Pressure :	1012 hPa	Test Voltage :	DC 3.7V
Test Mode :	TX n Mode /CH01, CH06, CH11		

Frequency	6dB Bandwidth (MHz)	99% Occupied BW (MHz)	Channel Separation (MHz)	Result
2412 MHz	17.02	17.48	>=500KHz	PASS
2437 MHz	17.50	17.50	>=500KHz	PASS
2462 MHz	17.58	17.48	>=500KHz	PASS

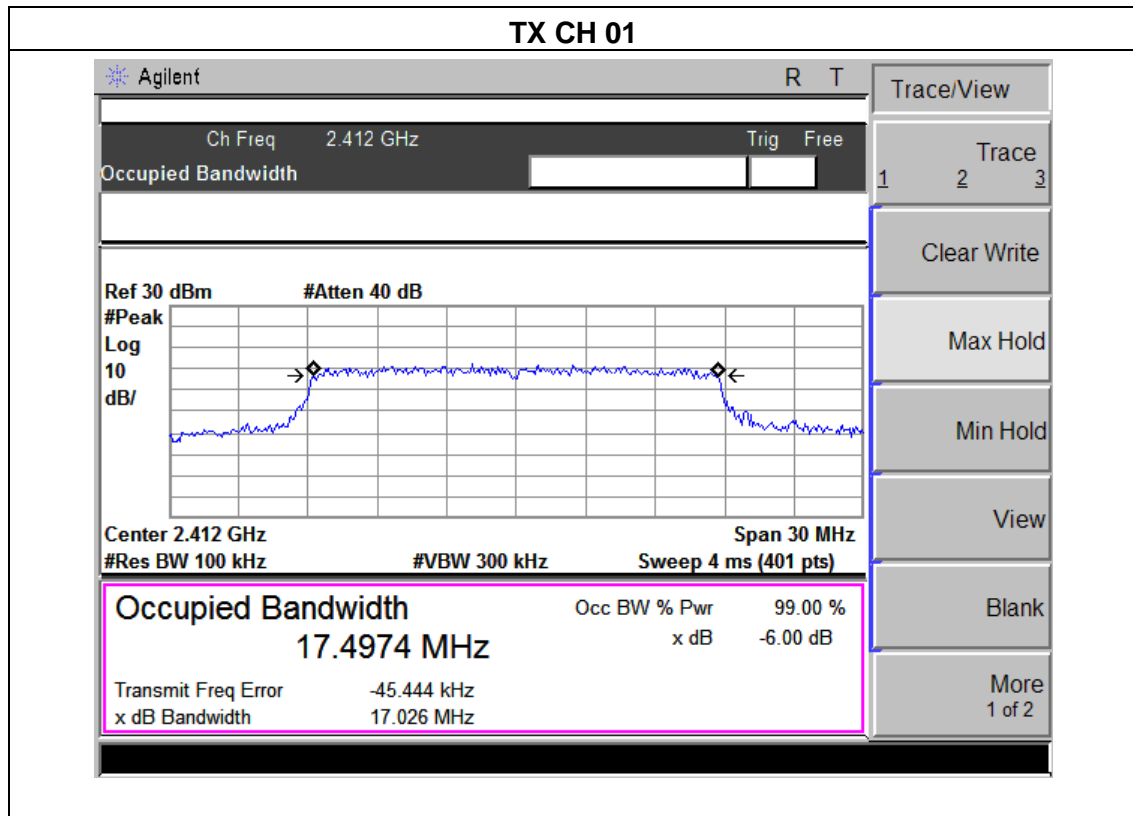

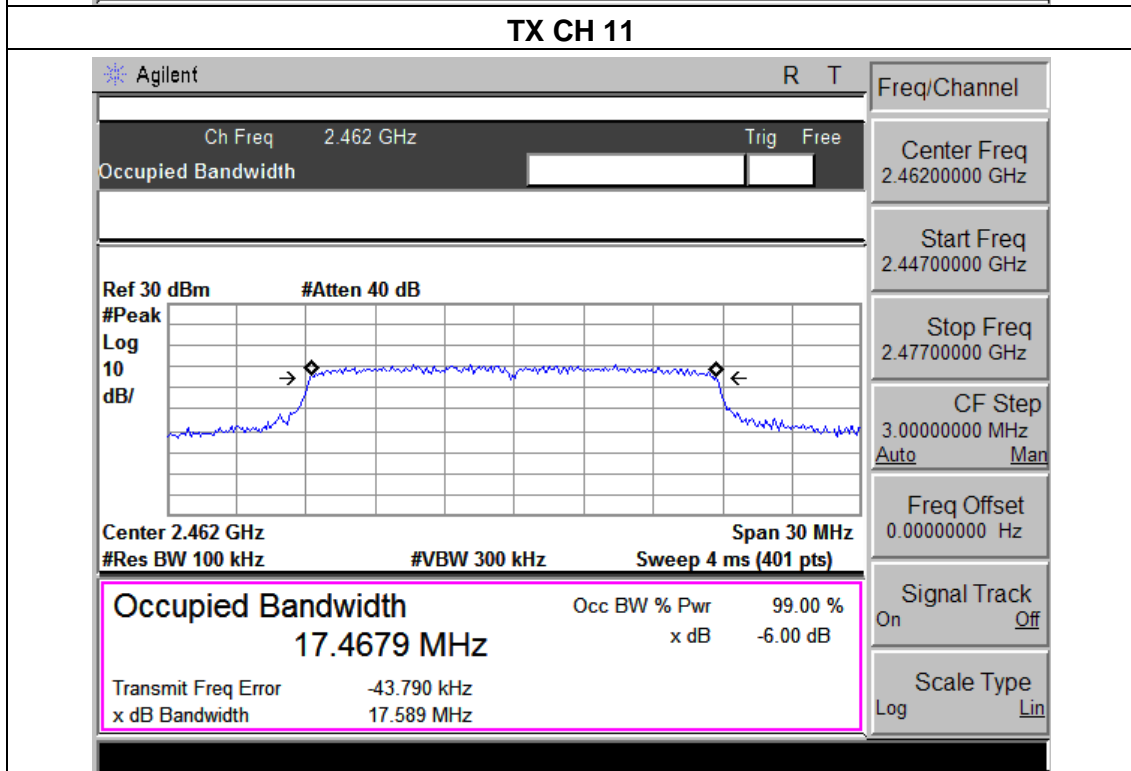
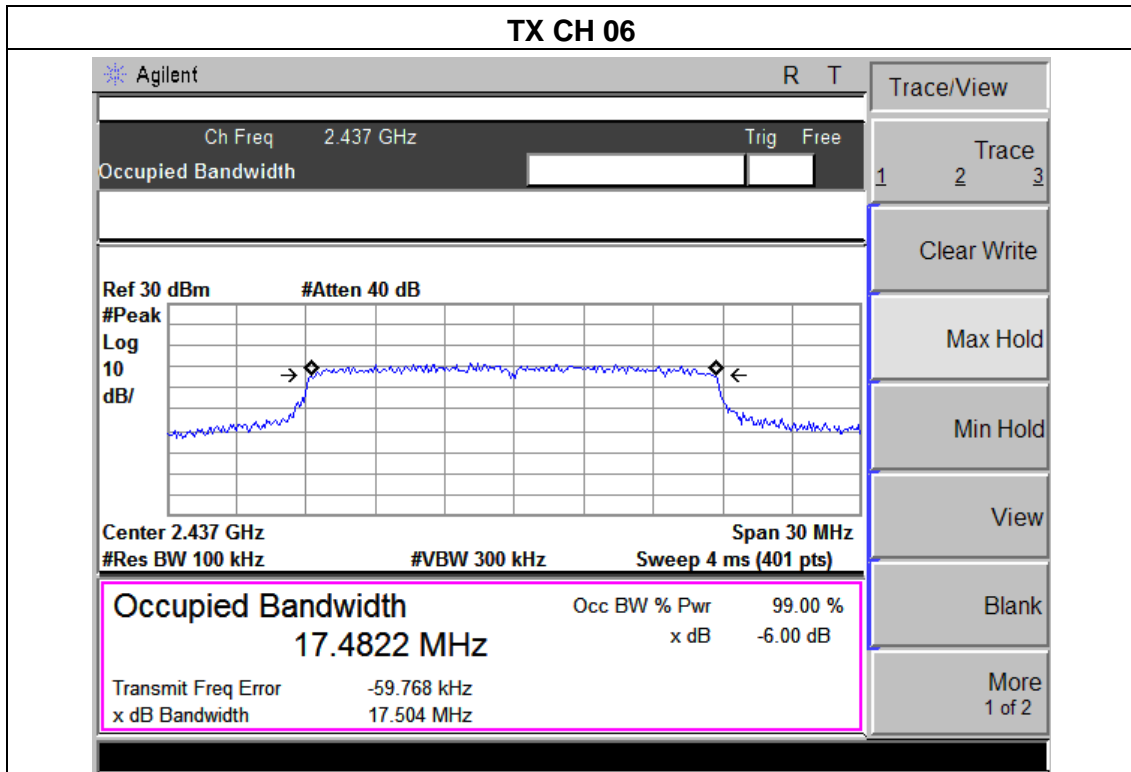

6. PEAK OUTPUT POWER TEST

6.1 APPLIED PROCEDURES / LIMIT

FCC Part15 (15.247) , Subpart C				
Section	Test Item	Limit	Frequency Range (MHz)	Result
15.247(b)(3)	Peak Output Power	1 watt or 30dBm	2400-2483.5	PASS

6.1.1 TEST PROCEDURE

- a. The EUT was directly connected to the Power meter

6.1.2 DEVIATION FROM STANDARD

No deviation.

6.1.3 TEST SETUP



6.1.4 EUT OPERATION CONDITIONS

The EUT tested system was configured as the statements of 2.4 Unless otherwise a special operating condition is specified in the follows during the testing.

6.1.5 TEST RESULTS

EUT :	7inch tablet	Model Name :	EGS004
Temperature :	25 °C	Relative Humidity :	60%
Pressure :	1012 hPa	Test Voltage :	DC 3.7V
Test Mode :	TX b/g/n Mode /CH01, CH06, CH11		

TX 802.11b Mode				
Test Channe	Frequency	Maximum Peak Conducted Output Power	Maximum Conducted Output Power(AV)	LIMIT
	(MHz)	(dBm)	(dBm)	dBm
CH01	2412	11.95	9.45	30
CH06	2437	11.72	9.32	30
CH11	2462	11.84	9.12	30
TX 802.11g Mode				
CH01	2412	9.76	7.43	30
CH06	2437	9.87	7.25	30
CH11	2462	9.57	7.19	30
TX 802.11n Mode				
CH01	2412	8.97	7.01	30
CH06	2437	8.68	6.68	30
CH11	2462	8.55	6.54	30

7. ANTENNA REQUIREMENT

7.1 STANDARD REQUIREMENT

15.203 requirement: For intentional device, according to 15.203: an intentional radiator shall be designed to ensure that no antenna other than that furnished by the responsible party shall be used with the device.

7.2 EUT ANTENNA

The EUT antenna is Integrated(FPCB) antenna. It comply with the standard requirement.

8. EUT TEST PHOTO

Radiated Measurement Photos

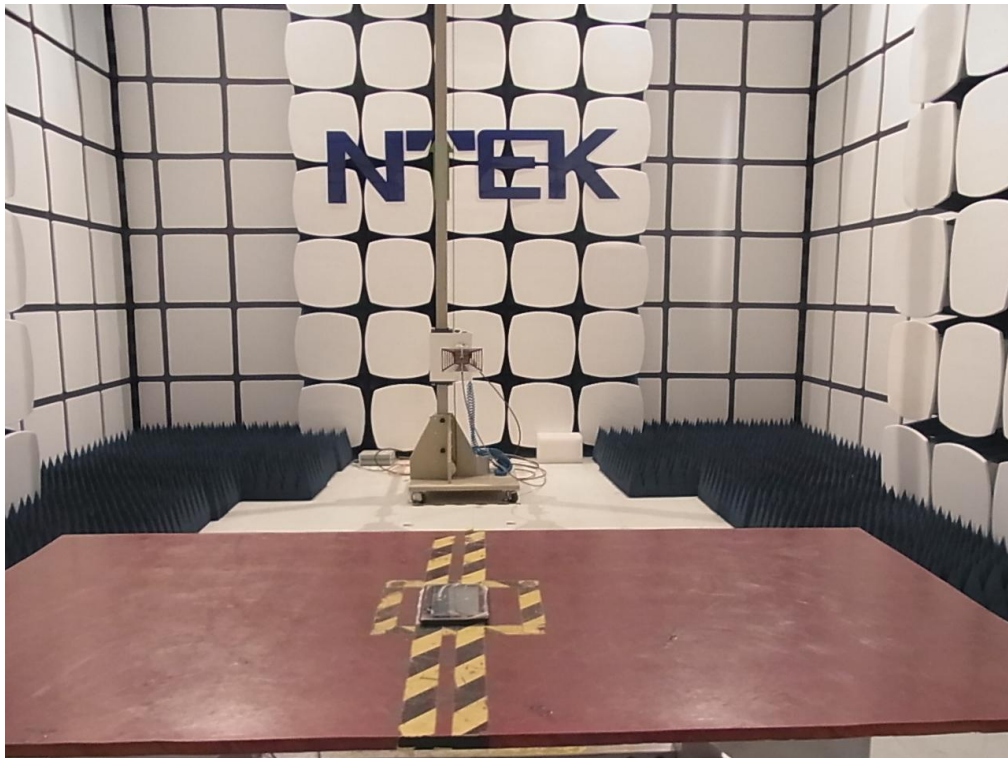
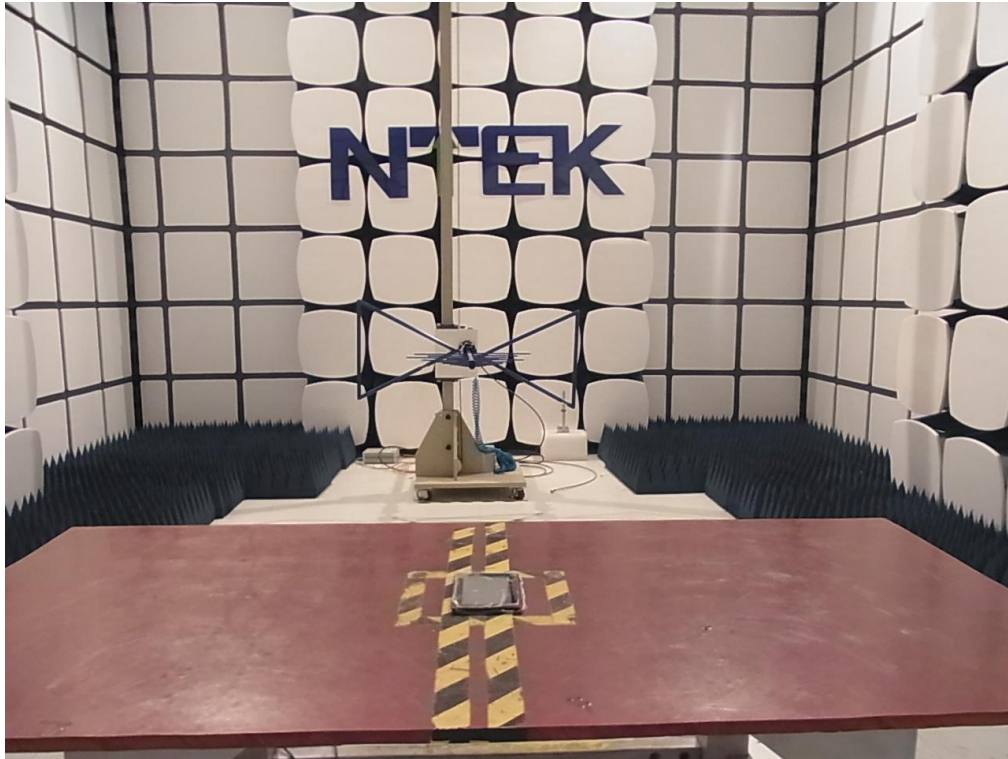

Conducted Measurement Photos

