



TEST REPORT

Report Reference No...... : **TRE150700202** R/C.....:94144
FCC ID..... : **XHWCUB**
Applicant's name..... : **E-Matic**
 Address..... : 3435 Ocean Park Blvd #107 PMB#444 Santa Monica CA 90405
 Manufacturer..... : SHENZHEN ZOWEE TECHNOLOGY CO., LTD.
 Address..... : Science &Technology Industrial Park of Privately
 Owned Enterprises, Pingshan, Xili, Nanshan District, Shenzhen, PR
 CHINA
Test item description : 7inch tablet pc-Cubby
 Trade Mark : Ematic
 Model/Type reference..... : CUBBY
 Listed Model(s) : M7017A; SPROUT CHANNEL CUBBY
Standard : **FCC CFR Title 47 Part 15 Subpart C Section 15.247**
 Date of receipt of test sample..... : July 03, 2015
 Date of testing..... : July 03, 2015- July 22, 2015
 Date of issue..... : July 22, 2015
Result..... : **PASS**

Compiled by
 (position+printedname+signature)....: File administrators Yingchun Shan 
 Supervised by
 (position+printedname+signature)....: Project Engineer Yingchun Shan 
 Approved by
 (position+printedname+signature)....: RF Manager Hans Hu 

Testing Laboratory Name : **Shenzhen Huatongwei International Inspection Co., Ltd**
 Address..... : Bldg3, Hongfa Hi-tech Industrial Park, Genyu Road, Shenzhen,
 China

Shenzhen Huatongwei International Inspection Co., Ltd. All rights reserved.
 This publication may be reproduced in whole or in part for non-commercial purposes as long as the Shenzhen Huatongwei International Inspection Co., Ltd is acknowledged as copyright owner and source of the material. Shenzhen Huatongwei International Inspection Co., Ltd takes no responsibility for and will not assume liability for damages resulting from the reader's interpretation of the reproduced material due to its placement and context.

Contents

1.	<u>TEST STANDARDS AND TEST DESCRIPTION</u>	3
1.1.	Test Standards	3
1.2.	Test Description	3
2.	<u>SUMMARY</u>	4
2.1.	Client Information	4
2.2.	Product Description	4
2.3.	Operation state	4
2.4.	EUT configuration	5
2.5.	Modifications	5
3.	<u>TEST ENVIRONMENT</u>	6
3.1.	Address of the test laboratory	6
3.2.	Test Facility	6
3.3.	Environmental conditions	7
3.4.	Statement of the measurement uncertainty	7
3.5.	Equipments Used during the Test	8
4.	<u>TEST CONDITIONS AND RESULTS</u>	9
4.1.	Antenna requirement	9
4.2.	Conducted Emission (AC Main)	10
4.3.	Conducted Peak Output Power	13
4.4.	20dB Emission Bandwidth	16
4.5.	Carrier Frequencies Separation	19
4.6.	Hopping Channel Number	21
4.7.	Dwell Time	23
4.8.	Pseudorandom Frequency Hopping Sequence	26
4.9.	Restricted band (radiated)	27
4.10.	Bandedge and Spurious Emission (conducted)	31
4.11.	Spurious Emission (radiated)	41
5.	<u>TEST SETUP PHOTOS OF THE EUT</u>	46
6.	<u>EXTERNAL AND INTERNAL PHOTOS OF THE EUT</u>	47

1. TEST STANDARDS AND TEST DESCRIPTION

1.1. Test Standards

The tests were performed according to following standards:

[FCC Rules Part 15.247](#): Frequency Hopping, Direct Spread Spectrum and Hybrid Systems that are in operation within the bands of 902-928 MHz, 2400-2483.5 MHz, and 5725-5850 MHz.

[ANSI C63.10-2013](#): American National Standard for Testing Unlicensed Wireless Devices

1.2. Test Description

ReportSection	Test Item	Section in CFR 47	Result
4.1	Antenna Requirement	15.203/15.247 (c)	Pass
4.2	AC Power Line Conducted Emission	15.207	Pass
4.3	Conducted Peak Output Power	15.247 (b)(1)	Pass
4.4	20dB Occupied Bandwidth	15.247 (a)(1)	Pass
4.5	Carrier Frequencies Separation	15.247 (a)(1)	Pass
4.6	Hopping Channel Number	15.247 (a)(1)	Pass
4.7	Dwell Time	15.247 (a)(1)	Pass
4.8	Pseudorandom Frequency Hopping Sequence	15.247(b)(4)&TCB Exclusion List (7 July 2002)	Pass
4.9	Restricted band	15.247(d)/15.205	Pass
4.10/4.11	Radiated Emission	15.247(d)/15.209	Pass

Remark: The measurement uncertainty is not included in the test result.

2. SUMMARY

2.1. Client Information

Applicant:	E-matic
Address:	3435 Ocean Park Blvd #107 PMB#444 Santa Monica CA 90405
Manufacturer:	SHENZHEN ZOWEE TECHNOLOGY CO., LTD.
Address:	Science & Technology Industrial Park of Privately Owned Enterprises, Pingshan, Xili, Nanshan District, Shenzhen, PR CHINA

2.2. Product Description

Name of EUT	7inch tablet pc-Cubby
Trade Mark:	Ematic
Model No.:	CUBBY
Listed Model(s):	M7017A; SPROUT CHANNEL CUBBY
Power supply:	DC3.70V From internal battery
Adapter information:	Model:JK050200-S04USA Input:100-240Va.c., 50/60Hz, 0.5A Output: 5.0Vd.c.,2.0A
Bluetooth	
Version:	Supported 2.1+EDR
Modulation:	GFSK, $\pi/4$ DQPSK, 8DPSK
Operation frequency:	2402MHz~2480MHz
Channel number:	79
Channel separation:	1MHz
Antenna type:	FPC
Antenna gain:	2.33dBi

2.3. Operation state

◆ Test frequency list

According to section 15.31(m), regards to the operating frequency range over 10 MHz, must select three channel which were tested. the Lowest frequency, the middle frequency, and the highest frequency of channel were selected to perform the test, please see the above gray bottom.

Channel	Frequency (MHz)
0	2402
1	2403
⋮	⋮
39	2441
⋮	⋮
77	2479
78	2480

◆ Test mode

For RF test items:

the engineering test program was provided and enabled to make EUT continuous transmit/receive.

For AC power line conducted emissions:

the EUT was set to connect with the Bluetooth under large package sizes transmission.

2.4. EUT configuration

The following peripheral devices and interface cables were connected during the measurement:

● - supplied by the manufacturer

○ - supplied by the lab

<input type="radio"/>	Power Cable	Length (m) :	/
		Shield :	/
		Detachable :	/
<input type="radio"/>	Multimeter	Manufacturer :	/
		Model No. :	/

2.5. Modifications

No modifications were implemented to meet testing criteria.

3. TEST ENVIRONMENT

3.1. Address of the test laboratory

Laboratory: Shenzhen Huatongwei International Inspection Co., Ltd. (Gongming)
Address: Bldg3, Hongfa Hi-tech Industrial Park, Genyu Road, Shenzhen, China
Phone: 86-755-26748019 Fax: 86-755-26748089

3.2. Test Facility

The test facility is recognized, certified, or accredited by the following organizations:

CNAS-Lab Code: L1225

Shenzhen Huatongwei International Inspection Co., Ltd. has been assessed and proved to be in compliance with CNAS-CL01 Accreditation Criteria for Testing and Calibration Laboratories (identical to ISO/IEC 17025: 2005 General Requirements) for the Competence of Testing and Calibration Laboratories, Date of Registration: February 28, 2015. Valid time is until February 27, 2018.

A2LA-Lab Cert. No. 2243.01

Shenzhen Huatongwei International Inspection Co., Ltd. EMC Laboratory has been accredited by A2LA for technical competence in the field of electrical testing, and proved to be in compliance with ISO/IEC 17025: 2005 General Requirements for the Competence of Testing and Calibration Laboratories and any additional program requirements in the identified field of testing. Valid time is until Sept 30, 2015.

FCC-Registration No.: 662850

Shenzhen Huatongwei International Inspection Co., Ltd. EMC Laboratory has been registered and fully described in a report filed with the FCC (Federal Communications Commission). The acceptance letter from the FCC is maintained in our files. Registration 662850, Renewal date April. 24, 2015, valid time is until April. 24, 2018

FCC-Registration No.: 317478

Shenzhen Huatongwei International Inspection Co., Ltd. (Gongming EMC Laboratory) has been registered and fully described in a report filed with the FCC (Federal Communications Commission). The acceptance letter from the FCC is maintained in our files. Registration 317478, Renewal date July 18, 2014, valid time is until July. 18, 2017.

IC-Registration No.: 5377A

The 3m Alternate Test Site of Shenzhen Huatongwei International Inspection Co., Ltd. has been registered by Certification and Engineering Bureau of Industry Canada for the performance of radiated measurements with Registration No. 5377A on Dec. 31, 2013, valid time is until Dec. 31, 2016.

IC-Registration No.: 5377B

The 3m Alternate Test Site of Shenzhen Huatongwei International Inspection Co., Ltd. (Gongming EMC Laboratory) has been registered by Certification and Engineering Bureau of Industry Canada for the performance of radiated measurements with Registration No. 5377B on September 3, 2014, valid time is until September 3, 2017.

ACA

Shenzhen Huatongwei International Inspection Co., Ltd. EMC Laboratory can also perform testing for the Australian C-Tick mark as a result of our A2LA accreditation.

VCCI

The 3m Semi-anechoic chamber (12.2m x 7.95m x 6.7m) of Shenzhen Huatongwei International Inspection Co., Ltd. has been registered in accordance with the Regulations for Voluntary Control Measures with Registration No.: R-2484. Date of Registration: Dec. 20, 2012. Valid time is until Dec. 29, 2015.

Radiated disturbance above 1GHz measurement of Shenzhen Huatongwei International Inspection Co., Ltd. has been registered in accordance with the Regulations for Voluntary Control Measures with Registration No.: G-292. Date of Registration: Dec. 24, 2013. Valid time is until Dec. 23, 2016.

Main Ports Conducted Interference Measurement of Shenzhen Huatongwei International Inspection Co., Ltd. has been registered in accordance with the Regulations for Voluntary Control Measures with Registration No.: C-2726. Date of Registration: Dec. 20, 2012. Valid time is until Dec. 19, 2015.

Telecommunication Ports Conducted Interference Measurement of Shenzhen Huatongwei International Inspection Co., Ltd. has been registered in accordance with the Regulations for Voluntary Control Measures with Registration No.: T-1837. Date of Registration: May 07, 2013. Valid time is until May 06, 2016.

DNV

Shenzhen Huatongwei International Inspection Co., Ltd. has been found to comply with the requirements of DNV towards subcontractor of EMC and safety testing services in conjunction with the EMC and Low voltage Directives and in the voluntary field. The acceptance is based on a formal quality Audit and follow-ups according to relevant parts of ISO/IEC Guide 17025 (2005), in accordance with the requirements of the DNV Laboratory Quality Manual towards subcontractors. Valid time is until Aug. 24, 2016.

3.3. Environmental conditions

During the measurement the environmental conditions were within the listed ranges:

Temperature:	15~35°C
Relative Humidity:	30~60 %
Air Pressure:	950~1050mbar

3.4. Statement of the measurement uncertainty

The data and results referenced in this document are true and accurate. The reader is cautioned that there may be errors within the calibration limits of the equipment and facilities. The measurement uncertainty was calculated for all measurements listed in this test report according to TR-100028-01 "Electromagnetic compatibility and Radio spectrum Matters (ERM); Uncertainties in the measurement of mobile radio equipment characteristics; Part 1" and TR-100028-02 "Electromagnetic compatibility and Radio spectrum Matters (ERM); Uncertainties in the measurement of mobile radio equipment characteristics; Part 2" and is documented in the Shenzhen Huatongwei International Inspection Co., Ltd quality system according to DIN EN ISO/IEC 17025. Furthermore, component and process variability of devices similar to that tested may result in additional deviation. The manufacturer has the sole responsibility of continued compliance of the device.

Hereafter the best measurement capability for Shenzhen Huatongwei laboratory is reported:

Test Items	Measurement Uncertainty	Notes
Transmitter power conducted	0.57 dB	(1)
Transmitter power Radiated	2.20 dB	(1)
Conducted spurious emission 9KHz-40 GHz	1.60 dB	(1)
Radiated spurious emission 9KHz-40 GHz	2.20 dB	(1)
Conducted Emission 9KHz-30MHz	3.39 dB	(1)
Radiated Emission 30~1000MHz	4.24 dB	(1)
Radiated Emission 1~18GHz	5.16 dB	(1)
Radiated Emission 18-40GHz	5.54 dB	(1)
Occupied Bandwidth	-----	(1)

(1) This uncertainty represents an expanded uncertainty expressed at approximately the 95% confidence level using a coverage factor of $k=1.96$.

3.5. Equipments Used during the Test

Conducted Emission (AC Main)					
Item	Test Equipment	Manufacturer	Model No.	Serial No.	Last Cal
1	Artificial Mains	Rohde&Schwarz	ESH2-Z5	100028	2014/11/01
2	EMI Test Receiver	Rohde&Schwarz	ESCI3	100038	2014/11/01
3	Pulse Limiter	Rohde&Schwarz	ESHSZ2	100044	2014/11/01
4	EMI Test Software	Rohde&Schwarz	ES-K1 V1.71	N/A	N/A

Radiated Emission					
Item	Test Equipment	Manufacturer	Model No.	Serial No.	Last Cal
1	Ultra-Broadband Antenna	ShwarzBeck	VULB9163	538	2014/11/01
2	EMI TEST RECEIVER	Rohde&Schwarz	ESI 26	100009	2014/11/01
3	EMI TEST Software	Audix	E3	N/A	N/A
4	TURNTABLE	ETS	2088	2149	N/A
5	ANTENNA MAST	ETS	2075	2346	N/A
6	EMI TEST Software	Rohde&Schwarz	ESK1	N/A	N/A
7	HORNANTENNA	ShwarzBeck	9120D	1011	2014/11/01
8	Amplifer	Sonoma	310N	E009-13	2014/11/01
9	JS amplifer	Rohde&Schwarz	JS4-00101800-28-5A	F201504	2014/11/01
10	High pass filter	Compliance Direction systems	BSU-6	34202	2014/11/01
11	HORNANTENNA	ShwarzBeck	9120D	1012	2014/11/01
12	Amplifer	Compliance Direction systems	PAP1-4060	120	2014/11/01
13	Loop Antenna	Rohde&Schwarz	HFH2-Z2	100020	2014/11/01
14	TURNTABLE	MATURO	TT2.0	----	N/A
15	ANTENNA MAST	MATURO	TAM-4.0-P	----	N/A
16	Horn Antenna	SCHWARZBECK	BBHA9170	25841	2014/11/01
17	ULTRA-BROADBAND ANTENNA	Rohde&Schwarz	HL562	100015	2014/11/01

Maximum Peak Output Power / Power Spectral Density / 6dB Bandwidth / Band Edge Compliance of RF Emission / Spurious RF Conducted Emission					
Item	Test Equipment	Manufacturer	Model No.	Serial No.	Last Cal
1	Spectrum Analyzer	Rohde&Schwarz	FSP	1164.4391.40	2014/11/01

The Cal.Interval was one year

4. TEST CONDITIONS AND RESULTS

4.1. Antenna requirement

Requirement

FCC CFR Title 47 Part 15 Subpart C Section 15.203:

An intentional radiator shall be designed to ensure that no antenna other than that furnished by the responsible party shall be used with the device. The use of a permanently attached antenna or of an antenna that uses a unique coupling to the intentional radiator, the manufacturer may design the unit so that a broken antenna can be replaced by the user, but the use of a standard antenna jack or electrical connector is prohibited.

FCC CFR Title 47 Part 15 Subpart C Section 15.247(c) (1)(i):

(i) Systems operating in the 2400-2483.5 MHz band that is used exclusively for fixed. Point-to-point operations may employ transmitting antennas with directional gain greater than 6dBi provided the maximum conducted output power of the intentional radiator is reduced by 1 dB for every 3 dB that the directional gain of the antenna exceeds 6dBi.

Test Result:

The antenna is integral antenna, the best case gain of the antenna is 2.33dBi.

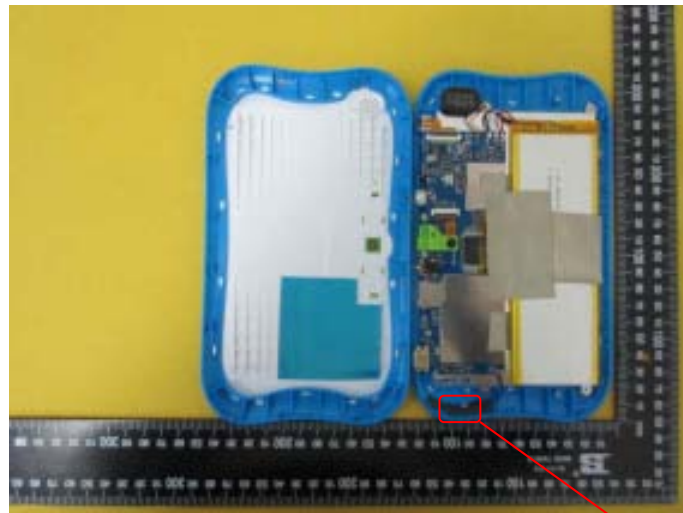

WiFi/BT Antenna

4.2. Conducted Emission (AC Main)

LIMIT

FCC CFR Title 47 Part 15 Subpart C Section 15.207

Frequency range (MHz)	Limit (dBuV)	
	Quasi-peak	Average
0.15-0.5	66 to 56*	56 to 46*
0.5-5	56	46
5-30	60	50

* Decreases with the logarithm of the frequency.

TEST CONFIGURATION

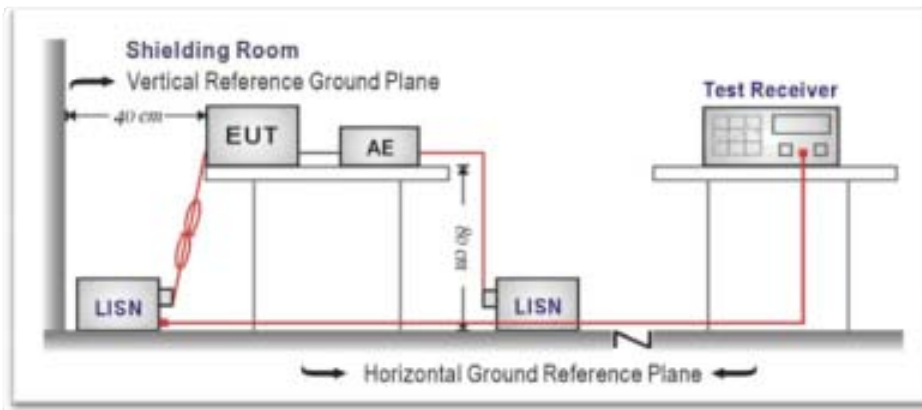

TEST PROCEDURE

1. The EUT was setup according to ANSI C63.4: 2014 and tested according to ANSI C63.10:2013 for compliance to FCC 47CFR 15.247 requirements.
2. The EUT was placed on a platform of nominal size, 1 m by 1.5 m, raised 80 cm above the conducting ground plane. The vertical conducting plane was located 40 cm to the rear of the EUT. All other surfaces of EUT were at least 80 cm from any other grounded conducting surface.
3. The EUT and simulators are connected to the main power through a line impedance stabilization network (LISN). The LISN provides a 50 ohm / 50uH coupling impedance for the measuring equipment.
4. The peripheral devices are also connected to the main power through a LISN. (Please refer to the block diagram of the test setup and photographs)
5. Each current-carrying conductor of the EUT power cord, except the ground (safety) conductor, was individually connected through a LISN to the input power source.
6. The excess length of the power cord between the EUT and the LISN receptacle were folded back and forth at the center of the lead to form a bundle not exceeding 40 cm in length.
7. Conducted emissions were investigated over the frequency range from 0.15 MHz to 30 MHz using a receiver bandwidth of 9 kHz.

TEST RESULTS

Test mode:	BT	Polarization	L
------------	----	--------------	---

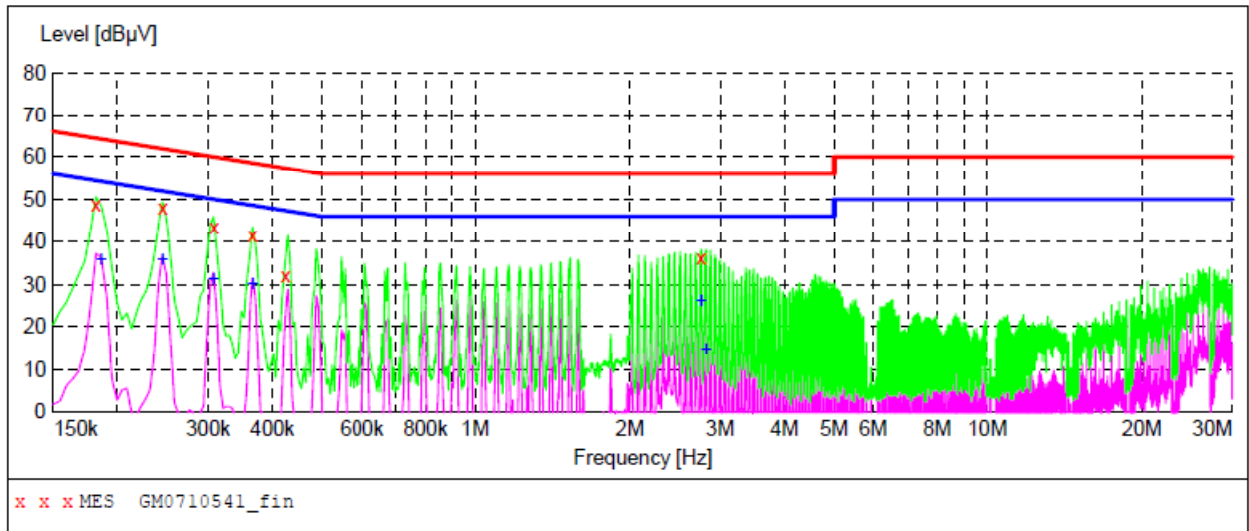

MEASUREMENT RESULT: "GM0710541_fin"

7/10/2015 4:24PM

Frequency MHz	Level dBµV	Transd dB	Limit dBµV	Margin dB	Detector	Line	PE
0.181500	48.80	10.2	64	15.6	QP	L1	GND
0.244500	48.00	10.2	62	13.9	QP	L1	GND
0.307500	43.60	10.2	60	16.4	QP	L1	GND
0.366000	41.60	10.2	59	17.0	QP	L1	GND
0.424500	32.20	10.2	57	25.2	QP	L1	GND
2.751000	36.40	10.3	56	19.6	QP	L1	GND

MEASUREMENT RESULT: "GM0710541_fin2"

7/10/2015 4:24PM

Frequency MHz	Level dBµV	Transd dB	Limit dBµV	Margin dB	Detector	Line	PE
0.186000	35.90	10.2	54	18.3	AV	L1	GND
0.244500	36.10	10.2	52	15.8	AV	L1	GND
0.307500	31.60	10.2	50	18.4	AV	L1	GND
0.366000	30.40	10.2	49	18.2	AV	L1	GND
2.755500	26.30	10.3	46	19.7	AV	L1	GND
2.814000	14.90	10.3	46	31.1	AV	L1	GND

Test mode:	BT	Polarization	N
------------	----	--------------	---

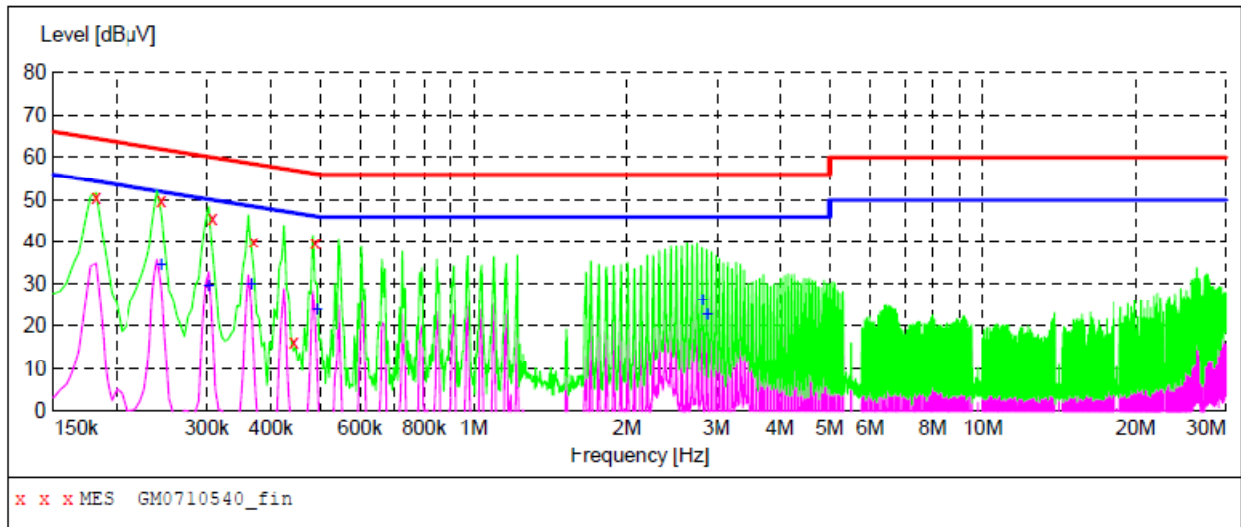

MEASUREMENT RESULT: "GM0710540_fin"

7/10/2015 4:21PM

Frequency MHz	Level dBµV	Transd dB	Limit dBµV	Margin dB	Detector	Line	PE
0.181500	50.50	10.2	64	13.9	QP	N	GND
0.244500	49.70	10.2	62	12.2	QP	N	GND
0.307500	45.70	10.2	60	14.3	QP	N	GND
0.370500	40.00	10.2	59	18.5	QP	N	GND
0.442500	16.30	10.2	57	40.7	QP	N	GND
0.487500	39.70	10.2	56	16.5	QP	N	GND

MEASUREMENT RESULT: "GM0710540_fin2"

7/10/2015 4:21PM

Frequency MHz	Level dBµV	Transd dB	Limit dBµV	Margin dB	Detector	Line	PE
0.244500	34.30	10.2	52	17.6	AV	N	GND
0.303000	29.50	10.2	50	20.7	AV	N	GND
0.366000	29.80	10.2	49	18.8	AV	N	GND
0.492000	23.70	10.2	46	22.4	AV	N	GND
2.809500	26.30	10.3	46	19.7	AV	N	GND
2.872500	22.90	10.3	46	23.1	AV	N	GND

4.3. Conducted Peak Output Power

LIMIT

FCC CFR Title 47 Part 15 Subpart C Section 15.247 (b)(3): **30dBm**

TEST CONFIGURATION

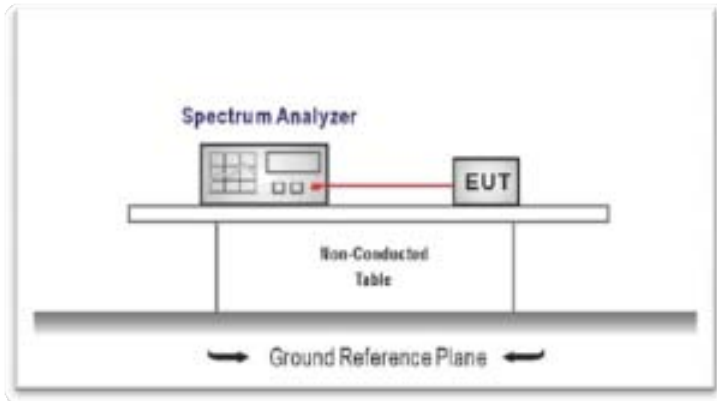

TEST PROCEDURE

Remove the antenna from the EUT and then connect a low loss RF cable from the antenna port to the spectrum.

TEST RESULTS

Modulation type	Channel	Output power (dBm)	Limit (dBm)	Result
GFSK	00	1.66	30.00	Pass
	39	1.33		
	78	1.03		
π/4DQPSK	00	0.50	21.00	Pass
	39	0.77		
	78	0.53		
8DPSK	00	0.41	21.00	Pass
	39	0.74		
	78	0.47		

Test plot as follows:

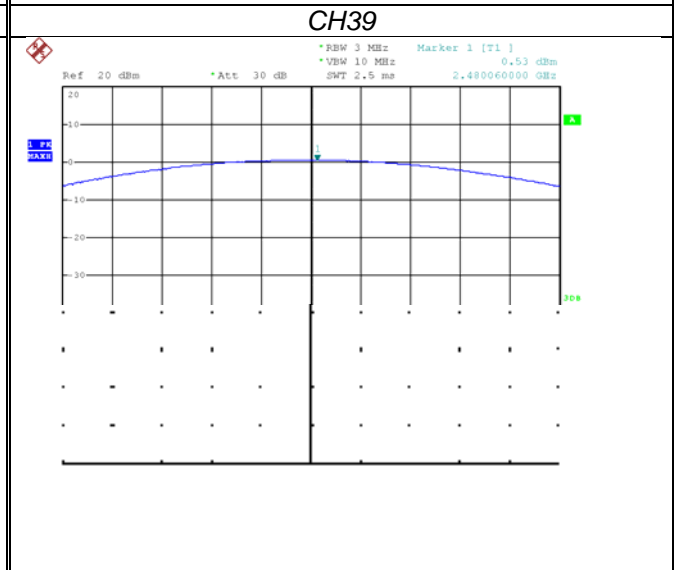
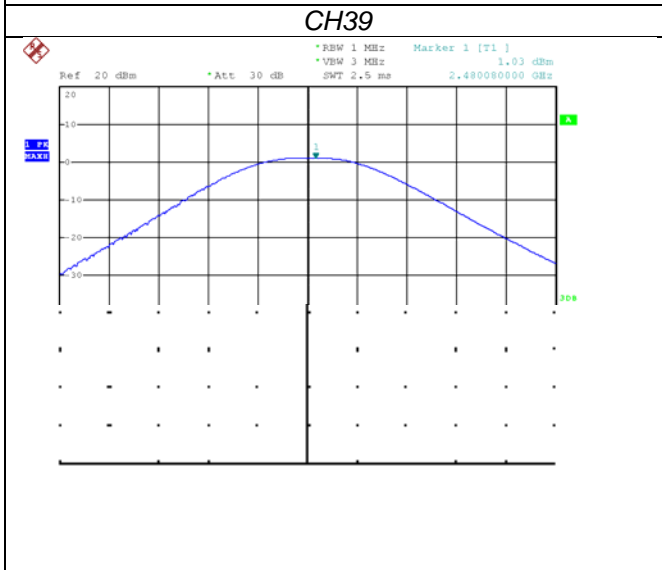
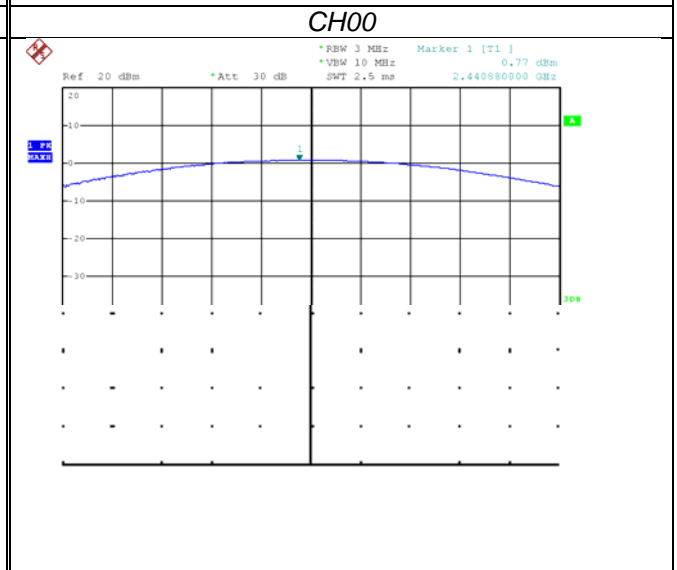
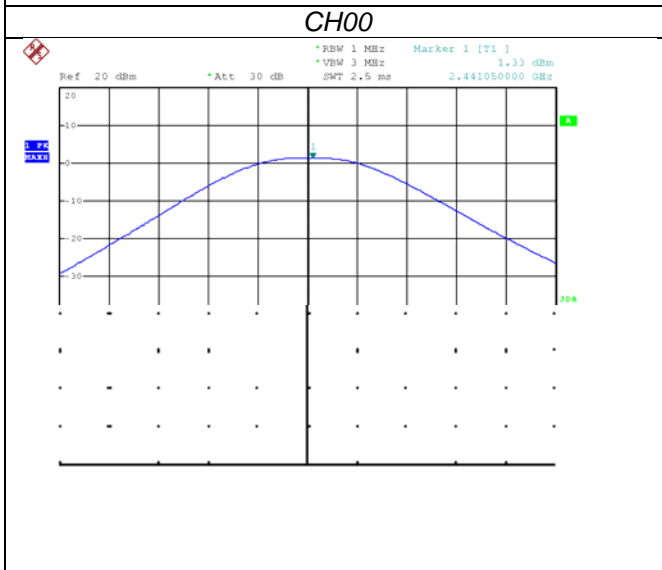
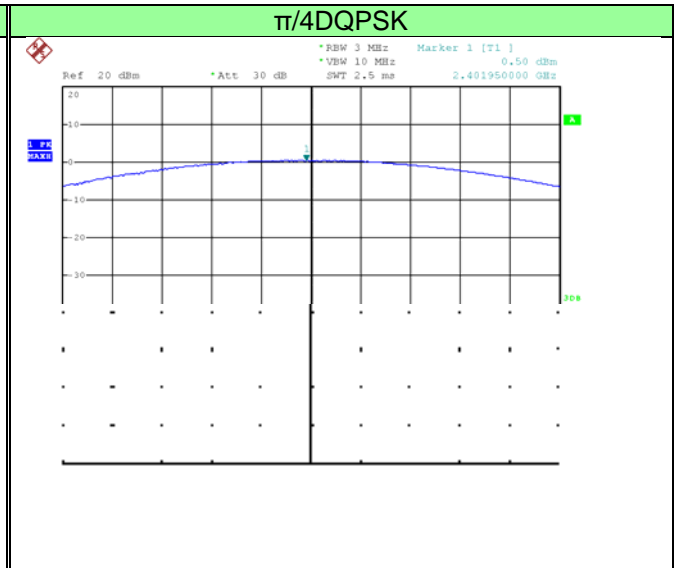
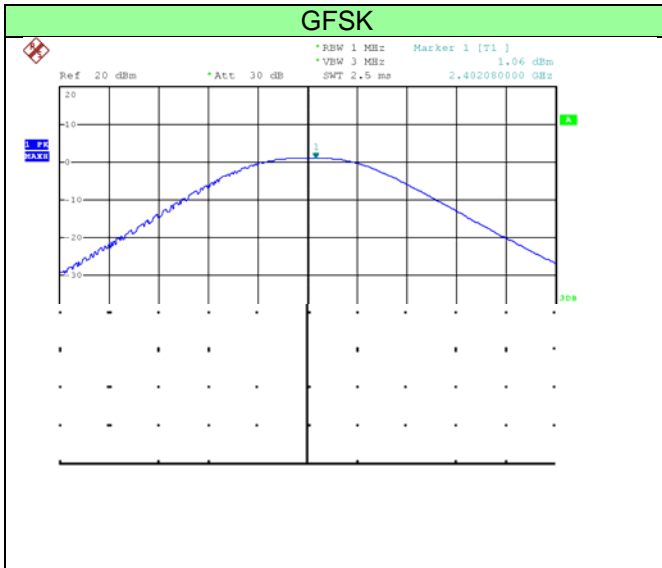

CH78

CH78

8DPSK

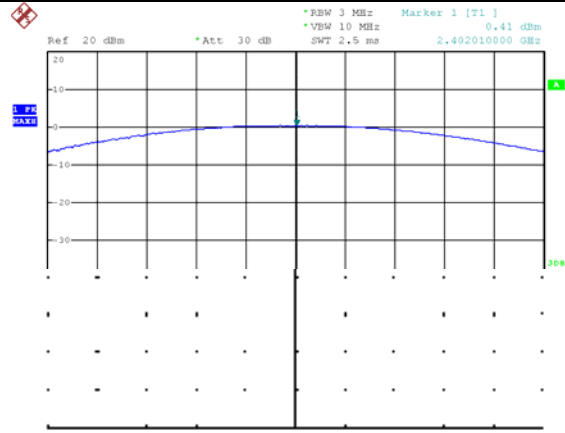

CH00

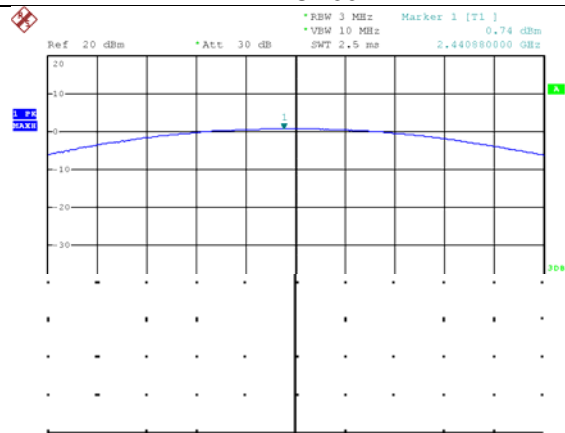

CH39

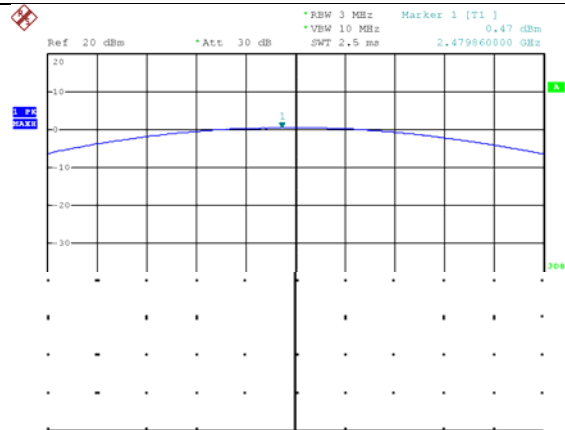

CH78

4.4. 20dB Emission Bandwidth

LIMIT

N/A

TEST CONFIGURATION

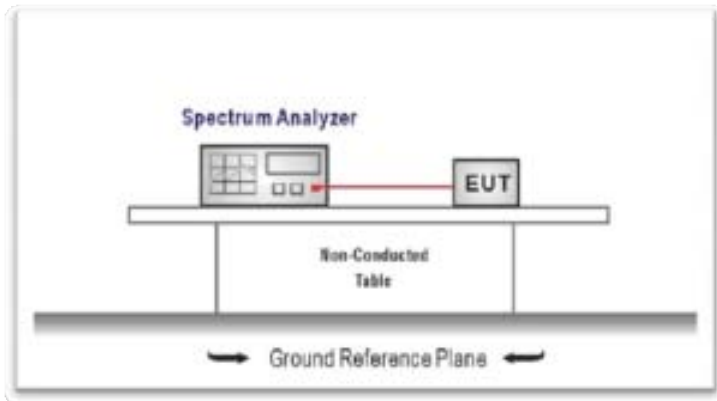

TEST PROCEDURE

1. The transmitter output was connected to the spectrum analyzer through an attenuator.
2. The bandwidth of the fundamental frequency was measured by spectrum analyzer with $RBW \geq 1\%$ of the 20 dB bandwidth and $VBW \geq RBW$.
3. The 20dB bandwidth is defined as the total spectrum the power of which is higher than peak power minus 20dB.

TEST RESULTS

Modulation type	Channel	20dB Bandwidth (MHz)	Limit (MHz)	Result
GFSK	00	0.690	/	Pass
	39	0.690		
	78	0.690		
$\pi/4$ DQPSK	00	1.150	/	Pass
	39	1.130		
	78	1.130		
8DPSK	00	1.170	/	Pass
	39	1.170		
	78	1.170		

Test plot as follows:

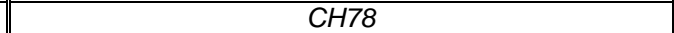
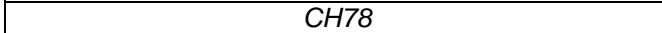
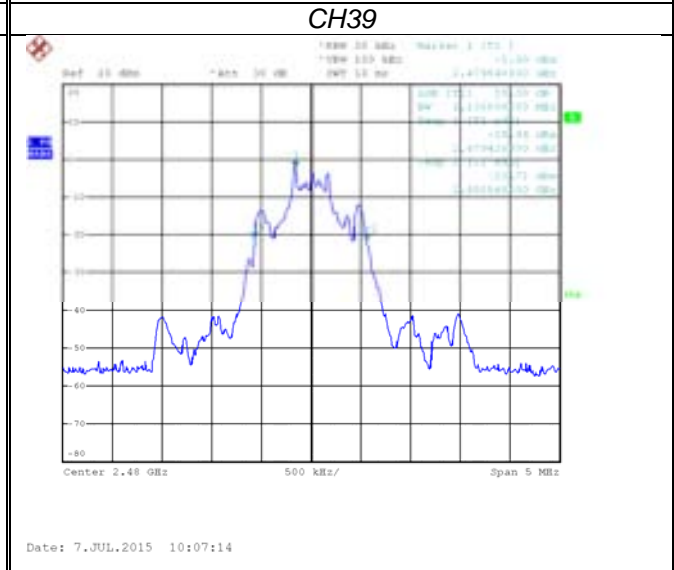
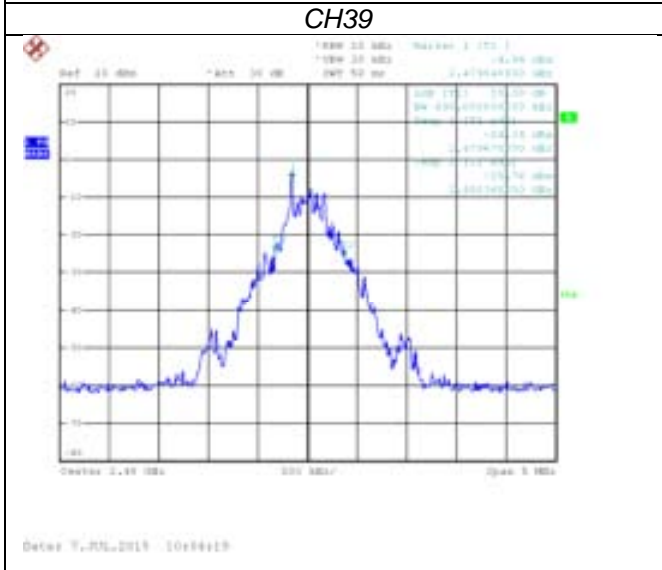
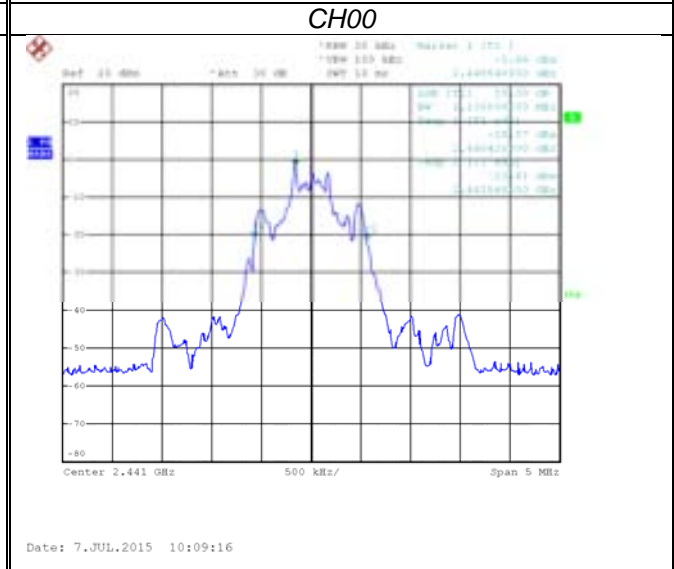
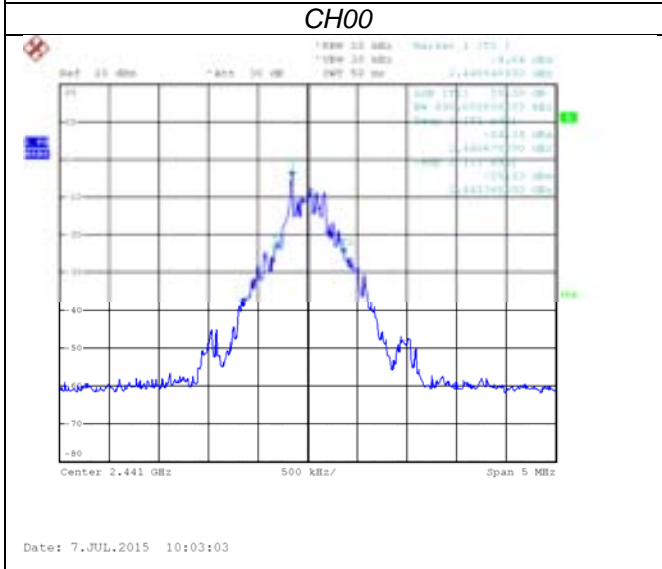

8DPSK

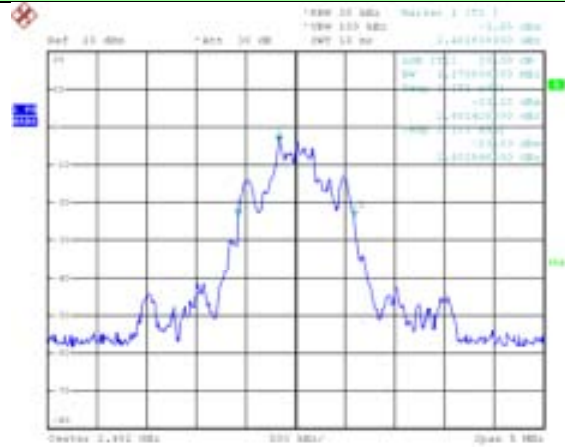

Date: 7.JUL.2015 10:15:19

CH00

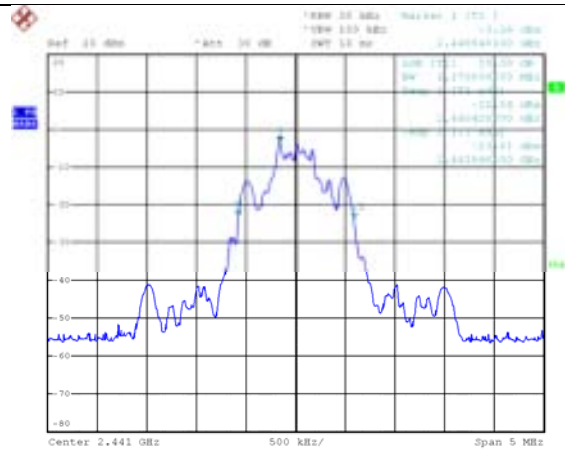

Date: 7.JUL.2015 10:16:26

CH39

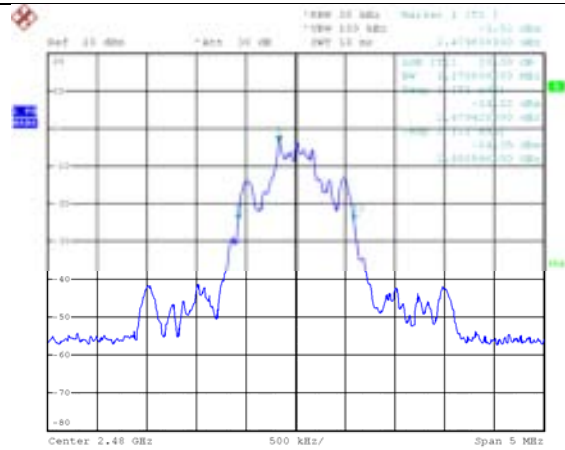

Date: 7.JUL.2015 10:17:02

CH78

4.5. Carrier Frequencies Separation

LIMIT

FCC CFR Title 47 Part 15 Subpart C Section 15.247 (a)(1): frequency hopping systems shall have hopping channel carrier frequencies separated by minimum of 25KHz or the $\frac{2}{3} * 20\text{dB}$ bandwidth of the hopping channel, whichever is greater.

TEST CONFIGURATION

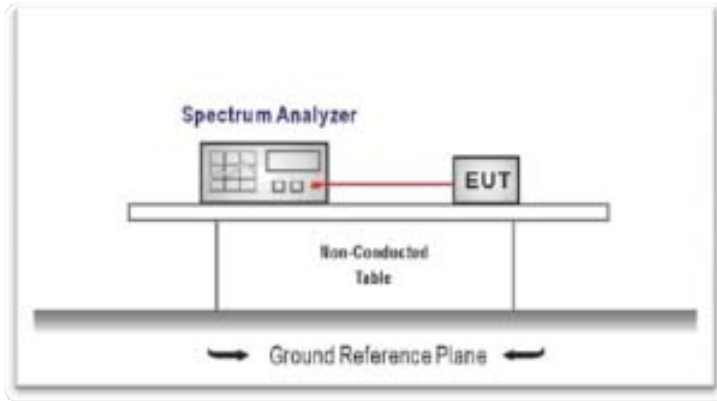

TEST PROCEDURE

1. The transmitter output was connected to the spectrum analyzer through an attenuator.
2. The bandwidth of the fundamental frequency was measured by spectrum analyzer with RBW=30 KHz and VBW=100KHz.

TEST RESULTS

Modulation type	Channel	Carrier Frequencies Separation (MHz)	Limit (MHz)	Result
GFSK	39	1.000	0.580	Pass
$\pi/4$ DQPSK	39	1.000	0.764	Pass
8DPSK	39	1.000	0.752	Pass

Test plot as follows:

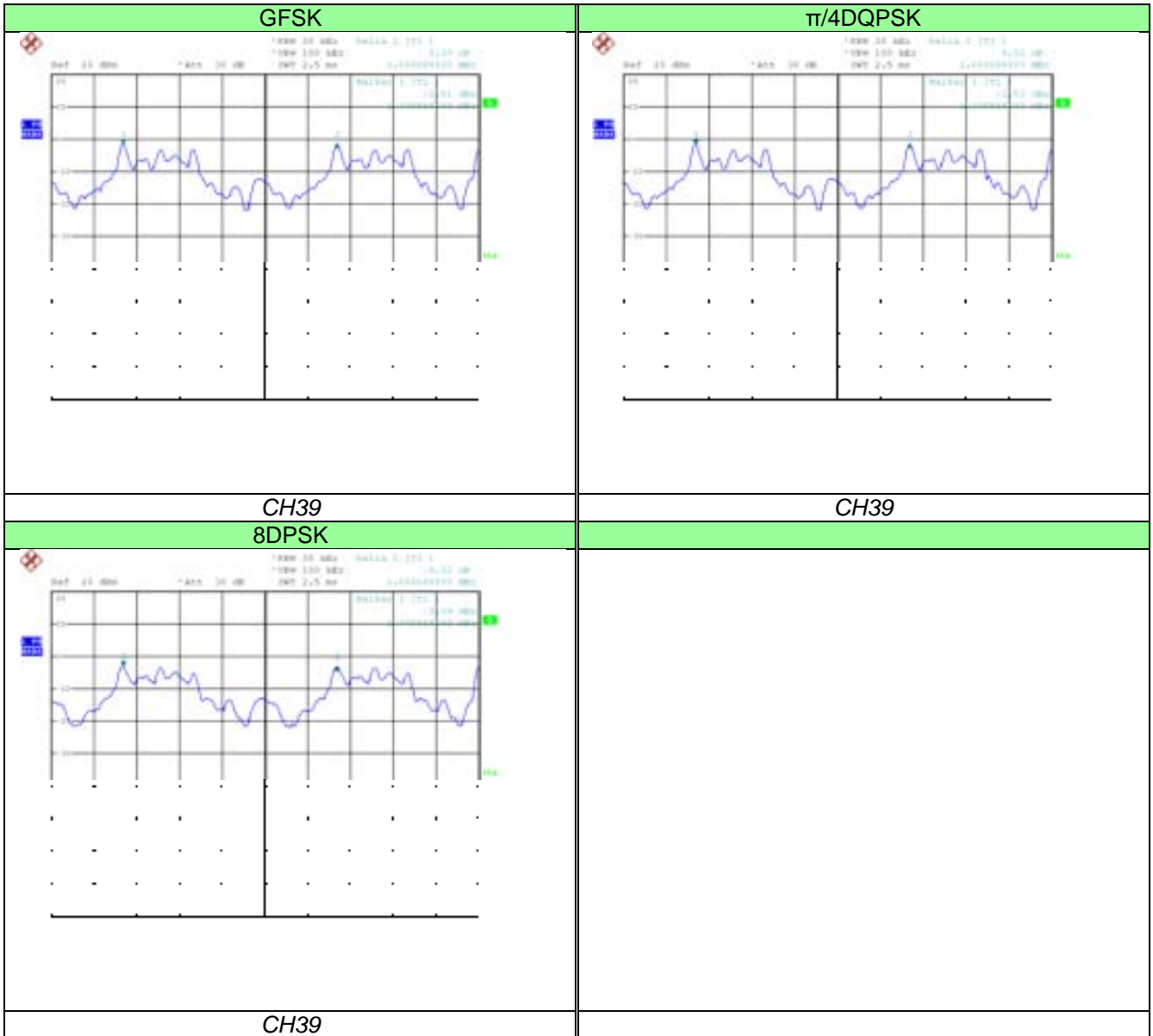

4.6. Hopping Channel Number

LIMIT

FCC CFR Title 47 Part 15 Subpart C Section 15.247 (a)(1):

Frequency hopping systems in the 2400–2483.5 MHz band shall use at least **15** channels.

TEST CONFIGURATION

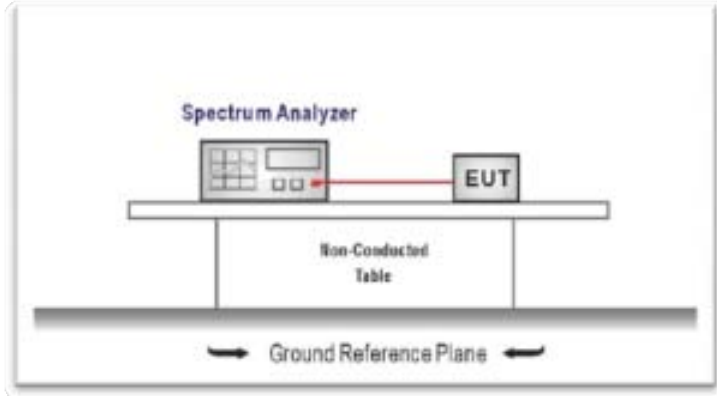

TEST PROCEDURE

1. The transmitter output was connected to the spectrum analyzer through an attenuator.
2. The bandwidth of the fundamental frequency was measured by spectrum analyzer with RBW=1MHz and VBW=3MHz.

TEST RESULTS

Modulation type	Channel number	Limit (MHz)	Result
GFSK	79	15	Pass
$\pi/4$ DQPSK	79		
8DPSK	79		

Test plot as follows:

4.7. Dwell Time

LIMIT

FCC CFR Title 47 Part 15 Subpart C Section 15.247 (a)(1):

The average time of occupancy on any channel shall not be greater than 0.4 seconds within a pe-riod of 0.4 seconds multiplied by the number of hopping channels employed.

TEST CONFIGURATION

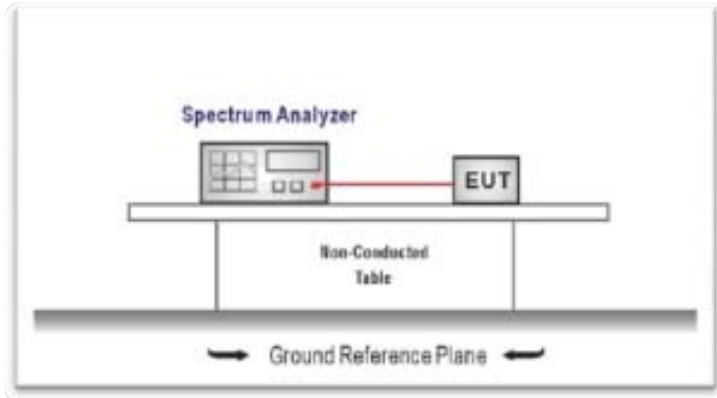

TEST PROCEDURE

1. The transmitter output was connected to the spectrum analyzer through an attenuator.
2. Set center frequency of spectrum analyzer=operating frequency with RBW=1MHz and VBW=3MHz, Span=0Hz.

TEST RESULTS

Modulation type	Channel	Dwell time (Second)	Limit (Second)	Result
GFSK	DH1	0.166	0.40	Pass
	DH3	0.274		
	DH5	0.320		
π/4DQPSK	2-DH1	0.166	0.40	Pass
	2-DH3	0.274		
	2-DH5	0.320		
8DPSK	3-DH1	0.166	0.40	Pass
	3-DH3	0.275		
	3-DH5	0.311		

Note:

1. We have tested all mode at high,middle and low channel,and recoreded worst case at middle channel.
2. Dwell time=Pulse time (ms) × (1600 ÷ 2 ÷ 79) ×31.6 Second for DH1, 2-DH1, 3-DH1
 Dwell time=Pulse time (ms) × (1600 ÷ 4 ÷ 79) ×31.6 Second for DH3, 2-DH3, 3-DH3
 Dwell time=Pulse time (ms) × (1600 ÷ 6 ÷ 79) ×31.6 Second for DH5, 2-DH5, 3-DH5

Test plot as follows:

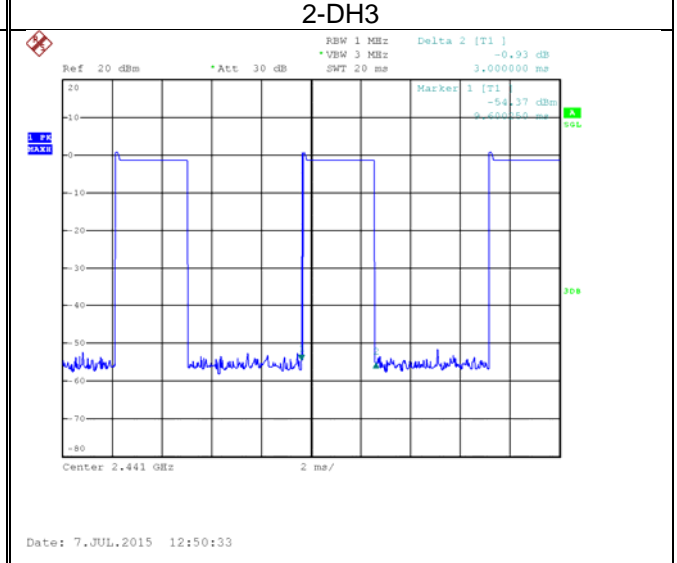
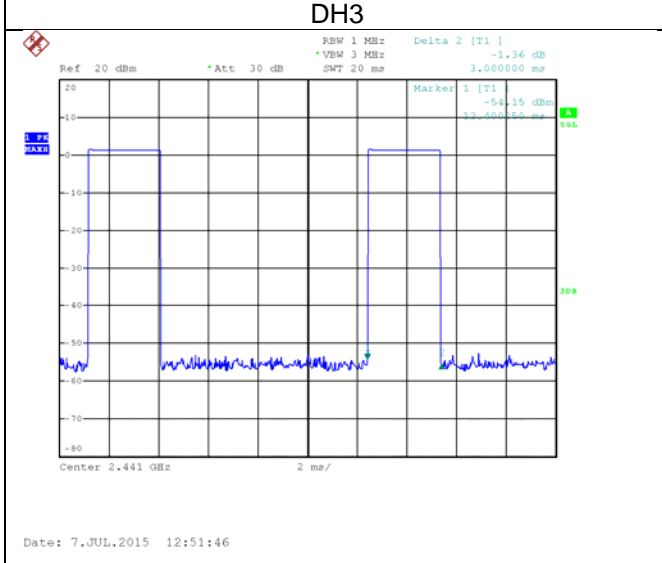
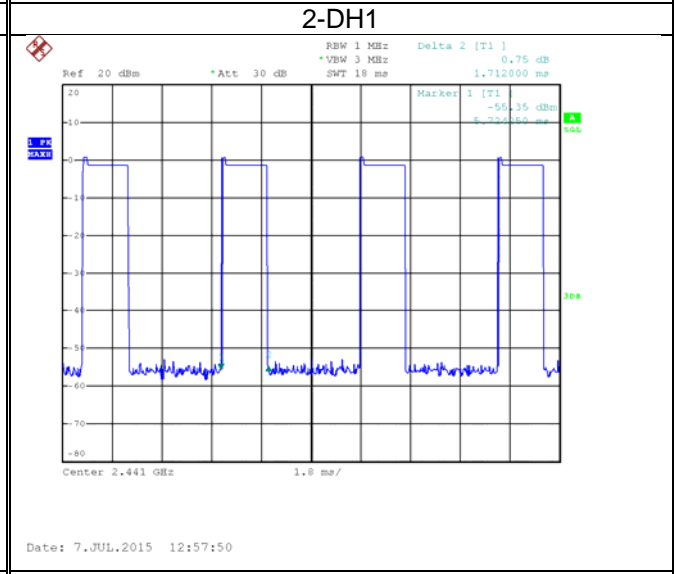
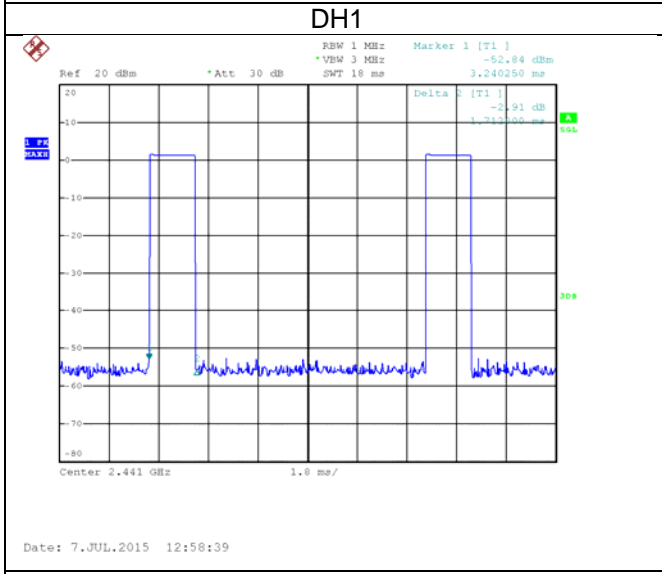
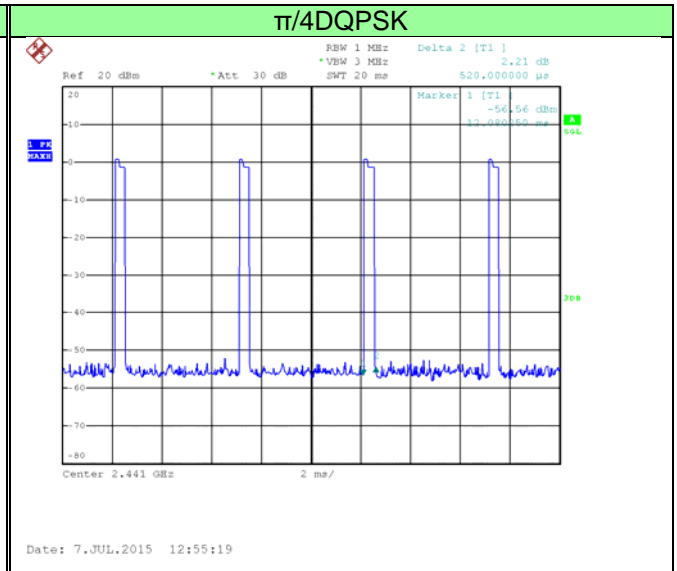
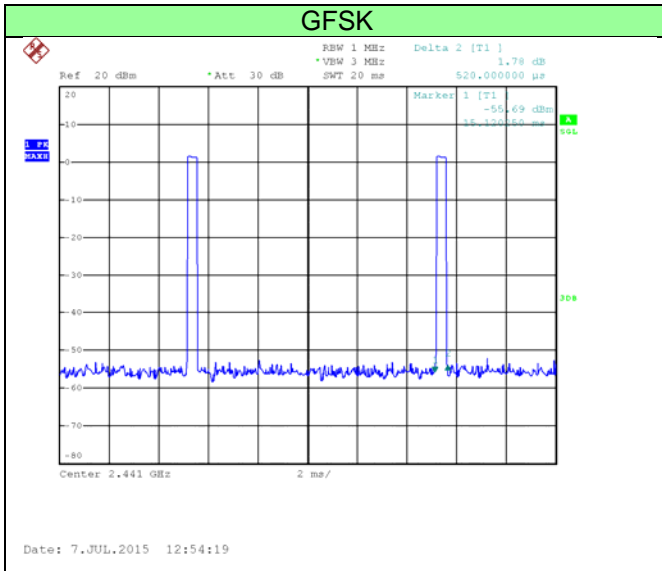

DH5

2-DH5

8DPSK

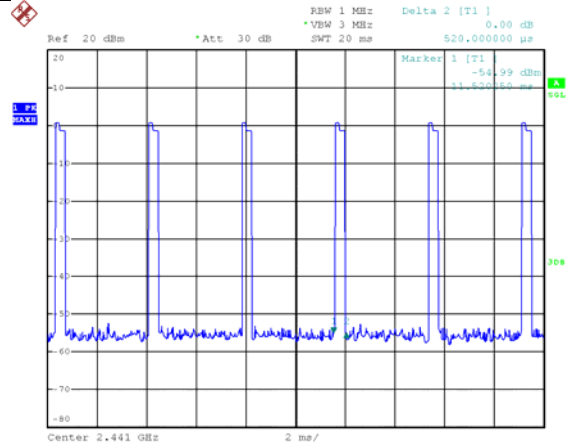

Date: 7.JUL.2015 12:56:10

3-DH1

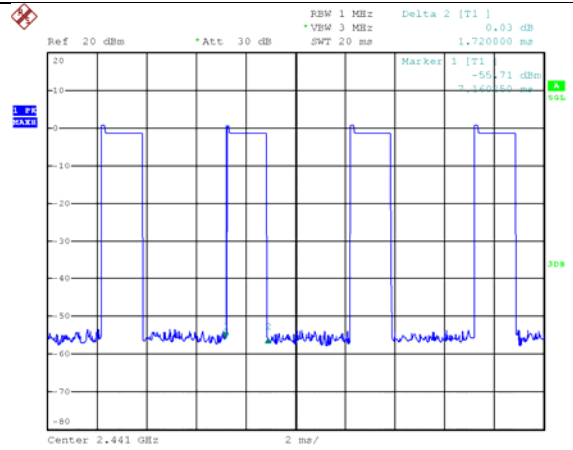

Date: 7.JUL.2015 12:56:43

3-DH3

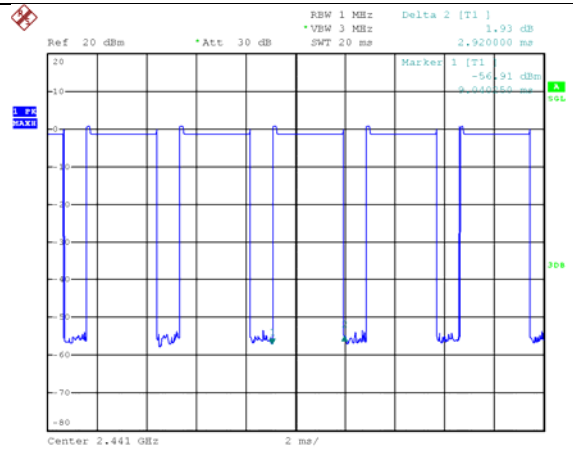

Date: 7.JUL.2015 12:52:42

3-DH5

4.8. Pseudorandom Frequency Hopping Sequence

LIMIT

FCC CFR Title 47 Part 15 Subpart C Section 15.247 (a)(1):

Frequency hopping systems shall have hopping channel carrier frequencies separated by a minimum of 25 kHz or the 20 dB bandwidth of the hopping channel, whichever is greater. Alternatively, frequency hopping systems operating in the 2400–2483.5 MHz band may have hopping channel carrier frequencies that are separated by 25 kHz or two-thirds of the 20 dB bandwidth of the hopping channel, whichever is greater, provided the systems operate with an output power no greater than 125 mW. The system shall hop to channel frequencies that are selected at the system hopping rate from a pseudo randomly ordered list of hopping frequencies. Each frequency must be used equally on the average by each transmitter. The system receivers shall have input bandwidths that match the hopping channel bandwidths of their corresponding transmitters and shall shift frequencies in synchronization with the transmitted signals.

TEST RESULTS

The pseudorandom frequency hopping sequence may be generated in a nine-stage shift register whose 5th and 9th stage outputs are added in a modulo-two addition stage. And the result is fed back to the input of the first stage. The sequence begins with the first one of 9 consecutive ones, for example: the shift register is initialized with nine ones.

- Number of shift register stages:9
- Length of pseudo-random sequence:29-1=511 bits
- Longest sequence of zeros:8(non-inverted signal)

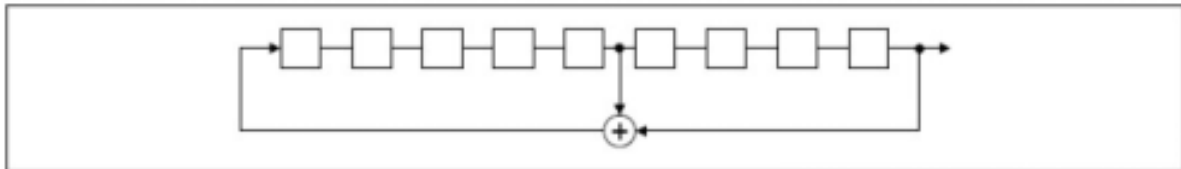

Linear Feedback Shift Register for Generation of the PRBS sequence

An example of pseudorandom frequency hopping sequence as follows:

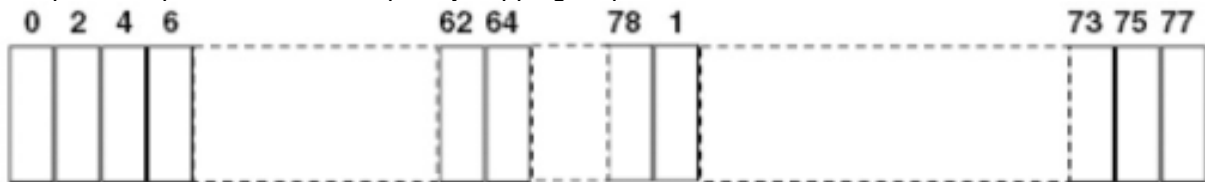

Each frequency used equally one the average by each transmitter.

The system receiver have input bandwidths that match the hopping channel bandwidths of their corresponding transmitter and shift frequencies in synchronization with the transmitted signals.

4.9. Restricted band (radiated)

LIMIT

FCC CFR Title 47 Part 15 Subpart C Section 15.209

Frequency	Limit (dBuV/m @3m)	Value
Above 1GHz	54.00	Average
	74.00	Peak

TEST CONFIGURATION

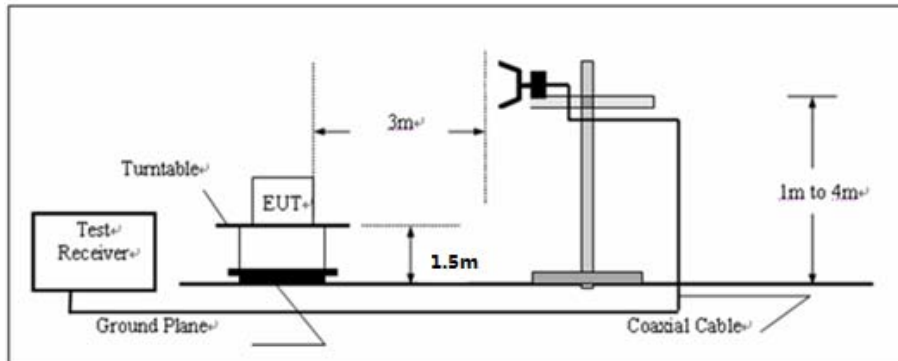

TEST PROCEDURE

1. The EUT was setup according to ANSI C63.4: 2014 and tested according to ANSI C63.10:2013 for compliance to FCC 47CFR 15.247 requirements.
2. The EUT is placed on a turn table which is 0.8 meter above ground. The turn table is rotated 360 degrees to determine the position of the maximum emission level.
3. The EUT was positioned such that the distance from antenna to the EUT was 3 meters.
4. The antenna is scanned from 1 meter to 4 meters to find out the maximum emission level. This is repeated for both horizontal and vertical polarization of the antenna. In order to find the maximum emission, all of the interface cables were manipulated according to ANSI C63.4:2014 on radiated measurement.
5. The receiver set as follow:
 RBW=1MHz, VBW=3MHz for Peak value
 RBW=1MHz, VBW=10Hz for Average value.
6. The frequency range from 2310MHz to 2483.5MHz harmonic is checked.

TEST RESULTS

Worst mode:	GFSK Modulation	Test Channel:	00
Detector:	Peak	Polarization:	Horizontal

Data: 17 File: D:\E3 Project RF Project 2015\TRE15060128.EM6 (18)

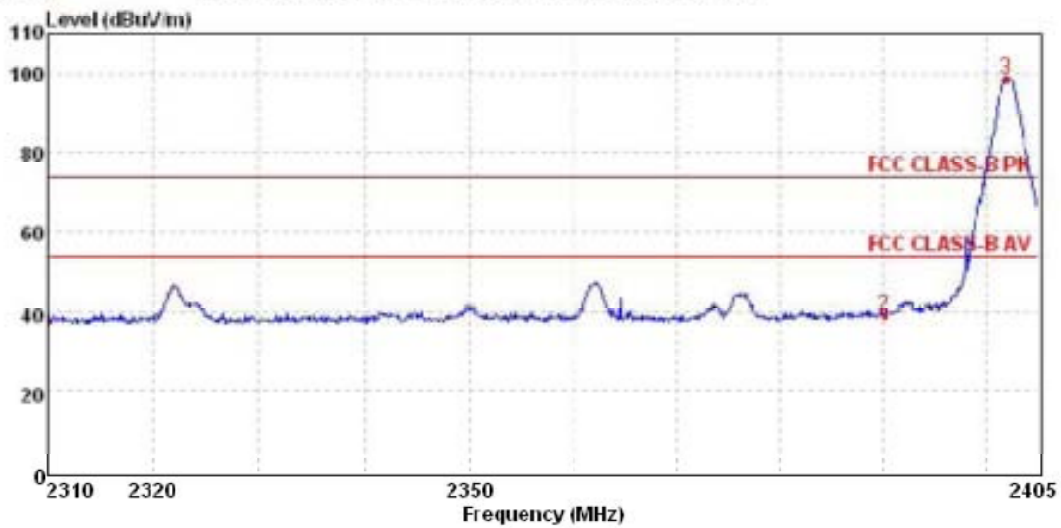

Mark	Frequency MHz	Reading dBuV/m	Antenna dB	Cable dB	Preamp dB	Level dBuV/m	Limit dBuV/m	Over limit	Remark
1	2310.00	41.33	27.27	6.68	37.51	37.77	74.00	-36.23	Peak
2	2390.02	42.53	27.53	6.81	37.57	39.30	74.00	-34.70	Peak
3	2401.98	102.19	27.57	6.83	37.58	99.01	74.00	25.01	Peak

Worst mode:	GFSK Modulation	Test Channel:	00
Detector:	Peak	Polarization:	Vertical

Data: 25 File: D:\E3 Project RF Project 2015\TRE15060128.EM6 (28)

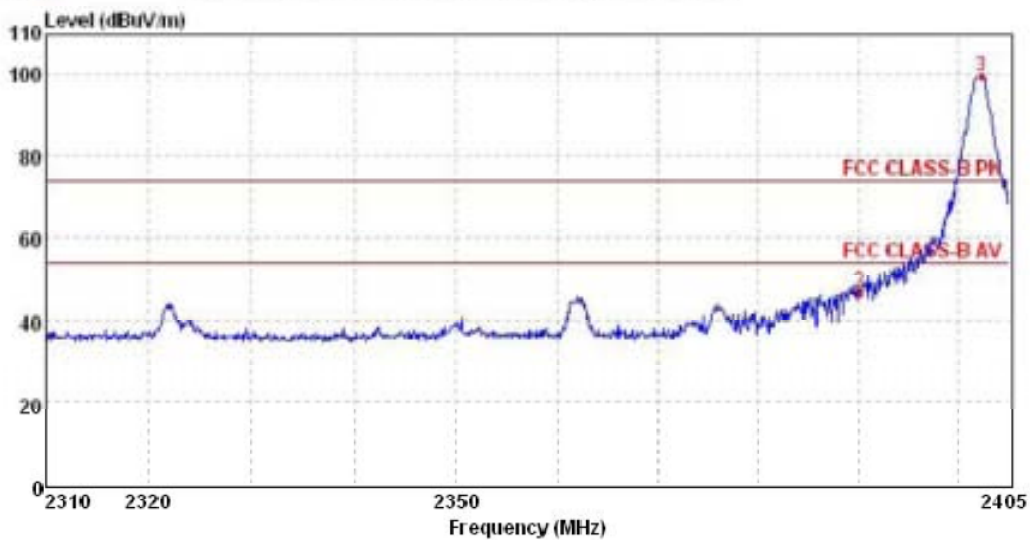

Mark	Frequency MHz	Reading dBuV/m	Antenna dB	Cable dB	Preamp dB	Level dBuV/m	Limit dBuV/m	Over limit	Remark
1	2310.00	39.38	27.27	6.68	37.51	35.82	74.00	-38.18	Peak
2	2390.02	49.67	27.53	6.81	37.57	46.44	74.00	-27.56	Peak
3	2402.29	103.11	27.57	6.83	37.58	99.93	74.00	25.93	Peak

Worst mode:	GFSK Modulation	Test Channel:	78
Detector:	Peak	Polarization:	Horizontal

Data: 36 File: D:\E3\Project\RF Project\2015\SOE15070002.EM6 (38)

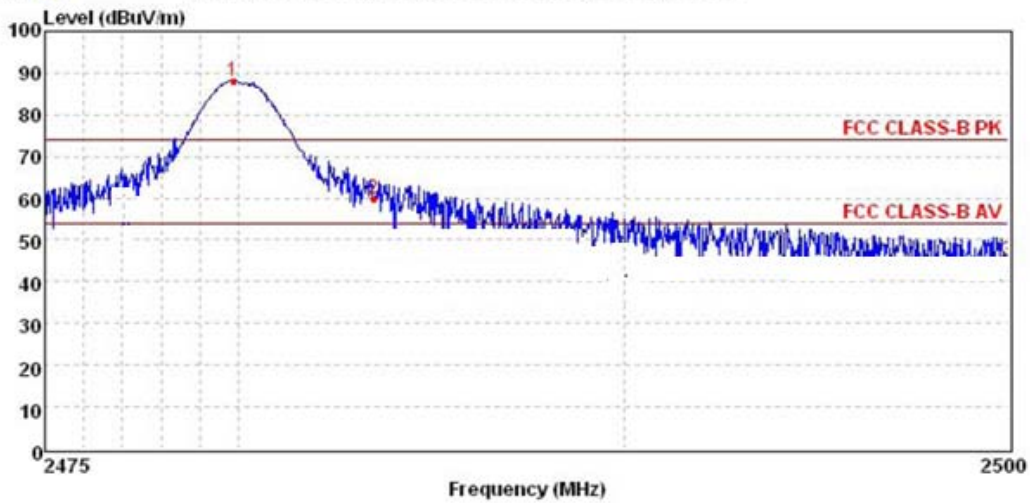

Mark	Frequency MHz	Reading dBuV/m	Antenna dB	Cable dB	Preamp dB	Level dBuV/m	Limit dBuV/m	Over limit	Remark
1	2479.86	91.02	27.83	6.94	37.64	88.15	74.00	14.15	Peak
2	2483.50	62.72	27.85	6.96	37.65	59.88	74.00	-14.12	Peak
3	2500.00	47.66	27.90	6.98	37.66	44.88	74.00	-29.12	Peak

Worst mode:	GFSK Modulation	Test Channel:	78
Detector:	Peak	Polarization:	Vertical

Data: 35 File: D:\E3\Project\RF Project\2015\SOE15070002.EM6 (38)

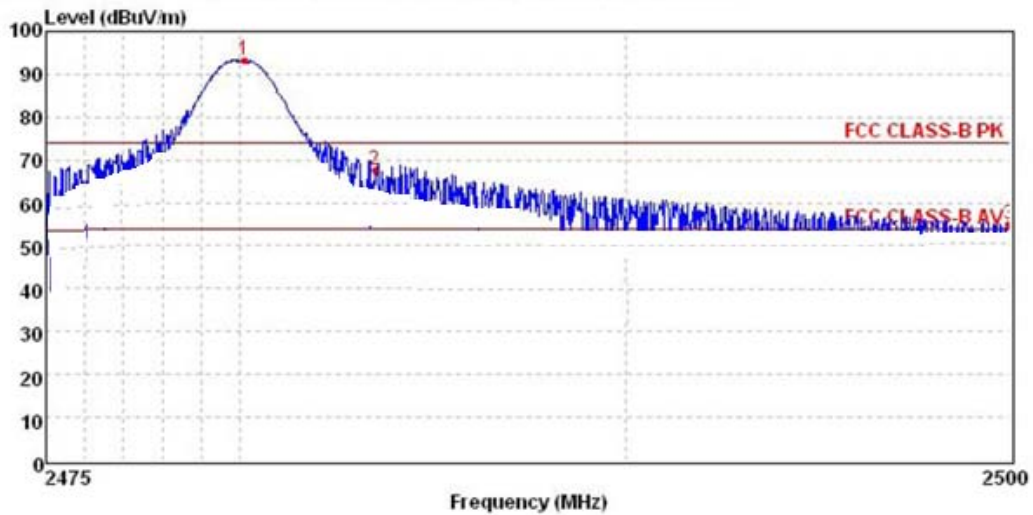

Mark	Frequency MHz	Reading dBuV/m	Antenna dB	Cable dB	Preamp dB	Level dBuV/m	Limit dBuV/m	Over limit	Remark
1	2480.13	96.10	27.83	6.94	37.64	93.23	74.00	19.23	Peak
2	2483.50	70.36	27.85	6.96	37.65	67.52	74.00	-6.48	Peak
3	2499.98	57.63	27.90	6.98	37.66	54.85	74.00	-19.15	Peak

Worst mode:	GFSK Modulation	Test Channel:	78
Detector:	Average	Polarization:	Horizontal

Data: 37 File: D:\E3\Project\RF Project\2015\SOE15070002.EM6 (38)

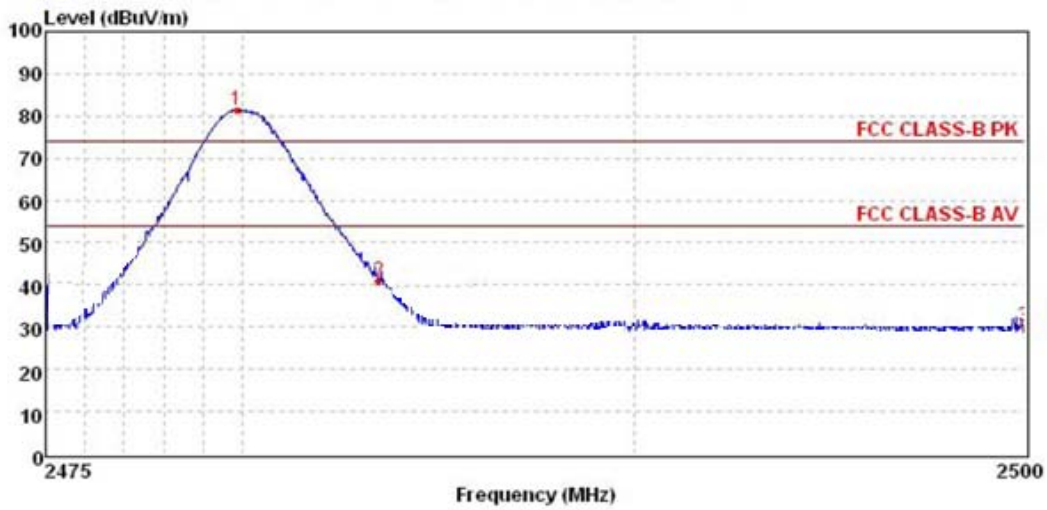

Mark	Frequency MHz	Reading dBuV/m	Antenna dB	Cable dB	Preamp dB	Level dBuV/m	Limit dBuV/m	Over limit	Remark
1	2479.86	84.24	27.83	6.94	37.64	81.37	54.00	27.37	Average
2	2483.47	43.81	27.85	6.96	37.65	40.97	54.00	-13.03	Average
3	2500.00	32.88	27.90	6.98	37.66	30.10	54.00	-23.90	Average

Worst mode:	GFSK Modulation	Test Channel:	78
Detector:	Average	Polarization:	Vertical

Data: 38 File: D:\E3\Project\RF Project\2015\SOE15070002.EM6 (38)

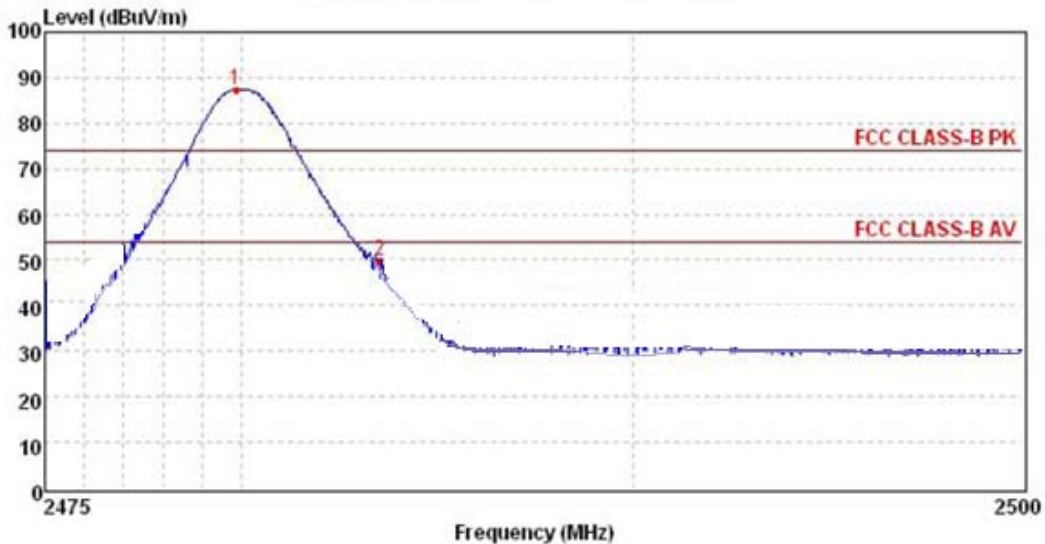

Mark	Frequency MHz	Reading dBuV/m	Antenna dB	Cable dB	Preamp dB	Level dBuV/m	Limit dBuV/m	Over limit	Remark
1	2479.86	90.28	27.83	6.94	37.64	87.41	54.00	33.41	Average
2	2483.52	52.56	27.85	6.96	37.65	49.72	54.00	-4.28	Average

Note: Have pre-scan all modulation mode, found the GFSK modulation which it was worst case, so only the worst case's data on the test report. and the Peak Level result is lower than the AV limit, so the AV result is not require.

4.10. Bandedge and Spurious Emission (conducted)

LIMIT

FCC CFR Title 47 Part 15 Subpart C Section 15.247 (d):

In any 100 kHz bandwidth outside the frequency band in which the spread spectrum intentional radiator is operating, the radio frequency power that is produced by the intentional radiator shall be at least 20 dB below that in the 100 kHz bandwidth within the band that contains the highest level of the desired power, based on either an RF conducted or a radiated measurement.

TEST CONFIGURATION

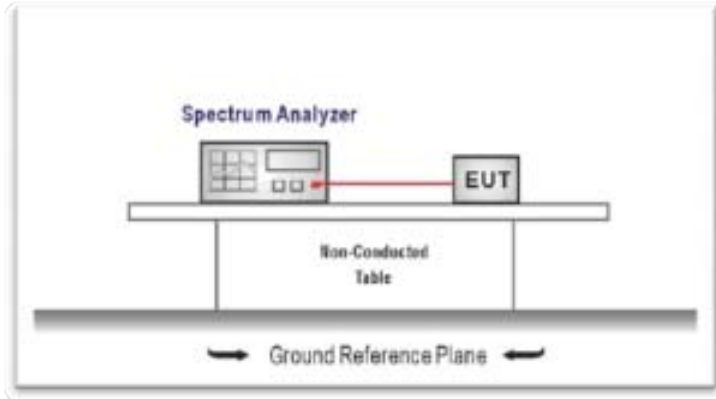

TEST PROCEDURE

1. The transmitter output was connected to the spectrum analyzer through an attenuator.
2. Conducted spurious emission the bandwidth of the fundamental frequency was measured by spectrum analyzer with RBW=100 KHz and VBW=300KHz.
3. Below -20dB of the highest emission level in operating band.

TEST RESULTS

Test plot as follows:

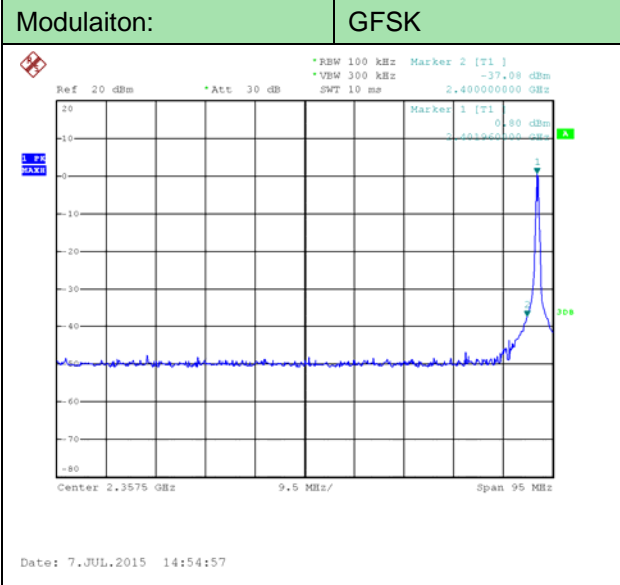
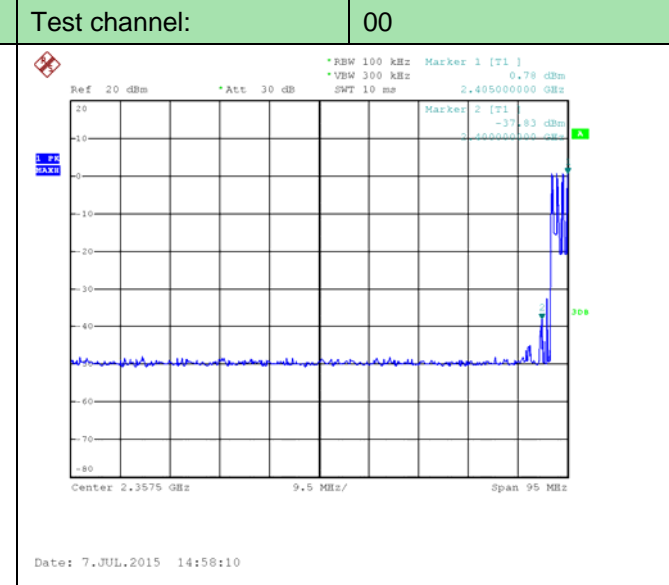
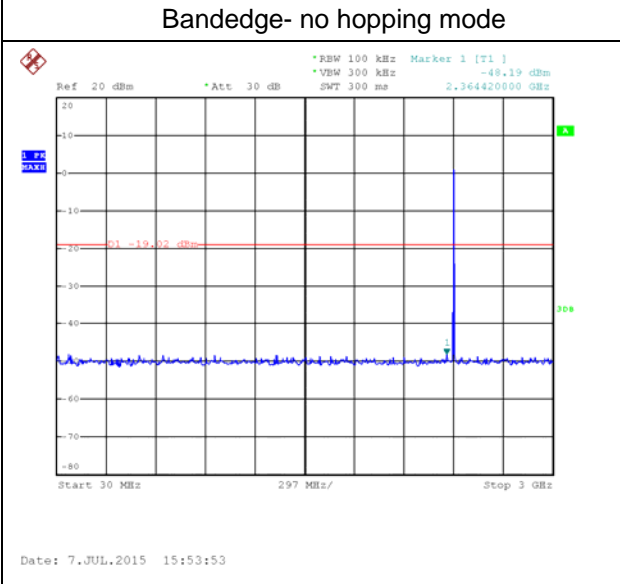
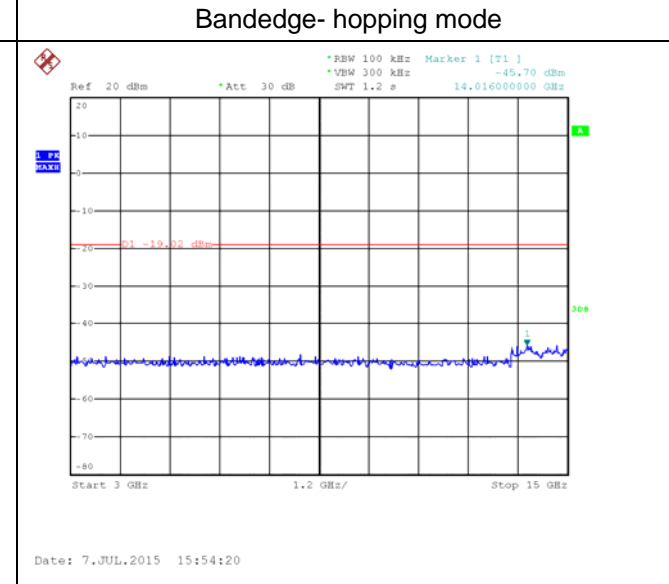
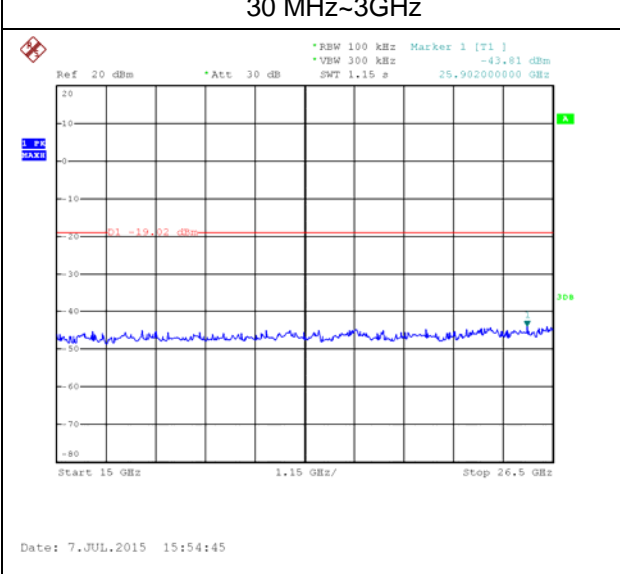
Modulation: GFSK		Test channel: 00	
 <p>Date: 7.JUL.2015 14:54:57</p>		 <p>Date: 7.JUL.2015 14:58:10</p>	
Bandedge- no hopping mode		Bandedge- hopping mode	
 <p>Date: 7.JUL.2015 15:53:53</p>		 <p>Date: 7.JUL.2015 15:54:20</p>	
30 MHz~3GHz		3GHz~15GHz	
 <p>Date: 7.JUL.2015 15:54:45</p>			
15GHz~26.5GHz			

Modulation:	GFSK	Test channel:	39
<p>Ref 20 dBm *Att 30 dB *RBW 100 kHz Marker 1 [T1] -47.87 dBm *VBW 300 kHz SWT 300 ms 1.693200000 GHz</p> <p>Start 30 MHz 297 MHz/ Stop 3 GHz</p> <p>Date: 7.JUL.2015 15:56:59</p>	<p>Ref 20 dBm *Att 30 dB *RBW 100 kHz Marker 1 [T1] -45.91 dBm *VBW 300 kHz SWT 1.2 s 14.496000000 GHz</p> <p>Start 3 GHz 1.2 GHz/ Stop 15 GHz</p> <p>Date: 7.JUL.2015 15:57:35</p>		
30MHz~3GHz		3GHz~15GHz	
<p>Ref 20 dBm *Att 30 dB *RBW 100 kHz Marker 1 [T1] -43.93 dBm *VBW 300 kHz SWT 1.15 s 26.385000000 GHz</p> <p>Start 15 GHz 1.15 GHz/ Stop 26.5 GHz</p> <p>Date: 7.JUL.2015 15:57:59</p>			
15GHz~26.5GHz			

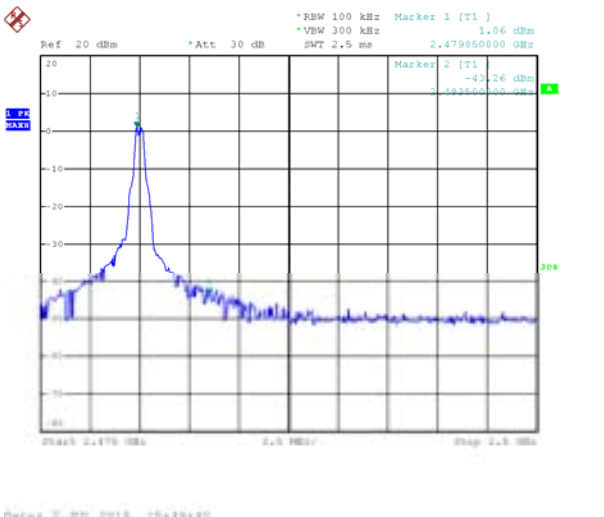
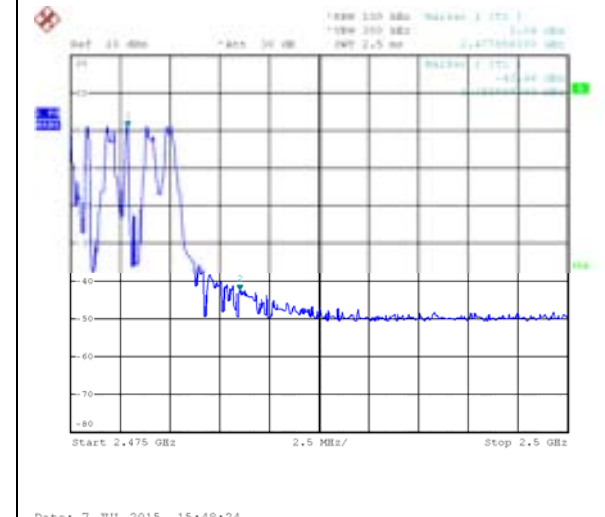
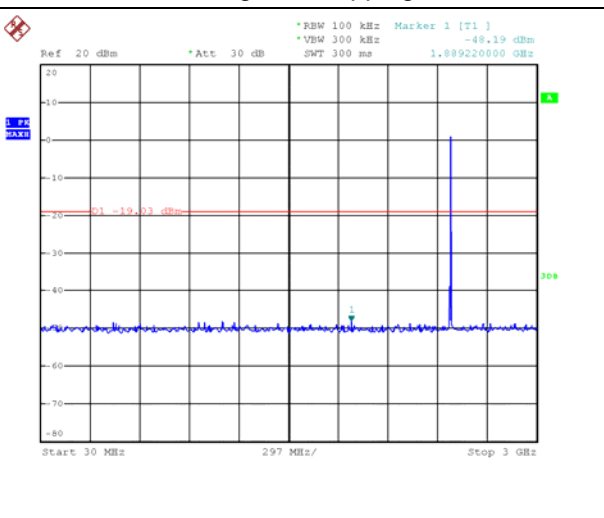
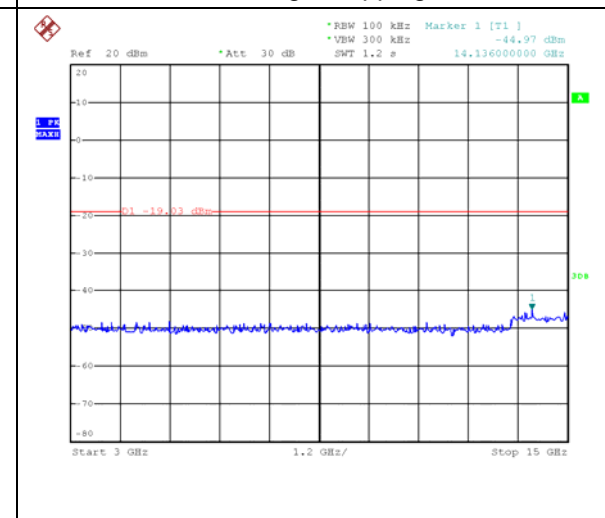
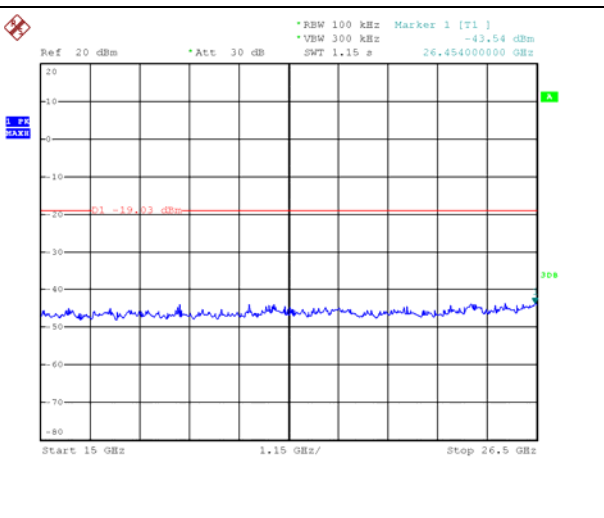
Modulation: GFSK		Test channel: 78	
 <p>Date: 7.JUL.2015 15:49:40</p>		 <p>Date: 7.JUL.2015 15:48:24</p>	
Bandedge- no hopping mode		Bandedge- hopping mode	
 <p>Date: 7.JUL.2015 15:59:12</p>		 <p>Date: 7.JUL.2015 15:59:37</p>	
30MHz~3GHz		3GHz~15GHz	
 <p>Date: 7.JUL.2015 16:00:10</p>			
15GHz~26.5GHz			

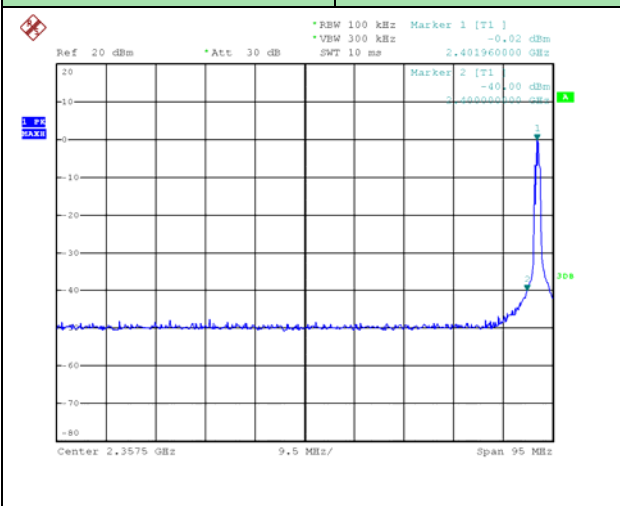
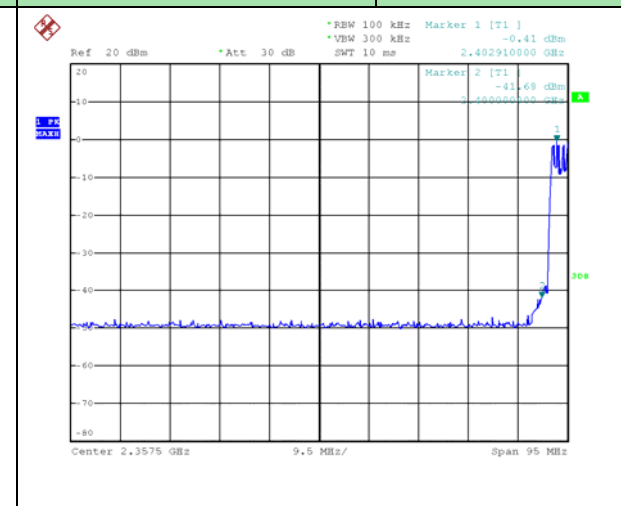
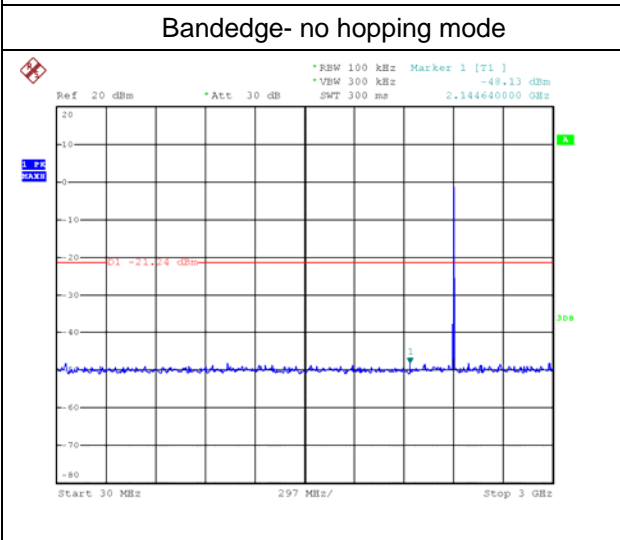
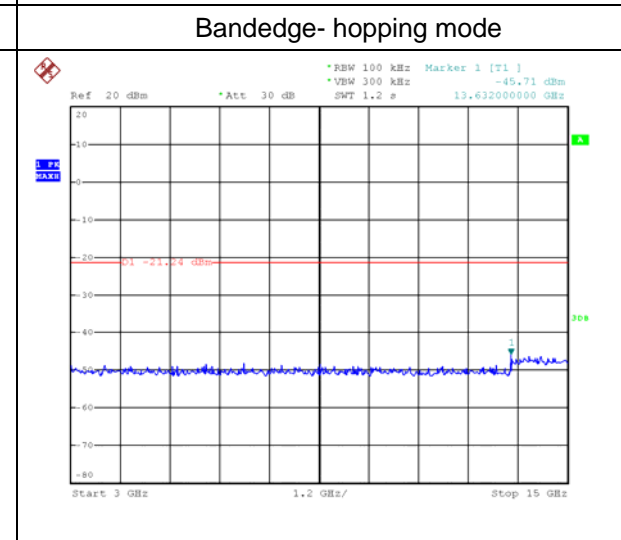
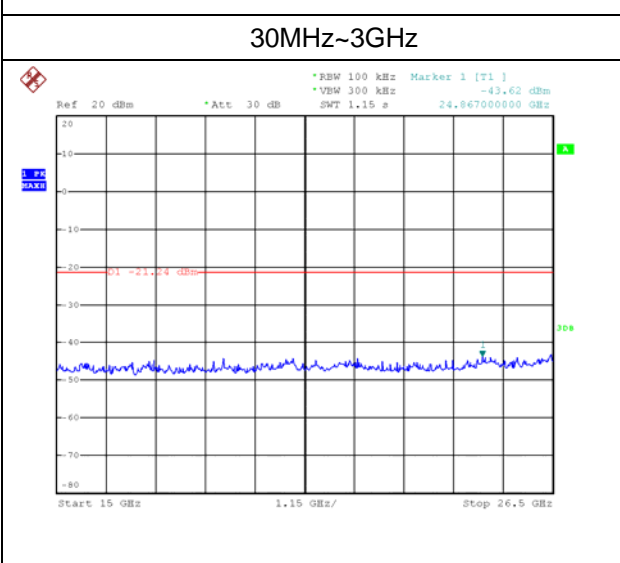
Modulation: $\pi/4$ QPSK		Test channel: 00	
 <p>Date: 7.JUL.2015 15:10:07</p>		 <p>Date: 7.JUL.2015 15:07:00</p>	
Bandedge- no hopping mode		Bandedge- hopping mode	
 <p>Date: 7.JUL.2015 16:06:41</p>		 <p>Date: 7.JUL.2015 16:07:06</p>	
30MHz~3GHz		3GHz~15GHz	
 <p>Date: 7.JUL.2015 16:07:28</p>			
15GHz~26.5GHz			

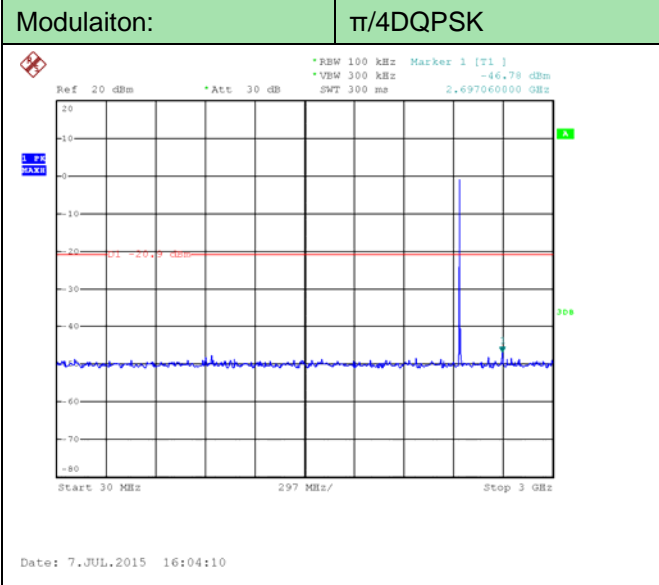
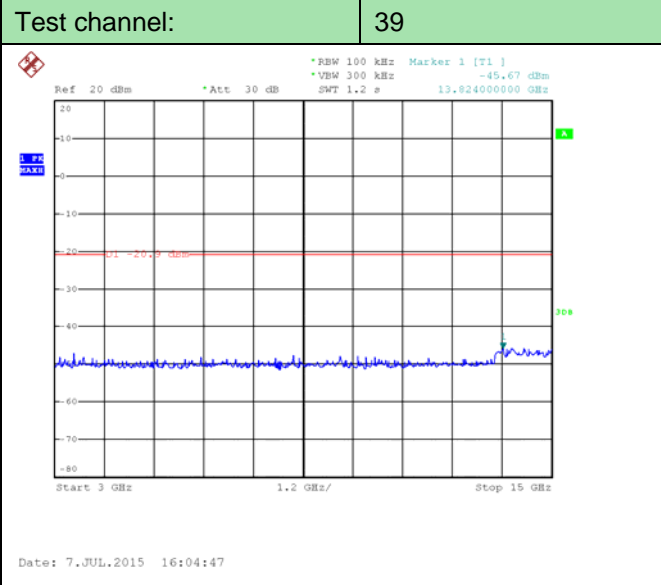
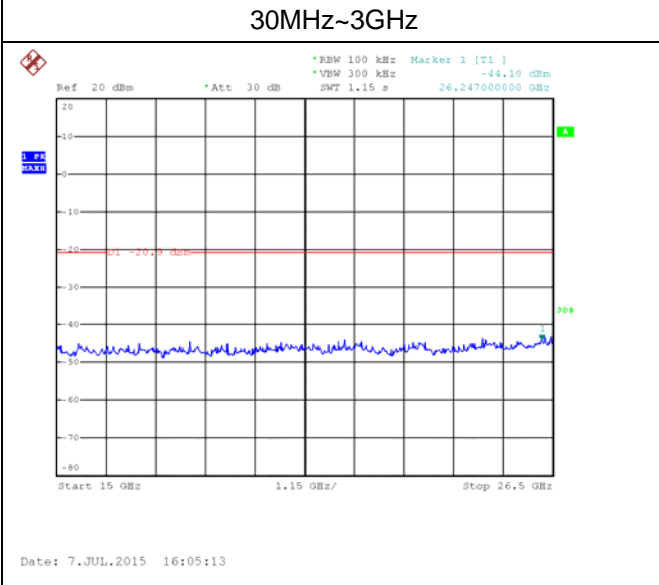
Modulation: $\pi/4$ DQPSK		Test channel: 39	
 <p>Date: 7.JUL.2015 16:04:10</p>	 <p>Date: 7.JUL.2015 16:04:47</p>		
30MHz~3GHz		3GHz~15GHz	
 <p>Date: 7.JUL.2015 16:05:13</p>			
15GHz~26.5GHz			

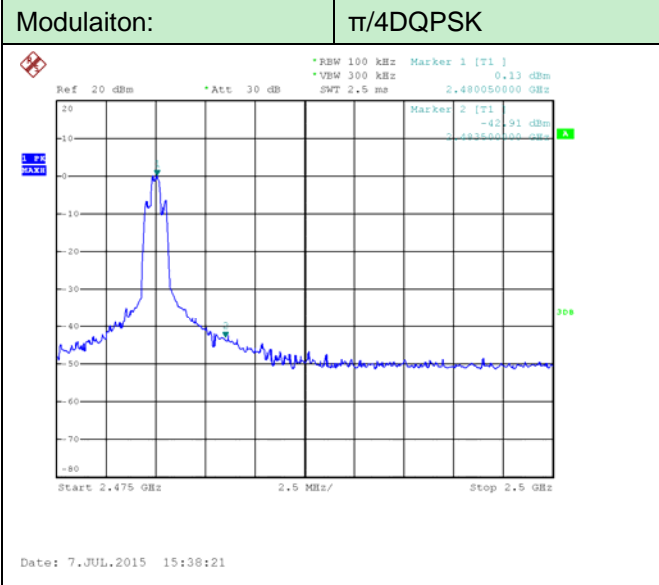
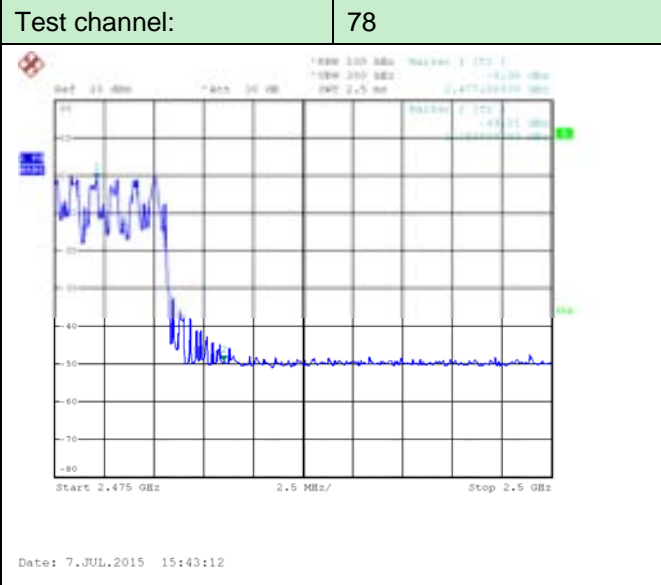
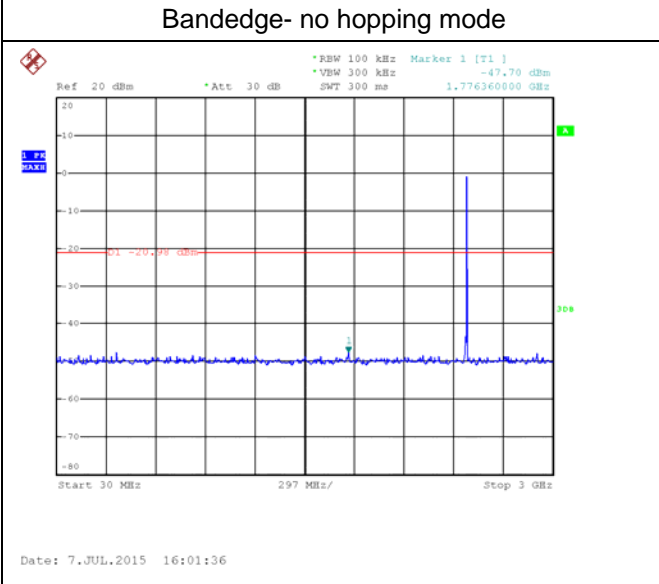
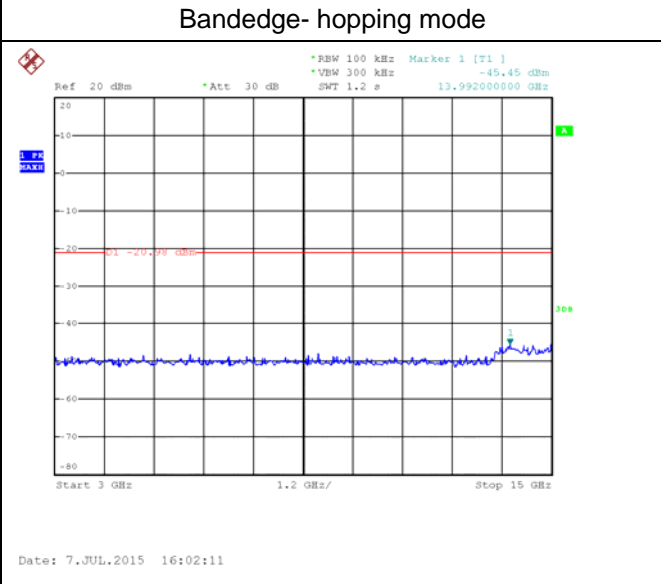
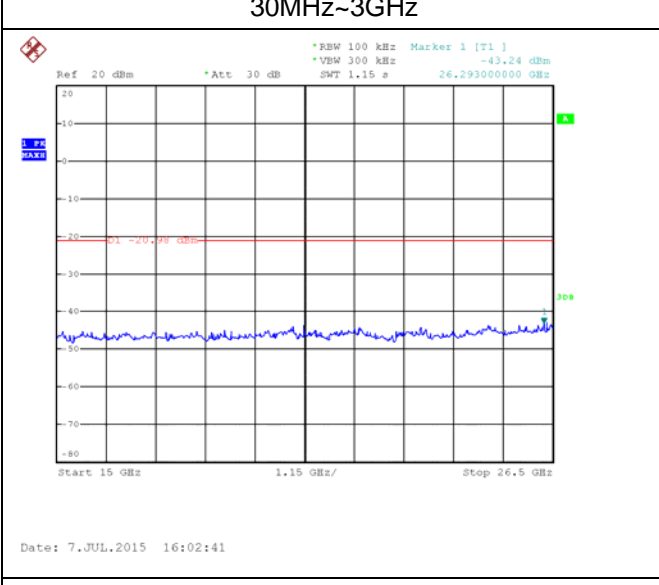
Modulation: $\pi/4$ DQPSK		Test channel: 78	
 <p>Date: 7.JUL.2015 15:38:21</p>		 <p>Date: 7.JUL.2015 15:43:12</p>	
Bandedge- no hopping mode		Bandedge- hopping mode	
 <p>Date: 7.JUL.2015 16:01:36</p>		 <p>Date: 7.JUL.2015 16:02:11</p>	
30MHz~3GHz		3GHz~15GHz	
 <p>Date: 7.JUL.2015 16:02:41</p>			
15GHz~26.5GHz			

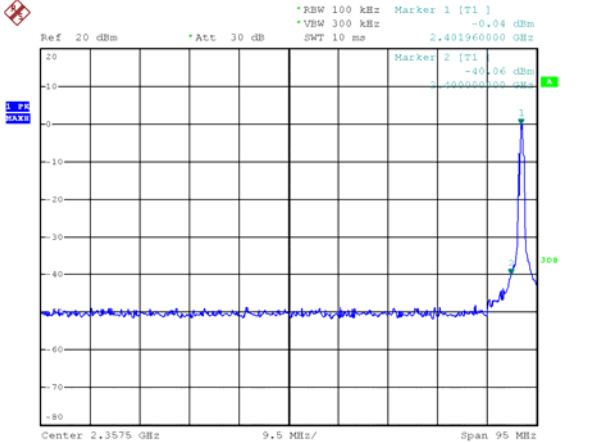
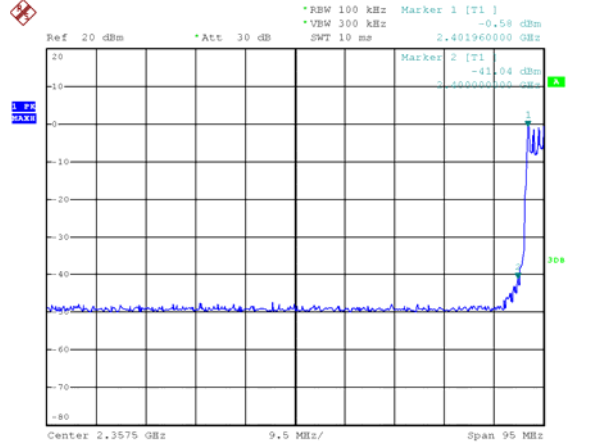
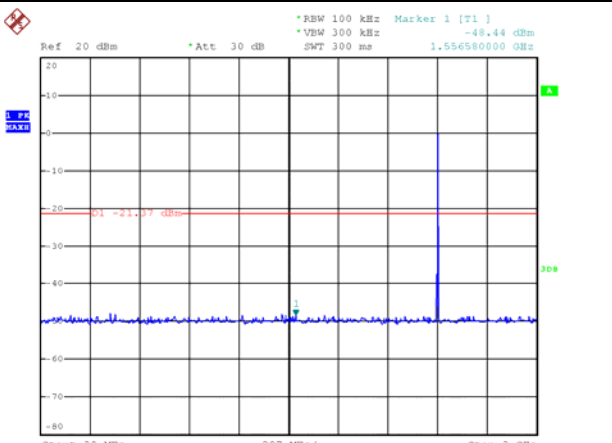
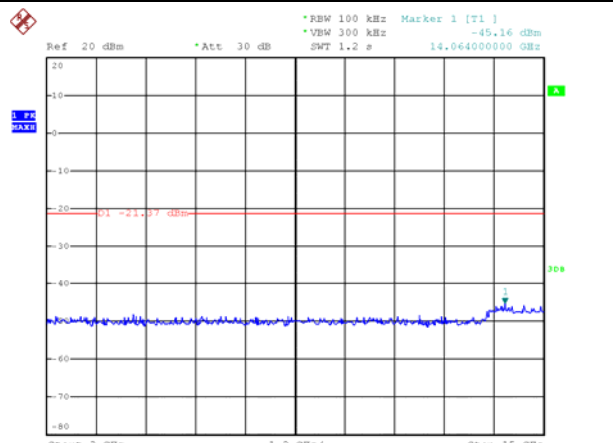
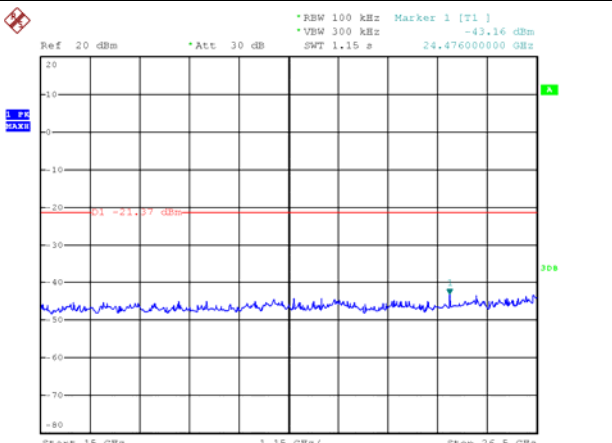
Modulation:	8DPSK	Test channel:	00
 <p>Date: 7.JUL.2015 15:11:09</p>		 <p>Date: 7.JUL.2015 15:21:10</p>	
Bandedge- no hopping mode		Bandedge- hopping mode	
 <p>Date: 7.JUL.2015 16:10:49</p>		 <p>Date: 7.JUL.2015 16:11:11</p>	
30MHz~3GHz		3GHz~15GHz	
 <p>Date: 7.JUL.2015 16:11:37</p>			
15GHz~26.5GHz			

Modulation: 8DPSK		Test channel: 39	
<p>Date: 7.JUL.2015 16:12:26</p>	<p>Date: 7.JUL.2015 16:12:54</p>		
30MHz~3GHz		3GHz~15GHz	
<p>Date: 7.JUL.2015 16:13:20</p>			
15GHz~26.5GHz			

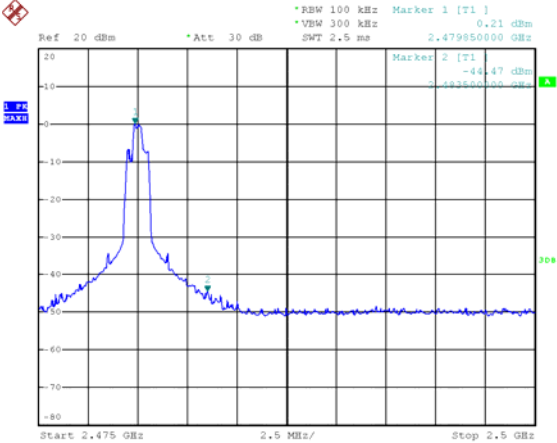
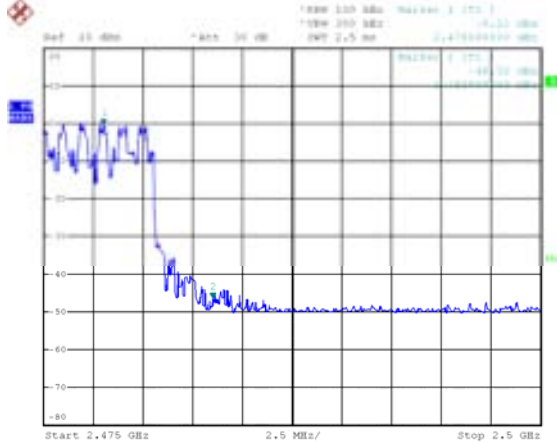
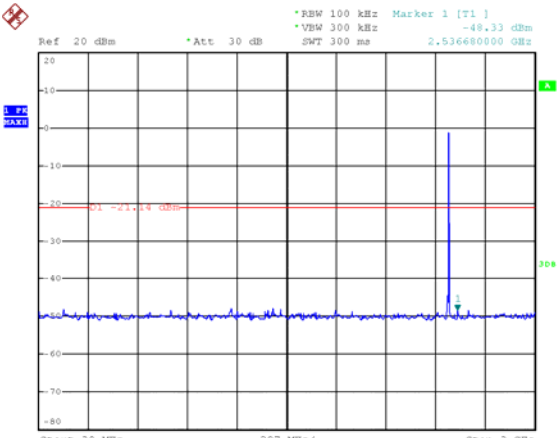
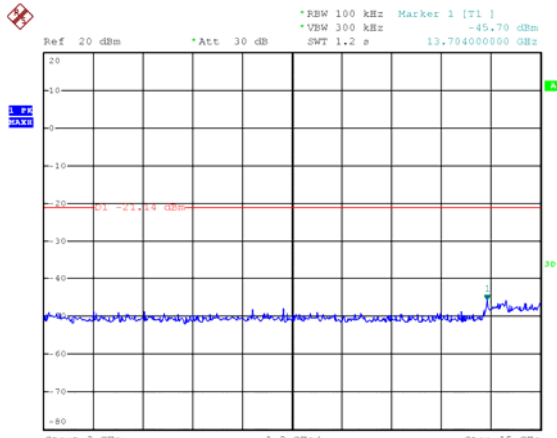
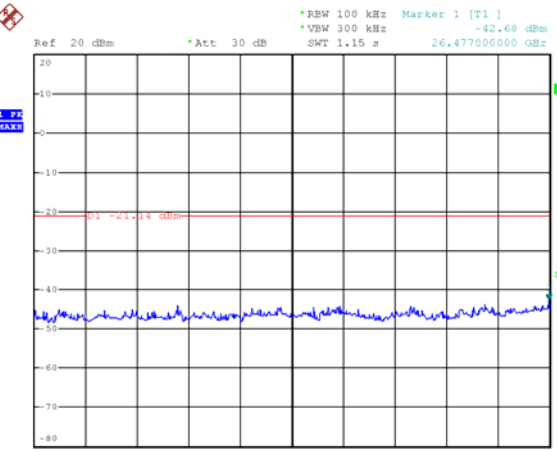
Modulation: 8DPSK		Test channel: 78	
 <p>Date: 7.JUL.2015 15:34:18</p>		 <p>Date: 7.JUL.2015 15:31:14</p>	
Bandedge- no hopping mode		Bandedge- hopping mode	
 <p>Date: 7.JUL.2015 16:14:32</p>		 <p>Date: 7.JUL.2015 16:15:41</p>	
30MHz~3GHz		3GHz~15GHz	
 <p>Date: 7.JUL.2015 16:16:08</p>			
15GHz~26.5GHz			

4.11. Spurious Emission (radiated)

LIMIT

FCC CFR Title 47 Part 15 Subpart C Section 15.209

Frequency	Limit (dBuV/m @3m)	Value
30MHz-88MHz	40.00	Quasi-peak
88MHz-216MHz	43.50	Quasi-peak
216MHz-960MHz	46.00	Quasi-peak
960MHz-1GHz	54.00	Quasi-peak
Above 1GHz	54.00	Average
	74.00	Peak

TEST CONFIGURATION

- ◆ Below 30MHz

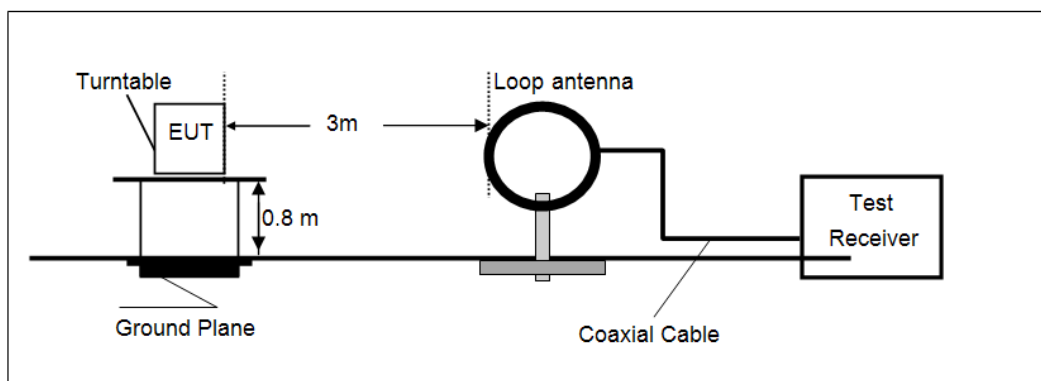

- ◆ 30MHz~1000MHz

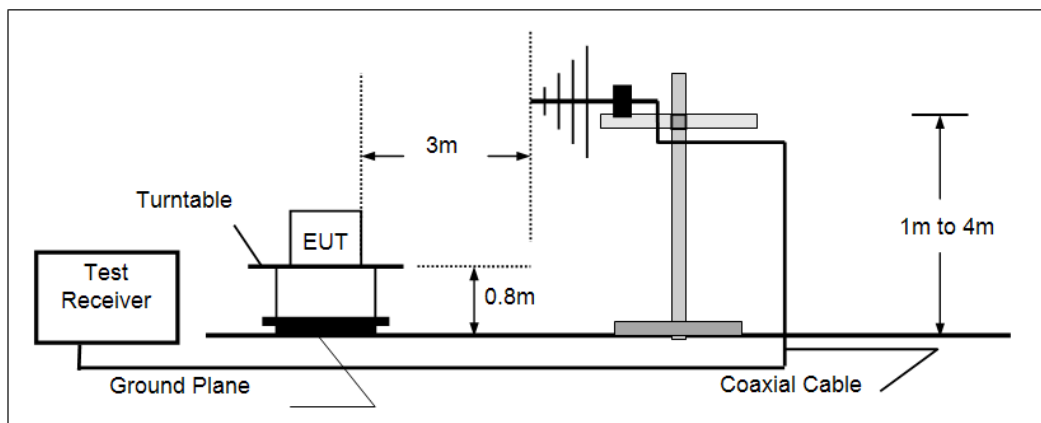

- ◆ Above 1GHz

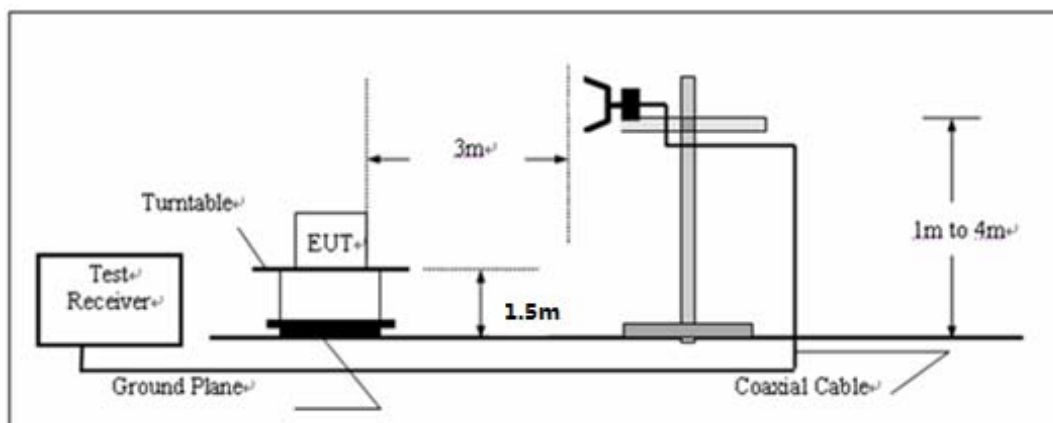

TEST PROCEDURE

1. The EUT was placed on the top of a rotating table 0.8 meters above the ground at a 3 meter camber. The table was rotated 360 degrees to determine the position of the highest radiation.
2. The EUT was set 3 meters away from the interference-receiving antenna, which was mounted on the top of a variable-height antenna tower.
3. The antenna height is varied from one meter to four meters above the ground to determine the maximum value of the field strength. Both horizontal and vertical polarizations of the antenna are set to make the measurement.
4. For each suspected emission, the EUT was arranged to its worst case and then the antenna was tuned to heights from 1 meter to 4 meters and the rotating table was turned from 0 degrees to 360 degrees to find the maximum reading.
5. Use the following spectrum analyzer settings
 - a) Span shall be wide enough to fully capture the emission being measured;
 - b) Below 1GHz, RBW=120KHz, VBW=300KHz, Sweep=auto, Detector function=peak, Trace=max hold;
If the emission level of the EUT measured by the peak detector is 3 dB lower than the applicable limit, the peak emission level will be reported. Otherwise, the emission measurement will be repeated using the quasi-peak detector and reported.
 - c) Above 1GHz, RBW=1MHz, VBW=3MHz for Peak value
RBW=1MHz, VBW=10Hz for Average value.

TEST RESULTS

Noted:

Have pre-scan all modulation mode, found the GFSK modulation which it was worst case, so only the worst case's data on the test report.

Measurement data:

■ **9kHz ~ 30MHz**

The low frequency, which started from 9 kHz to 30MHz, was pre-scanned and the result which was 20dB lower than the limit line per 15.31(o) was not reported.

■ **30MHz ~ 1GHz**

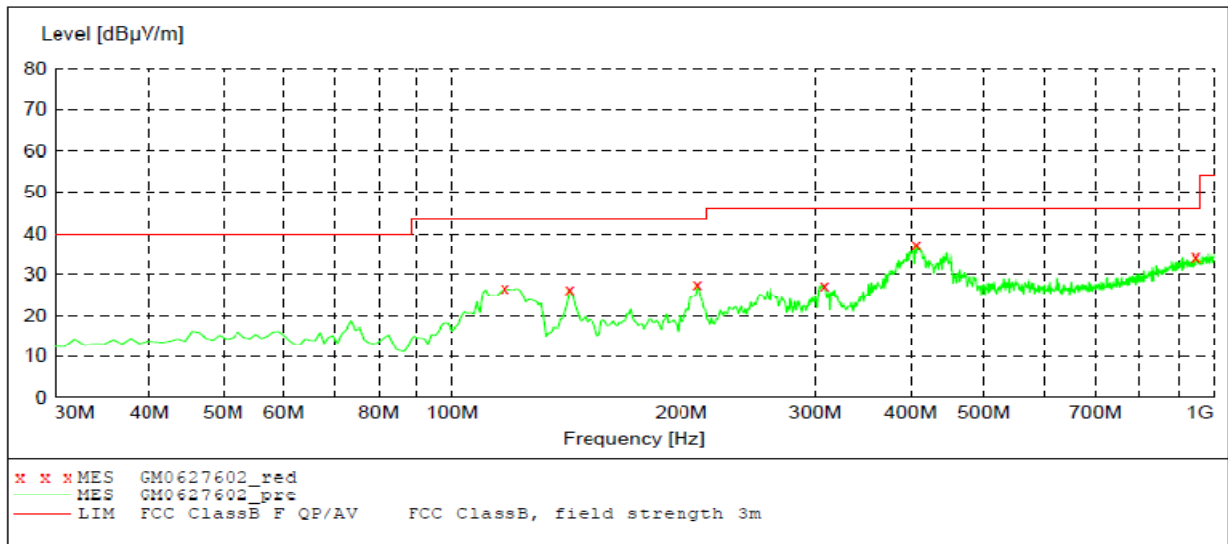

MEASUREMENT RESULT: "GM0627602_red"

6/27/2015 9:56AM

Frequency MHz	Level dBuV/m	Transd dB	Limit dBuV/m	Margin dB	Det.	Height cm	Azimuth deg	Polarization
117.300000	26.80	-15.7	43.5	16.7	QP	300.0	172.00	HORIZONTAL
142.520000	26.40	-18.2	43.5	17.1	QP	300.0	91.00	HORIZONTAL
210.420000	27.60	-14.0	43.5	15.9	QP	100.0	332.00	HORIZONTAL
308.390000	27.50	-13.5	46.0	18.5	QP	100.0	184.00	HORIZONTAL
407.330000	37.40	-10.5	46.0	8.6	QP	100.0	347.00	HORIZONTAL
947.620000	34.30	3.6	46.0	11.7	QP	300.0	290.00	HORIZONTAL

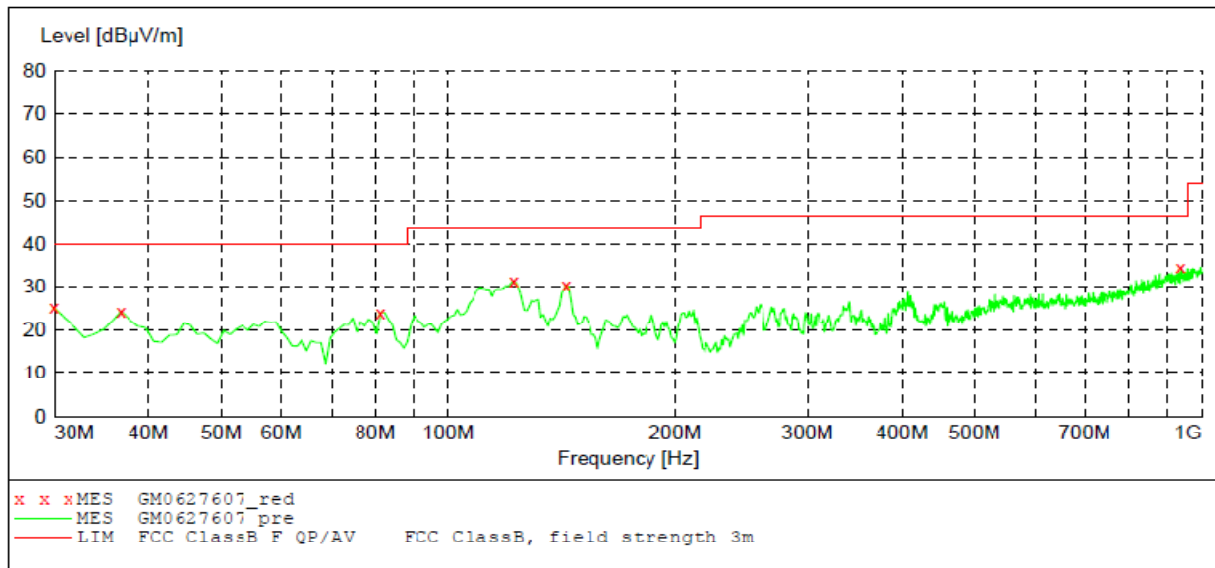

MEASUREMENT RESULT: "GM0627607_red"

6/27/2015 10:12AM

Frequency MHz	Level dBuV/m	Transd dB	Limit dBuV/m	Margin dB	Det.	Height cm	Azimuth deg	Polarization
30.000000	25.00	-16.8	40.0	15.0	QP	100.0	229.00	VERTICAL
36.790000	24.20	-15.8	40.0	15.8	QP	100.0	282.00	VERTICAL
81.410000	23.90	-18.3	40.0	16.1	QP	100.0	270.00	VERTICAL
122.150000	31.40	-16.1	43.5	12.1	QP	100.0	310.00	VERTICAL
143.490000	30.40	-18.1	43.5	13.1	QP	100.0	202.00	VERTICAL
938.890000	34.50	3.5	46.0	11.5	QP	100.0	15.00	VERTICAL

■ Above 1GHz

CH00 for GFSK									
Frequency (MHz)	Read Level (dBuV)	Antenna Factor (dB/m)	Cable Loss (dB)	Preamp Factor (dB)	Level (dBuV/m)	Limit Line (dBuV/m)	Margin Limit (dB)	Polarization	Test value
4809.50	41.36	31.09	9.21	38.53	43.13	74.00	-30.87	Vertical	Peak
7470.56	36.31	36.18	10.96	38.15	45.30	74.00	-28.70	Vertical	
10321.74	35.53	38.59	12.73	38.14	48.71	74.00	-25.29	Vertical	
12130.00	*							Vertical	
4809.50	41.05	31.09	9.21	38.53	44.19	74.00	-29.81	Horizontal	
6001.77	39.64	33.20	9.76	37.90	44.70	74.00	-29.30	Horizontal	
7209.02	38.60	35.97	10.86	38.10	47.33	74.00	-26.67	Horizontal	
12010.00	*							Horizontal	
4809.50	35.91	31.09	9.21	38.53	37.68	54.00	-16.32	Vertical	Average
7470.56	32.24	36.18	10.96	38.15	41.23	54.00	-12.77	Vertical	
10321.74	29.40	38.59	12.73	38.14	42.58	54.00	-11.42	Vertical	
12130.00	*							Vertical	
4809.50	35.86	31.09	9.21	38.53	37.63	54.00	-16.37	Horizontal	
6001.77	36.72	33.20	9.76	37.90	41.78	54.00	-12.22	Horizontal	
7209.02	33.80	35.97	10.86	38.10	42.53	54.00	-11.47	Horizontal	
12010.00	*							Horizontal	

CH39 for GFSK									
Frequency (MHz)	Read Level (dBuV)	Antenna Factor (dB/m)	Cable Loss (dB)	Preamp Factor (dB)	Level (dBuV/m)	Limit Line (dBuV/m)	Margin Limit (dB)	Polarization	Test value
4882.00	43.96	30.88	5.7	35.27	45.27	74.00	-32.48	Vertical	Peak
7323.00	37.18	35.82	6.91	35.13	44.78	74.00	-29.92	Vertical	
9764.00	38.03	37.45	8.84	35.53	48.79	74.00	-25.03	Vertical	
12205.00	*							Vertical	
4882.00	41.94	30.88	5.7	35.27	43.25	74.00	-29.45	Horizontal	
7323.00	37.01	35.82	6.91	35.13	44.61	74.00	-29.21	Horizontal	
9764.00	36.68	37.45	8.84	35.53	47.44	74.00	-26.44	Horizontal	
12205.00	*							Horizontal	
4882	37.41	30.88	5.7	35.27	38.72	54.00	-15.28	Vertical	Average
7323	29.27	35.82	6.91	35.13	36.87	54.00	-17.13	Vertical	
9764	32.42	37.45	8.84	35.53	43.18	54.00	-10.82	Vertical	
12205	*							Vertical	
4882	31.87	30.88	5.7	35.27	33.18	54.00	-20.82	Horizontal	
7323	29.56	35.82	6.91	35.13	37.16	54.00	-16.84	Horizontal	
9764	31.55	37.45	8.84	35.53	42.31	54.00	-11.69	Horizontal	
12205	*							Horizontal	

Remark:

- Final Level = Receiver Read level + Antenna Factor + Cable Loss – Pre-amplifier Factor
- “*”, means this data is too weak instrument of signal is unable to test.
- The emission levels of other frequencies are very lower than the limit and not show in test report.

CH78 for GFSK									
Frequency (MHz)	Read Level (dBuV)	Antenna Factor (dB/m)	Cable Loss (dB)	Preamp Factor (dB)	Level (dBuV/m)	Limit Line (dBuV/m)	Margin Limit (dB)	Polarization	Test value
4858.72	47.77	31.12	9.24	38.56	49.57	74.00	-24.43	Vertical	Peak
7172.41	35.68	35.95	10.84	38.10	44.37	74.00	-29.63	Vertical	
9859.47	35.78	38.32	12.36	38.11	48.35	74.00	-25.65	Vertical	
12380.00	*							Vertical	
4958.68	51.07	31.18	9.31	38.62	52.94	74.00	-21.06	Horizontal	
5338.58	41.46	32.00	9.53	38.39	44.60	74.00	-29.40	Horizontal	
7451.57	37.93	36.17	10.95	38.15	46.90	74.00	-27.10	Horizontal	
12400.00	*							Horizontal	
4858.72	40.57	31.12	9.24	38.56	42.37	54.00	-11.63	Vertical	Average
7172.41	29.24	35.95	10.84	38.10	37.93	54.00	-16.07	Vertical	
9859.47	29.41	38.32	12.36	38.11	41.98	54.00	-12.02	Vertical	
12380.00	*							Vertical	
4958.68	35.62	31.18	9.31	38.62	37.49	54.00	-16.51	Horizontal	
5338.58	37.57	32.00	9.53	38.39	40.71	54.00	-13.29	Horizontal	
7451.57	33.78	36.17	10.95	38.15	42.75	54.00	-11.25	Horizontal	
12400.00	*							Horizontal	

Remark:

1. Final Level = Receiver Read level + Antenna Factor + Cable Loss – Pre-amplifier Factor
2. “*”, means this data is the too weak instrument of signal is unable to test.
3. The emission levels of other frequencies are very lower than the limit and not show in test report.

5. Test Setup Photos of the EUT

Radiated Emission

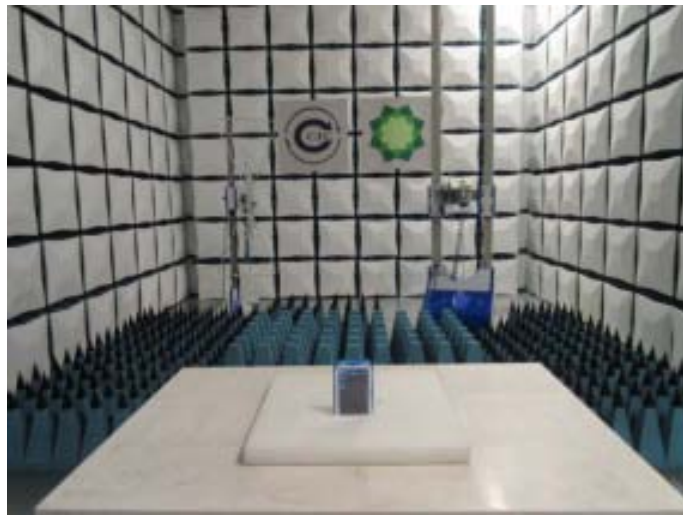

Conducted Emission (AC Mains)



6. External and Internal Photos of the EUT

Reference to Test Report TRE1507000201

.....End of Report.....