

CPU

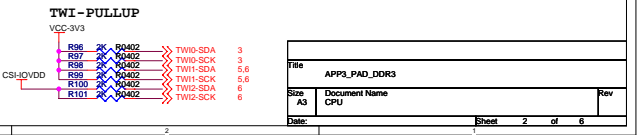

DISPLAY

LCD

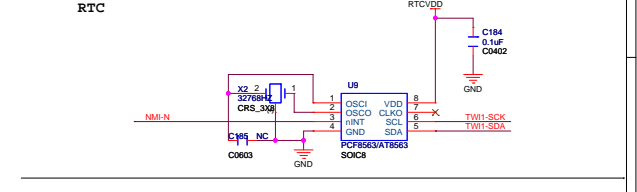
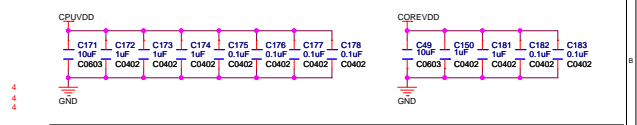
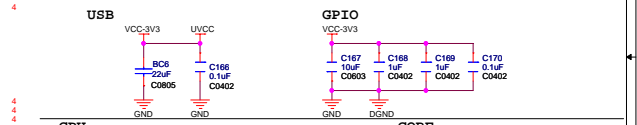
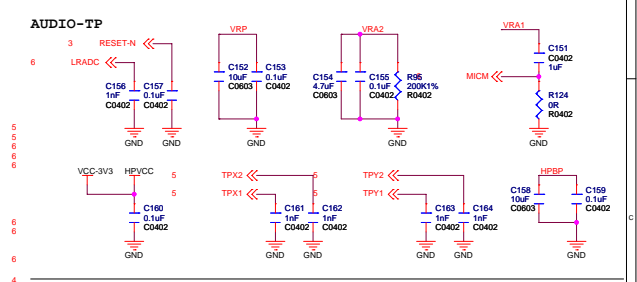
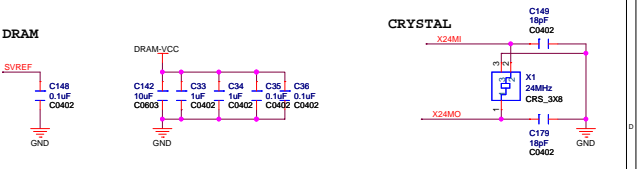
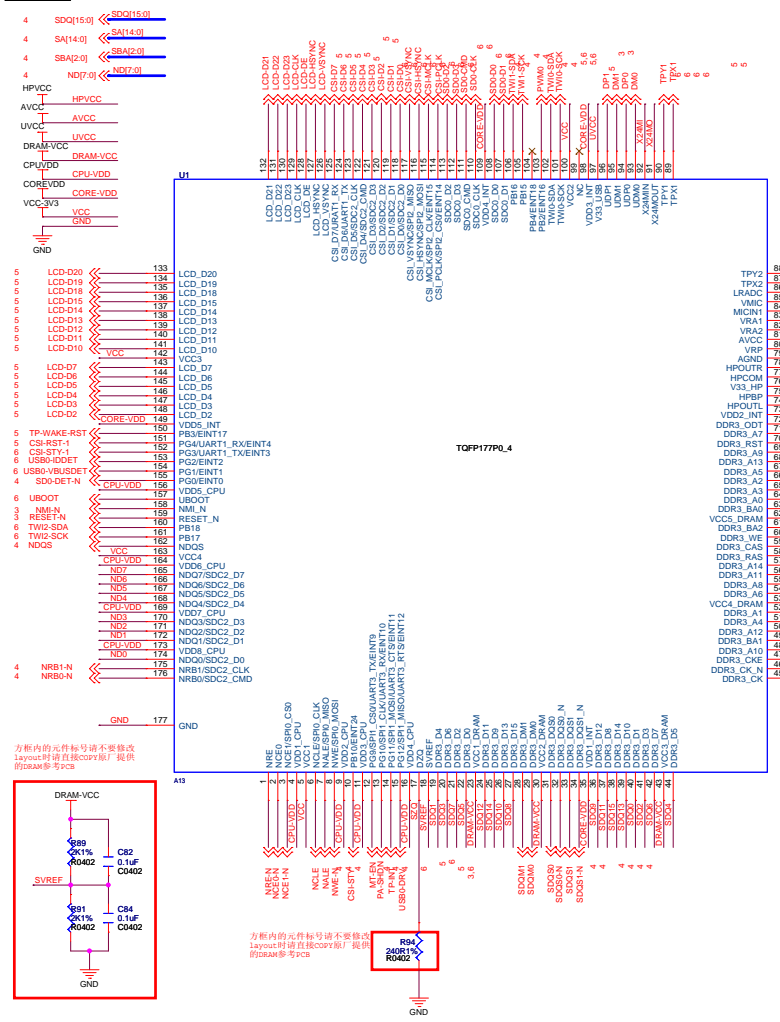
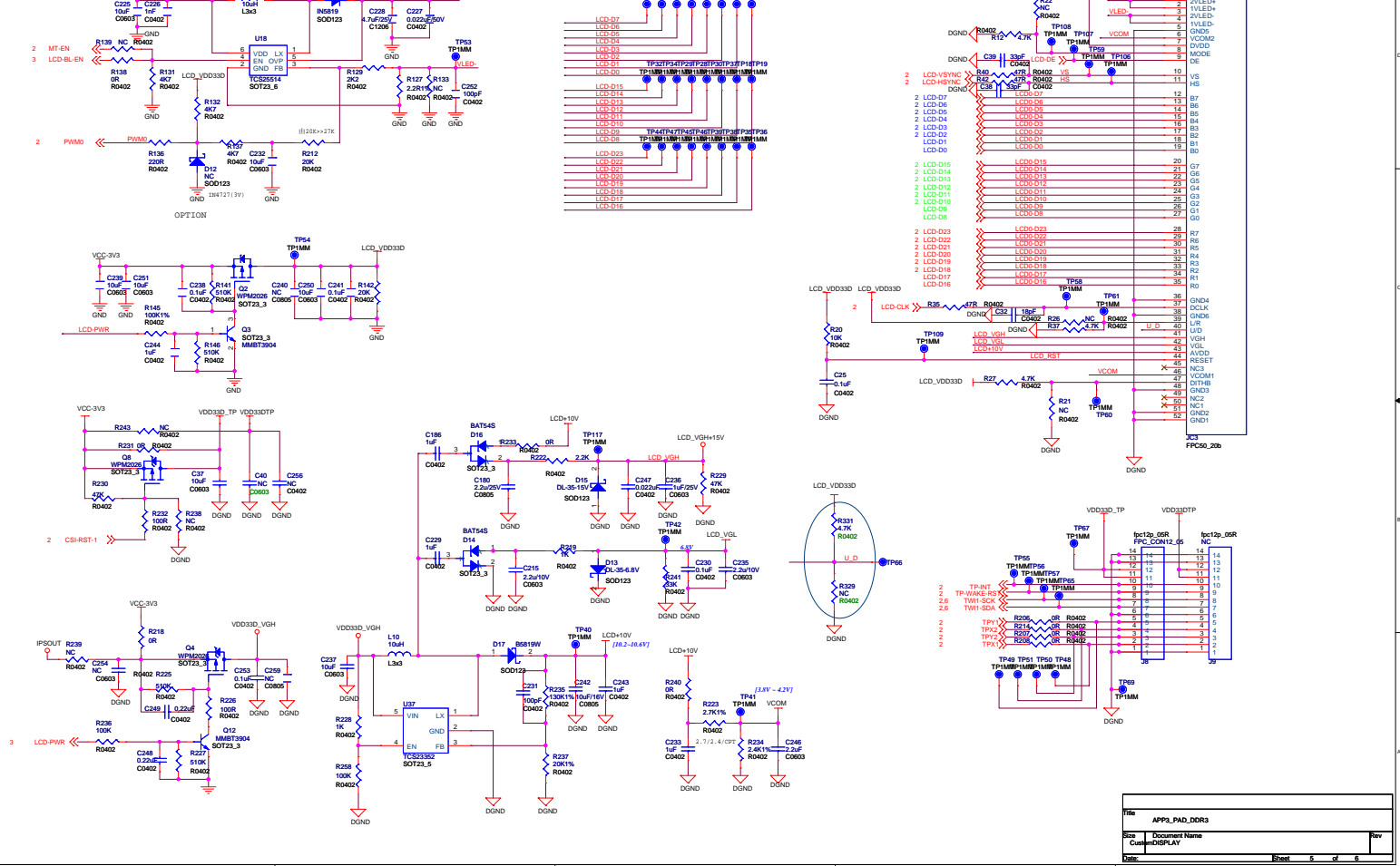

File	Document Name	Rev
APPS_PAD_DDR3	Display	

Sheet 5 of 6

6

5

4

3

2

1

D

D

C

C

B

B

A

A

REVISION RECORD			
LTR	ECO NO:	APPROVED:	DATE:

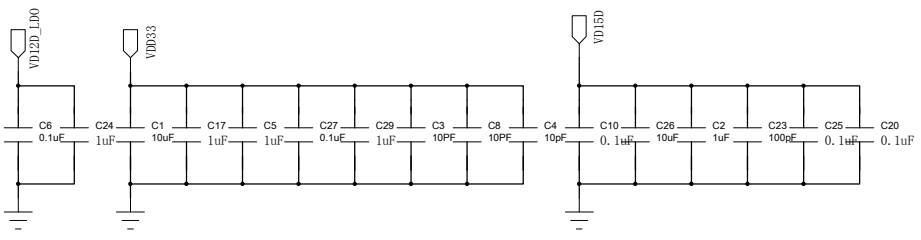
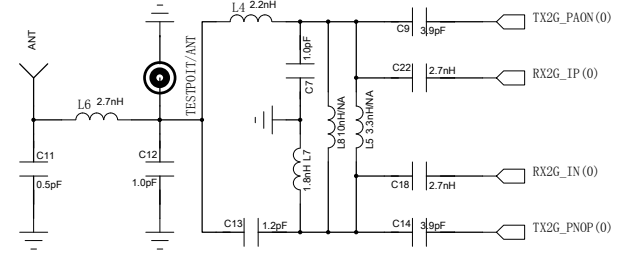
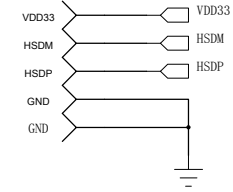
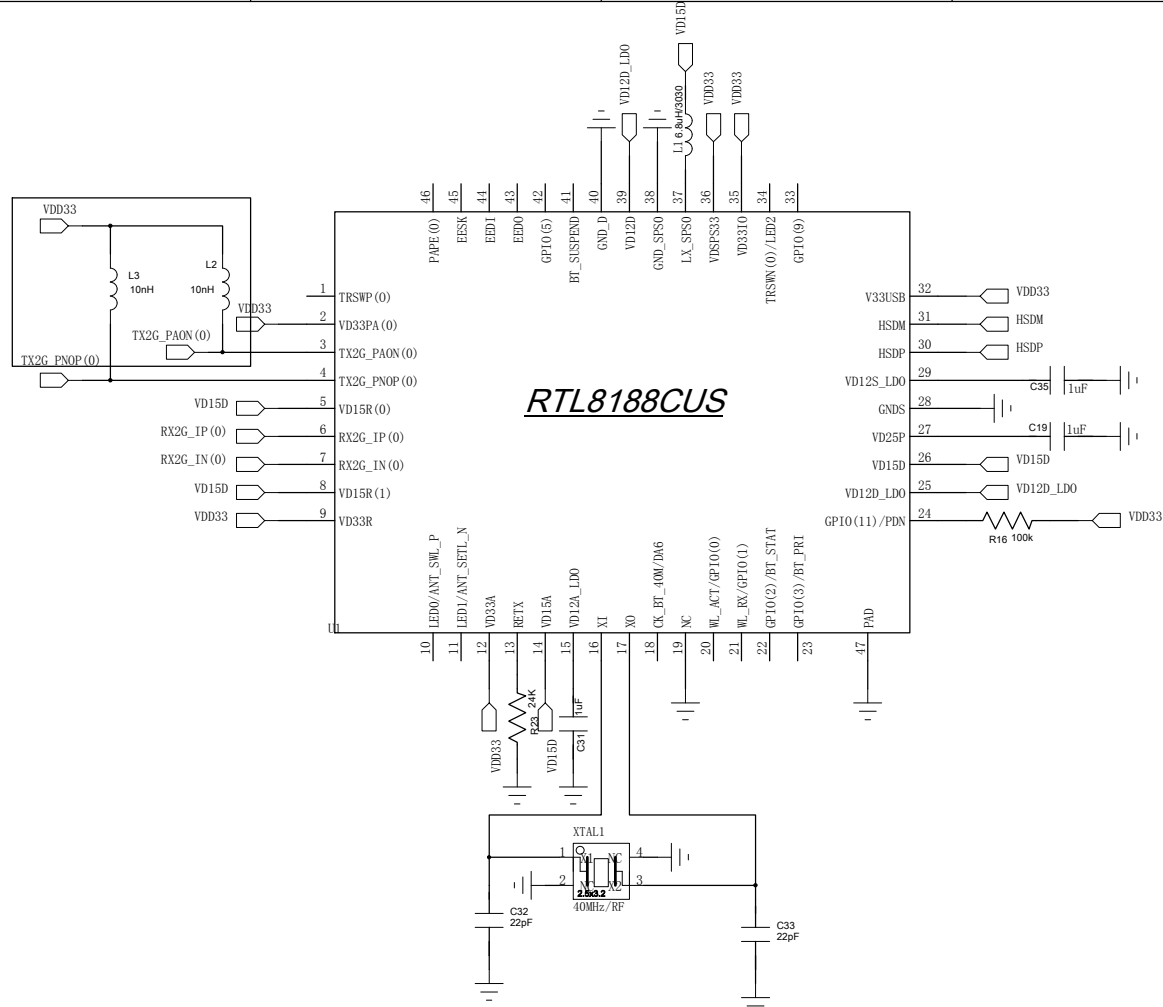

COMPANY: RL-LINK			
TITLE: RL-UM02BS-8188CUSB			
CODE:	SIZE:	DRAWING NO:	REV:
	B	R&D 2011-3-18-01	1.0
SCALE:			SHEET: 1 OF 1

DRAWN: Lavender	DATED: 2011.3.18
CHECKED:	DATED:
QUALITY CONTROL:	DATED:
RELEASED:	DATED: