



Neutron Engineering Inc.

Radio Test Report

FCC ID: XHM-LS185100

This report concerns (check one) : Original Grant Class II Change

Issued Date : Jul. 26, 2010
Project No. : R1005005
Equipment : Bedside Terminal Hardware System
Model Name : K938(B68)

Applicant : FLYTECH TECHNOLOGY CO., LTD.
1F, No. 168, Sing-Ai Rd., NeiHu District
114, Taipei, Taiwan

Tested by: Neutron Engineering Inc. EMC Laboratory
Date of Receipt: Jun. 25, 2010
Date of Test: Jun. 25, 2010 ~ Jul. 01, 2010

Testing Engineer: Rush Kao
(Rush Kao)

Technical Manager: Jeff Yang
(Jeff Yang)

Authorized Signatory: Andy Chiu
(Andy Chiu)

Neutron Engineering Inc.

B1, No. 37, Lane 365, YangGuang St.,
NeiHu District 114, Taipei, Taiwan.

TEL: +886-2-2657-3299

FAX: +886-2-2657-3331





Declaration

Neutron represents to the client that testing is done in accordance with standard procedures as applicable and that test instruments used has been calibrated with the standards traceable to National Measurement Laboratory (NML) of R.O.C., or National Institute of Standards and Technology (NIST) of U.S.A.

Neutron's reports apply only to the specific samples tested under conditions. It is manufacture's responsibility to ensure that additional production units of this model are manufactured with the identical electrical and mechanical components. **Neutron** shall have no liability for any declarations, inferences or generalizations drawn by the client or others from **Neutron** issued reports.

Neutron's reports must not be used by the client to claim product endorsement by the authorities or any agency of the Government.

This report is the confidential property of the client. As a mutual protection to the clients, the public and **Neutron-self**, extracts from the test report shall not be reproduced except in full with **Neutron's** authorized written approval.

Neutron's laboratory quality assurance procedures are in compliance with the **ISO Guide 17025** requirements, and accredited by the conformity assessment authorities listed in this test report.

Limitation

For the use of the authority's logo is limited unless the Test Standard(s)/Scope(s)/Item(s) mentioned in this test report is (are) included in the conformity assessment authorities acceptance respective.



Table of Contents	Page
1 . CERTIFICATION	4
2 . SUMMARY OF TEST RESULTS	5
2.1 TEST FACILITY	6
2.2 MEASUREMENT UNCERTAINTY	6
3 . GENERAL INFORMATION	7
3.1 GENERAL DESCRIPTION OF EUT	7
3.2 DESCRIPTION OF TEST MODES	8
3.3 BLOCK DIAGRAM SHOWING THE CONFIGURATION OF SYSTEM TESTED	9
3.4 DESCRIPTION OF SUPPORT UNITS	10
4 . EMC EMISSION TEST	11
4.1 CONDUCTED EMISSION MEASUREMENT	11
4.1.1 POWER LINE CONDUCTED EMISSION	11
4.1.2 MEASUREMENT INSTRUMENTS LIST	11
4.1.3 TEST PROCEDURE	12
4.1.4 DEVIATION FROM TEST STANDARD	12
4.1.5 TEST SETUP	12
4.1.6 EUT OPERATING CONDITIONS	12
4.1.7 TEST RESULTS	13
4.2 RADIATED EMISSION MEASUREMENT	15
4.2.1 RADIATED EMISSION LIMITS	15
4.2.2 MEASUREMENT INSTRUMENTS LIST	16
4.2.3 TEST PROCEDURE	16
4.2.4 DEVIATION FROM TEST STANDARD	16
4.2.5 TEST SETUP	17
4.2.6 EUT OPERATING CONDITIONS	17
4.2.7 TEST RESULTS- FCC PART 15.209	18
4.2.8 TEST RESULTS- FCC PART 15.225	20
4.3 FREQUENCY STABILITY MEASUREMENT	22
4.3.1 FREQUENCY STABILITY LIMITS	22
4.3.2 MEASUREMENT INSTRUMENTS LIST	22
4.3.3 TEST PROCEDURE	22
4.3.4 DEVIATION FROM TEST STANDARD	22
4.3.5 EUT OPERATING CONDITIONS	22
4.3.6 TEST RESULTS	23
5 . EUT TEST PHOTO	24



1. CERTIFICATION

Equipment : Bedside Terminal Hardware System
Brand Name : FLYTECH
Model Name : K938(B68)
Applicant : FLYTECH TECHNOLOGY CO., LTD.
Data of Test : Jun. 25, 2010 ~ Jul. 01, 2010
Standards : FCC Part15, Subpart C
 ANCI C63.4 : 2003

The above equipment has been tested and found compliance with the requirement of the relative standards by Neutron Engineering Inc. EMC Laboratory.

The test data, data evaluation, and equipment configuration contained in our test report (Ref No. NEI-FCCP-1-R1005005) were obtained utilizing the test procedures, test instruments, test sites that has been accredited by the Authority of NVLAP and TAF according to the ISO-17025 quality assessment standard and technical standard(s).



2. SUMMARY OF TEST RESULTS

Test procedures according to the technical standards: (Antenna to EUT distance is 3 m)

FCC Part15, Subpart C		
Standard	Test Item	Remark
15.207	Conducted Emission	PASS
15.35 / 15.205 / 15.209 / 15.225	Radiated Emission	PASS
15.225(e)	Frequency Stability	PASS
15.203	Antenna Requirement	PASS

NOTE:

(1) " N/A" denotes test is not applicable in this Test Report.



2.1 TEST FACILITY

The test facilities used to collect the test data in this report is **C01 & CB08** at the location of No.132-1, Lane 329, Sec. 2, Palain Road, Shijr City, Taipei, Taiwan. & 1F., No. 61, Ln. 77, Sing-ai Rd., Neihu Dist., Taipei City 114, Taiwan (R.O.C.)

2.2 MEASUREMENT UNCERTAINTY

The reported uncertainty of measurement $y \pm U$, where expended uncertainty **U** is based on a standard uncertainty multiplied by a coverage factor of **k=2**, providing a level of confidence of approximately **95%**.

A. Conducted Measurement :

Test Site	Method	Measurement Frequency Range	U , (dB)
C01	ANSI	150 KHz ~ 30MHz	1.94

B. Radiated Measurement :

Test Site	Method	Measurement Frequency Range	Ant. H / V	U , (dB)
OS-02	ANSI	30MHz ~ 200MHz	V	2.48
		30MHz ~ 200MHz	H	2.16
		200MHz ~ 1,000MHz	V	2.50
		200MHz ~ 1,000MHz	H	2.66
CB08	ANSI	30MHz ~ 200MHz	V	3.22
		30MHz ~ 200MHz	H	3.35
		200MHz ~ 1,000MHz	V	3.24
		200MHz ~ 1,000MHz	H	3.11
		1000MHz ~ 1800MHz	V	4.05
		1000MHz ~ 1800MHz	H	3.97
		18000MHz ~ 40000MHz	V	4.04
18000MHz ~ 40000MHz	H	4.01		



3. GENERAL INFORMATION

3.1 GENERAL DESCRIPTION OF EUT

Equipment	Bedside Terminal Hardware System
Brand Name	FLYTECH
Model Name	K938(B68)
OEM Brand/Model Name	N/A
Model Difference	N/A
Product Description	The EUT is a Bedside Terminal Hardware System.
	Operation Frequency: 13.56MHz
	Product Class: 1
	Receiver Class: 3
	Modulation Type: ASK
	Number Of Channel 1CH (13.56MHz)
	Antenna Designation: Loop
	Based on the application, features, or specification exhibited in User's Manual, the EUT is considered as an ITE/Computing Device. More details of EUT technical specification, please refer to the User's Manual.
Power Source	DC Voltage supplied from AC/DC adapter.
Power Rating	AcBel / AD7043: I/P: AC 100-240V~1.4A 50-60Hz / O/P: DC 19V, 4.74A PROTEK POWER : I/P: AC 100-240V~, 47-63Hz, 1.06-0.45A O/P: DC 19V, 4.74A, 90W MAX.
Connecting I/O Port(s)	Please refer to the User's Manual
Products Covered	Motherboard: FLYTECH / B68 CPU: INTEL / ATOM(N270) INVERTER: MiTAC / DA-2A12-FT02 Main Display: 18.5" LCD PANEL: (1) AU / M185XW01 (2) AU / G185XW01 (3) SHARP / LQ185T1LGN2 HDD: 160G ADAPTER: (1) AcBel / AD7043 (2) PROTEK POWER / PMP90-13-2-B15
EUT Modification(s)	N/A

Note:

1. For a more detailed features description, please refer to the manufacturer's specifications or the User's Manual.



3.2 DESCRIPTION OF TEST MODES

To investigate the maximum EMI emission characteristics generates from EUT, the test system was pre-scanning tested base on the consideration of following EUT operation mode or test configuration mode which possible have effect on EMI emission level. Each of these EUT operation mode(s) or test configuration mode(s) mentioned above was evaluated respectively.

Pretest Test Mode	Description
Mode 1	TX (Adapter: PMP90-13-2-B15)
Mode 2	TX (Adapter: AD7043)

For Conducted / Radiated Test	
Final Test Mode	Description
Mode 1	TX (Adapter: PMP90-13-2-B15)



3.3 BLOCK DIAGRAM SHOWING THE CONFIGURATION OF SYSTEM TESTED

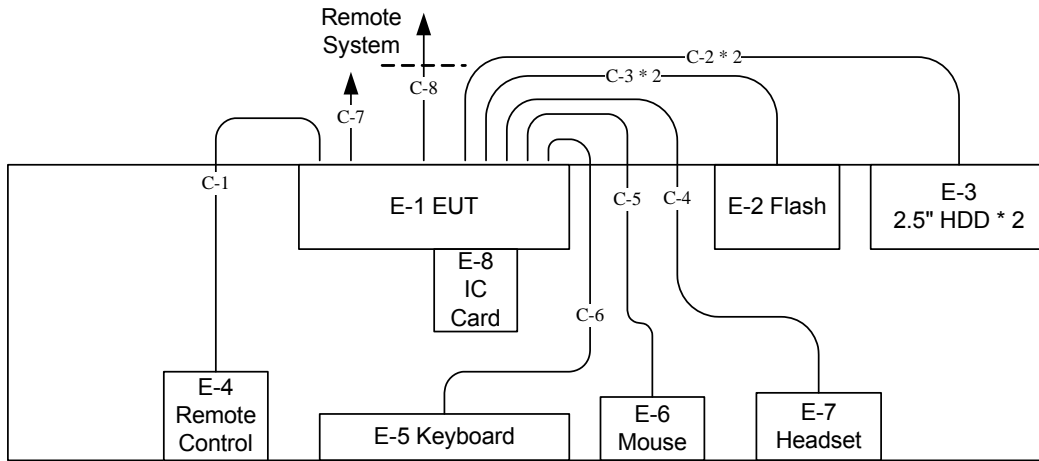

- C-1 Data Cable
- C-2 USB Cable
- C-3 Audio Cable
- C-4 USB Cable
- C-5 USB Cable
- C-6 USB Cable
- C-7 RJ-45 Cable
- C-8 RJ-45 Cable



3.4 DESCRIPTION OF SUPPORT UNITS

The EUT has been tested as an independent unit together with other necessary accessories or support units. The following support units or accessories were used to form a representative test configuration during the tests.

Item	Equipment	Mfr/Brand	Model/Type No.	FCC ID	Series No.	Note
E-1	Bedside Terminal Hardware System	FLYTECH	K938(B68)	DOC	N/A	EUT
E-2	USB Flash Drives	Silicon Power	SP004GBUF2M01V1K	DOC	N/A	
E-3	2.5" Mobile External HDD	FireWire	F12-UF	DOC	N/A	
E-4	Remote Control	JAO	RIMO	N/A	N/A	
E-5	USB K/B	Logitech	Y-BL49	DOC	STW43302534	
E-6	USB Mouse	Dell	M-UVDEL1	DOC	LNA44366861	
E-7	Headset	i-Acon	HOH-323-BK	N/A	N/A	
E-8	IC CARD	N/A	N/A	N/A	N/A	

Item	Shielded Type	Ferrite Core	Length	Note
C-1	YES	NO	2.7M	
C-2	YES	NO	1.8M	
C-3	NO	NO	1.8M	
C-4	YES	NO	1.8M	
C-5	YES	NO	1.7M	
C-6	YES	NO	1.7M	
C-7	NO	NO	1M	
C-8	NO	NO	10M	

Note:

- (1) The support equipment was authorized by Declaration of Conformity.
- (2) For detachable type I/O cable should be specified the length in cm in 『Length』 column.



4. EMC EMISSION TEST

4.1 CONDUCTED EMISSION MEASUREMENT

4.1.1 POWER LINE CONDUCTED EMISSION (FREQUENCY RANGE 150KHZ-30MHZ)

FREQUENCY (MHz)	Class A (dBuV)		Class B (dBuV)	
	Quasi-peak	Average	Quasi-peak	Average
0.15 -0.5	79.00	66.00	66 - 56 *	56 - 46 *
0.50 -5.0	73.00	60.00	56.00	46.00
5.0 -30.0	73.00	60.00	60.00	50.00

Note:

- (1) The tighter limit applies at the band edges.
- (2) The limit of " * " marked band means the limitation decreases linearly with the logarithm of the frequency in the range.

4.1.2 MEASUREMENT INSTRUMENTS LIST

Item	Kind of Equipment	Manufacturer	Type No.	Serial No.	Calibrated until
1	Test Cable	N/A	SR03_C_01&02	N/A	Aug. 19, 2010
2	Pulse Limiter	Electro-Metrics	EM-7600	112644	Dec. 27, 2010
3	50Ω BNC TYPE Terminator	N/A	N/A	01	May 25, 2011
4	50Ω BNC TYPE Terminator	N/A	N/A	03	May 25, 2011
5	EMI Test Receiver	R&S	ESCI	100082	Mar. 16, 2011
6	LISN	EMCO	4825/2	00028234	Jul. 13, 2010

Remark: " N/A" denotes No Model Name , Serial No. or No Calibration specified.

4.1.3 TEST PROCEDURE

- The EUT was placed 0.8 meters from the horizontal ground plane with EUT being connected to the power mains through a line impedance stabilization network (LISN). All other support equipments powered from additional LISN(s). The LISN provide 50 Ohm/ 50uH of coupling impedance for the measuring instrument.
- Interconnecting cables that hang closer than 40 cm to the ground plane shall be folded back and forth in the center forming a bundle 30 to 40 cm long.
- I/O cables that are not connected to a peripheral shall be bundled in the center. The end of the cable may be terminated, if required, using the correct terminating impedance. The overall length shall not exceed 1 m.
- LISN at least 80 cm from nearest part of EUT chassis.
- For the actual test configuration, please refer to the related Item –EUT Test Photos.

4.1.4 DEVIATION FROM TEST STANDARD

No deviation

4.1.5 TEST SETUP

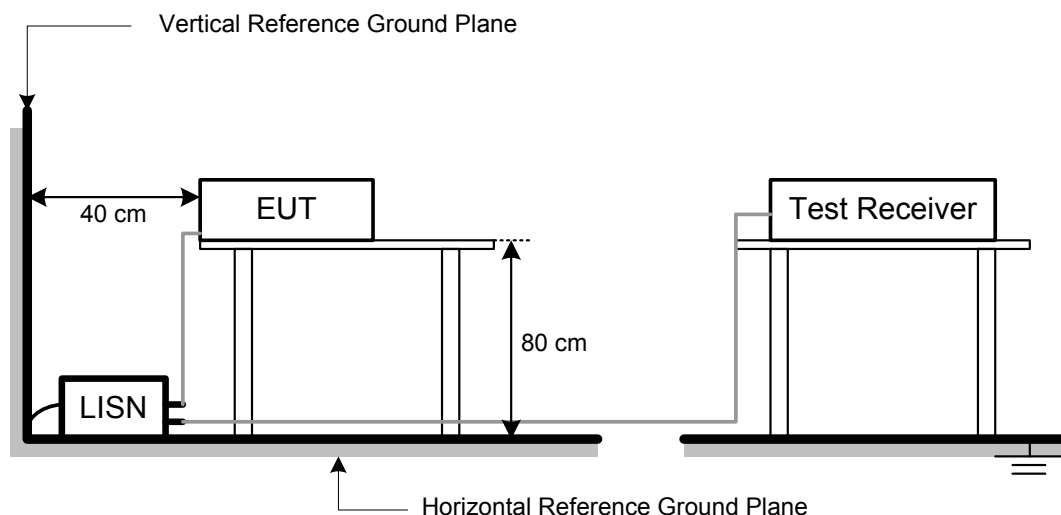

4.1.6 EUT OPERATING CONDITIONS

The EUT exercise program (EMC.exe) used during radiated and/or conducted emission measurement was designed to exercise the various system components in a manner similar to a typical use. The program contained on a PC hard disk and is auto-starting on power-up. Once loaded, the program sequentially exercises each system component in turn. The sequence used is:

1. Read (write) from (to) mass storage device (External HDD).
2. Send "H" pattern to video port device (LCD Panel).
3. Send/Receive data to/from remote system.
4. Send/Receive audio to/from audio devices.
5. Repeated from 2 to 4 continuously.

As the keyboard and mouse are strictly input devices, no data is transmitted to (from) them during test. They are, however, continuously scanned for data input activity.

The EUT has been programmed to continuously transmit during test.



4.1.7 TEST RESULTS

E.U.T :	Bedside Terminal Hardware System	Model Name :	K938(B68)
Temperature :	24 °C	Relative Humidity :	48%
Test Voltage :	AC 120V/60Hz		
Test Mode :	TX (Adapter: PMP90-13-2-B15)		

Freq. (MHz)	Terminal L/N	Measured(dBuV)		Limits(dBuV)		Margin (dB)	Note
		QP-Mode	AV-Mode	QP-Mode	AV-Mode		
0.17	Line	42.61	*	64.88	54.88	-22.27	(QP)
0.85	Line	34.55	*	56.00	46.00	-21.45	(QP)
1.44	Line	38.25	*	56.00	46.00	-17.75	(QP)
2.53	Line	40.50	*	56.00	46.00	-15.50	(QP)
6.05	Line	38.02	*	60.00	50.00	-21.98	(QP)
16.85	Line	43.11	*	60.00	50.00	-16.89	(QP)

Remark

- (1) Reading in which marked as QP means measurements by using are Quasi-Peak Mode with Detector BW=9KHz; SPA setting in RBW=10KHz,VBW =10KHz, Swp. Time = 0.2 sec./MHz ◦ Reading in which marked as AV means measurements by using are Average Mode with instrument setting in RBW=10KHz,VBW=10KHz, Swp. Time =0.2 sec./MHz ◦
- (2) All readings are QP Mode value unless otherwise stated AVG in column of 'Note'. If the QP Mode Measured value compliance with the QP Limits and lower than AVG Limits, the EUT shall be deemed to meet both QP & AVG Limits and then only QP Mode was measured, but AVG Mode didn't perform ◦ In this case, a " * " marked in AVG Mode column of Interference Voltage Measured ◦
- (3) Measuring frequency range from 150KHz to 30MHz ◦

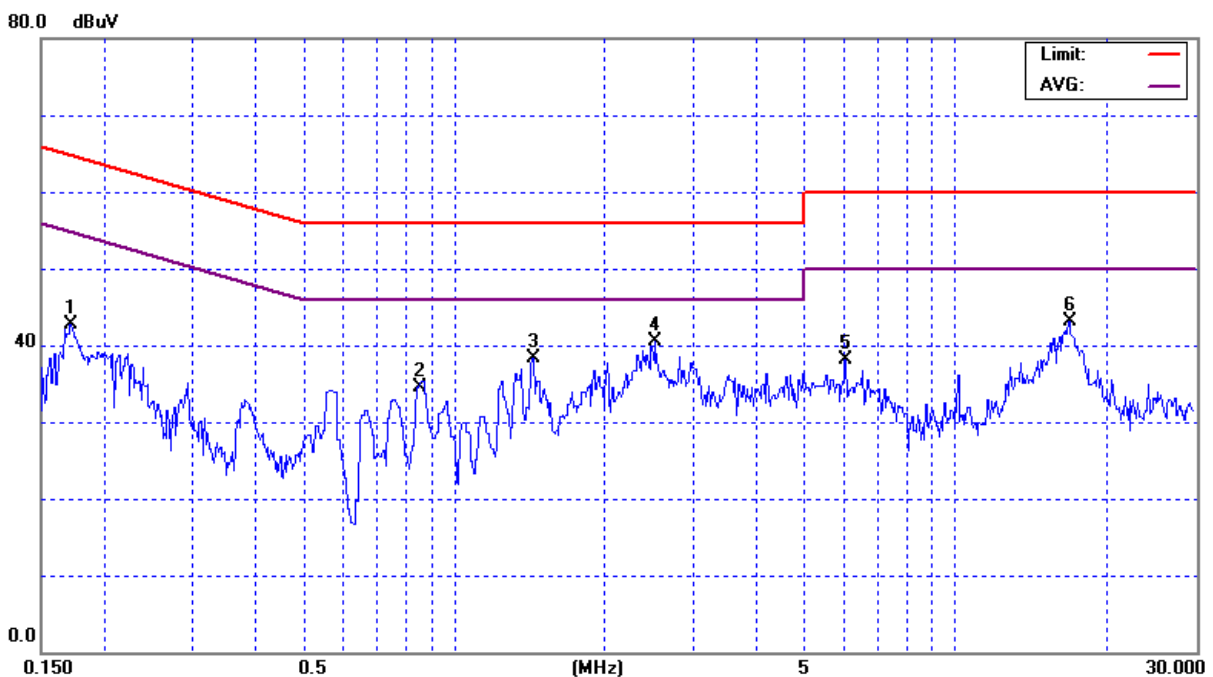



E.U.T :	Bedside Terminal Hardware System	Model Name :	K938(B68)
Temperature :	22 °C	Relative Humidity :	50%
Test Voltage :	AC 120V/60Hz		
Test Mode :	TX (Adapter: PMP90-13-2-B15)		

Freq. (MHz)	Terminal L/N	Measured(dBuV)		Limits(dBuV)		Margin (dB)	Note
		QP-Mode	AV-Mode	QP-Mode	AV-Mode		
0.19	Neutral	43.61	*	63.83	53.83	-20.22	(QP)
0.51	Neutral	33.56	*	56.00	46.00	-22.44	(QP)
2.52	Neutral	34.59	*	56.00	46.00	-21.41	(QP)
3.79	Neutral	37.11	*	56.00	46.00	-18.89	(QP)
12.35	Neutral	39.56	*	60.00	50.00	-20.44	(QP)
27.15	Neutral	35.45	*	60.00	50.00	-24.55	(QP)

Remark

- (1) Reading in which marked as QP means measurements by using are Quasi-Peak Mode with Detector BW=9KHz; SPA setting in RBW=10KHz,VBW =10KHz, Swp. Time = 0.2 sec./MHz ◦ Reading in which marked as AV means measurements by using are Average Mode with instrument setting in RBW=10KHz,VBW=10KHz, Swp. Time =0.2 sec./MHz ◦
- (2) All readings are QP Mode value unless otherwise stated AVG in column of 'Note'. If the QP Mode Measured value compliance with the QP Limits and lower than AVG Limits, the EUT shall be deemed to meet both QP & AVG Limits and then only QP Mode was measured, but AVG Mode didn't perform ◦ In this case, a " * " marked in AVG Mode column of Interference Voltage Measured ◦
- (3) Measuring frequency range from 150KHz to 30MHz ◦

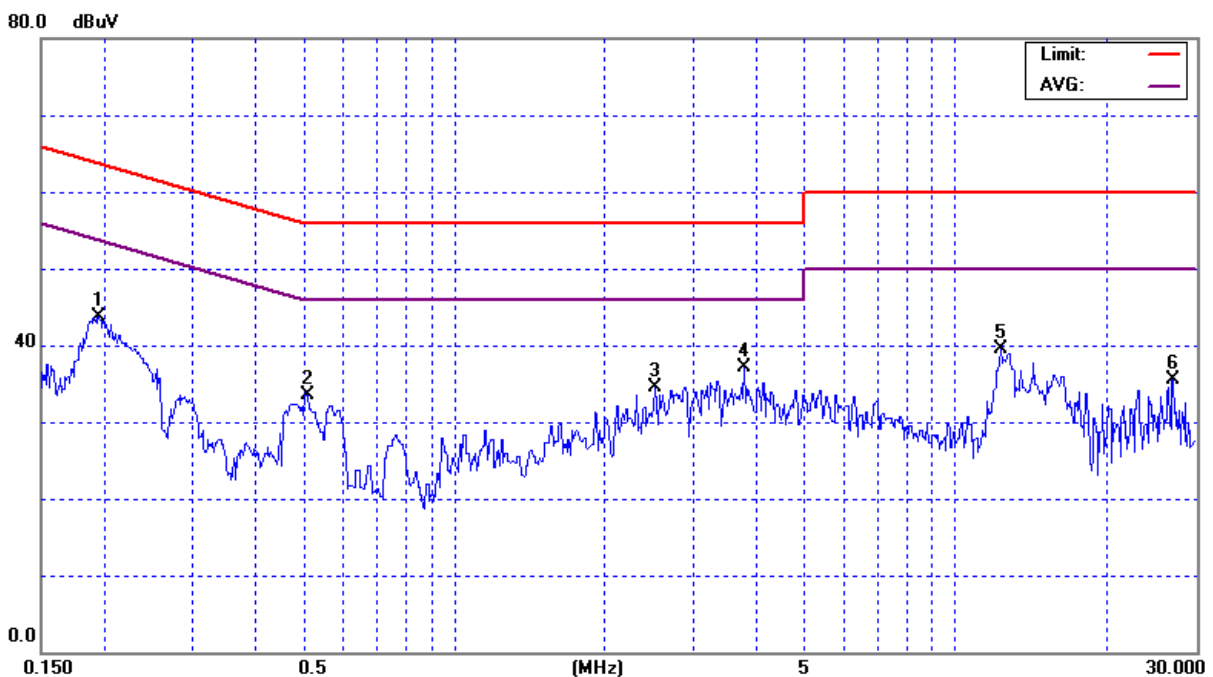



4.2 RADIATED EMISSION MEASUREMENT

4.2.1 RADIATED EMISSION LIMITS (Frequency Range 30MHz-1000MHz)

FCC Part 15.209				
Frequency (MHz)	Field Strength Limitation		Field Strength Limitation at 3m Measurement Dist	
	(uV/m)	Dist	(uV/m)	(dBuV/m)
0.009 – 0.490	2400 / F(KHz)	300m	10000 * 2400/F(KHz)	20log 2400/F(KHz) + 80
0.490 – 1.705	24000 / F(KHz)	30m	100 * 24000/F(KHz)	20log 24000/F(KHz) + 40
1.705 – 30.00	30	30m	100* 30	20log 30 + 40
30.0 – 88.0	100	3m	100	20log 100
88.0 – 216.0	150	3m	150	20log 150
216.0 – 960.0	200	3m	200	20log 200
Above 960.0	500	3m	500	20log 500
FCC Part 15.225(a)/(b)/(c)				
Frequency (MHz)	Field Strength Limitation		Field Strength Limitation at 3m Measurement Dist	
	(uV/m)	Dist	(uV/m)	(dBuV/m)
13.553 – 13.567	15,848	30 m	15,848*100	124
13.567 – 13.710	334	30 m	334*100	90.5
13.110 – 13.410 13.710 – 14.010	106	30 m	106*100	80.5

Notes:

- (1) The tighter limit shall apply at the boundary between two frequency range.
- (2) Limitation expressed in dBuV/m is calculated by 20log Emission Level (uV/m).
- (3) If measurement is made at 3m distance, then F.S Limitation at 3m distance is adjusted by using the formula of $L_{d1} = L_{d2} * (d_2/d_1)^2$.

Example:

F.S Limit at 30m distance is 30uV/m , then F.S Limitation at 3m distance is adjusted as $L_{d1} = L_1 = 30uV/m * (10)^2 = 100 * 30 uV/m$



4.2.2 MEASUREMENT INSTRUMENTS LIST

Item	Kind of Equipment	Manufacturer	Type No.	Serial No.	Calibrated until
1	Spectrum Analyzer	R&S	FSP-40	100129	Sep. 10, 2010
2	Microflex Cable	N/A	N/A	1m	May. 19, 2011
3	Test Cable	N/A	LMR-400	966_12m	Jun. 17, 2011
4	Test Cable	N/A	LMR-400	966_3m	Jun. 17, 2011
5	Pre-Amplifier	EMC	EMC-330	980001	Jun. 03, 2011
6	Log-Bicon Antenna	Schwarzbeck	VULB9168-352	9168-352	Jun. 17, 2010
7	Loop Ant.	EMCO	6502	00042960	Jan. 13,2011

Remark: " N/A" denotes No Model Name / Serial No. and No Calibration specified.

4.2.3 TEST PROCEDURE

- a. The measuring distance of at 10 m shall be used for measurements at frequency up to 1GHz. For frequencies above 1GHz, any suitable measuring distance may be used.
- b. The EUT was placed on the top of a rotating table 0.8 meters above the ground at a 3m or 10 meter open area test site. The table was rotated 360 degrees to determine the position of the highest radiation.
- c. The height of the equipment or of the substitution antenna shall be 0.8 m; the height of the test antenna shall vary between 1 m to 4 m. Both horizontal and vertical polarizations of the antenna are set to make the measurement.
- d. The initial step in collecting radiated emission data is a spectrum analyzer peak detector mode pre-scanning the measurement frequency range. Significant peaks are then marked and then Quasi Peak detector mode re-measured.
- e. If the Peak Mode measured value compliance with and lower than Quasi Peak Mode Limit, the EUT shall be deemed to meet QP Limits and then no additional QP Mode measurement performed.
- f. For the actual test configuration, please refer to the related Item –EUT Test Photos.

4.2.4 DEVIATION FROM TEST STANDARD

No deviation

4.2.5 TEST SETUP

Radiated Emission Test Set-Up Frequency 30 - 1000MHz

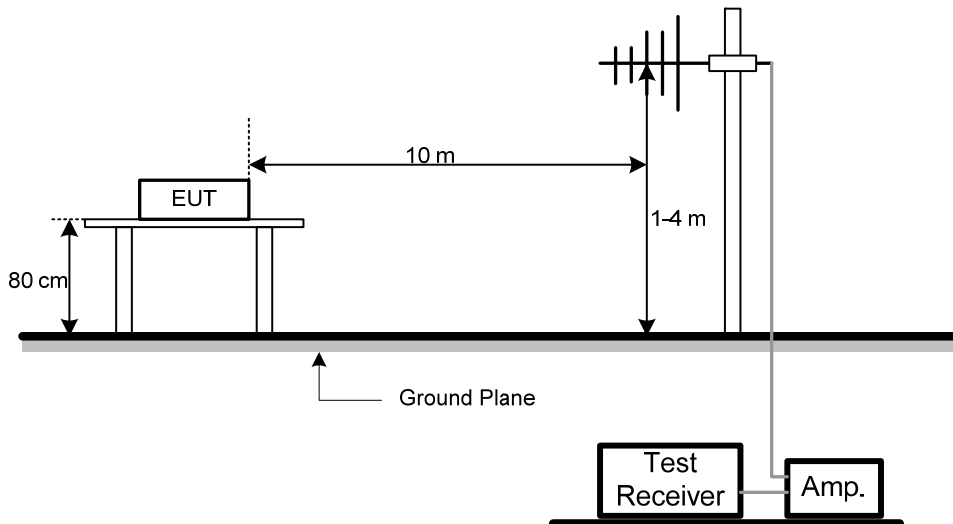

Radiated Emission Test Set-Up Frequency Above 1 GHz

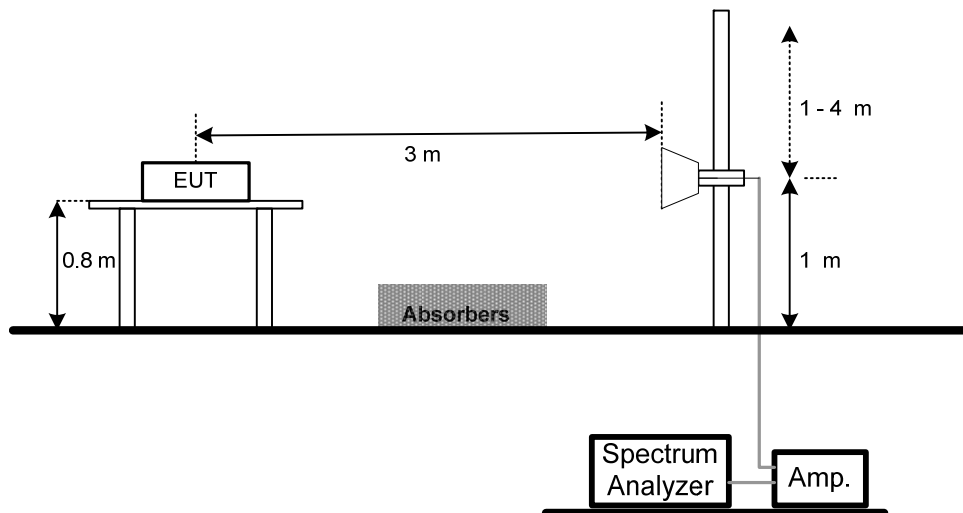

4.2.6 EUT OPERATING CONDITIONS

The EUT tested system was configured as the statements of 4.1.6 Unless otherwise a special operating condition is specified in the follows during the testing.



4.2.7 TEST RESULTS- FCC PART 15.209

E.U.T :	Bedside Terminal Hardware System	Model Name :	K938(B68)
Temperature :	23 °C	Relative Humidity :	43%
Test Voltage :	AC 120V/60Hz		
Test Mode :	TX (Adapter: PMP90-13-2-B15)		

Freq. (MHz)	Ant. Pol. H/V	Detector Mode (PK/AV)	Reading (dBuV)	Ant./CL/ Amp. CF (dB)	Actual FS (dBuV/m)	Limit-3m (dBuV/m)	Safe Margins (dBuV/m)	Note
276.38	V	Peak	54.92	- 17.60	37.32	46.00	- 8.68	
301.60	V	Peak	58.73	- 16.90	41.83	46.00	- 4.17	
350.10	V	Peak	54.84	- 15.84	39.00	46.00	- 7.00	
398.60	V	Peak	51.07	- 14.80	36.27	46.00	- 9.73	
480.08	V	Peak	52.82	- 12.99	39.83	46.00	- 6.17	
720.64	V	Peak	45.87	- 8.76	37.11	46.00	- 8.89	

Remark :

- (1) Reading in which marked as QP or Peak means measurements by using are Quasi-Peak Mode or Peak Mode with Detector BW=120KHz ; SPA setting in RBW=120KHz, VBW =120KHz, Swp. Time = 0.3 sec./MHz ◦
- (2) All readings are Peak unless otherwise stated QP in column of 『Note』 . Peak denotes that the Peak reading compliance with the QP Limits and then QP Mode measurement didn't perform ◦
- (3) Measuring frequency range from 30MHz to 1000MHz ◦
- (4) If the peak scan value lower limit more than 20dB, then this signal data does not how in table ◦

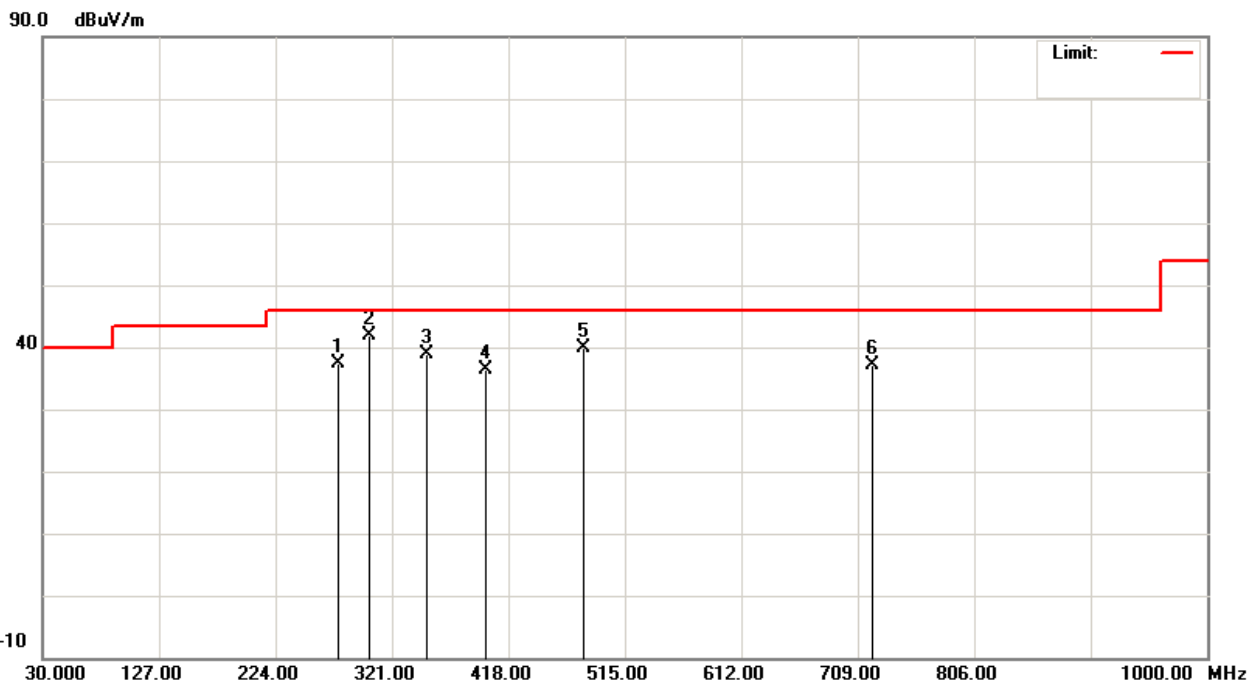



E.U.T :	Bedside Terminal Hardware System	Model Name :	K938(B68)
Temperature :	23 °C	Relative Humidity :	43%
Test Voltage :	AC 120V/60Hz		
Test Mode :	TX (Adapter: PMP90-13-2-B15)		

Freq. (MHz)	Ant.Pol. H/V	DetectorMode (PK/AV)	Reading (dBuV)	Ant./CL/ Amp. CF(dB)	Actual FS (dBuV/m)	Limit-3m (dBuV/m)	Safe Margins (dBuV/m)	Note
192.96	H	Peak	57.66	- 19.89	37.77	43.50	- 5.73	
276.38	H	Peak	60.95	- 17.60	43.35	46.00	- 2.65	
295.78	H	Peak	60.47	- 17.08	43.39	46.00	- 2.61	
301.60	H	Peak	60.41	- 16.90	43.51	46.00	- 2.49	(QP)
505.30	H	Peak	47.47	- 12.61	34.86	46.00	- 11.14	
720.64	H	Peak	49.70	- 8.76	40.94	46.00	- 5.06	

Remark :

- (1) Reading in which marked as QP or Peak means measurements by using are Quasi-Peak Mode or Peak Mode with Detector BW=120KHz ; SPA setting in RBW=120KHz, VBW =120KHz, Swp. Time = 0.3 sec./MHz ◦
- (2) All readings are Peak unless otherwise stated QP in column of 『Note 』 . Peak denotes that the Peak reading compliance with the QP Limits and then QP Mode measurement didn't perform ◦
- (3) Measuring frequency range from 30MHz to 1000MHz ◦
- (4) If the peak scan value lower limit more than 20dB, then this signal data does not how in table ◦

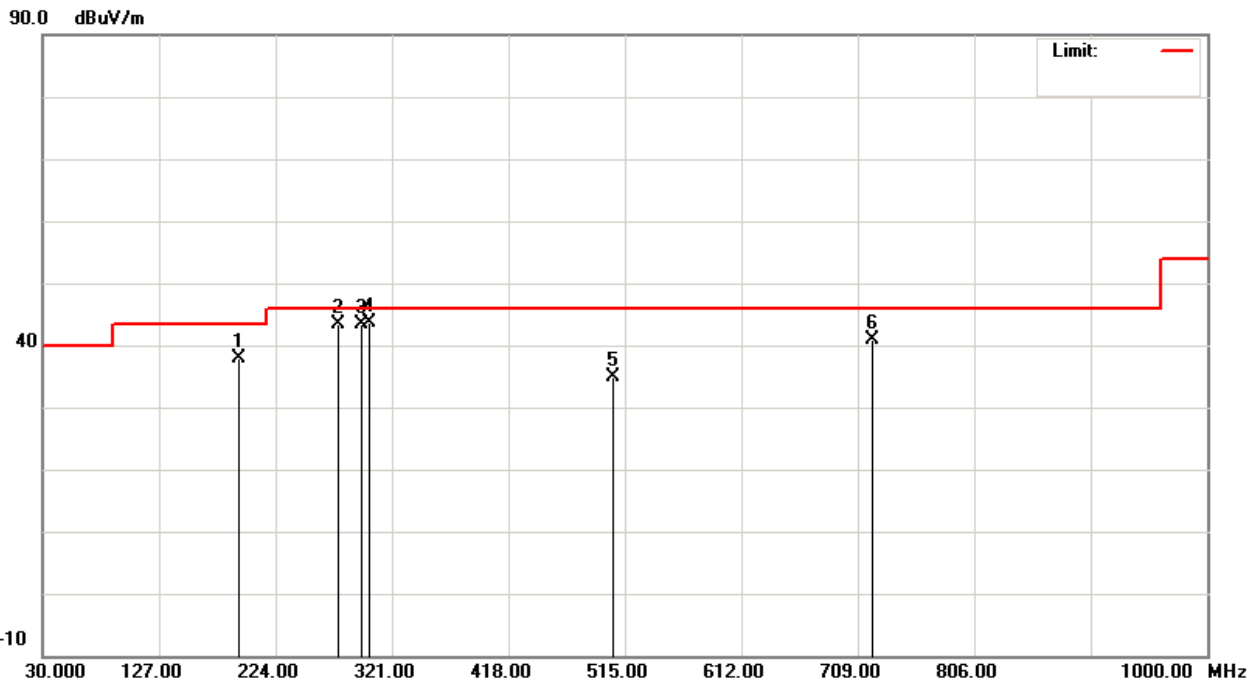



4.2.8 TEST RESULTS- FCC PART 15.225

E.U.T :	Bedside Terminal Hardware System	Model Name :	K938(B68)
Temperature :	23 °C	Relative Humidity :	43%
Test Voltage :	AC 120V/60Hz		
Test Mode :	TX (Adapter: PMP90-13-2-B15)		

Freq. (MHz)	DetectorMode (PK/AV)	Reading (dBuV)	Ant./CL/ Amp. CF(dB)	Actual FS (dBuV/m)	Limit-3m (dBuV/m)	Safe Margins (dBuV/m)	Note
13.56	Peak	49.34	10.86	60.20	124.00	- 63.80	
27.16	Peak	21.60	- 8.27	13.33	69.54	- 56.21	

Remark :

- (1) Spectrum Setting:
 9 KHz – 150 KHz, RBW= 1 KHz, VBW=1 KHz, Sweep time = 200 ms.
 150 K Hz – 30 MHz, RBW= 9 KHz, VBW=9 KHz, Sweep time = 200 ms.
 30 MHz – 1000 MHz, RBW= 100KHz, VBW=100KHz, Sweep time = 200 ms.
- (2) All readings are Peak unless otherwise stated QP in column of 『Note』 . Peak denotes that the Peak reading compliance with the QP Limits and then QP Mode measurement didn't perform ◦
- (3) The Log-Bicon Antenna will use to test frequency range from 30MHz to 1000MHz and the Loop Antenna will use to test frequency below 30MHz.
- (4) If the peak scan value lower limit more than 20dB, then this signal data does not how in table ◦

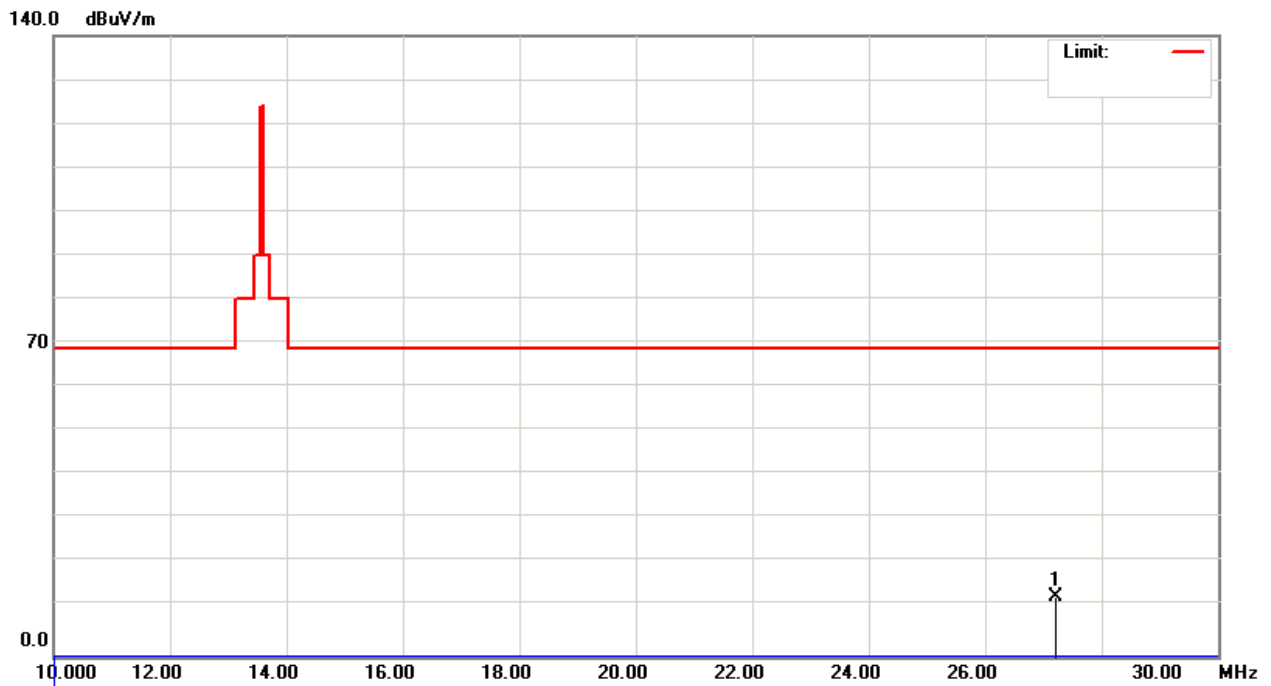
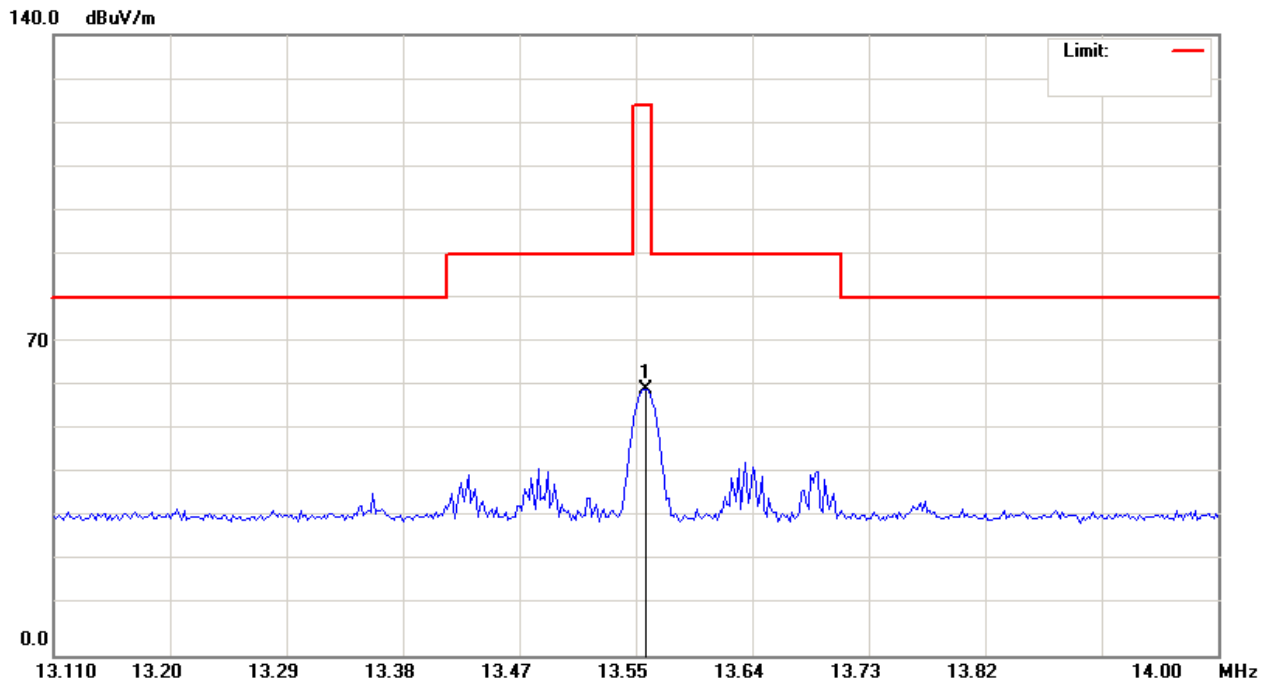



4.3 FREQUENCY STABILITY MEASUREMENT

4.3.1 FREQUENCY STABILITY LIMITS

FCC Part 15.225(e)
the frequency tolerance of the carrier signal shall be maintained within +/-0.01% of the operating frequency over a temperature variation of -20 degrees to + 50 degrees C at normal supply voltage, and for a variation in the primary supply voltage from 85% to 115% of the rated supply voltage at a temperature of 20 degrees C. For battery operated equipment, the equipment tests shall be performed using a new battery.

4.3.2 MEASUREMENT INSTRUMENTS LIST

Item	Kind of Equipment	Manufacturer	Type No.	Serial No.	Calibrated until
1	Spectrum Analyzer	R&S	FSL-6	100257	Jul. 06, 2010

Remark: " N/A" denotes No Model No. / Serial No. and No Calibration specified.

4.3.3 TEST PROCEDURE

- a. The equipment under test was connected to an external AC power supply and the RF output was connected to a frequency counter via feed through attenuators. The EUT was placed inside the temperature chamber.
After the temperature stabilized for approximately 20 minutes, the frequency of the output signal was recorded from the counter.
- b. At room temperature (25±5°C), an external variable AC power supply was connected to the EUT. The frequency of the transmitter was measured for 115%, 100% and 85% of the nominal operating input voltage.
- c. For the actual test configuration, please refer to the related Item –EUT Test Photos.

4.3.4 DEVIATION FROM TEST STANDARD

No deviation

4.3.5 EUT OPERATING CONDITIONS

The EUT tested system was configured as the statements of 4.1.6 Unless otherwise a special operating condition is specified in the follows during the testing.



4.3.6 TEST RESULTS

E.U.T :	Bedside Terminal Hardware System	Model Name :	K938(B68)
Temperature :	23 °C	Relative Humidity :	50%
Test Voltage :	AC 120V/60Hz		
Test Mode :	TX (Adapter: PMP90-13-2-B15)		

Frequency Stability Versus Environmental Temperature						
	Temperature (°C)	Voltage (Vac)	Frequency (MHz)	Freq Error (KHz)	Limit (KHz)	Results
	20	120V	13.56160			
0 min	50	120V	13.56168	0.080	+/- 1.356	PASS
	-20	120V	13.56150	-0.100	+/- 1.356	PASS
2 min	50	120V	13.56250	0.900	+/- 1.356	PASS
	-20	120V	13.56070	-0.900	+/- 1.356	PASS
5 min	50	120V	13.56170	0.100	+/- 1.356	PASS
	-20	120V	13.56144	-0.160	+/- 1.356	PASS
10 min	50	120V	13.56165	0.050	+/- 1.356	PASS
	-20	120V	13.56141	-0.190	+/- 1.356	PASS

Frequency Stability Versus Input Voltage						
Temperature (°C)	Voltage (Vac)		Frequency (MHz)	Freq Error (KHz)	Limit (KHz)	Results
20	V-nom	120	13.56160			
20	V-min	102	13.5616	0.003	+/- 1.356	PASS
20	V-max	138	13.5616	0.003	+/- 1.356	PASS