



Radio Test Report

FCC ID: XHM-K948C73

This report concerns (check one) : Original Grant Class II Change

Issued Date : Oct. 09, 2013
Project No. : 1307003
Equipment : Bedside Terminal Hardware System
Model Name : K948

Applicant : FLYTECH TECHNOLOGY CO., LTD.
Address : 1F, No. 168, Sing-Ai Rd., NeiHu District
 114, Taipei, Taiwan

Tested by: Neutron Engineering Inc. EMC Laboratory
Date of Receipt: Jul. 03, 2013
Date of Test: Jul. 03, 2013 ~ Aug. 05, 2013

Testing Engineer: Josh Lin
 (Josh Lin)

Technical Manager: Jeff Yang
 (Jeff Yang)

Authorized Signatory: Andy Chiu
 (Andy Chiu)

Neutron Engineering Inc.
 B1, No. 37, Lane 365, YangGuang St.,
 NeiHu District 114, Taipei, Taiwan.
 TEL: +886-2-2657-3299
 FAX: +886-2-2657-3331





Neutron Engineering Inc.

Declaration

Neutron represents to the client that testing is done in accordance with standard procedures as applicable and that test instruments used has been calibrated with the standards traceable to National Measurement Laboratory (**NML**) of **R.O.C.**, or National Institute of Standards and Technology (**NIST**) of **U.S.A.**

Neutron's reports apply only to the specific samples tested under conditions. It is manufacture's responsibility to ensure that additional production units of this model are manufactured with the identical electrical and mechanical components. **Neutron** shall have no liability for any declarations, inferences or generalizations drawn by the client or others from **Neutron** issued reports.

Neutron's reports must not be used by the client to claim product endorsement by the authorities or any agency of the Government.

This report is the confidential property of the client. As a mutual protection to the clients, the public and **Neutron-self**, extracts from the test report shall not be reproduced except in full with **Neutron's** authorized written approval.

Neutron's laboratory quality assurance procedures are in compliance with the **ISO Guide 17025** requirements, and accredited by the conformity assessment authorities listed in this test report.

Limitation

For the use of the authority's logo is limited unless the Test Standard(s)/Scope(s)/Item(s) mentioned in this test report is (are) included in the conformity assessment authorities acceptance respective.



Table of Contents

REPORT ISSUED HISTORY	4
1 CERTIFICATION	5
2 SUMMARY OF TEST RESULTS	6
2.1 TEST FACILITY	7
2.2 MEASUREMENT UNCERTAINTY	7
3 GENERAL INFORMATION	8
3.1 GENERAL DESCRIPTION OF EUT	8
3.2 DESCRIPTION OF TEST MODES	9
3.3 BLOCK DIAGRAM SHOWING THE CONFIGURATION OF SYSTEM TESTED	10
3.4 DESCRIPTION OF SUPPORT UNITS	11
4 CONDUCTED EMISSION	12
4.1 LIMITS	12
4.2 MEASUREMENT INSTRUMENTS LIST	12
4.3 TEST PROCEDURES	13
4.4 TEST SETUP LAYOUT	13
4.5 DEVIATION FROM TEST STANDARD	13
4.6 EUT OPERATING CONDITIONS	14
4.7 TEST RESULTS	15
5 RADIATED EMISSION	17
5.1 LIMITS	17
5.2 MEASUREMENT INSTRUMENTS LIST	18
5.3 TEST PROCEDURE	18
5.4 DEVIATION FROM TEST STANDARD	19
5.5 TEST SETUP	19
5.6 EUT OPERATING CONDITIONS	19
5.7 TEST RESULTS- FCC PART 15.209	20
5.8 TEST RESULTS- FCC PART 15.225	22
6 FREQUENCY STABILITY	24
6.1 LIMITS	24
6.2 MEASUREMENT INSTRUMENTS LIST	24
6.3 TEST PROCEDURE	24
6.4 DEVIATION FROM TEST STANDARD	24
6.5 EUT OPERATING CONDITIONS	24
6.6 TEST RESULTS	25
7 EUT TEST PHOTO	26



REPORT ISSUED HISTORY

Revised Version No.	Description	Issued Date
-	Initial Issue.	Oct. 09, 2013



Neutron Engineering Inc.

1 CERTIFICATION

Equipment : Bedside Terminal Hardware System
Brand Name : FLYTECH
Model Name : K948
Applicant : FLYTECH TECHNOLOGY CO., LTD.
Date of Test : Jul. 03, 2013 ~ Aug. 05, 2013
Standards : FCC Part 15, Subpart C: 2012
ANSI C63.4: 2009

The above equipment has been tested and found compliance with the requirement of the relative standards by Neutron Engineering Inc. EMC Laboratory.

The test data, data evaluation, and equipment configuration contained in our test report (Ref No. NEI-FCCP-1-1307003) were obtained utilizing the test procedures, test instruments, test sites that has been accredited by the Authority of TAF according to the ISO-17025 quality assessment standard and technical standard(s).



2 SUMMARY OF TEST RESULTS

Test procedures according to the technical standards:

Standard Section	Test Item	Result
15.207	Conducted emission	PASS
15.35 / 15.205 / 15.209 / 15.225	Radiated emission	PASS
15.225(e)	Frequency Stability	PASS
15.203	Antenna Requirement	PASS

NOTE:

1. **N/A**: denotes test is not applicable in this Test Report



2.1 TEST FACILITY

The test facilities used to collect the test data in this report:

Conducted emission Test:

C01: (VCCI RN: C-2918; FCC RN: 95335; FCC DN: TW1010)
 No.132-1, Ln. 329, Sec. 2, Balian Rd., Xizhi Dist., New Taipei City 221, Taiwan (R.O.C.)

Radiated emission Test:

CB08: (FCC RN: 614388; FCC DN: TW1054; IC Assigned Code: 4428C-1)
 1F., No. 61, Ln. 77, Sing-ai Rd., Neihu Dist., Taipei City 114, Taiwan (R.O.C.)

2.2 MEASUREMENT UNCERTAINTY

The measurement uncertainty is not specified by FCC rules and for reference only.

The reported uncertainty of measurement $y \pm U$, where expanded uncertainty U is based on a standard uncertainty multiplied by a coverage factor of $k=2$, providing a level of confidence of approximately **95%**.

The measurement instrumentation uncertainty considerations contained in CISPR 16-4-2.

A. Conducted emission test:

Test Site	Measurement Frequency Range	U , (dB)	NOTE
C01	150 kHz ~ 30 MHz	1.94	

B. Radiated emission test:

Test Site	Item	Measurement Frequency Range	Uncertainty	NOTE	
CB08	Radiated emission at 3m	Horizontal Polarization	30 - 200MHz	3.35 dB	
			200 - 1000MHz	3.11 dB	
			1 - 18GHz	3.97 dB	
			18 - 40GHz	4.01 dB	
		Vertical Polarization	30 - 200MHz	3.22 dB	
			200 - 1000MHz	3.24 dB	
			1 - 18GHz	4.05 dB	
			18 - 40GHz	4.04 dB	

Our calculated Measurement Instrumentation Uncertainty is shown in the tables above. These are our U_{lab} values in CISPR 16-4-2 terminology.

Since Table 1 of CISPR 16-4-2 has values of measurement instrumentation uncertainty, called U_{CISPR} , as follows:

Conducted Disturbance (mains port) – 150 kHz – 30 MHz : 3.6 dB

Radiated Disturbance (electric field strength on an open area test site or alternative test site) – 30 MHz – 1000 MHz : 5.2 dB

It can be seen that our U_{lab} values are smaller than U_{CISPR} .



3 GENERAL INFORMATION

3.1 GENERAL DESCRIPTION OF EUT

Equipment	Bedside Terminal Hardware System				
Brand Name	FLYTECH				
Model Name	K948				
OEM Brand/Model Name	N/A				
Model Difference	N/A				
Product Description	<p>The EUT is a Bedside Terminal Hardware System.</p> <table border="1"> <tr> <td>Operation Frequency:</td> <td>13.56 MHz</td> </tr> <tr> <td>Antenna Designation:</td> <td>LOOP Antenna</td> </tr> </table> <p>More details of EUT technical specification, please refer to the User's Manual.</p>	Operation Frequency:	13.56 MHz	Antenna Designation:	LOOP Antenna
Operation Frequency:	13.56 MHz				
Antenna Designation:	LOOP Antenna				
Power Source	DC Voltage supplied from External Power Supply.				
Power Rating	<p>1. EUT: I/P: DC 12-48V 5-1.5A</p> <p>2. External Power Supply:</p> <p>(1) PROTEK ELECTRONICS CORP, PMP105-18-B15 I/P: AC 100-240V 1.4-0.7A 47-63Hz / O/P: DC 46-50V 2.29A MAX 105W MAX (Output voltage set at 48V)</p> <p>(2) PROTEK ELECTRONICS CORP, PMP60-12-B16 I/P: AC 100-240V 1.22-0.68A 47-63Hz / O/P: DC 11-13V 5.46A</p> <p>(3) ENERTRONIX, EXA0703YH I/P: AC 100-240V 50-60Hz 1.5A / O/P: DC +19V 3.42A</p>				
Connecting I/O Port(s)	Please refer to the User's Manual				
Products Covered	<p>1 * Mother board: C73</p> <p>1 * CPU: Intel, Celeron 1047UE, 1.40 GHz</p> <p>2 * Memory: TLA, 2 GB, DDR3-1600</p> <p>1 * SSD: ADATA, IS22(N), 64 GB</p> <p>1 * Wi-Fi Module: Intel, 633ANHMW (FCC ID: PD9633ANHU; IC: 1000M-633ANHU)</p> <p>1 * RFID Module: EZM710AU-FLYTECH-001</p> <p>1 * Webcam</p> <p>1 * Smart IC Card Reader: CASTLES TECHNOLOGY, EZM110PU-FT</p> <p>1 * Combo Smart IC Card Reader (optional) with separate RFID antenna in the front bezel: EZM710AU-FLYTECH-001</p> <p>1 * Panel: AU Optronics, M185XTN01</p> <p>1 * Headset module</p> <p>1 * Wired remote (rimo)</p> <p>1 * External Power Supply (optional):</p> <p>(1) PROTEK ELECTRONICS CORP, PMP105-18-B15</p> <p>(2) PROTEK ELECTRONICS CORP, PMP60-12-B16</p> <p>(3) ENERTRONIX, EXA0703YH</p>				
EUT Modification(s)	N/A				

Note:

1. For a more detailed features description, please refer to the manufacturer's specifications or the User's Manual.



3.2 DESCRIPTION OF TEST MODES

To investigate the maximum EMI emission characteristics generated from EUT, the test system was pre-scanning tested based on the consideration of following EUT operation mode or test configuration mode which possibly have effect on EMI emission level. Each of these EUT operation mode(s) or test configuration mode(s) mentioned above was evaluated respectively.

Pretest Test Mode	Description
Mode 1	Transmitting

Conducted emission test

Final Test Mode	Description
Mode 1	Transmitting

Radiated emission test

Final Test Mode	Description
Mode 1	Transmitting

Frequency Stability test

Final Test Mode	Description
Mode 1	Transmitting

Antenna Requirement test

Final Test Mode	Description
Mode 1	Transmitting



3.3 BLOCK DIAGRAM SHOWING THE CONFIGURATION OF SYSTEM TESTED

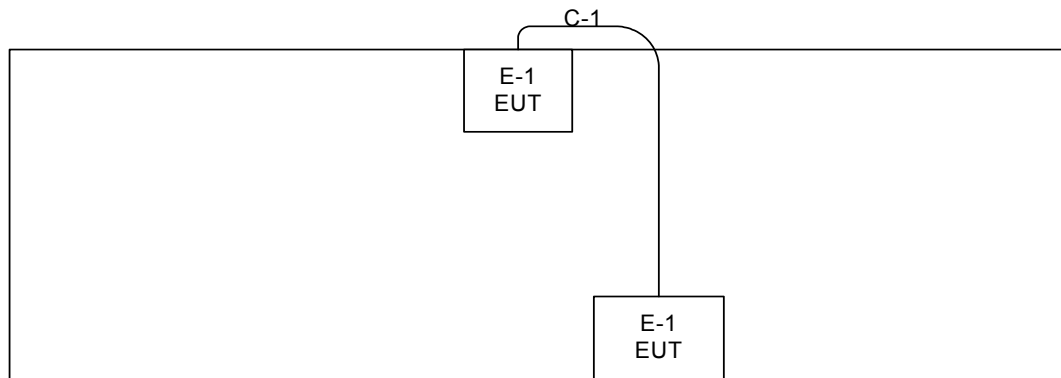

C-1 Data Cable

**Neutron Engineering Inc.****3.4 DESCRIPTION OF SUPPORT UNITS**

The EUT has been tested as an independent unit together with other necessary accessories or support units. The following support units or accessories were used to form a representative test configuration during the tests.

Item	Equipment	Mfr/Brand	Model/Type No.	FCC ID	Series No.	Note
E-1	Bedside Terminal Hardware System	FLYTECH	K948	XHM-K948C73	N/A	EUT

Item	Shielded Type	Ferrite Core	Length	Note
C-1	YES	NO	2.9M	

Note:

- (1) The support equipment was authorized by Declaration of Conformity (DOC).



4 CONDUCTED EMISSION

4.1 LIMITS

FREQUENCY (MHz)	Class A (dBuV)		Class B (dBuV)	
	Quasi-peak	Average	Quasi-peak	Average
0.15 - 0.5	79.00	66.00	66 - 56 *	56 - 46 *
0.50 - 5.0	73.00	60.00	56.00	46.00
5.0 - 30.0	73.00	60.00	60.00	50.00

NOTE:

1. The tighter limit applies at the band edges.
2. The limit of " * " marked band means the limitation decreases linearly with the logarithm of the frequency in the range.
3. The test result calculated as following:
 Measurement Value = Reading Level + Correct Factor
 Correct Factor = Insertion Loss + Cable Loss + Attenuator Factor(if use)
 Margin Level = Measurement Value – Limit Value

4.2 MEASUREMENT INSTRUMENTS LIST

Item	Kind of Equipment	Manufacturer	Type No.	Serial No.	Calibrated until
1	TWO-LINE V-NETWORK	R&S	ENV216	101050	Apr. 22, 2014
2	Test Cable	TIMES	CFD300-NL	C01	Jun. 16, 2014
3	EMI Test Receiver	R&S	ESCI	100082	Mar. 21, 2014
4	Measurement Software	EZ	EZ_EMG (Version NB-02A)	N/A	N/A

NOTE: **N/A**: denotes No Model Name, No Serial No. or No Calibration specified.

4.3 TEST PROCEDURES

- a. The EUT was placed 0.8 meters from the horizontal ground plane with EUT being connected to the power mains through a line impedance stabilization network (LISN). All other support equipments powered from additional LISN(s). The LISN provide 50 Ohm/ 50uH of coupling impedance for the measuring instrument.
- b. Interconnecting cables that hang closer than 40 cm to the ground plane shall be folded back and forth in the center forming a bundle 30 to 40 cm long.
- c. I/O cables that are not connected to a peripheral shall be bundled in the center. The end of the cable may be terminated, if required, using the correct terminating impedance. The overall length shall not exceed 1 m.
- d. LISN at least 80 cm from nearest part of EUT chassis.
- e. For the actual test configuration, please refer to the related Item –EUT Test Photos.

NOTE:

- a. Reading in which marked as Peak, QP or AVG means measurements by using are Quasi-Peak or Average Mode with Detector BW=9 kHz (6 dB Bandwidth).
- b. All readings are Peak Mode value unless otherwise stated QP or AVG in column of Note. If the Peak or QP Mode Measured value compliance with the QP Limits and lower than AVG Limits, the EUT shall be deemed to meet both QP & AVG Limits and then only Peak or QP Mode was measured, but AVG Mode didn't perform.

4.4 TEST SETUP LAYOUT

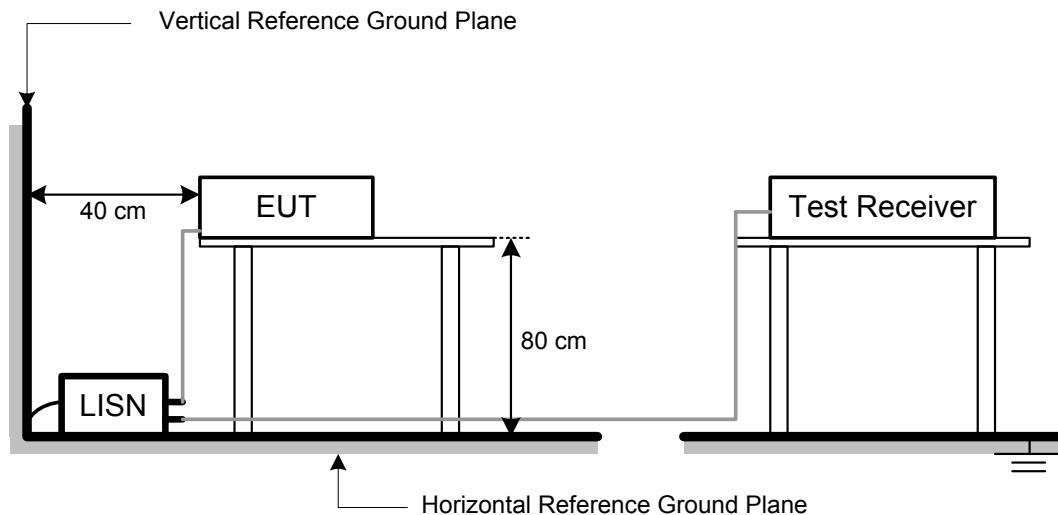

4.5 DEVIATION FROM TEST STANDARD

No deviation



4.6 EUT OPERATING CONDITIONS

The EUT used during radiated and/or conducted emission measurement was designed to exercise in a manner similar to a typical use.



4.7 TEST RESULTS

EUT	Bedside Terminal Hardware System	Model Name	K948
Temperature	31°C	Relative Humidity	53%
Test Voltage	AC 120V/60Hz		
Test Mode	Transmitting		

Phase: Line

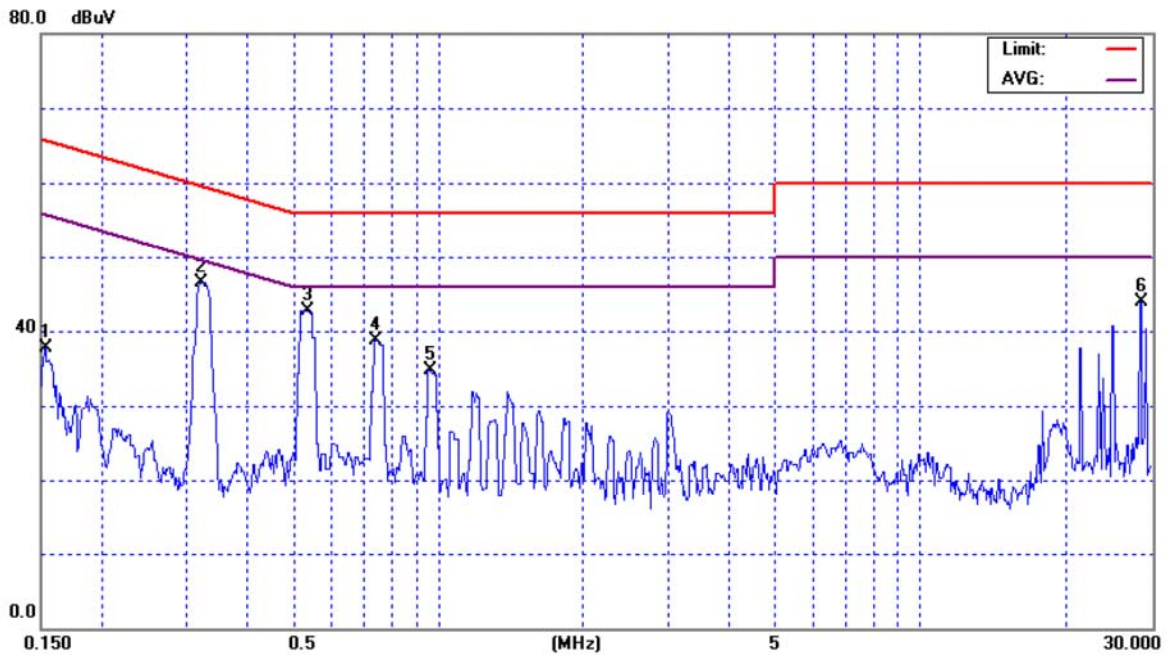

No. Mk.	Freq. MHz	Reading Level dBuV	Correct Factor dB	Measurement dBuV	Limit dBuV	Over dB	Detector	Comment
1	0.1528	27.99	9.72	37.71	65.85	-28.14	peak	
2 *	0.3208	36.91	9.64	46.55	59.69	-13.14	peak	
3	0.5360	33.09	9.61	42.70	56.00	-13.30	peak	
4	0.7430	29.01	9.62	38.63	56.00	-17.37	peak	
5	0.9590	24.99	9.63	34.62	56.00	-21.38	peak	
6	28.6500	34.01	9.96	43.97	60.00	-16.03	peak	



EUT	Bedside Terminal Hardware System	Model Name	K948
Temperature	31°C	Relative Humidity	53%
Test Voltage	AC 120V/60Hz		
Test Mode	Transmitting		

Phase: Neutral

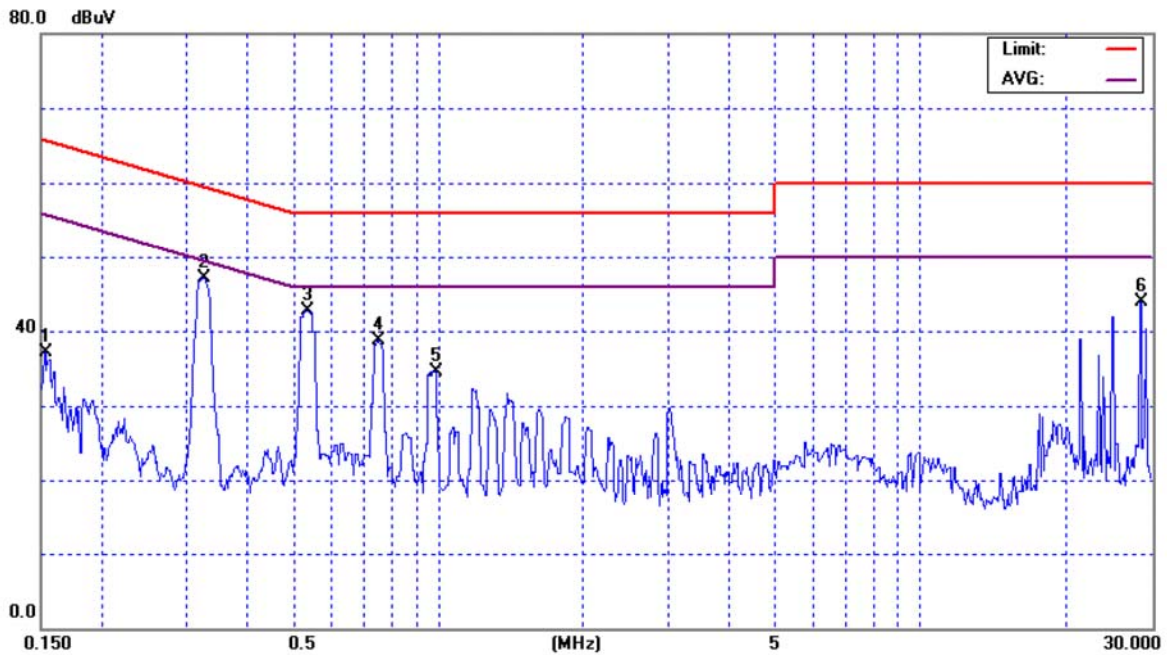

No. Mk.	Freq. MHz	Reading Level dBuV	Correct Factor dB	Measurement dBuV	Limit dBuV	Over dB	Detector	Comment
1	0.1528	27.36	9.70	37.06	65.85	-28.79	peak	
2 *	0.3257	37.41	9.63	47.04	59.56	-12.52	peak	
3	0.5360	33.20	9.59	42.79	56.00	-13.21	peak	
4	0.7520	29.03	9.61	38.64	56.00	-17.36	peak	
5	0.9860	24.90	9.62	34.52	56.00	-21.48	peak	
6	28.6500	34.07	9.93	44.00	60.00	-16.00	peak	



5 RADIATED EMISSION

5.1 LIMITS

FCC Part 15.209				
Frequency (MHz)	Field Strength Limitation		Field Strength Limitation at 3m Measurement Dist	
	(uV/m)	Dist	(uV/m)	(dBuV/m)
0.009 – 0.490	2400 / F(KHz)	300m	10000 * 2400/F(KHz)	20log 2400/F(KHz) + 80
0.490 – 1.705	24000 / F(KHz)	30m	100 * 24000/F(KHz)	20log 24000/F(KHz) + 40
1.705 – 30.00	30	30m	100* 30	20log 30 + 40
30.0 – 88.0	100	3m	100	20log 100
88.0 – 216.0	150	3m	150	20log 150
216.0 – 960.0	200	3m	200	20log 200
Above 960.0	500	3m	500	20log 500
FCC Part 15.225(a)/(b)/(c)				
Frequency (MHz)	Field Strength Limitation		Field Strength Limitation at 3m Measurement Dist	
	(uV/m)	Dist	(uV/m)	(dBuV/m)
13.553 – 13.567	15,848	30 m	15,848*100	124
13.567 – 13.710	334	30 m	334*100	90.5
13.110 – 13.410	106	30 m	106*100	80.5
13.710 – 14.010				

NOTE:

- (1) The tighter limit shall apply at the boundary between two frequency range.
- (2) Limitation expressed in dBuV/m is calculated by 20log Emission Level (uV/m).
- (3) If measurement is made at 3m distance, then F.S Limitation at 3m distance is adjusted by using the formula of $L_{d1} = L_{d2} * (d_2/d_1)^2$.
 Example:
 F.S Limit at 30m distance is 30uV/m , then F.S Limitation at 3m distance is adjusted as $L_{d1} = L_1 = 30uV/m * (10)^2 = 100 * 30 uV/m$
- (4) The test result calculated as following:
 Measurement Value = Reading Level + Correct Factor
 Correct Factor = Insertion Loss + Cable Loss + Attenuator Factor(if use)
 Margin Level = Measurement Value – Limit Value



5.2 MEASUREMENT INSTRUMENTS LIST

Table with 6 columns: Item, Kind of Equipment, Manufacturer, Type No., Serial No., Calibrated until. Contains 8 rows of equipment data.

Remark: "N/A" denotes No Model Name, No Serial No. or No Calibration specified.

5.3 TEST PROCEDURE

- a. The measuring distance of at 3 m shall be used for measurements at frequency up to 1GHz. For frequencies above 1GHz, any suitable measuring distance may be used.
b. The EUT was placed on the top of a rotating table 0.8 meters above the ground at a 3m or 10 meter open area test site. The table was rotated 360 degrees to determine the position of the highest radiation.
c. The height of the equipment or of the substitution antenna shall be 0.8 m; the height of the test antenna shall vary between 1 m to 4 m. Both horizontal and vertical polarizations of the antenna are set to make the measurement.
d. The initial step in collecting radiated emission data is a spectrum analyzer peak detector mode pre-scanning the measurement frequency range. Significant peaks are then marked and then Quasi Peak detector mode re-measured.
e. If the Peak Mode measured value compliance with and lower than Quasi Peak Mode Limit, the EUT shall be deemed to meet QP Limits and then no additional QP Mode measurement performed.
f. For the actual test configuration, please refer to the related Item -EUT Test Photos.

NOTE: (FCC PART 15.209)

- a. Reading in which marked as QP or Peak means measurements by using are Quasi-Peak Mode with Detector BW=120 kHz.
b. All readings are Peak unless otherwise stated QP in column of Note. Peak denotes that the Peak reading compliance with the QP Limits and then QP Mode measurement didn't perform.

NOTE: (FCC PART 15.225)

- a. Spectrum Setting:
9 KHz - 150 KHz, RBW= 200Hz, VBW=200Hz, Sweep time = 200 ms.
150 K Hz - 30 MHz, RBW= 10 KHz, VBW=10 KHz, Sweep time = 200 ms.
30 MHz - 1000 MHz, RBW= 100KHz, VBW=100KHz, Sweep time = 200 ms.
b. All readings are Peak unless otherwise stated QP in column of Note. Peak denotes that the Peak reading compliance with the QP Limits and then QP Mode measurement didn't perform.
c. The Log-Bicon Antenna will use to test frequency range from 30MHz to 1000MHz and the Loop Antenna will use to test frequency below 30MHz.

5.4 DEVIATION FROM TEST STANDARD

No deviation

5.5 TEST SETUP

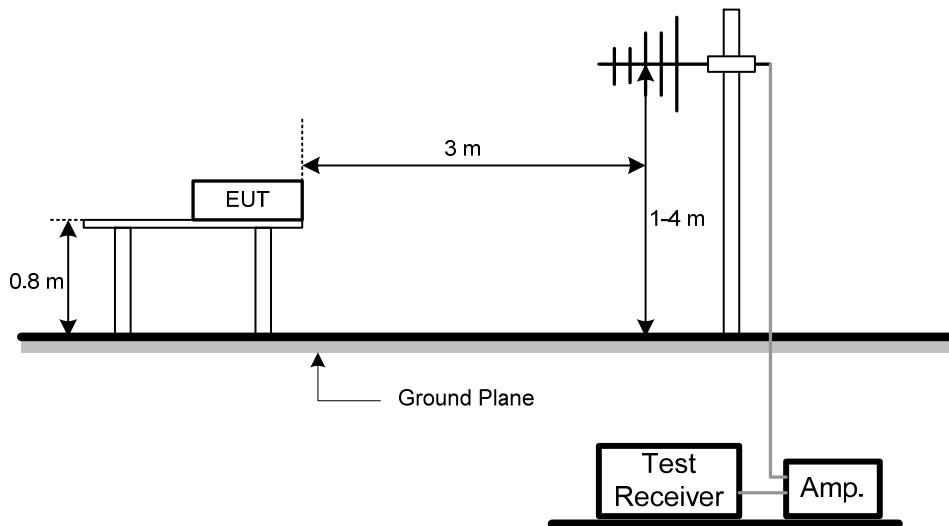

5.6 EUT OPERATING CONDITIONS

The EUT tested system was configured as the statements of 4.1.6 Unless otherwise a special operating condition is specified in the follows during the testing.



5.7 TEST RESULTS- FCC PART 15.209

EUT	Bedside Terminal Hardware System	Model Name	K948
Temperature	26 °C	Relative Humidity	60%
Test Voltage	AC 120V/60Hz		
Test Mode	Transmitting		

Polarization: Vertical

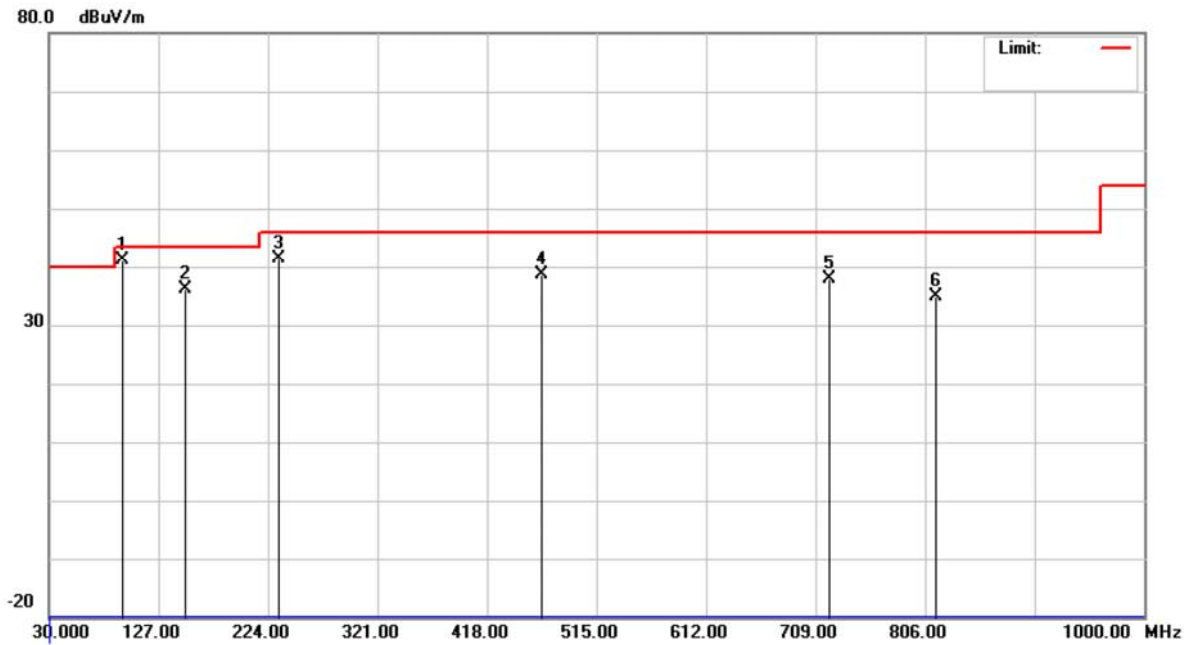

No.	Mk.	Freq. MHz	Reading Level dBuV	Correct Factor dB	Measure- ment dBuV/m	Limit dBuV/m	Over dB	Detector	Comment
1	*	95.4749	60.82	-19.73	41.09	43.50	-2.41	peak	
2		151.2500	50.25	-14.15	36.10	43.50	-7.40	peak	
3		233.6999	57.41	-15.99	41.42	46.00	-4.58	peak	
4		466.5000	48.20	-9.67	38.53	46.00	-7.47	peak	
5		721.1250	43.86	-6.00	37.86	46.00	-8.14	peak	
6		815.7000	39.38	-4.59	34.79	46.00	-11.21	peak	



EUT	Bedside Terminal Hardware System	Model Name	K948
Temperature	26 °C	Relative Humidity	60%
Test Voltage	AC 120V/60Hz		
Test Mode	Transmitting		

Polarization: Horizontal

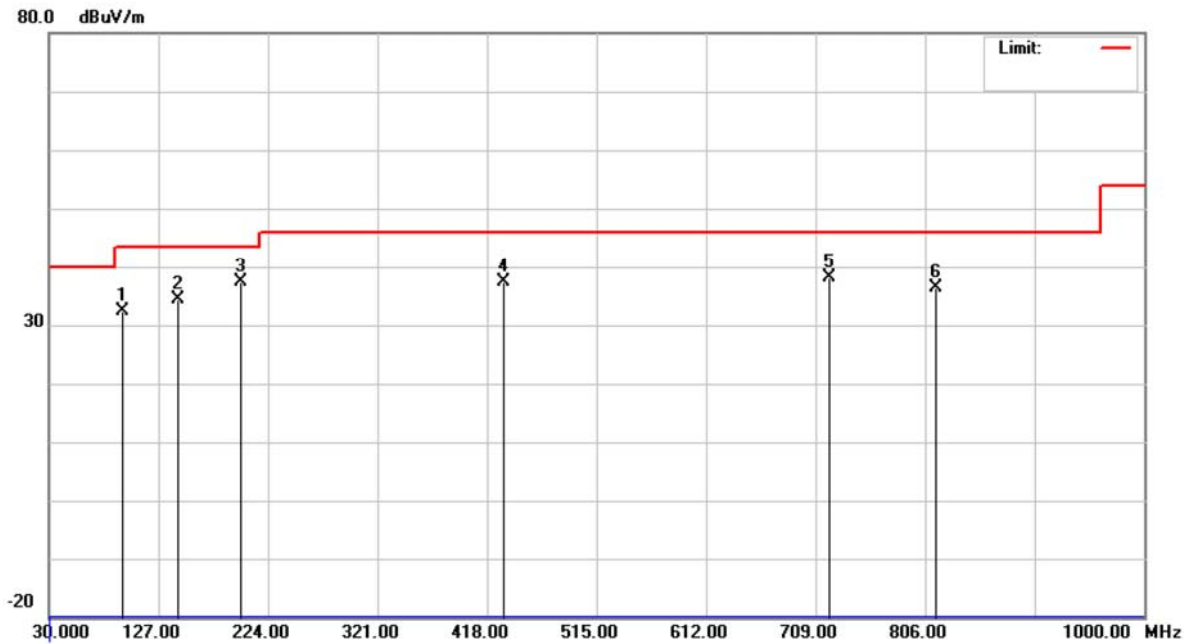

No.	Mk.	Freq. MHz	Reading Level dBuV	Correct Factor dB	Measure- ment dBuV/m	Limit dBuV/m	Over dB	Detector	Comment
1		95.4749	52.23	-19.73	32.50	43.50	-11.00	peak	
2		143.9750	48.71	-14.43	34.28	43.50	-9.22	peak	
3	*	199.7500	54.15	-16.89	37.26	43.50	-6.24	peak	
4		432.5499	47.68	-10.26	37.42	46.00	-8.58	peak	
5		721.1250	44.10	-6.00	38.10	46.00	-7.90	peak	
6		815.7000	40.88	-4.59	36.29	46.00	-9.71	peak	



5.8 TEST RESULTS- FCC PART 15.225

EUT	Bedside Terminal Hardware System	Model Name	K948
Temperature	26 °C	Relative Humidity	60%
Test Voltage	AC 120V/60Hz		
Test Mode	Transmitting		

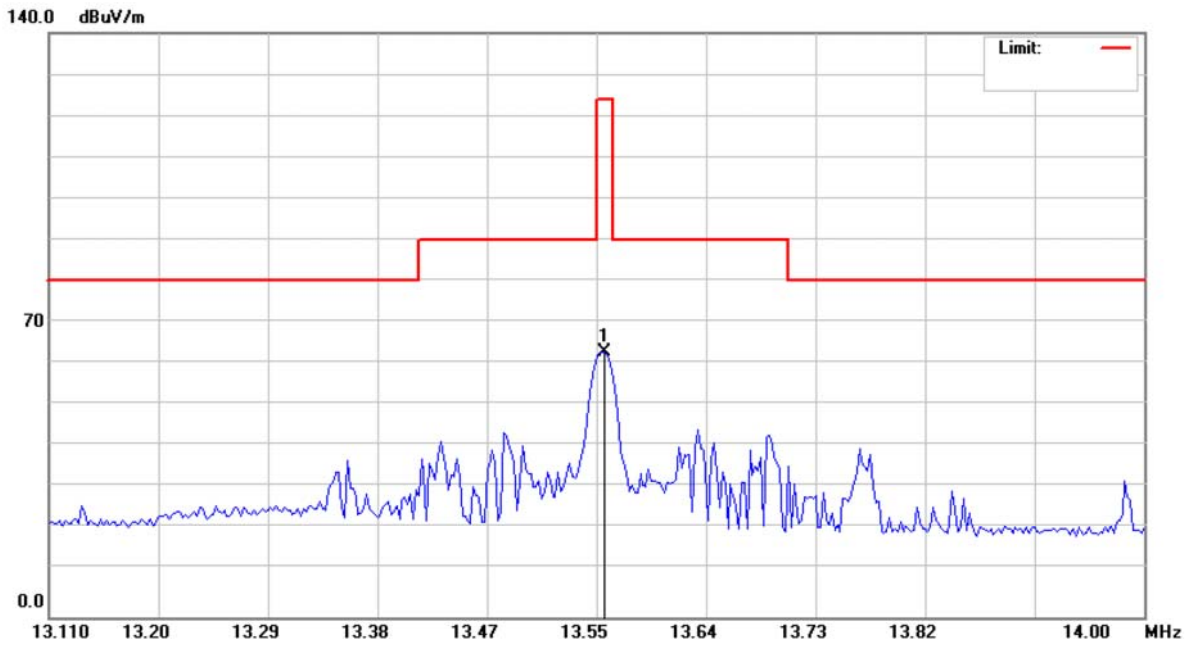

No.	Mk.	Freq.	Reading Level	Correct Factor	Measurement	Limit	Over	Detector	Comment
		MHz	dBuV	dB	dBuV/m	dBuV/m	dB		
1	*	13.5617	52.44	11.18	63.62	124.0	-60.38	peak	



EUT	Bedside Terminal Hardware System	Model Name	K948
Temperature	26 °C	Relative Humidity	60%
Test Voltage	AC 120V/60Hz		
Test Mode	Transmitting		



No.	Mk.	Freq. MHz	Reading Level dBuV	Correct Factor dB	Measure- ment dBuV/m	Limit dBuV/m	Over dB	Detector	Comment
1	*	27.1220	18.78	9.92	28.70	69.54	-40.84	peak	



6 FREQUENCY STABILITY

6.1 LIMITS

FCC Part 15.225(e)

The frequency tolerance of the carrier signal shall be maintained within +/-0.01% of the operating frequency over a temperature variation of - 20 degrees to + 50 degrees C at normal supply voltage, and for a variation in the primary supply voltage from 85% to 115% of the rated supply voltage at a temperature of 20 degrees C.
For battery operated equipment, the equipment tests shall be performed using a new battery.

6.2 MEASUREMENT INSTRUMENTS LIST

Item	Kind of Equipment	Manufacturer	Type No.	Serial No.	Calibrated until
1	Spectrum Analyzer	R&S	FSP-40	100129	Oct. 01, 2013

Remark: "N/A" denotes No Model Name, No Serial No. or No Calibration specified.

6.3 TEST PROCEDURE

- a. The equipment under test was connected to an external AC power supply and the RF output was connected to a frequency counter via feed through attenuators. The EUT was placed inside the temperature chamber.
After the temperature stabilized for approximately 20 minutes, the frequency of the output signal was recorded from the counter.
- b. At room temperature ($25\pm 5^{\circ}\text{C}$), an external variable AC power supply was connected to the EUT. The frequency of the transmitter was measured for 115%, 100% and 85% of the nominal operating input voltage.

6.4 DEVIATION FROM TEST STANDARD

No deviation

6.5 EUT OPERATING CONDITIONS

The EUT tested system was configured as the statements of 4.1.6 Unless otherwise a special operating condition is specified in the follows during the testing.



6.6 TEST RESULTS

EUT	Bedside Terminal Hardware System	Model Name	K948
Temperature	26 °C	Relative Humidity	60%
Test Voltage	AC 120V/60Hz		
Test Mode	Transmitting		

Frequency Stability Versus Environmental Temperature

	Temperature (°C)	Voltage (AC)	Frequency (MHz)	Frequency Error (kHz)	Limit (kHz)	Result
	20	120V	13.55967			
0 min	50	120V	13.55966	-0.010	+/- 1.356	PASS
	-20	120V	13.55971	0.040	+/- 1.356	PASS
2 min	50	120V	13.55965	-0.020	+/- 1.356	PASS
	-20	120V	13.55972	0.050	+/- 1.356	PASS
5 min	50	120V	13.55966	-0.010	+/- 1.356	PASS
	-20	120V	13.55972	0.050	+/- 1.356	PASS
10 min	50	120V	13.55966	-0.010	+/- 1.356	PASS
	-20	120V	13.55972	0.050	+/- 1.356	PASS

Frequency Stability Versus Input Voltage

Temperature (°C)	Voltage (AC)		Frequency (MHz)	Frequency Error (kHz)	Limit (kHz)	Result
20	V-nom	120	13.55967			
20	V-min	102	13.55966	-0.01	+/- 1.356	PASS
20	V-max	138	13.55966	-0.01	+/- 1.356	PASS