

# FCC CDMA REPORT

## FCC Certification

**Applicant Name:**  
Franklin Technology Inc.

**Address:**  
906 JEI Platz, 186, Gasan digital 1-ro, Geumcheon-gu,  
Seoul, Korea, (08502)

**Date of Issue:**

July 11, 2016

**Location:**

HCT CO., LTD.,

74, Seoicheon-ro 578beon-gil, Majang-myeon,  
Icheon-si, Gyeonggi-do, 17383, Rep. of KOREA

**Report No.:** HCT-R-1607-F013

**HCT FRN:** 0005866421

**FCC ID:** XHG-U772S

**APPLICANT:** Franklin Technology Inc.

**FCC Model(s):** U772

**EUT Type:** LTE/CDMA USB Dongle

**FCC Classification:** PCS Licensed Transmitter (PCB)

**FCC Rule Part(s):** §22, §24, §2

Mode	Tx Frequency (MHz)	Rx Frequency (MHz)	Emission Designator	ERP	
				Max. Power (W)	Max. Power (dBm)
CDMA	824.70– 848.31	869.70– 893.31	1M28F9W	0.291	24.64
CDMA EVDO_Rev.0			1M28F9W	0.217	23.37
CDMA EVDO_Rev.A			1M27F9W	0.321	25.07

Mode	Tx Frequency (MHz)	Rx Frequency (MHz)	Emission Designator	EIRP	
				Max. Power (W)	Max. Power (dBm)
PCS CDMA	1851.25– 1 908.75	1 931.25– 1 988.75	1M28F9W	0.092	19.66
PCS CDMA EVDO_Rev.0			1M28F9W	0.096	19.85
PCS CDMA EVDO_Rev.A			1M28F9W	0.094	19.74

The measurements shown in this report were made in accordance with the procedures specified in CFR47 section§2.947. I assume full responsibility for the accuracy and completeness of these measurements, and for the qualifications of all persons taking them.

HCT CO., LTD. Certifies that no party to this application has subject to a denial of Federal benefits that includes FCC benefits pursuant to section 5301 of the Anti-Drug Abuse Act of 1998,21 U.S. C.853(a)



**Report prepared by**  
: Jeong Ho Kim  
**Test engineer of RF Team**



**Approved by**  
: Kyoung Houn Seo  
**Manager of RF Team**

This report only responds to the tested sample and may not be reproduced, except in full, without written approval of the HCT Co., Ltd.

# Version

TEST REPORT NO.	DATE	DESCRIPTION
HCT-R-1607-F013	July 11, 2016	- First Approval Report

---

---

# Table of Contents

1. GENERAL INFORMATION .....	4
2. INTRODUCTION .....	5
2.1. EUT DESCRIPTION.....	5
2.2. MEASURING INSTRUMENT CALIBRATION.....	5
2.3. TEST FACILITY .....	5
3. DESCRIPTION OF TESTS .....	6
3.1 ERP/EIRP RADIATED POWER AND RADIATED SPURIOUS EMISSIONS.....	6
3.2 PEAK- TO- AVERAGE RATIO .....	7
3.3 OCCUPIED BANDWIDTH. ....	9
3.4 SPURIOUS AND HARMONIC EMISSIONS AT ANTENNA TERMINAL.....	10
3.5 FREQUENCY STABILITY / VARIATION OF AMBIENT TEMPERATURE .....	11
4. LIST OF TEST EQUIPMENT .....	12
5. MEASUREMENT UNCERTAINTY .....	13
6. SUMMARY OF TEST RESULTS .....	14
7. SAMPLE CALCULATION .....	15
8. TEST DATA .....	16
8.1 EFFECTIVE RADIATED POWER(CDMA Mode).....	16
8.2EQUIVALENT ISOTROPIC RADIATED POWER(PCS CDMA Mode).....	17
8.3RADIATED SPURIOUS EMISSIONS .....	18
8.3.1 RADIATED SPURIOUS EMISSIONS (CDMA Mode) .....	18
8.3.2 RADIATED SPURIOUS EMISSIONS(PCS Mode).....	19
8.4 PEAK-TO-AVERAGE RATIO .....	20
8.5 OCCUPIED BANDWIDTH .....	21
8.6 CONDUCTED SPURIOUS EMISSIONS .....	22
8.6.1 Band Edge .....	22
8.7 FREQUENCY STABILITY / VARIATION OF AMBIENT TEMPERATURE .....	23
8.7.1 RADIATED SPURIOUS EMISSIONS (CDMA Mode) .....	23
8.7.2 RADIATED SPURIOUS EMISSIONS (PCS Mode).....	24
9. TEST PLOTS.....	25

# MEASUREMENT REPORT

## 1. GENERAL INFORMATION

**Applicant Name:** Franklin Technology Inc.

**Address:** 906 JEI Platz, 186, Gasan digital 1-ro, Geumcheon-gu, Seoul, Korea, (08502)

**FCC ID:** XHG-U772S

**Application Type:** Certification

**FCC Classification:** PCS Licensed Transmitter (PCB)

**FCC Rule Part(s):** §22, §24, §2

**EUT Type:** LTE/CDMA USB Dongle

**FCCModel(s):** U772

**Tx Frequency:** 824.70 — 848.31 MHz (CDMA)  
1 851.25 – 1 908.75 MHz (PCS CDMA)

**Rx Frequency:** 869.70 — 893.31 MHz (CDMA)  
1 931.25 – 1 988.75 MHz (PCS CDMA)

**Max. RF Output Power:** 0.291 W CDMA(24.64dBm)/ 0.217 W CDMA EVDO\_Rev.0 (23.37dBm)  
/ 0.321 W CDMA EVDO\_Rev.A(25.07dBm)

0.092 W PCS CDMA(19.66dBm) / 0.096 W PCS CDMA EVDO\_Rev.0 (19.85dBm)  
/ 0.094 W PCS CDMA EVDO\_Rev.A(19.74dBm)

**Emission Designator(s):** 1M28F9W (CDMA)/1M28F9W (CDMA EVDO\_Rev.0)  
/1M27F9W (CDMA EVDO\_Rev.A)

1M28F9W (PCS CDMA)/ 1M28F9W (PCS CDMA EVDO\_Rev.0)  
/ 1M28F9W (PCS CDMA EVDO\_Rev.A)

**Date(s) of Tests:** June 21, 2016 ~ July 08, 2016

**Antenna Specification**

Manufacturer: HUTEC Co.,ltd  
Antenna type: Internal Antenna  
Peak Gain: CDMA850 :-0.431dBi  
PCS : 2.977dBi

## **2. INTRODUCTION**

### **2.1. EUT DESCRIPTION**

The Franklin Technology Inc. U772 LTE/CDMA USB Dongle consists of Cellular CDMA, PCS CDMA, EVDO\_Rev.0 and EVDO\_Rev.A.

### **2.2. MEASURING INSTRUMENT CALIBRATION**

The measuring equipment, which was utilized in performing the tests documented herein, has been calibrated in accordance with the manufacturer's recommendations for utilizing calibration equipment, which is traceable to recognized national standards.

### **2.3. TEST FACILITY**

The Fully-anechoic chamber and conducted measurement facility used to collect the radiated data are located at the **74, Seoicheon-ro 578beon-gil, Majang-myeon, Icheon-si, Gyeonggi-do, 17383, Rep. of KOREA.**

## **3. DESCRIPTION OF TESTS**

### **3.1 ERP/EIRP RADIATED POWER AND RADIATED SPURIOUS EMISSIONS**

Note: ERP(Effective Radiated Power), EIRP(Effective Isotropic Radiated Power)

Test Procedure

Radiated emission measurements are performed in the Fully-anechoic chamber. The equipment under test is placed on a non-conductive table 3-meters away from the receive antenna in accordance with ANSI/TIA-603-D-2010 Clause 2.2.17. The turntable is rotated through 360 degrees, and the receiving antenna scans in order to determine the level of the maximized emission. The level and position of the maximized emission is recorded with the spectrum analyzer using RMS detector.

A half wave dipole is then substituted in place of the EUT. For emissions above 1GHz, a horn antenna is substituted in place of the EUT. The substitute antenna is driven by a signal generator and the previously recorded signal was duplicated.

The power is calculated by the following formula;

$$P_{d(dBm)} = P_{g(dBm)} - \text{cable loss}_{(dB)} + \text{antenna gain}_{(dB)}$$

Where:  $P_d$  is the dipole equivalent power and  $P_g$  is the generator output power into the substitution antenna.

The maximum EIRP is calculated by adding the forward power to the calibrated source plus its appropriate gain value. These steps are repeated with the receiving antenna in both vertical and horizontal polarization. the difference between the gain of the horn and an isotropic antenna are taken into consideration

#### **Radiated spurious emissions**

1. Frequency Range : 30 MHz ~ 10<sup>th</sup> Harmonics of highest channel fundamental frequency.
2. The EUT was setup to maximum output power. The 100 kHz RBW was used to scan from 30 MHz to 1 GHz. Also, the 1 MHz RBW was used to scan from 1 GHz to 10 GHz(Cellular CDMA) or 20 GHz(PCS CDMA). The high, low and a middle channel were tested for out of band measurements.

Note : This device was tested under all R.C.s and S.O.s and worst case is reported with 'All Up' power control bits.

### 3.2 PEAK- TO- AVERAGE RATIO

#### Test Procedure

Peak to Average Power Ratio is tested in accordance with KDB971168 D01 Power Meas License Digital Systems v02r02, October 17, 2014, Section 5.7.

#### - Section 5.7.1 CCDF Procedure

- a) Set resolution/measurement bandwidth  $\geq$  signal's occupied bandwidth;
- b) Set the number of counts to a value that stabilizes the measured CCDF curve;
- c) Set the measurement interval as follows:
  - 1) for continuous transmissions, set to 1 ms,
  - 2) for burst transmissions, employ an external trigger that is synchronized with the EUT burst timing sequence, or use the internal burst trigger with a trigger level that allows the burst to stabilize and set the measurement interval to a time that is less than or equal to the burst duration.
- d) Record the maximum PAPR level associated with a probability of 0.1%.

#### - Section 5.7.2 Alternate Procedure

Use one of the procedures presented in 5.1 to measure the total peak power and record as  $P_{Pk}$ . Use one of the applicable procedures presented 5.2 to measure the total average power and record as  $P_{Avg}$ . Determine the P.A.R. from:  $P.A.R_{(dB)} = P_{Pk(dBm)} - P_{Avg(dBm)}$  ( $P_{Avg}$  = Average Power + Duty cycle Factor)

#### 5.1.1 Peak power measurements with a spectrum/signal analyzer or EMI receiver

The following procedure can be used to determine the total peak output power.

- a) Set the RBW  $\geq$  OBW.
- b) Set VBW  $\geq 3 \times$  RBW.
- c) Set span  $\geq 2 \times$  RBW
- d) Sweep time = auto couple.
- e) Detector = peak.
- f) Ensure that the number of measurement points  $\geq$  span/RBW.
- g) Trace mode = max hold.
- h) Allow trace to fully stabilize.
- i) Use the peak marker function to determine the peak amplitude level.

### **5.2.2 Procedures for use with a spectrum/signal analyzer when EUT cannot be configured to transmit continuously and sweep triggering/signal gating cannot be properly implemented**

If the EUT cannot be configured to transmit continuously (burst duty cycle < 98%), then one of the following procedures can be used. The selection of the applicable procedure will depend on the characteristics of the measured burst duty cycle.

Measure the burst duty cycle with a spectrum/signal analyzer or EMC receiver can be used in zero-span mode if the response time and spacing between bins on the sweep are sufficient to permit accurate measurement of the burst on/off time of the transmitted signal.

#### **5.2.2.2 Constant burst duty cycle**

If the measured burst duty cycle is constant (i.e., duty cycle variations are less than  $\pm 2$  percent), then:

- a) Set span to at least 1.5 times the OBW.
- b) Set RBW = 1-5% of the OBW, not to exceed 1 MHz.
- c) Set VBW  $\geq 3 \times$  RBW.
- d) Number of points in sweep  $\geq 2 \times$  span / RBW. (This gives bin-to-bin spacing  $\leq$  RBW/2, so that narrowband signals are not lost between frequency bins.)
- e) Sweep time = auto.
- f) Detector = RMS (power averaging).
- g) Set sweep trigger to "free run".
- h) Trace average at least 100 traces in power averaging (i.e., RMS) mode.
- i) Compute power by integrating the spectrum across the OBW of the signal using the instrument's band power measurement function with band limits set equal to the OBW band edges. If the instrument does not have a band power function, sum the spectrum levels (in power units) at intervals equal to the RBW extending across the entire OBW of the spectrum.
- j) Add  $10 \log (1/x)$ , where  $x$  is the duty cycle, to the measured power in order to compute the average power during the actual transmission times (because the measurement represents an average over both the on and off times of the transmission).

For example, add  $10 \log (1/0.25) = 6$  dB if the duty cycle is a constant 25%.



### 3.3 OCCUPIED BANDWIDTH.

Test set-up

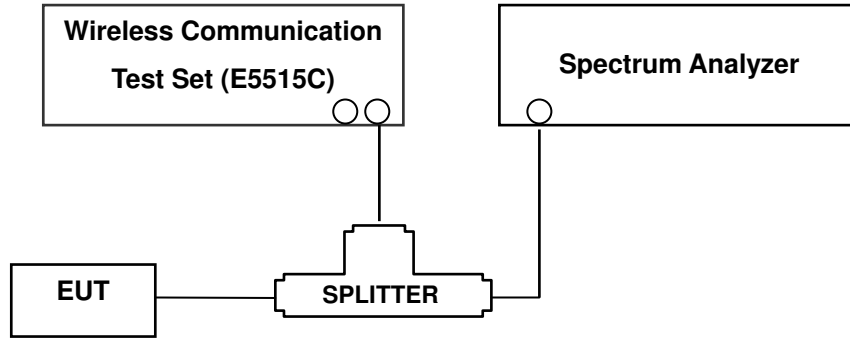

(Configuration of conducted Emission measurement)

The width of a frequency band such that, below the lower and above the upper frequency limits, the mean powers emitted are each equal to a specified percentage 0.5 % of the total mean power of a given emission.

#### Test Procedure

OBW is tested in accordance with KDB971168 D01 Power Meas License Digital Systems v02r02, October 17, 2014, Section 4.2.

The EUT makes a call to the communication simulator. The power was measured with R&S Spectrum Analyzer. All measurements were done at 3 channels(low, middle and high operational range.)

The conducted occupied bandwidth used the power splitter via EUT RF power connector between simulation base station and spectrum analyzer.

The communication simulator station system controlled a EUT to export maximum output power under transmission mode and specific channel frequency. Use OBW measurement function of Spectrum analyzer to measure 99 % occupied bandwidth

Note : This device was tested under all R.C.s and S.O.s and worst case is reported with 'All Up' power control bits.

### 3.4 SPURIOUS AND HARMONIC EMISSIONS AT ANTENNA TERMINAL.

#### Test Procedure

The level of the carrier and the various conducted spurious and harmonic frequencies is measured by means of a calibrated spectrum analyzer.

On any frequency outside a licensee's frequency block, the power of any emission shall be attenuated below the transmitter power (P) by at least  $43 + 10 \log(P)$  dB. The RBW settings used in the testing are greater than 1 % of the occupied bw. The 1 MHz RBW was used to scan from 10 MHz to 10 GHz. (GSM1900 Mode: 10 MHz to 20 GHz). A display line was placed at - 13 dBm to show compliance. The high, lowest and a middle channel were tested for out of band measurements.

Measurements of all out of band are made on RBW = 1MHz and VBW  $\geq$  3 MHz in the worst case despite RBW = 100 kHz and VBW  $\geq$  300 kHz upon 1 GHz.

- RBW = 1 MHz
- VBW  $\geq$  3 MHz
- Detector = Peak
- Trace Mode = max hold
- Sweep time = auto
- Number of points in sweep  $\geq$  2 \* Span / RBW

- Band Edge Requirement : According to FCC 22.917, 24.238(a) specified that power of any emission outside of The authorized operating frequency ranges must be attenuated below the transmitting power (P) by a factor of at least  $43 + 10 \log(P)$  dB. In the 1 MHz bands immediately outside and adjacent to the frequency block a resolution bandwidth of at least one percent of the emission bandwidth of the fundamental emission of the transmitter may be employed.

The EUT makes a call to the communication simulator. The power was measured with R&S Spectrum Analyzer. All measurements were done at 2 channels(low and high operational frequency range.)

The band edge measurement used the power splitter via EUT RF power connector between simulation base station and spectrum analyzer.

Note : This device was tested under all R.C.s and S.O.s and worst case is reported with 'All Up' power control bits.

**NOTES:** The analyzer plot offsets were determined by below conditions.

- For CDMA, total offset 26.6 dB = 20 dB attenuator + 6 dB Splitter + 0.6 dB RF cables,
- For PCS, total offset 27.2 dB = 20 dB attenuator + 6 dB Splitter + 1.2 dB RF cables,

### 3.5 FREQUENCY STABILITY / VARIATION OF AMBIENT TEMPERATURE

#### Test Set-up

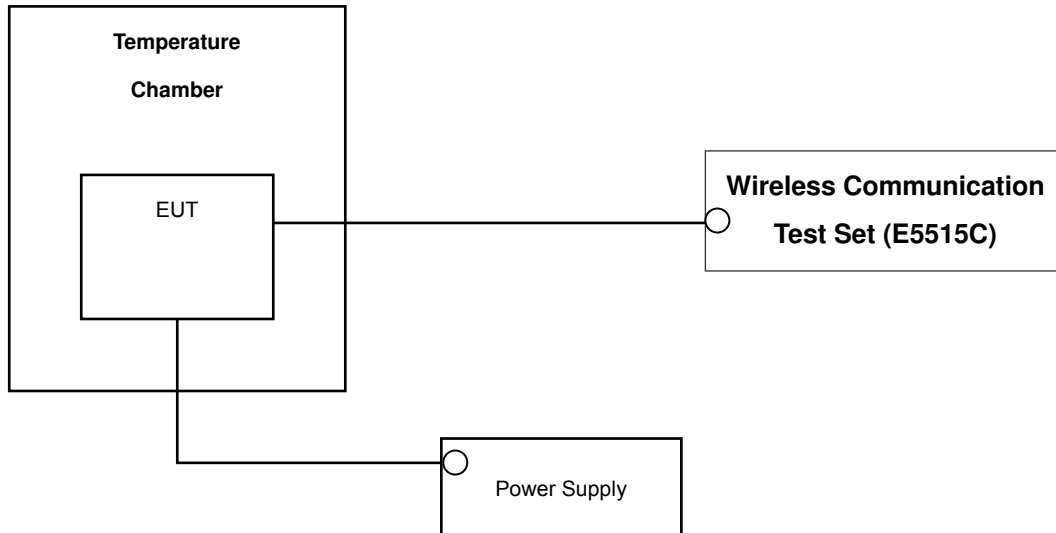

\* Nominal Operating Voltage

#### Test Procedure

Frequency stability is tested in accordance with ANSI/TIA-603-D-2010 section 2.2.2.

The frequency stability of the transmitter is measured by:

- a.) **Temperature:** The temperature is varied from - 30 °C to + 50 °C using an environmental chamber.
- b.) **Primary Supply Voltage:** The primary supply voltage is varied from battery end point to 100 % of the voltage normally at the input to the device or at the power supply terminals if cables are not normally supplied.

Specification — the frequency stability shall be sufficient to ensure that the fundamental emission stays within the authorized frequency block(PCS CDMA). The frequency stability of the transmitter shall be maintained within  $\pm 0.00025$  % ( $\pm 2.5$  ppm) of the center frequency(Cellular CDMA).

#### Time Period and Procedure:

The carrier frequency of the transmitter is measured at room temperature (20°C to provide a reference).

1. The equipment is turned on in a "standby" condition for one minute before applying power to the transmitter. Measurement of the carrier frequency of the transmitter is made within one minute after applying power to the transmitter.
2. Frequency measurements are made at 10°C intervals ranging from -30°C to +50°C. A period of at least one half-hour is provided to allow stabilization of the equipment at each temperature level.

**NOTE: The EUT is tested down to the battery endpoint.**

Note : This device was tested under all R.C.s and S.O.s and worst case is reported with 'All Up' power control bits.

## 4. LIST OF TEST EQUIPMENT

Manufacture	Model/ Equipment	Serial Number	Calibration Interval	Calibration Due
CERNEX	CBLU1183540B-01/ POWER AMP	25540	Annual	05/13/2017
Wainwright	WHKX 10-900-1000-15000-40SS/H.P.F	5	Annual	08/11/2016
Wainwright	WHKX10-2700-3000-18000-40SS/H.P.F	3	Annual	08/05/2016
Hewlett Packard	11667B / Power Splitter	10545	Annual	02/15/2017
Hewlett Packard	11667B / Power Splitter	11275	Annual	04/29/2017
ITECH	IT6720/ Power Supply	0100215626700119	Annual	11/02/2016
Schwarzbeck	UHAP/ Dipole Antenna	557	Biennial	03/23/2017
Schwarzbeck	UHAP/ Dipole Antenna	558	Biennial	03/23/2017
EXP	EX-TH400/ Chamber	None	Annual	05/31/2017
Schwarzbeck	BBHA 9120D/ Horn Antenna	9210D-1298	Biennial	10/16/2016
Schwarzbeck	BBHA 9120D/ Horn Antenna	9210D-1299	Biennial	10/16/2016
Schwarzbeck	BBHA 9170/ Horn Antenna(15~40GHz)	BBHA9170342	Biennial	04/30/2017
Schwarzbeck	BBHA 9170/ Horn Antenna(15~35GHz)	BBHA9170124	Biennial	04/30/2017
Agilent	N9020A/Signal Analyzer	MY52090906	Annual	05/13/2017
Hewlett Packard	8493C/ATTENUATOR	17280	Annual	06/22/2017
REOHDE&SCHWARZ	FSV40-N/Signal Analyzer	101068-SZ	Annual	09/23/2016
Agilent	8960 (E5515C)/ Base Station	MY48360800	Annual	10/30/2016
Anritsu Corp.	MT8820C/Wideband Radio Communication Tester	6200863156	Annual	02/26/2017
Anritsu Corp.	MT8820C/Wideband Radio Communication Tester	6201026545	Annual	02/16/2017
Schwarzbeck	VULB9160/ Bilog Antenna	3150	Biennial	11/17/2016
Schwarzbeck	VULB9160/ Bilog Antenna	3368	Biennial	10/10/2016

## 5. MEASUREMENT UNCERTAINTY

The measurement uncertainties shown below were calculated in accordance with the requirements of ANSI C63.4:2014.

All measurement uncertainty values are shown with a coverage factor of  $k = 2$  to indicate a 95 % level of confidence. The measurement data shown herein meets or exceeds the  $U_{\text{CISPR}}$  measurement uncertainty values specified in CISPR 16-4-2 and, thus, can be compared directly to specified limits to determine compliance.

Parameter	Expanded Uncertainty ( $\pm$ dB)
Conducted Disturbance (150 kHz ~ 30 MHz)	1.82
Radiated Disturbance (9 kHz ~ 30 MHz)	3.40
Radiated Disturbance (30 MHz ~ 1 GHz)	4.80
Radiated Disturbance (1 GHz ~ 18 GHz)	6.07

## 6. SUMMARY OF TEST RESULTS

FCC Part Section(s)	Test Description	Test Limit	Test Condition	Test Result
2.1049	Occupied Bandwidth	N/A	CONDUCTED	PASS
2.1051, 22.917(a), 24.238(a)	Band Edge / Spurious and Harmonic Emissions at Antenna Terminal.	< 43 + 10log <sub>10</sub> (P[Watts]) at Band Edge and for all out-of-band emissions		PASS
* 2.1046	Conducted Output Power	-		PASS
24.232(d)	Peak- to- Average Ratio	< 13 dB		PASS
2.1055, 22.355	Frequency stability / variation of ambient temperature	< 2.5 ppm (Part22)		PASS
24.235		Emission must remain in band (Part24)		PASS
22.913(a)(2)	Effective Radiated Power	< 7 Watts max. ERP	RADIATED	PASS
24.232(c)	Equivalent Isotropic Radiated Power	< 2 Watts max. EIRP		PASS
2.1053, 22.917(a), 24.238(a)	Radiated Spurious and Harmonic Emissions	< 43 + 10log <sub>10</sub> (P[Watts]) for all out-ofband emissions		PASS

\*: See SAR Report

## 7. SAMPLE CALCULATION

### A. ERP Sample Calculation

Mode	Ch./ Freq.		Measured Level(dBm)	Substitute LEVEL(dBm)	Ant. Gain (dBd)	C.L	Pol.	Limit W	ERP	
	channel	Freq.(MHz)							W	dBm
CDMA	384	836.52	-23.45	38.92	-10.53	0.88	V	<7.00	0.564	27.51

**ERP = Substitute LEVEL(dBm) + Ant. Gain – CL(Cable Loss)**

- 1) The EUT mounted on a non-conductive turntable is 2.5 meter above test site ground level.
- 2) During the test , the turn table is rotated until the maximum signal is found.
- 3) Record the field strength meter’s level.
- 4) Replace the EUT with dipole/Horn antenna that is connected to a calibrated signal generator.
- 5) Increase the signal generator output till the field strength meter’s level is equal to the item (3).
- 6) The signal generator output level with Ant. Gain and cable loss are the rating of effective radiated power (**ERP**).

## B. Emission Designator

### CDMA Emission Designator

**Emission Designator = 1M27F9W**

CDMA BW = 1.27 MHz

(Measured at the 99% power bandwidth)

F = Frequency Modulation

9 = Composite Digital Info

W = Combination (Audio/Data)

### EVDO Emission Designator

**Emission Designator = 1M27F9W**

CDMA BW = 1.27 MHz

(Measured at the 99% power bandwidth)

F = Frequency Modulation

9 = Composite Digital Info

W = Combination (Audio/Data)

## 8. TEST DATA

### 8.1 EFFECTIVE RADIATED POWER(CDMA Mode)

Mode	Ch./ Freq.		Measured Level (dBm)	Substitute LEVEL (dBm)	Ant. Gain (dBd)	C.L	Pol.	Limit W	ERP	
	channel	Freq.(MHz)							W	dBm
CDMA	1013	824.7	-25.75	36.38	-10.22	1.79	H	< 7.00	0.274	24.37
	384	836.5	-26.08	36.64	-10.20	1.80	H		0.291	24.64
	777	848.3	-27.55	35.31	-10.17	1.81	H		0.215	23.33
EVDO Rev.0	1013	824.7	-27.79	34.34	-10.22	1.79	H		0.171	22.33
	384	836.5	-27.35	35.37	-10.20	1.80	H		0.217	23.37
	777	848.3	-28.05	34.81	-10.17	1.81	H		0.192	22.83
EVDO Rev.A	1013	824.7	-27.78	34.35	-10.22	1.79	H		0.172	22.34
	384	836.5	-27.09	35.63	-10.20	1.80	H		0.231	23.63
	777	848.3	-25.81	37.05	-10.17	1.81	H		0.321	25.07

**NOTES:**

Effective Radiated Power Output Measurements by Substitution Method

according to ANSI/TIA/EIA-603-D-2010 June 24, 2010:

The EUT was placed on a non-conductive styrofoam resin table 3-meters from the receive antenna. The receive antenna height and turntable rotation was adjusted for the highest reading on the receive spectrum analyzer. For CDMA signals, RBW = 1-5% of the OBW, not to exceed 1MHz, VBW ≥ 3 x RBW, Detector = RMS. A half-wave dipole was substituted in place of the EUT. This dipole antenna was driven by a signal generator and the level of the signal generator was adjusted to obtain the same receive spectrum analyzer reading. The conducted power at the terminals of the dipole is measured. The ERP is recorded.

This device was tested under all configurations and the highest power is reported. Also, we have done x, y, z planes in EUT and horizontal and vertical polarization in detecting antenna. The worst case of the EUT is in z plane in CDMA mode, CDMA EVDO\_Rev.0 mode and CDMA EVDO\_Rev.A mode. Also worst case of detecting Antenna is in horizontal polarization in CDMA mode, CDMA EVDO\_Rev.0 mode and CDMA EVDO\_Rev.A mode.



**8.2EQUIVALENT ISOTROPIC RADIATED POWER(PCS CDMA Mode)**

Mode	Ch./ Freq.		Measured Level (dBm)	Substitute LEVEL (dBm)	Ant. Gain (dBi)	C.L	Pol.	Limit W	EIRP	
	channel	Freq.(MHz)							W	dBm
PCS	25	1851.3	-21.82	12.15	9.82	2.42	V	< 2.00	0.090	19.55
	600	1880.0	-21.75	12.08	9.91	2.45	V		0.090	19.54
	1175	1908.8	-21.58	12.12	10.00	2.46	V		0.092	19.66
EVDO Rev.0	25	1851.3	-21.52	12.45	9.82	2.42	V		0.096	19.85
	600	1880.0	-21.59	12.24	9.91	2.45	V		0.093	19.70
	1175	1908.8	-21.45	12.25	10.00	2.46	V		0.095	19.79
EVDO Rev.A	25	1851.3	-21.63	12.34	9.82	2.42	V		0.094	19.74
	600	1880.0	-21.90	11.93	9.91	2.45	V		0.087	19.39
	1175	1908.8	-21.65	12.05	10.00	2.46	V		0.091	19.59

**NOTES:**

Equivalent Isotropic Radiated Power Measurements by Substitution Method according to ANSI/TIA/EIA-603-D-2010 June 24, 2010:

The EUT was placed on a non-conductive styrofoam resin table 3-meters from the receive antenna. The receive antenna height and turntable rotation was adjusted for the highest reading on the receive spectrum analyzer. For CDMA signals, RBW = 1-5% of the OBW, not to exceed 1MHz, VBW ≥ 3 x RBW, Detector = RMS. A half-wave dipole was substituted in place of the EUT. This dipole antenna was driven by a signal generator and the level of the signal generator was adjusted to obtain the same receive spectrum analyzer reading. The conducted power at the terminals of the dipole is measured. The EIRP is recorded.

This device was tested under all configurations and the highest power is reported. Also, we have done x, y, z planes in EUT and horizontal and vertical polarization in detecting antenna. The worst case of the EUT is in y plane in PCS mode, PCSEVDO\_Rev.0 mode and PCS EVDO\_Rev.A mode. Also worst case of detecting Antenna is in vertical polarization in PCS mode, PCSEVDO\_Rev.0 mode and PCS EVDO\_Rev.A mode.

## 8.3 RADIATED SPURIOUS EMISSIONS

### 8.3.1 RADIATED SPURIOUS EMISSIONS (CDMA Mode)

- MEASURED OUTPUT POWER: 25.07 dBm = 0.321 W
- MODULATION SIGNAL: CDMAEVDO Rev.A
- DISTANCE: 3 meters
- LIMIT:  $43 + 10 \log_{10}(W) =$  38.07dBc

Ch.	Freq.(MHz)	Measured Level [dBm]	Ant. Gain (dBd)	Substitute Level [dBm]	C.L	Pol.	ERP (dBm)	dBc
1013 (824.70)	1,649.40	-50.28	9.16	-61.99	2.32	V	-55.15	80.22
	2,474.10	-54.70	10.92	-62.09	2.75	H	-53.91	78.98
	3,298.80	-55.02	11.94	-60.42	3.12	H	-51.60	76.67
384 (836.52)	1,673.00	-51.32	9.25	0.00	2.34	H	-56.08	81.15
	2,509.50	-54.17	10.96	-61.99	2.73	H	-52.71	77.78
	3,346.00	-55.79	12.05	-62.09	3.18	V	-53.24	78.31
777 (848.31)	1,696.60	-46.94	9.32	0.96	2.35	V	-51.60	76.67
	2,544.90	-51.41	10.98	-62.99	2.76	V	-50.50	75.57
	3,393.20	-55.15	12.13	-60.94	3.20	V	-51.89	76.96

- NOTES:**
1. Radiated Spurious Emission Measurements at 3 meters by Substitution Method according to ANSI/TIA/EIA-603-D-2010 Jun 24, 2010:
  2. We are performed all frequency to 10<sup>th</sup> harmonics from 30 MHz. Measurements above show only up to 3 maximum emissions noted, or would be lesser if no specific emissions from the EUT are recorded (ie: margin > 20 dB from the applicable limit) and considered that's already beyond the background noise floor.
  3. We have done x, y, z planes in EUT and horizontal and vertical polarization in detecting antenna.

### 8.3.2 RADIATED SPURIOUS EMISSIONS(PCS Mode)

- MEASURED OUTPUT POWER: 19.85 dBm = 0.096 W
- MODULATION SIGNAL: PCSEVDO Rev.0
- DISTANCE: 3 meters
- LIMIT:  $43 + 10 \log_{10}(W) =$  32.85dBc

Ch.	Freq.(MHz)	<u>Measured Level</u> [dBm]	Ant. Gain (dBi)	<u>Substitute</u> <u>Level</u> [dBm]	C.L	Pol.	EIRP (dBm)	dBc
25 (1851.25)	3,702.60	-54.27	12.52	-57.47	3.41	H	-48.36	68.21
	5,553.90	-55.83	13.29	-54.14	4.81	V	-45.66	65.51
	7,405.20	-50.16	11.72	-41.13	5.58	H	-34.99	54.84
600 (1880.00)	3,760.00	-54.67	12.56	0.00	3.50	V	-48.79	68.64
	5,640.00	-56.19	13.29	-57.47	4.77	H	-46.09	65.94
	7,520.00	-51.12	11.70	-54.14	5.62	V	-36.23	56.08
1175 (1908.75)	3,817.60	-54.13	12.60	17.67	3.58	V	-47.88	67.73
	5,726.40	-53.94	13.31	-57.85	4.84	V	-43.46	63.31
	7,635.20	-49.43	11.62	-54.61	5.63	V	-35.19	55.04

- NOTES:**
1. Radiated Spurious Emission Measurements at 3 meters by Substitution Method according to ANSI/TIA/EIA-603-D-2010 Jun 24, 2010:
  2. We are performed all frequency to 10<sup>th</sup> harmonics from 30 MHz. Measurements above show only up to 3 maximum emissions noted, or would be lesser if no specific emissions from the EUT are recorded (ie: margin > 20 dB from the applicable limit) and considered that's already beyond the background noise floor.
  3. We have done x, y, z planes in EUT and horizontal and vertical polarization in detecting antenna.

### 8.4 PEAK-TO-AVERAGE RATIO

Band	Ch.	Measured P <sub>Pk</sub> (dBm)	Measured P <sub>Avg</sub> (dBm)	P <sub>Avg</sub> (Duty Cycle)			P.A.R. = P <sub>Pk</sub> - P <sub>Avg</sub> (dB)	Limit (dB)	Pass / Fail
				Tx <sub>Total</sub> (ms)	Tx <sub>On</sub> (ms)	Factor (dB)			
PCS	600	CCDF Procedure					4.34	13	Pass
PCS_Rev.0							5.34		
PCS_Rev.A							5.33		

- Plots of the EUT's Peak- to- Average Ratio are shown Page 35 ~ 36

**NOTES:**

Peak to Average Power Ratio was tested in accordance with KDB971168 D01 Power Meas License Digital Systems v02r02, October 17, 2014, Section 5.7

### 8.5 OCCUPIED BANDWIDTH

Band	Channel	Frequency(MHz)	Data (MHz)
CDMA	1013	824.70	1.2783
	384	836.52	1.2736
	777	848.31	1.2702
CDMA EVDO_Rev.0	1013	824.70	1.2750
	384	836.52	1.2719
	777	848.31	1.2770
CDMA EVDO_Rev.A	1013	824.70	1.2740
	384	836.52	1.2723
	777	848.31	1.2745
PCS	25	1851.25	1.2745
	600	1880.00	1.2767
	1175	1908.75	1.2760
PCS EVDO_Rev.0	25	1851.25	1.2743
	600	1880.00	1.2737
	1175	1908.75	1.2776
PCS EVDO_Rev.A	25	1851.25	1.2723
	600	1880.00	1.2761
	1175	1908.75	1.2691

- Plots of the EUT's Occupied Bandwidth are shown Page 26 ~ 34.

## 8.6 CONDUCTED SPURIOUS EMISSIONS

### ■FACTORS FOR FREQUENCY

Frequency Range (GHz)	Factor [dB]
0.03 – 1	27.145
1 – 5	26.960
5 – 10	27.542
10 – 15	28.439
15 – 20	29.144
Above 20	30.148

### NOTES:

Factor(dB) = Cable Loss + Attenuator +Power Splitter

Band	Channel	Frequency of Maximum Harmonic (GHz)	Factor (dB)	Measurement Maximum Data (dBm)	Result (dBm)	Limit (dBm)
CDMA	1013	2.4746	26.960	-75.210	-48.250	-13.00
	384	2.5105	26.960	-75.140	-48.180	
	777	2.5459	26.960	-74.496	-47.536	
CDMA EVDO_Rev.0	1013	2.4756	26.960	-73.161	-46.201	
	384	2.5095	26.960	-74.297	-47.337	
	777	2.5464	26.960	-71.970	-45.010	
CDMA EVDO_Rev.A	1013	2.4736	26.960	-74.200	-47.240	
	384	2.5105	26.960	-73.400	-46.440	
	777	2.5449	26.960	-72.840	-45.880	
PCS	25	5.5534	27.542	-71.490	-43.948	
	600	5.6411	27.542	-72.400	-44.858	
	1175	5.7259	27.542	-73.870	-46.328	
PCS EVDO_Rev.0	25	5.5544	27.542	-71.670	-44.128	
	600	5.6401	27.542	-73.230	-45.688	
	1175	5.7274	27.542	-74.320	-46.778	
PCS EVDO_Rev.A	25	5.5554	27.542	-71.780	-44.238	
	600	5.6401	27.542	-73.180	-45.638	
	1175	5.7279	27.542	-74.320	-46.778	

### NOTES:

1. Result (dBm) = Measurement Maximum Data (dBm) + Factor (dB)

- Plots of the EUT's Conducted Spurious Emissions are shown Page 48 ~ 61.

### 8.6.1 Band Edge

- Plots of the EUT's Band Edge are shown Page 36 ~ 48.

## 8.7 FREQUENCY STABILITY / VARIATION OF AMBIENT TEMPERATURE

### 8.7.1 RADIATED SPURIOUS EMISSIONS (CDMA Mode)

- ▣ OPERATING FREQUENCY: 836,520,000 Hz
- ▣ CHANNEL: 384
- ▣ REFERENCE VOLTAGE: 5.00 VDC
- ▣ DEVIATION LIMIT: ± 0.000 25 % or 2.5 ppm

Voltage (%)	Power (VDC)	Temp. (°C)	Frequency (Hz)	Frequency Error (Hz)	Deviation (%)	ppm
100%	5.00	+20(Ref)	836 519 992	0.00	0.000 000	0.000
100%		-30	836 519 983	-8.74	-0.000 001	-0.010
100%		-20	836 519 983	-9.01	-0.000 001	-0.011
100%		-10	836 519 982	-10.32	-0.000 001	-0.012
100%		0	836 519 984	-8.06	-0.000 001	-0.010
100%		+10	836 519 982	-10.62	-0.000 001	-0.013
100%		+30	836 519 981	-11.68	-0.000 001	-0.014
100%		+40	836 519 982	-10.22	-0.000 001	-0.012
100%		+50	836 519 981	-11.17	-0.000 001	-0.013
Batt. Endpoint	4.75	+20	836 519 983	-9.51	-0.000 001	-0.011

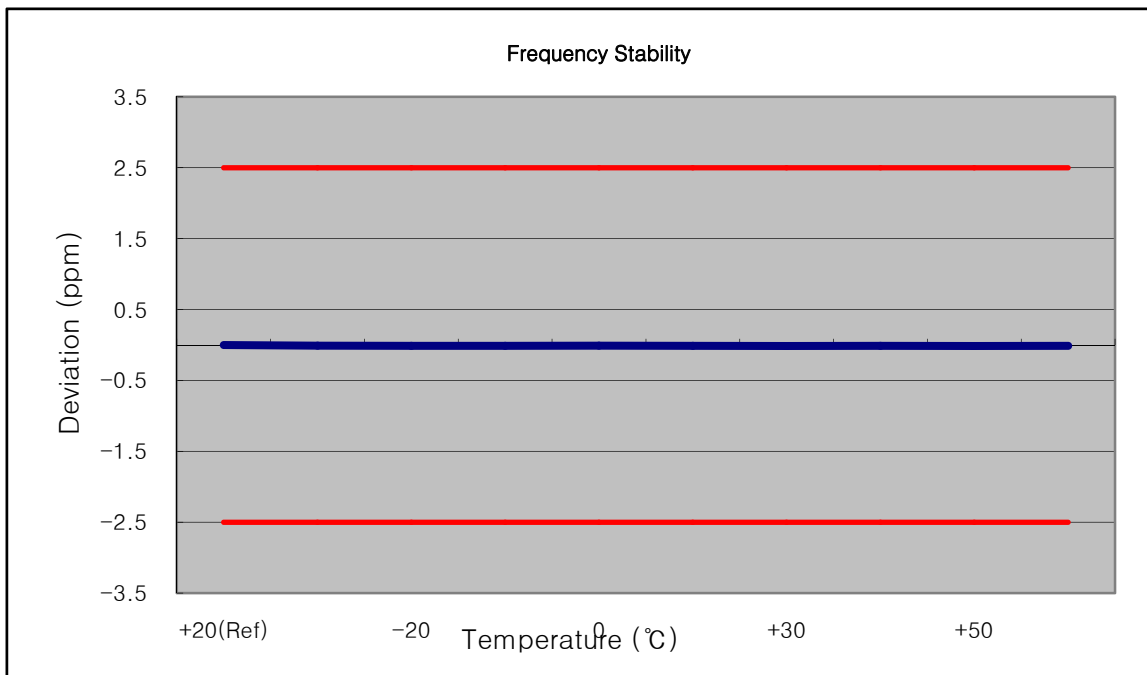

**8.7.2 RADIATED SPURIOUS EMISSIONS (PCS Mode)**

- ▣ OPERATING FREQUENCY: 1880,000,000 Hz
- ▣ CHANNEL: 600
- ▣ REFERENCE VOLTAGE: 5.00 VDC
- ▣ DEVIATION LIMIT: Emission must remain in band

Voltage (%)	Power (VDC)	Temp. (°C)	Frequency (Hz)	Frequency Error (Hz)	Deviation (%)	ppm
100%	5.00	+20(Ref)	1880 000 014	0.00	0.000 000	0.000
100%		-30	1880 000 021	7.44	0.000 000	0.004
100%		-20	1880 000 024	10.64	0.000 001	0.006
100%		-10	1880 000 025	11.48	0.000 001	0.006
100%		0	1880 000 022	8.28	0.000 000	0.004
100%		+10	1880 000 024	10.64	0.000 001	0.006
100%		+30	1880 000 020	6.10	0.000 000	0.003
100%		+40	1880 000 025	11.61	0.000 001	0.006
100%		+50	1880 000 025	11.17	0.000 001	0.006
Batt. Endpoint		4.75	+20	1880 000 025	10.90	0.000 001

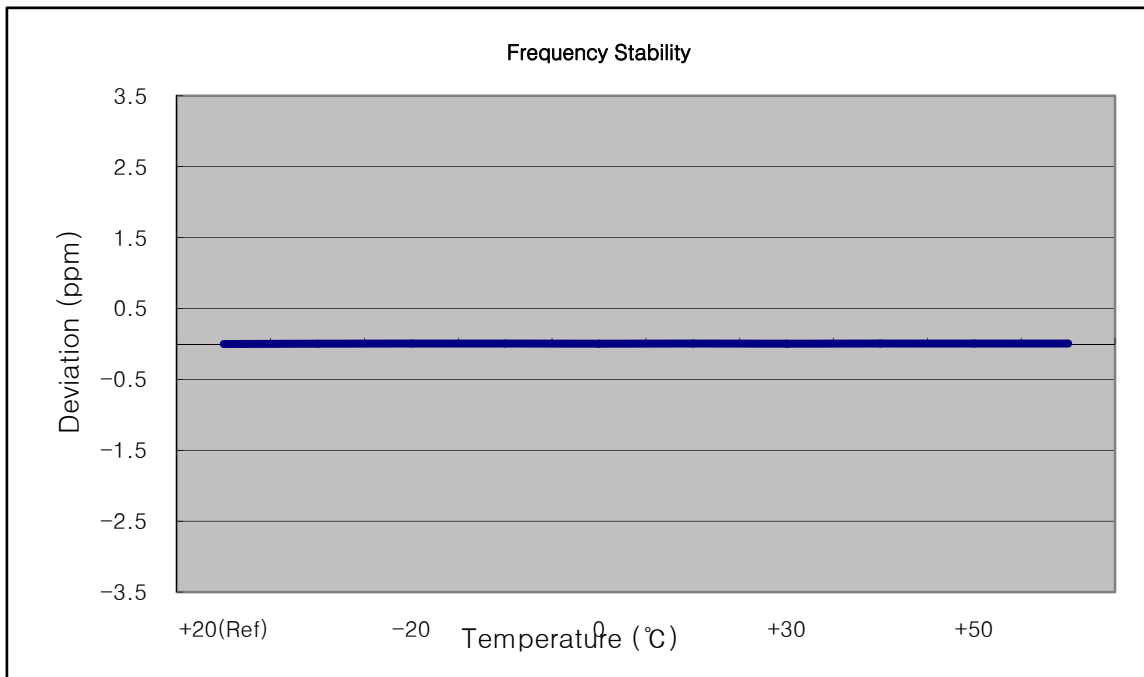



## 9. TEST PLOTS

■ CDMA MODE (1013 CH.) Occupied Bandwidth

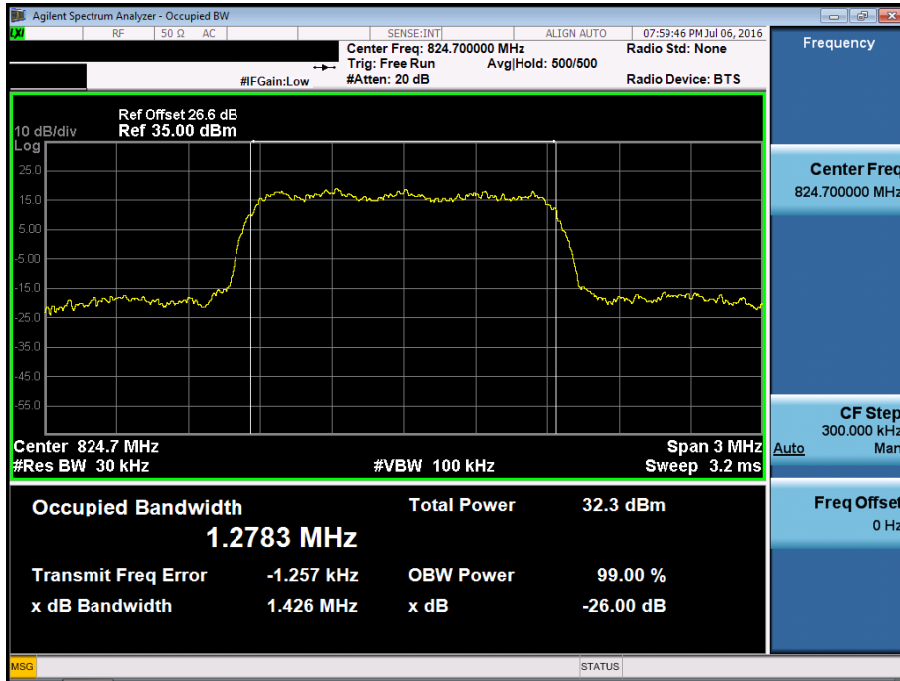

■ CDMA MODE (384 CH.) Occupied Bandwidth

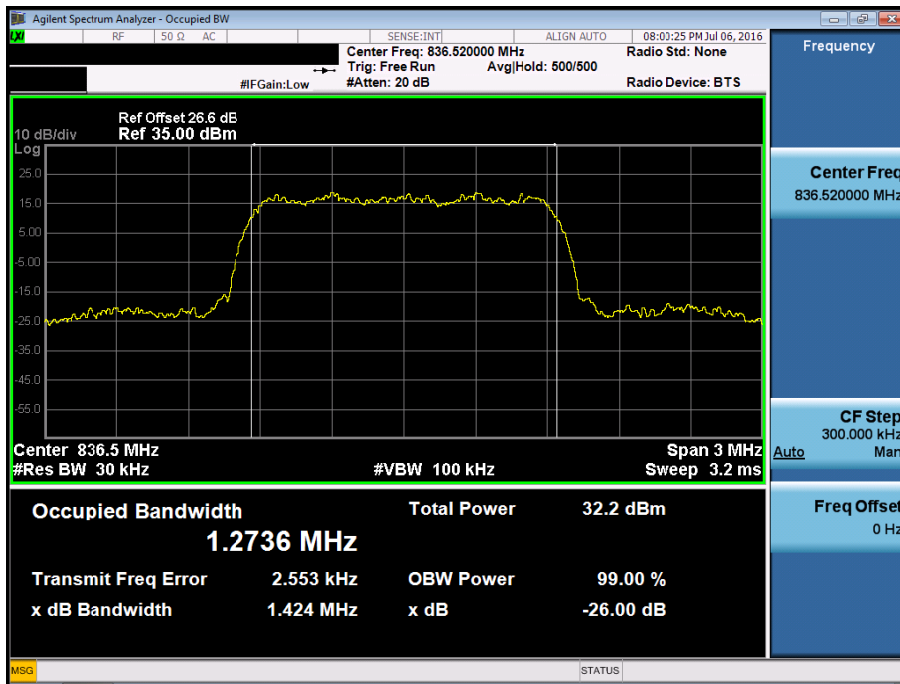

■ CDMA MODE (777 CH.) Occupied Bandwidth

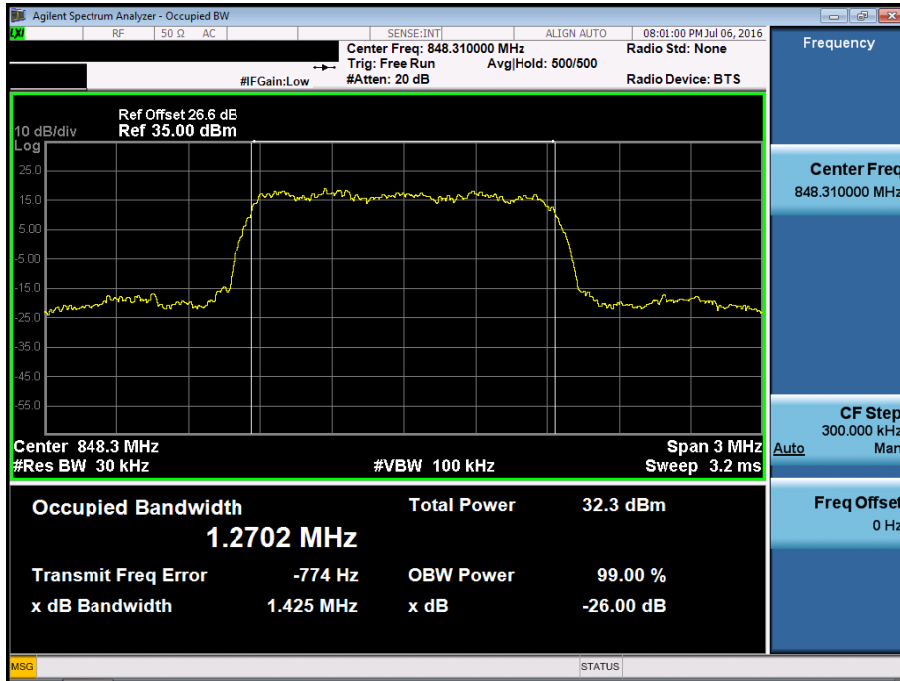

■ CDMA EVDO\_Rev.0 MODE (1013 CH.) Occupied Bandwidth

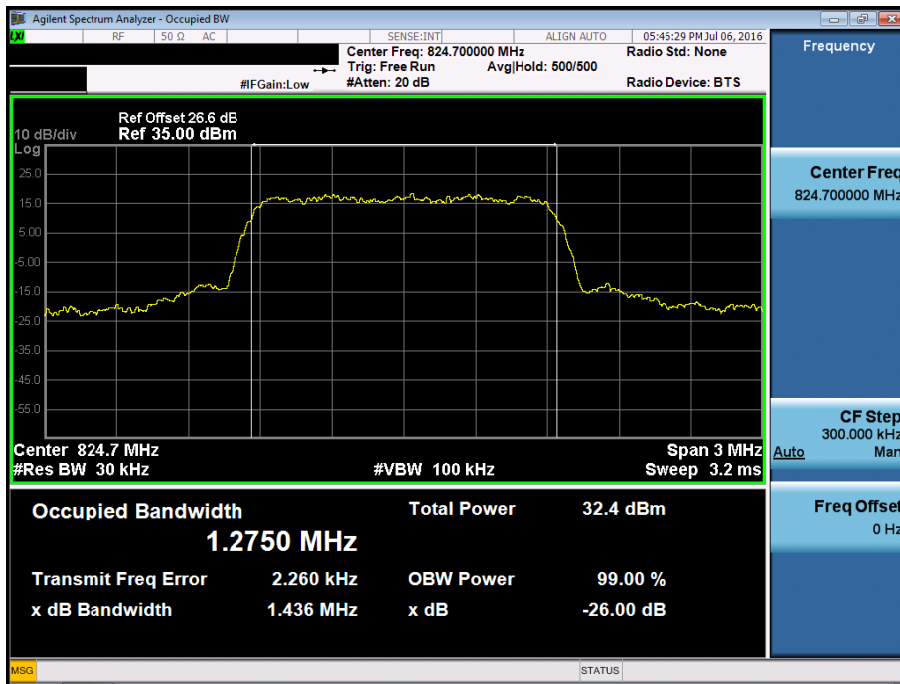

■ CDMA EVDO\_Rev.0 MODE (384 CH.) Occupied Bandwidth

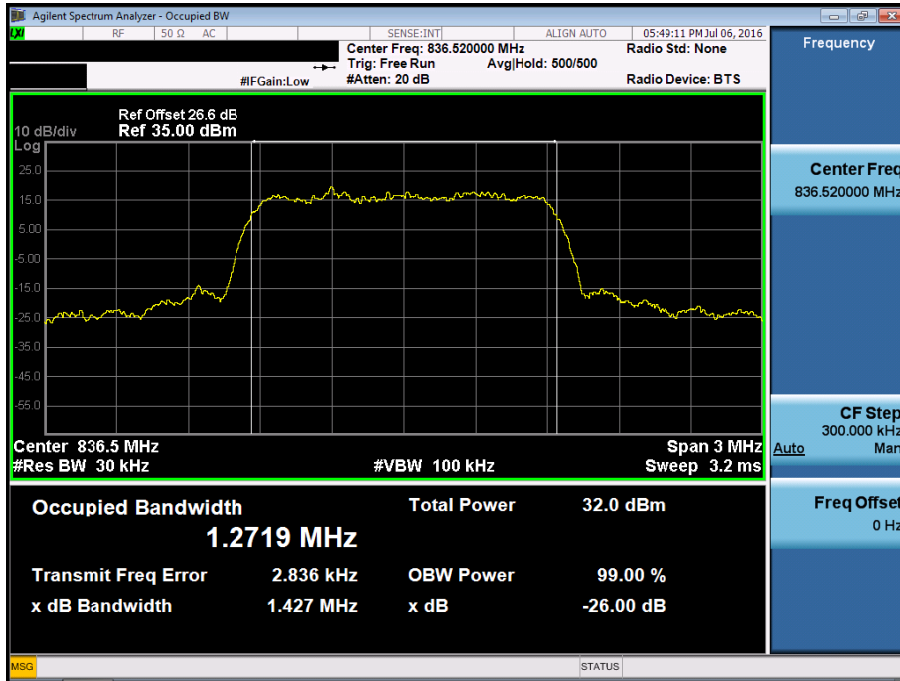

■ CDMA EVDO\_Rev.0 MODE (777 CH.) Occupied Bandwidth

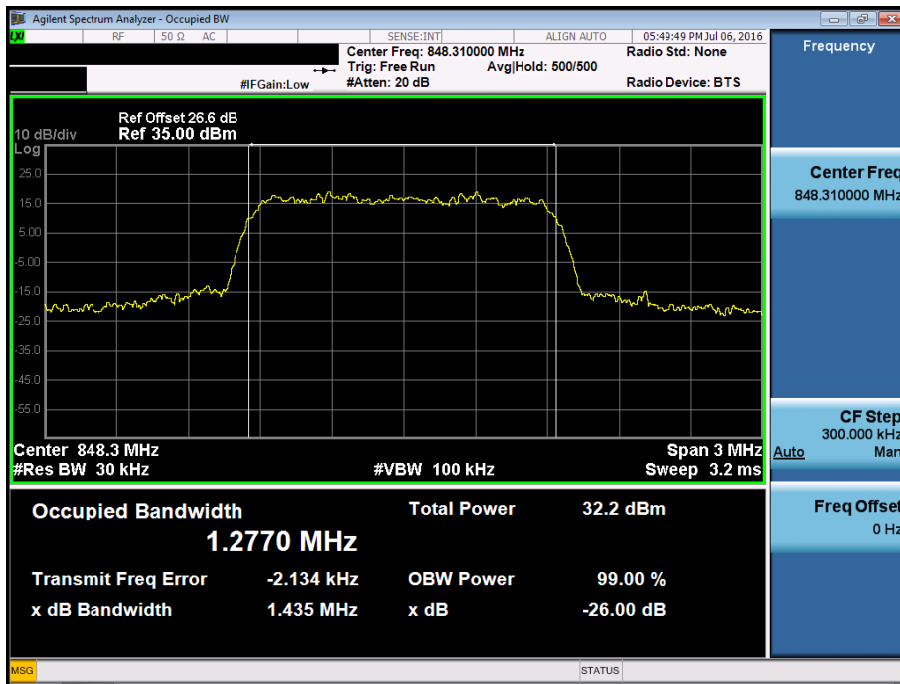

■ CDMA EVDO\_Rev.A MODE (1013 CH.) Occupied Bandwidth

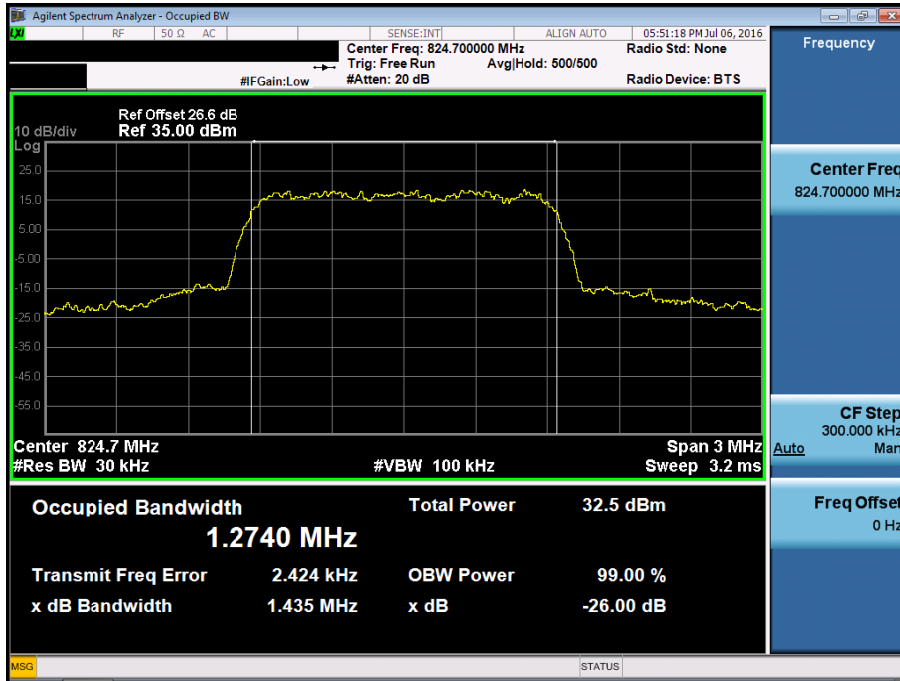

■ CDMA EVDO\_Rev.A MODE (384 CH.) Occupied Bandwidth

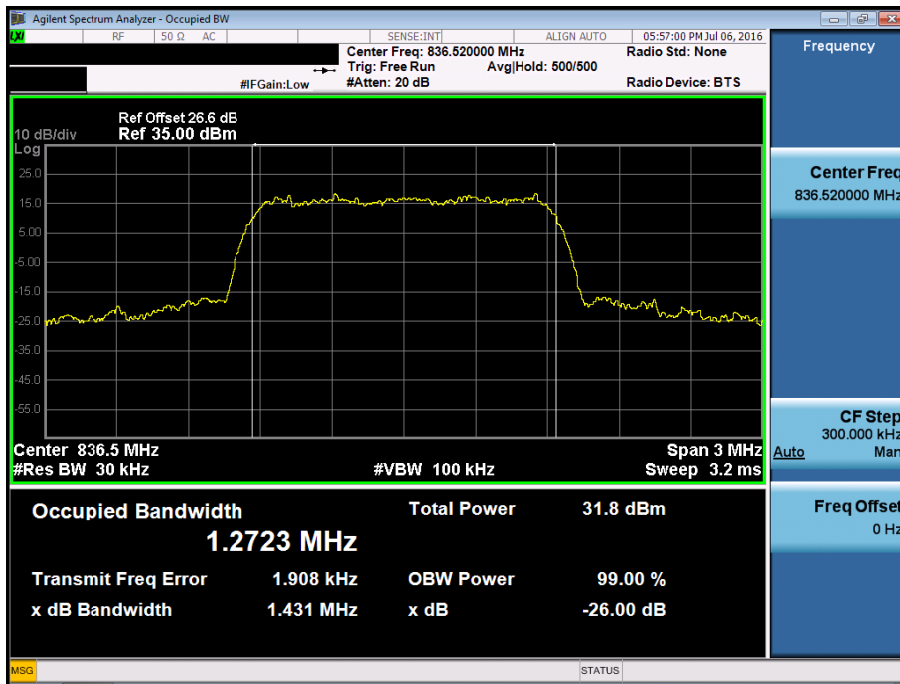

■ CDMA EVDO\_Rev.A MODE (777 CH.) Occupied Bandwidth

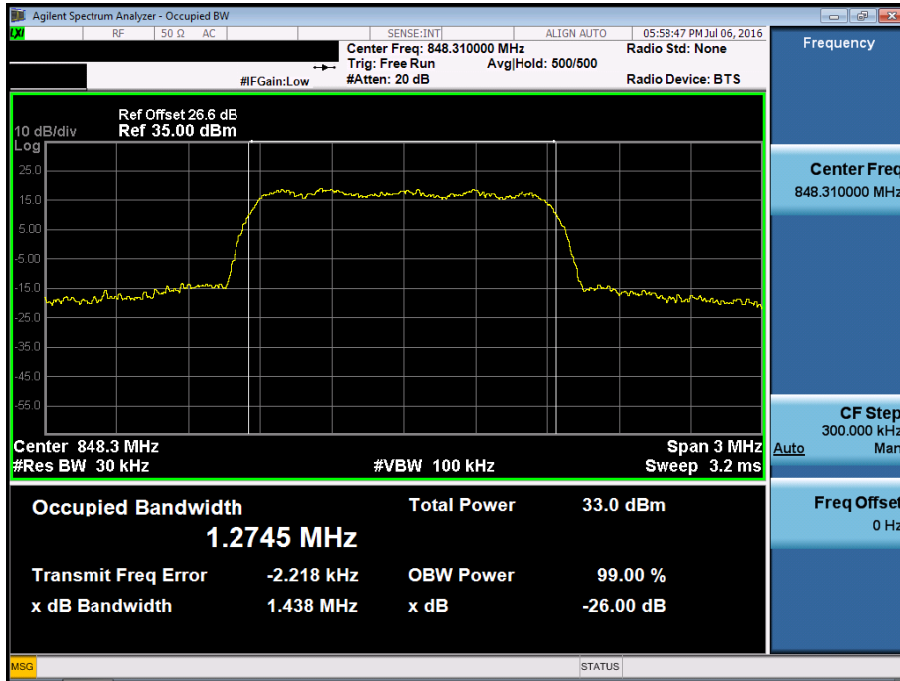

■ PCS MODE (25 CH.) Occupied Bandwidth

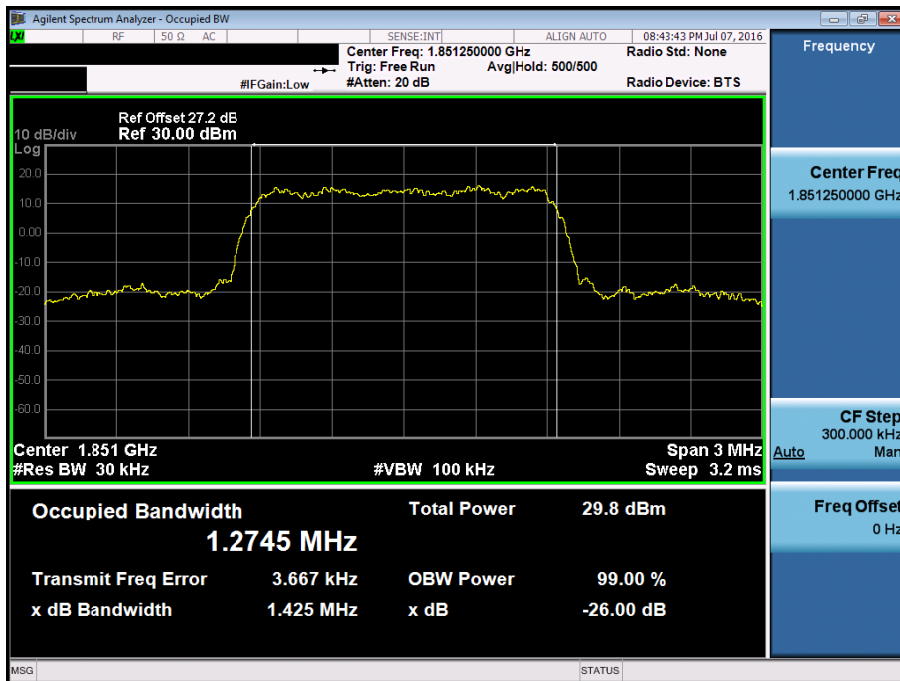

■ PCS MODE (600 CH.) Occupied Bandwidth

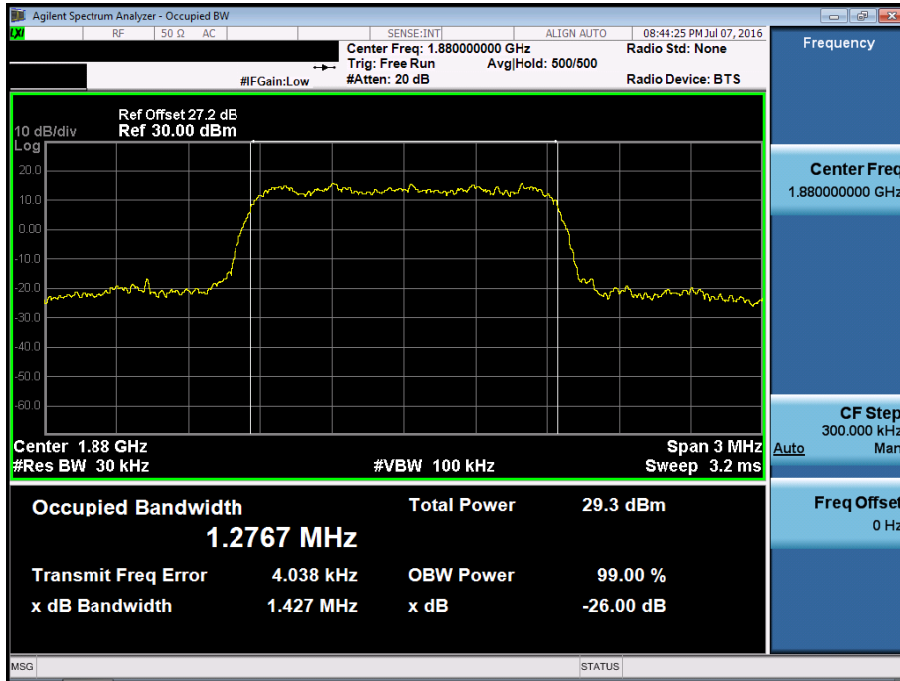

■ PCS MODE (1175 CH.) Occupied Bandwidth

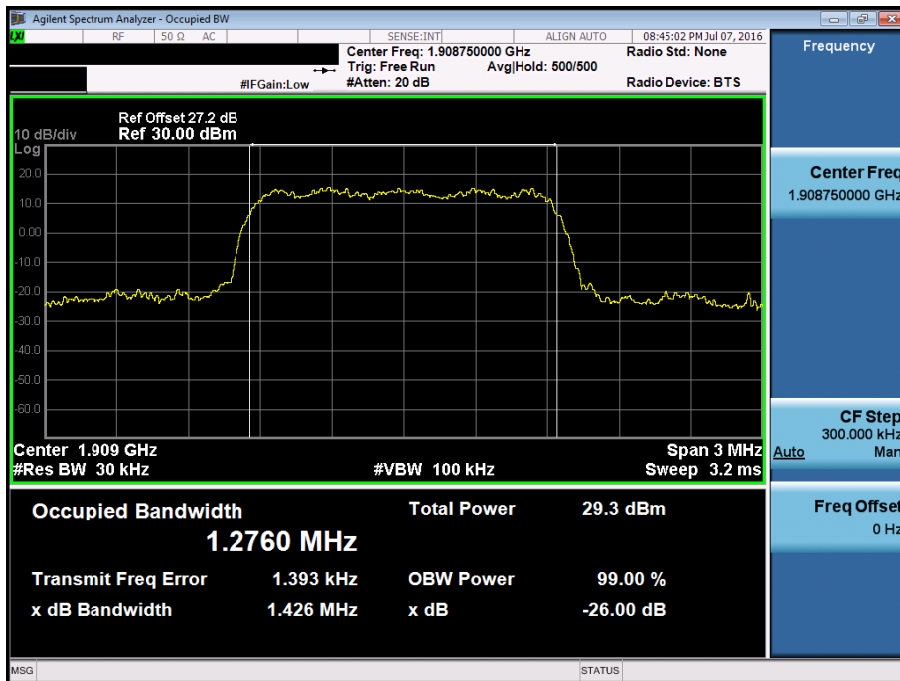

■ PCS EVDO\_Rev.0 MODE (25 CH.) Occupied Bandwidth

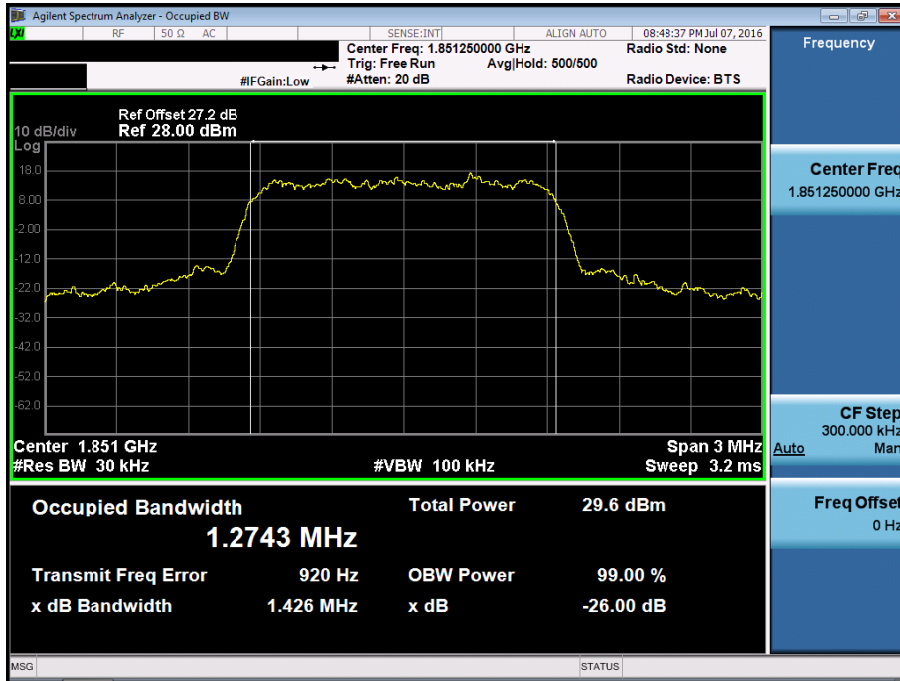

■ PCS EVDO\_Rev.0 MODE (600 CH.) Occupied Bandwidth

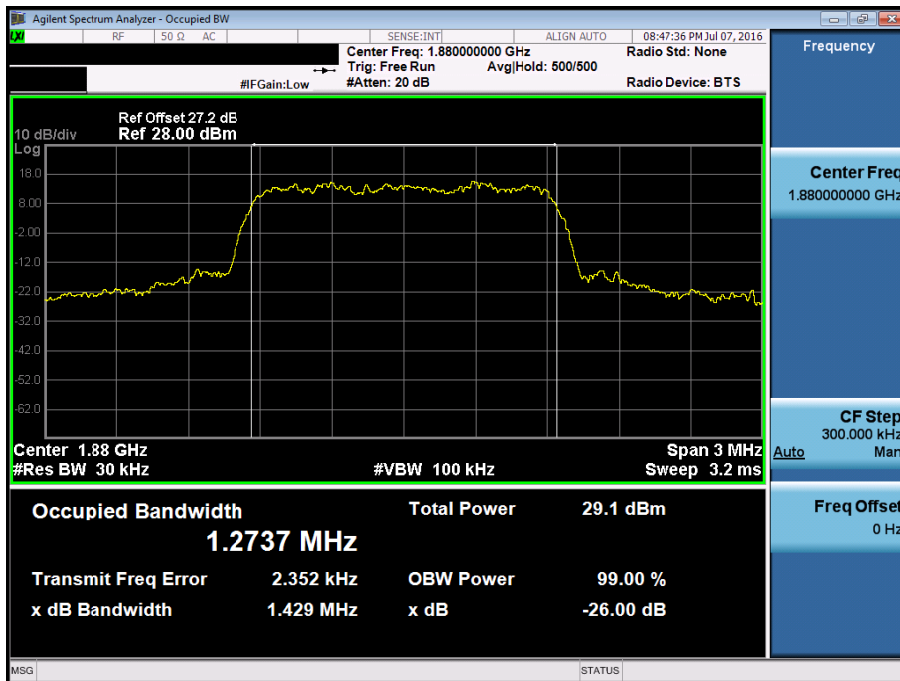



■ PCS EVDO\_Rev.0 MODE (1175 CH.) Occupied Bandwidth

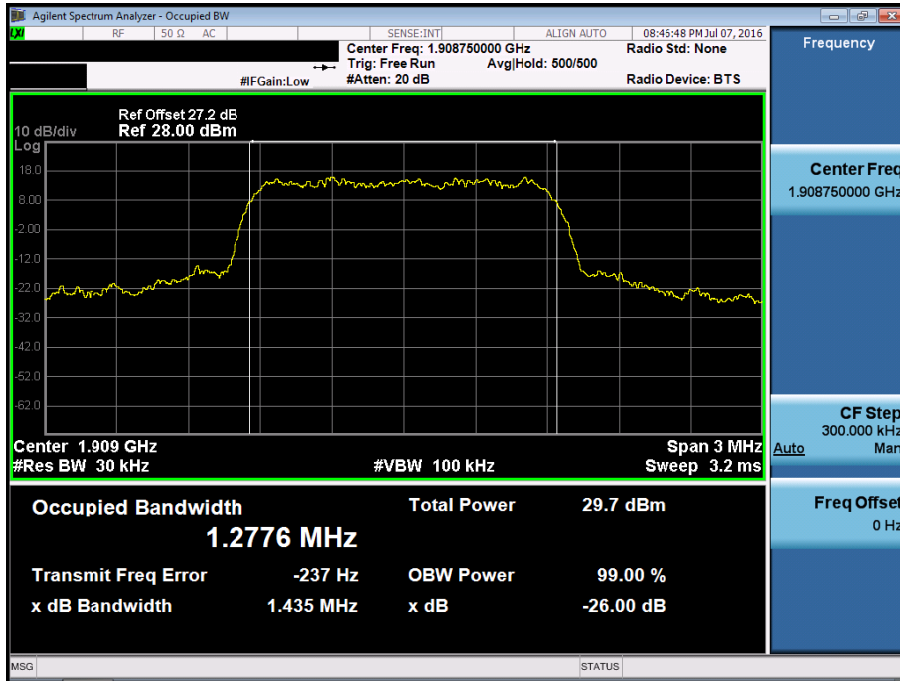

■ PCS EVDO\_Rev.A MODE (25 CH.) Occupied Bandwidth

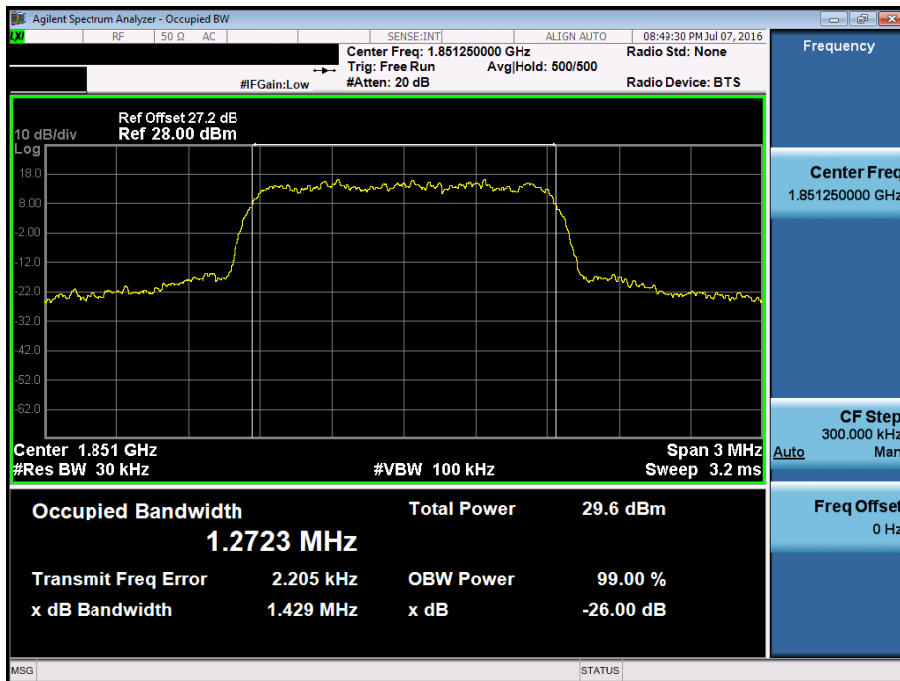

■ PCS EVDO\_Rev.A MODE (600 CH.) Occupied Bandwidth

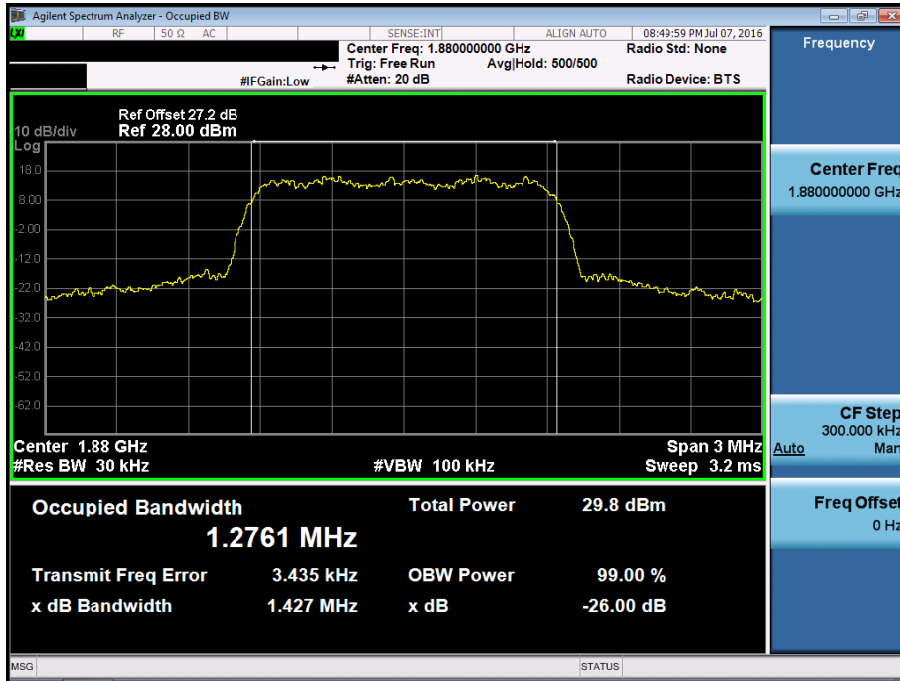

■ PCS EVDO\_Rev.A MODE (1175 CH.) Occupied Bandwidth

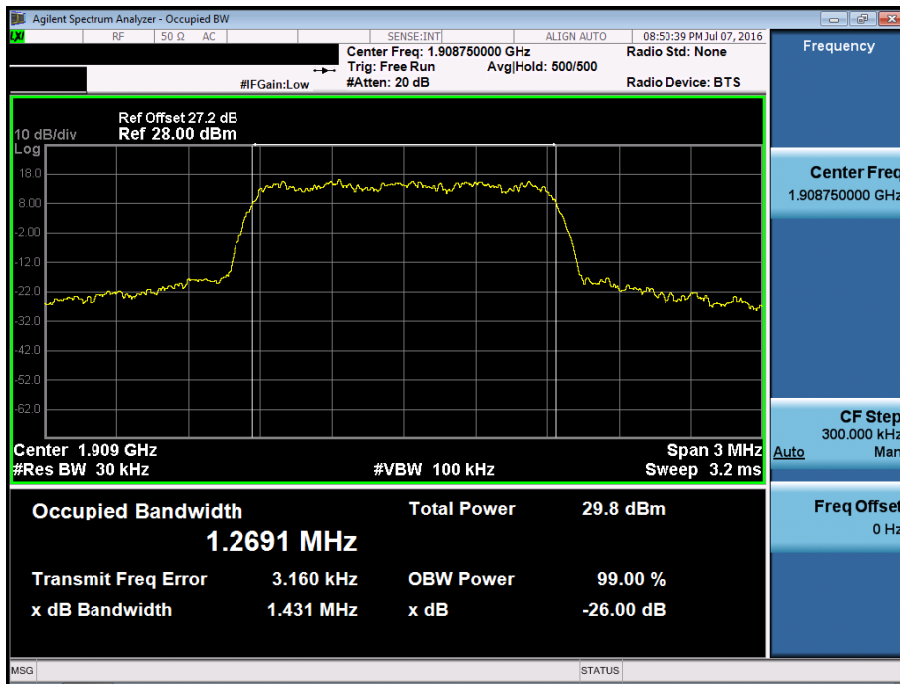

■ PCS CDMA MODE (600 CH.) Peak-to-Average Ratio

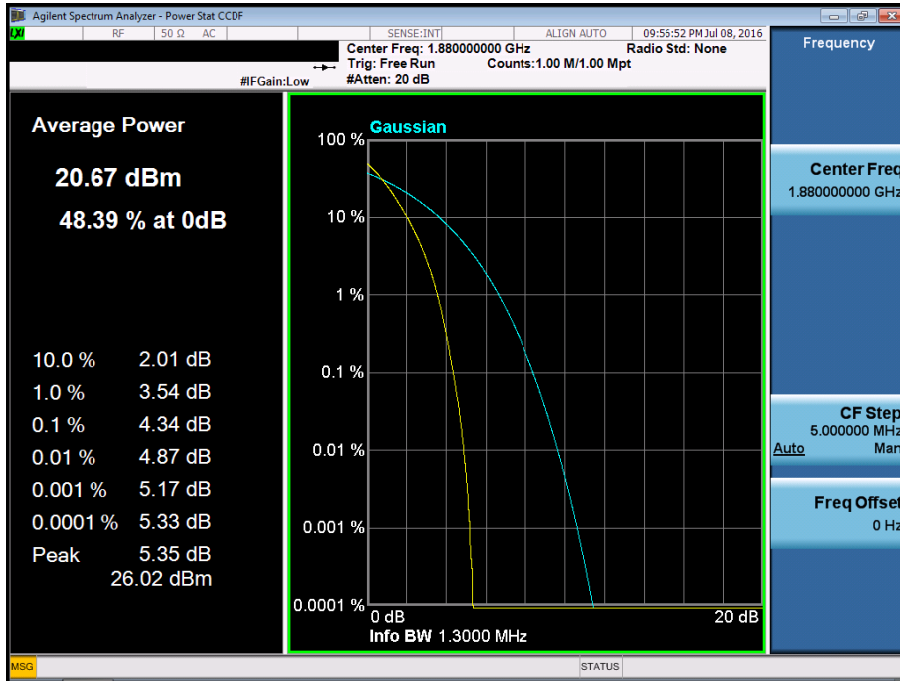

■ PCS CDMA EVDO\_Rev.0 MODE (600 CH.) Peak-to-Average Ratio

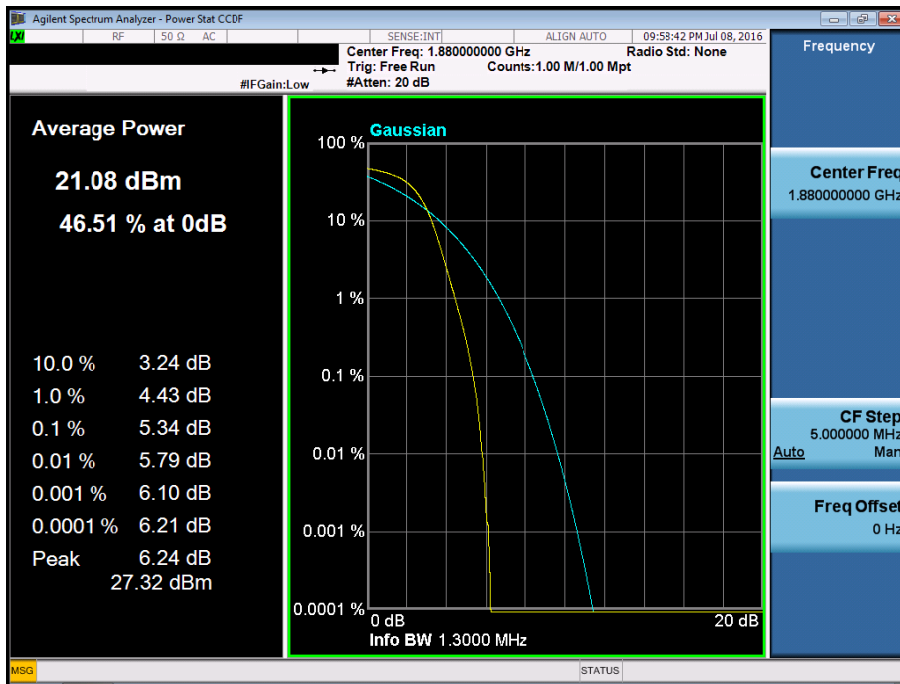

■ PCS CDMA EVDO\_Rev.A MODE (600 CH.) Peak-to-Average Ratio

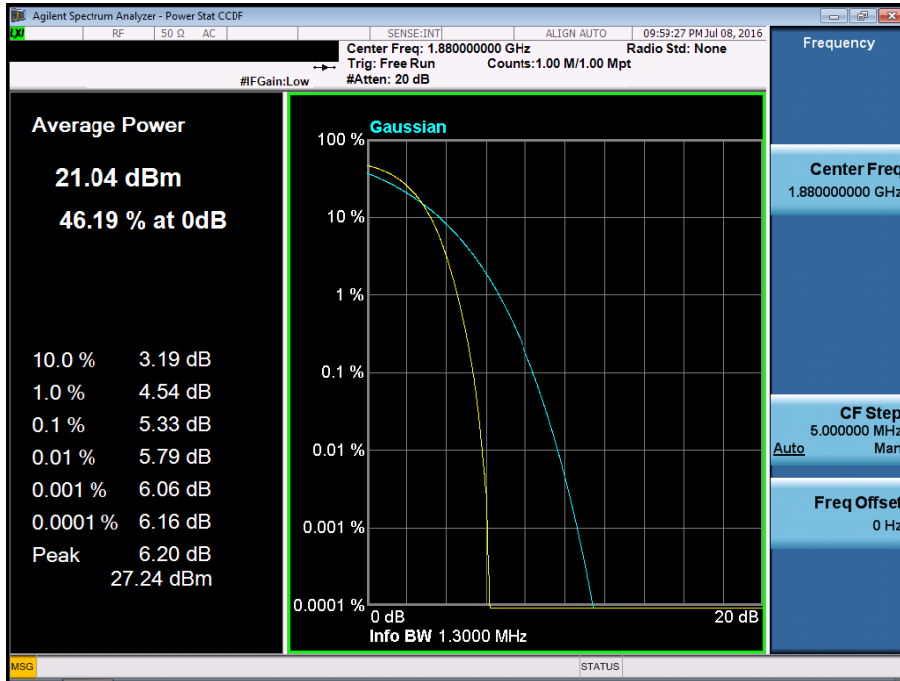

■ CDMA MODE (1013 CH.) Block Edge

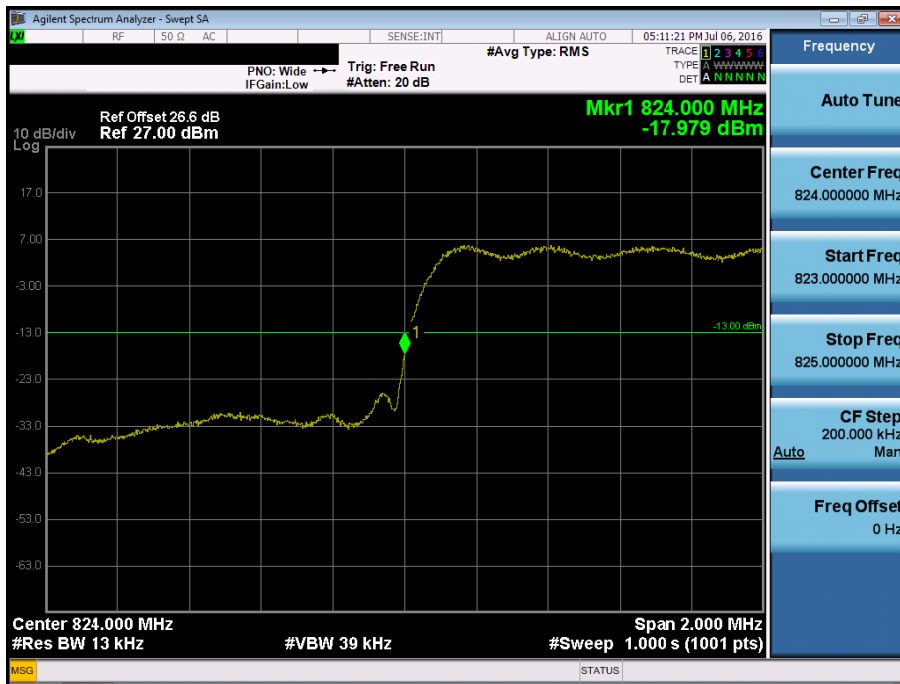

■ CDMA EVDO\_Rev.0 MODE (1013 CH.) Block Edge

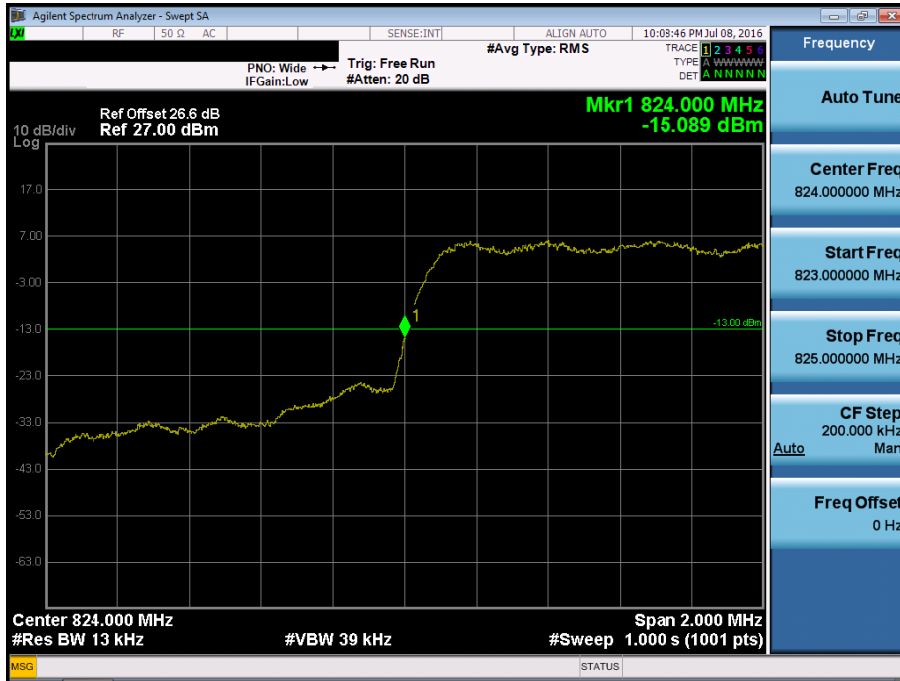

■ CDMA EVDO\_Rev.A MODE (1013 CH.) Block Edge

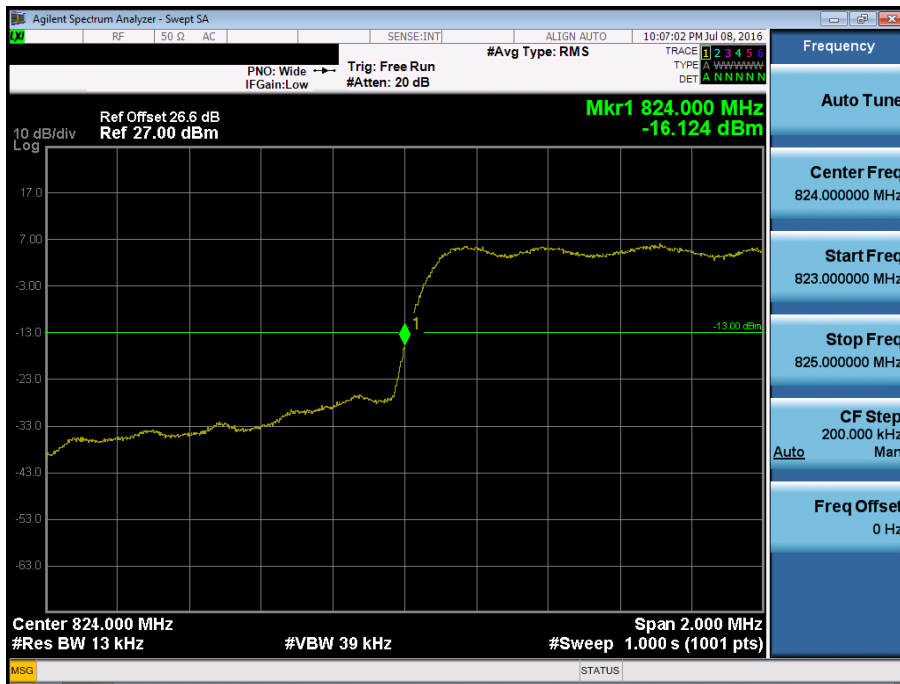

■ CDMA MODE (1013 CH.) 4 MHz Span

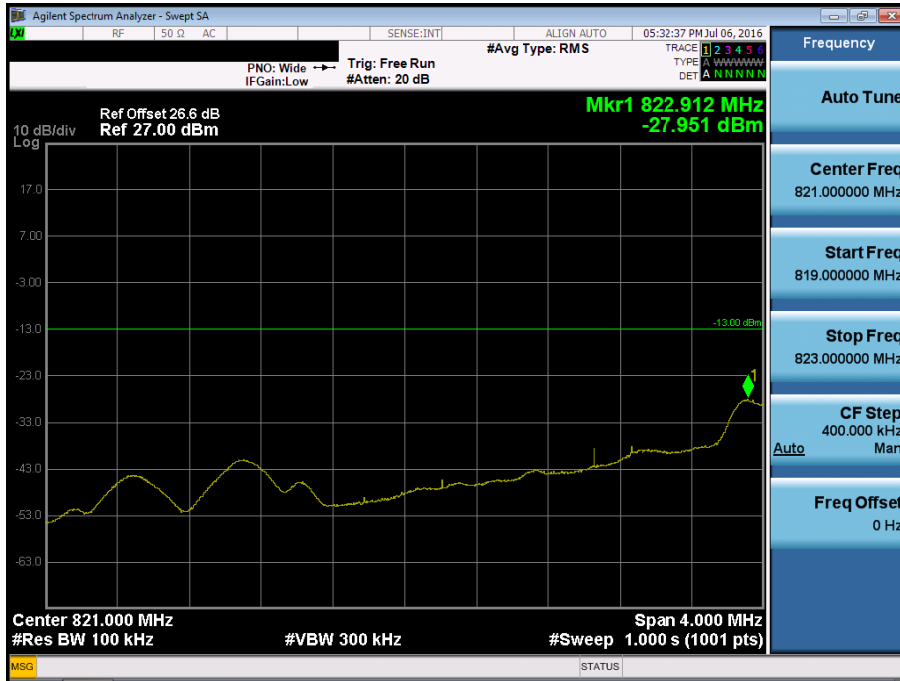

■ CDMA EVDO\_Rev.0 MODE (1013 CH.) 4 MHz Span



■ CDMA EVDO\_Rev.A MODE (1013 CH.) 4 MHz Span



■ CDMA MODE (777 CH.) Block Edge



■ CDMA EVDO\_Rev.0 MODE (777 CH.) Block Edge



■ CDMA EVDO\_Rev.A MODE (777 CH.) Block Edge

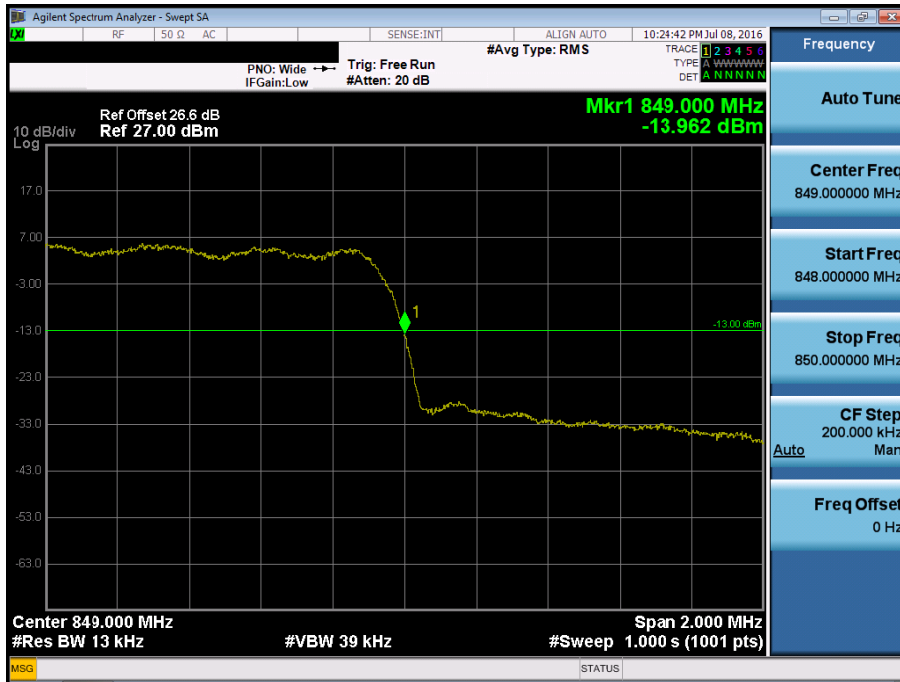



■ CDMA MODE (777 CH.) 4 MHz Span



■ CDMA EVDO\_Rev.0 MODE (777 CH.) 4 MHz Span



■ CDMA EVDO\_Rev.A MODE (777 CH.) 4 MHz Span



■ PCS MODE (25 CH.) Block Edge pan

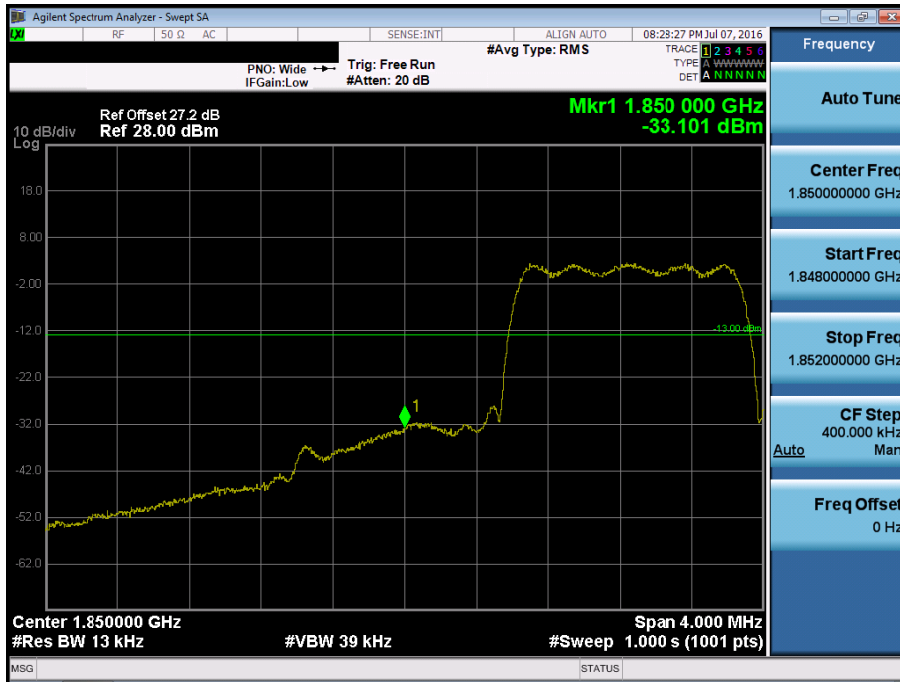

■ PCS EVDO\_Rev.0 MODE (25 CH.) Block Edge

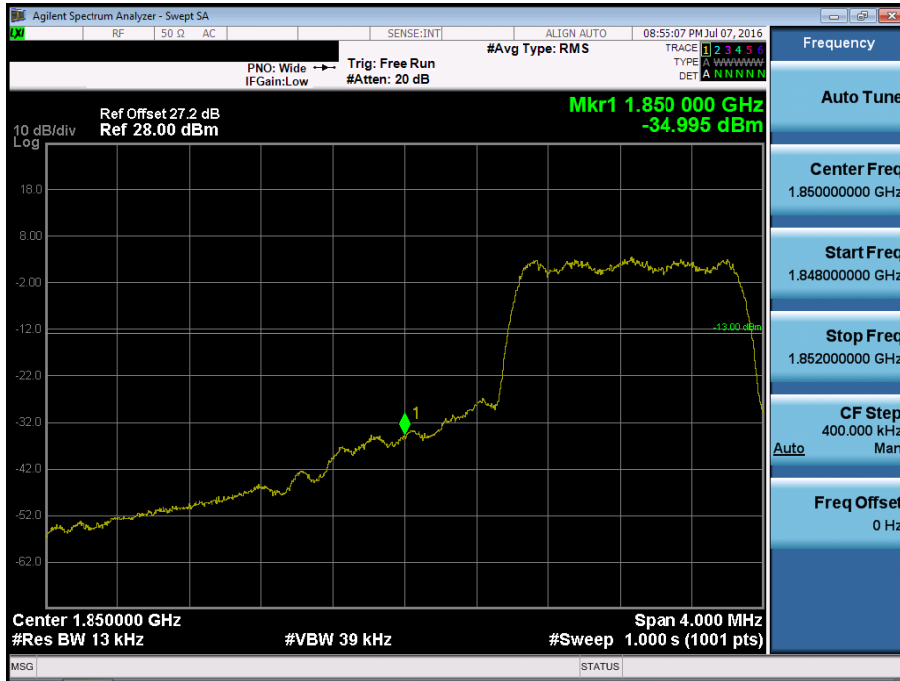

■ PCS EVDO\_Rev.A MODE (25 CH.) Block Edge

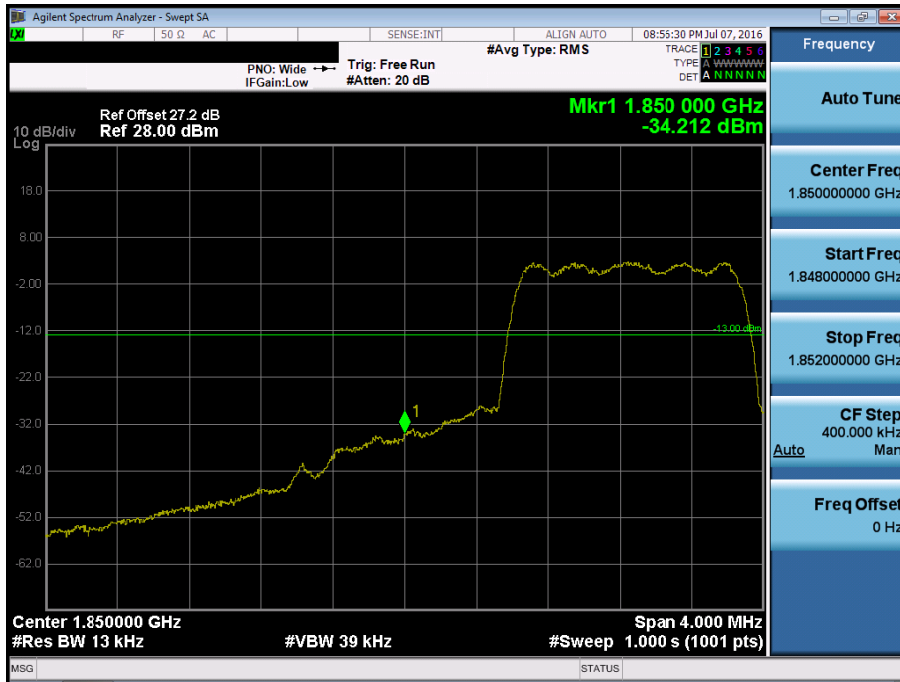

■ PCS MODE (25 CH.) 4 MHz Span



■ PCS EVDO\_Rev.0 MODE (25 CH.) 4 MHz Span



■ PCS EVDO\_Rev.A MODE (25 CH.) 4 MHz Span



■ PCS MODE (1175 CH.) Block Edge



■ PCS EVDO\_Rev.0 MODE (1175 CH.) Block Edge



■ PCS EVDO\_Rev.A MODE (1175 CH.) Block Edge



■ PCS MODE (1175 CH.) 4 MHz Span



■ PCS EVDO\_Rev.0 MODE (1175 CH.) 4 MHz Span

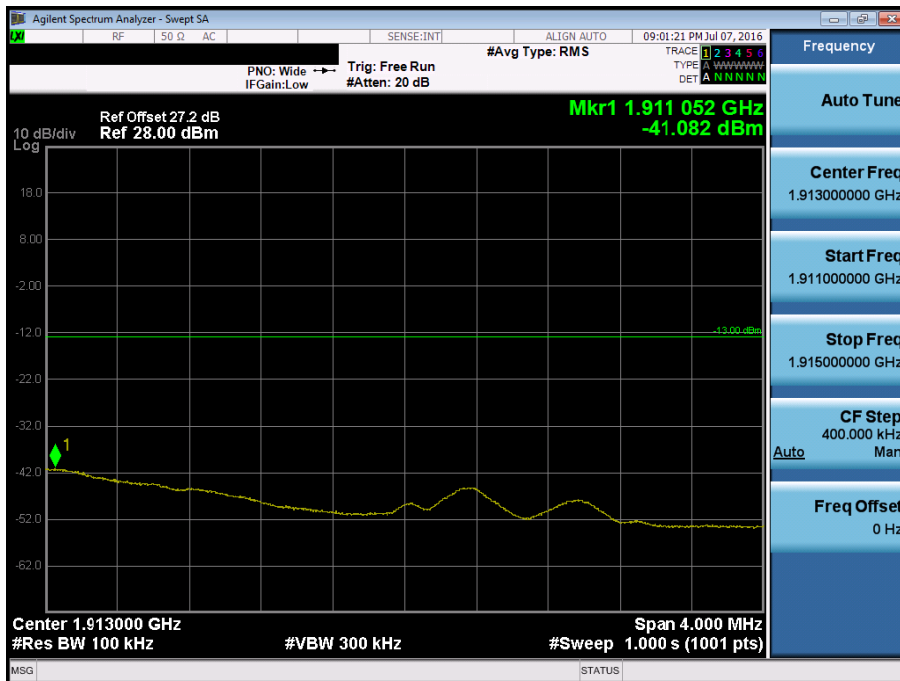

■ PCS EVDO\_Rev.A MODE (1175 CH.) 4 MHz Span

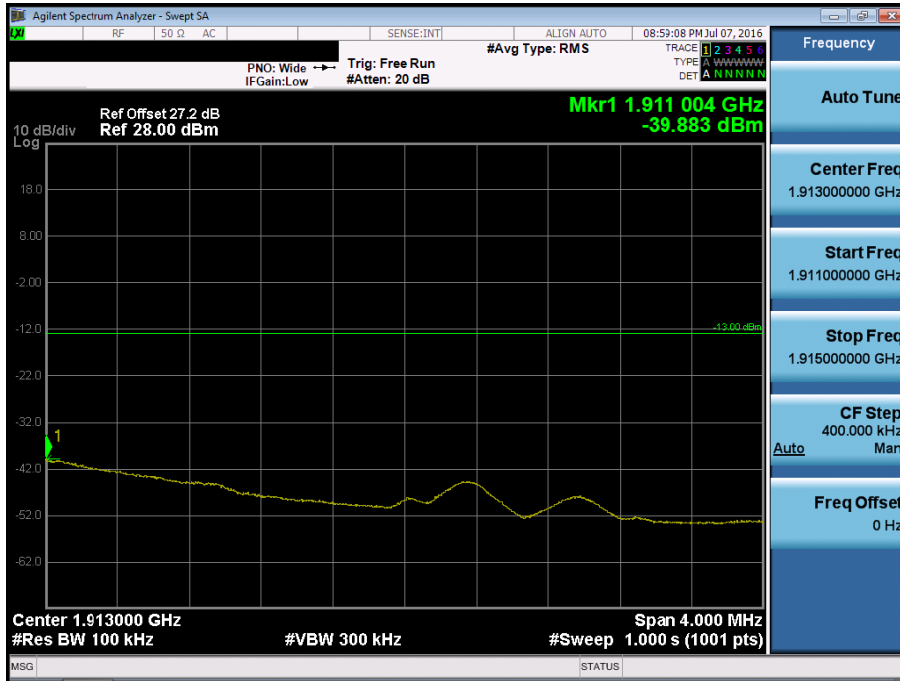

■ CDMA MODE (1013 CH.) Conducted Spurious Emissions

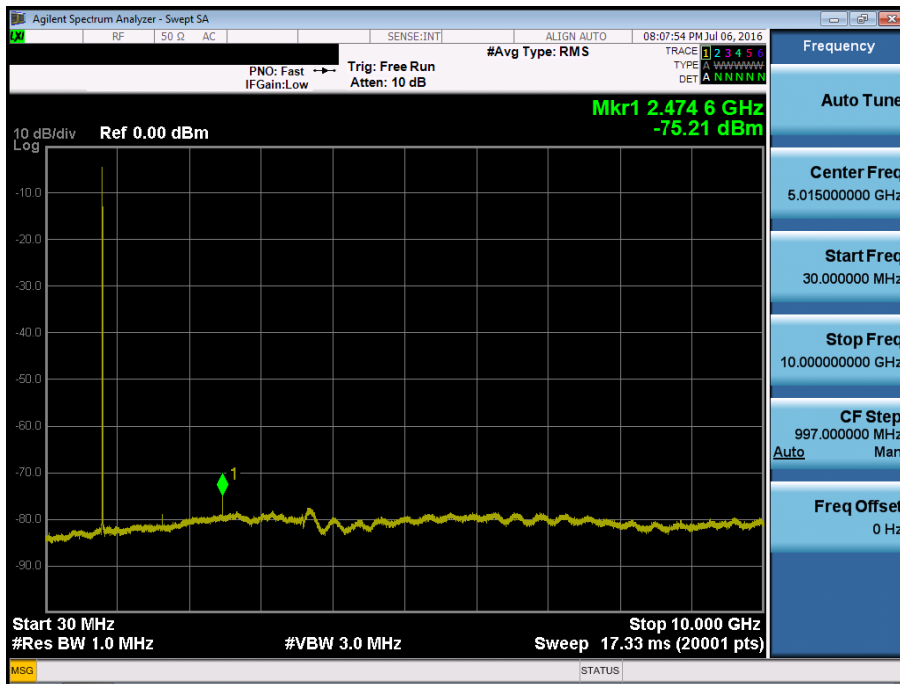



■ CDMA MODE (384 CH.) Conducted Spurious Emissions

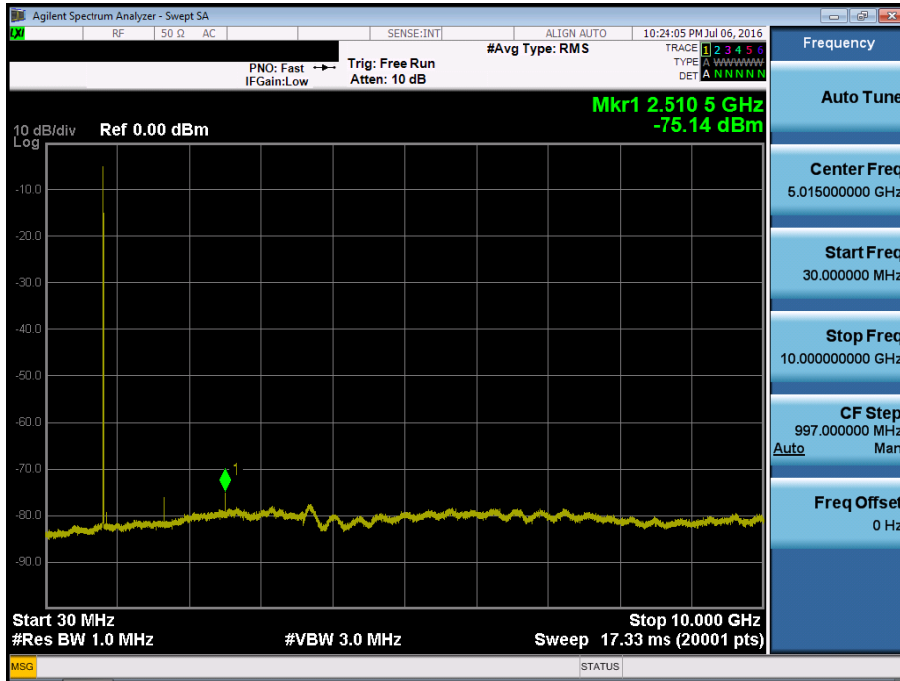

■ CDMA MODE (777 CH.) Conducted Spurious Emissions

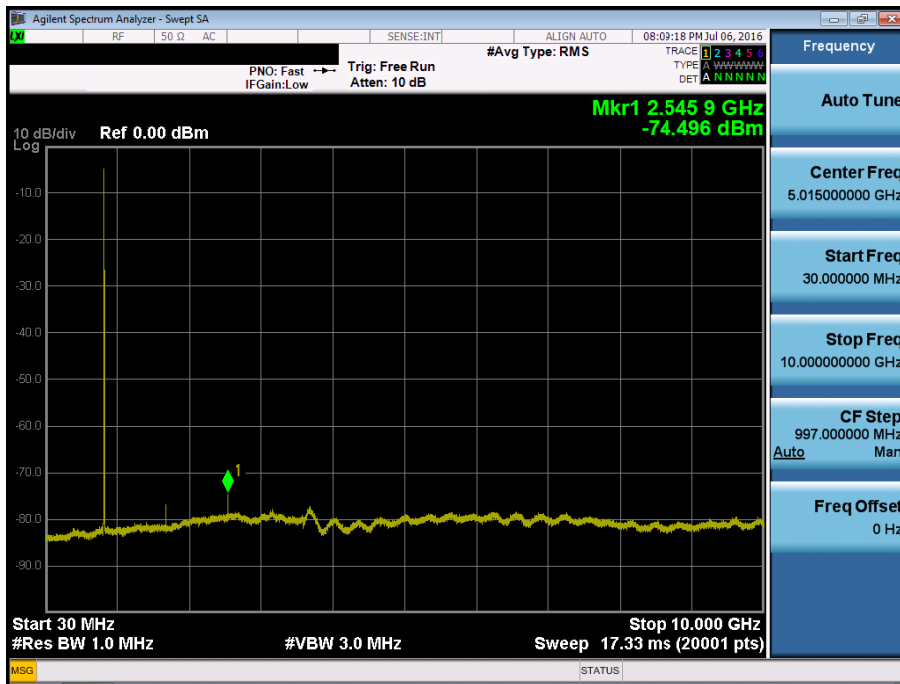

■ CDMA\_Rev.0MODE (1013 CH.) Conducted Spurious Emissions

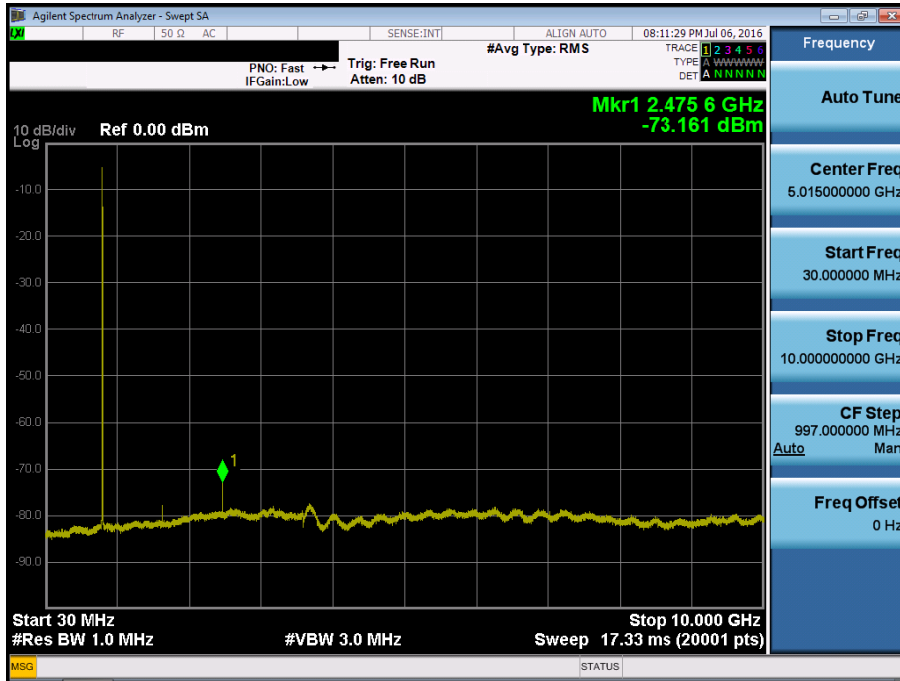

■ CDMA\_Rev.0MODE (384 CH.) Conducted Spurious Emissions

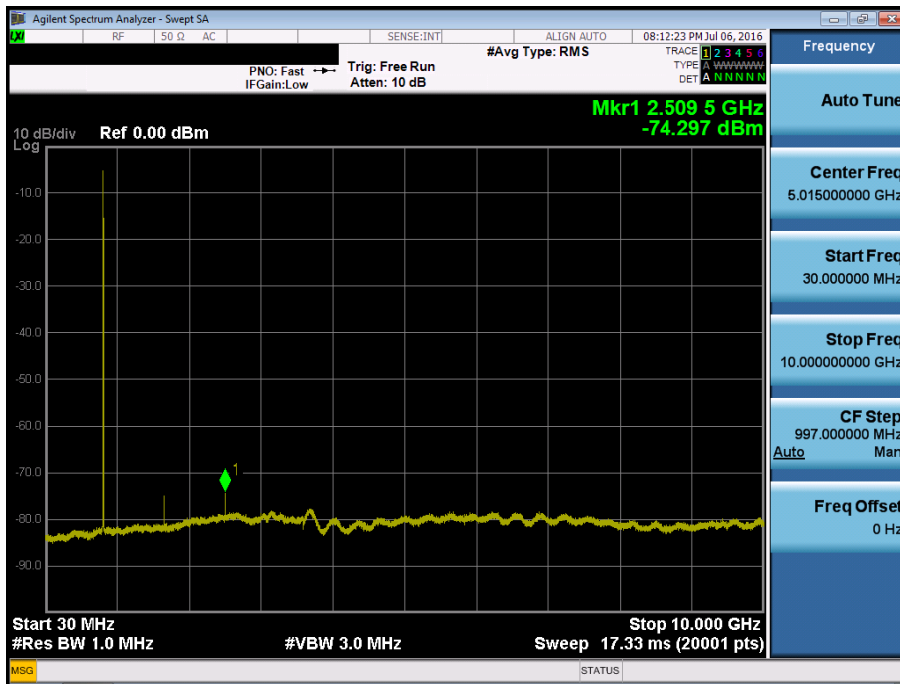

■ CDMA\_Rev.0MODE (777 CH.) Conducted Spurious Emissions

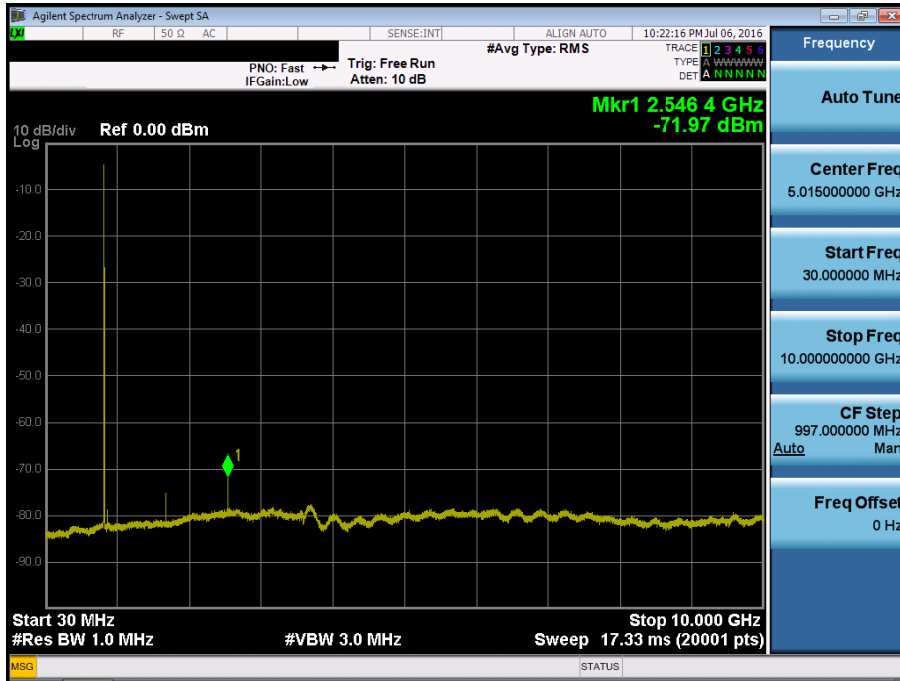

■ CDMA\_Rev.AMODE (1013 CH.) Conducted Spurious Emissions

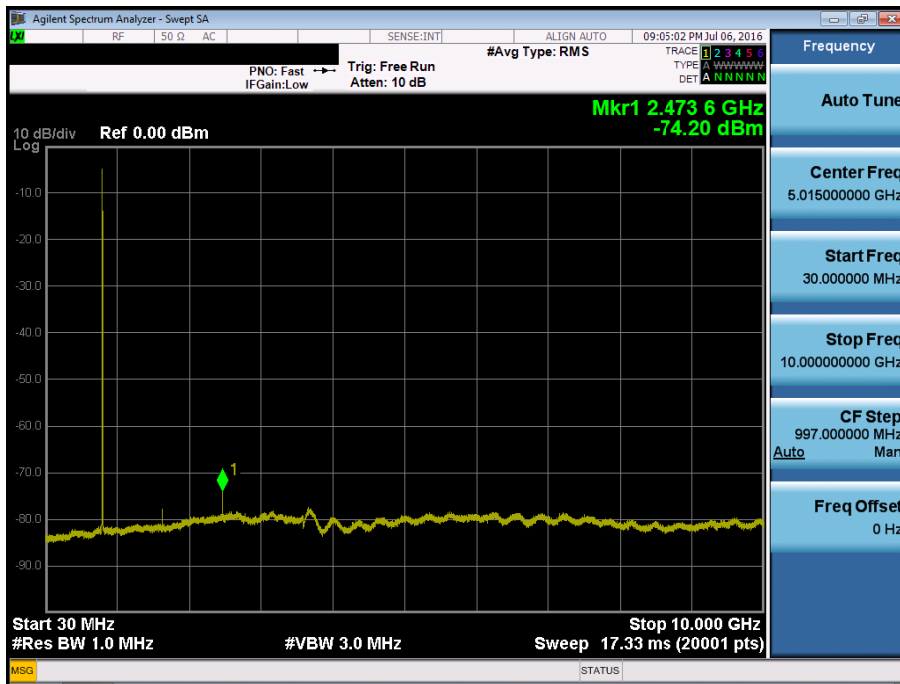

■ CDMA \_ Rev.A MODE (384 CH.) Conducted Spurious Emissions

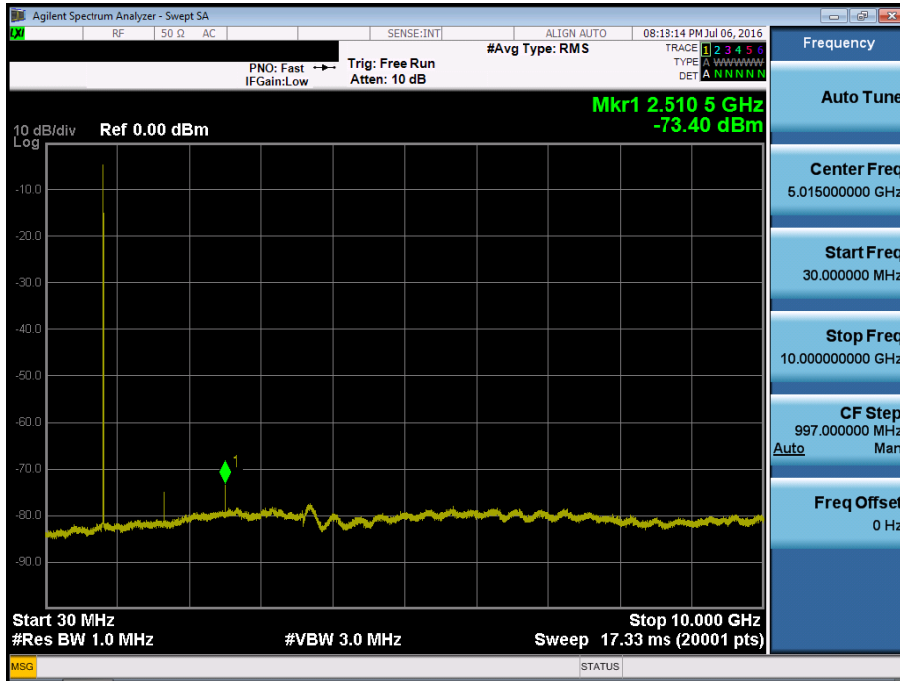

■ CDMA \_ Rev.A MODE (777 CH.) Conducted Spurious Emissions

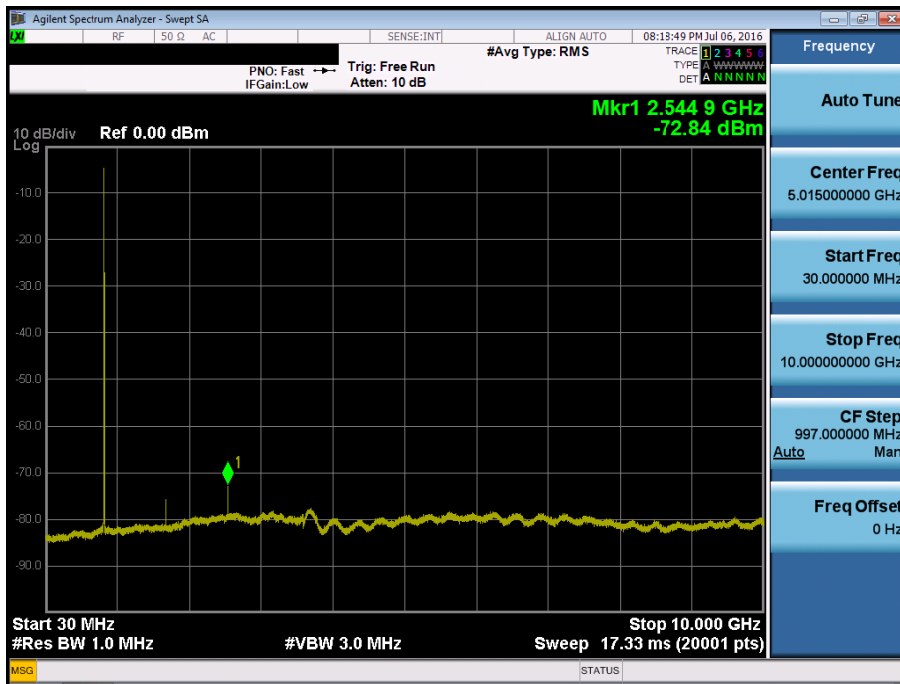

■ PCS MODE (25 CH.) Conducted Spurious Emissions -1

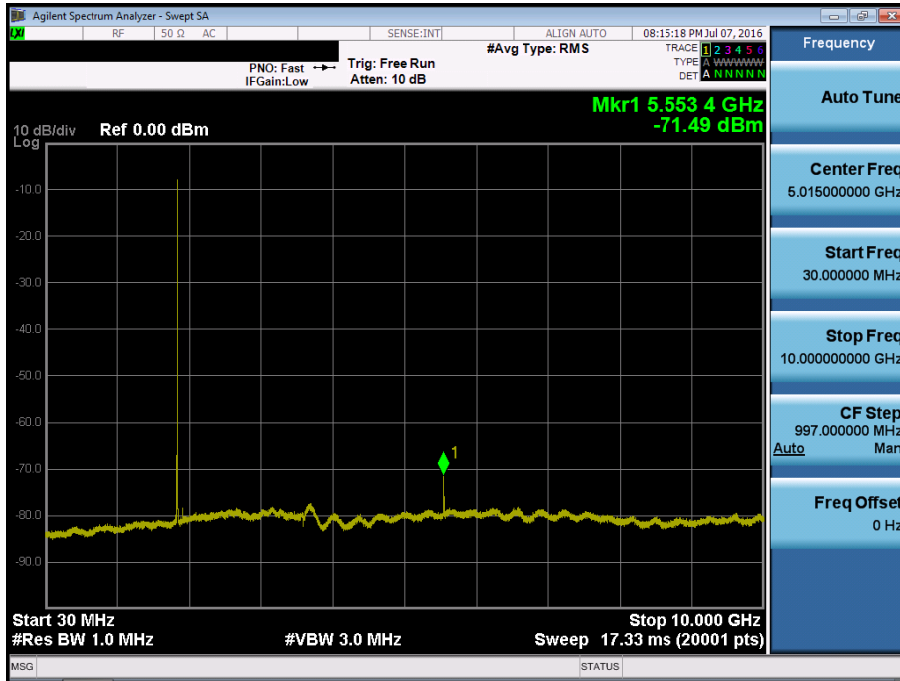

■ PCS MODE (25 CH.) Conducted Spurious Emissions -2

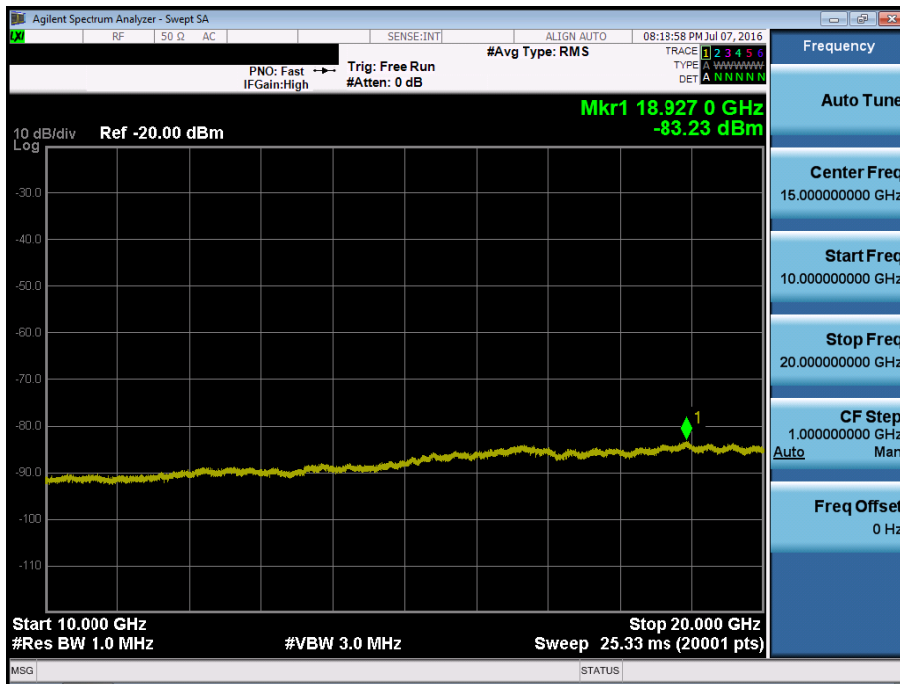

■ PCS MODE (600 CH.) Conducted Spurious Emissions -1

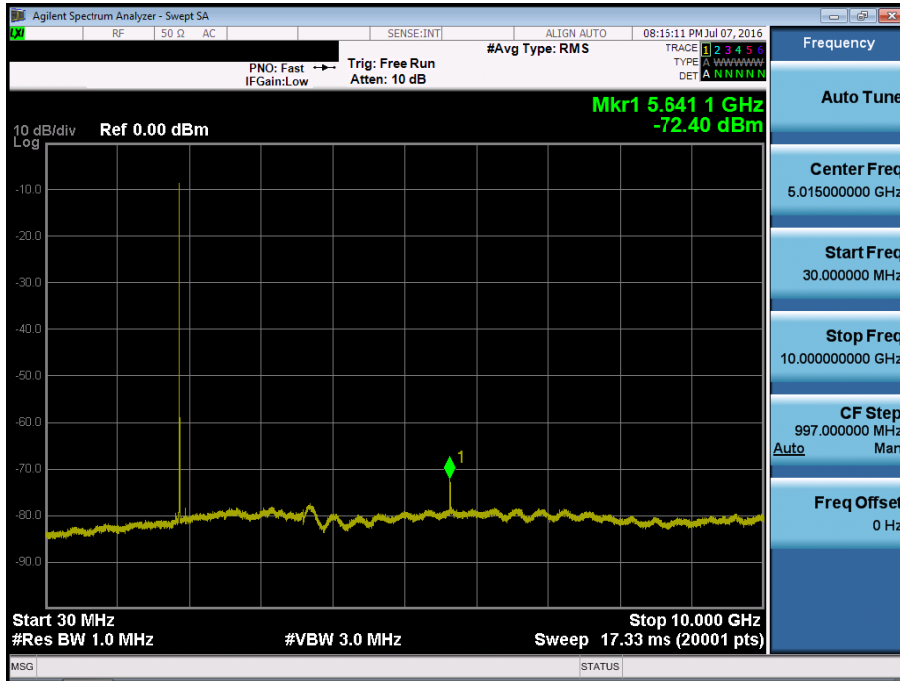

■ PCS MODE (600 CH.) Conducted Spurious Emissions -2

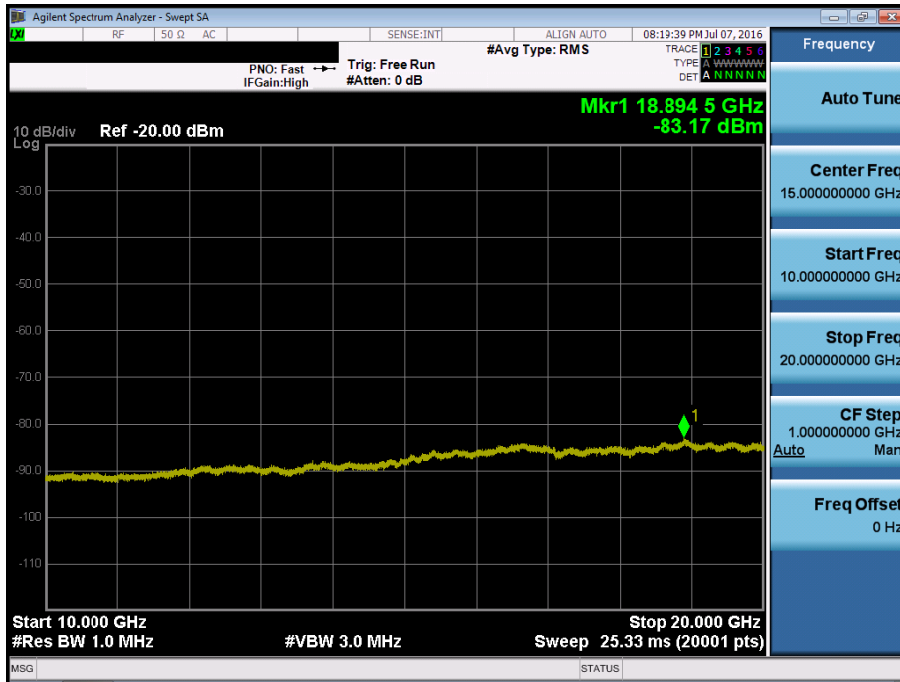

■ PCS MODE (1175 CH.) Conducted Spurious Emissions -1

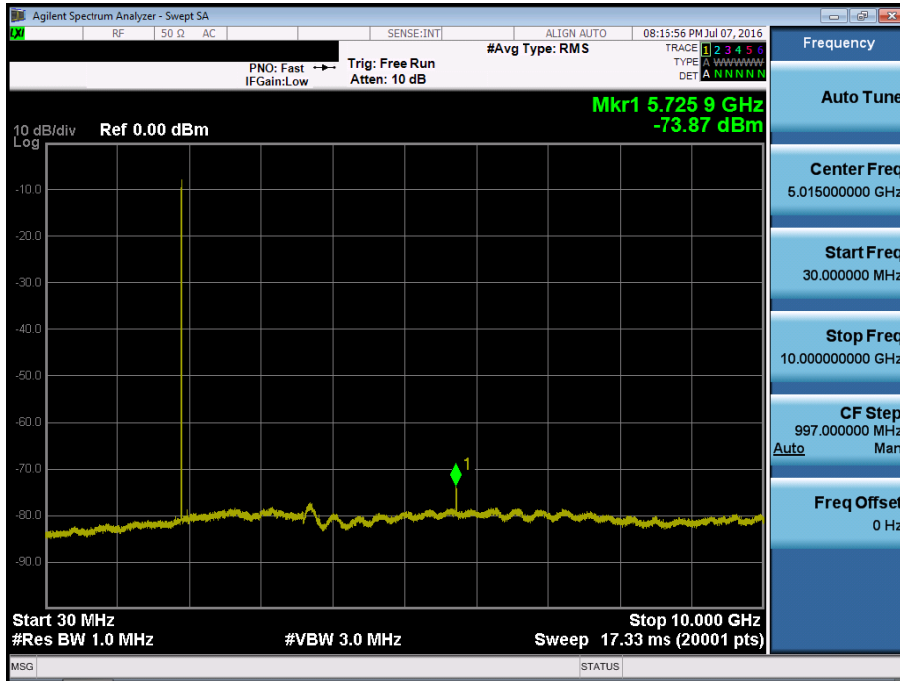

■ PCS MODE (1175 CH.) Conducted Spurious Emissions -2

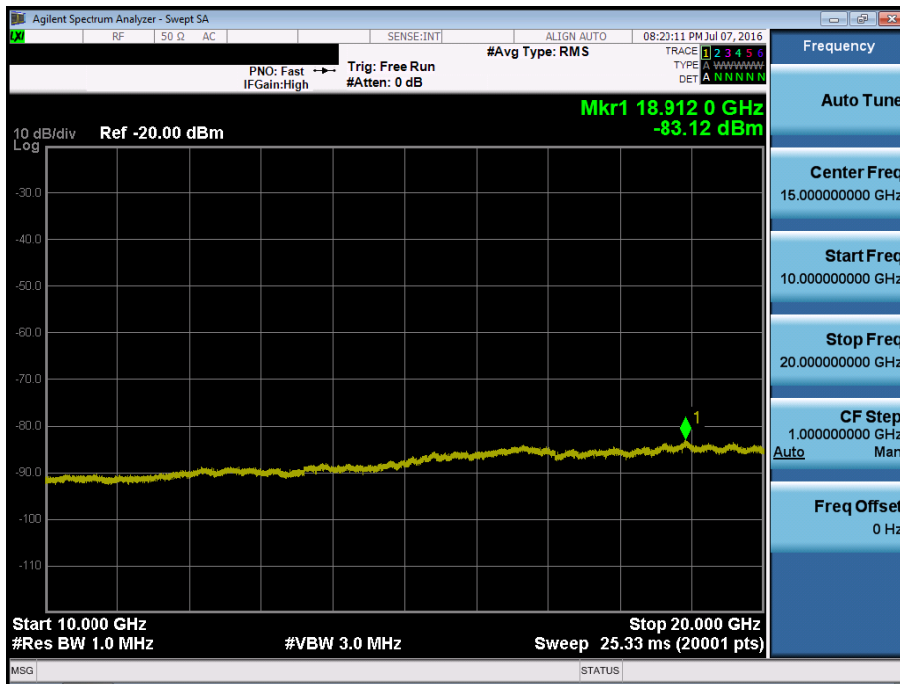

■ PCS\_Rev.0 MODE (25 CH.) Conducted Spurious Emissions -1

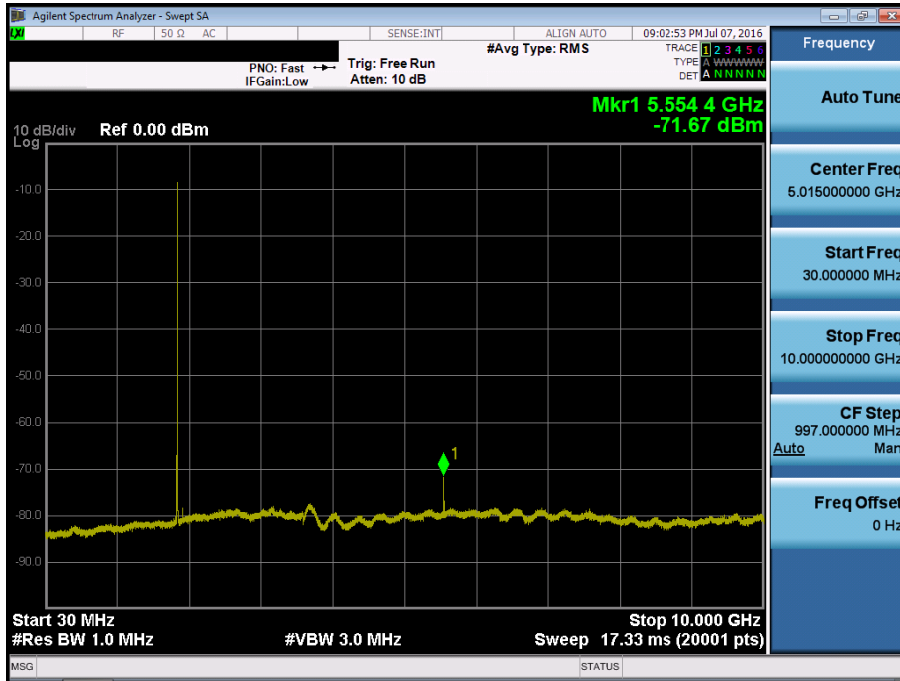

■ PCS\_Rev.0 MODE (25 CH.) Conducted Spurious Emissions -2

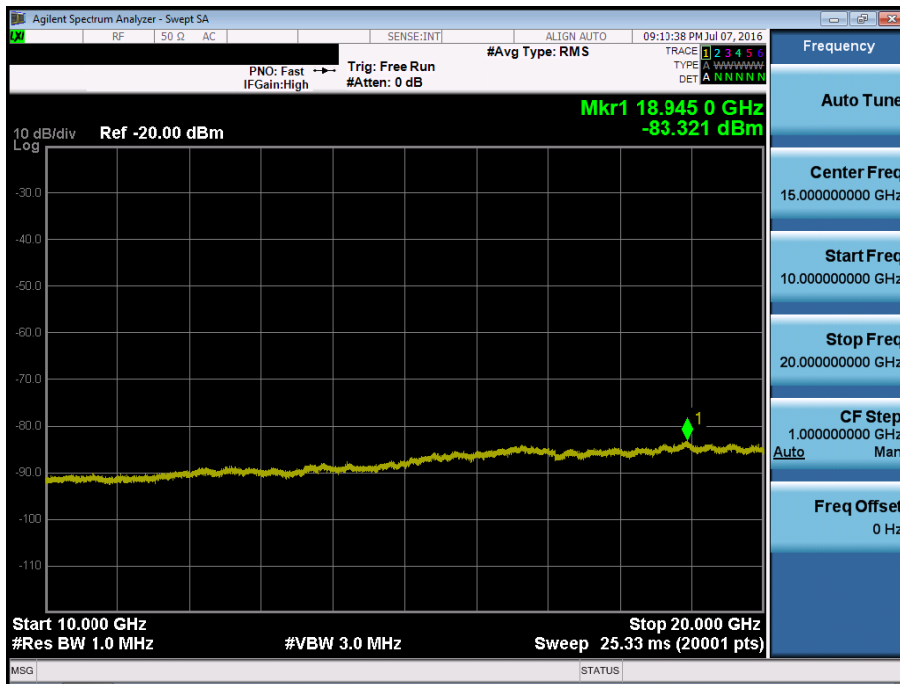



■ PCS\_Rev.0 MODE (600 CH.) Conducted Spurious Emissions -1

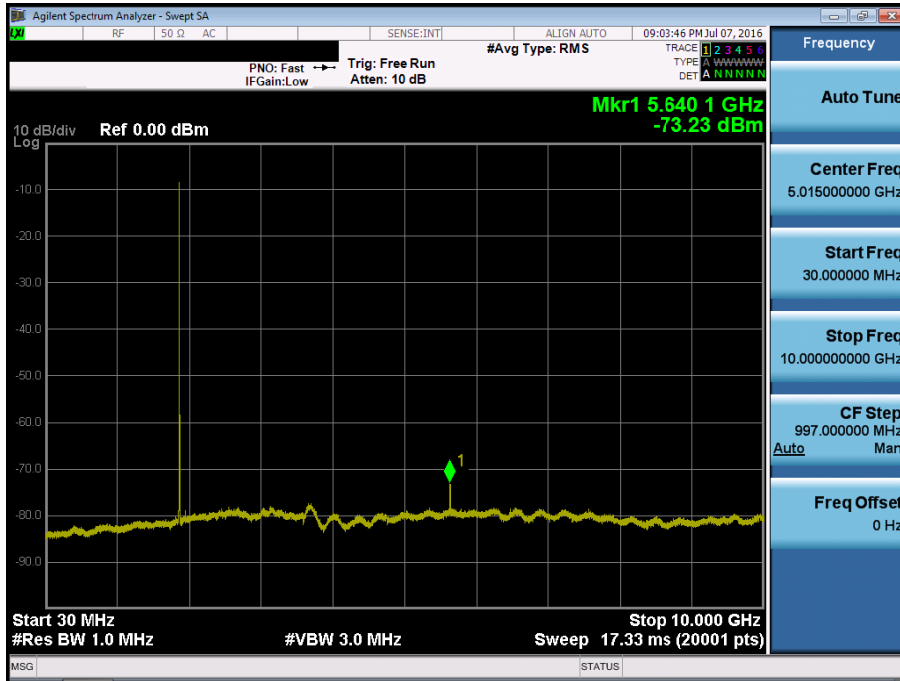

■ PCS\_Rev.0 MODE (600 CH.) Conducted Spurious Emissions -2

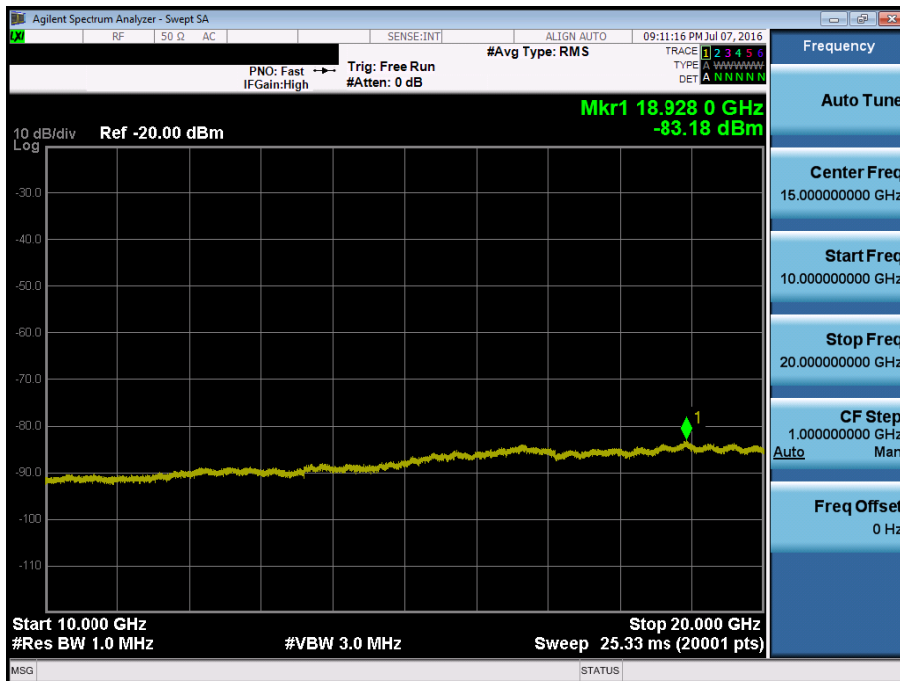

■ PCS\_Rev.0 MODE (1175 CH.) Conducted Spurious Emissions -1

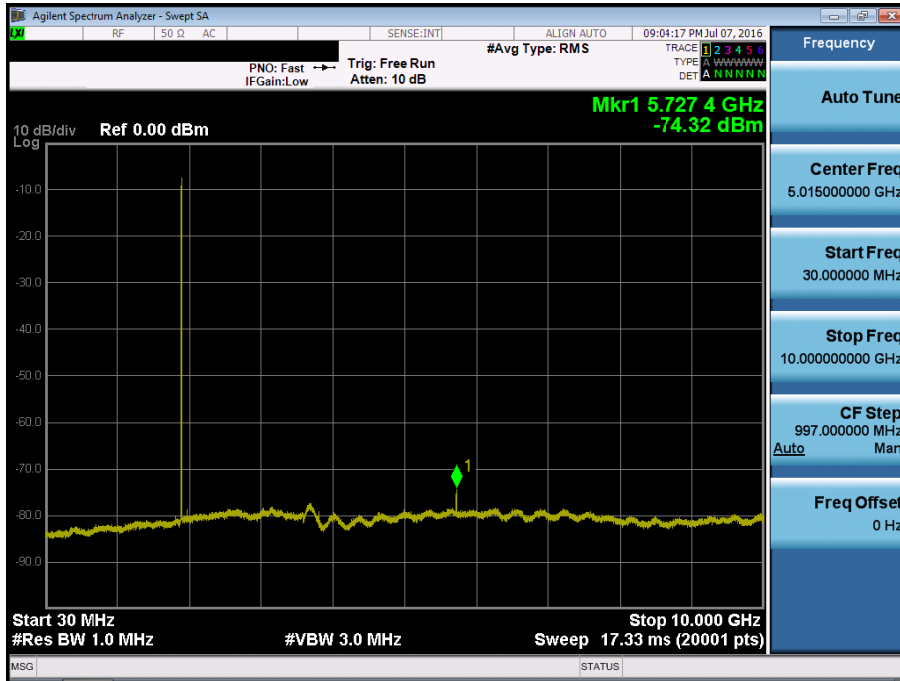

■ PCS\_Rev.0 MODE (1175 CH.) Conducted Spurious Emissions -2

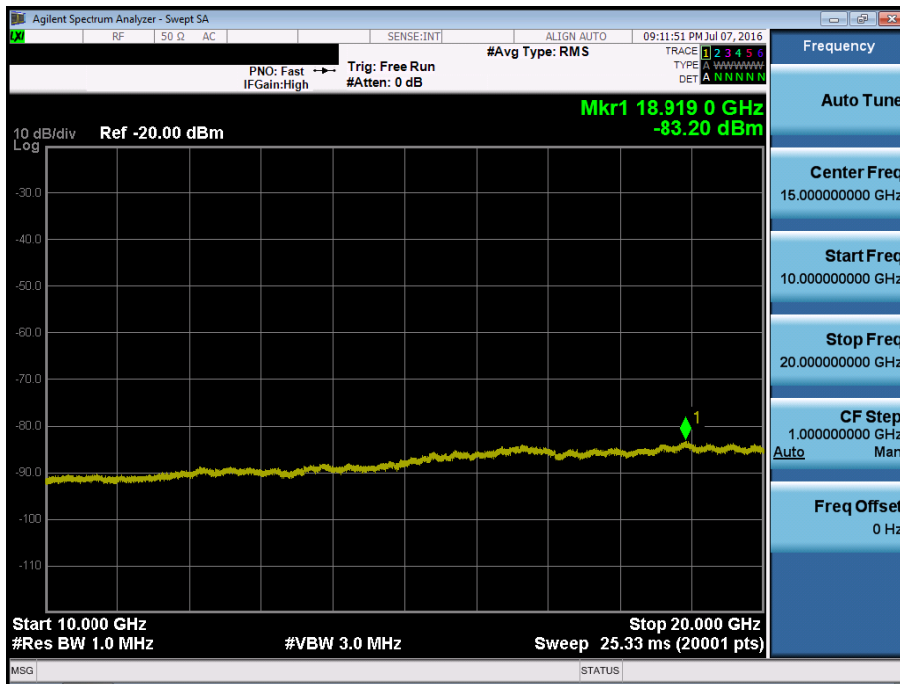

■ PCS\_ Rev.A MODE (25 CH.) Conducted Spurious Emissions -1

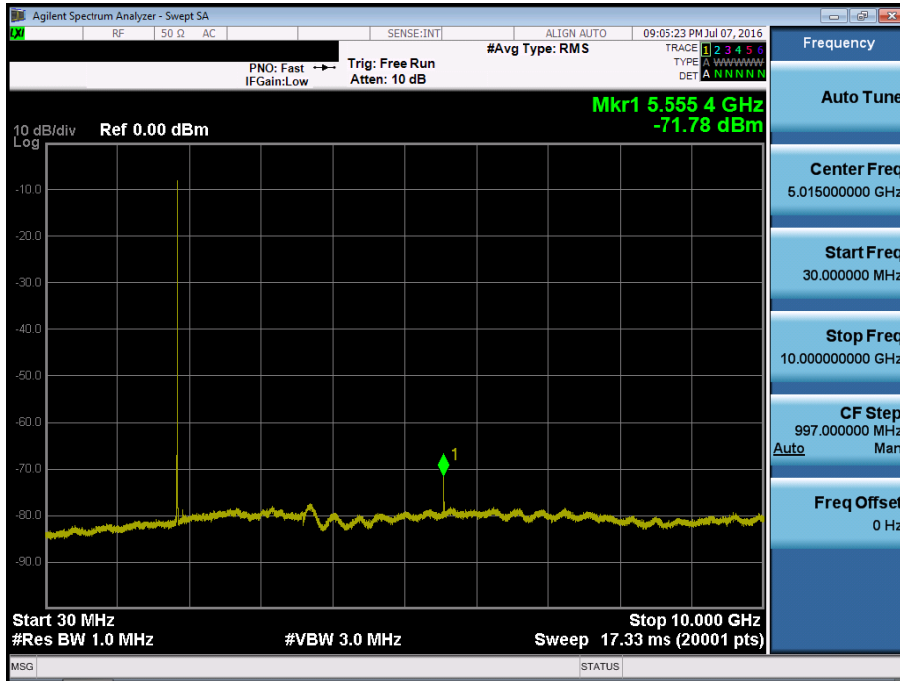

■ PCS\_ Rev.A MODE (25 CH.) Conducted Spurious Emissions -2

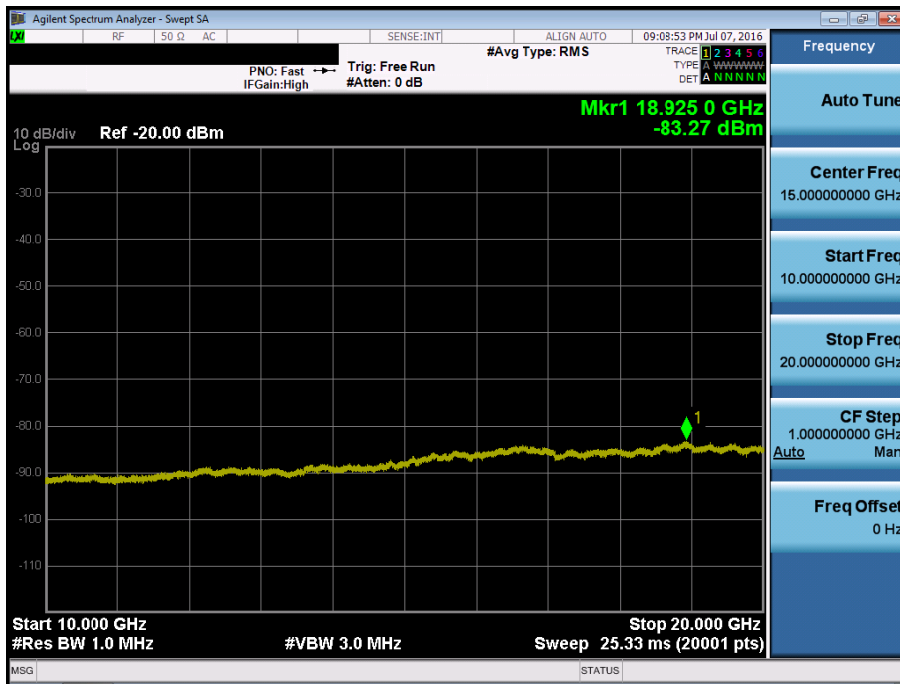

■ PCS\_ Rev.A MODE (600 CH.) Conducted Spurious Emissions -1

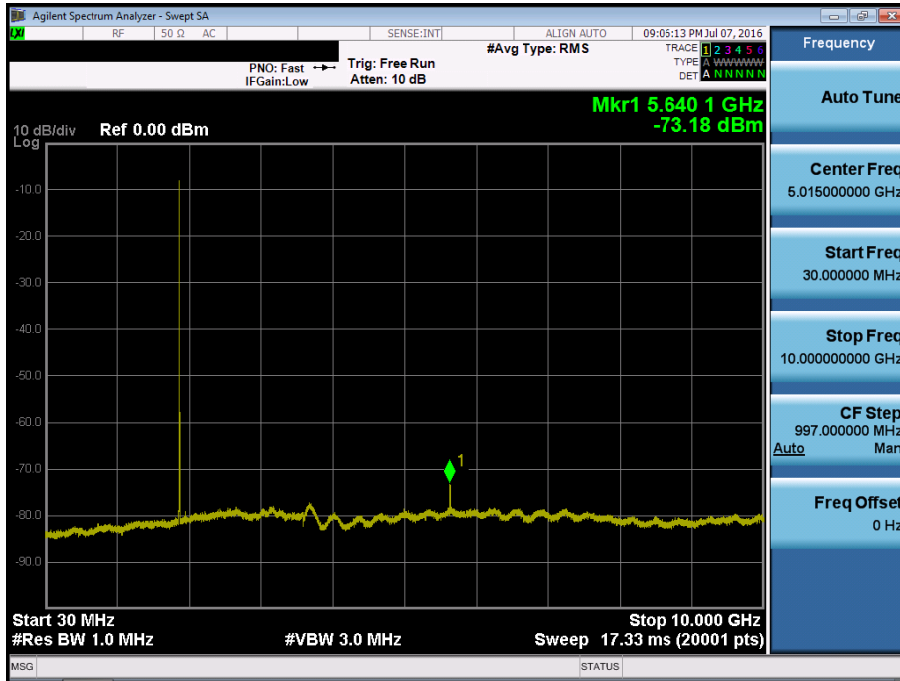

■ PCS\_ Rev.A MODE (600 CH.) Conducted Spurious Emissions -2

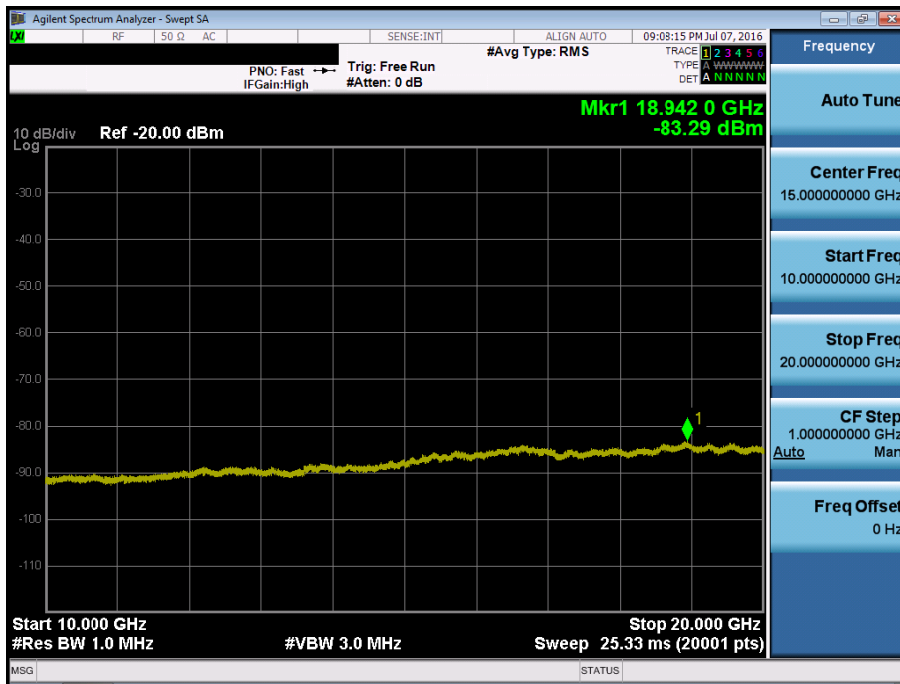

■ PCS\_ Rev.A MODE (1175 CH.) Conducted Spurious Emissions -1

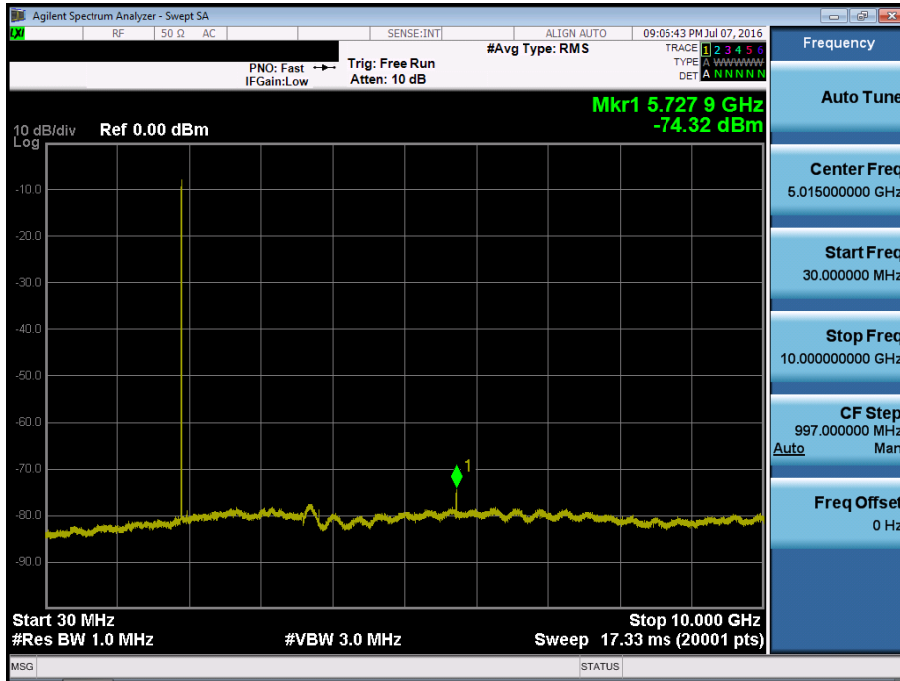

■ PCS\_ Rev.A MODE (1175 CH.) Conducted Spurious Emissions -2

