

FCC LTE REPORT

FCC Certification

Applicant Name:
Franklin Technology Inc.

Date of Issue:

July 11, 2016

Location:

HCT CO., LTD.,

Address:

906 JEI Platz, 186, Gasan digital 1-ro, Geumcheon-gu,
Seoul, Korea, (08502)

74, Seoicheon-ro 578beon-gil, Majang-myeon,
Icheon-si, Gyeonggi-do, 17383, Rep. of KOREA

Report No.: HCT-R-1607-F012

HCT FRN: 0005866421

FCC ID: XHG-U772S

APPLICANT: Franklin Technology Inc.

FCC Model(s): U772
EUT Type: LTE/CDMA USB Dongle
FCC Classification: PCS Licensed Transmitter (PCB)
FCC Rule Part(s): §24, §2

Mode (MHz)	Tx Frequency (MHz)	Emission Designator	Modulation	EIRP	
				Max. Power (W)	Max. Power (dBm)
LTE – Band25 (1.4)	1 850.7 – 1 914.3	1M10G7D	QPSK	0.139	21.44
		1M10W7D	16QAM	0.111	20.44
LTE – Band25 (3)	1 851.5 – 1 913.5	2M68G7D	QPSK	0.138	21.40
		2M68W7D	16QAM	0.110	20.41
LTE – Band25 (5)	1 852.5 – 1 912.5	4M51G7D	QPSK	0.142	21.53
		4M50W7D	16QAM	0.112	20.49
LTE – Band25 (10)	1 855.0 – 1 910.0	8M97G7D	QPSK	0.132	21.20
		8M94W7D	16QAM	0.107	20.29
LTE – Band25 (15)	1 857.5 – 1 907.5	13M5G7D	QPSK	0.131	21.17
		13M5W7D	16QAM	0.107	20.29
LTE – Band25 (20)	1 860.0 – 1 905.0	17M9G7D	QPSK	0.132	21.22
		18M0W7D	16QAM	0.108	20.32

The measurements shown in this report were made in accordance with the procedures specified in CFR47 section §2.947. I assume full responsibility for the accuracy and completeness of these measurements, and for the qualifications of all persons taking them.

HCT CO., LTD. Certifies that no party to this application has subject to a denial of Federal benefits that includes FCC benefits pursuant to section 5301 of the Anti-Drug Abuse Act of 1998, 21 U.S. C. 853(a)



Report prepared by
: Jeong Ho Kim
Test engineer of RF Team



Approved by
: Kyoung Houn Seo
Manager of RF Team

This report only responds to the tested sample and may not be reproduced, except in full, without written approval of the HCT Co., Ltd.

Report Revision

TEST REPORT NO.	DATE	DESCRIPTION
HCT-R-1607-F012	July 11, 2016	- First Approval Report

Table of Contents

1. GENERAL INFORMATION	4
2. INTRODUCTION	5
2.1. EUT DESCRIPTION.....	5
2.2. MEASURING INSTRUMENT CALIBRATION.....	5
2.3. TEST FACILITY	5
3. DESCRIPTION OF TESTS	6
3.1 EIRP RADIATED POWER AND RADIATED SPURIOUS EMISSIONS	6
3.2 PEAK-AVERAGE RATIO.	7
3.3 OCCUPIED BANDWIDTH.	8
3.4 SPURIOUS AND HARMONIC EMISSIONS AT ANTENNA TERMINAL.....	9
3.5 FREQUENCY RANGE (1850 MHz ~ 1915 MHz)	9
3.6 FREQUENCY STABILITY / VARIATION OF AMBIENT TEMPERATURE	10
4. LIST OF TEST EQUIPMENT	11
5. MEASUREMENT UNCERTAINTY	12
6. SUMMARY OF TEST RESULTS	13
7. SAMPLE CALCULATION.....	14
8. TEST DATA	15
8.1 EQUIVALENT ISOTROPIC RADIATED POWER (Band 25)	15
8.2 RADIATED SPURIOUS EMISSIONS (LTE Band 25).....	19
8.2.1 RADIATED SPURIOUS EMISSIONS(1.4 MHz Band 25 LTE).....	19
8.2.2 RADIATED SPURIOUS EMISSIONS (3 MHz Band 25 LTE).....	20
8.2.3 RADIATED SPURIOUS EMISSIONS (5 MHz Band 25 LTE).....	21
8.2.4 RADIATED SPURIOUS EMISSIONS (10 MHz Band 25 LTE).....	22
8.2.5 RADIATED SPURIOUS EMISSIONS (15 MHz Band 25 LTE).....	23
8.2.6 RADIATED SPURIOUS EMISSIONS (20 MHz Band 25 LTE).....	24
8.3 PEAK-TO-AVERAGE RATIO	25
8.4 OCCUPIED BANDWIDTH	26
8.5 CONDUCTED SPURIOUS EMISSIONS	27
7.5.1 BAND EDGE.....	27
8.6 FREQUENCY STABILITY / VARIATION OF AMBIENT TEMPERATURE	28
8.6.1 FREQUENCY STABILITY (1.4 MHz Band 25 LTE)	28
8.6.2 FREQUENCY STABILITY (3 MHz Band 25 LTE)	29
8.6.3 FREQUENCY STABILITY (5 MHz Band 25 LTE)	30
8.6.4 FREQUENCY STABILITY (10 MHz Band 25 LTE)	31
8.6.5 FREQUENCY STABILITY (15 MHz Band 25 LTE)	32
8.6.6 FREQUENCY STABILITY (20 MHz Band 25 LTE)	33
9. TEST PLOTS.....	34

MEASUREMENT REPORT

1. GENERAL INFORMATION

Applicant Name: Franklin Technology Inc.

Address: 906 JEI Platz, 186, Gasan digital 1-ro, Geumcheon-gu, Seoul, Korea, (08502)

FCC ID: XHG-U772S

Application Type: Certification

FCC Classification: PCS Licensed Transmitter (PCB)

FCC Rule Part(s): §24, §2

EUT Type: LTE/CDMA USB Dongle

FCC Model(s): U772

Tx Frequency: 1 850.7 MHz – 1 914.3 MHz (LTE – Band25 (1.4 MHz))
1 851.5 MHz – 1 913.5 MHz (LTE – Band25 (3 MHz))
1 852.5 MHz – 1 912.5 MHz (LTE – Band25 (5 MHz))
1 855.0 MHz – 1 910.0 MHz (LTE – Band25 (10 MHz))
1 857.5 MHz – 1 907.5 MHz (LTE – Band25 (15 MHz))
1 860.0 MHz – 1 905.0 MHz (LTE – Band25 (20 MHz))

Max. RF Output Power: Band 25 (1.4 MHz) : 0.139 W (QPSK) (21.44 dBm)
0.111 W (16-QAM) (20.44 dBm)
Band 25 (3 MHz) : 0.138 W (QPSK) (21.40 dBm)
0.110 W (16-QAM) (20.41 dBm)
Band 25 (5 MHz) : 0.142 W (QPSK) (21.53 dBm)
0.112 W (16-QAM) (20.49 dBm)
Band 25 (10 MHz) : 0.132 W (QPSK) (21.20 dBm)
0.107 W (16-QAM) (20.29 dBm)
Band 25 (15 MHz) : 0.131 W (QPSK) (21.17 dBm)
0.107 W (16-QAM) (20.29 dBm)
Band 25 (20 MHz) : 0.132 W (QPSK) (21.22 dBm)
0.108 W (16-QAM) (20.32 dBm)

Emission Designator(s): Band 25 (1.4 MHz) : 1M10G7D (QPSK) / 1M10W7D (16-QAM)
Band 25 (3 MHz) : 2M68G7D (QPSK) / 2M68W7D (16-QAM)
Band 25 (5 MHz) : 4M51G7D (QPSK) / 4M50W7D (16-QAM)
Band 25 (10 MHz) : 8M97G7D (QPSK) / 8M94W7D (16-QAM)
Band 25 (15 MHz) : 13M5G7D (QPSK) / 13M5W7D (16-QAM)
Band 25 (20 MHz) : 17M9G7D (QPSK) / 18M0W7D (16-QAM)

Date(s) of Tests: June 21, 2016 ~ July08, 2016

Antenna Specification Manufacturer: HUTEK Co.,ltd
Antenna type: Internal Antenna
Peak Gain: Band 25: 2.977dBi

2. INTRODUCTION

2.1. EUT DESCRIPTION

The Franklin Technology Inc.U772 LTE/CDMA USB Dongle consists of LTE 25.

2.2. MEASURING INSTRUMENT CALIBRATION

The measuring equipment, which was utilized in performing the tests documented herein, has been calibrated in accordance with the manufacturer's recommendations for utilizing calibration equipment, which is traceable to recognized national standards.

2.3. TEST FACILITY

The Fully-anechoic chamber and conducted measurement facility used to collect the radiated data are located at the **74, Seoicheon-ro 578beon-gil, Majang-myeon, Icheon-si, Gyeonggi-do, 17383, Rep. of KOREA.**

3. DESCRIPTION OF TESTS

3.1 EIRP RADIATED POWER AND RADIATED SPURIOUS EMISSIONS

Note: EIRP(Effective Isotropic Radiated Power)

Test Procedure

Radiated emission measurements are performed in the Fully-anechoic chamber. The equipment under test is placed on a non-conductive table 3-meters away from the receive antenna in accordance with ANSI/TIA-603-D-2010 Clause 2.2.17. The turntable is rotated through 360 degrees, and the receiving antenna scans in order to determine the level of the maximized emission. The level and position of the maximized emission is recorded with the spectrum analyzer using a RMS detector.

A half wave dipole is then substituted in place of the EUT. For emissions above 1GHz, a horn antenna is substituted in place of the EUT. The substitute antenna is driven by a signal generator and the previously recorded signal was duplicated.

The power is calculated by the following formula;

$$P_{d(\text{dBm})} = P_{g(\text{dBm})} - \text{cable loss}_{(\text{dB})} + \text{antenna gain}_{(\text{dB})}$$

Where: P_d is the dipole equivalent power and P_g is the generator output power into the substitution antenna.

The maximum EIRP is calculated by adding the forward power to the calibrated source plus its appropriate gain value. These steps are repeated with the receiving antenna in both vertical and horizontal polarization. the difference between the gain of the horn and an isotropic antenna are taken into consideration

Radiated spurious emissions

: Frequency Range : 30 MHz ~ 10th Harmonics of highest channel fundamental frequency.

3.2 PEAK-AVERAGE RATIO.

Test Procedure

Peak to Average Power Ratio is tested in accordance with KDB971168 D01 Power Meas License Digital Systems v02r02, October 17, 2014, Section 5.7.

- Section 5.7.1 CCDF Procedure

- a) Set resolution/measurement bandwidth \geq signal's occupied bandwidth;
- b) Set the number of counts to a value that stabilizes the measured CCDF curve;
- c) Set the measurement interval as follows:
 - 1) for continuous transmissions, set to 1 ms,
 - 2) for burst transmissions, employ an external trigger that is synchronized with the EUT burst timing sequence, or use the internal burst trigger with a trigger level that allows the burst to stabilize and set the measurement interval to a time that is less than or equal to the burst duration.
- d) Record the maximum PAPR level associated with a probability of 0.1%.

- Section 5.7.2 Alternate Procedure

Use one of the procedures presented in 5.1 to measure the total peak power and record as P_{Pk} . Use one of the applicable procedures presented 5.2 to measure the total average power and record as P_{Avg} . Determine the P.A.R. from: $P.A.R_{(dB)} = P_{Pk(dBm)} - P_{Avg(dBm)}$ (P_{Avg} = Average Power + Duty cycle Factor)

5.1.1 Peak power measurements with a spectrum/signal analyzer or EMI receiver

The following procedure can be used to determine the total peak output power.

- a) Set the RBW \geq OBW.
- b) Set VBW $\geq 3 \times$ RBW.
- c) Set span $\geq 2 \times$ RBW
- d) Sweep time = auto couple.
- e) Detector = peak.
- f) Ensure that the number of measurement points \geq span/RBW.
- g) Trace mode = max hold.
- h) Allow trace to fully stabilize.
- i) Use the peak marker function to determine the peak amplitude level.

3.3 OCCUPIED BANDWIDTH.

Test set-up

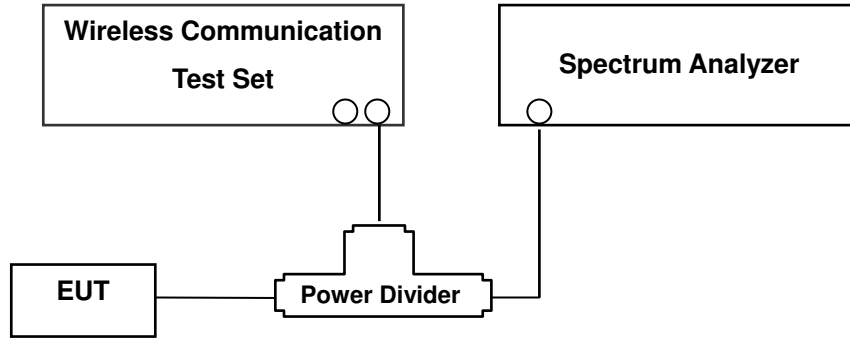

(Configuration of conducted Emission measurement)

The width of a frequency band such that, below the lower and above the upper frequency limits, the mean powers emitted are each equal to a specified percentage 0.5 % of the total mean power of a given emission.

Test Procedure

OBW is tested in accordance with KDB971168 D01 Power Meas License Digital Systems v02r02, October 17, 2014, Section 4.2.

The EUT makes a call to the communication simulator. The power was measured with R&S Spectrum Analyzer. All measurements were done at 3 channels(low, middle and high operational range.)

The conducted occupied bandwidth used the power splitter via EUT RF power connector between simulation base station and spectrum analyzer.

The communication simulator station system controlled a EUT to export maximum output power under transmission mode and specific channel frequency. Use OBW measurement function of Spectrum analyzer to measure 99 % occupied bandwidth

3.4 SPURIOUS AND HARMONIC EMISSIONS AT ANTENNA TERMINAL.

Test Procedure

Spurious and harmonic emissions at antenna terminal is tested in accordance with KDB971168 D01 Power Meas License Digital Systems v02r02, October 17, 2014, Section 6.0.

The level of the carrier and the various conducted spurious and harmonic frequencies is measured by means of a calibrated spectrum analyzer.

The EUT was setup to maximum output power at its lowest channel. The Resolution BW of the analyzer is set to 1 % of the emission bandwidth to show compliance with the -13 dBm limit, in the 1 MHz bands immediately outside and adjacent to the edge of the frequency block. The 1 MHz RBW was used to scan from 30 MHz to 26.5 GHz. A display line was placed at -13 dBm to show compliance. The high, lowest and a middle channel were tested for out of band measurements.

- Band Edge Requirement : In the 1MHz bands immediately outside and adjacent to the frequency block, a resolution bandwidth of at least 1 percent of the emission bandwidth of the fundamental emission of the transmitter may be employed to measure the out of band Emissions. Limit, -13dBm.

NOTES: The analyzer plot offsets were determined by below conditions.

- For LTE Band 25, total offset 27.0dBm = 20 dBm attenuator + 6 dBm Divider + 1.0dBm RF cables.

3.5 FREQUENCY RANGE (1850 MHz ~ 1915 MHz)

Subpart E—Broadband PCS

§ 24.229

(a) The following frequency blocks are available for assignment on an MTA basis:

Block A: 1850–1865 MHz paired with 1930–1945 MHz;

Block B: 1870–1885 MHz paired with 1950–1965 MHz.

(b) The following frequency blocks are available for assignment on a BTA basis:

Block C: 1895–1910 MHz paired with 1975–1990 MHz;

Block D: 1865–1870 MHz paired with 1945–1950 MHz;

Block E: 1885–1890 MHz paired with 1965–1970 MHz;

Block F: 1890–1895 MHz paired with 1970–1975 MHz;

(c) 1910-1915 MHz paired with 1990-1995 MHz

3.6 FREQUENCY STABILITY / VARIATION OF AMBIENT TEMPERATURE

Test Set-up

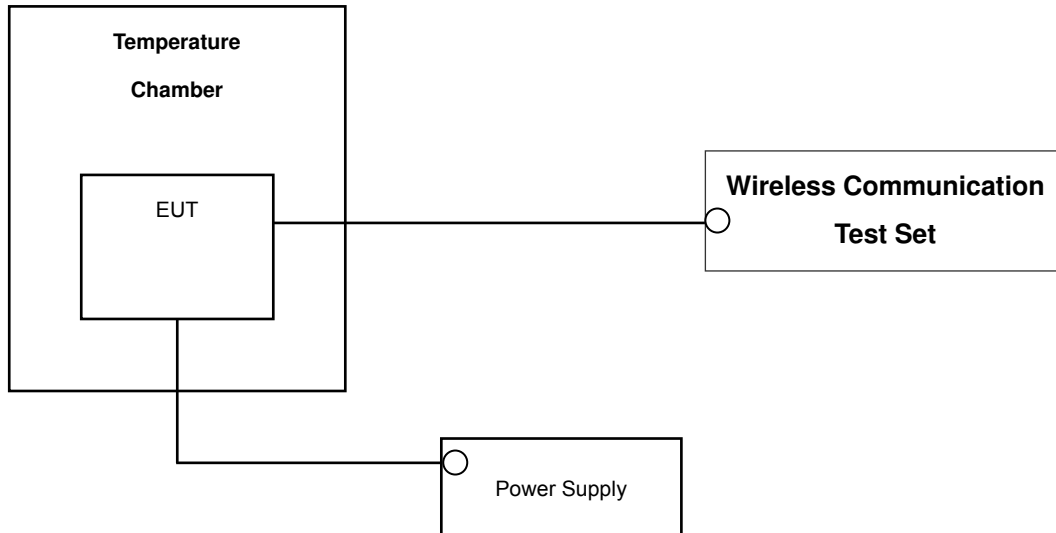

* Nominal Operating Voltage

Test Procedure

Frequency stability is tested in accordance with ANSI/TIA-603-D-2010 section 2.2.2

The frequency stability of the transmitter is measured by:

- a.) **Temperature:** The temperature is varied from - 30 °C to + 50 °C using an environmental chamber.
- b.) **Primary Supply Voltage:** The primary supply voltage is varied from the end point to 100 % of the voltage normally at the input to the device or at the power supply terminals if cables are not normally supplied.

Specification — the frequency stability shall be sufficient to ensure that the fundamental emission stays within the authorized frequency block.

Time Period and Procedure:

The carrier frequency of the transmitter is measured at room temperature (20°C to provide a reference).

1. The equipment is turned on in a “standby” condition for one minute before applying power to the transmitter. Measurement of the carrier frequency of the transmitter is made within one minute after applying power to the transmitter.
2. Frequency measurements are made at 10°C intervals ranging from -30°C to +50°C. A period of at least one half-hour is provided to allow stabilization of the equipment at each temperature level.

NOTE: The EUT is tested down to the battery endpoint.

4. LIST OF TEST EQUIPMENT

Manufacture	Model/ Equipment	Serial Number	Calibration Interval	Calibration Due
CERNEX	CBLU1183540B-01/ POWER AMP	25540	Annual	05/13/2017
Wainwright	WHKX 10-900-1000-15000-40SS/H.P.F	5	Annual	08/11/2016
Wainwright	WHKX10-2700-3000-18000-40SS/H.P.F	3	Annual	08/05/2016
Hewlett Packard	11667B / Power Splitter	10545	Annual	02/15/2017
Hewlett Packard	11667B / Power Splitter	11275	Annual	04/29/2017
ITECH	IT6720/ Power Supply	0100215626700119	Annual	11/02/2016
Schwarzbeck	UHAP/ Dipole Antenna	557	Biennial	03/23/2017
Schwarzbeck	UHAP/ Dipole Antenna	558	Biennial	03/23/2017
EXP	EX-TH400/ Chamber	None	Annual	05/31/2017
Schwarzbeck	BBHA 9120D/ Horn Antenna	9210D-1298	Biennial	10/16/2016
Schwarzbeck	BBHA 9120D/ Horn Antenna	9210D-1299	Biennial	10/16/2016
Schwarzbeck	BBHA 9170/ Horn Antenna(15~40GHz)	BBHA9170342	Biennial	04/30/2017
Schwarzbeck	BBHA 9170/ Horn Antenna(15~35GHz)	BBHA9170124	Biennial	04/30/2017
Agilent	N9020A/Signal Analyzer	MY52090906	Annual	05/13/2017
Hewlett Packard	8493C/ATTENUATOR	17280	Annual	06/22/2017
REOHDE&SCHWARZ	FSV40-N/Signal Analyzer	101068-SZ	Annual	09/23/2016
Agilent	8960 (E5515C)/ Base Station	MY48360800	Annual	10/30/2016
Anritsu Corp.	MT8820C/Wideband Radio Communication Tester	6200863156	Annual	02/26/2017
Anritsu Corp.	MT8820C/Wideband Radio Communication Tester	6201026545	Annual	02/16/2017
Schwarzbeck	VULB9160/ Bilog Antenna	3150	Biennial	11/17/2016
Schwarzbeck	VULB9160/ Bilog Antenna	3368	Biennial	10/10/2016

5. MEASUREMENT UNCERTAINTY

The measurement uncertainties shown below were calculated in accordance with the requirements of ANSI C63.4:2014.

All measurement uncertainty values are shown with a coverage factor of $k = 2$ to indicate a 95 % level of confidence. The measurement data shown herein meets or exceeds the U_{CISPR} measurement uncertainty values specified in CISPR 16-4-2 and, thus, can be compared directly to specified limits to determine compliance.

Parameter	Expanded Uncertainty (\pm dB)
Conducted Disturbance (150 kHz ~ 30 MHz)	1.82
Radiated Disturbance (9 kHz ~ 30 MHz)	3.40
Radiated Disturbance (30 MHz ~ 1 GHz)	4.80
Radiated Disturbance (1 GHz ~ 18 GHz)	6.07

6. SUMMARY OF TEST RESULTS

FCC Part Section(s)	Test Description	Test Limit	Test Condition	Test Result
2.1049	Occupied Bandwidth	N/A	CONDUCTED	PASS
2.1051, 24.238(a)	Band Edge / Spurious and Harmonic Emissions at Antenna Terminal.	< 43 + 10log ₁₀ (P[Watts]) at Band Edge and for all out-of-band emissions		PASS
2.1046	*Conducted Output Power	N/A		PASS
24.232(d)	Peak- to- Average Ratio	< 13 dB		PASS
2.1055, 24.235	Frequency stability / variation of ambient temperature	Emission must remain in band		PASS
24.232(c)	Equivalent Isotropic Radiated Power	< 2 Watts max. EIRP	RADIATED	PASS
2.1053, 24.238(a)	Radiated Spurious and Harmonic Emissions	< 43 + 10log ₁₀ (P[Watts]) for all out-of band emissions		PASS

*: See SAR Report

7. SAMPLE CALCULATION

A. EIRP Sample Calculation

Mode	Ch./ Freq.		Measured Level(dBm)	Substitute LEVEL(dBm)	Ant. Gain (dBi)	C.L	Pol.	Limit W	EIRP	
	channel	Freq.(MHz)							W	dBm
LTE25	26365	1882.5	-17.72	14.03	9.91	1.47	V	< 2.00	0.176	22.47

EIRP = Substitute LEVEL(dBm) + Ant. Gain – CL(Cable Loss)

- 1) The EUT mounted on a wooden tripod is 2.5 meter above test site ground level.
- 2) During the test , the turn table is rotated until the maximum signal is found.
- 3) Record the field strength meter's level.
- 4) Replace the EUT with dipole/Horn antenna that is connected to a calibrated signal generator.
- 5) Increase the signal generator output till the field strength meter's level is equal to the item (3).
- 6) The signal generator output level with Ant. Gain and cable loss are the rating of equivalent isotropic radiated power(EIRP).

B. Emission Designator

QPSK Modulation

5MHz Bandwidth

Emission Designator = 4M48G7D

LTE BW = 4.48 MHz

G = Phase Modulation

7 = Quantized/Digital Info

D = Data transmission; telemetry; telecommand

10MHz Bandwidth

Emission Designator = 8M95G7D

LTE BW = 8.95 MHz

G = Phase Modulation

7 = Quantized/Digital Info

D = Data transmission; telemetry; telecommand

16QAM Modulation

5MHz Bandwidth

Emission Designator = 4M48W7D

LTE BW = 4.48 MHz

W = main carrier modulated in a combination of two or more of the following modes;
amplitude, angle, pulse

7 = Quantized/Digital Info

D = Data transmission; telemetry; telecommand

10MHz Bandwidth

Emission Designator = 8M95W7D

LTE BW = 8.95 MHz

W = main carrier modulated in a combination of two or more of the following modes;
amplitude, angle, pulse

7 = Quantized/Digital Info

D = Data transmission; telemetry; telecommand

8. TEST DATA

8.1 EQUIVALENT ISOTROPIC RADIATED POWER (Band 25)

Freq (MHz)	Bandwidth	Modulation	Measured Level (dBm)	Substitute Level (dBm)	Ant. Gain(dBi)	C.L	Pol	Limit	EIRP	
								W	W	dBm
1850.7	1.4 MHz	QPSK	-20.24	13.73	9.82	2.42	H	< 2.00	0.130	21.13
		16-QAM	-21.18	12.79	9.82	2.42	H		0.104	20.19
1882.5		QPSK	-20.13	13.70	9.91	2.45	H		0.131	21.16
		16-QAM	-21.04	12.79	9.91	2.45	H		0.106	20.25
1914.3		QPSK	-20.23	13.88	10.02	2.46	H		0.139	21.44
		16-QAM	-21.23	12.88	10.02	2.46	H		0.111	20.44

Equivalent Isotropic Radiated Power Data (1.4 MHz Band 25 LTE)

Note: All of RB size has been tested for emissions and EIRP, with the 1RB configuration observed as the worst case

Freq (MHz)	Bandwidth	Modulation	Measured Level (dBm)	Substitute Level (dBm)	Ant. Gain(dBi)	C.L	Pol	Limit	EIRP	
								W	W	dBm
1851.5	3 MHz	QPSK	-20.33	13.64	9.82	2.42	H	< 2.00	0.127	21.04
		16-QAM	-21.05	12.92	9.82	2.42	H		0.108	20.32
1882.5		QPSK	-19.89	13.94	9.91	2.45	H		0.138	21.40
		16-QAM	-20.88	12.95	9.91	2.45	H		0.110	20.41
1913.5		QPSK	-20.43	13.27	10.00	2.46	H		0.120	20.81
		16-QAM	-21.40	12.30	10.00	2.46	H		0.096	19.84

Equivalent Isotropic Radiated Power Data (3 MHz Band 25 LTE)

Note: All of RB size has been tested for emissions and EIRP, with the 1RB configuration observed as the worst case

Freq (MHz)	Bandwidth	Modulation	Measured Level (dBm)	Substitute Level (dBm)	Ant. Gain(dBi)	C.L	Pol	Limit	EIRP	
								W	W	dBm
1852.5	5 MHz	QPSK	-20.11	13.86	9.82	2.42	H	< 2.00	0.134	21.26
		16-QAM	-21.06	12.91	9.82	2.42	H		0.107	20.31
1882.5		QPSK	-19.76	14.07	9.91	2.45	H		0.142	21.53
		16-QAM	-20.80	13.03	9.91	2.45	H		0.112	20.49
1912.5		QPSK	-20.02	13.68	10.00	2.46	H		0.132	21.22
		16-QAM	-20.98	12.72	10.00	2.46	H		0.106	20.26

Equivalent Isotropic Radiated Power Data (5 MHz Band 25 LTE)

Note: All of RB size has been tested for emissions and EIRP, with the 1RB configuration observed as the worst case

Freq (MHz)	Bandwidth	Modulation	Measured Level (dBm)	Substitute Level (dBm)	Ant. Gain(dBi)	C.L	Pol	Limit	EIRP	
								W	W	dBm
1855.0	10 MHz	QPSK	-20.16	13.77	9.84	2.42	H	< 2.00	0.131	21.19
		16-QAM	-21.06	12.87	9.84	2.42	H		0.107	20.29
1882.5		QPSK	-20.09	13.74	9.91	2.45	H		0.132	21.20
		16-QAM	-21.10	12.73	9.91	2.45	H		0.104	20.19
1910.0		QPSK	-21.02	12.68	10.00	2.46	H		0.105	20.22
		16-QAM	-22.05	11.65	10.00	2.46	H		0.083	19.19

Equivalent Isotropic Radiated Power Data (10 MHz Band 25 LTE)

Note: All of RB size has been tested for emissions and EIRP, with the 1RB configuration observed as the worst case

Freq (MHz)	Bandwidth	Modulation	Measured Level (dBm)	Substitute Level (dBm)	Ant. Gain(dBi)	C.L	Pol	Limit	EIRP	
								W	W	dBm
1857.5	15 MHz	QPSK	-20.16	13.74	9.85	2.42	H	< 2.00	0.131	21.17
		16-QAM	-21.04	12.86	9.85	2.42	H		0.107	20.29
1882.5		QPSK	-20.44	13.39	9.91	2.45	H		0.122	20.85
		16-QAM	-21.48	12.35	9.91	2.45	H		0.096	19.81
1907.5		QPSK	-20.57	13.13	10.00	2.46	H		0.117	20.67
		16-QAM	-21.73	11.97	10.00	2.46	H		0.089	19.51

Equivalent Isotropic Radiated Power Data (15 MHz Band 25 LTE)

Note: All of RB size has been tested for emissions and EIRP, with the 1RB configuration observed as the worst case

Freq (MHz)	Bandwidth	Modulation	Measured Level (dBm)	Substitute Level (dBm)	Ant. Gain(dBi)	C.L	Pol	Limit	EIRP	
								W	W	dBm
1860.0	20 MHz	QPSK	-20.12	13.78	9.85	2.42	H	< 2.00	0.132	21.21
		16-QAM	-21.07	12.83	9.85	2.42	H		0.106	20.26
1882.5		QPSK	-20.07	13.76	9.91	2.45	H		0.132	21.22
		16-QAM	-20.97	12.86	9.91	2.45	H		0.108	20.32
1905.0		QPSK	-20.58	13.31	9.99	2.45	H		0.121	20.84
		16-QAM	-21.57	12.32	9.99	2.45	H		0.097	19.85

Equivalent Isotropic Radiated Power Data (20 MHz Band 25 LTE)

Note: All of RB size has been tested for emissions and EIRP, with the 1RB configuration observed as the worst case

NOTES:

Equivalent Isotropic Radiated Power Measurements by Substitution Method according to ANSI/TIA/EIA-603-D-2010 June 24, 2010:

The EUT was placed on a non-conductive styrofoam resin table 3-meters from the receive antenna. The receive antenna height and turntable rotation was adjusted for the highest reading on the receive spectrum analyzer. For LTE signals, RBW = 1-5% of the OBW, not to exceed 1MHz, VBW ≥ 3 x RBW, Detector = RMS. A half-wave dipole was substituted in place of the EUT. This dipole antenna was driven by a signal generator and the level of the signal generator was adjusted to obtain the same receive spectrum analyzer reading. The conducted power at the terminals of the Horn antenna is measured. The difference between the gain of the

horn and an isotropic antenna is taken into consideration and the EIRP is recorded.

Also, we have done x, y, z planes in EUT and horizontal and vertical polarization in detecting antenna. The worst case of the EUT is z plane in LTE mode. Also worst case of detecting Antenna is horizontal polarization in LTE mode.

8.2 RADIATED SPURIOUS EMISSIONS (LTE Band 25)

8.2.1 RADIATED SPURIOUS EMISSIONS(1.4 MHz Band 25 LTE)

- ▣ OPERATING FREQUENCY: 1914.30 MHz
- ▣ MEASURED OUTPUT POWER: 21.44dBm = 0.139 W
- ▣ MODULATION SIGNAL: 1.4 MHz QPSK
- ▣ DISTANCE: 3 meters
- ▣ LIMIT: $43 + 10 \log_{10}(W) =$ 34.44dBc

Ch	Freq (MHz)	Measured Level (dBm)	Ant. Gain (dBi)	Substitute Level (dBm)	C.L	Pol	EIRP (dBm)	dBc
26047 (1850.7)	3,701.40	-54.71	12.52	-57.91	3.41	H	-48.80	70.24
	5,552.10	-55.70	13.29	-53.86	4.78	H	-45.35	66.79
	7,402.80	-48.49	11.72	-39.40	5.58	V	-33.26	54.70
	9,253.50	-56.20	11.45	-41.47	6.37	H	-36.39	57.83
26365 (1882.5)	3,765.00	-55.07	12.56	-58.32	3.50	H	-49.26	70.70
	5,647.50	-55.14	13.30	-53.60	4.80	H	-45.10	66.54
	7,530.00	-51.65	11.69	-43.22	5.69	V	-37.22	58.66
26683 (1914.3)	3,828.60	-54.99	12.61	-58.05	3.55	H	-48.99	70.43
	5,742.90	-51.54	13.32	-49.29	4.81	H	-40.78	62.22
	7,657.20	-52.99	11.59	-44.80	5.60	V	-38.81	60.25
	9,571.50	-48.60	11.33	-35.48	6.51	H	-30.66	52.10

- NOTES:**
1. Radiated Spurious Emission Measurements at 3 meters by Substitution Method according to ANSI/TIA/EIA-603-D-2010 June 24, 2010:
 2. We are performed all frequency to 10th harmonics from 30 MHz. Measurements above show only up to 3 maximum emissions noted, or would be lesser if no specific emissions from the EUT are recorded (ie: margin > 20 dB from the applicable limit) and considered that's already beyond the background noise floor.
 3. we have done x, y, z planes in EUT and horizontal and vertical polarization in detecting antenna.
 4. All of RB size has been tested for emissions and EIRP, with the 1RB configuration observed as the worst case
 5. We are performed 16QAM and QPSK modulations. The worst case data are reported in the table above.

8.2.2 RADIATED SPURIOUS EMISSIONS (3 MHz Band 25 LTE)

- ▣ OPERATING FREQUENCY: 1882.50 MHz
- ▣ MEASURED OUTPUT POWER: 21.40dBm = 0.138 W
- ▣ MODULATION SIGNAL: 3 MHz QPSK
- ▣ DISTANCE: 3 meters
- ▣ LIMIT: $43 + 10 \log_{10}(W) =$ 34.40dBc

Ch	Freq (MHz)	Measured Level (dBm)	Ant. Gain (dBi)	Substitute Level (dBm)	C.L	Pol	EIRP (dBm)	dBc
26055 (1851.5)	3,703.00	-53.50	12.52	-56.82	3.43	H	-47.73	69.13
	5,554.50	-55.93	13.29	-54.24	4.81	H	-45.76	67.16
	7,406.00	-47.67	11.72	-38.70	5.57	V	-32.55	53.95
	9,257.50	-54.87	11.49	-41.51	6.32	H	-36.34	57.74
26365 (1882.5)	3,765.00	-54.65	12.56	-57.90	3.50	H	-48.84	70.24
	5,647.50	-56.27	13.30	-54.73	4.80	H	-46.23	67.63
	7,530.00	-50.78	11.69	-42.35	5.69	V	-36.35	57.75
26675 (1913.5)	3,827.00	-53.54	12.61	-56.60	3.55	H	-47.54	68.94
	5,740.50	-54.66	13.32	-52.41	4.81	V	-43.90	65.30
	7,654.00	-52.02	11.60	-43.90	5.59	V	-37.89	59.29
	9,567.50	-49.10	11.34	-35.44	6.49	H	-30.59	51.99

- NOTES:**
1. Radiated Spurious Emission Measurements at 3 meters by Substitution Method according to ANSI/TIA/EIA-603-D-2010 June 24, 2010:
 2. We are performed all frequency to 10th harmonics from 30 MHz. Measurements above show only up to 3 maximum emissions noted, or would be lesser if no specific emissions from the EUT are recorded (ie: margin > 20 dB from the applicable limit) and considered that's already beyond the background noise floor.
 3. we have done x, y, z planes in EUT and horizontal and vertical polarization in detecting antenna.
 4. All of RB size has been tested for emissions and EIRP, with the 1RB configuration observed as the worst case
 5. We are performed 16QAM and QPSK modulations. The worst case data are reported in the table above.

8.2.3 RADIATED SPURIOUS EMISSIONS (5 MHz Band 25 LTE)

- ▣ OPERATING FREQUENCY: 1882.50 MHz
- ▣ MEASURED OUTPUT POWER: 21.53dBm = 0.142 W
- ▣ MODULATION SIGNAL: 5 MHz QPSK
- ▣ DISTANCE: 3 meters
- ▣ LIMIT: $43 + 10 \log_{10}(W) =$ 34.53dBc

Ch	Freq (MHz)	Measured Level (dBm)	Ant. Gain (dBi)	Substitute Level (dBm)	C.L	Pol	EIRP (dBm)	dBc
26065 (1852.5)	3,705.00	-55.32	12.52	-58.64	3.43	V	-49.55	71.08
	5,557.50	-56.53	13.29	-55.00	4.83	H	-46.54	68.07
	7,410.00	-50.63	11.72	-41.66	5.57	V	-35.51	57.04
26365 (1882.5)	3,765.00	-53.92	12.56	-57.17	3.50	H	-48.11	69.64
	5,647.50	-55.41	13.30	-53.87	4.80	H	-45.37	66.90
	7,530.00	-49.95	11.69	-41.52	5.69	V	-35.52	57.05
26665 (1912.5)	3,825.00	-53.94	12.60	-56.85	3.57	H	-47.81	69.34
	5,737.50	-55.18	13.32	-52.93	4.81	H	-44.42	65.95
	7,650.00	-48.89	11.60	-40.77	5.59	V	-34.76	56.29
	9,562.50	-50.89	11.34	-36.69	6.46	H	-31.81	53.34

- NOTES:**
1. Radiated Spurious Emission Measurements at 3 meters by Substitution Method according to ANSI/TIA/EIA-603-D-2010 June 24, 2010:
 2. We are performed all frequency to 10th harmonics from 30 MHz. Measurements above show only up to 3 maximum emissions noted, or would be lesser if no specific emissions from the EUT are recorded (ie: margin > 20 dB from the applicable limit) and considered that's already beyond the background noise floor.
 3. we have done x, y, z planes in EUT and horizontal and vertical polarization in detecting antenna.
 4. All of RB size has been tested for emissions and EIRP, with the 1RB configuration observed as the worst case
 5. We are performed 16QAM and QPSK modulations. The worst case data are reported in the table above.

8.2.4 RADIATED SPURIOUS EMISSIONS (10 MHz Band 25 LTE)

- ▣ OPERATING FREQUENCY: 1855.00 MHz
- ▣ MEASURED OUTPUT POWER: 21.20dBm = 0.132 W
- ▣ MODULATION SIGNAL: 10 MHz QPSK
- ▣ DISTANCE: 3 meters
- ▣ LIMIT: $43 + 10 \log_{10}(W) =$ 34.20dBc

Ch	Freq (MHz)	Measured Level (dBm)	Ant. Gain (dBi)	Substitute Level (dBm)	C.L	Pol	EIRP (dBm)	dBc
26090 (1855.0)	3,710.00	-53.39	12.52	-56.84	3.45	H	-47.77	68.97
	5,565.00	-56.11	13.29	-54.65	4.81	H	-46.17	67.37
	7,420.00	-51.15	11.72	-42.33	5.64	V	-36.25	57.45
	9,275.00	-54.40	11.48	-40.42	6.36	H	-35.30	56.50
26365 (1882.5)	3,765.00	-53.75	12.56	-57.00	3.50	H	-47.94	69.14
	5,647.50	-55.70	13.30	-54.16	4.80	H	-45.66	66.86
	7,530.00	-50.46	11.69	-42.03	5.69	V	-36.03	57.23
	9,412.50	-55.68	11.42	-40.85	6.42	H	-35.85	57.05
26640 (1910.0)	3,820.00	-51.98	12.60	-54.75	3.58	H	-45.73	66.93
	5,730.00	-54.14	13.31	-52.13	4.84	H	-43.66	64.86
	7,640.00	-47.35	11.61	-39.18	5.62	V	-33.19	54.39
	9,550.00	-52.26	11.35	-39.40	6.43	H	-34.48	55.68

- NOTES:**
1. Radiated Spurious Emission Measurements at 3 meters by Substitution Method according to ANSI/TIA/EIA-603-D-2010 June 24, 2010:
 2. We are performed all frequency to 10th harmonics from 30 MHz. Measurements above show only up to 3 maximum emissions noted, or would be lesser if no specific emissions from the EUT are recorded (ie: margin > 20 dB from the applicable limit) and considered that's already beyond the background noise floor.
 3. we have done x, y, z planes in EUT and horizontal and vertical polarization in detecting antenna.
 4. All of RB size has been tested for emissions and EIRP, with the 1RB configuration observed as the worst case
 5. We are performed 16QAM and QPSK modulations. The worst case data are reported in the table above.

8.2.5 RADIATED SPURIOUS EMISSIONS (15 MHz Band 25 LTE)

- ▣ OPERATING FREQUENCY: 1857.50 MHz
- ▣ MEASURED OUTPUT POWER: 21.17dBm = 0.131 W
- ▣ MODULATION SIGNAL: 15 MHz QPSK
- ▣ DISTANCE: 3 meters
- ▣ LIMIT: $43 + 10 \log_{10}(W) =$ 34.17dBc

Ch	Freq (MHz)	Measured Level (dBm)	Ant. Gain (dBi)	Substitute Level (dBm)	C.L	Pol	EIRP (dBm)	dBc
26115 (1857.5)	3,715.00	-55.75	12.52	-59.30	3.44	H	-50.22	71.39
	5,572.50	-56.38	13.29	-55.00	4.79	H	-46.50	67.67
	7,430.00	-50.99	11.72	-41.62	5.56	V	-35.46	56.63
	9,287.50	-54.99	11.48	-40.76	6.39	H	-35.67	56.84
26365 (1882.5)	3,765.00	-53.43	12.56	-56.68	3.50	H	-47.62	68.79
	5,647.50	-55.94	13.30	-54.40	4.80	V	-45.90	67.07
	7,530.00	-55.16	11.69	-46.73	5.69	V	-40.73	61.90
	9,412.50	-49.77	11.42	-34.94	6.42	H	-29.94	51.11
26615 (1907.5)	3,815.00	-53.76	12.60	-56.53	3.55	H	-47.48	68.65
	5,722.50	-53.98	13.31	-52.06	4.83	H	-43.58	64.75
	7,630.00	-53.88	11.62	-45.63	5.63	H	-39.64	60.81
	9,537.50	-51.75	11.36	-37.77	6.49	H	-32.90	54.07

- NOTES:**
1. Radiated Spurious Emission Measurements at 3 meters by Substitution Method according to ANSI/TIA/EIA-603-D-2010 June 24, 2010:
 2. We are performed all frequency to 10th harmonics from 30 MHz. Measurements above show only up to 3 maximum emissions noted, or would be lesser if no specific emissions from the EUT are recorded (ie: margin > 20 dB from the applicable limit) and considered that's already beyond the background noise floor.
 3. we have done x, y, z planes in EUT and horizontal and vertical polarization in detecting antenna.
 4. All of RB size has been tested for emissions and EIRP, with the 1RB configuration observed as the worst case
 5. We are performed 16QAM and QPSK modulations. The worst case data are reported in the table above.

8.2.6 RADIATED SPURIOUS EMISSIONS (20 MHz Band 25 LTE)

- ▣ OPERATING FREQUENCY: 1882.50 MHz
- ▣ MEASURED OUTPUT POWER: 21.22dBm = 0.132 W
- ▣ MODULATION SIGNAL: 20 MHz QPSK
- ▣ DISTANCE: 3 meters
- ▣ LIMIT: $43 + 10 \log_{10}(W) =$ 34.22dBc

Ch	Freq (MHz)	Measured Level (dBm)	Ant. Gain (dBi)	Substitute Level (dBm)	C.L	Pol	EIRP (dBm)	dBc
26140 (1860.0)	3,720.00	-54.38	12.53	-58.05	3.43	V	-48.95	70.17
	5,580.00	-54.16	13.29	-52.22	4.88	H	-43.81	65.03
	7,440.00	-49.36	11.72	-40.45	5.67	V	-34.40	55.62
26365 (1882.5)	3,765.00	-53.33	12.56	-56.58	3.50	V	-47.52	68.74
	5,647.50	-53.72	13.30	-52.18	4.80	V	-43.68	64.90
	7,530.00	-48.28	11.69	-39.85	5.69	V	-33.85	55.07
26590 (1905.0)	3,810.00	-52.90	12.60	-55.67	3.52	H	-46.59	67.81
	5,715.00	-54.40	13.31	-52.46	4.82	V	-43.97	65.19
	7,620.00	-48.11	11.62	-39.73	5.63	H	-33.74	54.96

- NOTES:**
1. Radiated Spurious Emission Measurements at 3 meters by Substitution Method according to ANSI/TIA/EIA-603-D-2010 June 24, 2010:
 2. We are performed all frequency to 10th harmonics from 30 MHz. Measurements above show only up to 3 maximum emissions noted, or would be lesser if no specific emissions from the EUT are recorded (ie: margin > 20 dB from the applicable limit) and considered that's already beyond the background noise floor.
 3. we have done x, y, z planes in EUT and horizontal and vertical polarization in detecting antenna.
 4. All of RB size has been tested for emissions and EIRP, with the 1RB configuration observed as the worst case
 5. We are performed 16QAM and QPSK modulations. The worst case data are reported in the table above.

8.3 PEAK-TO-AVERAGE RATIO

Band	Band Width	Frequency (MHz)	Modulation	Resource Block Size	Resource Block Offset	Data (dB)
Band 25	1.4 MHz	1882.5	QPSK	6	0	6.13
			16-QAM	6		7.01
	3 MHz		QPSK	15		6.09
			16-QAM	15		6.89
	5 MHz		QPSK	25		6.05
			16-QAM	25		6.70
	10 MHz		QPSK	50		6.04
			16-QAM	50		6.73
	15 MHz		QPSK	75		6.04
			16-QAM	75		6.71
	20 MHz		QPSK	100		6.03
			16-QAM	100		6.77

- Plots of the EUT's Peak- to- Average Ratio are shown Page 41 ~ 46.

8.4OCCUPIED BANDWIDTH

Band	Band Width	Frequency (MHz)	Modulation	Resource Block Size	Resource Block Offset	Data (MHz)
Band 25	1.4 MHz	1882.5	QPSK	6	0	1.1038
			16-QAM	6	0	1.1007
	3 MHz		QPSK	15	0	2.6797
			16-QAM	15	0	2.6800
	5 MHz		QPSK	25	0	4.5098
			16-QAM	25	0	4.5044
	10 MHz		QPSK	50	0	8.9706
			16-QAM	50	0	8.9448
	15 MHz		QPSK	75	0	13.468
			16-QAM	75	0	13.466
	20 MHz		QPSK	100	0	17.938
			16-QAM	100	0	17.952

- Plots of the EUT's Occupied Bandwidth are shown Page 35 ~ 40.

8.5 CONDUCTED SPURIOUS EMISSIONS

■ FACTORS FOR FREQUENCY

Frequency Range (GHz)	Factor [dB]
0.03 – 1	27.145
1 – 5	26.960
5 – 10	27.542
10 – 15	28.439
15 – 20	29.144
Above 20	30.148

NOTES:

Factor(dB) = Cable Loss + Attenuator + Power Splitter

Band	Band Width (MHz)	Frequency (MHz)	Frequency of Maximum Harmonic (GHz)	Factor (dB)	Measurement Maximum Data (dBm)	Result (dBm)	Limit (dBm)
25	1.4	1850.7	5.5514	27.542	-65.037	-37.495	-13.00
		1880.0	5.6471	27.542	-65.520	-37.978	
		1909.3	5.7423	27.542	-63.450	-35.908	
	3	1851.5	5.5514	27.542	-63.877	-36.335	
		1880.0	5.6441	27.542	-63.887	-36.345	
		1908.5	5.7373	27.542	-64.103	-36.561	
	5	1852.5	5.5519	27.542	-64.395	-36.853	
		1880.0	5.6416	27.542	-64.680	-37.138	
		1880.0	5.7318	27.542	-66.270	-38.728	
	10	1907.5	5.5524	27.542	-64.460	-36.918	
		1855.0	5.6346	27.542	-64.425	-36.883	
		1880.0	5.7174	27.542	-66.650	-39.108	
	15	1905.0	5.5534	27.542	-64.350	-36.808	
		1857.5	5.6282	27.542	-66.630	-39.088	
		1880.0	5.7029	27.542	-69.397	-41.855	
	20	1902.5	5.5539	27.542	-64.790	-37.248	
		1860.0	5.6217	27.542	-65.036	-37.494	
		1880.0	5.6890	27.542	-67.344	-39.802	

NOTES:

1. Conducted Spurious Emissions was Tested QPSK Modulation, Resource Block Size 1 and Resource Block Offset 0
2. Result (dBm) = Measurement Maximum Data (dBm) + Factor (dB)

- Plots of the EUT's Conducted Spurious Emissions are shown Page 65 ~ 82.

7.5.1 BAND EDGE

- Plots of the EUT's Band Edge are shown Page 47 ~ 64.

8.6 FREQUENCY STABILITY / VARIATION OF AMBIENT TEMPERATURE

8.6.1 FREQUENCY STABILITY (1.4 MHz Band 25 LTE)

- ▣ OPERATING FREQUENCY: 1882,500,000 Hz
- ▣ CHANNEL: 26365 (1.4 MHz)
- ▣ REFERENCE VOLTAGE: 5.00 VDC
- ▣ DEVIATION LIMIT: Emission must remain in band

Voltage (%)	Power (VDC)	Temp. (°C)	Frequency (Hz)	Frequency Error (Hz)	Deviation (%)	ppm
100%	5.00	+20(Ref)	1882 499 991	0	0.000 000	0.000
100%		-30	1882 500 012	20.9	0.000 001	0.011
100%		-20	1882 500 000	9.7	0.000 001	0.005
100%		-10	1882 499 999	7.9	0.000 000	0.004
100%		0	1882 499 996	4.8	0.000 000	0.003
100%		+10	1882 499 996	5.2	0.000 000	0.003
100%		+30	1882 499 997	6.2	0.000 000	0.003
100%		+40	1882 499 994	3.1	0.000 000	0.002
100%		+50	1882 499 997	5.8	0.000 000	0.003
Batt. Endpoint		4.75	+20	1882 499 995	4.4	0.000 000

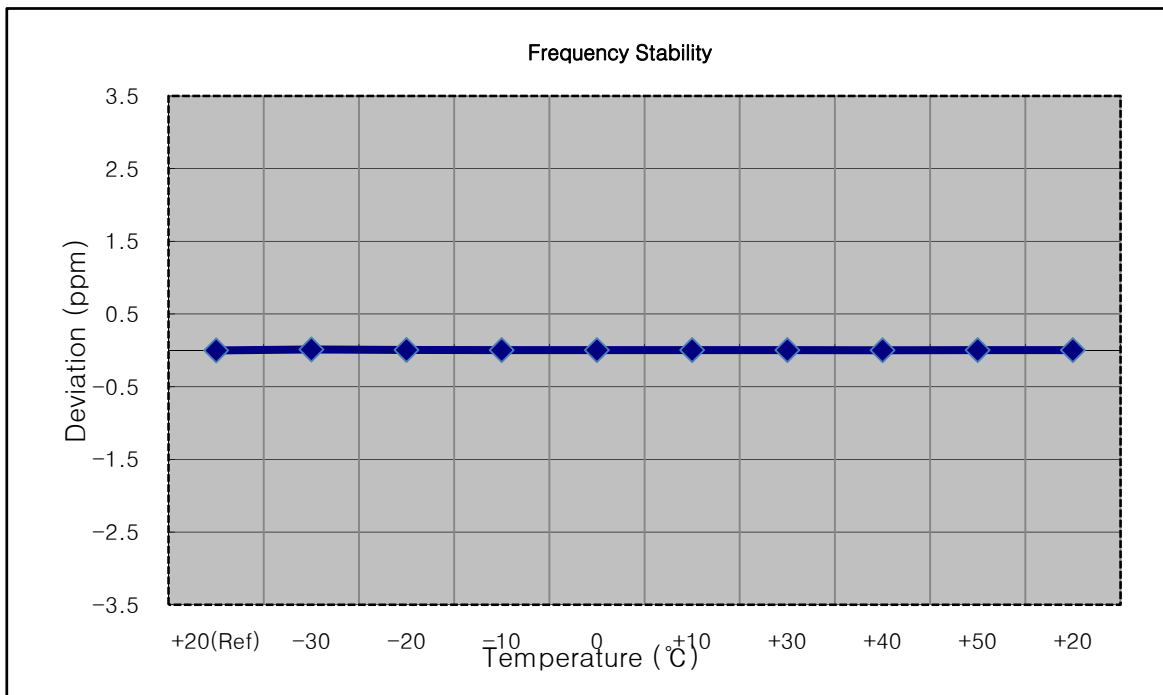

8.6.2 FREQUENCY STABILITY (3 MHz Band 25 LTE)

- ▣ OPERATING FREQUENCY: 1882,500,000 Hz
- ▣ CHANNEL: 26365 (3 MHz)
- ▣ REFERENCE VOLTAGE: 5.00 VDC
- ▣ DEVIATION LIMIT: Emission must remain in band

Voltage (%)	Power (VDC)	Temp. (°C)	Frequency (Hz)	Frequency Error (Hz)	Deviation (%)	ppm
100%	5.00	+20(Ref)	1882 500 016	0.0	0.000 000	0.000
100%		-30	1882 500 031	15.2	0.000 001	0.008
100%		-20	1882 500 029	12.5	0.000 001	0.007
100%		-10	1882 500 026	9.9	0.000 001	0.005
100%		0	1882 500 033	17.2	0.000 001	0.009
100%		+10	1882 500 027	10.4	0.000 001	0.006
100%		+30	1882 500 024	8.0	0.000 000	0.004
100%		+40	1882 500 026	9.5	0.000 001	0.005
100%		+50	1882 500 022	5.4	0.000 000	0.003
Batt. Endpoint		4.75	+20	1882 500 020	4.1	0.000 000

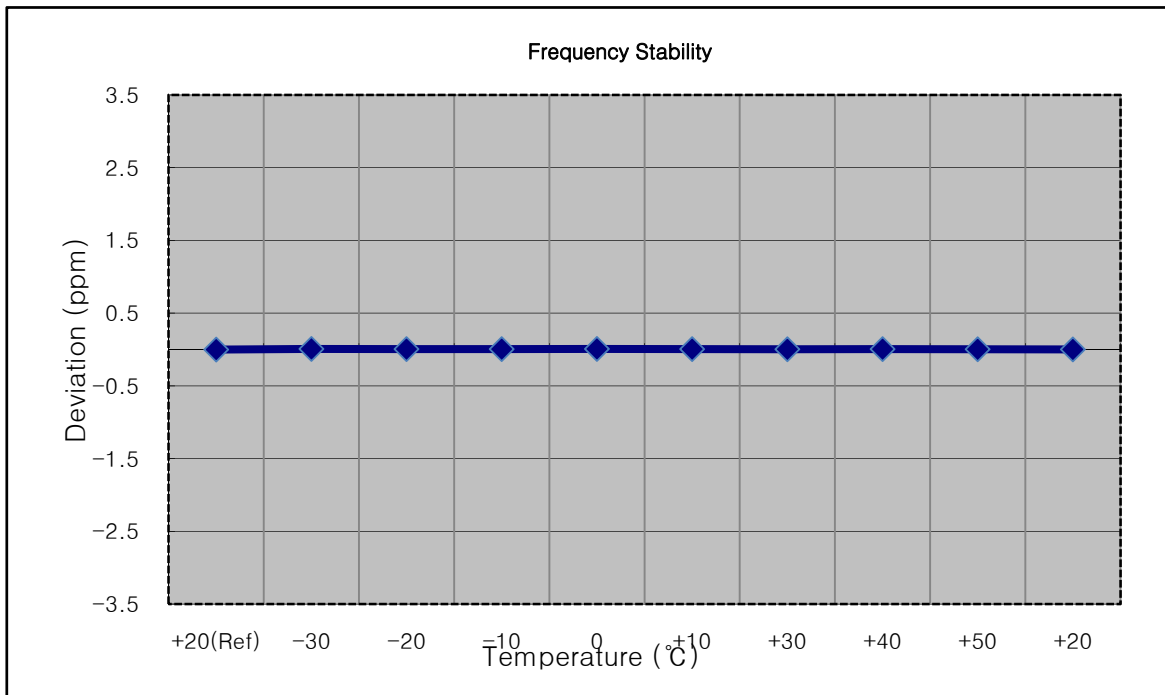

8.6.3 FREQUENCY STABILITY (5 MHz Band 25 LTE)

- ▣ OPERATING FREQUENCY: 1882,500,000 Hz
- ▣ CHANNEL: 26365 (5 MHz)
- ▣ REFERENCE VOLTAGE: 5.00 VDC
- ▣ DEVIATION LIMIT: Emission must remain in band

Voltage (%)	Power (VDC)	Temp. (°C)	Frequency (Hz)	Frequency Error (Hz)	Deviation (%)	ppm
100%	5.00	+20(Ref)	1882 500 008	0.0	0.000 000	0.000
100%		-30	1882 500 012	4.1	0.000 000	0.002
100%		-20	1882 500 005	-3.6	0.000 000	-0.002
100%		-10	1882 500 003	-5.4	0.000 000	-0.003
100%		0	1882 500 002	-6.6	0.000 000	-0.004
100%		+10	1882 500 002	-6.0	0.000 000	-0.003
100%		+30	1882 500 002	-5.9	0.000 000	-0.003
100%		+40	1882 500 003	-5.7	0.000 000	-0.003
100%		+50	1882 500 002	-6.3	0.000 000	-0.003
Batt. Endpoint	4.75	+20	1882 500 001	-6.8	0.000 000	-0.004

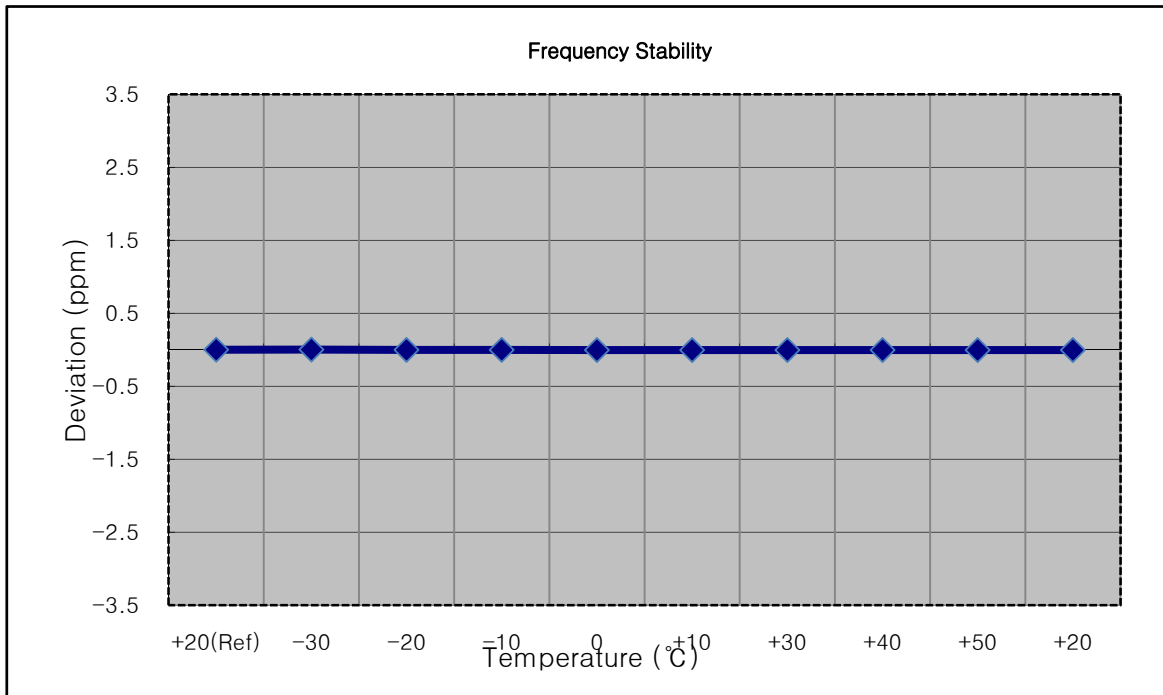

8.6.4 FREQUENCY STABILITY (10 MHz Band 25 LTE)

- ▣ OPERATING FREQUENCY: 1882,500,000 Hz
- ▣ CHANNEL: 26365 (10 MHz)
- ▣ REFERENCE VOLTAGE: 5.00 VDC
- ▣ DEVIATION LIMIT: Emission must remain in band

Voltage (%)	Power (VDC)	Temp. (°C)	Frequency (Hz)	Frequency Error (Hz)	Deviation (%)	ppm
100%	5.00	+20(Ref)	1882 499 987	0.0	0.000 000	0.000
100%		-30	1882 500 000	13.6	0.000 001	0.007
100%		-20	1882 499 993	6.6	0.000 000	0.004
100%		-10	1882 499 989	2.7	0.000 000	0.001
100%		0	1882 499 990	3.2	0.000 000	0.002
100%		+10	1882 499 985	-1.2	0.000 000	-0.001
100%		+30	1882 499 979	-7.8	0.000 000	-0.004
100%		+40	1882 499 978	-9.0	0.000 000	-0.005
100%		+50	1882 499 979	-7.6	0.000 000	-0.004
Batt. Endpoint	4.75	+20	1882 499 977	-9.6	-0.000 001	-0.005

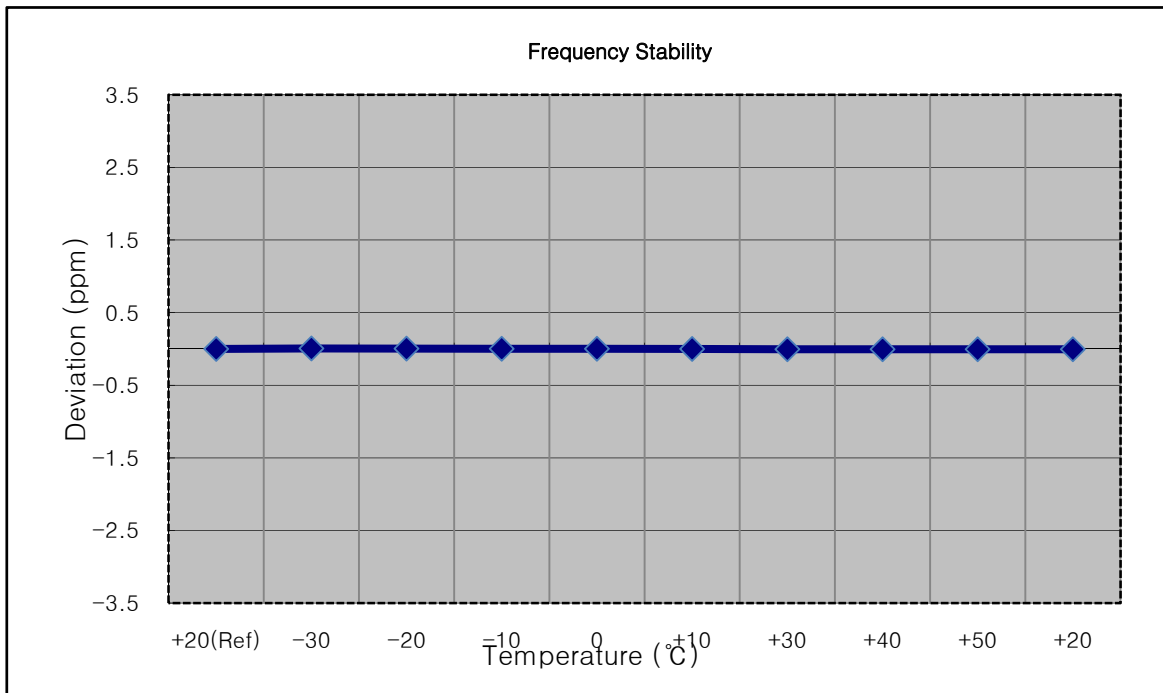

8.6.5 FREQUENCY STABILITY (15 MHz Band 25 LTE)

- ▣ OPERATING FREQUENCY: 1882,500,000 Hz
- ▣ CHANNEL: 26365 (15 MHz)
- ▣ REFERENCE VOLTAGE: 5.00 VDC
- ▣ DEVIATION LIMIT: Emission must remain in band

Voltage (%)	Power (VDC)	Temp. (°C)	Frequency (Hz)	Frequency Error (Hz)	Deviation (%)	ppm
100%	5.00	+20(Ref)	1882 499 994	0.0	0.000 000	0.000
100%		-30	1882 499 980	-14.2	-0.000 001	-0.008
100%		-20	1882 499 978	-15.9	-0.000 001	-0.008
100%		-10	1882 499 976	-18.6	-0.000 001	-0.010
100%		0	1882 499 978	-16.2	-0.000 001	-0.009
100%		+10	1882 500 005	11.2	0.000 001	0.006
100%		+30	1882 500 007	13.2	0.000 001	0.007
100%		+40	1882 500 007	12.9	0.000 001	0.007
100%		+50	1882 500 005	10.7	0.000 001	0.006
Batt. Endpoint	4.75	+20	1882 500 004	10.0	0.000 001	0.005

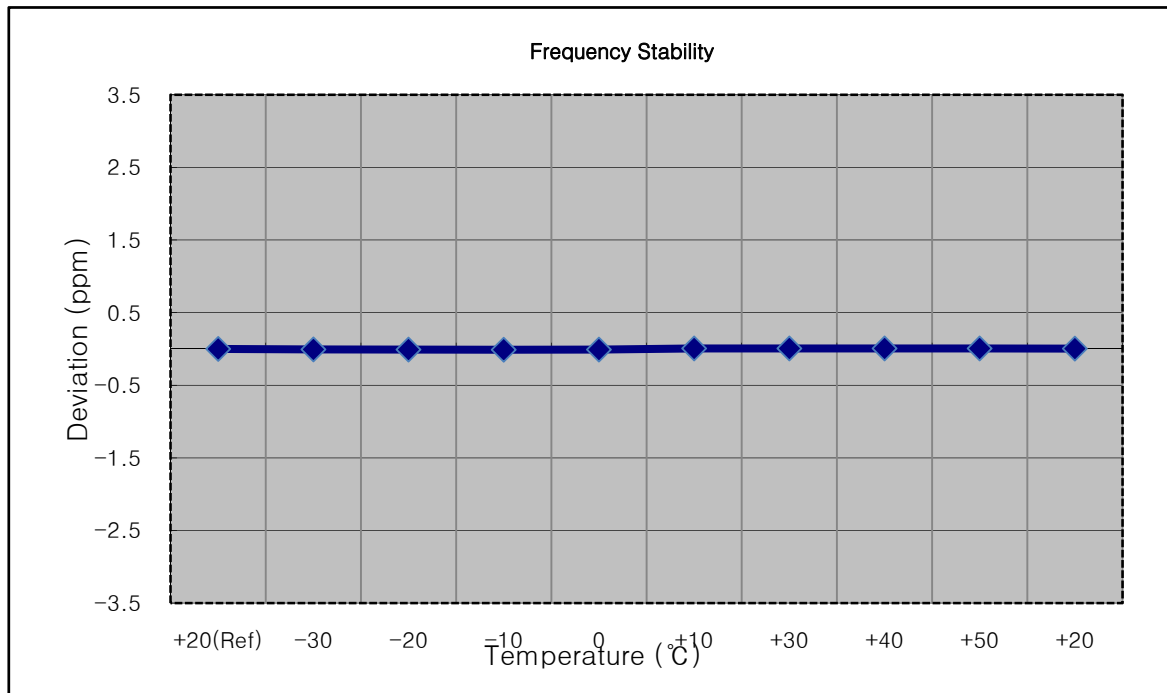

8.6.6 FREQUENCY STABILITY (20 MHz Band 25 LTE)

- ▣ OPERATING FREQUENCY: 1882,500,000 Hz
- ▣ CHANNEL: 26365 (20 MHz)
- ▣ REFERENCE VOLTAGE: 5.00 VDC
- ▣ DEVIATION LIMIT: Emission must remain in band

Voltage (%)	Power (VDC)	Temp. (°C)	Frequency (Hz)	Frequency Error (Hz)	Deviation (%)	ppm
100%	5.00	+20(Ref)	1882 499 997	0.0	0.000 000	0.000
100%		-30	1882 500 001	4.4	0.000 000	0.002
100%		-20	1882 499 995	-2.2	0.000 000	-0.001
100%		-10	1882 499 992	-4.3	0.000 000	-0.002
100%		0	1882 499 994	-3.1	0.000 000	-0.002
100%		+10	1882 499 992	-4.7	0.000 000	-0.002
100%		+30	1882 499 989	-7.5	0.000 000	-0.004
100%		+40	1882 499 990	-6.5	0.000 000	-0.003
100%		+50	1882 499 987	-9.8	-0.000 001	-0.005
Batt. Endpoint	4.75	+20	1882 499 987	-10.1	-0.000 001	-0.005

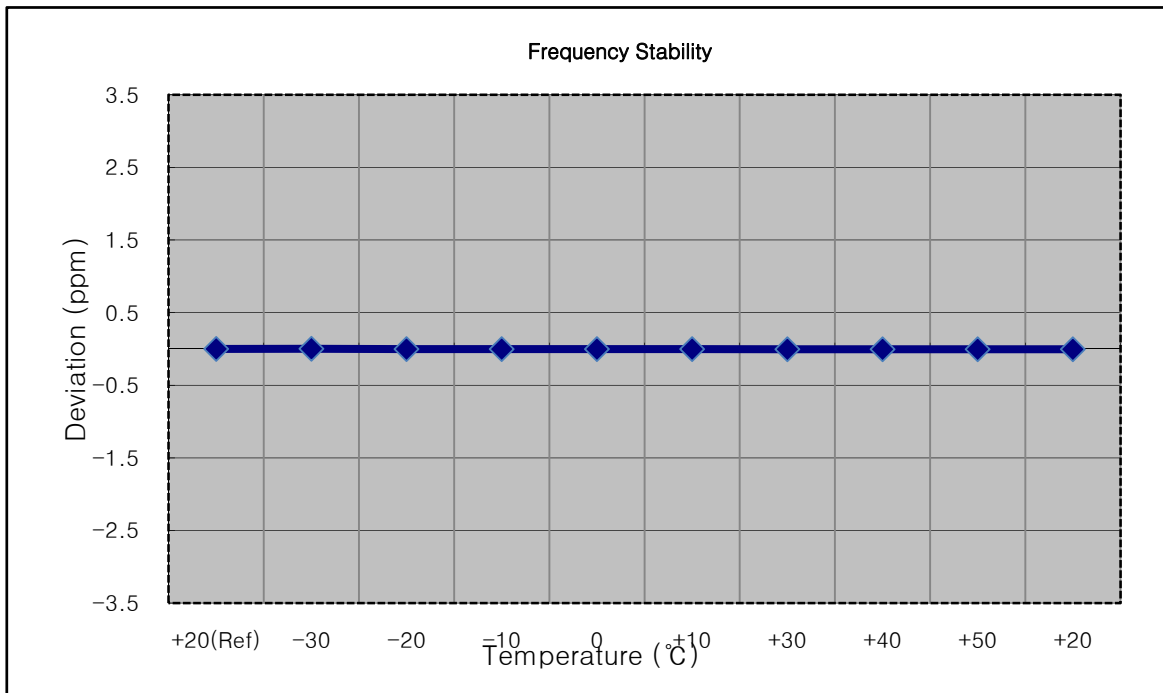

9. TEST PLOTS

BAND 25. Occupied Bandwidth Plot (1.4M BW Ch.26365 QPSK RB 6_0)

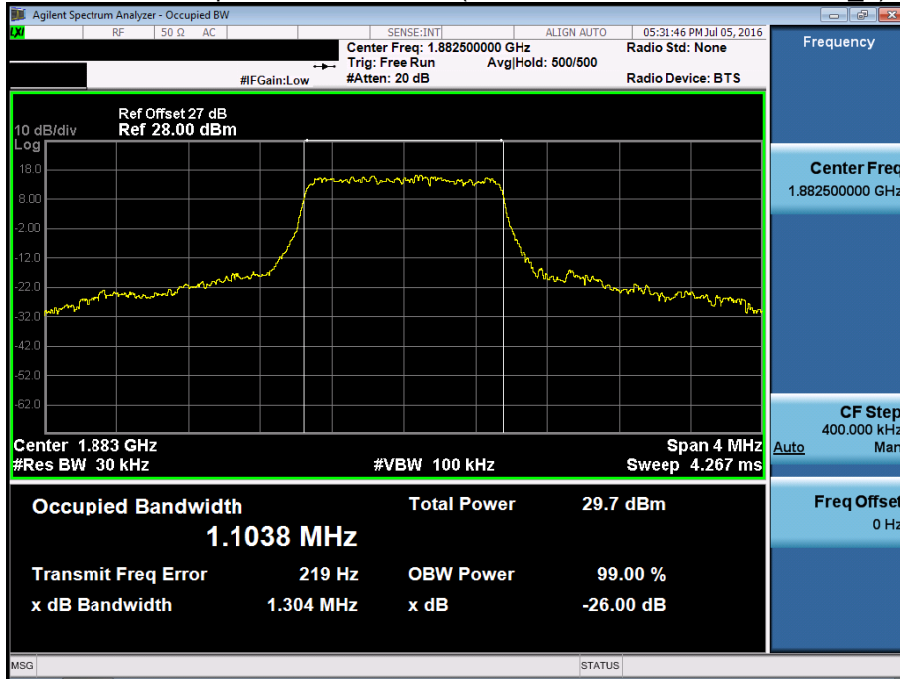

BAND 25. Occupied Bandwidth Plot (1.4M BW Ch. 26365 16QAM RB 6_0)

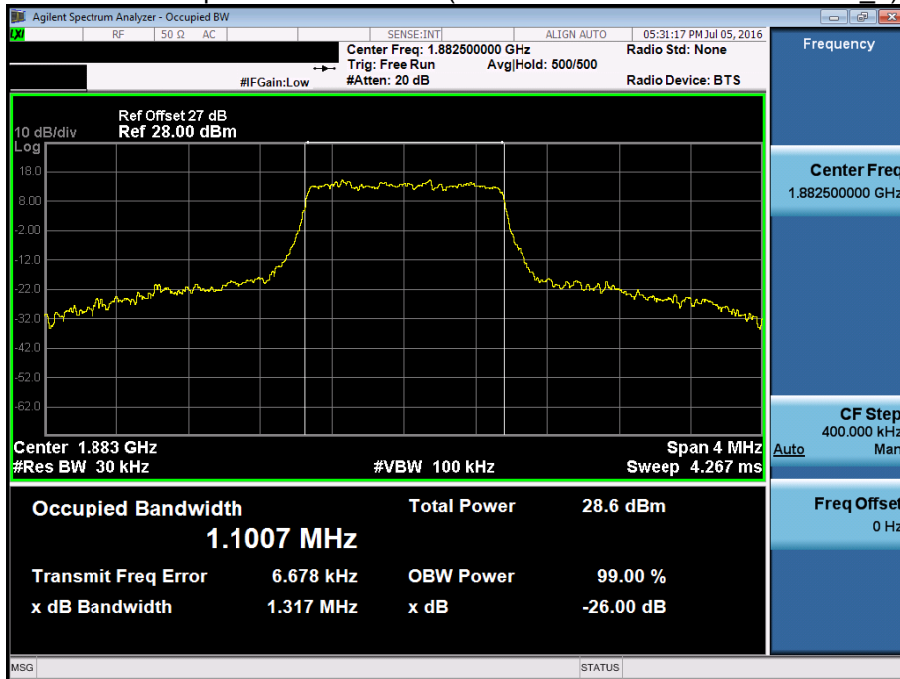

BAND 25. Occupied Bandwidth Plot (3M BW Ch. 26365 QPSK RB 15_0)

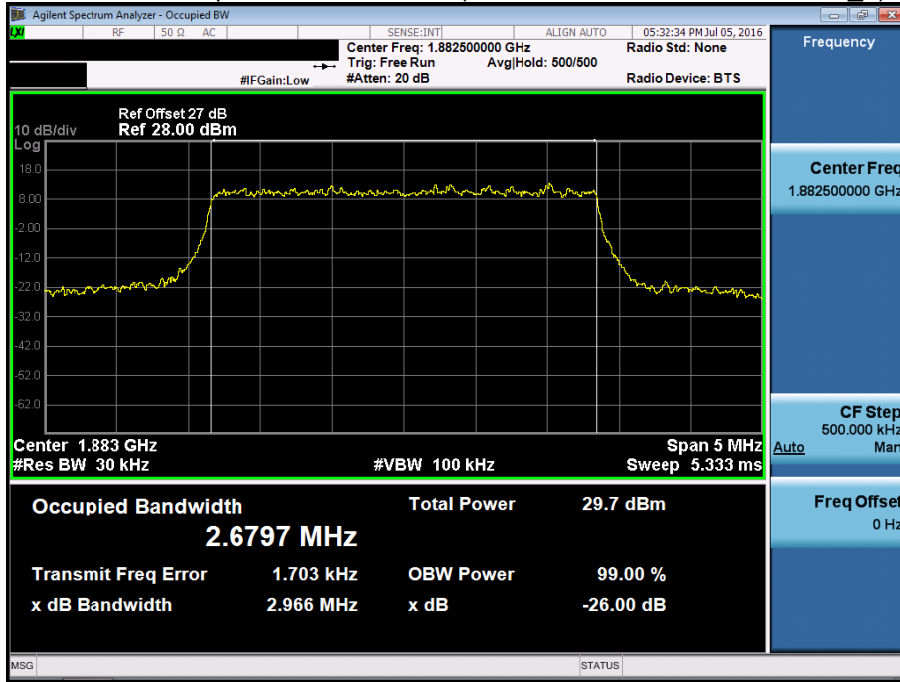

BAND 25. Occupied Bandwidth Plot (3M BW Ch. 26365 16QAM RB 15_0)

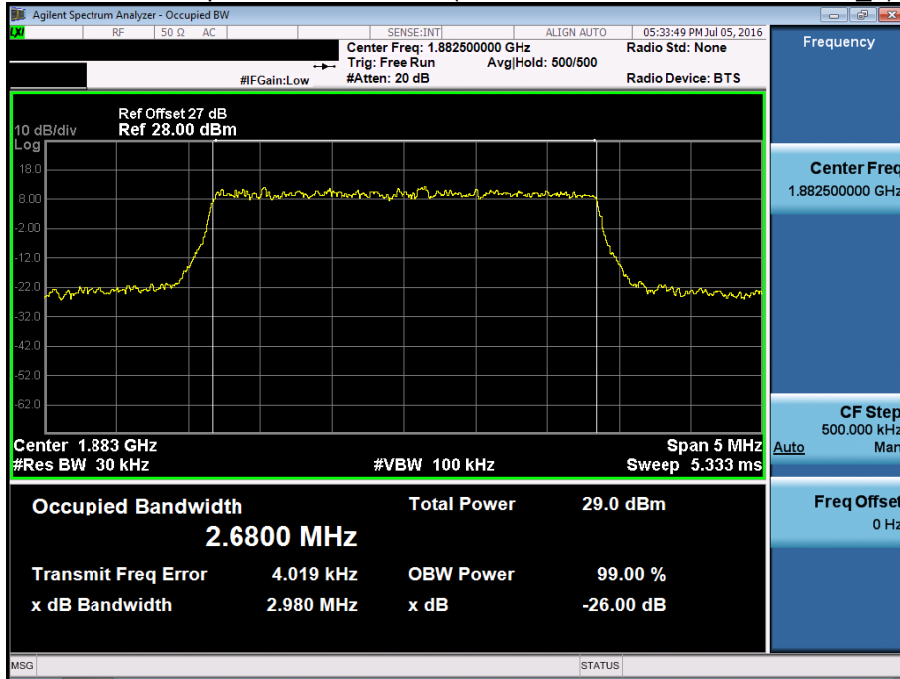

BAND 25. Occupied Bandwidth Plot (5M BW Ch. 26365QPSK RB 25_0)

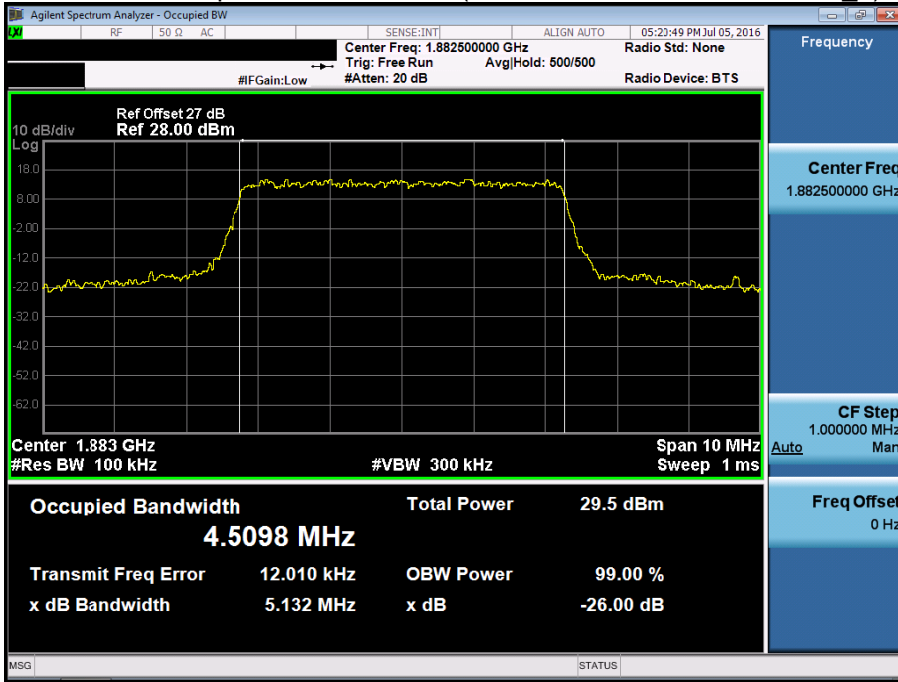

BAND 25. Occupied Bandwidth Plot (5M BW Ch. 2636516QAM RB 25_0)

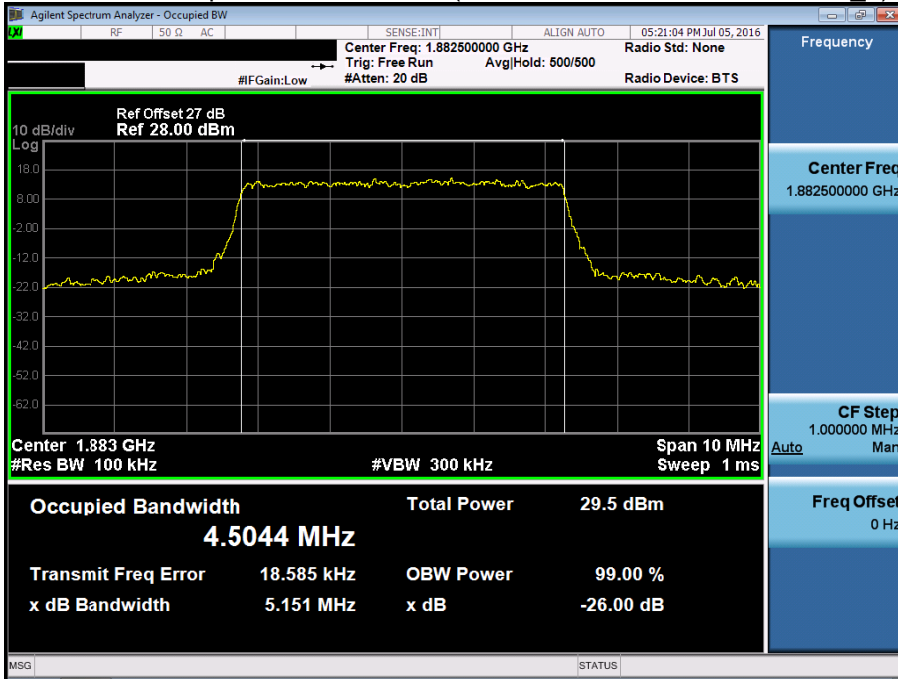

BAND 25. Occupied Bandwidth Plot (10M BW Ch. 26365 QPSK RB 50_0)

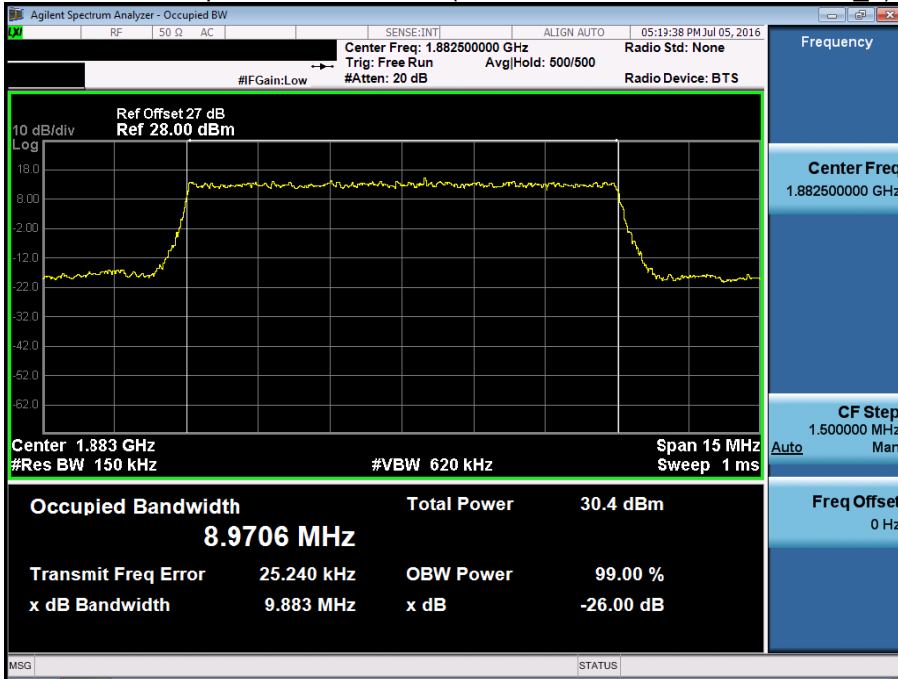

BAND 25. Occupied Bandwidth Plot (10M BW Ch. 26365 16QAM RB 50_0)

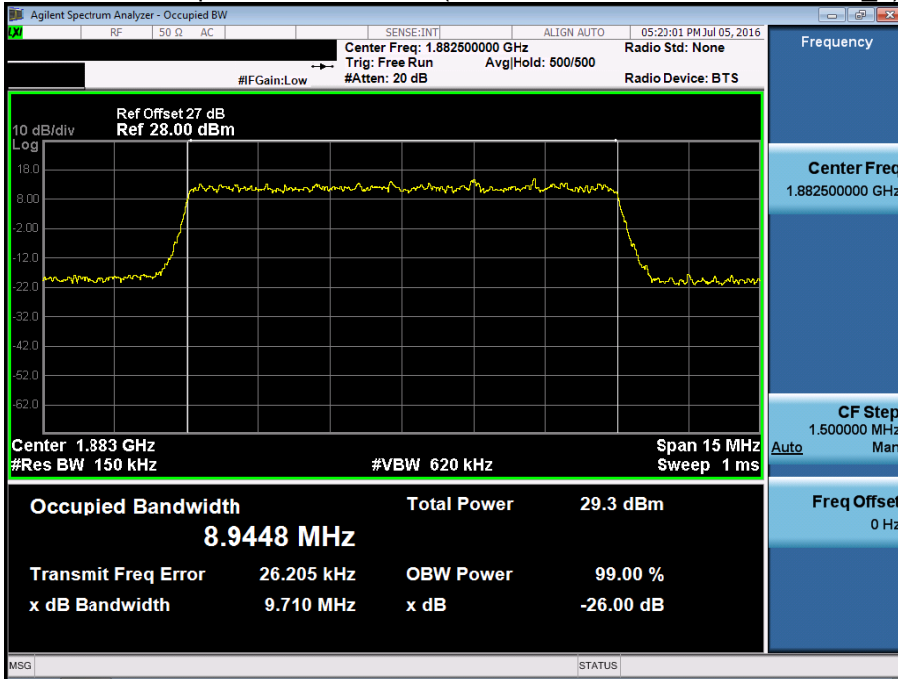

BAND 25. Occupied Bandwidth Plot (15M BW Ch. 26365 QPSK RB 75_0)

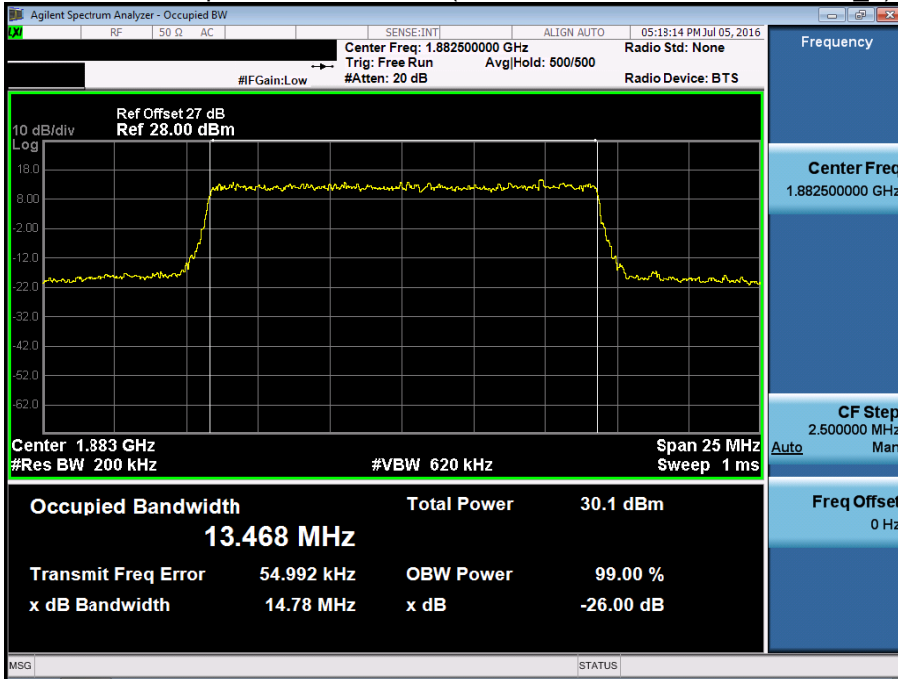

BAND 25. Occupied Bandwidth Plot (15M BW Ch. 26365 16QAM RB 75_0)

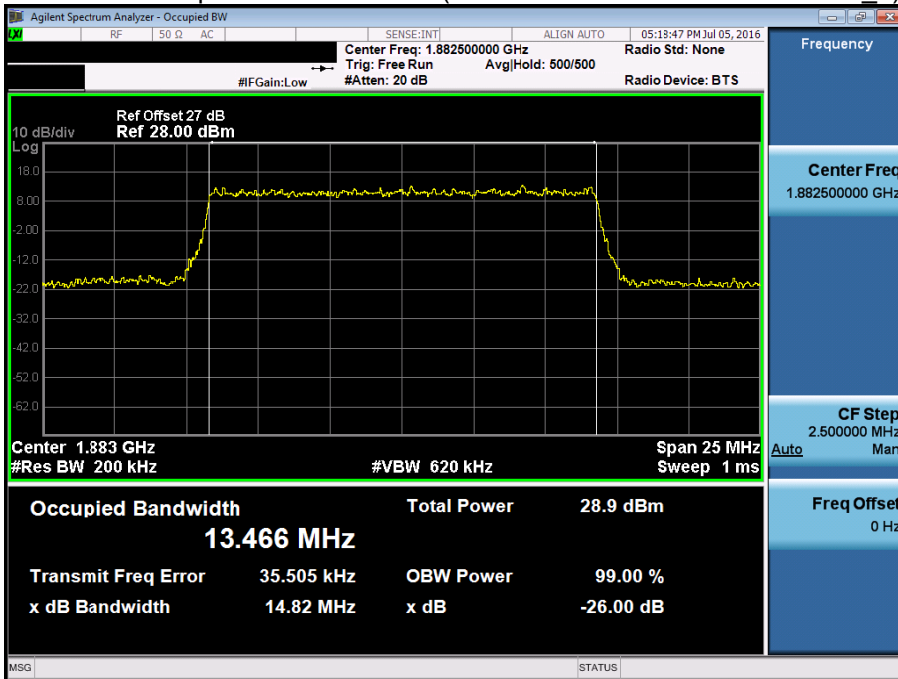

BAND 25. Occupied Bandwidth Plot (20M BW Ch. 26365 QPSK RB 100_0)

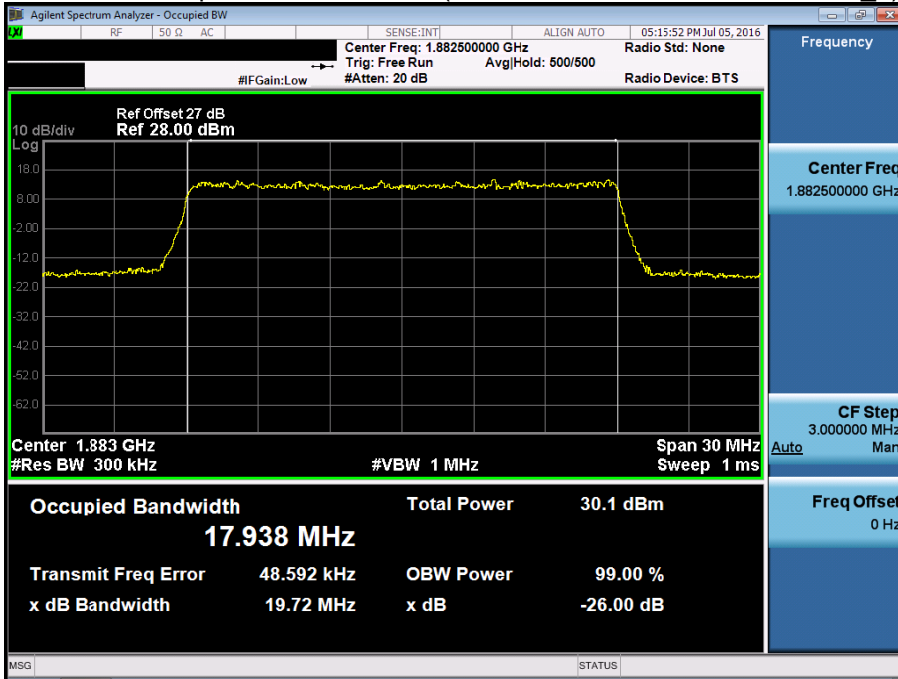

BAND 25. Occupied Bandwidth Plot (20M BW Ch. 26365 16QAM RB 100_0)

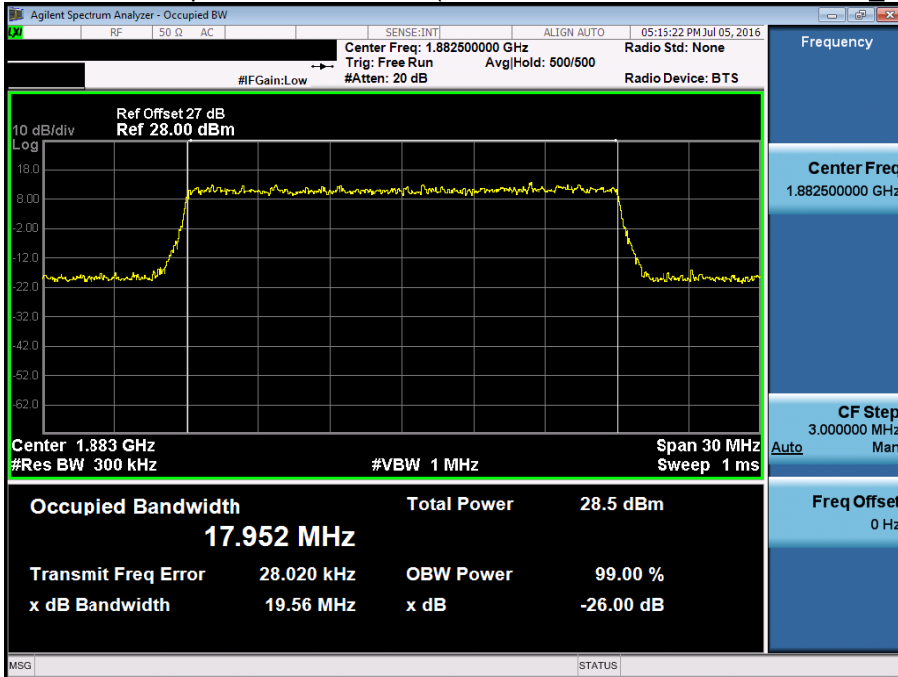

BAND 25. PAR Plot (1.4M BW Ch. 26365 QPSK RB 6_0)

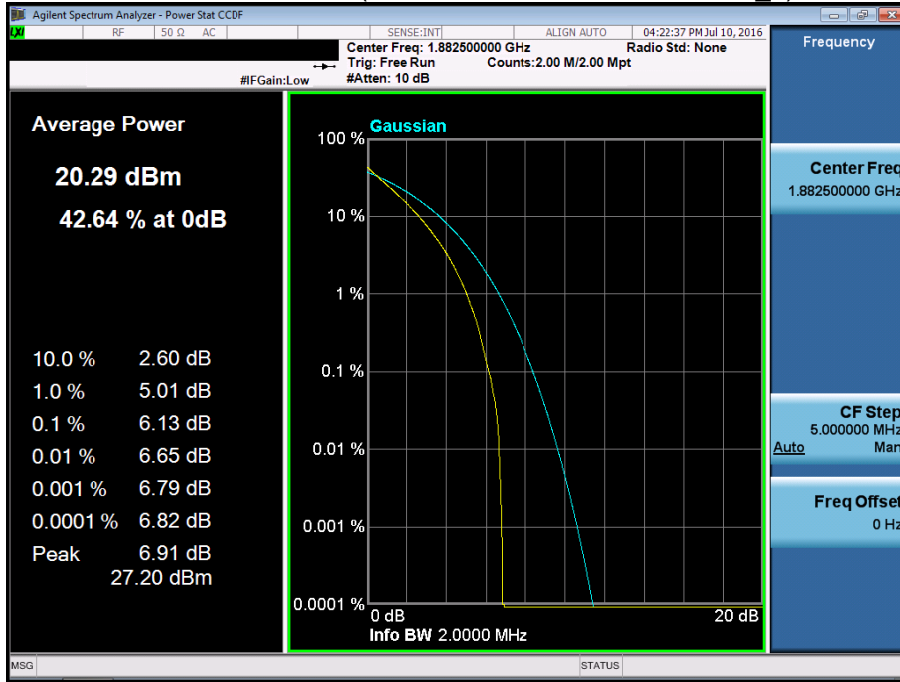

BAND 25. PAR Plot (1.4M BW Ch. 26365 16QAM RB 6_0)

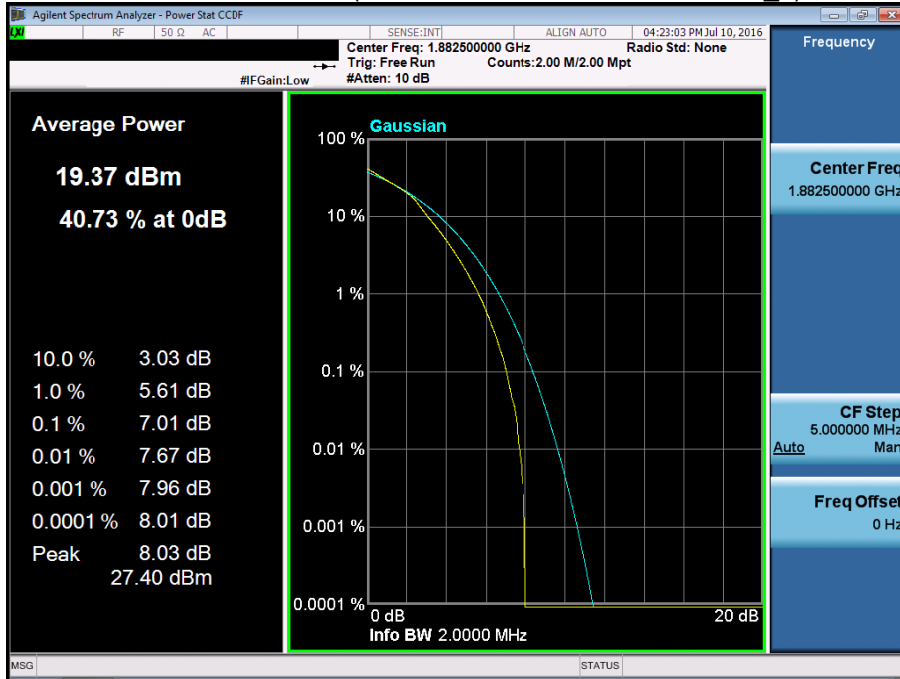

BAND 25. PAR Plot (3M BW Ch. 26365 QPSK RB 15_0)

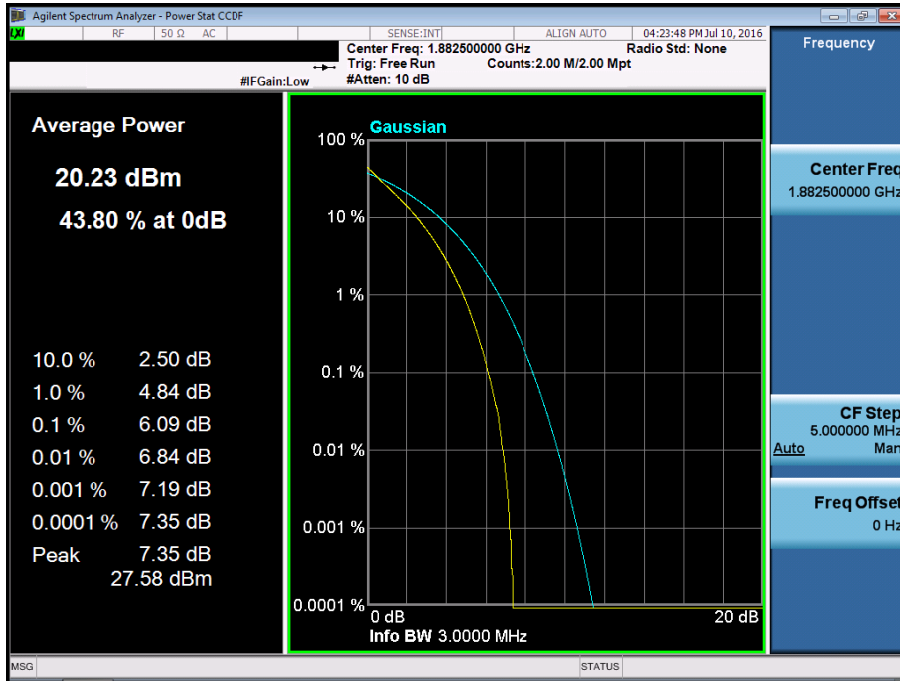

BAND 25. PAR Plot (3M BW Ch. 26365 16QAM RB 15_0)

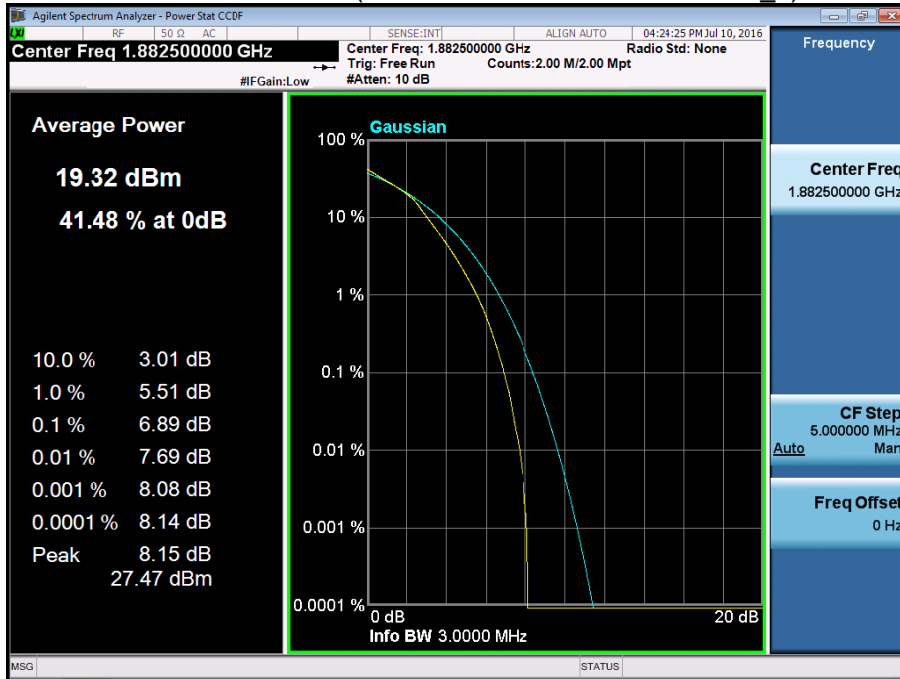

BAND 25. PAR Plot (5M BW Ch. 26365 QPSK RB 25_0)

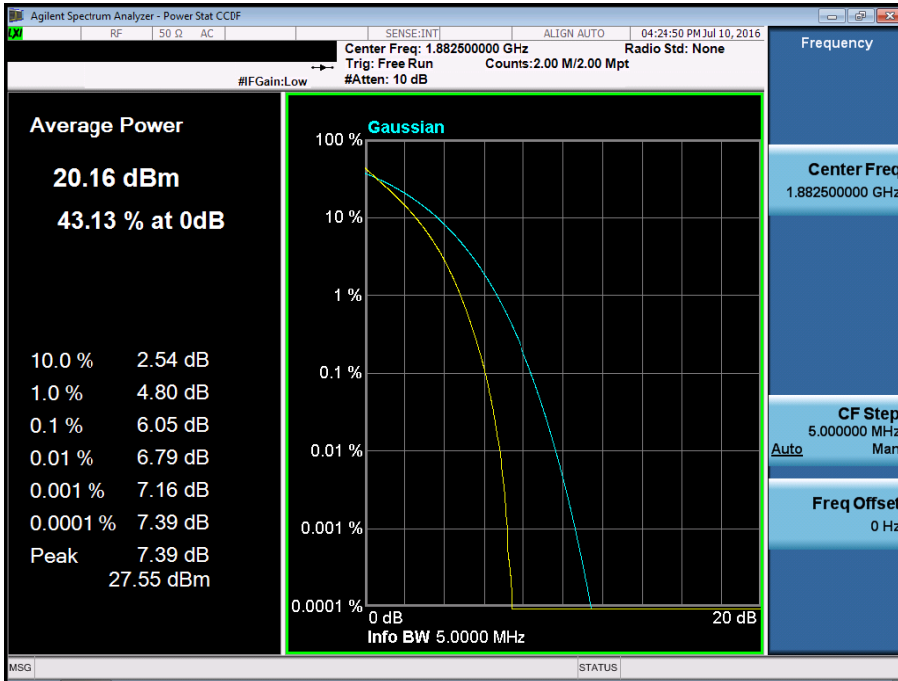

BAND 25. PAR Plot (5M BW Ch. 26365 16QAM RB 25_0)

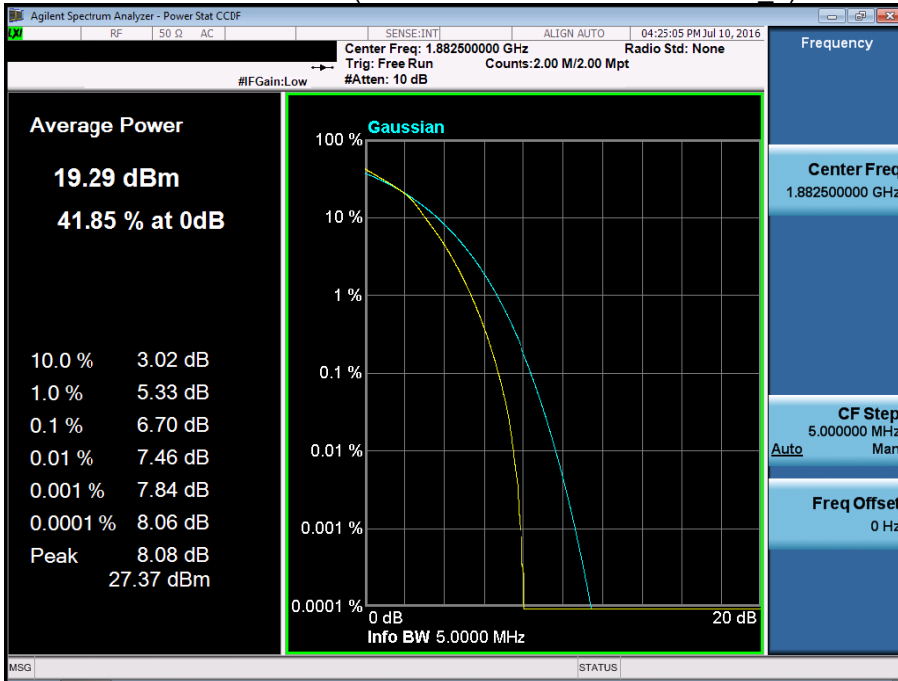

BAND 25. PAR Plot (10M BW Ch. 26365 QPSK RB 50_0)

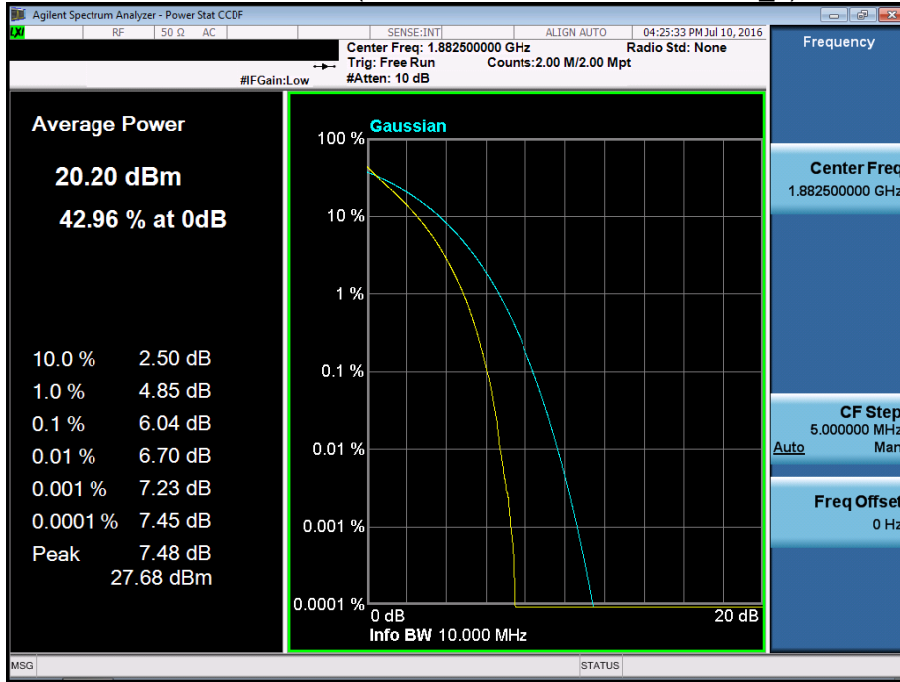

BAND 25. PAR Plot (10M BW Ch. 26365 16QAM RB 50_0)

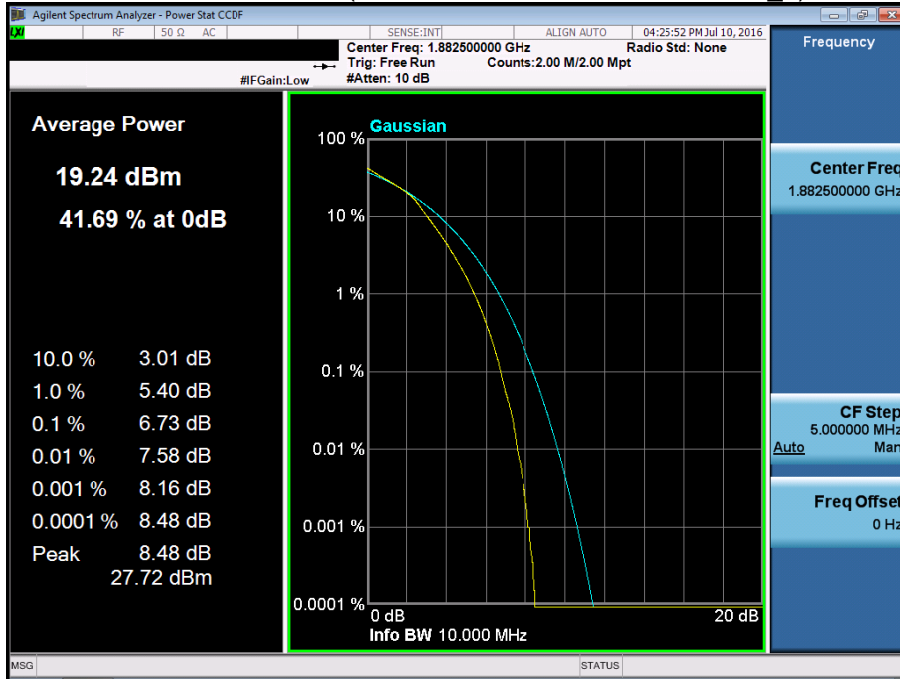

BAND 25. PAR Plot (15M BW Ch. 26365 QPSK RB 75_0)

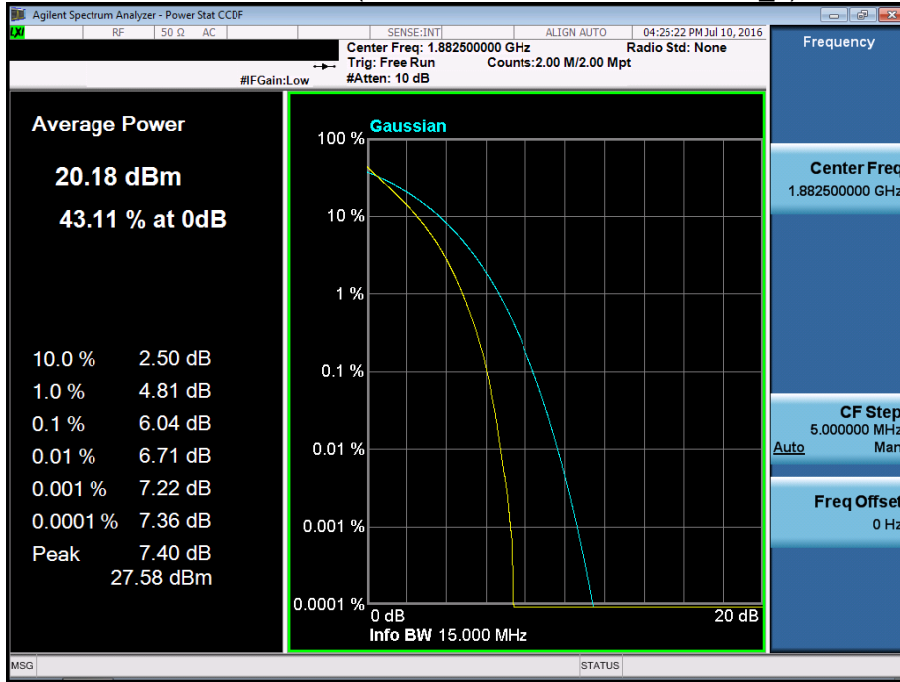

BAND 25. PAR Plot (15M BW Ch. 26365 16QAM RB 75_0)

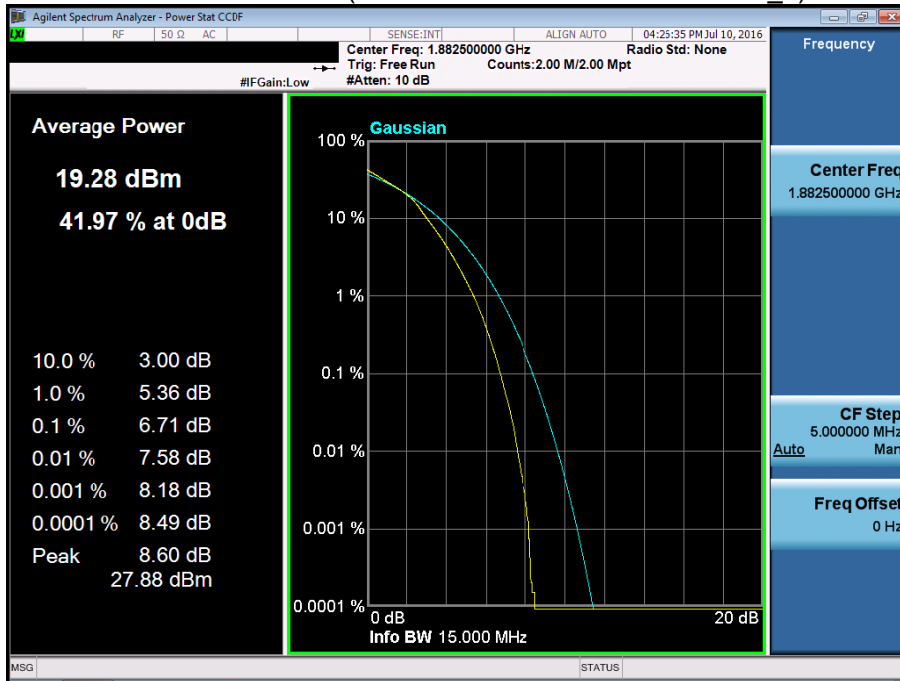

BAND 25. PAR Plot (20M BW Ch. 26365 QPSK RB 100_0)

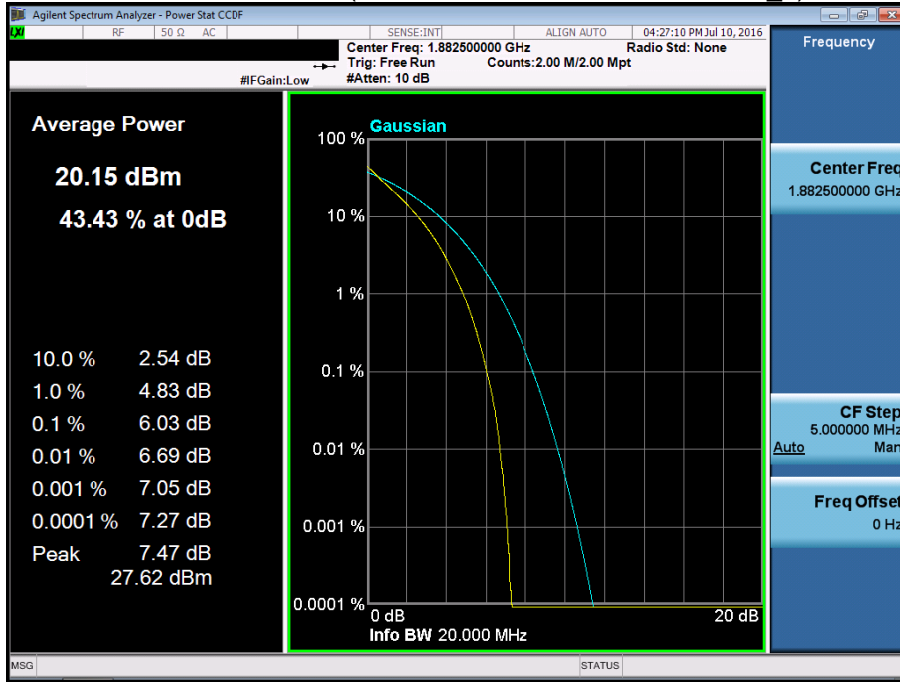

BAND 25. PAR Plot (20M BW Ch. 26365 16QAM RB 100_0)

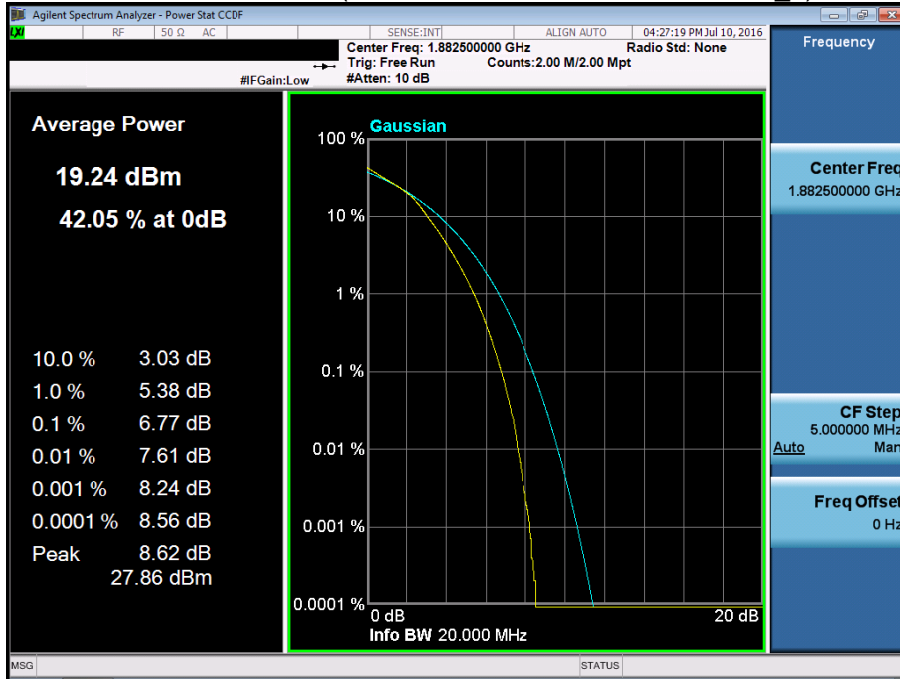

BAND 25. Lower Band Edge Plot (1.4M BW Ch.26047 QPSK_RB1_Offset 0) -1

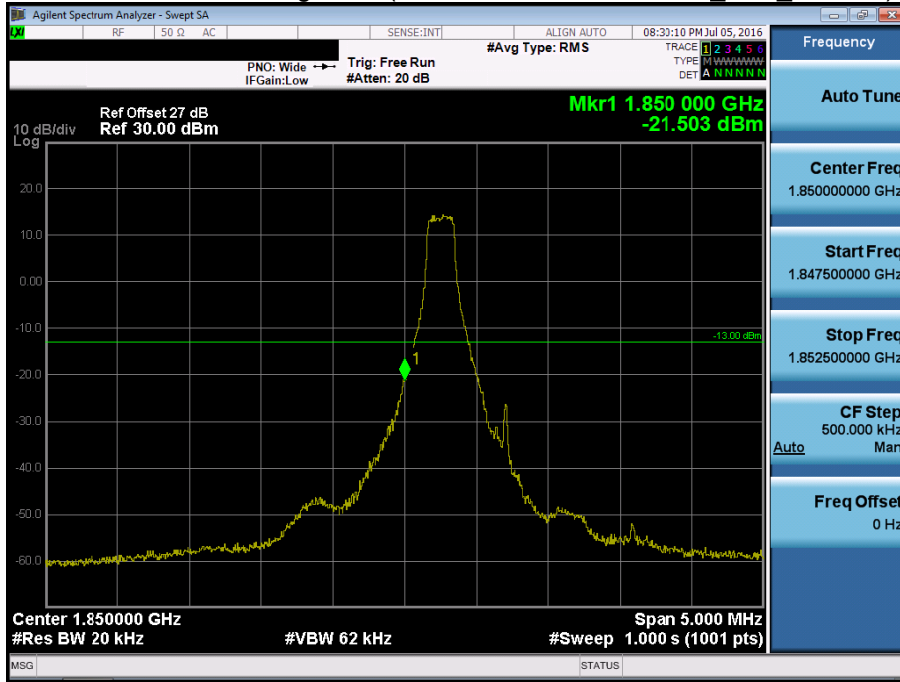

BAND 25. Lower Band Edge Plot (1.4M BW Ch. 26047 QPSK_RB6_Offset 0) -2

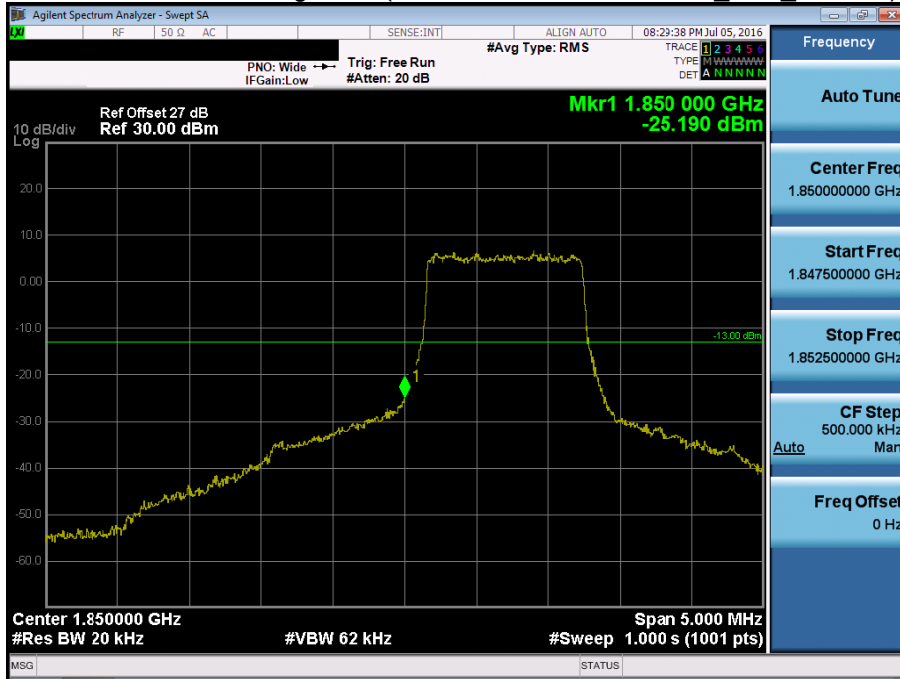

BAND 25. Lower Extended Band Edge Plot (1.4M BW Ch. 26047 QPSK_RB6_0) -3

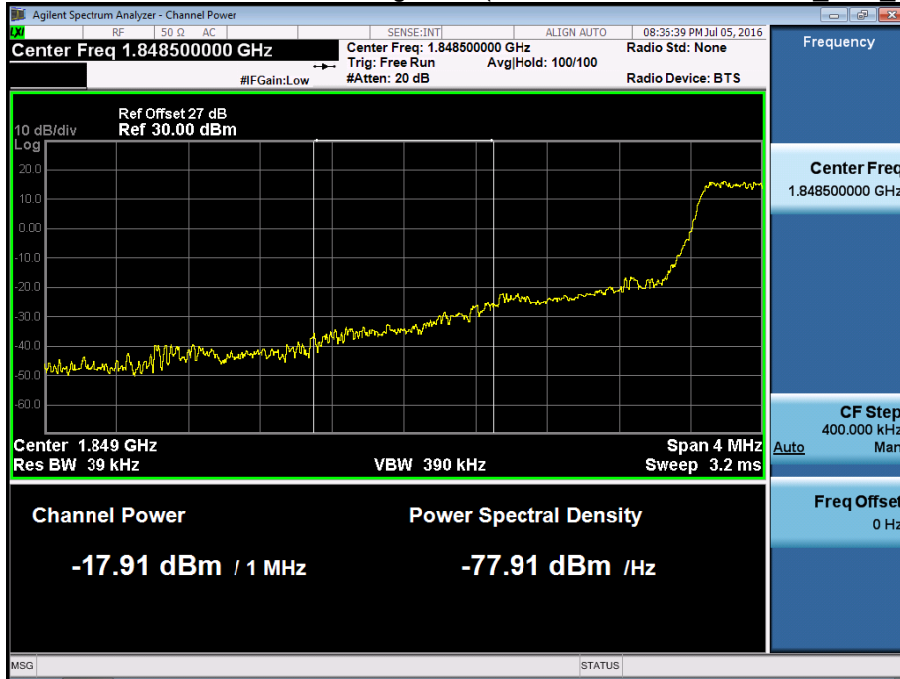

BAND 25. Lower Band Edge Plot (3M BW Ch.26055 QPSK_RB1_Offset 0) -1

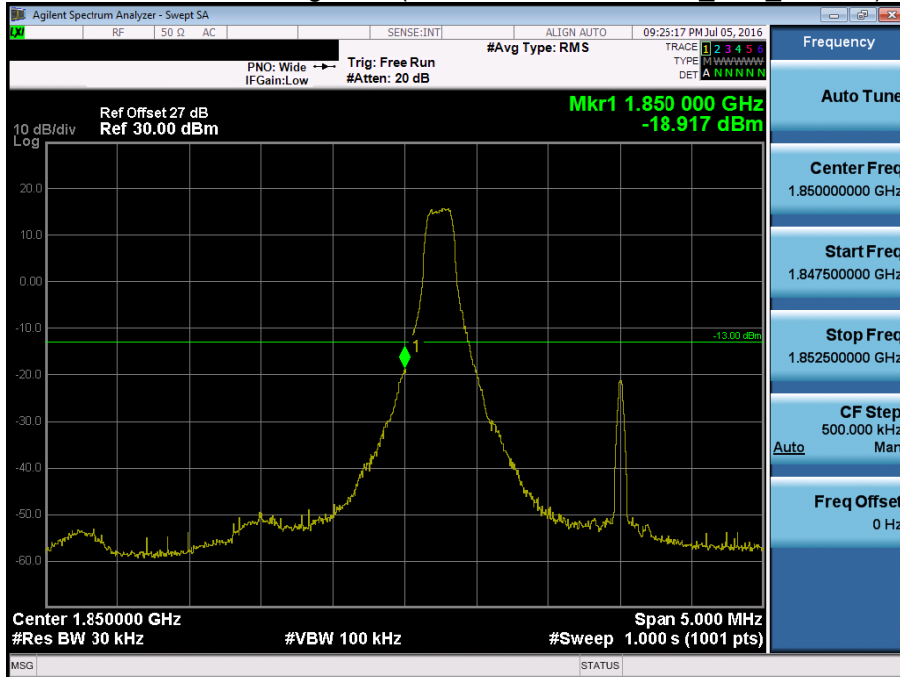

BAND 25. Lower Band Edge Plot (3M BW Ch. 26055 QPSK_RB15_Offset 0) -2

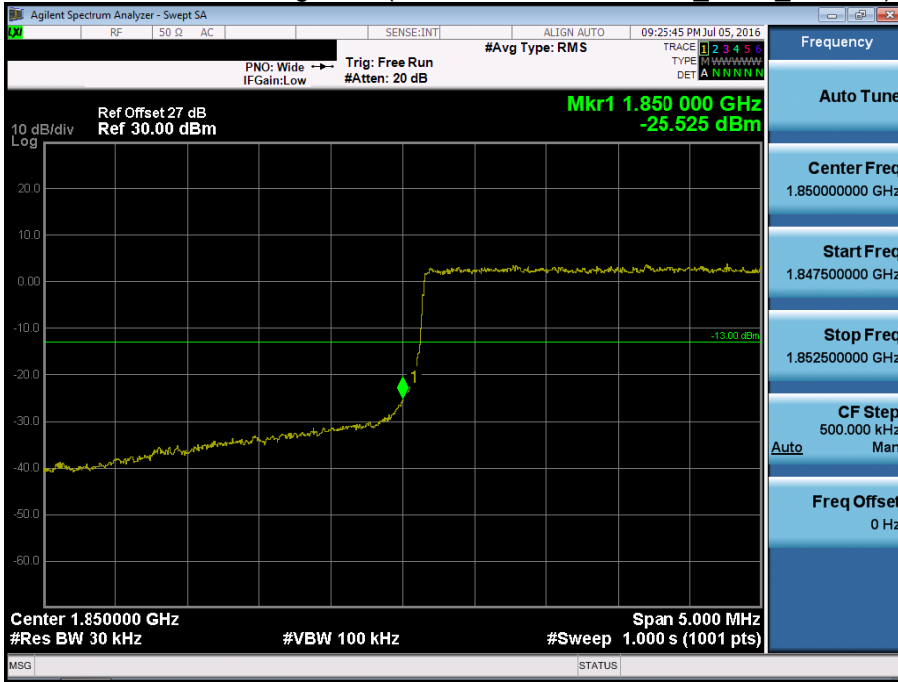

BAND 25. Lower Extended Band Edge Plot (3M BW Ch. 26055 QPSK_RB15_0) -3

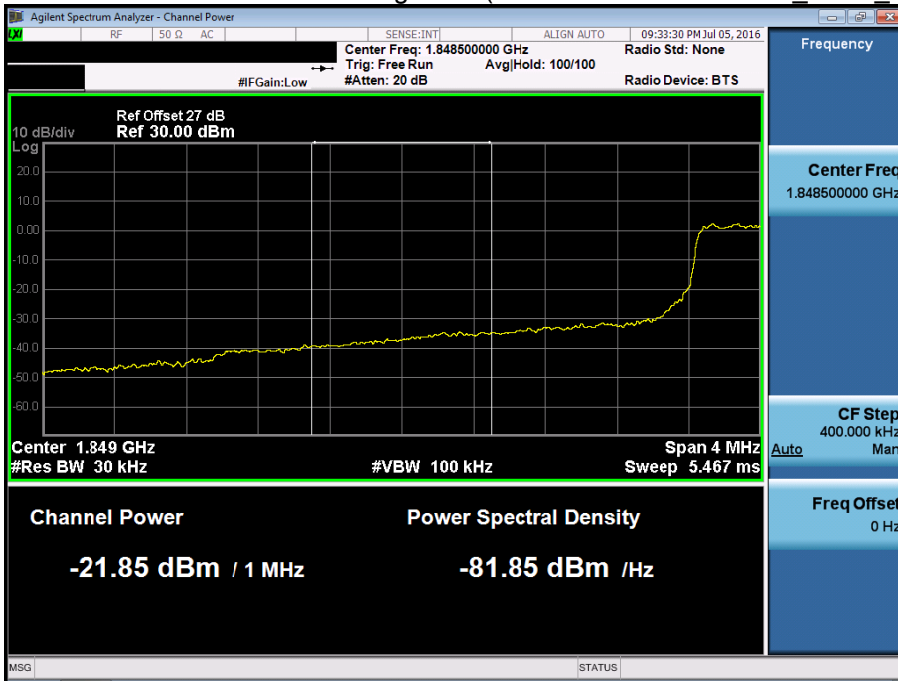

BAND 25. Lower Band Edge Plot (5M BW Ch.26065 QPSK_RB1_Offset 0) -1

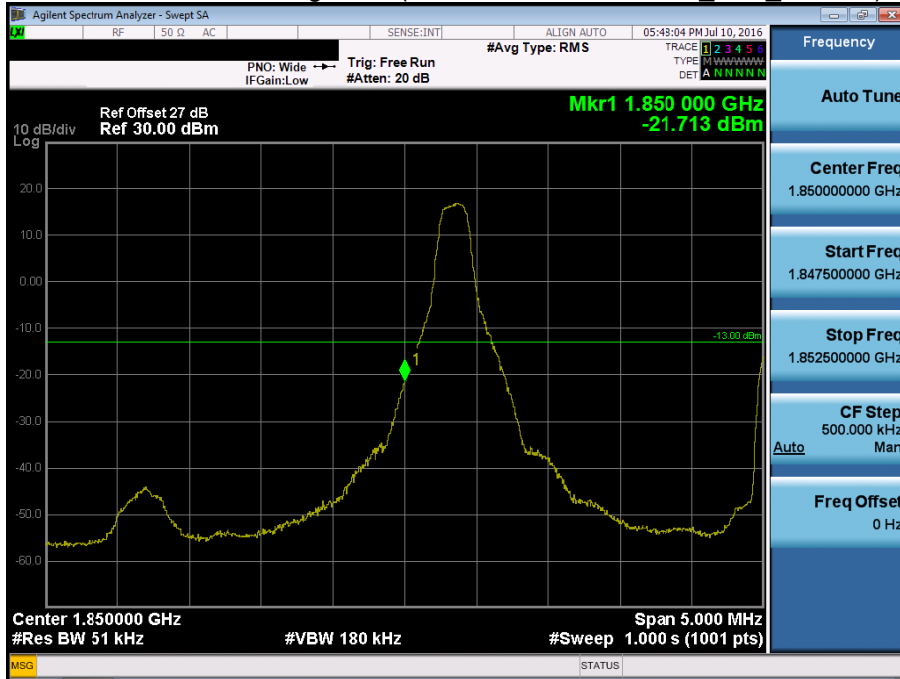

BAND 25. Lower Band Edge Plot (5M BW Ch. 26065 QPSK_RB25_Offset 0) -2

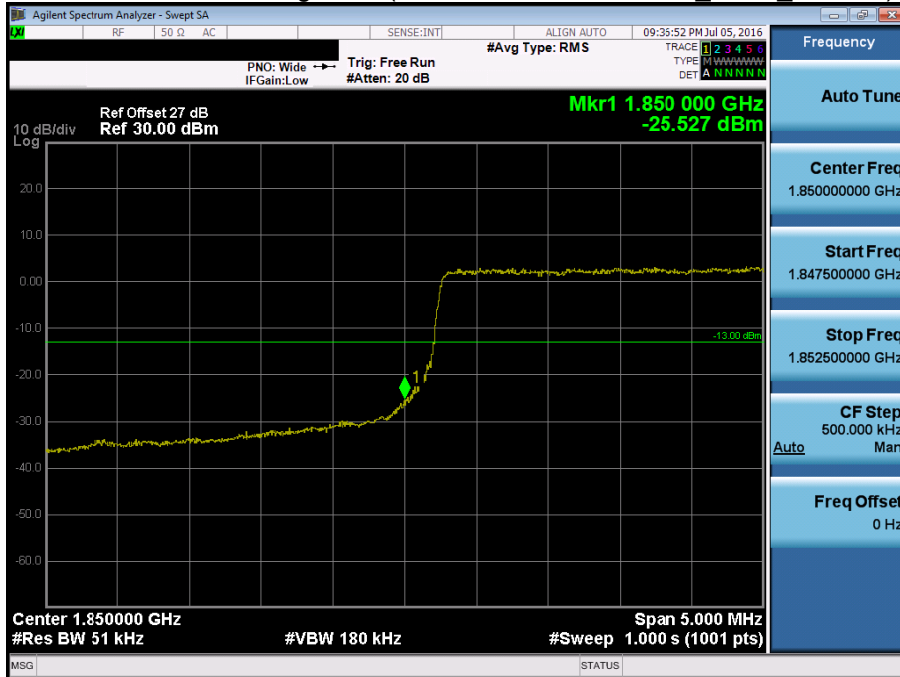

BAND 25. Lower Extended Band Edge Plot (5M BW Ch. 26065 QPSK_RB25_0) -3

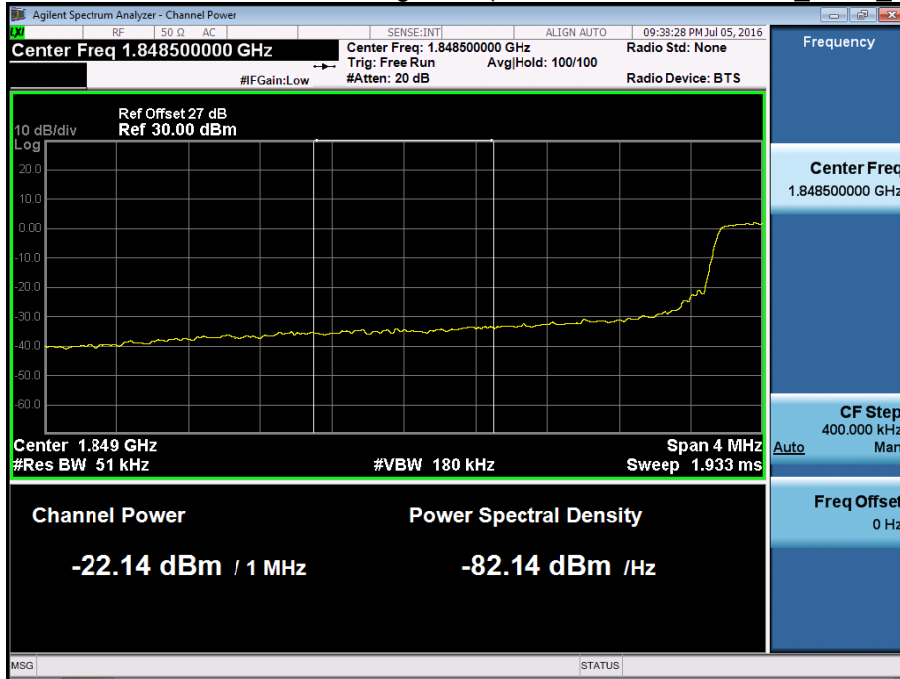

BAND 25. Lower Band Edge Plot (10M BW Ch.26090 QPSK_RB1_Offset 0) -1

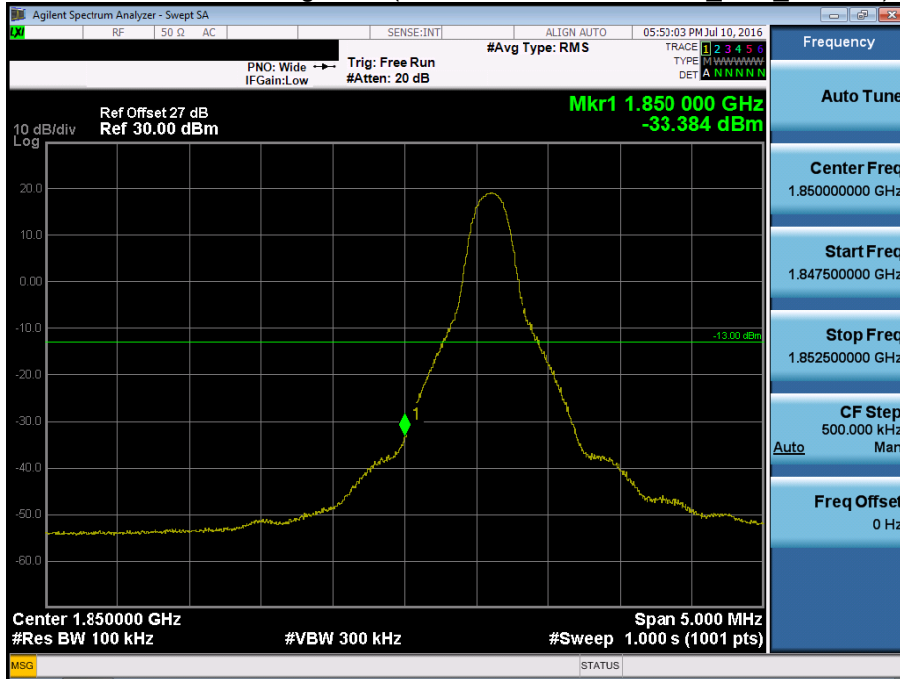

BAND 25. Lower Band Edge Plot (10M BW Ch. 26090 QPSK_RB50_Offset 0) -2



BAND 25. Lower Extended Band Edge Plot (10M BW Ch. 26090 QPSK_RB50_0) -3

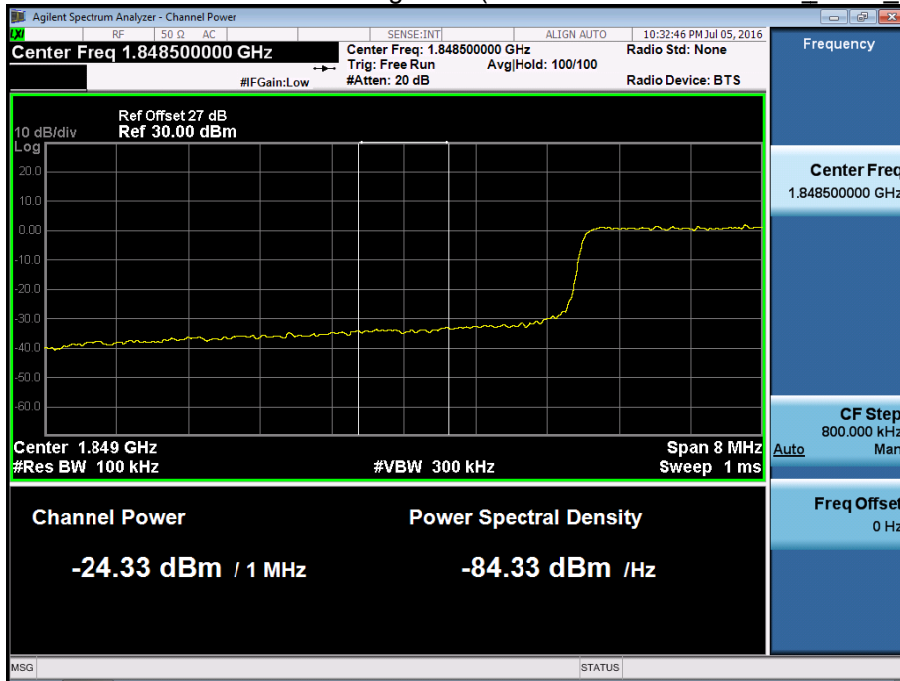

BAND 25. Lower Band Edge Plot (15M BW Ch.26115 QPSK_RB75_Offset 0) -1

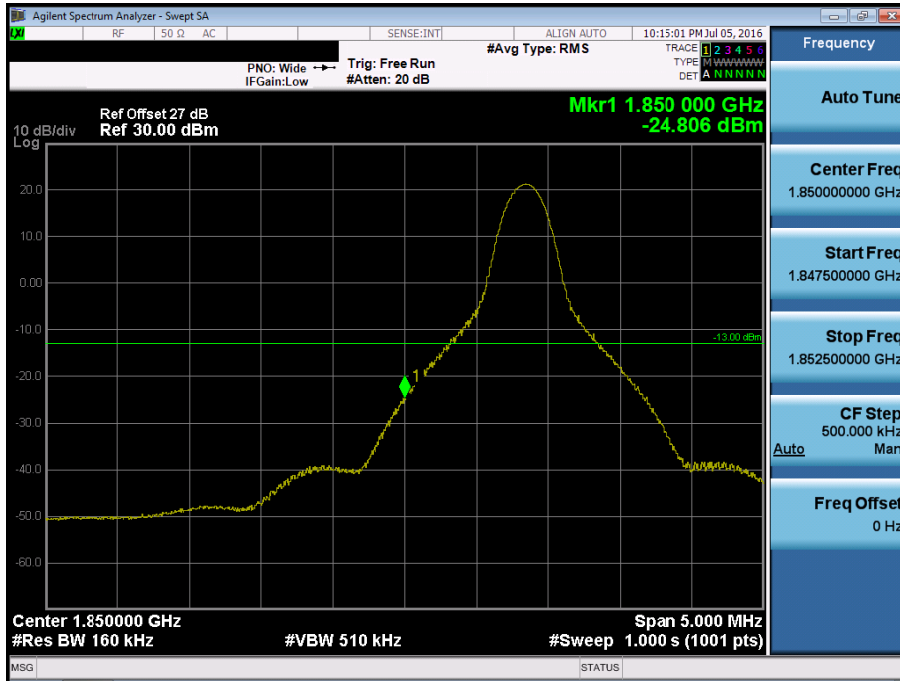

BAND 25. Lower Band Edge Plot (15M BW Ch. 26115 QPSK_RB75_Offset 0) -2



BAND 25. Lower Extended Band Edge Plot (15M BW Ch. 26115 QPSK_RB75_0) -3

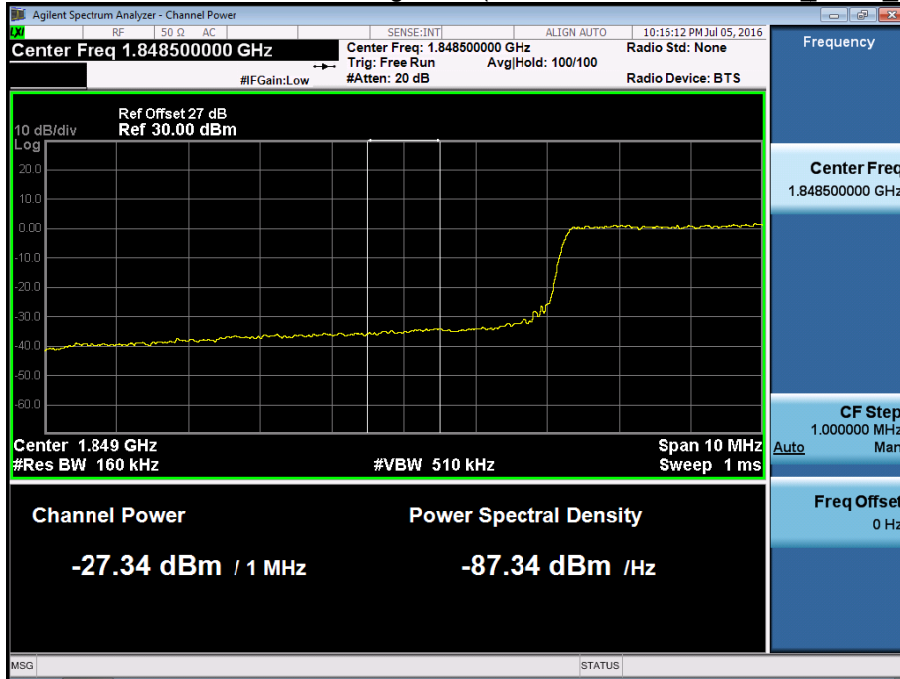

BAND 25. Lower Band Edge Plot (20M BW Ch.26140 QPSK_RB1_Offset 0) -1

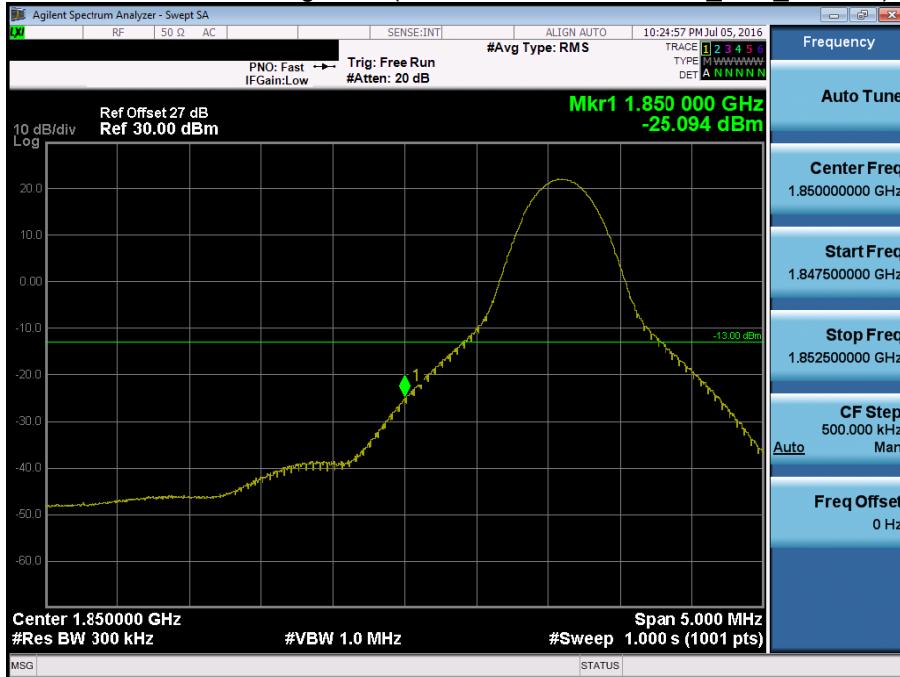

BAND 25. Lower Band Edge Plot (20M BW Ch. 26140 QPSK_RB100_Offset 0) -2

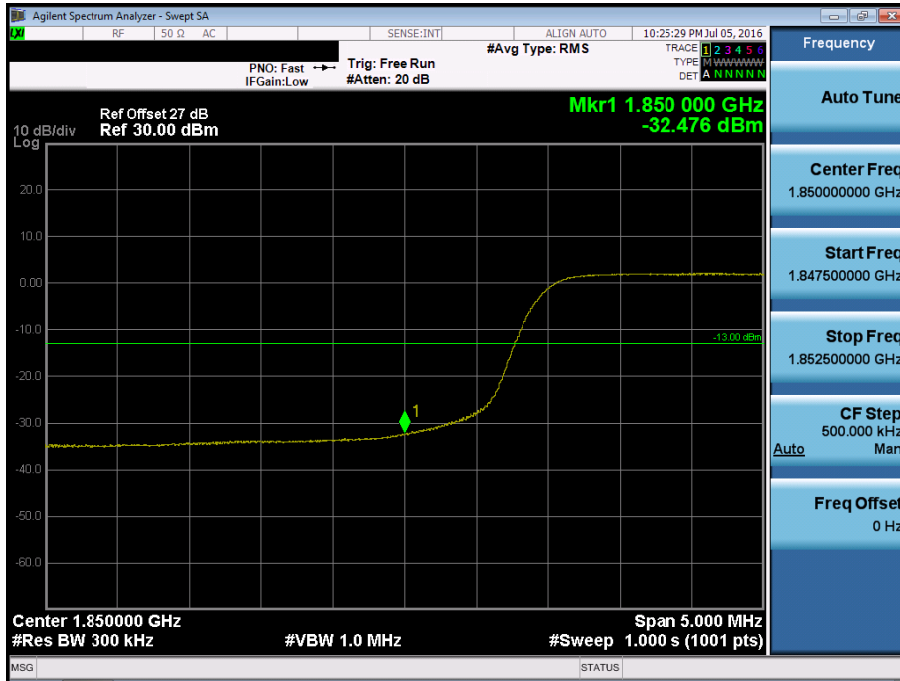

BAND 25. Lower Extended Band Edge Plot (20M BW Ch. 26140 QPSK_RB100_0) -3

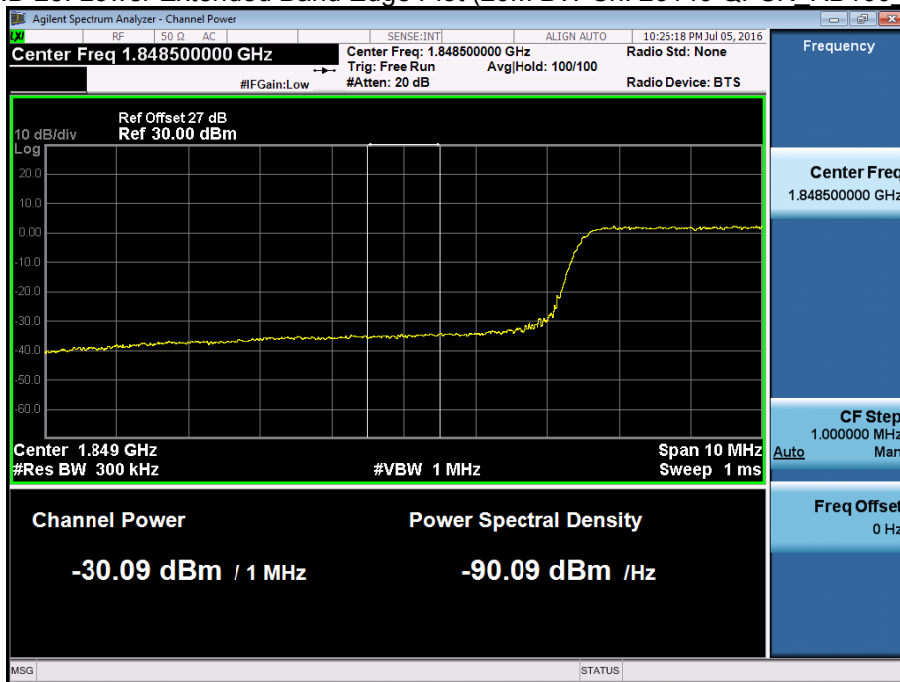

BAND 25. Upper Band Edge Plot (1.4M BW Ch.26683 QPSK_RB1_Offset 5) -1

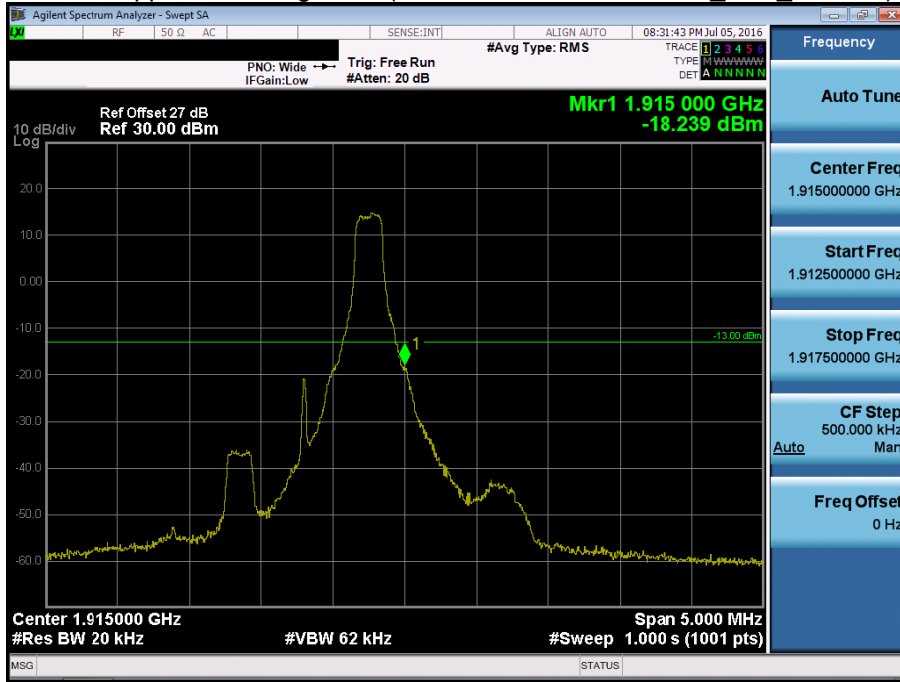

BAND 25. Upper Band Edge Plot (1.4M BW Ch. 26683 QPSK_RB6_Offset 0) -2

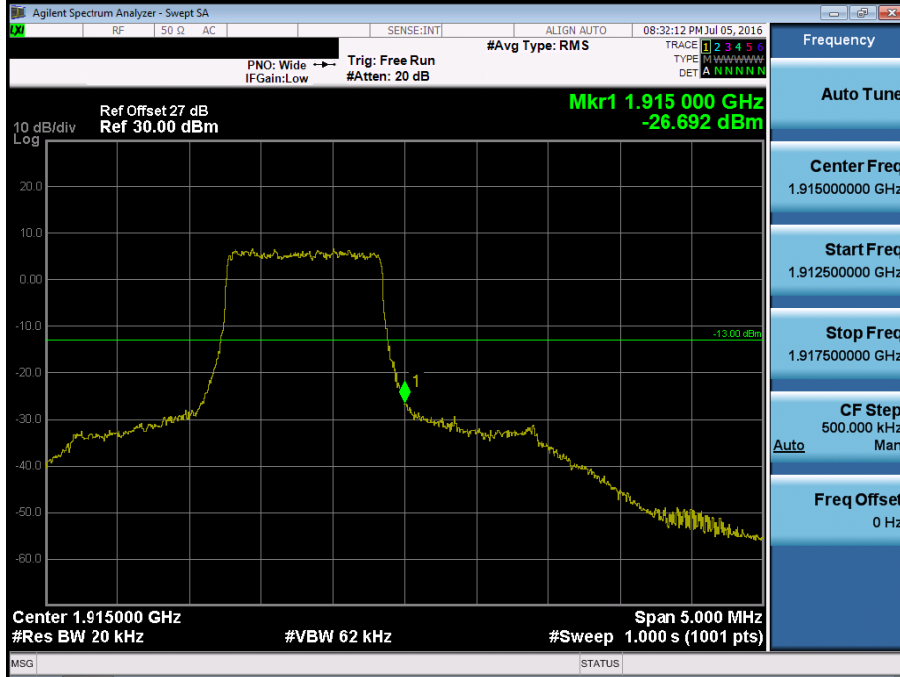

BAND 25. Upper Extended Band Edge Plot (1.4M BW Ch. 26683 QPSK_RB6_0) -3



BAND 25. Upper Band Edge Plot (3M BW Ch.26675 QPSK_RB1_Offset 14) -1

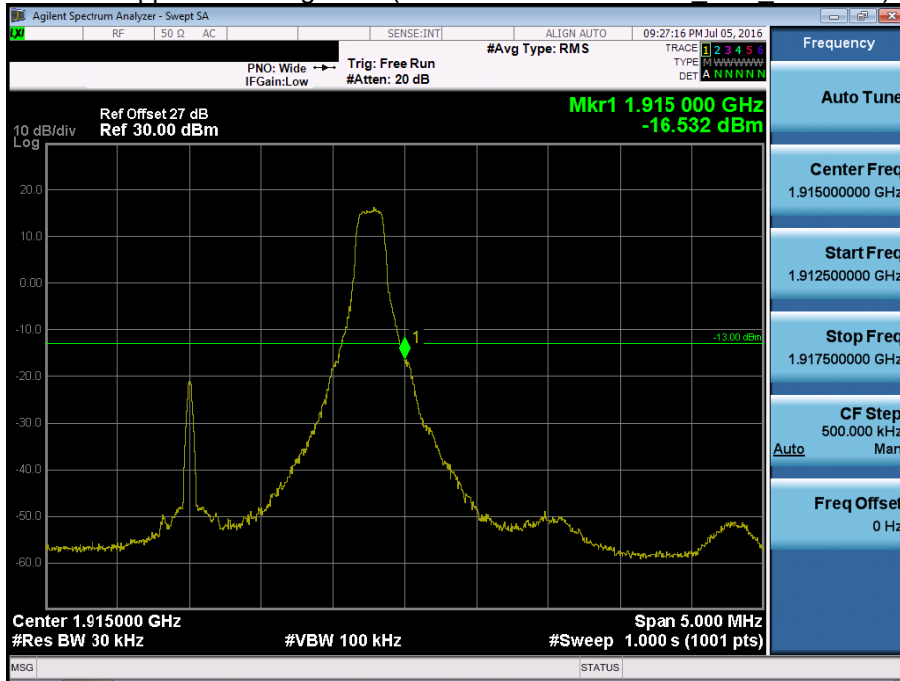

BAND 25. Upper Band Edge Plot (3M BW Ch. 26675 QPSK_RB15_Offset 0) -2

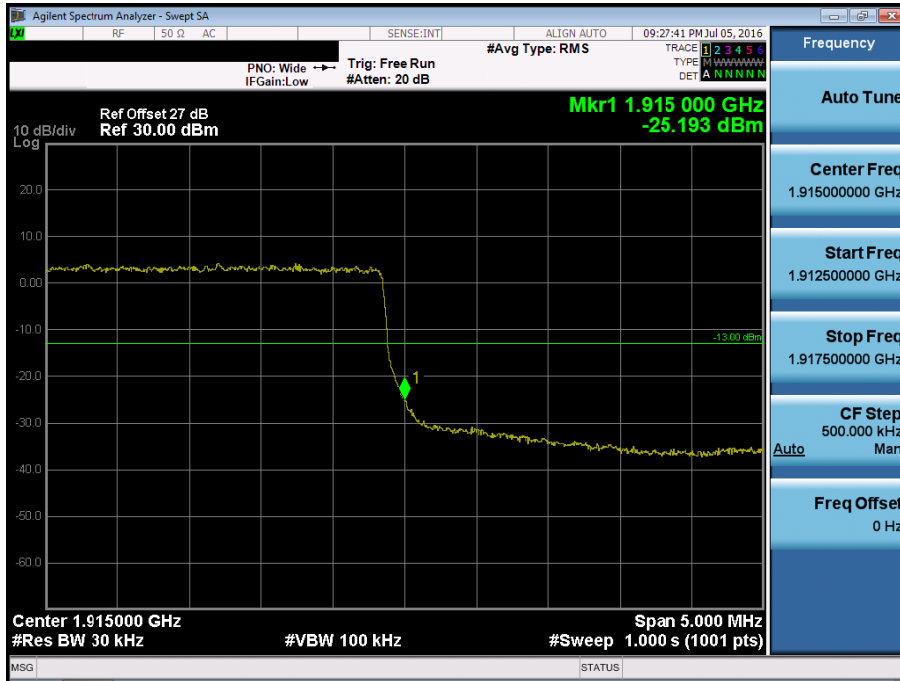

BAND 25. Upper Extended Band Edge Plot (3M BW Ch. 26675 QPSK_RB15 0) -3

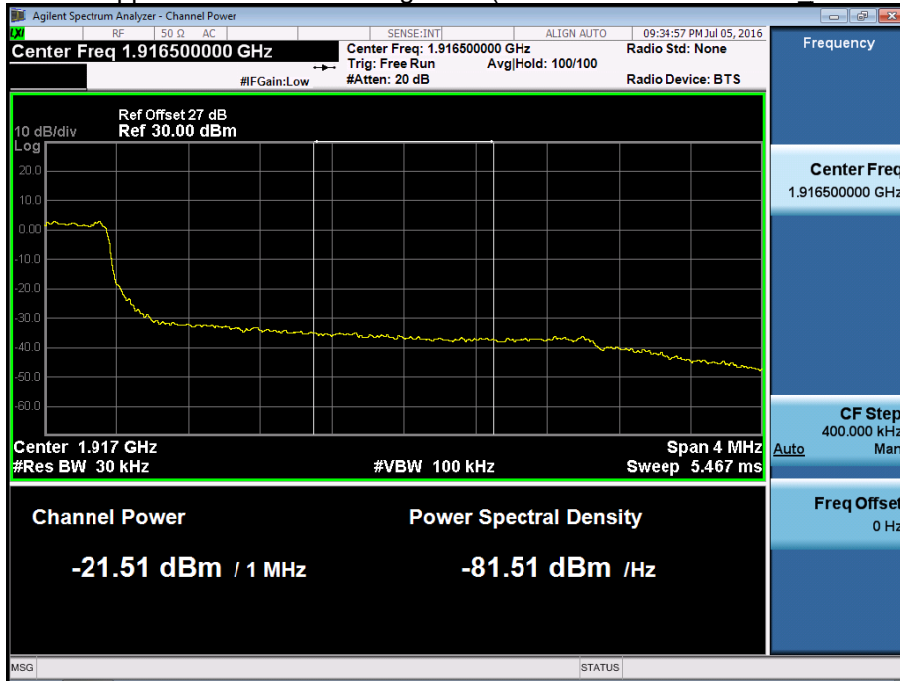

BAND 25. Upper Band Edge Plot (5M BW Ch.26665 QPSK_RB1_Offset 24) -1

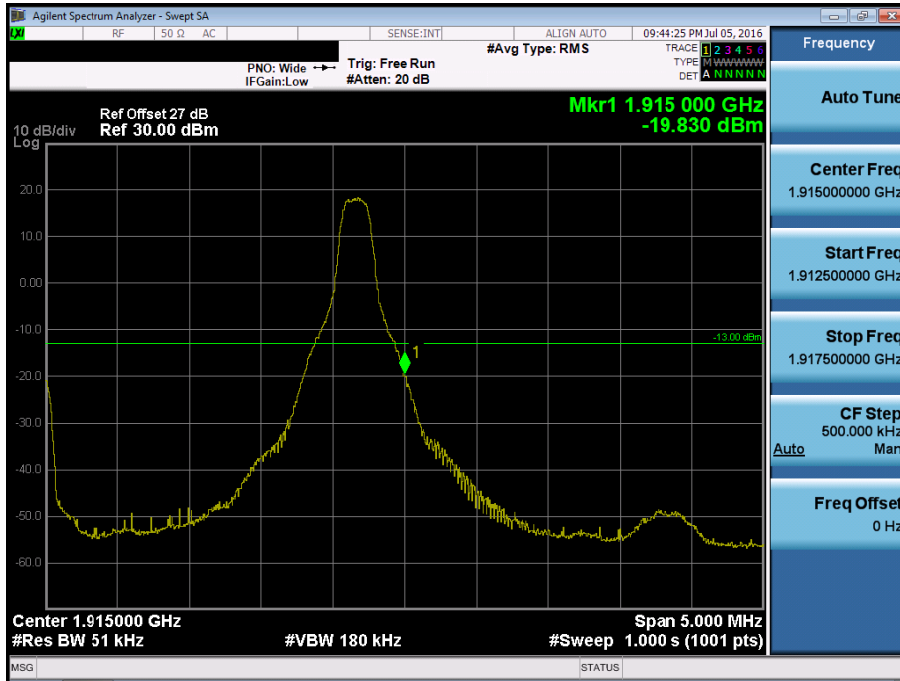

BAND 25. Upper Band Edge Plot (5M BW Ch. 26665 QPSK_RB25_Offset 0) -2



BAND 25. Upper Extended Band Edge Plot (5M BW Ch. 26665 QPSK_RB25_0) -3

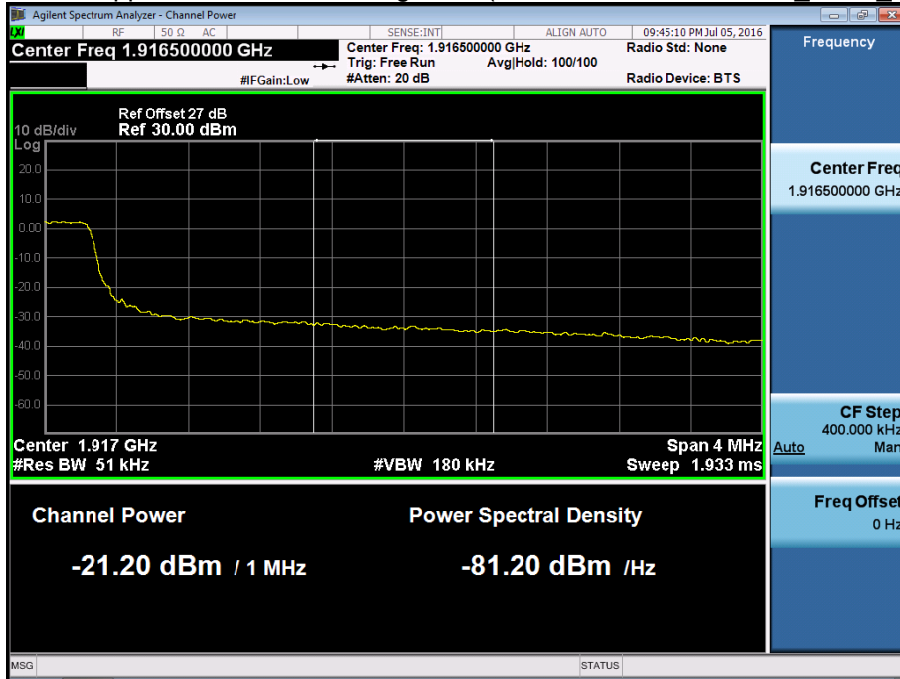

BAND 25. Upper Band Edge Plot (10M BW Ch.26640 QPSK_RB1_Offset 49) -1

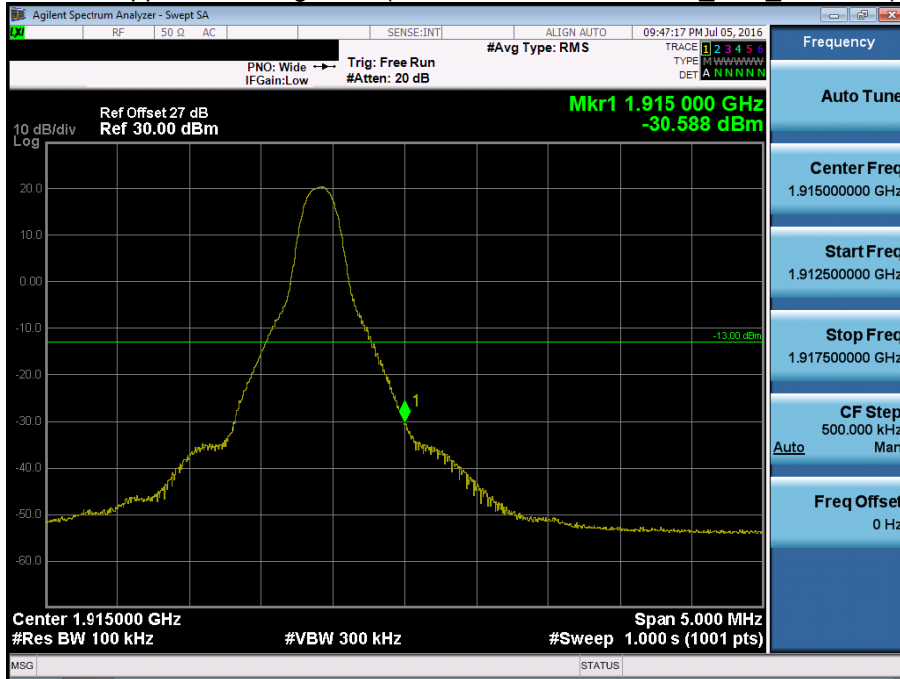

BAND 25. Upper Band Edge Plot (10M BW Ch. 26640 QPSK_RB50_Offset 0) -2

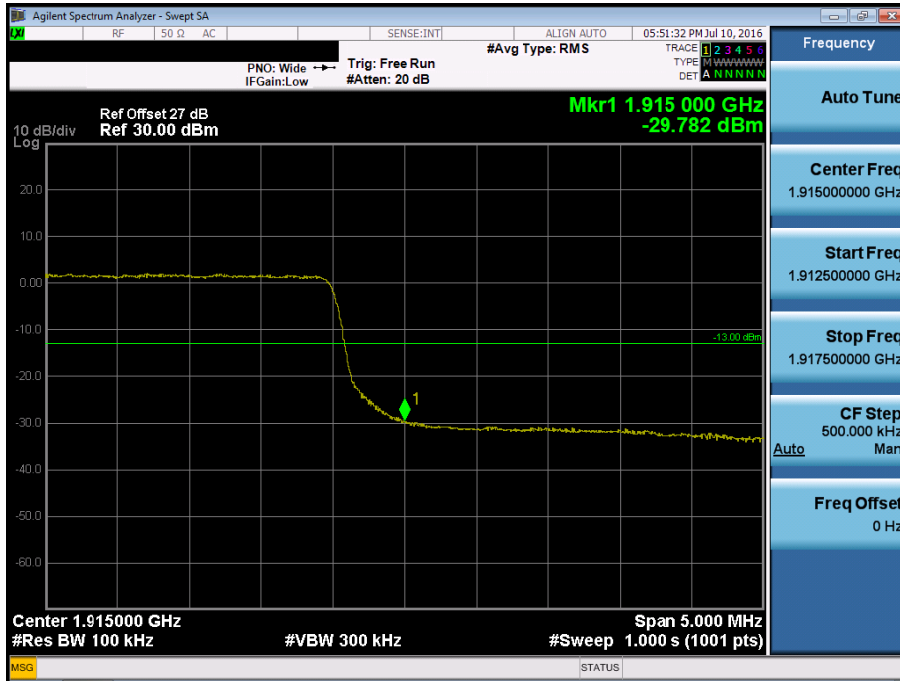

BAND 25. Upper Extended Band Edge Plot (10M BW Ch. 26640 QPSK_RB50_0) -3



BAND 25. Upper Band Edge Plot (15M BW Ch.26615 QPSK_RB1_Offset 74) -1

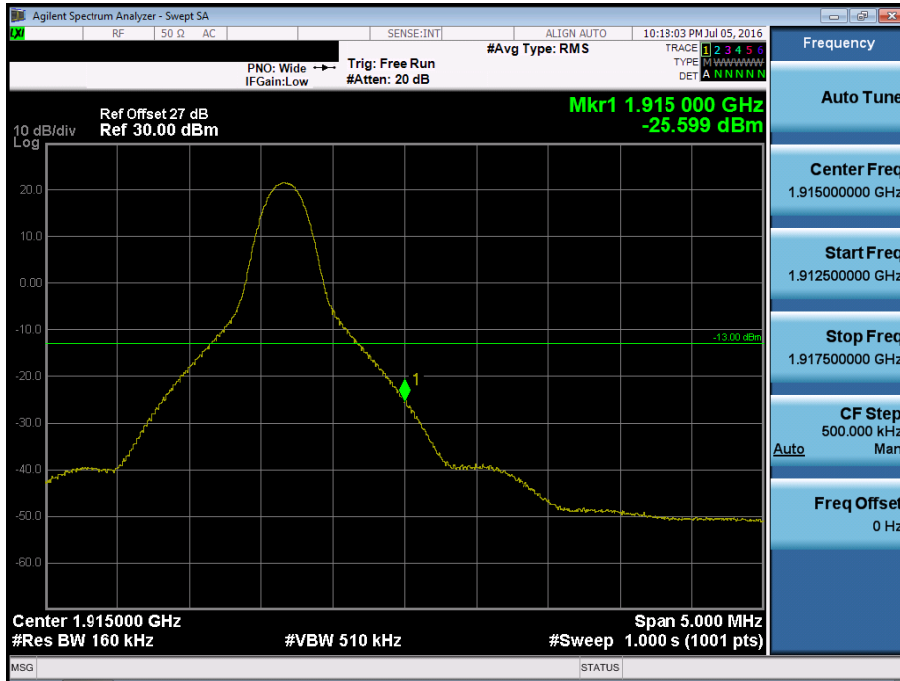

BAND 25. Upper Band Edge Plot (15M BW Ch. 26615 QPSK RB75 Offset 0) -2

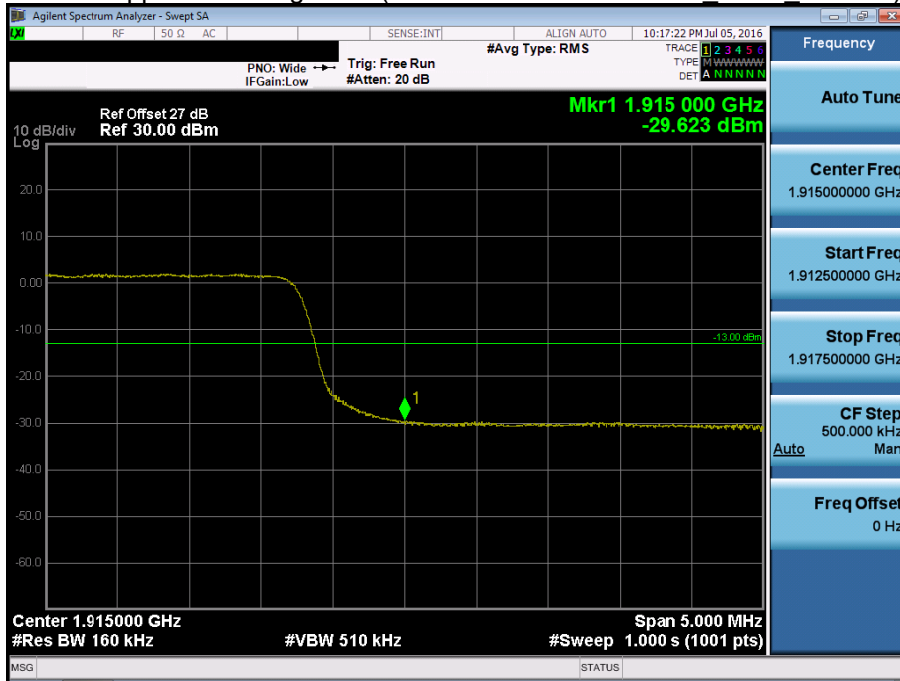

BAND 25. Upper Extended Band Edge Plot (15M BW Ch. 26615 QPSK_RB75_0) -3

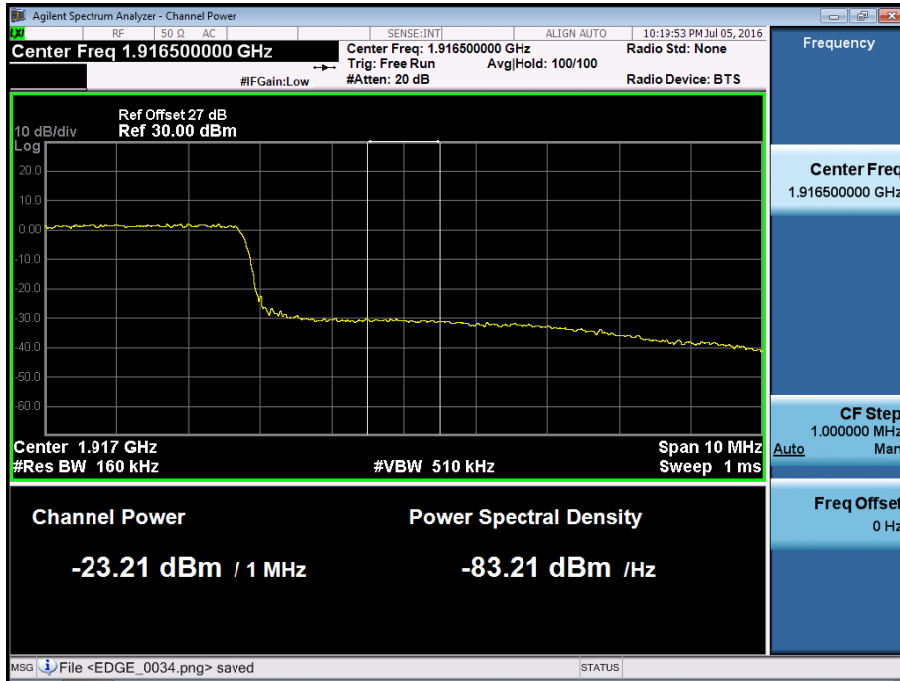

BAND 25. Upper Band Edge Plot (20M BW Ch.26590 QPSK_RB1_Offset 99) -1

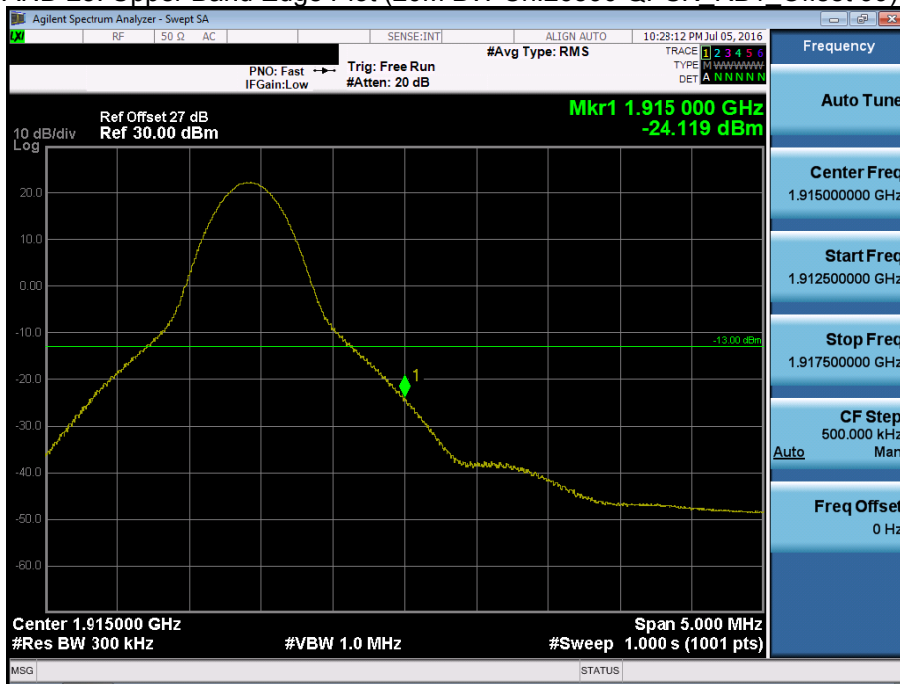

BAND 25. Upper Band Edge Plot (20M BW Ch. 26590 QPSK_RB100_Offset 0) -2



BAND 25. Upper Extended Band Edge Plot (20M BW Ch. 26590 QPSK_RB100_0) -3

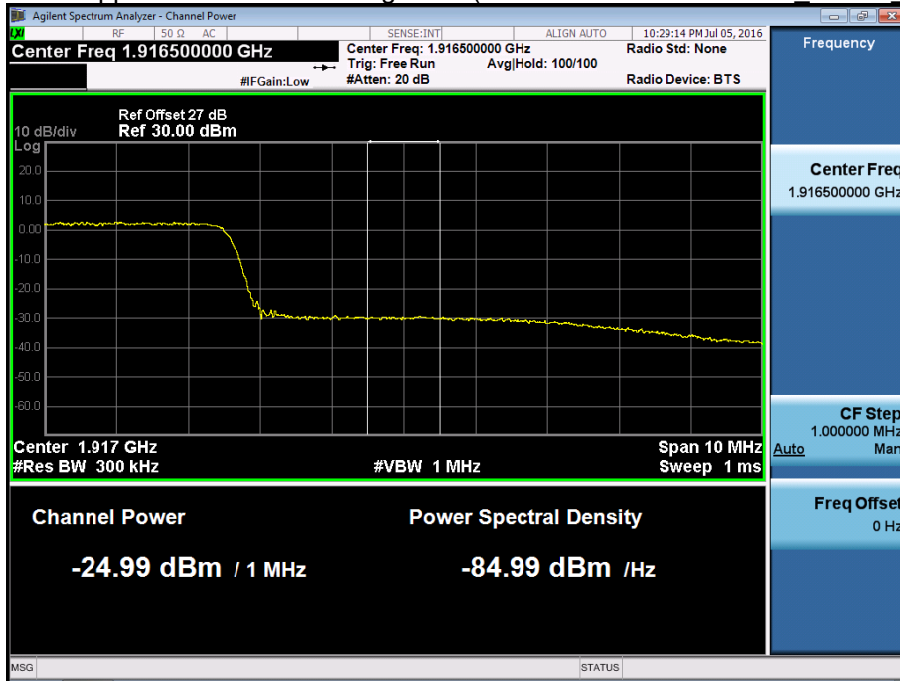

BAND 25. Conducted Spurious_1 (26047ch_1.4MHz_QPSK_RB 1_0)

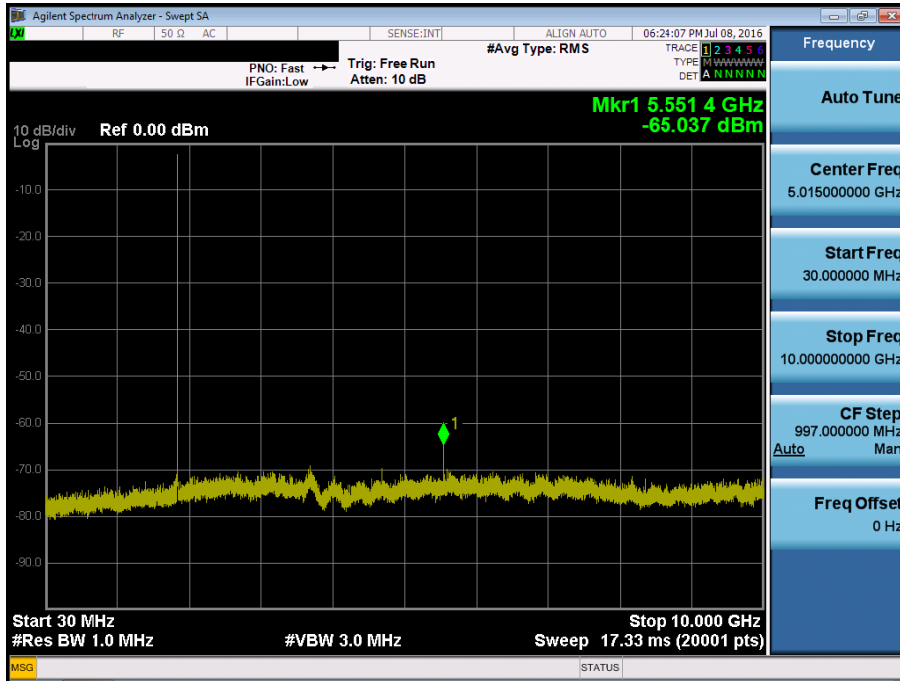

BAND 25. Conducted Spurious_2 (26047ch 1.4MHz QPSK RB 1_0)

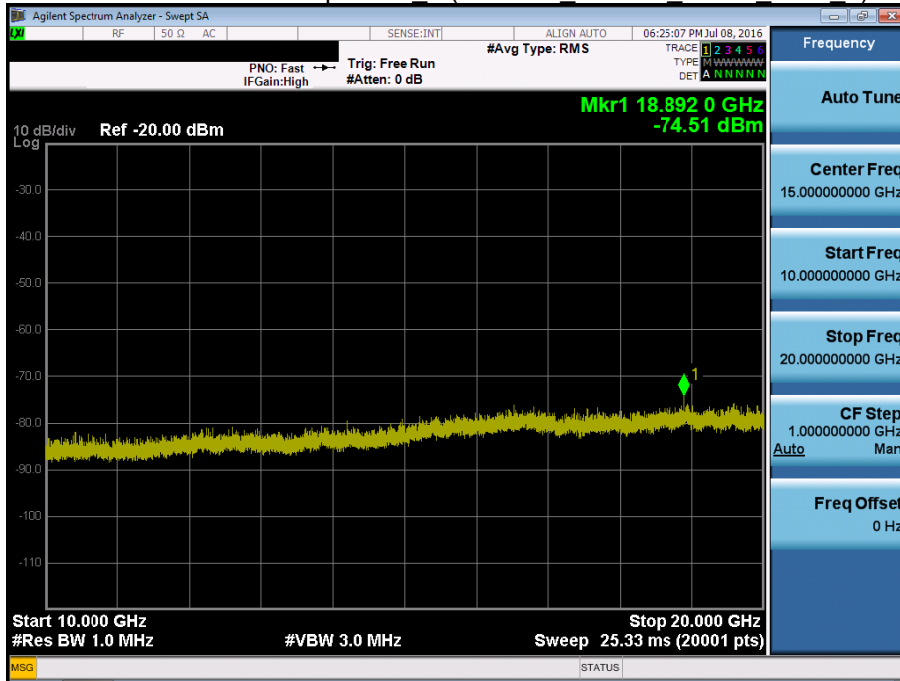

BAND 25. Conducted Spurious_1 (26365 ch_1.4MHz_QPSK_RB 1_0)

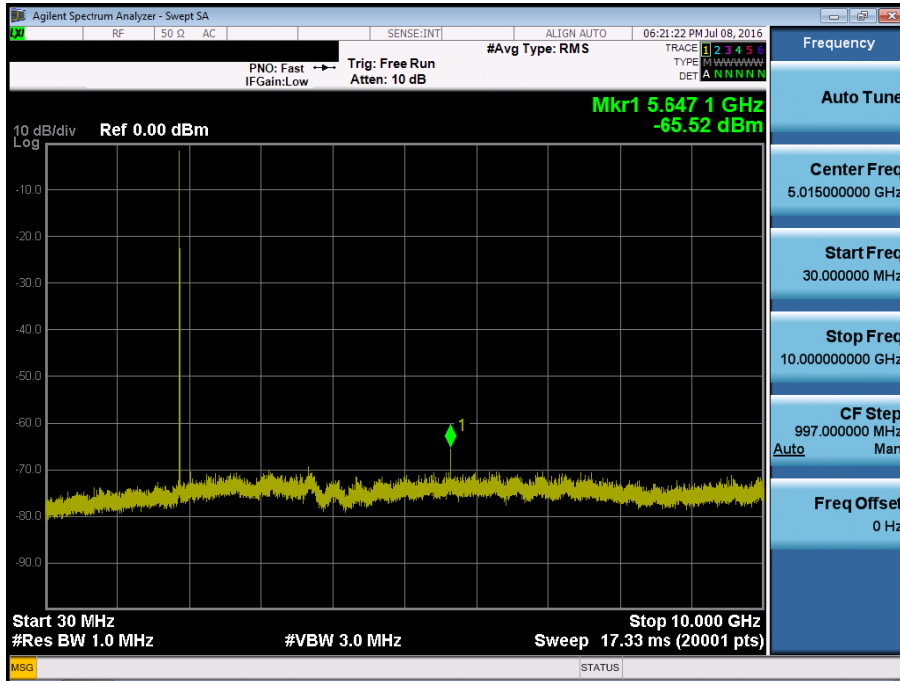

BAND 25. Conducted Spurious_2 (26365ch 1.4MHz QPSK RB 1_0)

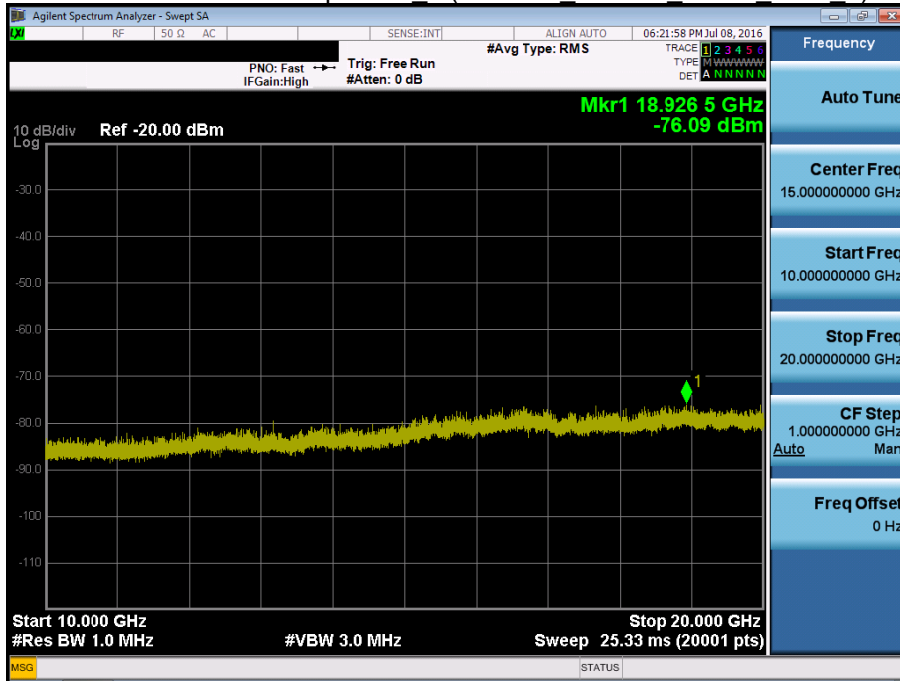

BAND 25. Conducted Spurious_1 (26683 ch_1.4MHz_QPSK_RB 1_0)

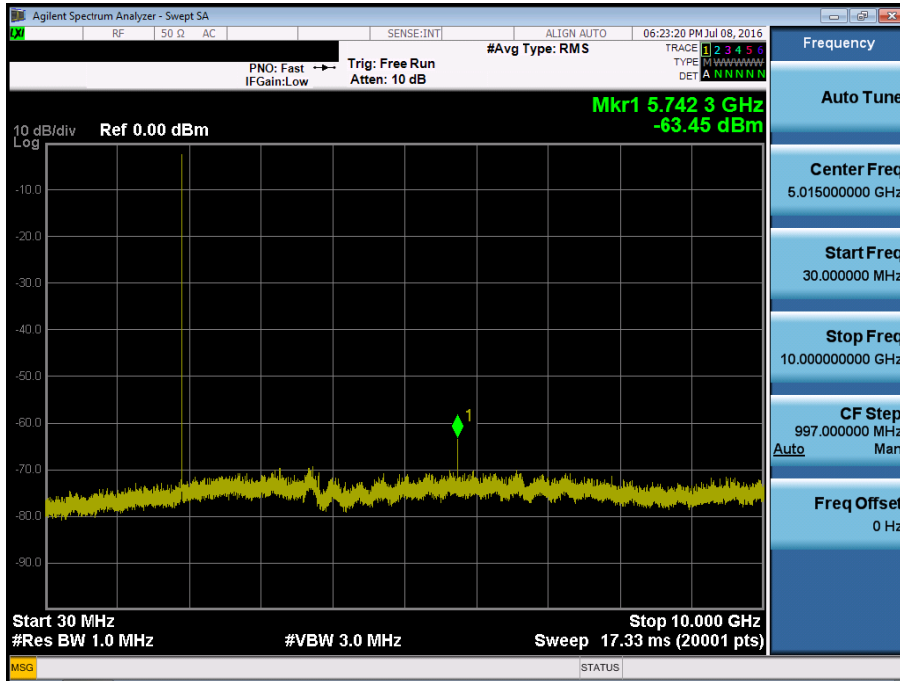

BAND 25. Conducted Spurious_2 (26683 ch_1.4MHz_QPSK_RB 1_0)

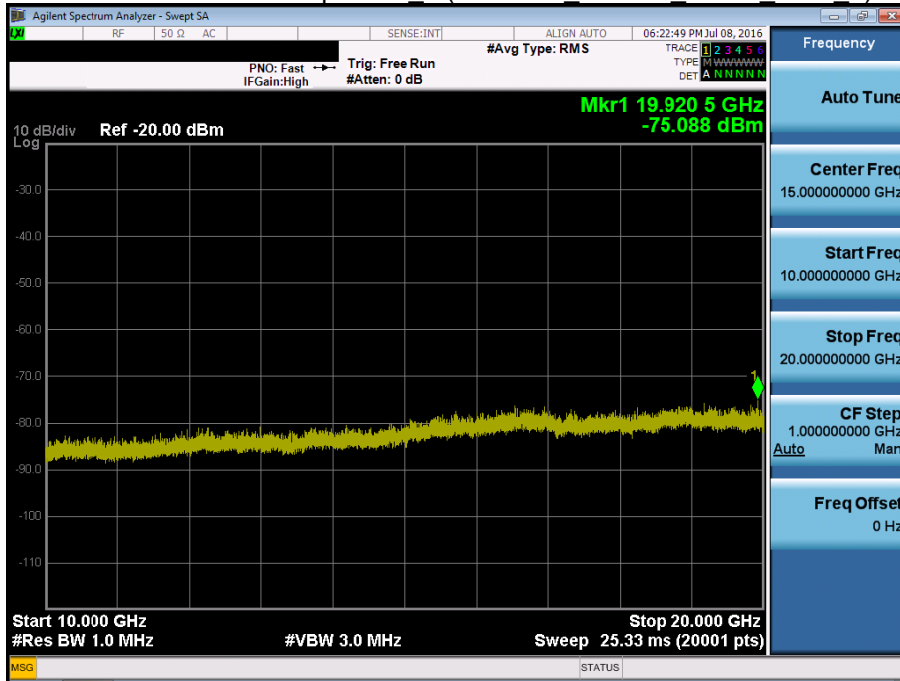

BAND 25. Conducted Spurious_1 (26055 ch_3MHz_QPSK_RB 1_0)

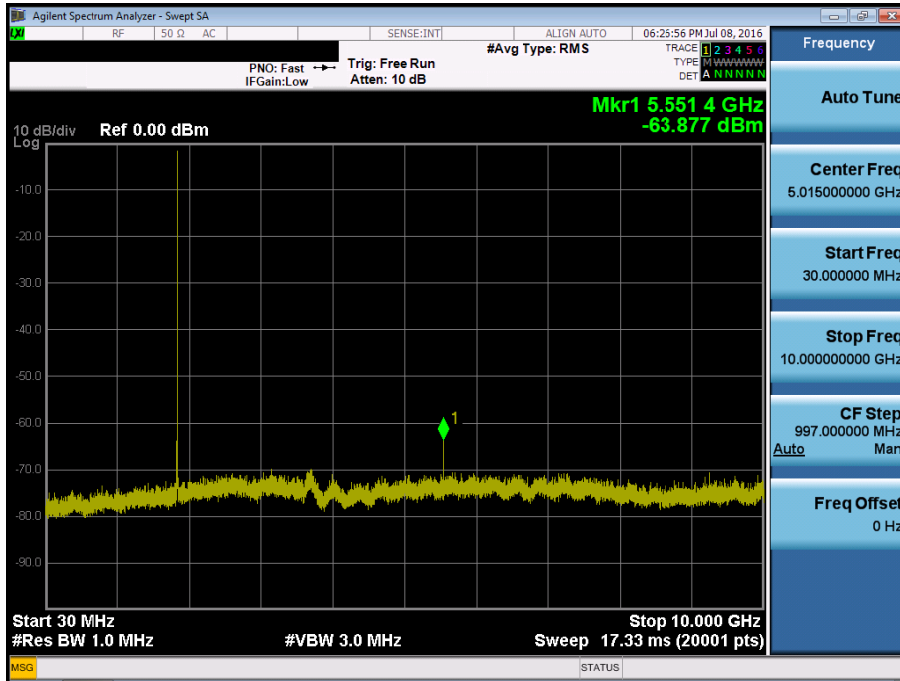

BAND 25. Conducted Spurious_2 (26055 ch_3MHz_QPSK_RB 1_0)

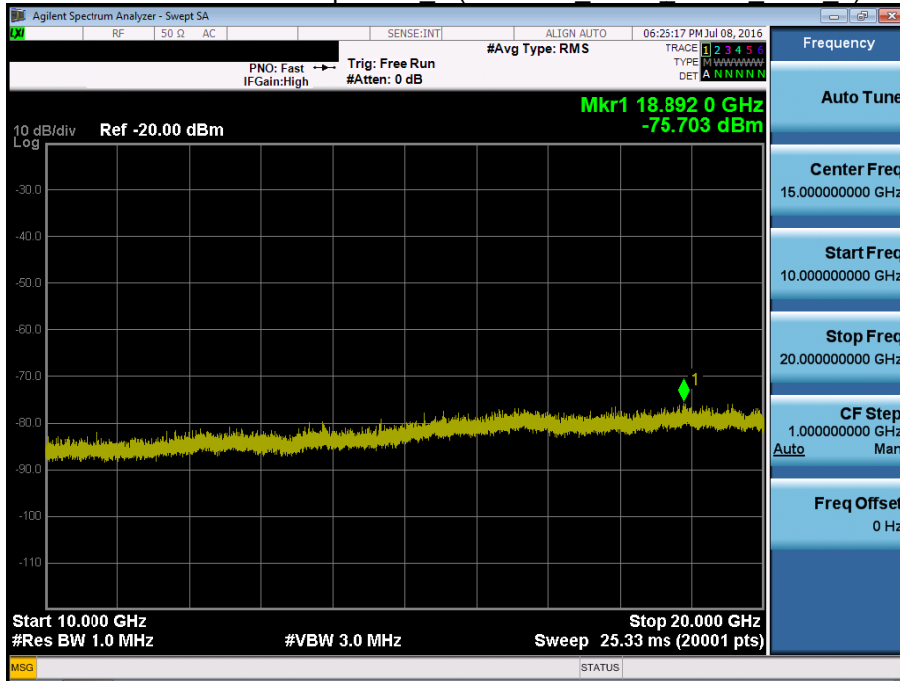

BAND 25. Conducted Spurious_1 (26365 ch_3MHz_QPSK_RB 1_0)

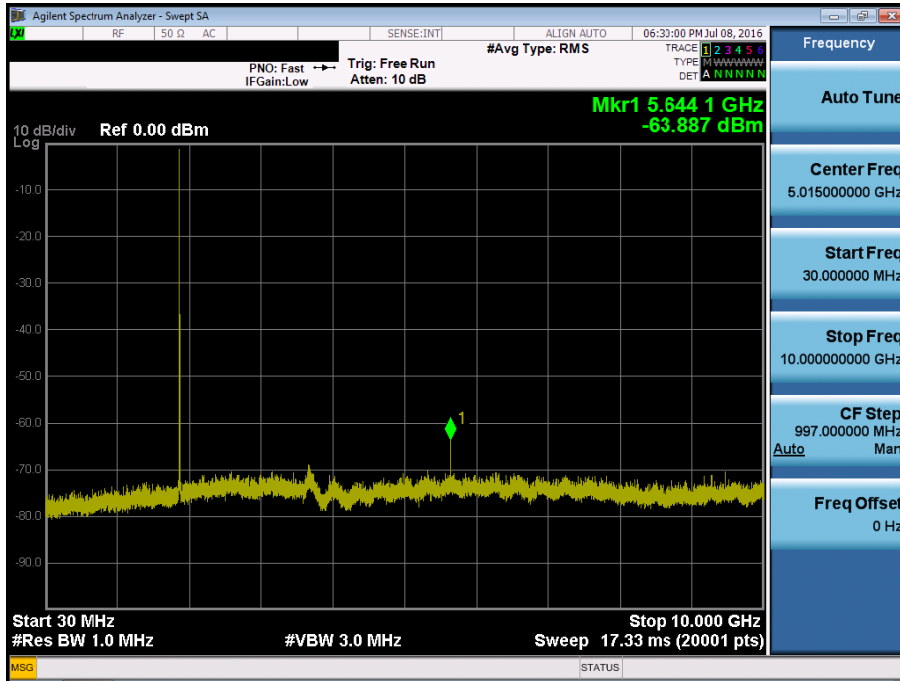

BAND 25. Conducted Spurious_2 (26365 ch_3MHz_QPSK_RB 1_0)

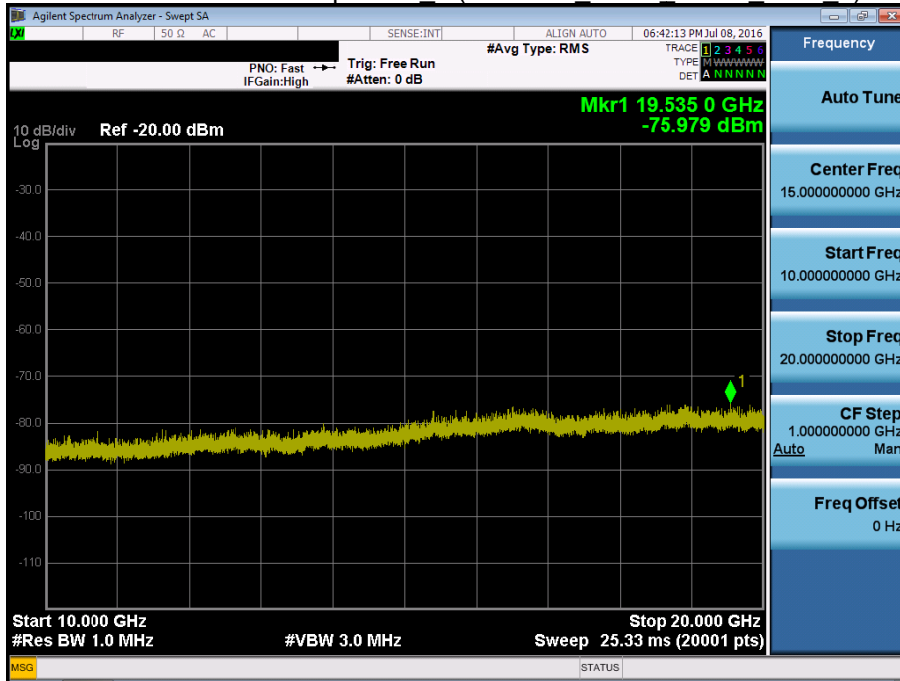

BAND 25. Conducted Spurious_1 (26675 ch_3MHz_QPSK_RB 1_0)

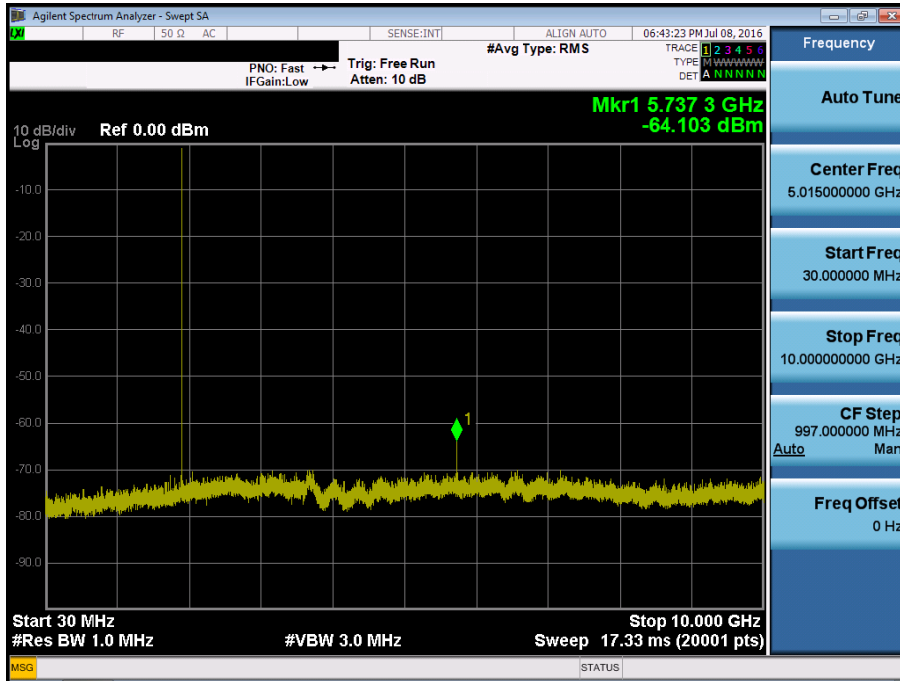

BAND 25. Conducted Spurious_2 (26675 ch_3MHz_QPSK_RB 1_0)

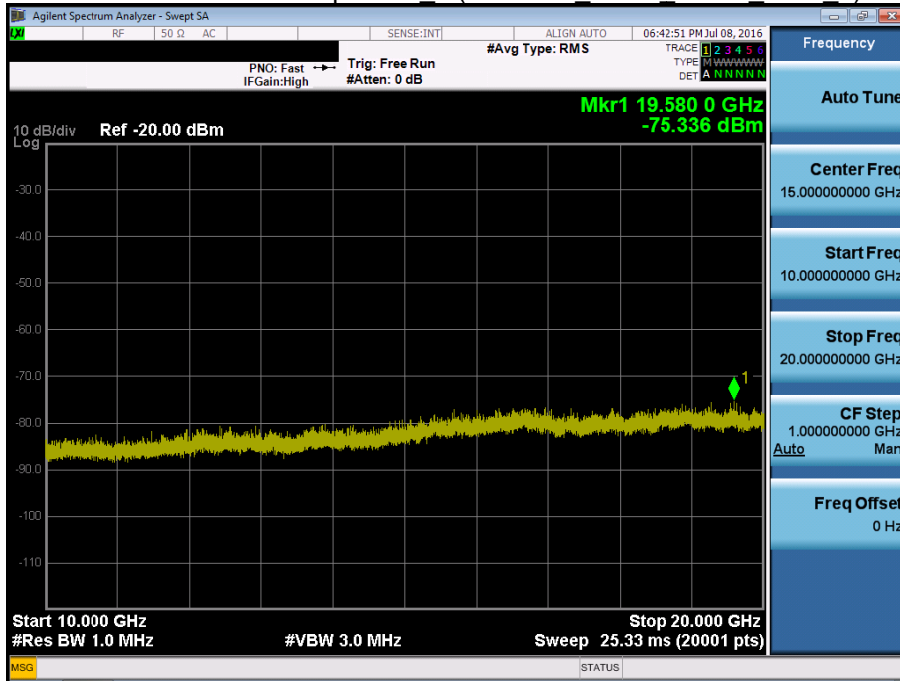

BAND 25. Conducted Spurious_1 (26065 ch_5MHz_QPSK_RB 1_0)

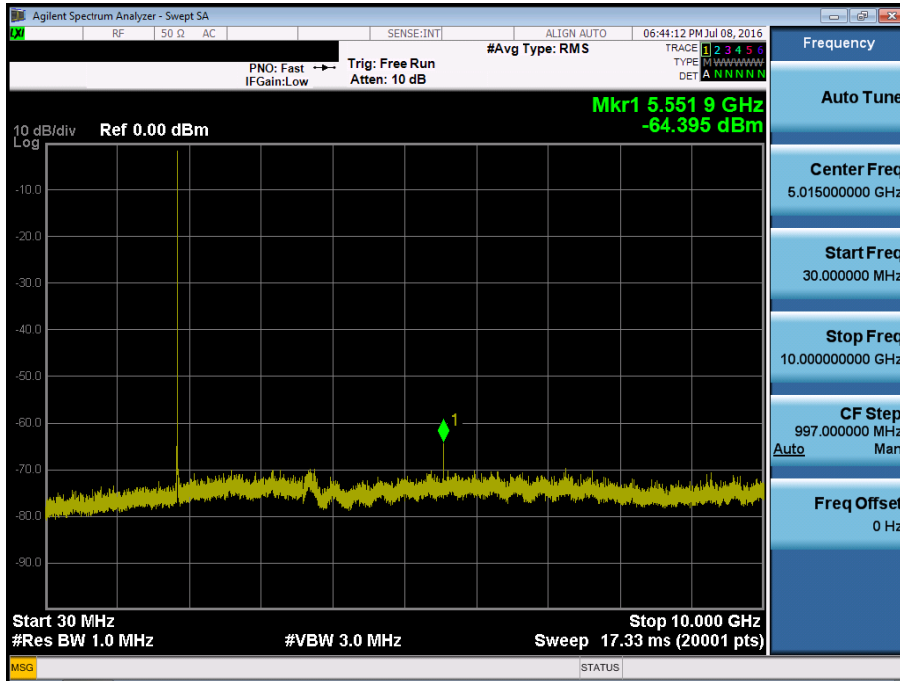

BAND 25. Conducted Spurious_2 (26065 ch_5MHz_QPSK_RB 1_0)

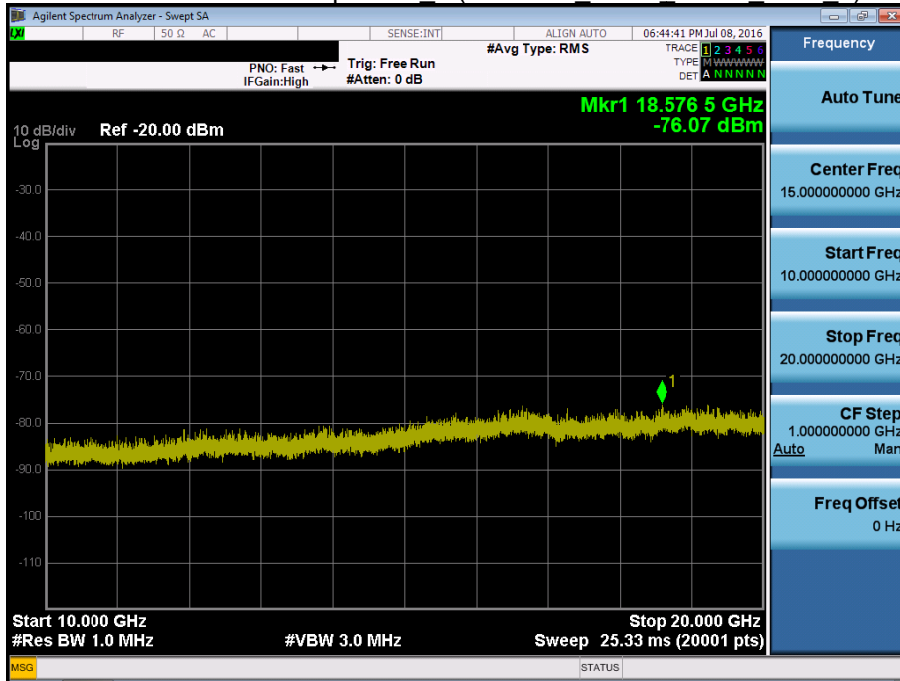

BAND 25. Conducted Spurious_1 (26365 ch_5MHz_QPSK_RB 1_0)

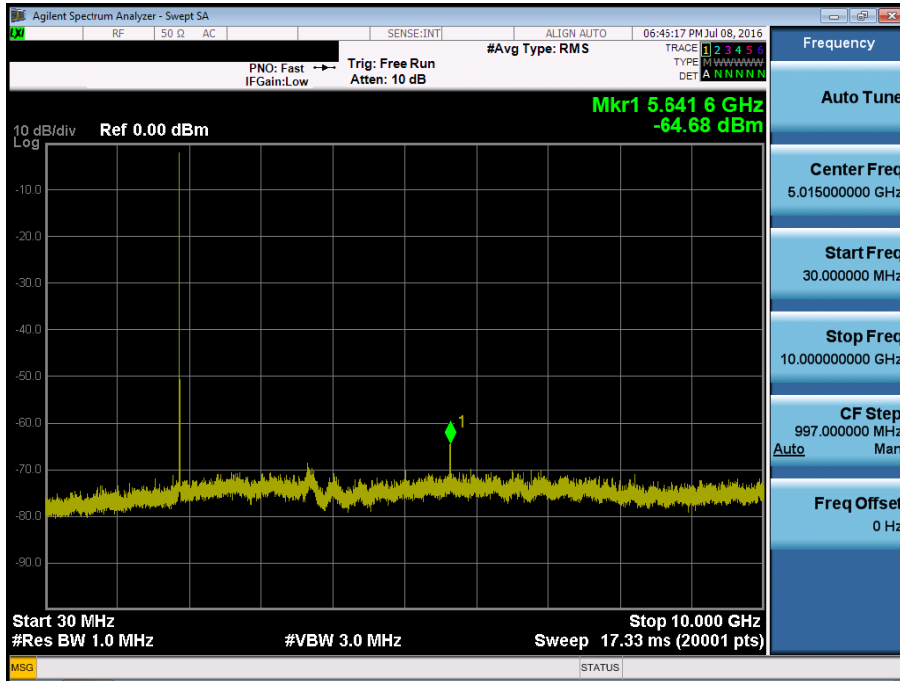

BAND 25. Conducted Spurious_2 (26365 ch_5MHz_QPSK_RB 1_0)

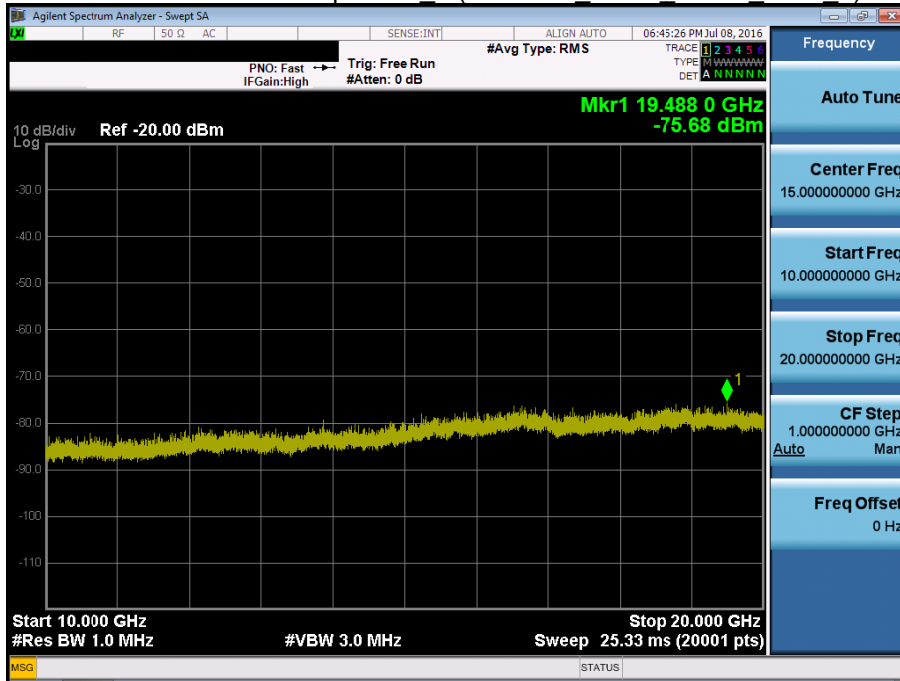

BAND 25. Conducted Spurious_1 (26665 ch_5MHz_QPSK_RB 1_0)

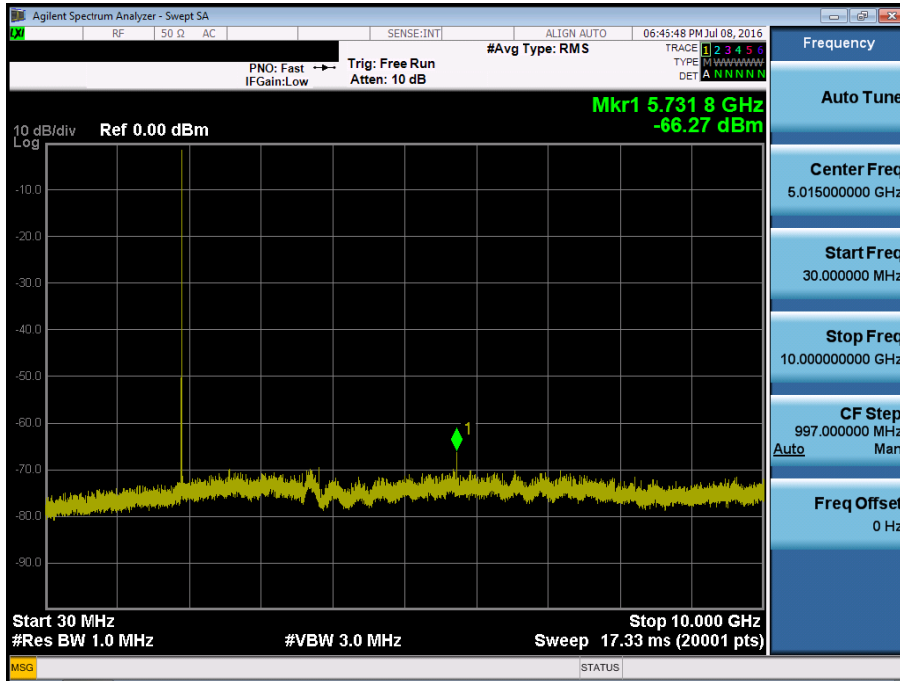

BAND 25. Conducted Spurious_2 (26665 ch_5MHz_QPSK_RB 1_0)

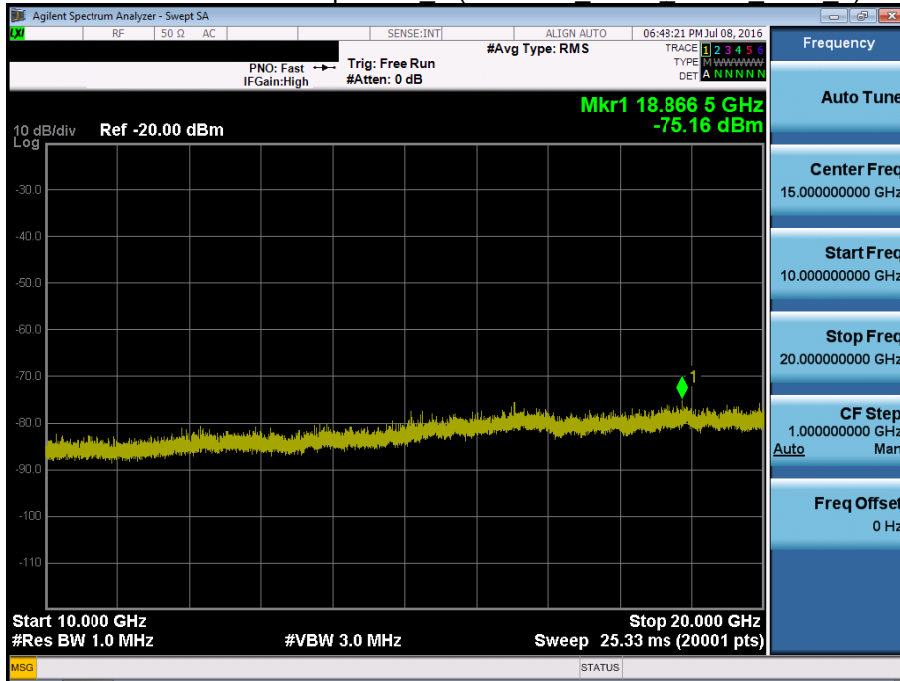

BAND 25. Conducted Spurious_1 (26090 ch_10MHz_QPSK_RB 1_0)

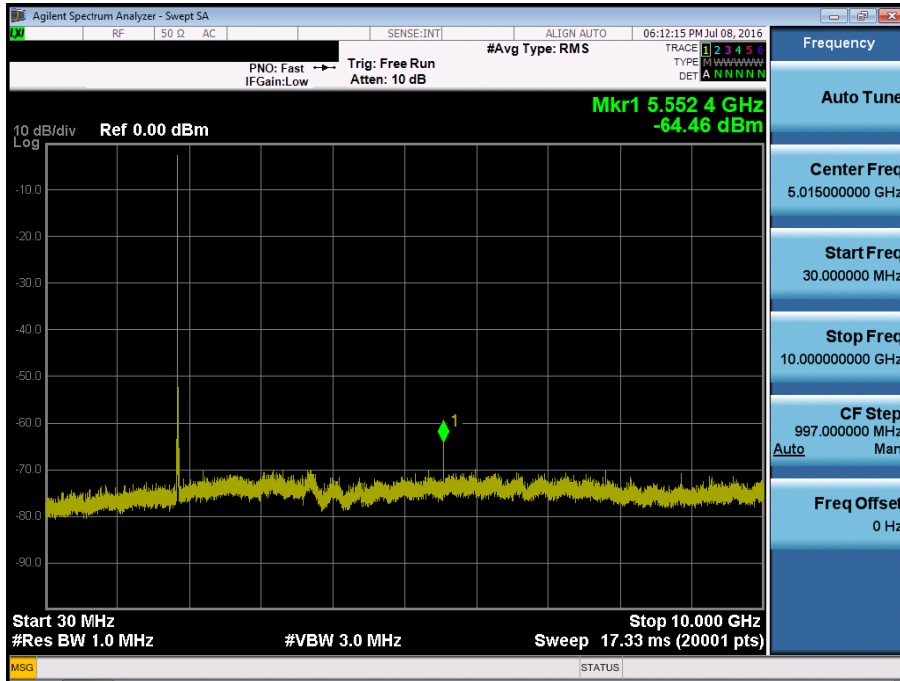

BAND 25. Conducted Spurious_2 (26090 ch_10MHz_QPSK_RB 1_0)

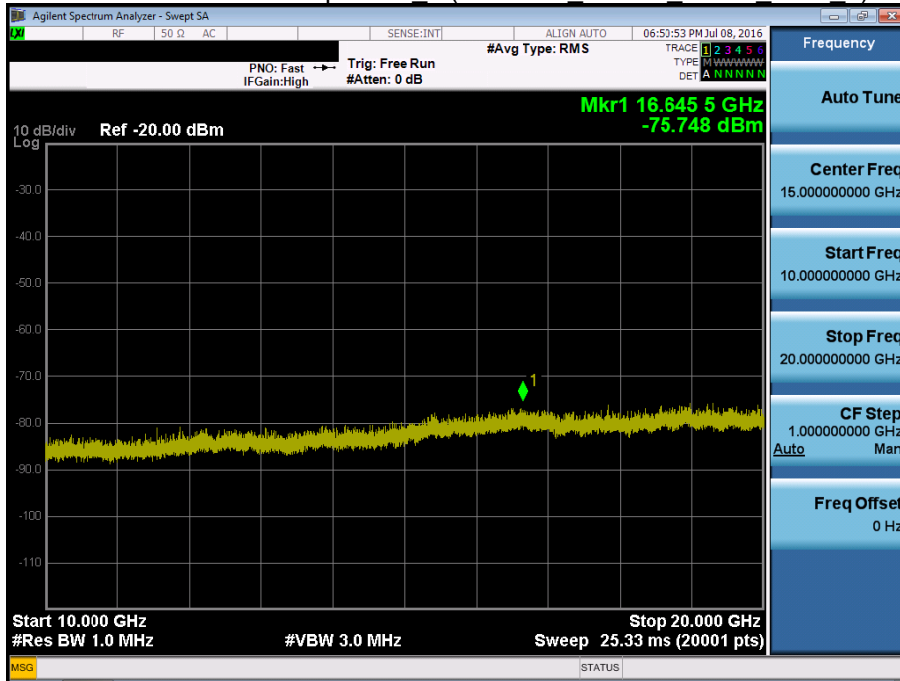

BAND 25. Conducted Spurious_1 (26365 ch_10MHz_QPSK_RB 1_0)

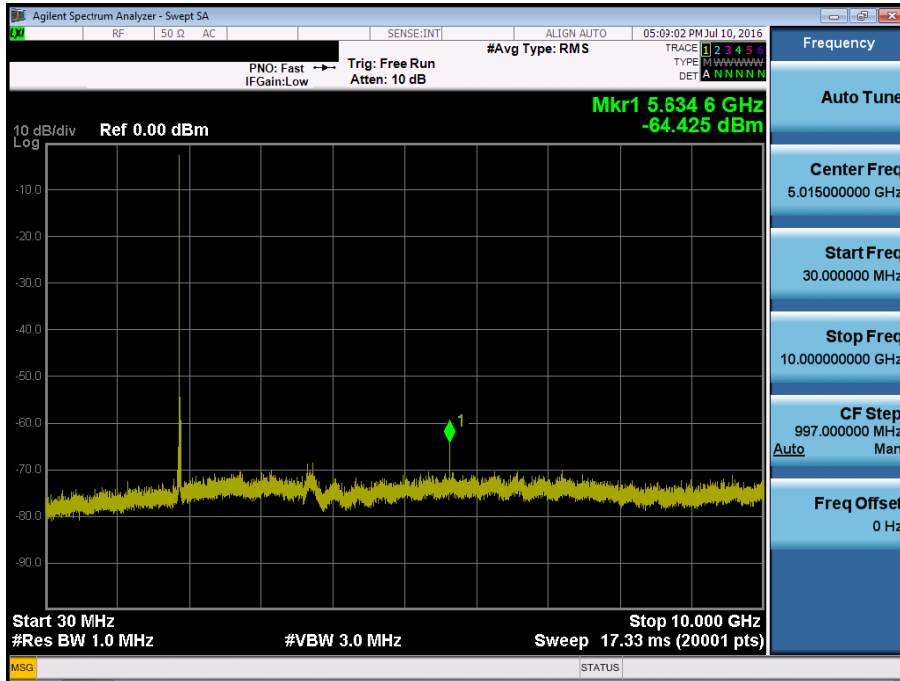

BAND 25. Conducted Spurious_2 (26365 ch 10MHz QPSK RB 1_0)

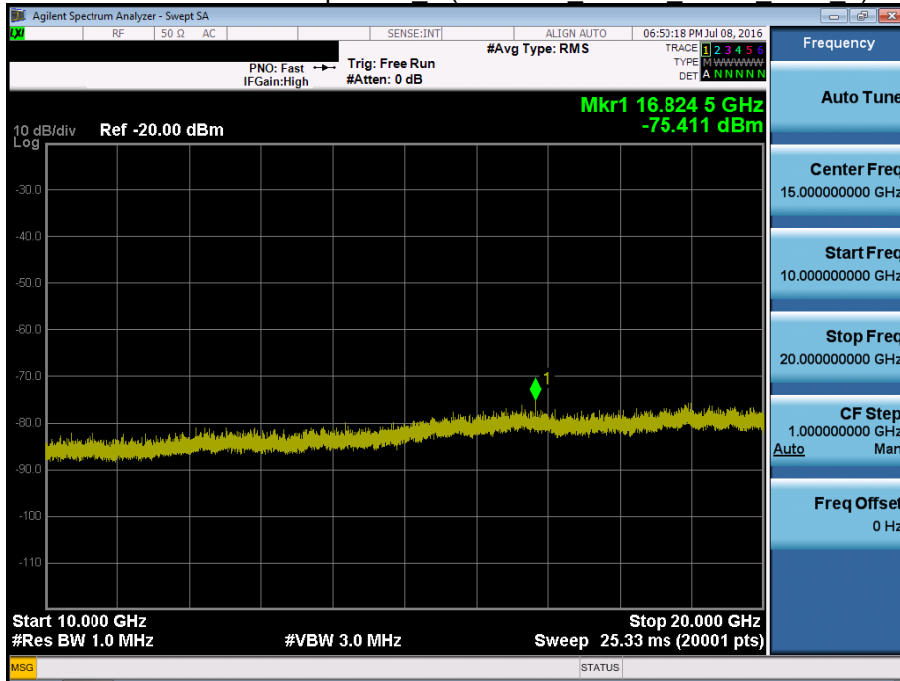

BAND 25. Conducted Spurious_1 (26640 ch_10MHz_QPSK_RB 1_0)

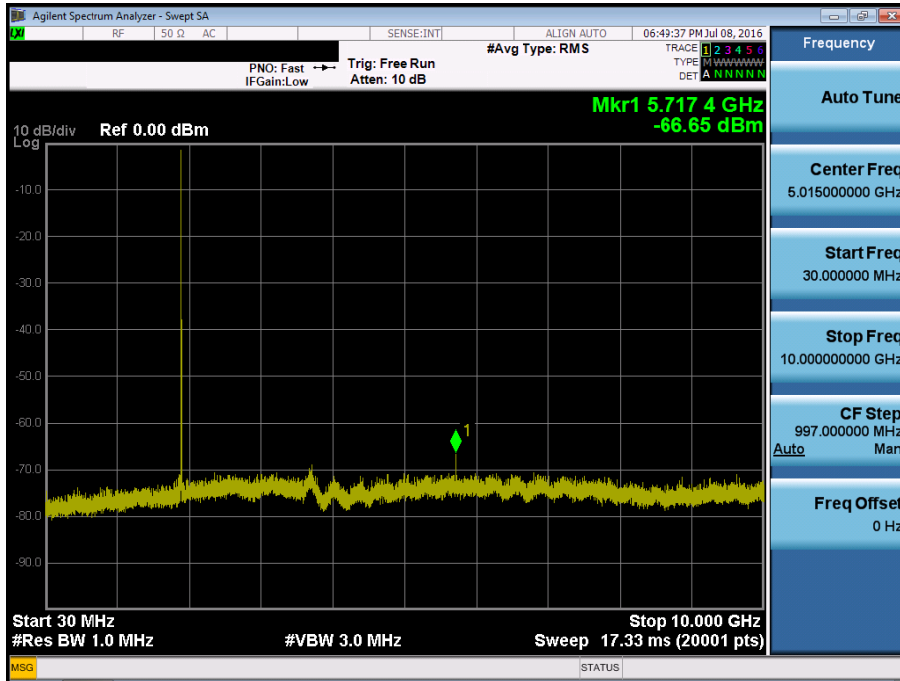

BAND 25. Conducted Spurious_2 (26640 ch_10MHz_QPSK_RB 1_0)

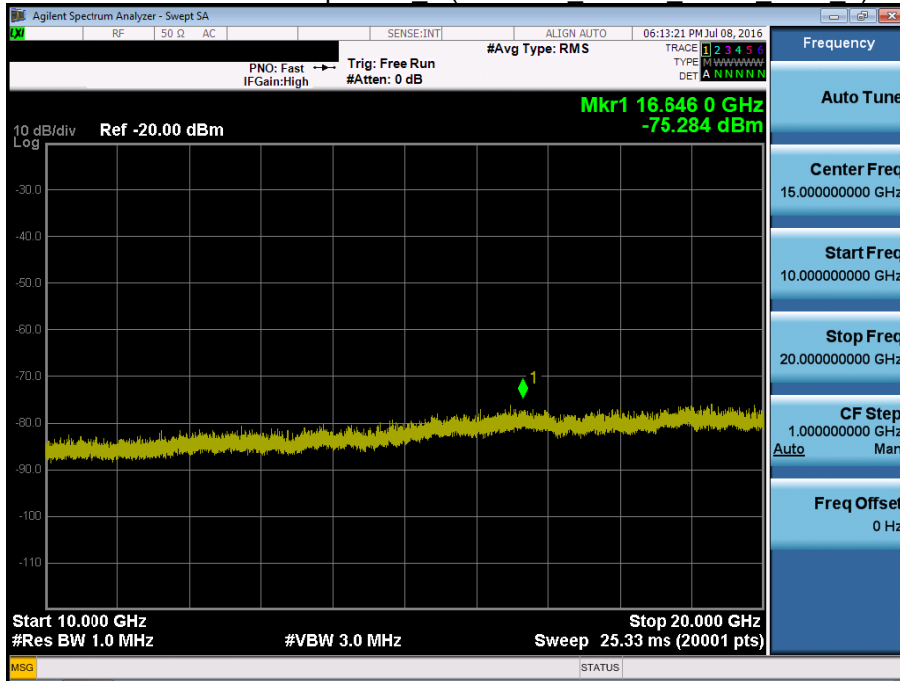

BAND 25. Conducted Spurious_1 (26115 ch_15MHz_QPSK_RB 1_0)

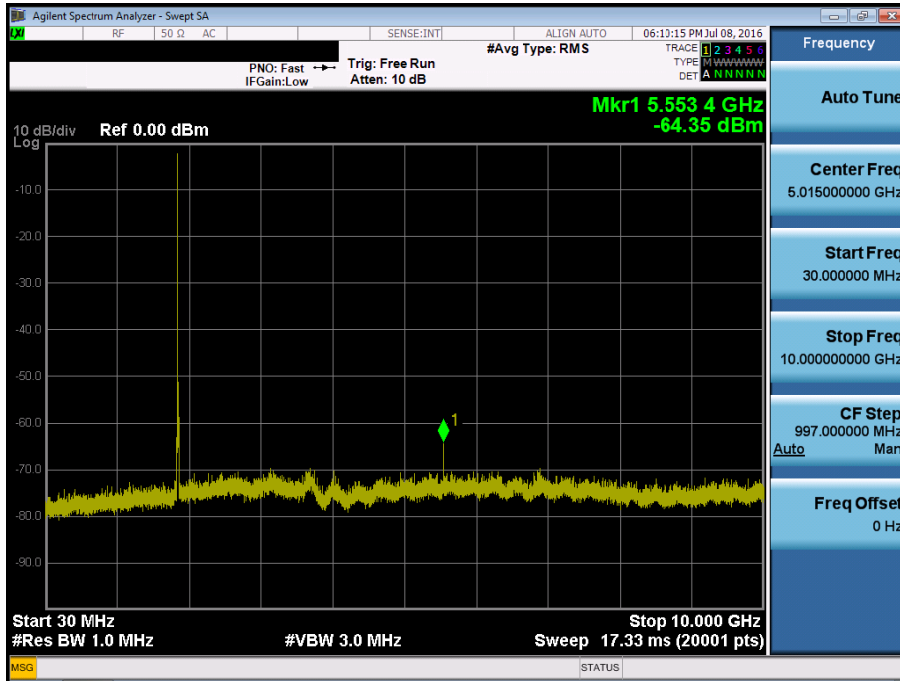

BAND 25. Conducted Spurious_2 (26115 ch_15MHz_QPSK_RB 1_0)

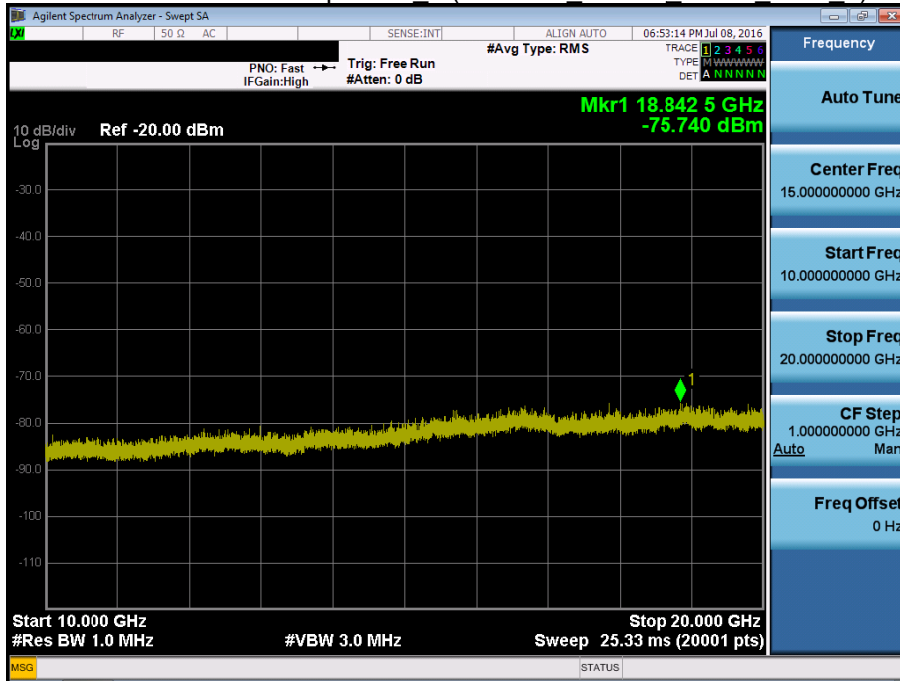

BAND 25. Conducted Spurious_1 (26365 ch_15MHz_QPSK_RB 1_0)

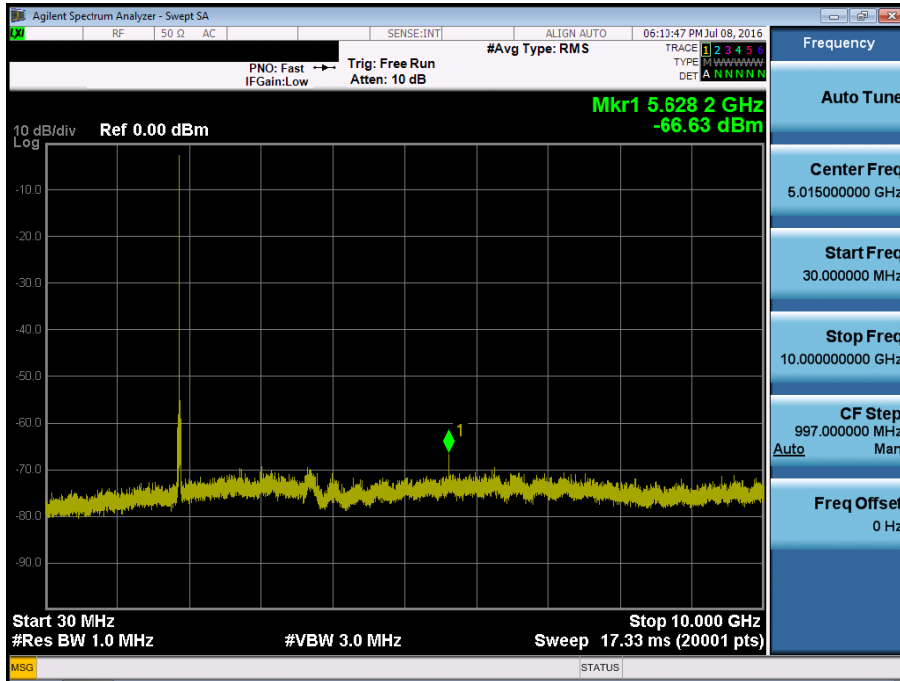

BAND 25. Conducted Spurious_2 (26365 ch 15MHz QPSK RB 1_0)

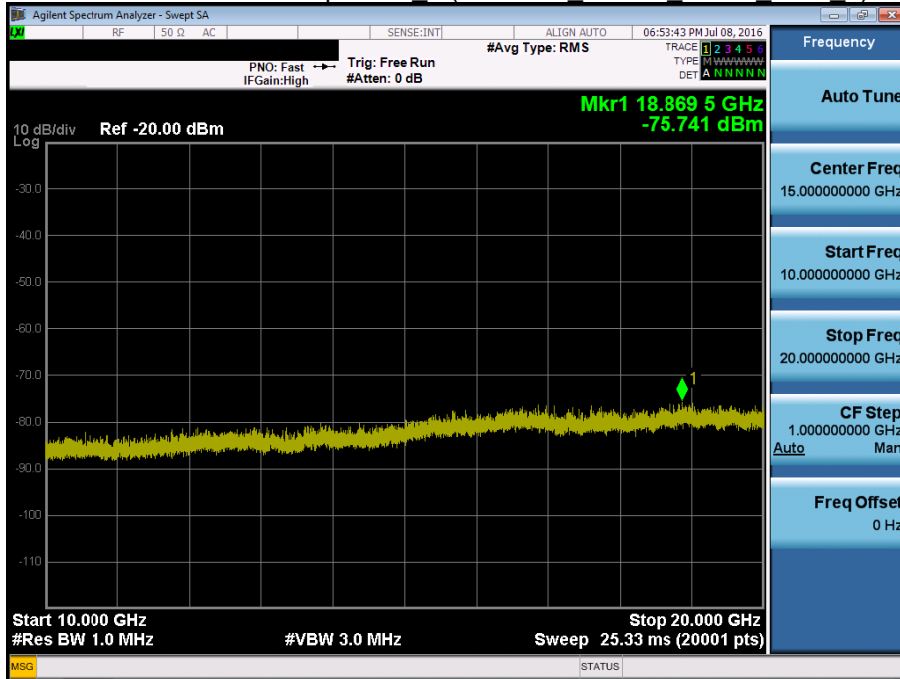

BAND 25. Conducted Spurious_1 (26615 ch_15MHz_QPSK_RB 1_0)

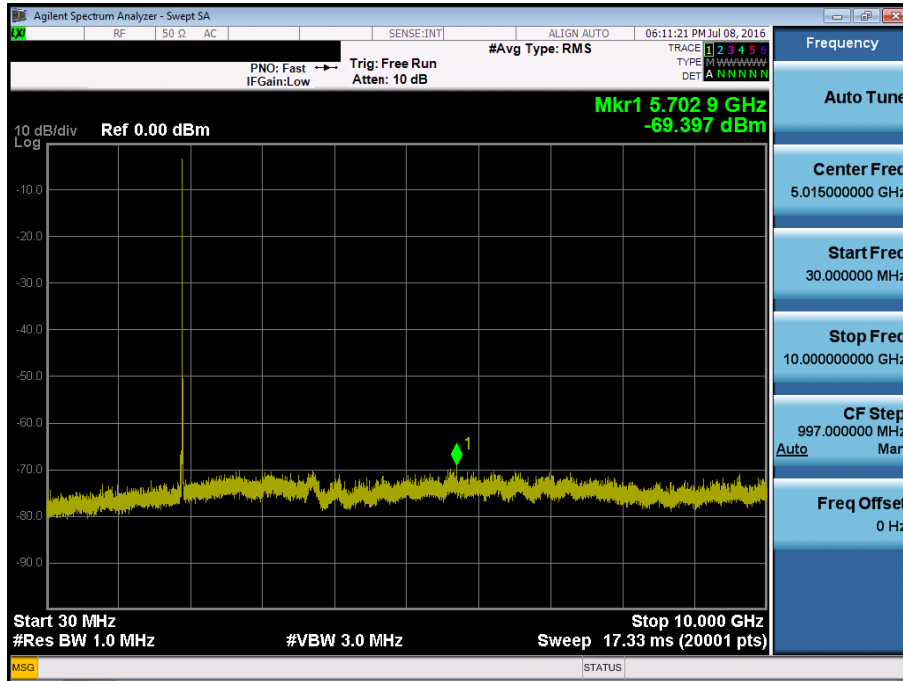

BAND 25. Conducted Spurious_2 (26615 ch_15MHz_QPSK_RB 1_0)

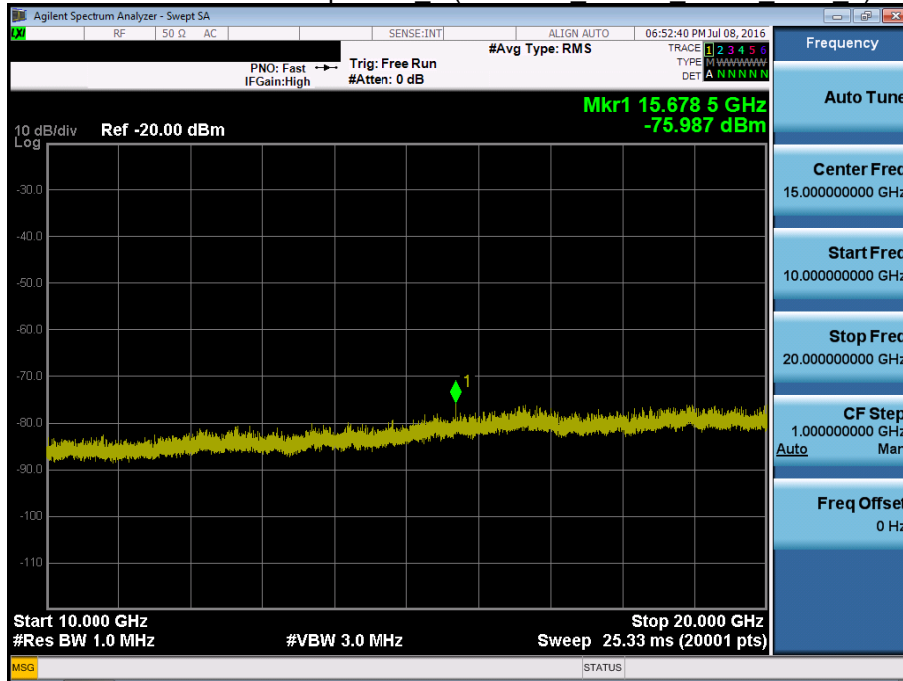

BAND 25. Conducted Spurious_1 (26140 ch_20MHz_QPSK_RB 1_0)

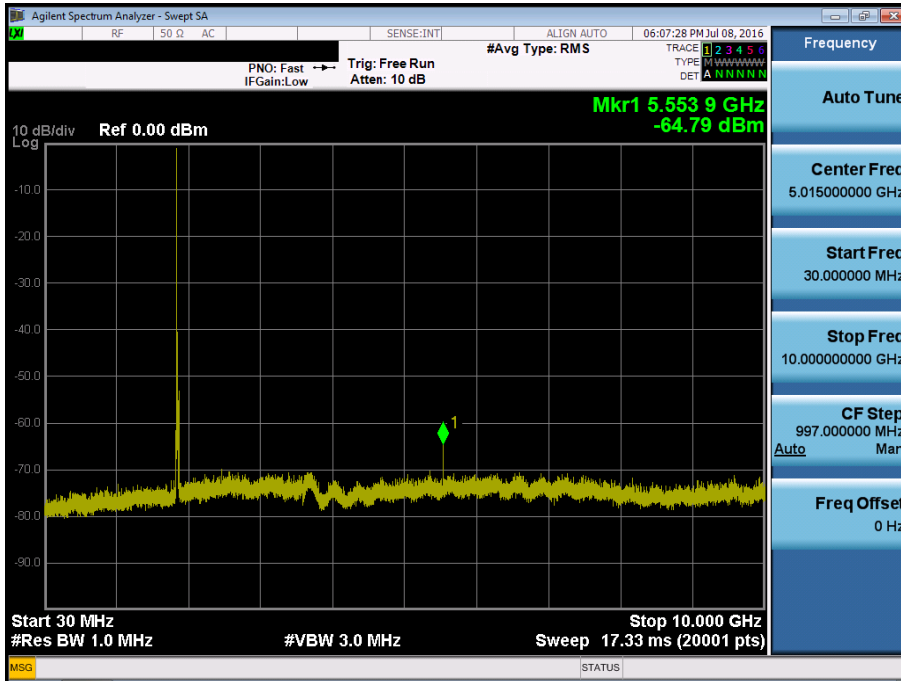

BAND 25. Conducted Spurious_2 (26140 ch_20MHz_QPSK_RB 1_0)

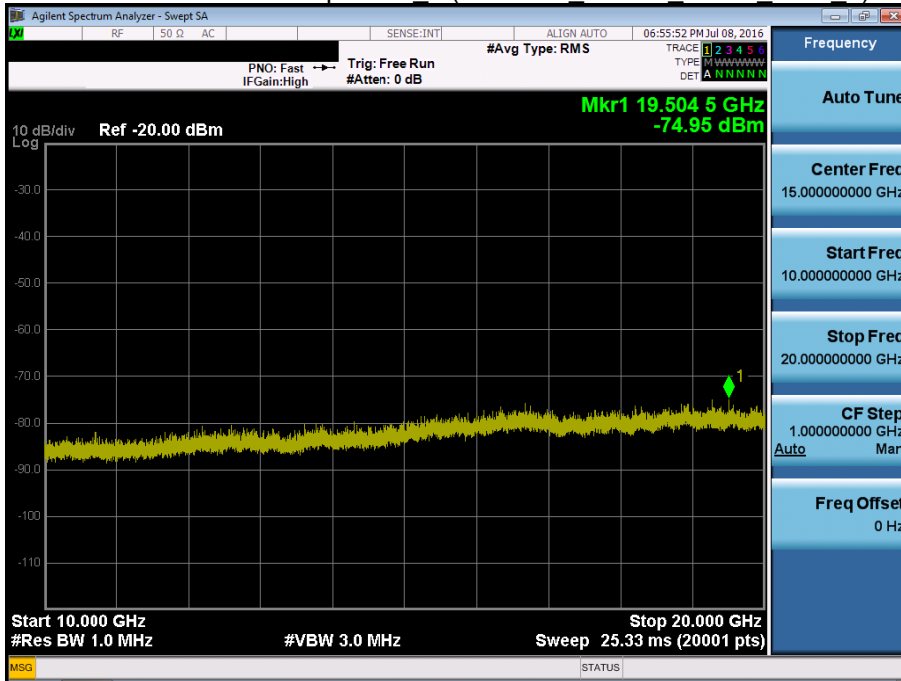

BAND 25. Conducted Spurious_1 (26365 ch_20MHz_QPSK_RB 1_0)

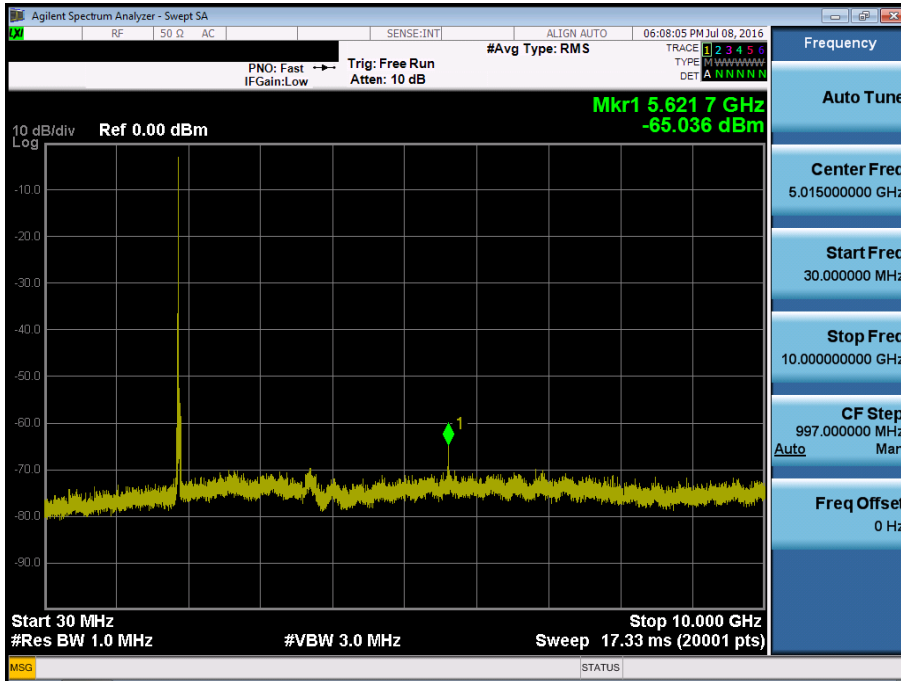

BAND 25. Conducted Spurious_2 (26365 ch_20MHz_QPSK_RB 1_0)

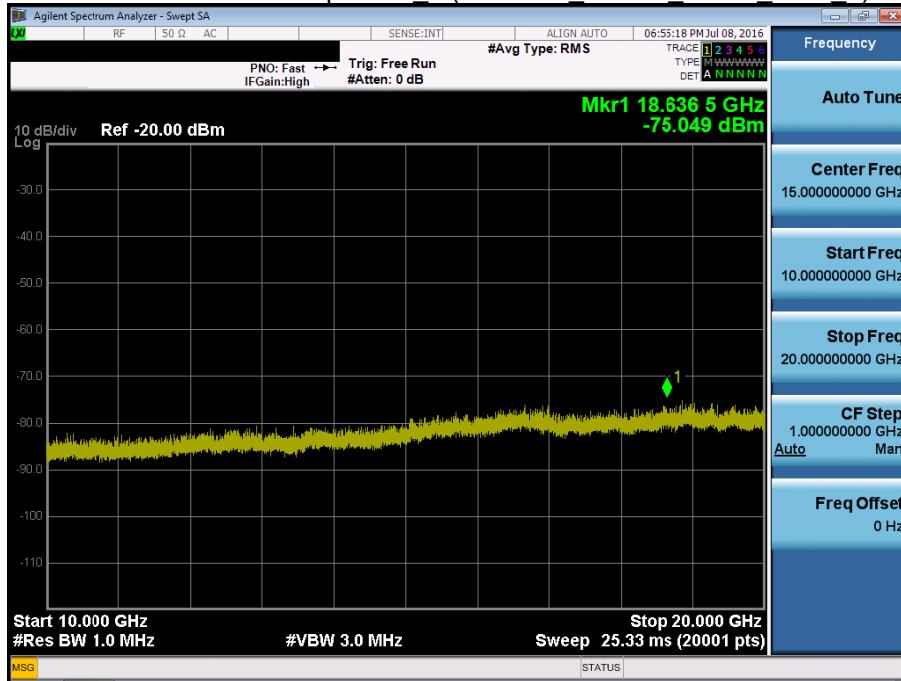

BAND 25. Conducted Spurious_1 (26590 ch_20MHz_QPSK_RB 1_0)

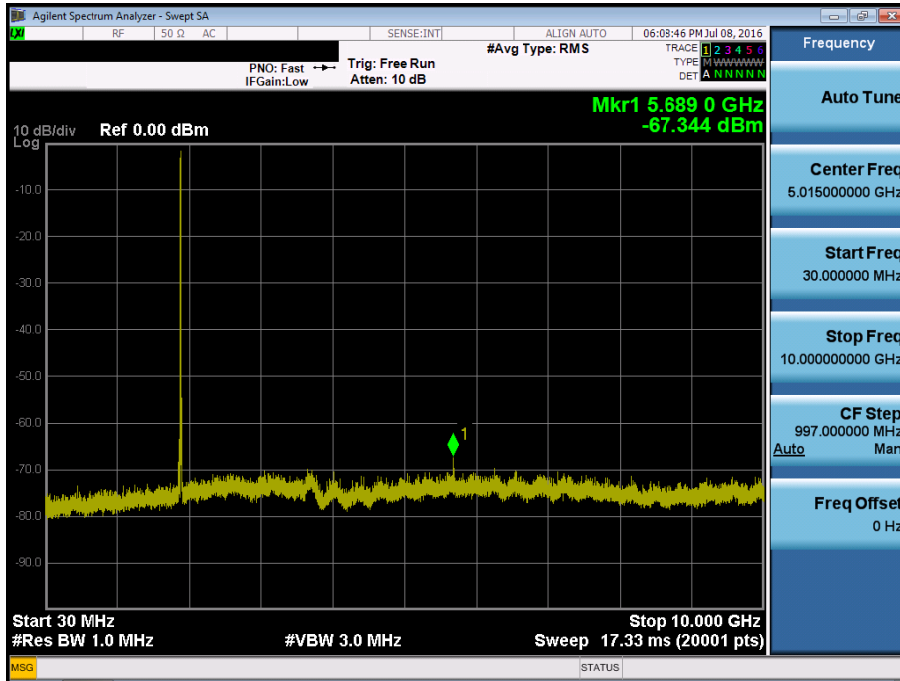

BAND 25. Conducted Spurious_2 (26590 ch_20MHz_QPSK_RB 1_0)

