



HCT CO., LTD.

CERTIFICATE OF COMPLIANCE FCC Certification

Applicant Name:
Franklin Technology Inc.
Address:
906 JEI Platz 459-11 Gasan-dong, Gumcheon-Gu, Seoul,
Korea

Date of Issue:
August 23, 2011
Location:
HCT CO., LTD., 105-1, Jangam-ri, Majang-Myeon, Icheon-si,
Kyunggi-Do, Korea
Test Report No.: HCTR1108FR17
HCT FRN: 0005866421

FCC ID : XHGU602
APPLICANT : Franklin Technology Inc.

Model(s): U602
EUT Type: USB Dongle
Tx Frequency: 2 498.5 MHz ~ 2 687.5 MHz (5 MHz Bandwidth)
2 501.0 MHz ~ 2 685.0 MHz (10 MHz Bandwidth)

Rx Frequency: 2 498.5 MHz ~ 2 687.5 MHz (5 MHz Bandwidth)
2 501.0 MHz ~ 2 685.0 MHz (10 MHz Bandwidth)

Max. RF Output Power: TX1: 0.873 W 5 MHz 16QAM(29.41 dBm)/ 0.944 W 5 MHz QPSK(29.75 dBm)/
0.598 W 10 MHz 16QAM(27.77 dBm)/ 0.724 W 10 MHz QPSK(28.60 dBm)
TX2: 1.265 W 5 MHz 16QAM(31.02 dBm)/ 1.178 W 5 MHz QPSK(30.71 dBm)/
0.853 W 10 MHz 16QAM(29.31 dBm)/ 0.847 W 10 MHz QPSK(29.28 dBm)

Emission Designator(s): 5 MHz BW : 4M44G7D (QPSK) / 4M46W7D(16QAM)
10 MHz BW : 9M09G7D (QPSK) / 9M10W7D(16QAM)

FCC Classification: Licensed Non-Broadcast Transmitter (TNB)

FCC Rule Part(s): §27, §2

The measurements shown in this report were made in accordance with the procedures specified in §2.947. I assume full responsibility for the accuracy and completeness of these measurements, and for the qualifications of all persons taking them.

HCT CO., LTD. Certifies that no party to this application has subject to a denial of Federal benefits that includes FCC benefits pursuant to section 5301 of the Anti-Drug Abuse Act of 1998, 21 U.S. C.853(a)

Report prepared by
: Hyo Sun Kwak
Test engineer of RF Team

Approved by
: Sang Jun Lee
Manager of RF Team

This report only responds to the tested sample and may not be reproduced, except in full, without written approval of the HCT Co., Ltd.

FCC CERTIFICATION REPORT			www.hct.co.kr
Test Report No. HCTR1108FR17	Date of Issue: August 23, 2011	EUT Type: USB Dongle	FCC ID: XHGU602

Version

TEST REPORT NO.	DATE	DESCRIPTION
HCTR1108FR17	August 23, 2011	First Approval Report

Table of Contents

1. GENERAL INFORMATION	4
2. INTRODUCTION	5
2.1. EUT DESCRIPTION.....	5
2.2. MEASURING INSTRUMENT CALIBRATION.....	5
2.3. TEST FACILITY	5
3. DESCRIPTION OF TESTS	6
3.1 EQUIVALENT ISOTROPIC RADIATED POWER	6
3.2 OCCUPIED BANDWIDTH.	7
3.3 SPURIOUS AND HARMONIC EMISSIONS AT ANTENNA TERMINAL.....	8
3.4 RADIATED SPURIOUS AND HARMONIC EMISSIONS	9
3.5 FREQUENCY STABILITY / VARIATION OF AMBIENT TEMPERATURE	10
4. LIST OF TEST EQUIPMENT	11
5. SUMMARY OF TEST RESULTS	12
6. SAMPLE CALCULATION.....	13
7. TEST DATA	14
7.1 CONDUCTED OUTPUT POWER	14
7.2 OCCUPIED BANDWIDTH	17
7.3 CONDUCTED SPURIOUS EMISSIONS	19
7.3.1 CHANNEL EDGE	20
7.4 EFFECTIVE RADIATED POWER OUTPUT (WiMAX).....	21
7.5 EFFECTIVE RADIATED POWER OUTPUT (WiMAX).....	23
7.6 RADIATED SPURIOUS EMISSIONS.....	25
7.6.1 RADIATED SPURIOUS EMISSIONS (TX1: WiMAX 5 MHz)	25
7.6.2 RADIATED SPURIOUS EMISSIONS (TX2: WiMAX 5 MHz)	26
7.6.3 RADIATED SPURIOUS EMISSIONS (TX1: WiMAX 10 MHz)	27
7.6.4 RADIATED SPURIOUS EMISSIONS (TX2: WiMAX 10 MHz)	28
7.7 FREQUENCY STABILITY / VARIATION OF AMBIENT TEMPERATURE	29
7.7.1 FREQUENCY STABILITY (WiMAX-5 MHz)	29
7.7.2 FREQUENCY STABILITY (WiMAX-10 MHz)	30
8. TEST PLOTS.....	31



MEASUREMENT REPORT

1. GENERAL INFORMATION

Applicant Name: Franklin Technology Inc.

Address: 1505 Digital Tower Aston, 505-15 Gasan-dong, Gumcheon-gu, Seoul, Korea

FCC ID: XHGU602

Application Type: Certification

FCC Classification: Licensed Non-Broadcast Transmitter (TNB)

FCC Rule Part(s): §27, §2

EUT Type: USB Dongle

Model(s): U602

Tx Frequency: 2 498.5 MHz ~ 2 687.5 MHz (5 MHz Bandwidth)
2 501.0 MHz ~ 2 685.0 MHz (10 MHz Bandwidth)

Rx Frequency: 2 498.5 MHz ~ 2 687.5 MHz (5 MHz Bandwidth)
2 501.0 MHz ~ 2 685.0 MHz (10 MHz Bandwidth)

Max. RF Output Power: TX1: 0.873 W 5 MHz 16QAM(29.41 dBm)/ 0.944 W 5 MHz QPSK(29.75 dBm)/
0.598 W 10 MHz 16QAM(27.77 dBm)/ 0.724 W 10 MHz QPSK(28.60 dBm)

TX2: 1.265 W 5 MHz 16QAM(31.02 dBm)/ 1.178 W 5 MHz QPSK(30.71 dBm)/
0.853 W 10 MHz 16QAM(29.31 dBm)/ 0.847 W 10 MHz QPSK(29.28 dBm)

Emission Designator(s): 5 MHz BW : 4M44G7D (QPSK) / 4M46W7D(16QAM)
10 MHz BW : 9M09G7D (QPSK) / 9M10W7D(16QAM)

Antenna Specification Manufacturer: KWANG HYUN AIRTECH CO.,LTD
Antenna type: PCB Antenna
Peak Gain: 1.82 dBi

Date(s) of Tests: August 01, 2011 ~ August 10, 2011

FCC CERTIFICATION REPORT			www.hct.co.kr
Test Report No. HCTR1108FR17	Date of Issue: August 23, 2011	EUT Type: USB Dongle	FCC ID: XHGU602



2. INTRODUCTION

2.1. EUT DESCRIPTION

The U602 USB Dongle consists of Cellular CDMA, PCS CDMA, 1xEVDO Rev.0, A and wimax.

2.2. MEASURING INSTRUMENT CALIBRATION

The measuring equipment, which was utilized in performing the tests documented herein, has been calibrated in accordance with the manufacturer's recommendations for utilizing calibration equipment, which is traceable to recognized national standards.

2.3. TEST FACILITY

The SAC(Semi-Anechoic Chamber) and conducted measurement facility used to collect the radiated data are located at the 105-1, Jangam-ri , Majang-Myeon, Icheon-si, 467-811, KOREA.

The site is constructed in conformance with the requirements of ANSI C63.4 and CISPR Publication 22. Detailed description of test facility was submitted to the Commission and accepted dated March 02, 2011 (Registration Number: 90661)

FCC CERTIFICATION REPORT			www.hct.co.kr
Test Report No. HCTR1108FR17	Date of Issue: August 23, 2011	EUT Type: USB Dongle	FCC ID: XHGU602

3. DESCRIPTION OF TESTS

3.1 EQUIVALENT ISOTROPIC RADIATED POWER

Test Set-up

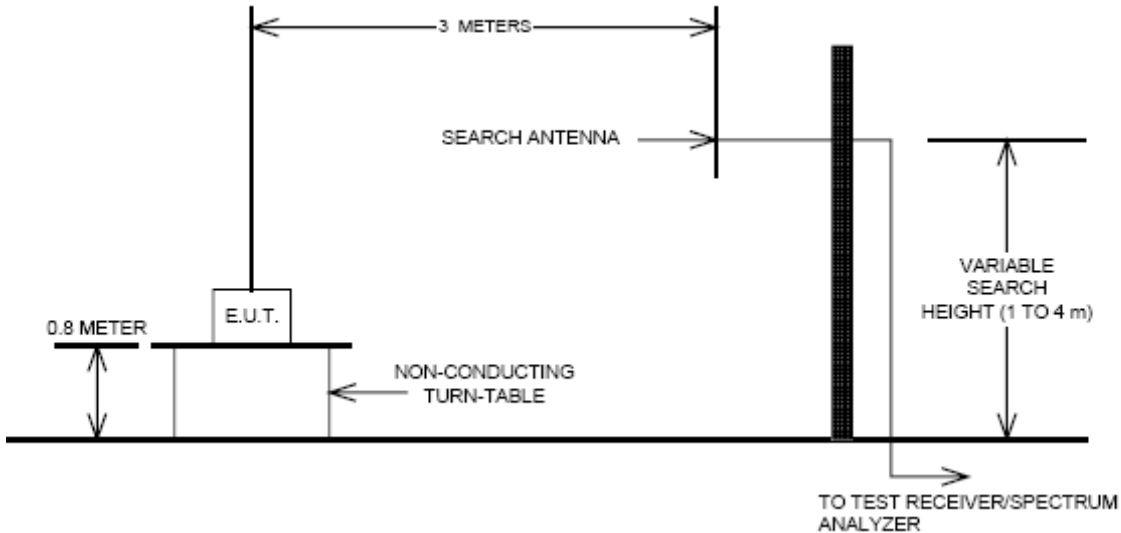

Test Procedure

Radiated emission measurements were performed at an SAC(Semi-Anechoic Chamber)

The equipment under test is placed on a non-conductive styrofoam resin table 3-meters from the receive antenna. A styrofoam turntable was rotated 360° and the receiving antenna scanned from 1-4m in order to capture the maximum emission. A half wave dipole was substituted in place of the EUT. This dipole antenna was driven by a signal generator and the previously recorded signal was duplicated.

The maximum EIRP was calculated by adding the forward power to the calibrated source plus its appropriate gain value. These steps were carried out with the receiving antenna in both vertical and horizontal polarization. For readings above 1GHz, the above procedure is repeated using horn antennas and the difference between the gain of the horn and an isotropic antenna are taken into consideration.

FCC CERTIFICATION REPORT			www.hct.co.kr
Test Report No. HCTR1108FR17	Date of Issue: August 23, 2011	EUT Type: USB Dongle	FCC ID: XHGU602

3.2 OCCUPIED BANDWIDTH.

Test set-up

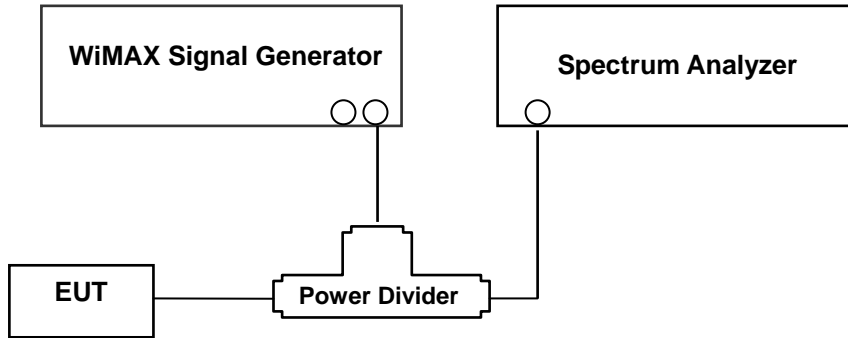

(Configuration of conducted Emission measurement)

Test Procedure

The EUT was setup to maximum output power at its lowest channel. The occupied bandwidth was measured using a spectrum analyzer. The measurements are repeated for the highest and a middle channel. The EUT's occupied bandwidth is measured as the width of the signal between two points, one below the carrier center frequency and one above the carrier frequency, outside of which all emissions are attenuated at least 26 dB below the transmitter power. Plots of the EUT's occupied bandwidth are shown herein.

FCC CERTIFICATION REPORT			www.hct.co.kr
Test Report No. HCTR1108FR17	Date of Issue: August 23, 2011	EUT Type: USB Dongle	FCC ID: XHGU602



3.3 SPURIOUS AND HARMONIC EMISSIONS AT ANTENNA TERMINAL.

Test Procedure

The level of the carrier and the various conducted spurious and harmonic frequencies is measured by means of a calibrated spectrum analyzer.

The EUT was setup to maximum output power at its lowest channel. The Resolution BW of the analyzer is set to 1 % of the emission bandwidth to show compliance with the -13 dBm limit, in the 1 MHz bands immediately outside and adjacent to the edge of the frequency block. The 1 MHz RBW was used to scan from 30 MHz to 26.5 GHz.. A display line was placed at -25 dBm to show compliance. The high, lowest and a middle channel were tested for out of band measurements.

- Band Edge Requirement : When measuring conducted band edge, the ACP feature of the signal analyzer was used. For each segment of the band edge, the allowed integration bandwidth was configured to calculate the channel power that is highest within that band edge segment.

- Occupied Bandwidth Emission Limits

· On any frequency outside but within 5.5 MHz from the band edge of a licensee's frequency block, the power of any emission shall be attenuated below the transmitter power (P) by at least $43 + 10\log(P)$ dB. At frequencies greater than 5.5 MHz from any in-band channel edge, the transmitter power (P) shall be attenuated by at least $55 + 10\log(P)$ dB.

· Compliance with these provisions is based on the use of measurement instrumentation employing a resolution bandwidth of 1 MHz or greater. However, in the 1 MHz bands immediately outside and adjacent to the frequency block a resolution bandwidth of at least one percent of the emission bandwidth of the fundamental emission of the transmitter may be employed. The emission bandwidth is defined as the width of the signal between two points, one below the carrier center frequency and one above the carrier center frequency, outside of which all emission are attenuated at least 26 dB below the transmitter power.

· When measuring the emission limits, the nominal carrier frequency shall be adjusted as close to the licensee's frequency block edges, both upper and lower, as the design permits.

· The measurement of emission power can be expressed in peak or average values, provided they are expressed in the same parameters as the transmitter power.

FCC CERTIFICATION REPORT			www.hct.co.kr
Test Report No. HCTR1108FR17	Date of Issue: August 23, 2011	EUT Type: USB Dongle	FCC ID: XHGU602

3.4 RADIATED SPURIOUS AND HARMONIC EMISSIONS

Test Set-up

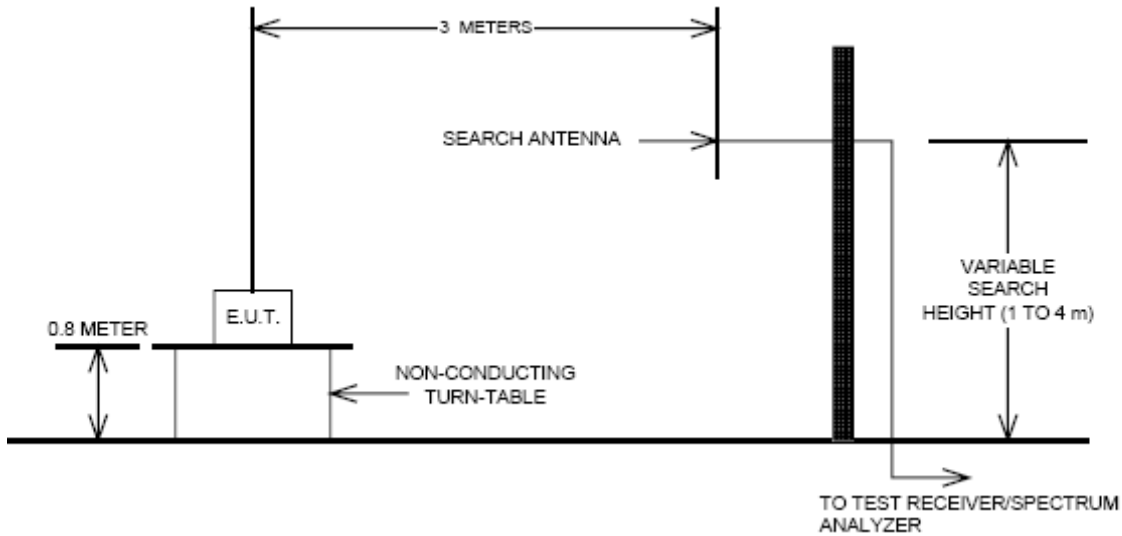

The measurement facilities used for this test have been documented in previous filings with the commission pursuant to section § 2.948. The SAC(Semi-Anechoic Chamber) meets requirements in ANSI C63.4 –2003. A mast capable of lifting the receiving antenna from a height of one to four meters is used together with a rotatable styrofoam platform mounted at three from the antenna mast.

- 1) The unit mounted on a styrofoam turntable 1.5 m × 1.0 m × 0.80 m is 0.8 meter above test site ground level.
- 2) During the emission test, the turntable is rotated and the EUT is manipulated to find the configuration resulting in maximum emission under normal condition of installation and operation.
- 3) The antenna height and polarization are also varied from 1 to 4 meters until the maximum signal is found.
- 4) The spectrum shall be scanned up to the 10th harmonic of the fundamental frequency.

Test Procedure

The equipment under test is placed on a non-conductive styrofoam resin table 3-meters from the receive antenna. A styrofoam turntable was rotated 360° and the receiving antenna scanned from 1-4m in order to capture the maximum emission. A half wave dipole was substituted in place of the EUT. This dipole antenna was driven by a signal generator and the previously recorded signal was duplicated.

The maximum EIRP was calculated by adding the forward power to the calibrated source plus its appropriate gain value. These steps were carried out with the receiving antenna in both vertical and horizontal polarization. For readings above 1GHz, the above procedure is repeated using horn antennas and the difference between the gain of the horn and an isotropic antenna are taken into consideration.

FCC CERTIFICATION REPORT			www.hct.co.kr
Test Report No. HCTR1108FR17	Date of Issue: August 23, 2011	EUT Type: USB Dongle	FCC ID: XHGU602

3.5 FREQUENCY STABILITY / VARIATION OF AMBIENT TEMPERATURE

Test Set-up

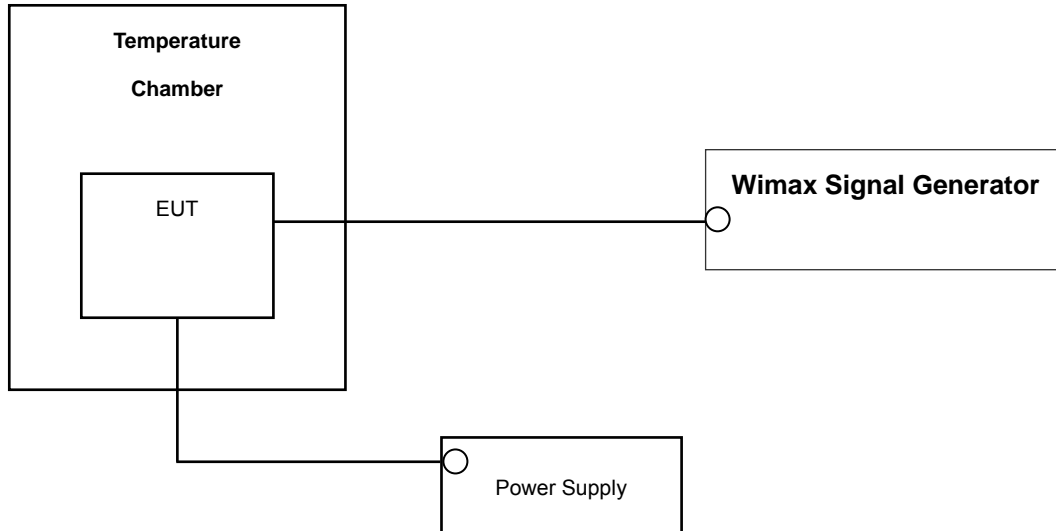

* Nominal Operating Voltage

Test Procedure

The frequency stability of the transmitter is measured by:

- a.) **Temperature:** The temperature is varied from - 30 °C to + 50 °C using an environmental chamber.
- b.) **Primary Supply Voltage:** The primary supply voltage is varied from battery end point to 115 % of the voltage normally at the input to the device or at the power supply terminals if cables are not normally supplied.

Specification — the frequency stability shall be sufficient to ensure that the fundamental emission stays within the authorized frequency block. The frequency stability of the transmitter shall be maintained within $\pm 0.00025\%$ (± 2.5 ppm) of the center frequency.

Time Period and Procedure:

The carrier frequency of the transmitter is measured at room temperature (20°C to provide a reference).

1. The equipment is turned on in a “standby” condition for one minute before applying power to the transmitter. Measurement of the carrier frequency of the transmitter is made within one minute after applying power to the transmitter.
2. Frequency measurements are made at 10°C intervals ranging from -30°C to +50°C. A period of at least one half-hour is provided to allow stabilization of the equipment at each temperature level.

NOTE: The EUT is tested down to the battery endpoint.

FCC CERTIFICATION REPORT			www.hct.co.kr
Test Report No. HCTR1108FR17	Date of Issue: August 23, 2011	EUT Type: USB Dongle	FCC ID: XHGU602

4. LIST OF TEST EQUIPMENT

Manufacture	Model/ Equipment	Serial Number	Calibration Interval	Calibration Due
R&S	N9020A	MY51110020	Annual	04/16/2012
Agilent	E4416A/ Power Meter	GB41291412	Annual	01/04/2012
Agilent	E9327A/ Power Sensor	MY4442009	Annual	05/02/2012
Agilent	E4438C	MY42082646	Annual	11/11/2011
MITEQ	AMF-6D-001180-35-20P/AMP	990893	Annual	05/02/2012
Wainwright	WHK1.2/15G-10EF/H.P.F	2	Annual	05/02/2012
Wainwright	WHK3.3/18G-10EF/H.P.F	1	Annual	05/02/2012
Agilent	775D/ Dual Directional Coupler	12922	Annual	12/29/2011
Agilent	11636B/ Power Divider	11377	Annual	12/29/2011
Digital	EP-3010/ Power Supply	3110117	Annual	01/04/2012
Schwarzbeck	UHAP/ Dipole Antenna	949	Biennial	03/18/2012
Schwarzbeck	UHAP/ Dipole Antenna	950	Biennial	03/18/2012
Korea Engineering	KR-1005L / Chamber	KRAB07063-2CH	Annual	12/28/2011
Schwarzbeck	BBHA 9120D/ Horn Antenna	296	Biennial	09/23/2011
Schwarzbeck	BBHA 9120D/ Horn Antenna	147	Biennial	04/13/2012
Agilent	E4440A/Spectrum Analyzer	US45303008	Annual	05/02/2012

5. SUMMARY OF TEST RESULTS

FCC Part Section(s)	Test Description	Test Limit	Test Condition	Test Result
2.1049, 27.53(l)(6)	Occupied Bandwidth	N/A	CONDUCTED	PASS
2.1051, 27.53(l)(4)(6)	Band Edge	< 43 + 10log ₁₀ (P[Watts]) within 5.5MHz from the band edge		PASS
2.1046	Conducted Output Power	N/A		PASS
2.1051, 27.53(l)(4)(6)	Conducted Spurious Emissions	< 55 + 10log ₁₀ (P[Watts]) for all emissions greater than 5.5MHz from the band edge		PASS
2.1055, 27.54	Frequency stability	Fundamental emissions must stay within the allotted band		PASS
27.50(h)(2)	Equivalent Isotropic Radiated Power	< 2 Watts max. EIRP	RADIATED	PASS
2.1053, 27.53(l)(4)	Undesirable Emissions	< 55 + 10log ₁₀ (P[Watts]) for all out-of-band emissions		PASS

6. SAMPLE CALCULATION

A. ERP Sample Calculation

Mode	Ch./ Freq.	Measured Level(dBm)	Substitute LEVEL(dBm)	Ant. Gain	C.L	Pol.	ERP	
	Freq.(MHz)						W	dBm
WiMAX	2596.00	-18.19	15.16	10.28	2.33	H	0.205	23.11

ERP = SubstituteLEVEL(dBm) + Ant. Gain – CL(Cable Loss)

- 1) The EUT mounted on a wooden tripod is 0.8 meter above test site ground level.
- 2) During the test , the turn table is rotated and the antenna height is also varied from 1 to 4 meters until the maximum signal is found.
- 3) Record the field strength meter's level.
- 4) Replace the EUT with dipole/Horn antenna that is connected to a calibrated signal generator.
- 5) Increase the signal generator output till the field strength meter's level is equal to the item (3).
- 6) The signal generator output level with Ant. Gain and cable loss are the rating of effective radiated power (ERP).

B. Emission Designator

Wimax Emission Designator

Emission Designator = 1M27F9W

QPSK Modulation

Emission Designator = 9M11G7D

Wimax BW = 9.11 MHz (Measured at the 99% power bandwidth)

G= Phase Modulation

7 = Quantized/Digital Info

D= Amplitude/Angle Modulated

16QAM / 64QAM Modulation

Emission Designator = 9M12W7D

Wimax BW = 9.12 MHz (Measured at the 99% power bandwidth)

W= Combination (Audio/Data)

7 = Quantized/Digital Info

D= Amplitude/Angle Modulated

FCC CERTIFICATION REPORT			www.hct.co.kr
Test Report No. HCTR1108FR17	Date of Issue: August 23, 2011	EUT Type: USB Dongle	FCC ID: XHGU602

7. TEST DATA

7.1 CONDUCTED OUTPUT POWER

A base station simulator was used to establish communication with the EUT. The base station simulator parameters were set to produce the maximum power from the EUT. This device was tested under all configurations and the highest power is reported. Conducted Output Powers of EUT are reported below.

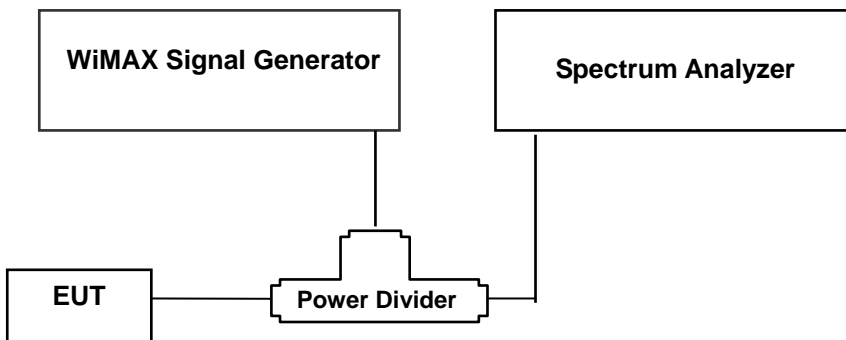

Test Result

TX1-5 MHz

5 MHz channel BW		
Frequency(MHz)	Modulation	Average Power (dBm)
2498.5	QPSK 1/2	23.16
	QPSK 3/4	22.94
	16QAM 1/2	23.03
	16QAM 3/4	23.09
2593.0	QPSK 1/2	22.87
	QPSK 3/4	23.03
	16QAM 1/2	22.92
	16QAM 3/4	23.08
2687.5	QPSK 1/2	23.06
	QPSK 3/4	22.81
	16QAM 1/2	23.10
	16QAM 3/4	22.86

(WiMAX Conducted Average Output Powers)

TX1-10 MHz

10 MHz channel BW		
Frequency(MHz)	Modulation	Average Power (dBm)
2501.0	QPSK 1/2	22.91
	QPSK 3/4	23.03
	16QAM 1/2	23.06
	16QAM 3/4	23.04
2593.0	QPSK 1/2	23.09
	QPSK 3/4	23.10
	16QAM 1/2	23.07
	16QAM 3/4	23.18
2685.0	QPSK 1/2	23.21
	QPSK 3/4	23.15
	16QAM 1/2	23.12
	16QAM 3/4	23.17

(WiMAX Conducted Average Output Powers)

TX2-5 MHz

5 MHz channel BW		
Frequency(MHz)	Modulation	Average Power (dBm)
2498.5	QPSK 1/2	23.14
	QPSK 3/4	23.08
	16QAM 1/2	22.98
	16QAM 3/4	23.08
2593.0	QPSK 1/2	22.97
	QPSK 3/4	22.98
	16QAM 1/2	23.01
	16QAM 3/4	23.06
2687.5	QPSK 1/2	22.88
	QPSK 3/4	22.92
	16QAM 1/2	23.09
	16QAM 3/4	23.07

(WiMAX Conducted Average Output Powers)

TX2-10 MHz

10 MHz channel BW		
Frequency(MHz)	Modulation	Average Power (dBm)
2501.0	QPSK 1/2	23.09
	QPSK 3/4	23.00
	16QAM 1/2	23.08
	16QAM 3/4	23.03
2593.0	QPSK 1/2	23.08
	QPSK 3/4	23.11
	16QAM 1/2	23.07
	16QAM 3/4	23.16
2685.0	QPSK 1/2	23.25
	QPSK 3/4	23.23
	16QAM 1/2	23.21
	16QAM 3/4	23.23

(WiMAX Conducted Average Output Powers)

Note : Detecting mode is average.

TX1

- 5 MHz: Plots of the EUT's Conducted Output Power are shown Page 44 ~ 49.

- 10 MHz: Plots of the EUT's Conducted Output Power are shown Page 50 ~ 55.

TX2

- 5 MHz: Plots of the EUT's Conducted Output Power are shown Page 56 ~ 61.

- 10 MHz: Plots of the EUT's Conducted Output Power are shown Page 62 ~ 67.

7.2 OCCUPIED BANDWIDTH

5 MHz

Frequency [MHz]	Modulation	Occupied Bandwidth [MHz]
2498.5	QPSK 1/2	4.3922
	QPSK 3/4	4.4374
	16QAM 1/2	4.4543
	16QAM 3/4	4.3808
2593.0	QPSK 1/2	4.3890
	QPSK 3/4	4.4390
	16QAM 1/2	4.4561
	16QAM 3/4	4.3810
2687.5	QPSK 1/2	4.4007
	QPSK 3/4	4.4418
	16QAM 1/2	4.4560
	16QAM 3/4	4.3817

10 MHz

Frequency [MHz]	Modulation	Occupied Bandwidth [MHz]
2501.0	QPSK 1/2	9.0913
	QPSK 3/4	9.0860
	16QAM 1/2	9.0464
	16QAM 3/4	9.0948
2593.0	QPSK 1/2	9.0874
	QPSK 3/4	9.0874
	16QAM 1/2	9.0512
	16QAM 3/4	9.0978
2685.0	QPSK 1/2	9.0936
	QPSK 3/4	9.0877
	16QAM 1/2	9.0521
	16QAM 3/4	9.1018

- 5 MHz: Plots of the EUT's Occupied Bandwidth are shown Page 32 ~ 37.

- 10 MHz: Plots of the EUT's Occupied Bandwidth are shown Page 38 ~ 43.

7.3 CONDUCTED SPURIOUS EMISSIONS

5 MHz

Frequency(MHz)	Modulation	Frequency of Maximum Harmonic (GHz)	Maximum Data (dBm)
2498.5	QPSK 1/2	24.4600	-35.4620
	QPSK 3/4	24.9960	-35.0930
	16QAM 1/2	25.5060	-34.5950
	16QAM 3/4	24.9700	-34.5610
2593.0	QPSK 1/2	25.0210	-34.3800
	QPSK 3/4	25.0980	-32.3030
	16QAM 1/2	24.9700	-32.6630
	16QAM 3/4	25.0720	-32.5970
2687.5	QPSK 1/2	25.0210	-33.4510
	QPSK 3/4	24.9700	-33.2230
	16QAM 1/2	24.9450	-33.1580
	16QAM 3/4	25.0470	-32.6200

10 MHz

Frequency(MHz)	Modulation	Frequency of Maximum Harmonic (GHz)	Maximum Data (dBm)
2501.0	QPSK 1/2	25.0980	-32.1570
	QPSK 3/4	25.0720	-32.0730
	16QAM 1/2	25.0470	-31.1130
	16QAM 3/4	25.0210	-29.9770
2593.0	QPSK 1/2	25.0720	-31.3110
	QPSK 3/4	25.0720	-31.5820
	16QAM 1/2	24.4600	-32.2300
	16QAM 3/4	25.6330	-31.0110
2685.0	QPSK 1/2	25.0470	-31.4670
	QPSK 3/4	25.0470	-31.6140
	16QAM 1/2	24.9960	-30.6050
	16QAM 3/4	25.0210	-31.2660

- 5 MHz: Plots of the EUT's Conducted Spurious Emissions are shown Page 76 ~ 87.

- 10 MHz: Plots of the EUT's Conducted Spurious Emissions are shown Page 88 ~ 99.

7.3.1 CHANNEL EDGE

- 5 MHz: Plots of the EUT's Band Edge are shown Page 68 ~ 71.

- 10 MHz: Plots of the EUT's Band Edge are shown Page 72 ~ 75.

7.4 EFFECTIVE RADIATED POWER OUTPUT (WiMAX)

TX1: 5 MHz

Mode	Freq. (MHz)	Measured Level(dBm)	Substitute LEVEL (dBm)	Ant. Gain (dBd)	C.L	Pol.	ERP	
							W	dBm
QPSK	2498.5	-14.56	22.47	10.81	3.53	V	0.944	29.75
	2593.0	-15.22	22.21	10.86	3.57	V	0.891	29.50
	2687.5	-17.37	20.11	10.91	3.73	V	0.536	27.29
16QAM	2498.5	-14.90	22.13	10.81	3.53	V	0.873	29.41
	2593.0	-15.48	21.95	10.86	3.57	V	0.839	29.24
	2687.5	-17.46	20.02	10.91	3.73	V	0.525	27.20

Note: Worst case are QPSK 1/2 (2593 MHz = 3/4) and 16QAM 3/4 (2687.5 MHz=1/2) This unit was tested with a notebook computer.

TX2: 5 MHz

Mode	Freq. (MHz)	Measured Level(dBm)	Substitute LEVEL (dBm)	Ant. Gain (dBd)	C.L	Pol.	ERP	
							W	dBm
QPSK	2498.5	-14.23	22.80	10.81	3.53	V	1.019	30.08
	2593.0	-14.39	23.04	10.86	3.57	V	1.079	30.33
	2687.5	-13.95	23.53	10.91	3.73	V	1.178	30.71
16QAM	2498.5	-14.37	22.66	10.81	3.53	V	0.986	29.94
	2593.0	-13.70	23.73	10.86	3.57	V	1.265	31.02
	2687.5	-13.91	23.57	10.91	3.73	V	1.189	30.75

Note: Worst case are QPSK 3/4 (2687.5 MHz = 1/2) and 16QAM 3/4 (2498.5 MHz=1/2) This unit was tested with a notebook computer.

NOTES:

Equivalent Isotropic Radiated Power Measurements by Substitution Method

according to ANSI/TIA/EIA-603-C-2004, Aug. 17, 2004:

The EUT was placed on a wooden turn table 3-meters from the receive antenna. The receive antenna height and turntable rotation was adjusted for the highest reading on the receive spectrum analyzer. For 5 MHz BW signals, a peak detector is used, with RBW = VBW = 5 MHz. For 10 MHz BW signals, a peak detector is used, with RBW = VBW = 10MHz. A Horn antenna was substituted in place of the EUT. This Horn antenna was driven by a signal generator and the level of the signal generator was adjusted to obtain the same receive spectrum analyzer reading. The conducted power at the terminals of the Horn antenna is measured. The difference between the gain of the horn and an isotropic antenna is taken into consideration and the EIRP is recorded.

FCC CERTIFICATION REPORT			www.hct.co.kr
Test Report No. HCTR1108FR17	Date of Issue: August 23, 2011	EUT Type: USB Dongle	FCC ID: XHGU602



Also, we have done x, y, z planes in EUT and horizontal and vertical polarization in detecting antenna. The worst case of the EUT is in y plane in 5 MHz BW mode. Also worst case of detecting Antenna is in vertical polarization in 5 MHz BW mode.

FCC CERTIFICATION REPORT			www.hct.co.kr
Test Report No. HCTR1108FR17	Date of Issue: August 23, 2011	EUT Type: USB Dongle	FCC ID: XHGU602

7.5 EFFECTIVE RADIATED POWER OUTPUT (WiMAX)

TX1: 10 MHz

Mode	Freq. (MHz)	Measured Level(dBm)	Substitute LEVEL (dBm)	Ant. Gain (dBd)	C.L	Pol.	ERP	
							W	dBm
QPSK	2501.0	-15.71	21.32	10.81	3.53	V	0.724	28.60
	2593.0	-17.06	20.37	10.86	3.57	V	0.583	27.66
	2685.0	-18.98	18.50	10.91	3.73	V	0.370	25.68
16QAM	2501.0	-16.54	20.49	10.81	3.53	V	0.598	27.77
	2593.0	-17.43	20.00	10.86	3.57	V	0.536	27.29
	2685.0	-19.17	18.31	10.91	3.73	V	0.354	25.49

Note: Worst case are QPSK 3/4 (2685MHz = 1/2) and 16QAM 3/4 (2501MHz = 1/2). This unit was tested with a notebook computer.

TX2: 10 MHz

Mode	Freq. (MHz)	Measured Level(dBm)	Substitute LEVEL (dBm)	Ant. Gain (dBd)	C.L	Pol.	ERP	
							W	dBm
QPSK	2501.0	-16.02	21.01	10.81	3.53	V	0.675	28.29
	2593.0	-15.44	21.99	10.86	3.57	V	0.847	29.28
	2685.0	-15.72	21.76	10.91	3.73	V	0.783	28.94
16QAM	2501.0	-15.50	21.53	10.81	3.53	V	0.760	28.81
	2593.0	-15.41	22.02	10.86	3.57	V	0.853	29.31
	2685.0	-15.96	21.52	10.91	3.73	V	0.741	28.70

Note: Worst case are QPSK 1/2 (2593MHz 3/4) and 16QAM 3/4 (2501 MHz=1/2) This unit was tested with a notebook computer.

NOTES:

Equivalent Isotropic Radiated Power Measurements by Substitution Method

according to ANSI/TIA/EIA-603-C-2004, Aug. 17, 2004:

The EUT was placed on a wooden turn table 3-meters from the receive antenna. The receive antenna height and turntable rotation was adjusted for the highest reading on the receive spectrum analyzer. For 5 MHz BW signals, a peak detector is used, with RBW = VBW = 5 MHz. For 10 MHz BW signals, a peak detector is used, with RBW = VBW = 10MHz. A Horn antenna was substituted in place of the EUT. This Horn antenna was driven by a signal generator and the level of the signal generator was adjusted to obtain the same receive spectrum analyzer reading. The conducted power at the terminals of the Horn antenna is measured. The difference between the gain of the horn and an isotropic antenna is taken into consideration and the EIRP is recorded.

FCC CERTIFICATION REPORT			www.hct.co.kr
Test Report No. HCTR1108FR17	Date of Issue: August 23, 2011	EUT Type: USB Dongle	FCC ID: XHGU602



Also, we have done x, y, z planes in EUT and horizontal and vertical polarization in detecting antenna. The worst case of the EUT is in y plane in 10 MHz BW mode. Also worst case of detecting Antenna is in vertical polarization in 10 MHz BW mode.

FCC CERTIFICATION REPORT			www.hct.co.kr
Test Report No. HCTR1108FR17	Date of Issue: August 23, 2011	EUT Type: USB Dongle	FCC ID: XHGU602



7.6 RADIATED SPURIOUS EMISSIONS

7.6.1 RADIATED SPURIOUS EMISSIONS (TX1: WiMAX 5 MHz)

- MEASURED OUTPUT POWER: 29.75 dBm = 0.944 W
- MODULATION SIGNAL: WiMAX 5 MHz (QPSK)
- DISTANCE: 3 meters
- LIMIT: - (55 + 10 log₁₀(W)) = - 54.75 dBc

Operating Freq. (MHz)	Freq.(MHz)	Measured Level [dBm]	Ant. Gain (dBd)	Substitute Level [dBm]	C.L	Pol.	ERP (dBm)	dBc
2498.50	4,997.00	-47.97	12.45	-50.21	5.81	H	-43.57	-73.32
	7,495.50	-49.10	10.84	-41.24	6.90	H	-37.30	-67.05
	9,994.00	-	-	-	-	-	-	-
2593.00	5,186.00	-52.69	12.50	-53.68	6.41	H	-47.59	-77.34
	7,779.00	-49.29	10.89	-39.80	7.68	V	-36.59	-66.34
	10,372.00	-	-	-	-	-	-	-
2687.50	5,375.00	-50.36	12.55	-52.18	6.53	H	-46.16	-75.91
	8,062.50	-40.92	11.00	-31.45	7.77	V	-28.22	-57.97
	10,750.00	-	-	-	-	-	-	-

NOTES: 1. Radiated Spurious Emission Measurements at 3 meters by Substitution Method

according to ANSI/TIA/EIA-603-C-2004, Aug. 17, 2004:

2. The magnitude of spurious emissions attenuated more than 20dB below the limit above 5th Harmonic for all channel.

3. we have done x, y, z planes in EUT and horizontal and vertical polarization in detecting antenna.

4. Worst case is QPSK 1/2

-

FCC CERTIFICATION REPORT			www.hct.co.kr
Test Report No. HCTR1108FR17	Date of Issue: August 23, 2011	EUT Type: USB Dongle	FCC ID: XHGU602

7.6.2 RADIATED SPURIOUS EMISSIONS (TX2: WiMAX 5 MHz)

- MEASURED OUTPUT POWER: 31.02 dBm = 1.265 W
- MODULATION SIGNAL: WiMAX 5 MHz (16QAM)
- DISTANCE: 3 meters
- LIMIT: - (55 + 10 log₁₀(W)) = - 56.02 dBc

Operating Freq. (MHz)	Freq.(MHz)	Measured Level [dBm]	Ant. Gain (dBd)	Substitute Level [dBm]	C.L	Pol.	ERP (dBm)	dBc
2498.50	4,997.00	-51.42	12.45	-53.66	5.81	H	-47.02	-78.04
	7,495.50	-43.87	10.84	-36.01	6.90	H	-32.07	-63.09
	9,994.00	-	-	-	-	-	-	-
2593.00	5,186.00	-51.09	12.50	-52.08	6.41	H	-45.99	-77.01
	7,779.00	-47.10	10.89	-37.61	7.68	V	-34.40	-65.42
	10,372.00	-	-	-	-	-	-	-
2687.50	5,375.00	-49.15	12.55	-50.97	6.53	H	-44.95	-75.97
	8,062.50	-50.18	11.00	-40.71	7.77	V	-37.48	-68.50
	10,750.00	-	-	-	-	-	-	-

- NOTES:**
1. Radiated Spurious Emission Measurements at 3 meters by Substitution Method according to ANSI/TIA/EIA-603-C-2004, Aug. 17, 2004:
 2. The magnitude of spurious emissions attenuated more than 20dB below the limit above 5th Harmonic for all channel.
 3. we have done x, y, z planes in EUT and horizontal and vertical polarization in detecting antenna.
 4. Worst case is 16QAM 3/4.

7.6.3 RADIATED SPURIOUS EMISSIONS (TX1: WiMAX 10 MHz)

- MEASURED OUTPUT POWER: 28.60 dBm = 0.724 W
- MODULATION SIGNAL: WiMAX 10 MHz (QPSK)
- DISTANCE: 3 meters
- LIMIT: - (55 + 10 log₁₀(W)) = - 53.60 dBc

Operating Freq. (MHz)	Freq.(MHz)	Measured Level [dBm]	Ant. Gain (dBd)	Substitute Level [dBm]	C.L	Pol.	ERP (dBm)	dBc
2501.00	5,002.00	-52.80	12.45	-55.04	5.81	H	-48.40	-77.00
	7,503.00	-51.03	10.84	-43.17	6.90	H	-39.23	-67.83
	10,004.00	-	-	-	-	-	-	-
2593.00	5,186.00	-54.17	12.50	-55.16	6.41	H	-49.07	-77.67
	7,779.00	-53.70	10.89	-44.21	7.68	V	-41.00	-69.60
	10,372.00	-52.81	11.44	-42.04	8.01	-	-38.61	-67.21
2685.00	5,370.00	-52.62	12.55	-54.44	6.53	H	-48.42	-77.02
	8,055.00	-45.83	11.00	-36.36	7.77	V	-33.13	-61.73
	10,740.00	-	-	-	-	-	-	-

- NOTES:**
1. Radiated Spurious Emission Measurements at 3 meters by Substitution Method according to ANSI/TIA/EIA-603-C-2004, Aug. 17, 2004:
 2. The magnitude of spurious emissions attenuated more than 20dB below the limit above 5th Harmonic for all channel.
 3. we have done x, y, z planes in EUT and horizontal and vertical polarization in detecting antenna.
 4. Worst case is QPSK 3/4.

7.6.4 RADIATED SPURIOUS EMISSIONS (TX2: WiMAX 10 MHz)

- MEASURED OUTPUT POWER: 29.31 dBm = 0.853 W
- MODULATION SIGNAL: WiMAX 10 MHz (16QAM)
- DISTANCE: 3 meters
- LIMIT: - (55 + 10 log₁₀(W)) = - 54.31 dBc

Operating Freq. (MHz)	Freq.(MHz)	Measured Level [dBm]	Ant. Gain (dBd)	Substitute Level [dBm]	C.L	Pol.	ERP (dBm)	dBc
2501.00	5,002.00	-55.37	12.45	-57.61	5.81	H	-50.97	-80.28
	7,503.00	-49.48	10.84	-41.62	6.90	H	-37.68	-66.99
	10,004.00	-	-	-	-	-	-	-
2593.00	5,186.00	-52.11	12.50	-53.10	6.41	V	-47.01	-76.32
	7,779.00	-49.79	10.89	-40.30	7.68	V	-37.09	-66.40
	10,372.00	-	-	-	-	-	-	-
2685.00	5,370.00	-51.67	12.55	-53.49	6.53	V	-47.47	-76.78
	8,055.00	-52.33	11.00	-42.86	7.77	V	-39.63	-68.94
	10,740.00	-	-	-	-	-	-	-

- NOTES:**
1. Radiated Spurious Emission Measurements at 3 meters by Substitution Method according to ANSI/TIA/EIA-603-C-2004, Aug. 17, 2004:
 2. The magnitude of spurious emissions attenuated more than 20dB below the limit above 5th Harmonic for all channel.
 3. we have done x, y, z planes in EUT and horizontal and vertical polarization in detecting antenna.
 4. Worst case is 16QAM 3/4.

7.7 FREQUENCY STABILITY / VARIATION OF AMBIENT TEMPERATURE

7.7.1 FREQUENCY STABILITY (WiMAX-5 MHz)

OPERATING FREQUENCY: 2593,000,000 Hz
 REFERENCE VOLTAGE: 5.0 VDC
 DEVIATION LIMIT: ± 0.000 25 % or 2.5 ppm

Voltage (%)	Power (VDC)	Temp. (°C)	Frequency (Hz)	Frequency Error (Hz)	Deviation (%)	ppm
100%	3.700	+20(Ref)	2593 001 400	0	0.000 000	0.000
100%		-30	2592 999 100	-2300	-0.000 089	-0.887
100%		-20	2593 000 400	-1000	-0.000 039	-0.386
100%		-10	2593 001 190	-210	-0.000 008	-0.081
100%		0	2593 000 780	-620	-0.000 024	-0.239
100%		+10	2593 000 100	-1300	-0.000 050	-0.501
100%		+30	2593 000 680	-720	-0.000 028	-0.278
100%		+40	2593 001 860	460	0.000 018	0.177
100%		+50	2593 002 120	720	0.000 028	0.278
115%	4.255	+20	2593 000 000	-1400	-0.000 054	-0.540
Batt. Endpoint	3.400	+20	2593 000 000	-1400	-0.000 054	-0.540

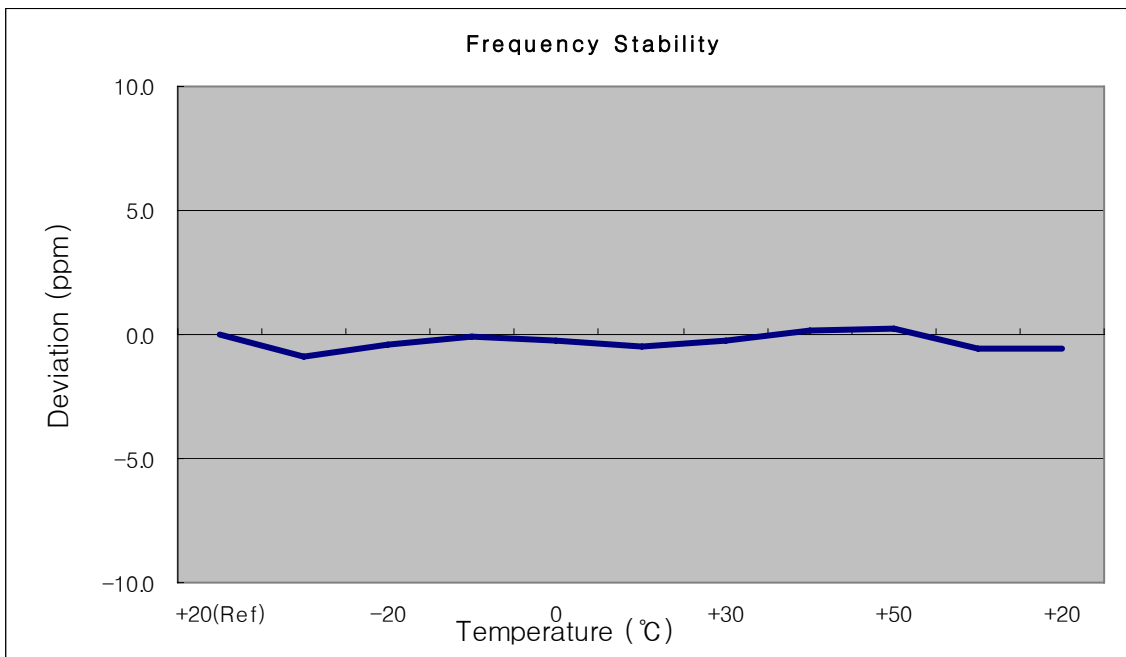

7.7.2 FREQUENCY STABILITY (WiMAX-10 MHz)

OPERATING FREQUENCY: 2593,000,000 Hz
 REFERENCE VOLTAGE: 5.0 VDC
 DEVIATION LIMIT: ± 0.000 25 % or 2.5 ppm

Voltage (%)	Power (VDC)	Temp. (°C)	Frequency (Hz)	Frequency Error (Hz)	Deviation (%)	ppm
100%	3.700	+20(Ref)	2593 001 500	0	0.000 000	0.000
100%		-30	2592 999 300	-2200	-0.000 085	-0.848
100%		-20	2593 000 400	-1100	-0.000 042	-0.424
100%		-10	2593 001 270	-230	-0.000 009	-0.089
100%		0	2593 000 890	-610	-0.000 024	-0.235
100%		+10	2593 000 200	-1300	-0.000 050	-0.501
100%		+30	2593 000 800	-700	-0.000 027	-0.270
100%		+40	2593 001 990	490	0.000 019	0.189
100%		+50	2593 002 230	730	0.000 028	0.282
115%	4.255	+20	2593 000 000	-1500	-0.000 058	-0.578
Batt. Endpoint	3.400	+20	2593 000 100	-1400	-0.000 054	-0.540

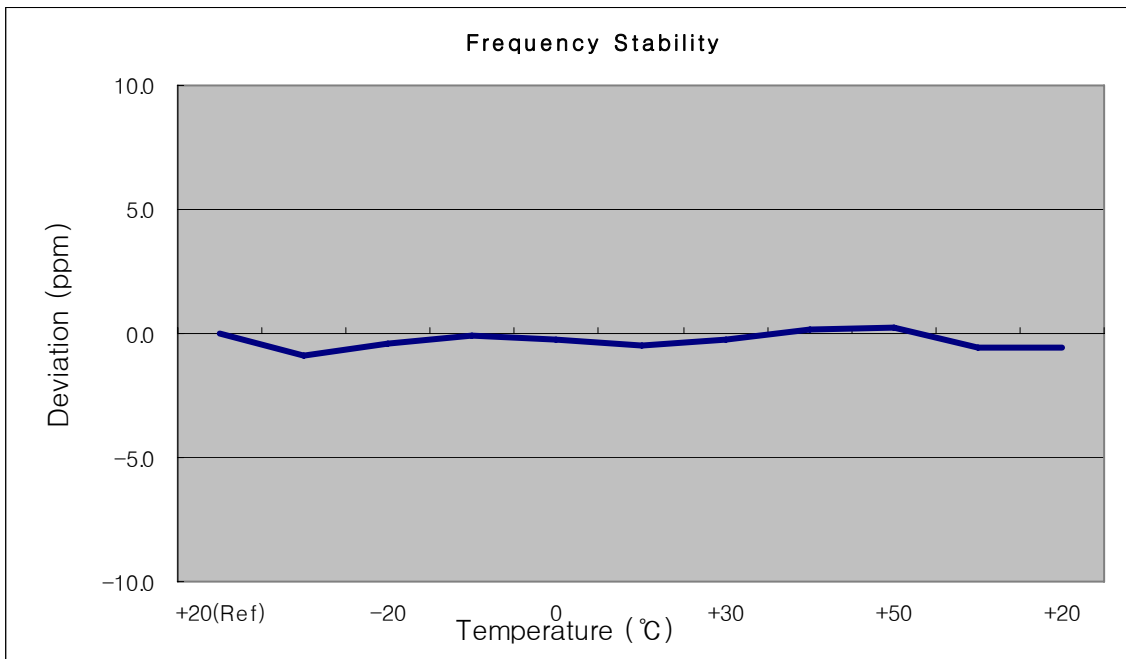



8. TEST PLOTS

FCC CERTIFICATION REPORT			www.hct.co.kr
Test Report No. HCTR1108FR17	Date of Issue: August 23, 2011	EUT Type: USB Dongle	FCC ID: XHGU602

5 MHz

■ QPSK MODE 1/2 (2498.5 MHz) Occupied Bandwidth

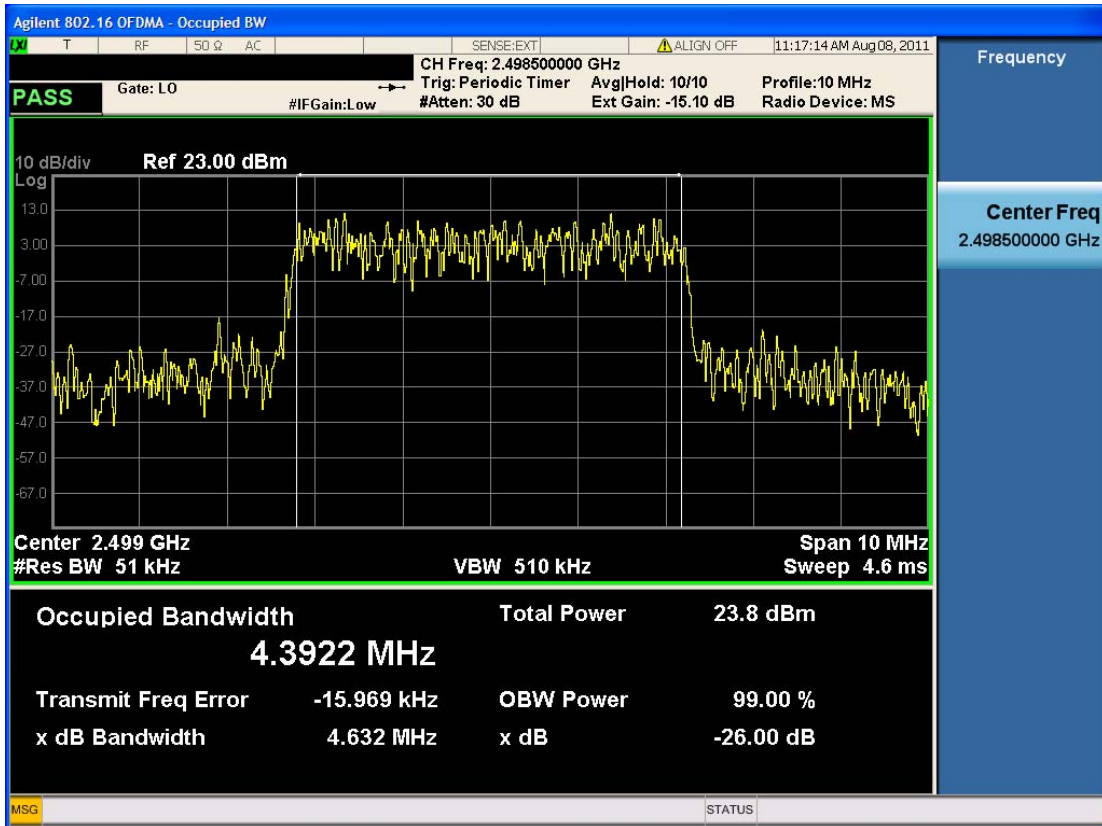

■ QPSK MODE 3/4 (2498.5 MHz) Occupied Bandwidth

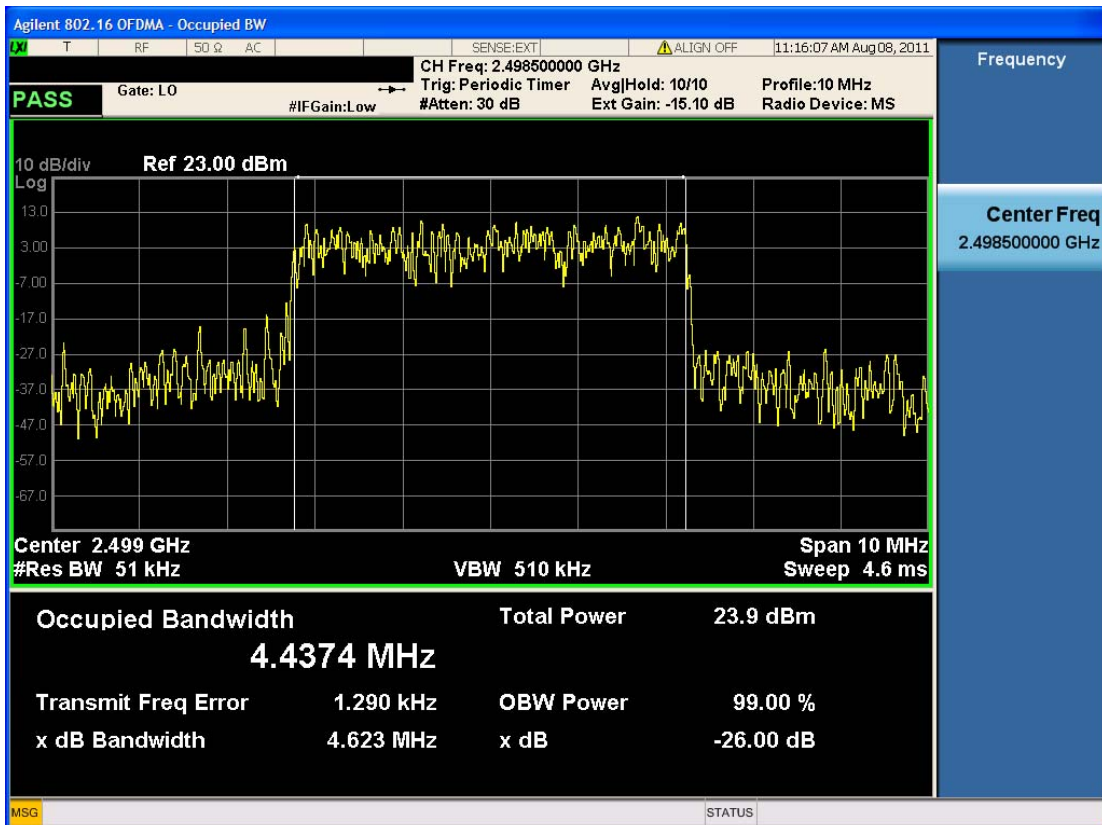

FCC CERTIFICATION REPORT

Test Report No. HCTR1108FR17	Date of Issue: August 23, 2011	EUT Type: USB Dongle	www.hct.co.kr FCC ID: XHGU602
---------------------------------	-----------------------------------	-------------------------	-------------------------------------

■ 16QAM MODE 1/2 (2498.5 MHz) Occupied Bandwidth

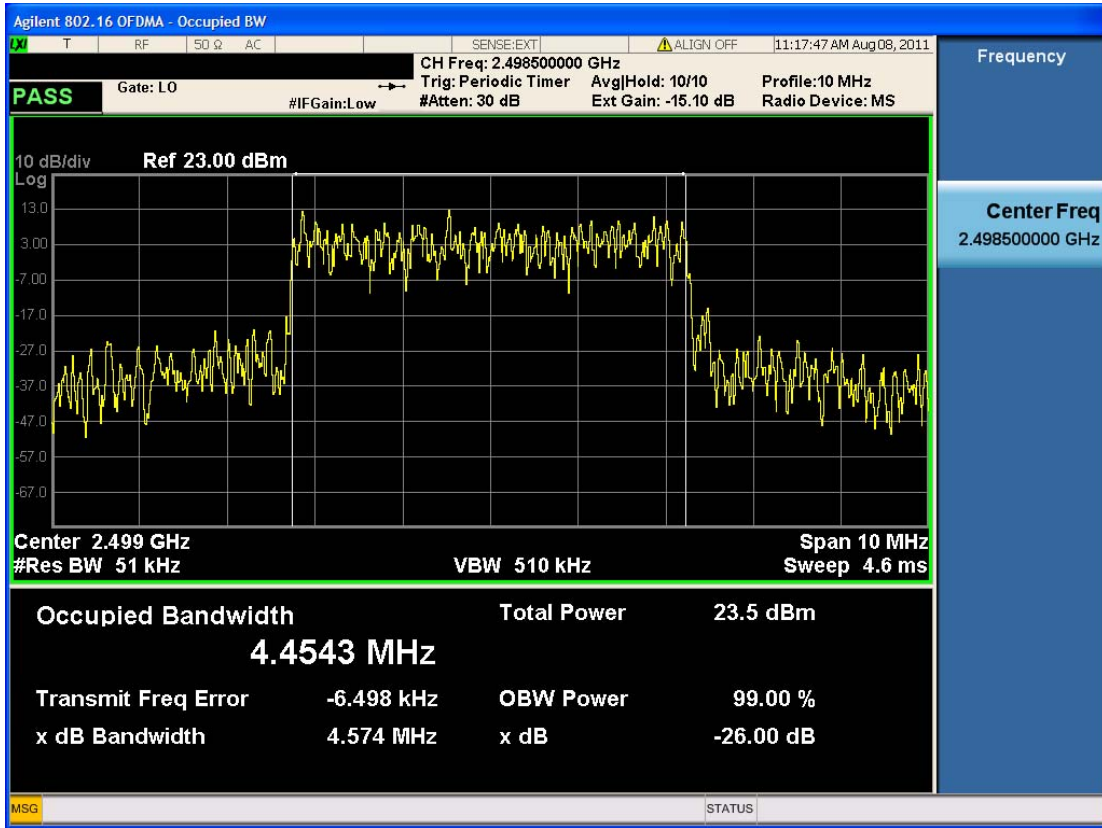

■ 16QAM MODE 3/4 (2498.5 MHz) Occupied Bandwidth

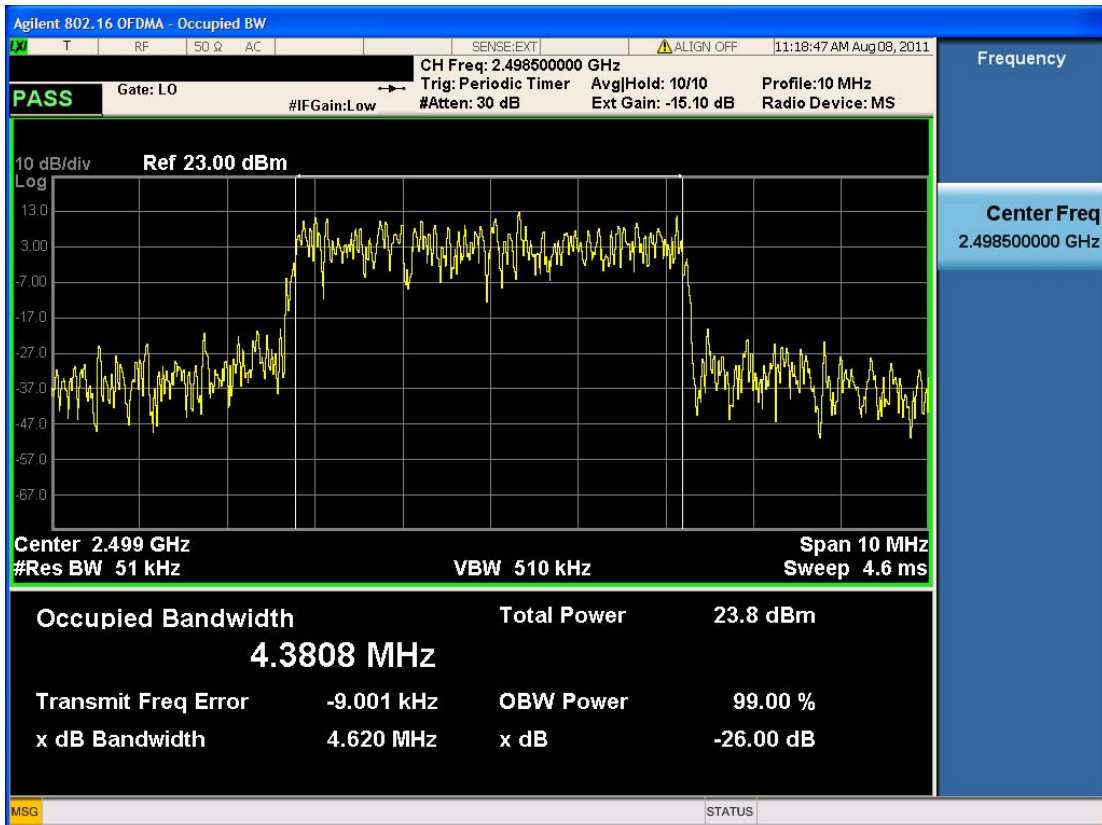

■ QPSK MODE 1/2 (2593.0 MHz) Occupied Bandwidth

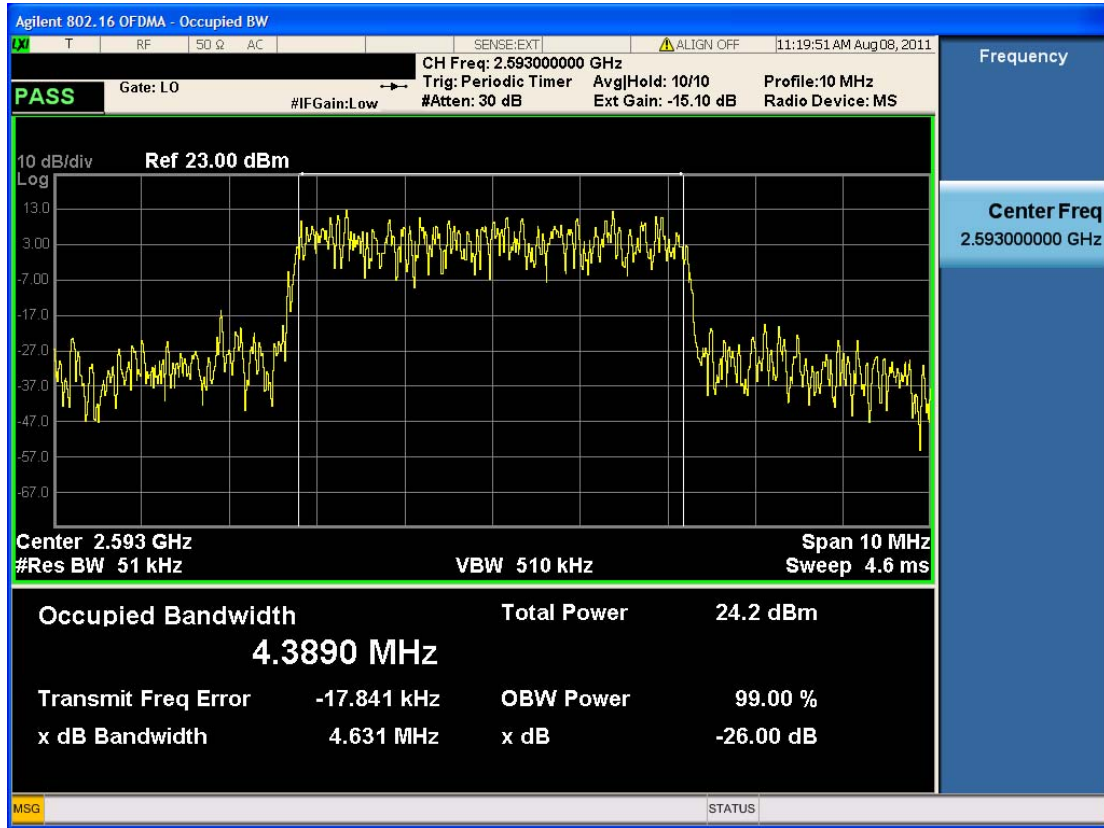

■ QPSK MODE 3/4 (2593.0 MHz) Occupied Bandwidth

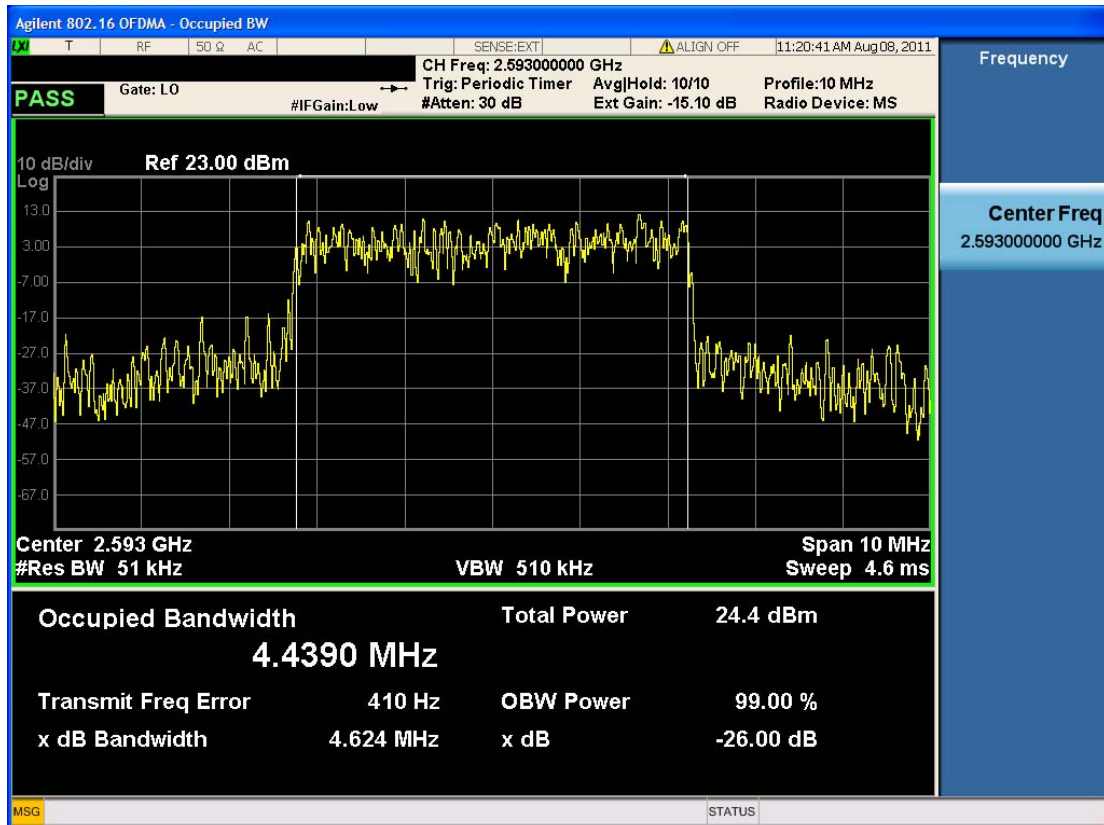

FCC CERTIFICATION REPORT			www.hct.co.kr
Test Report No. HCTR1108FR17	Date of Issue: August 23, 2011	EUT Type: USB Dongle	FCC ID: XHGU602

■ 16QAM MODE 1/2 (2593.0 MHz) Occupied Bandwidth

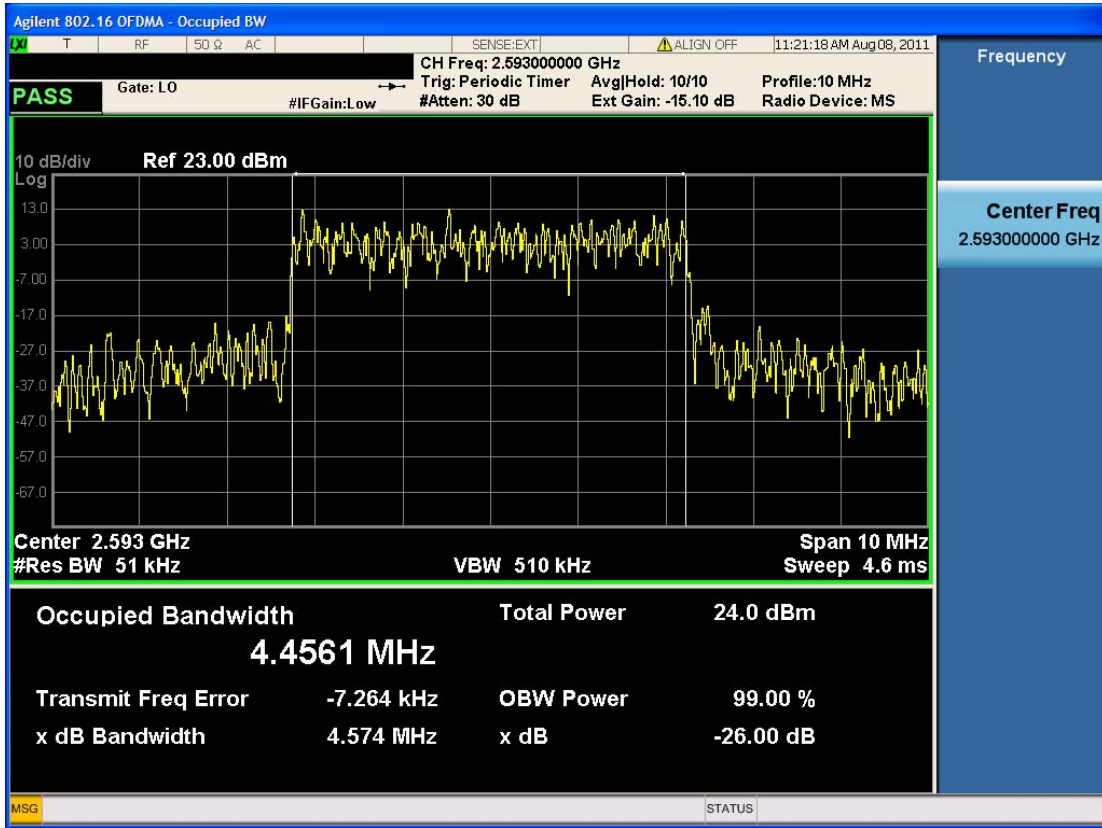

■ 16QAM MODE 3/4 (2593.0 MHz) Occupied Bandwidth

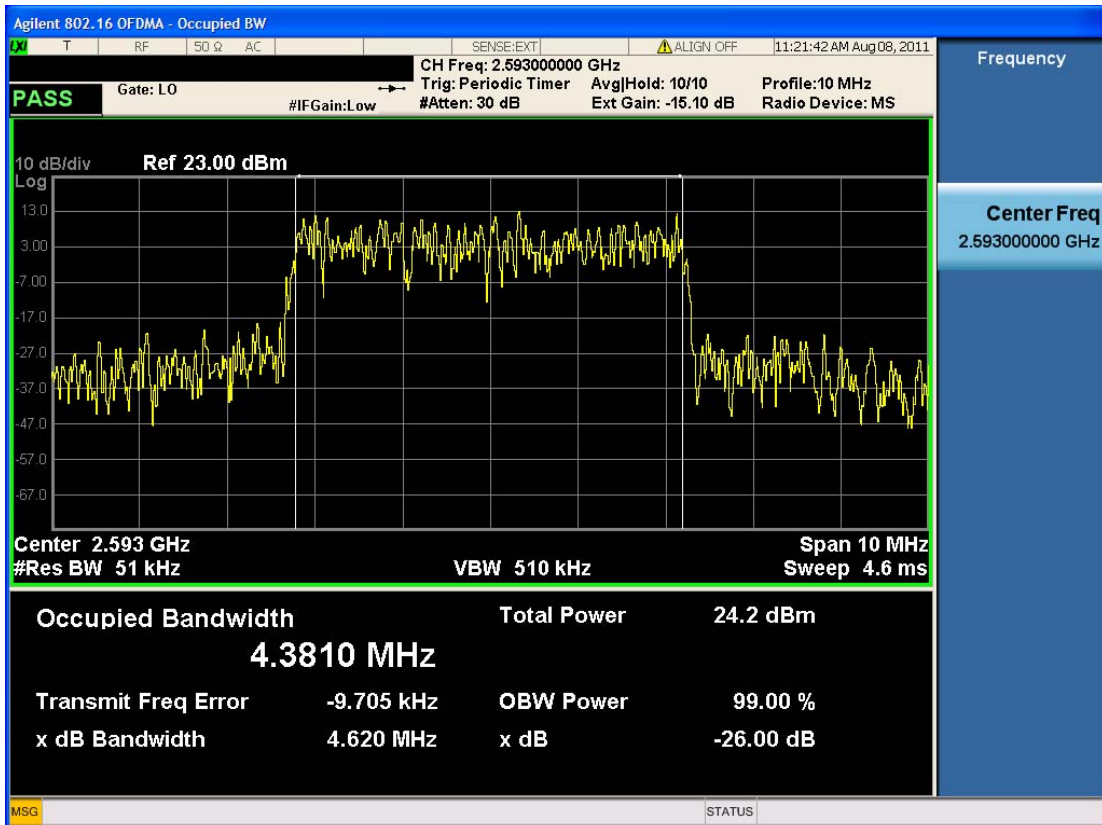

■ QPSK MODE 1/2 (2687.5 MHz) Occupied Bandwidth

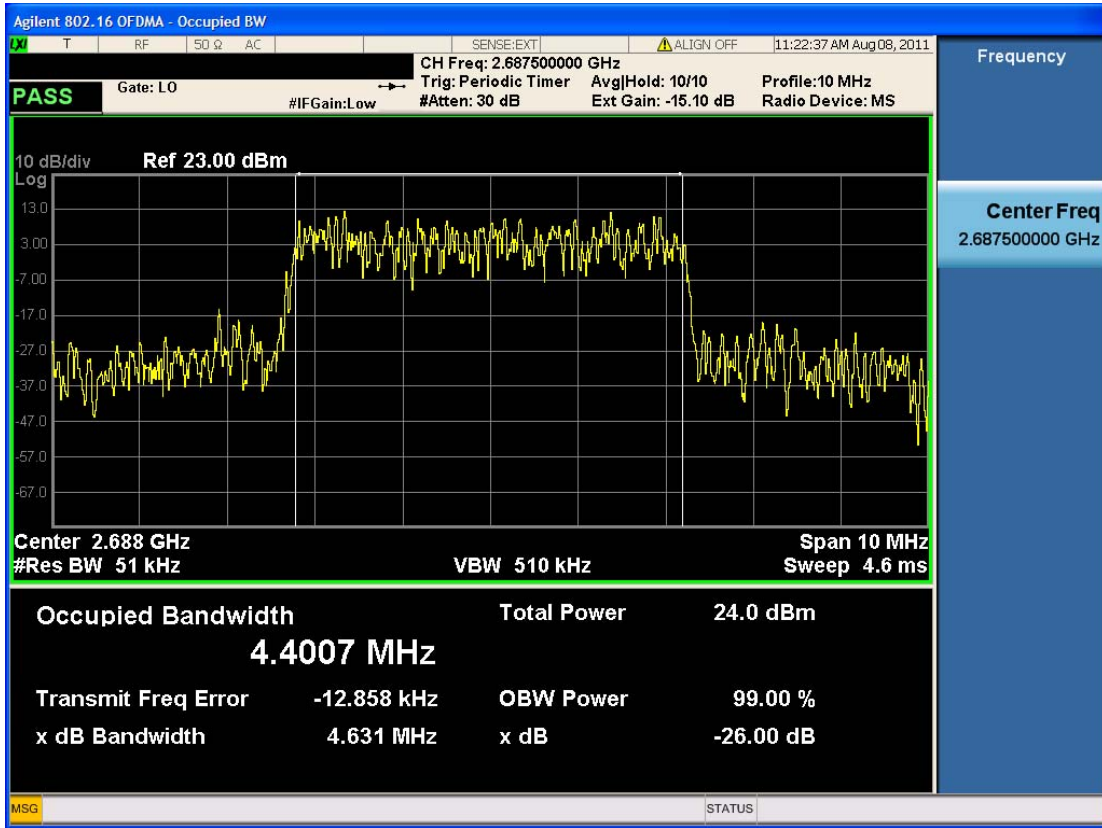

■ QPSK MODE 3/4 (2687.5 MHz) Occupied Bandwidth

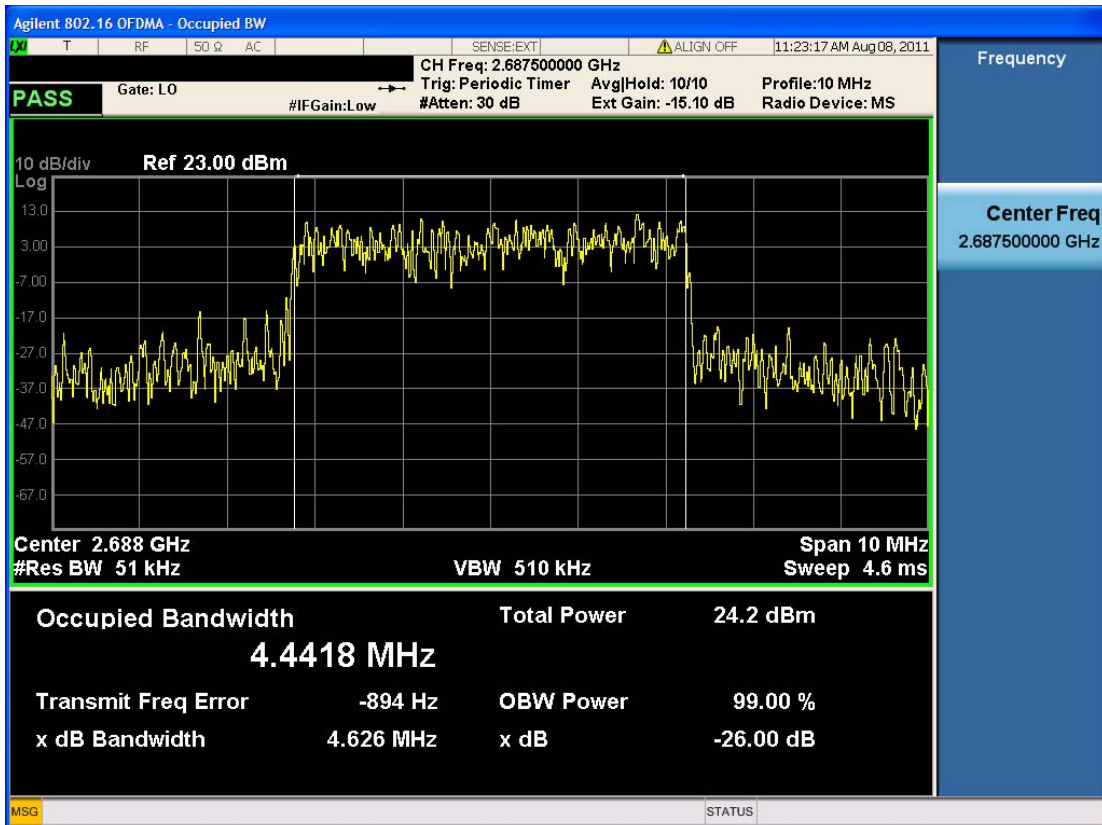

FCC CERTIFICATION REPORT			www.hct.co.kr
Test Report No. HCTR1108FR17	Date of Issue: August 23, 2011	EUT Type: USB Dongle	FCC ID: XHGU602

■ 16QAM MODE 1/2 (2687.5 MHz) Occupied Bandwidth

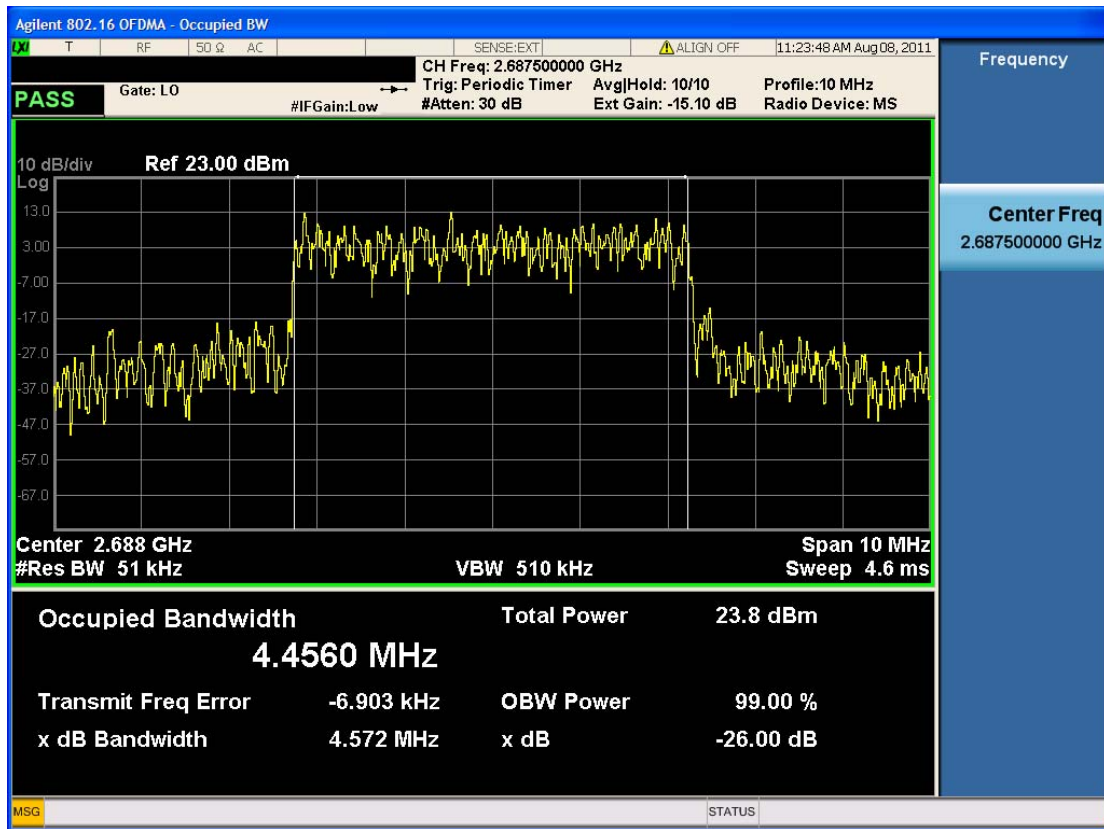

■ 16QAM MODE 3/4 (2687.5 MHz) Occupied Bandwidth

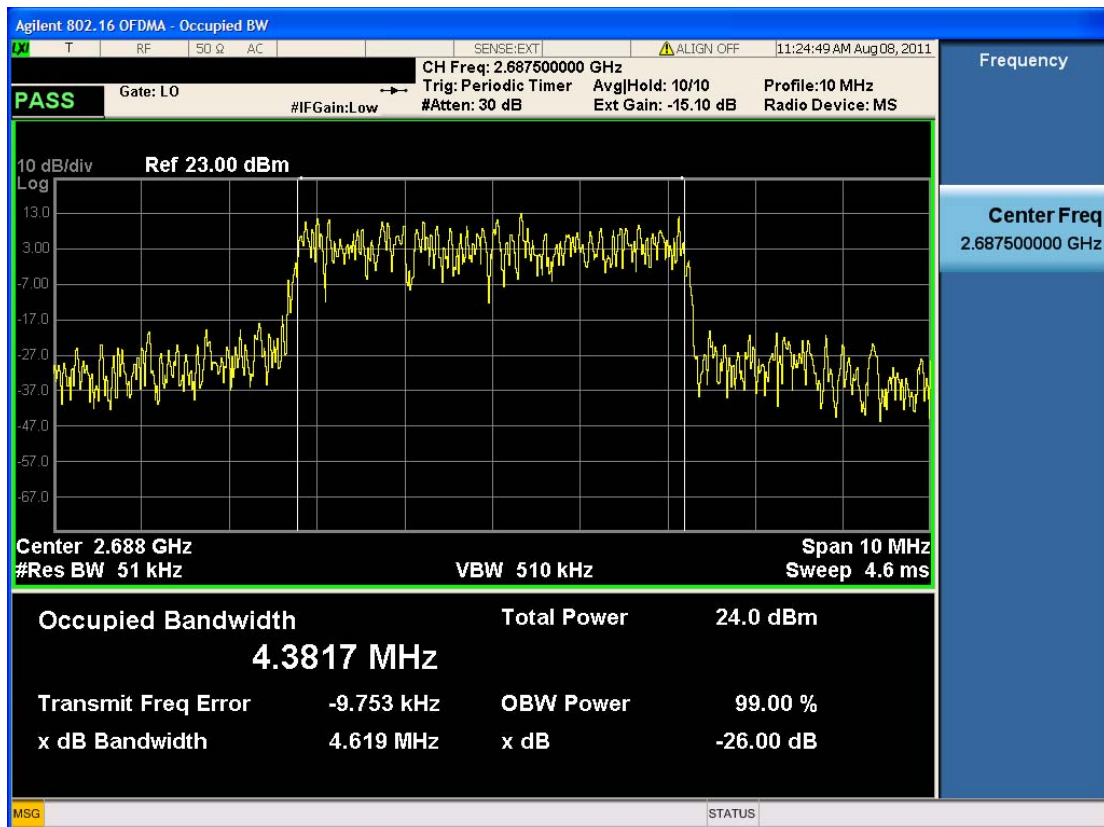

FCC CERTIFICATION REPORT			www.hct.co.kr
Test Report No. HCTR1108FR17	Date of Issue: August 23, 2011	EUT Type: USB Dongle	FCC ID: XHGU602

10 MHz

■ QPSK MODE 1/2 (2501.0 MHz) Occupied Bandwidth

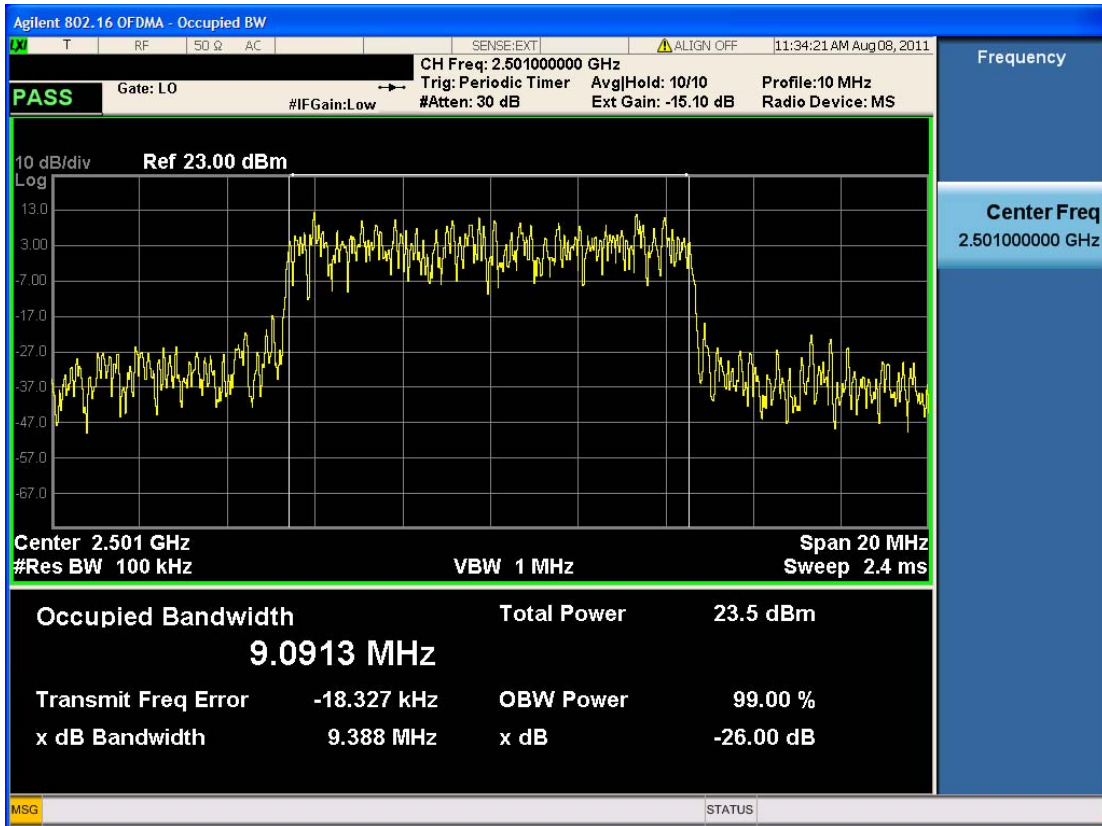

■ QPSK MODE 3/4 (2501.0 MHz) Occupied Bandwidth

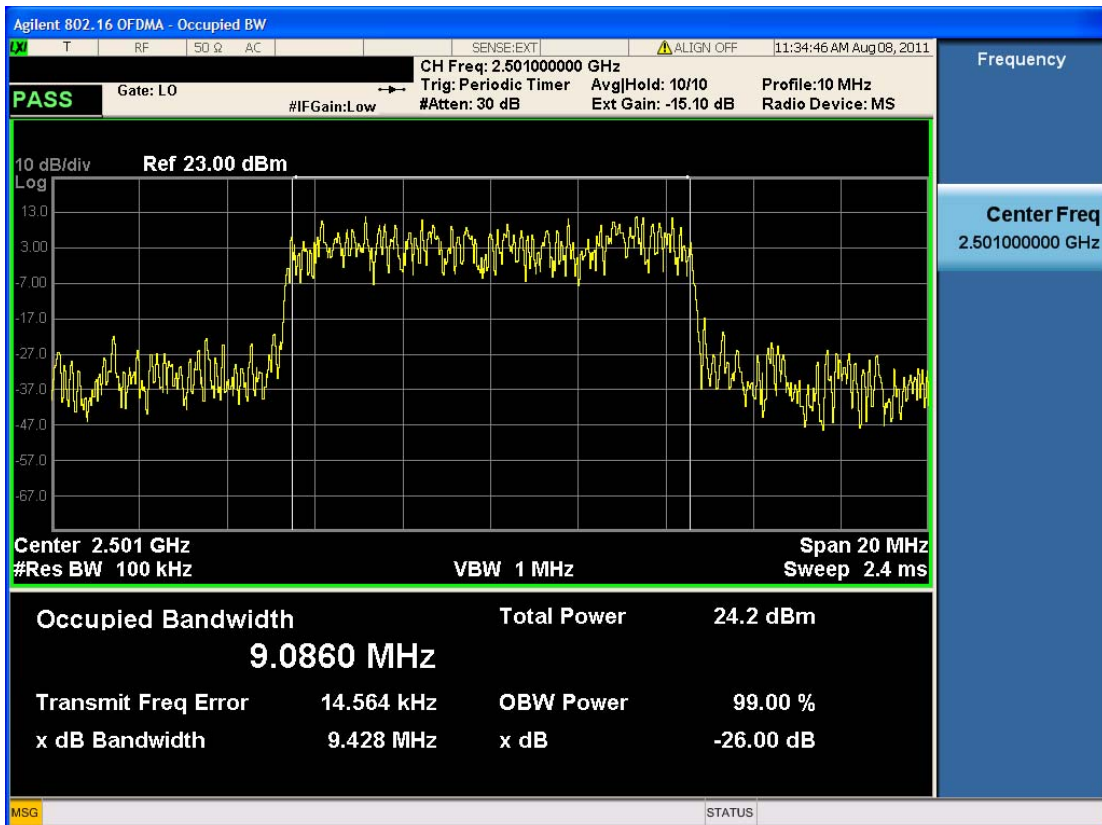

FCC CERTIFICATION REPORT			www.hct.co.kr
Test Report No. HCTR1108FR17	Date of Issue: August 23, 2011	EUT Type: USB Dongle	FCC ID: XHGU602

■ 16QAM MODE 1/2 (2501.0 MHz) Occupied Bandwidth

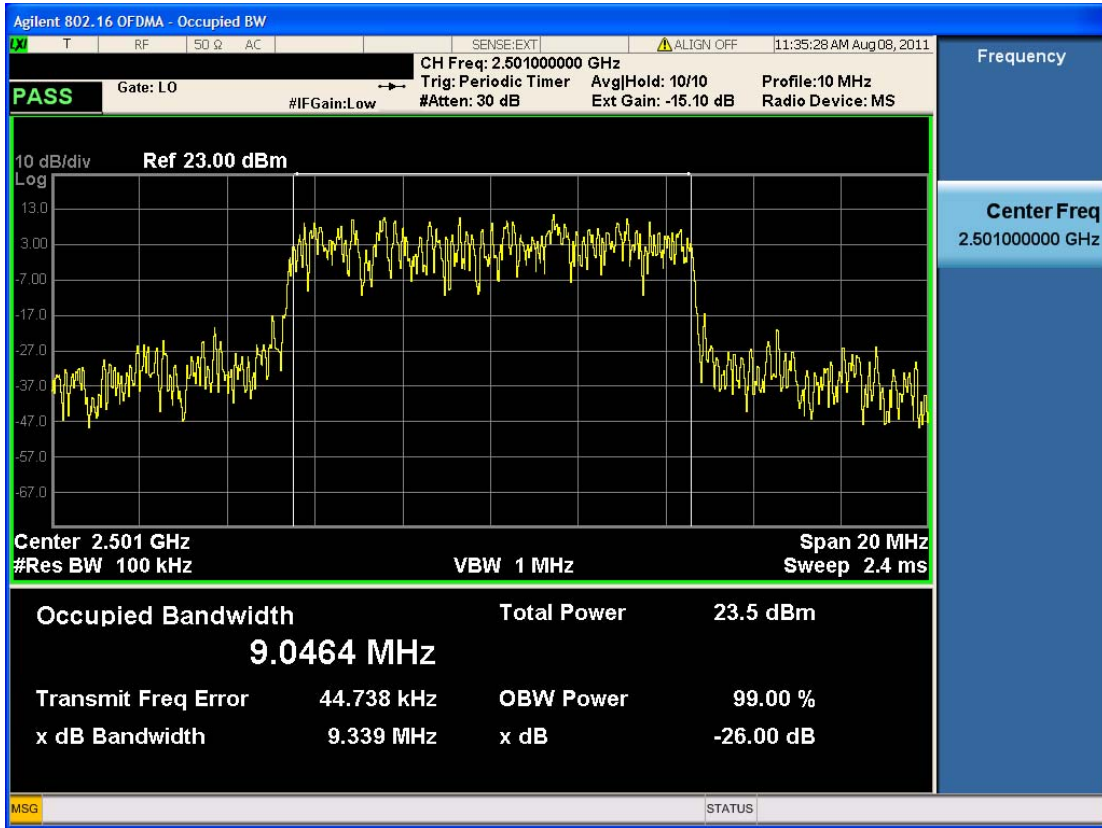

■ 16QAM MODE 3/4 (2501.0 MHz) Occupied Bandwidth

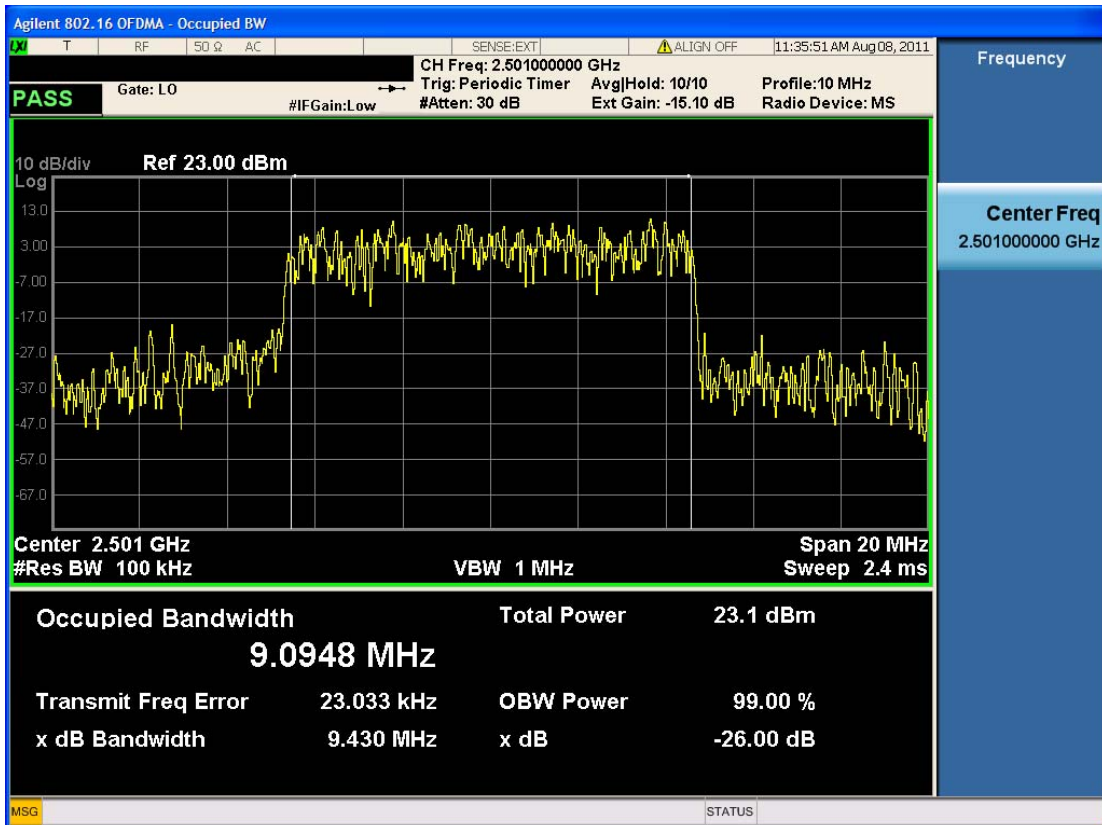

FCC CERTIFICATION REPORT			www.hct.co.kr
Test Report No. HCTR1108FR17	Date of Issue: August 23, 2011	EUT Type: USB Dongle	FCC ID: XHGU602

■ QPSK MODE 1/2 (2593.0 MHz) Occupied Bandwidth

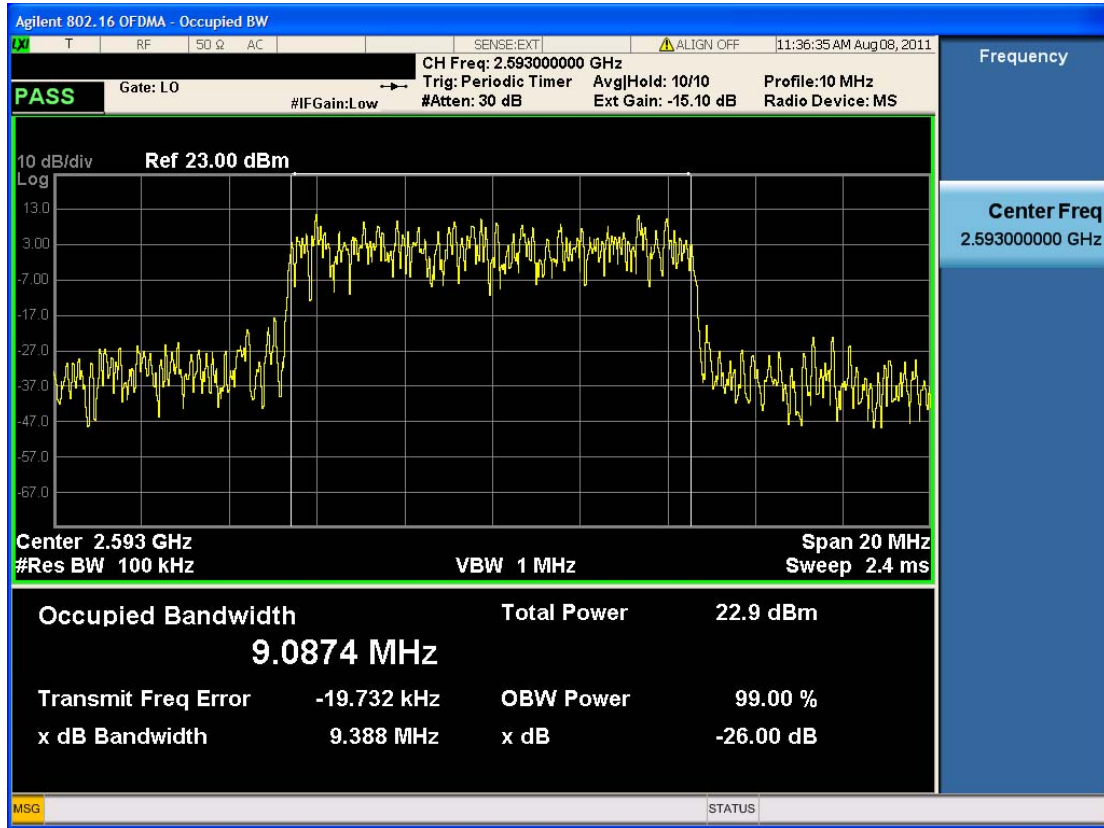

■ QPSK MODE 3/4 (2593.0 MHz) Occupied Bandwidth

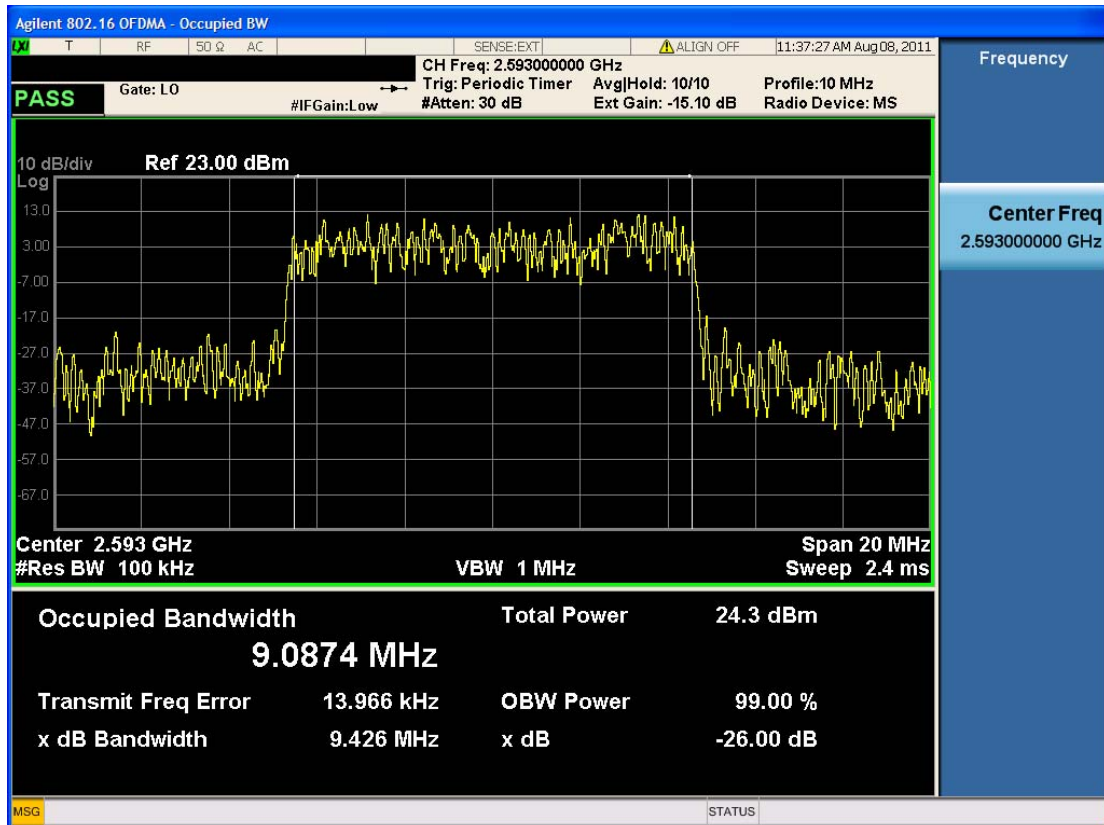

FCC CERTIFICATION REPORT			www.hct.co.kr
Test Report No. HCTR1108FR17	Date of Issue: August 23, 2011	EUT Type: USB Dongle	FCC ID: XHGU602

■ 16QAM MODE 1/2 (2593.0 MHz) Occupied Bandwidth

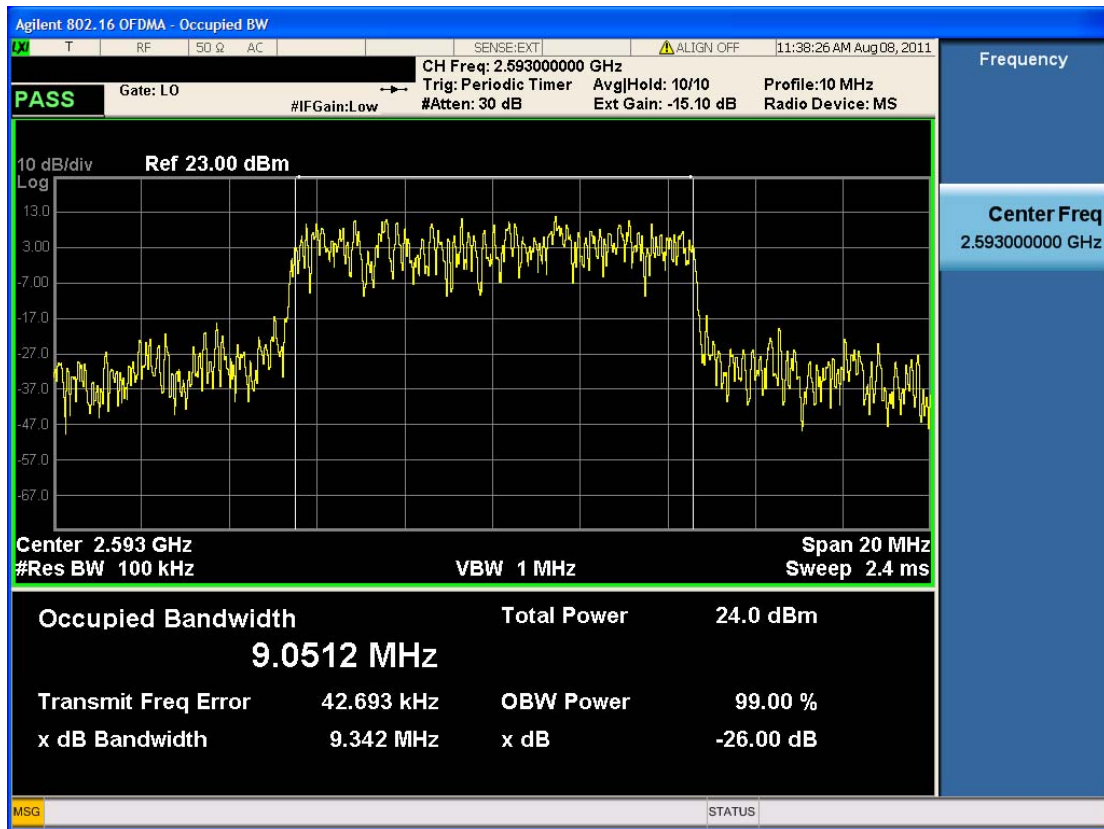

■ 16QAM MODE 3/4 (2593.0 MHz) Occupied Bandwidth

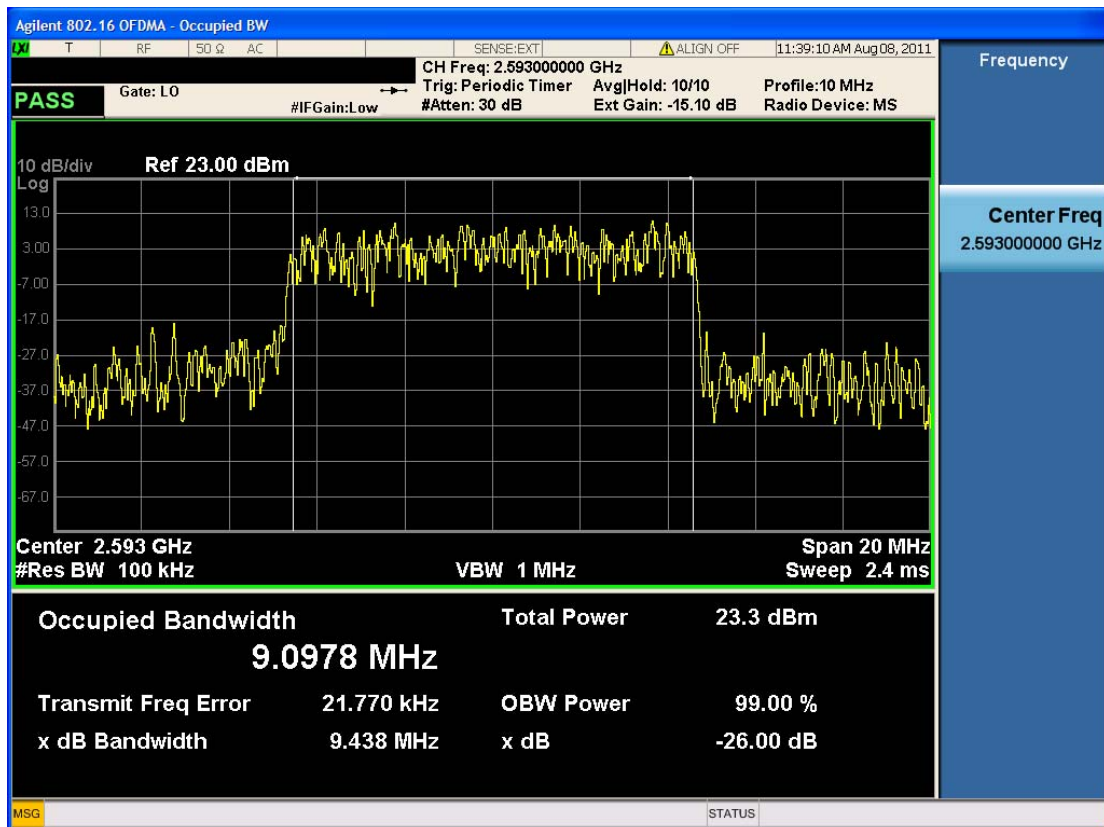

FCC CERTIFICATION REPORT			www.hct.co.kr
Test Report No. HCTR1108FR17	Date of Issue: August 23, 2011	EUT Type: USB Dongle	FCC ID: XHGU602

■ QPSK MODE 1/2 (2685.0 MHz) Occupied Bandwidth

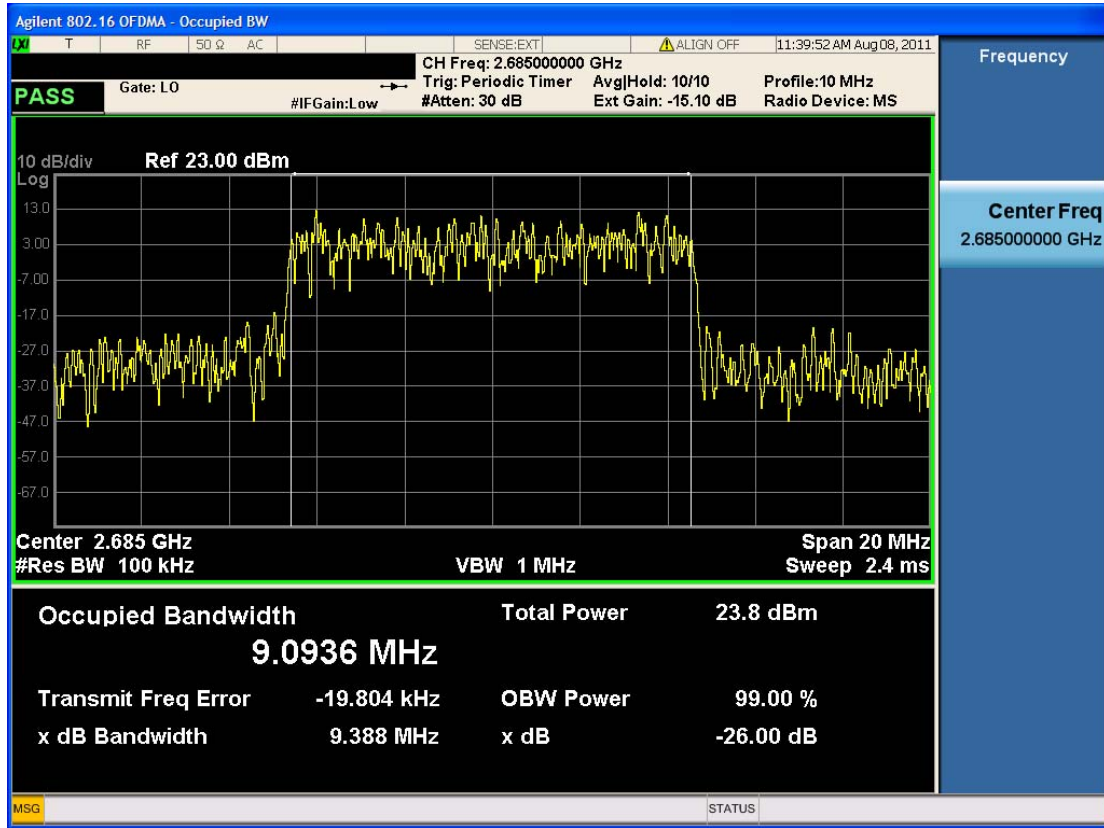

■ QPSK MODE 3/4 (2685.0 MHz) Occupied Bandwidth

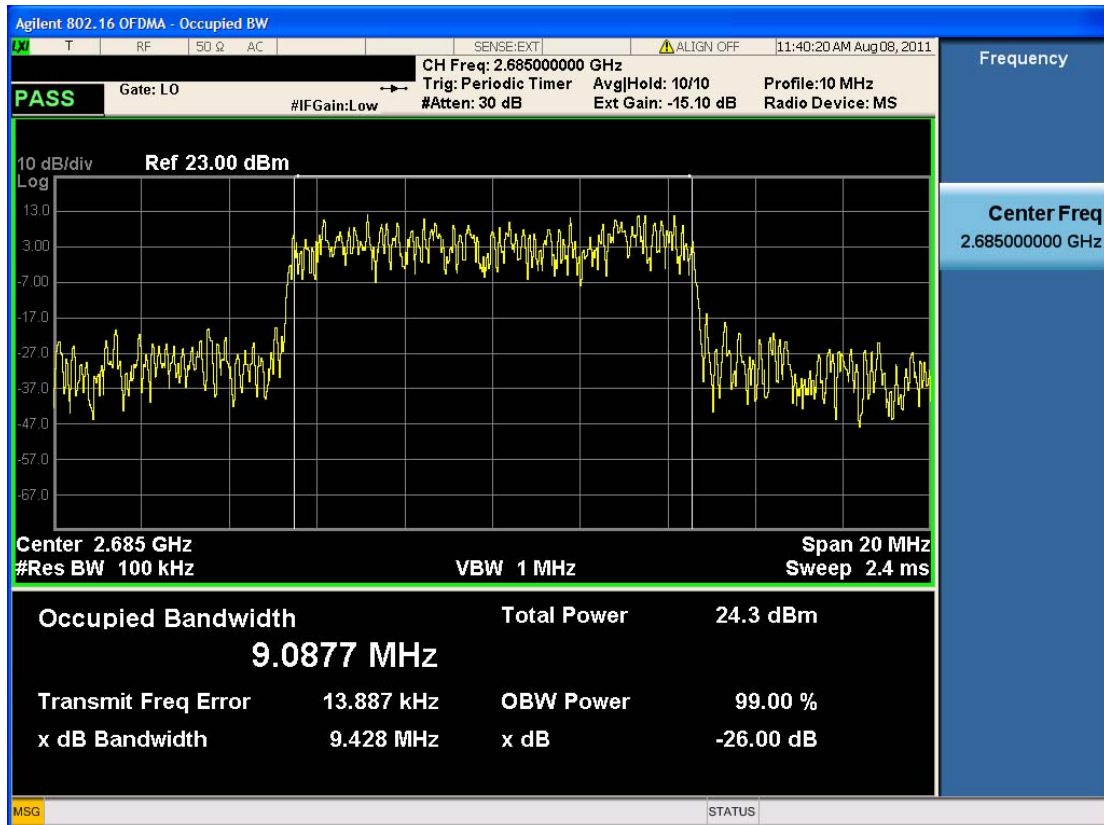

FCC CERTIFICATION REPORT			www.hct.co.kr
Test Report No. HCTR1108FR17	Date of Issue: August 23, 2011	EUT Type: USB Dongle	FCC ID: XHGU602

■ 16QAM MODE 1/2 (2685.0 MHz) Occupied Bandwidth

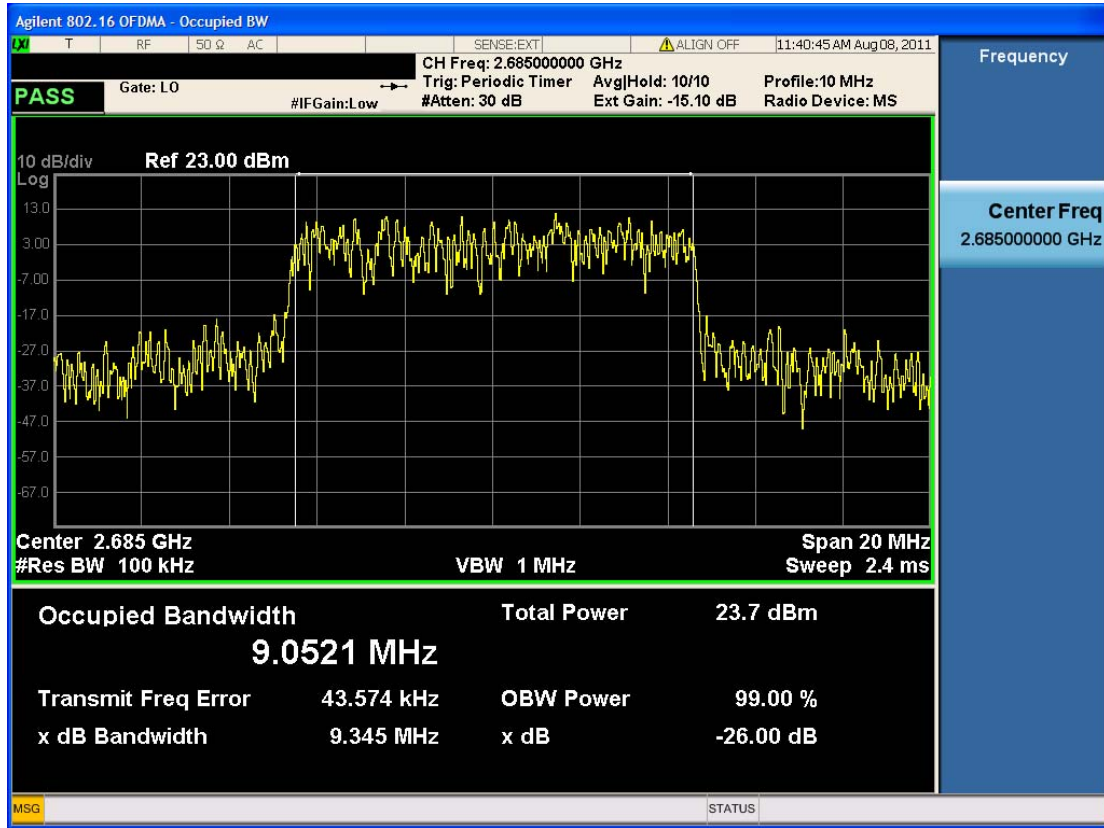

■ 16QAM MODE 3/4 (2685.0 MHz) Occupied Bandwidth

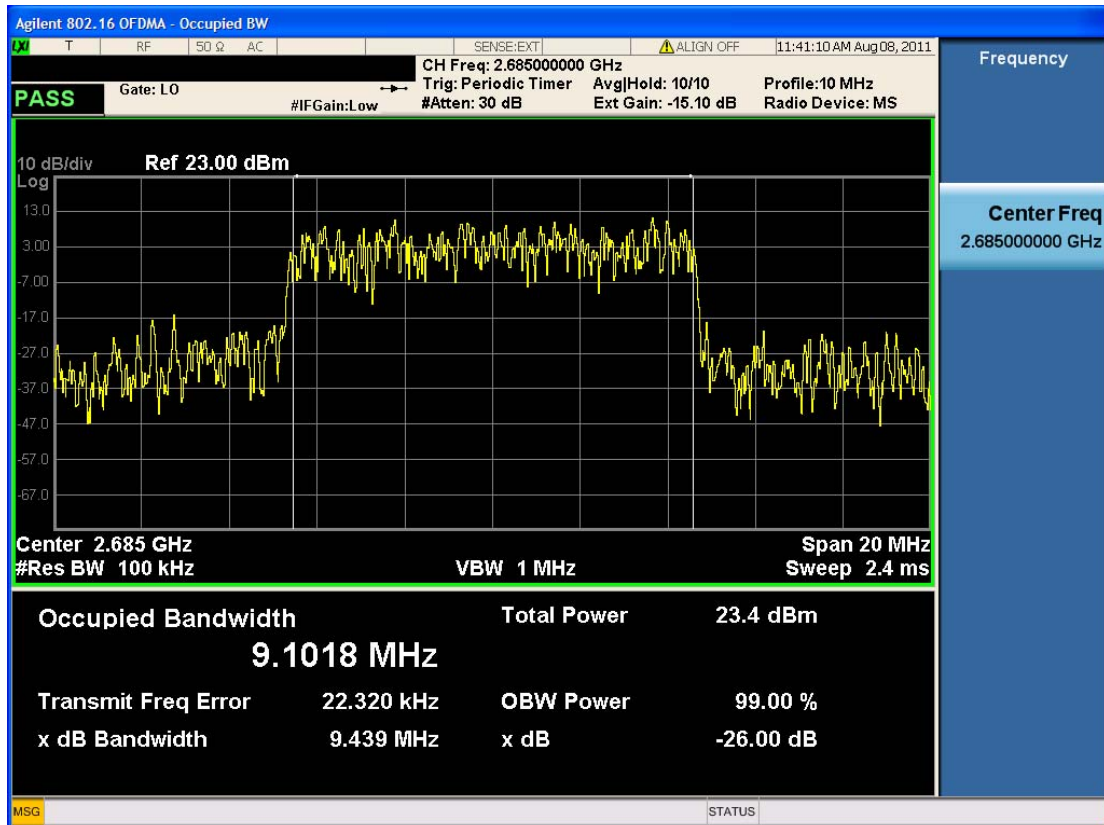

FCC CERTIFICATION REPORT			www.hct.co.kr
Test Report No. HCTR1108FR17	Date of Issue: August 23, 2011	EUT Type: USB Dongle	FCC ID: XHGU602

TX1: 5 MHz

■ QPSK MODE 1/2 (2498.5 MHz) Conducted Output Power

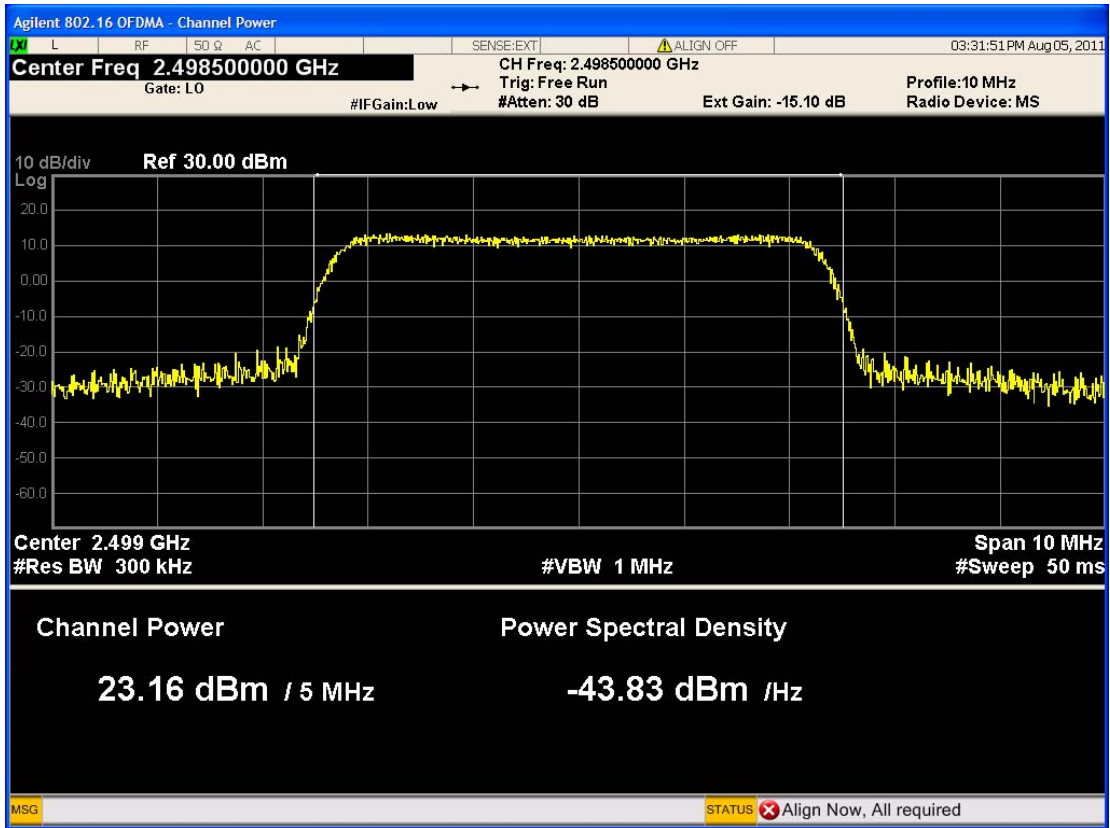

■ QPSK MODE 3/4 (2498.5 MHz) Conducted Output Power

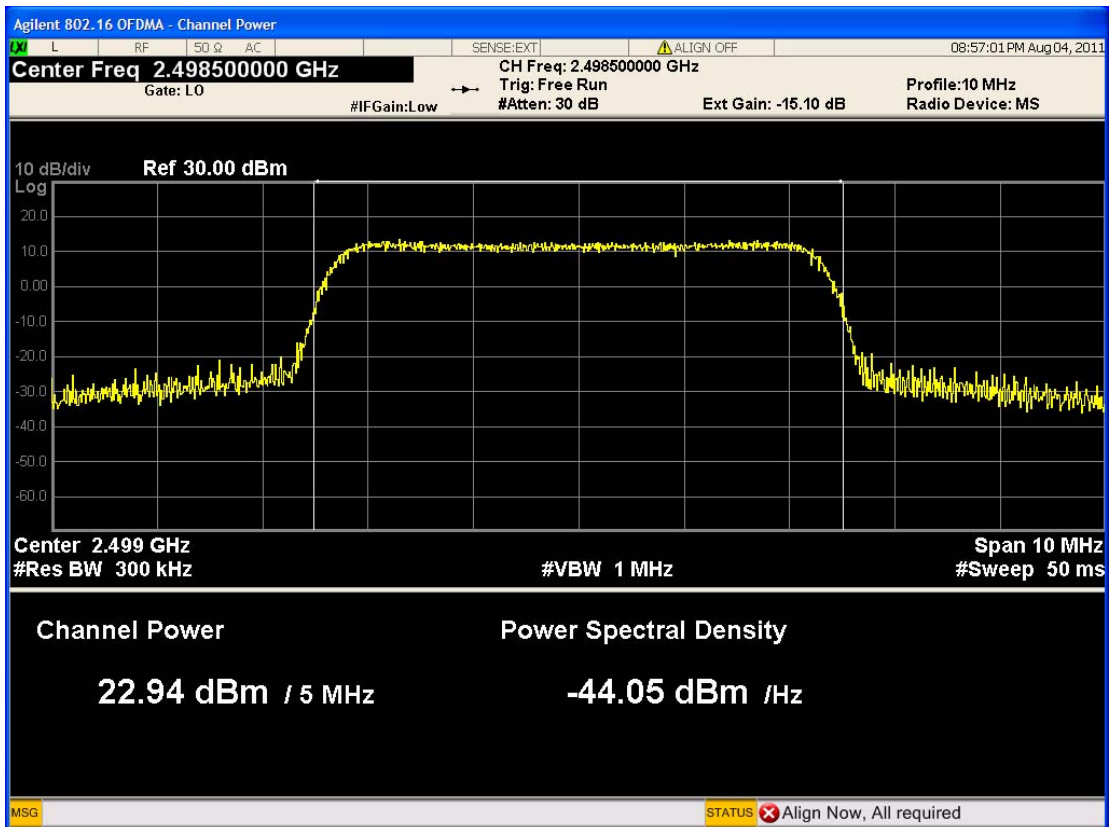

FCC CERTIFICATION REPORT			www.hct.co.kr
Test Report No. HCTR1108FR17	Date of Issue: August 23, 2011	EUT Type: USB Dongle	FCC ID: XHGU602

■ 16QAM MODE 1/2 (2498.5 MHz) Conducted Output Power

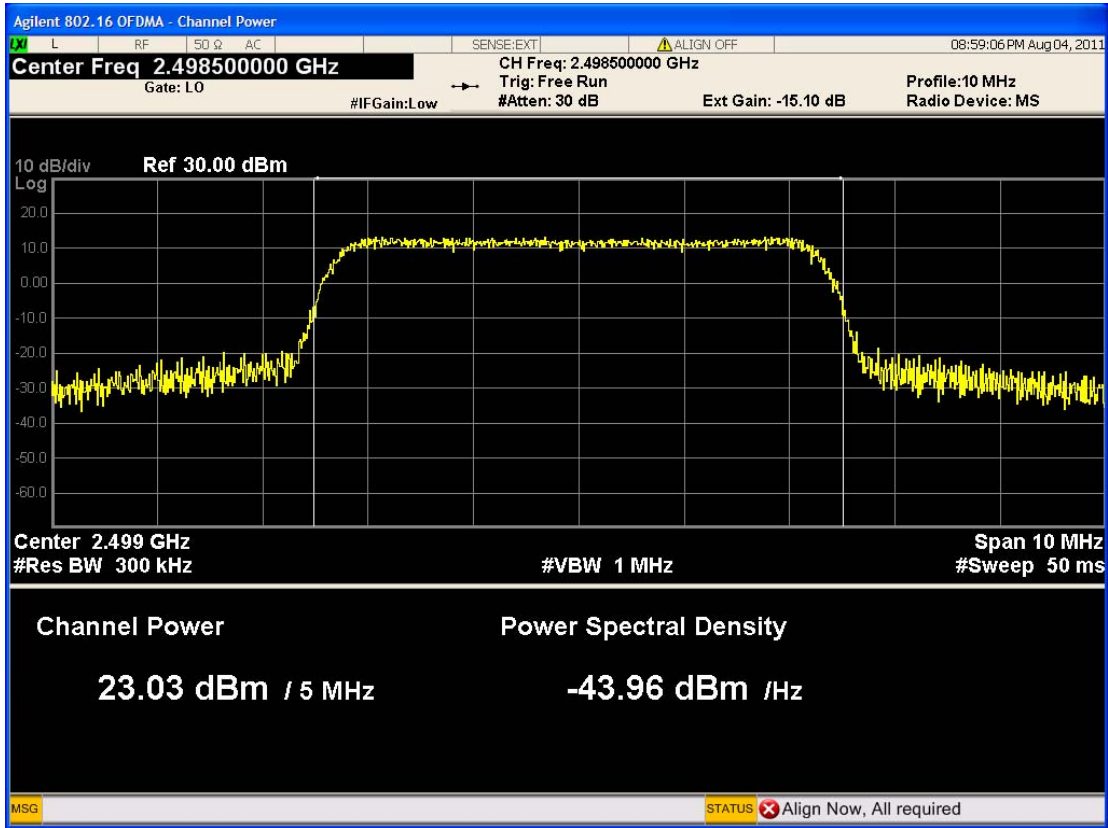

■ 16QAM MODE 3/4 (2498.5 MHz) Conducted Output Power

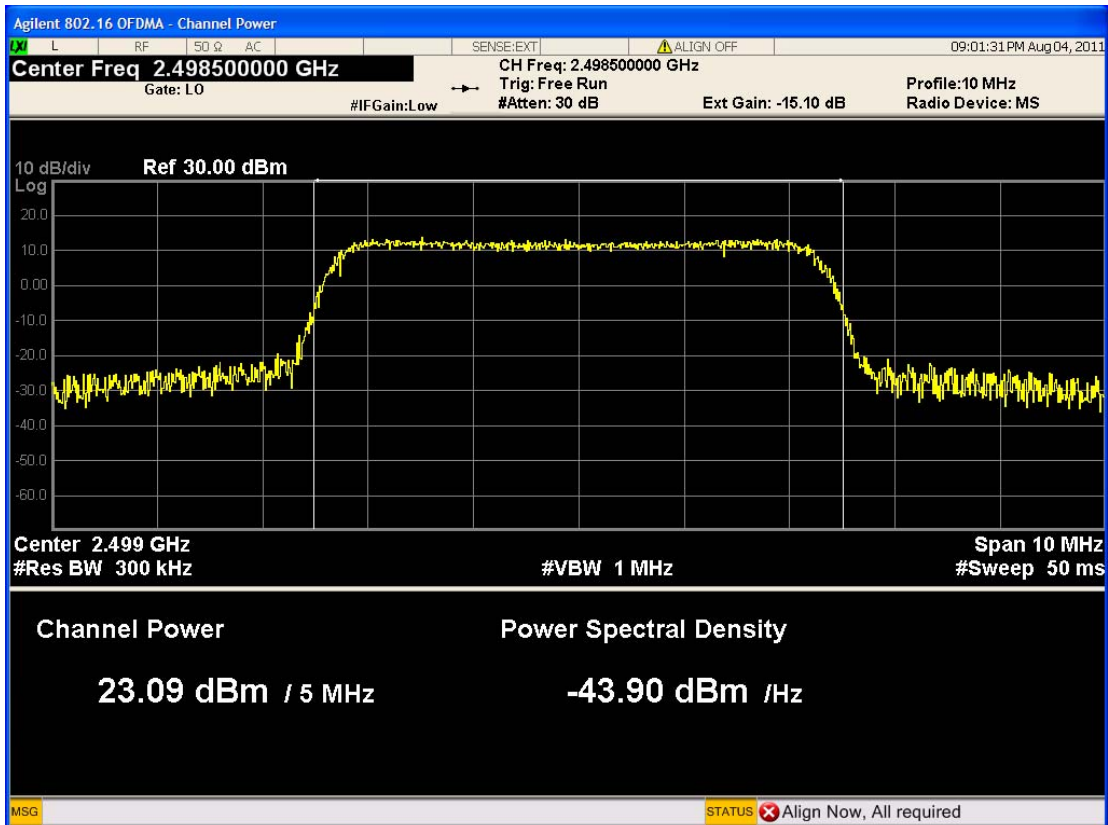

FCC CERTIFICATION REPORT			www.hct.co.kr
Test Report No. HCTR1108FR17	Date of Issue: August 23, 2011	EUT Type: USB Dongle	FCC ID: XHGU602