



# HCT CO., LTD.

## CERTIFICATE OF COMPLIANCE FCC Certification

<b>Applicant Name:</b> Franklin Technology Inc.	<b>Date of Issue:</b> June 15, 2011
<b>Address:</b> 906 JEI Platz 459-11 Gasan-dong, Gumcheon-Gu, Seoul, Korea	<b>Location:</b> HCT CO., LTD., 105-1, Jangam-ri, Majang-Myeon, Icheon-si, Kyunggi-Do, Korea
	<b>Test Report No.:</b> HCTR1106FR22
	<b>HCT FRN:</b> 0005866421

<b>FCC ID:</b>	<b>XHGU601</b>
<b>APPLICANT:</b>	<b>Franklin Technology Inc.</b>

<b>FCC Model(s):</b>	U601
<b>EUT Type:</b>	USB Dongle
<b>Tx Frequency:</b>	824.70 — 848.31 MHz (CDMA) 1 851.25 — 1 908.75 MHz (PCS CDMA)
<b>Rx Frequency:</b>	869.70 — 893.31 MHz (CDMA) 1 931.25 — 1 988.75 MHz (PCS CDMA)
<b>Max. RF Output Power:</b>	0.347 W ERP CDMA (25.40 dBm) / 0.601 W EIRP PCS CDMA (27.79 dBm) / 0.377 W ERP CDMA EVDO (25.76 dBm) / 0.714 W EIRP PCS EVDO (28.54 dBm)
<b>Emission Designator(s):</b>	1M28F9W (CDMA), 1M28F9W (PCS CDMA), 1M27F9W (CDMA EVDO), 1M28F9W (PCS CDMA EVDO)
<b>FCC Classification:</b>	PCS Licensed Transmitter (PCB)
<b>FCC Rule Part(s):</b>	§22, §24, §2

The measurements shown in this report were made in accordance with the procedures specified in §2.947. I assume full responsibility for the accuracy and completeness of these measurements, and for the qualifications of all persons taking them.

HCT CO., LTD. Certifies that no party to this application has subject to a denial of Federal benefits that includes FCC benefits pursuant to section 5301 of the Anti-Drug Abuse Act of 1998, 21 U.S.C. 853(a)

Hyo Sun Kwak  
**Report prepared by**  
**: Hyo Sun Kwak**  
**Test engineer of RF Team**

Chang Seok Choi  
**Approved by**  
**: Chang Seok Choi**  
**Manager of RF Team**

This report only responds to the tested sample and may not be reproduced, except in full, without written approval of the HCT Co., Ltd.

FCC CERTIFICATION REPORT				<a href="http://www.hct.co.kr">www.hct.co.kr</a>
Test Report No. HCTR1106FR22	Date of Issue: June 15, 2011	EUT Type: USB Dongle	FCC ID: XHGU601	Page 1 of 42

# Version

TEST REPORT NO.	DATE	DESCRIPTION
HCTR1106FR22	June 15, 2011	- First Approval Report

# Table of Contents

1. GENERAL INFORMATION .....	4
2. INTRODUCTION .....	5
2.1. EUT DESCRIPTION.....	5
2.2. MEASURING INSTRUMENT CALIBRATION.....	5
2.3. TEST FACILITY .....	5
3. DESCRIPTION OF TESTS .....	6
3.1 EFFECTIVE RADIATED POWER/EQUIVALENT ISOTROPIC RADIATED POWER.....	6
3.2 PEAK- TO- AVERAGE RATIO .....	7
3.3 OCCUPIED BANDWIDTH. ....	8
3.4 SPURIOUS AND HARMONIC EMISSIONS AT ANTENNA TERMINAL.....	9
3.5 RADIATED SPURIOUS AND HARMONIC EMISSIONS.....	10
3.6 FREQUENCY STABILITY / VARIATION OF AMBIENT TEMPERATURE .....	11
4. LIST OF TEST EQUIPMENT .....	12
5. SUMMARY OF TEST RESULTS .....	13
6. SAMPLE CALCULATION .....	14
7. TEST DATA .....	15
7.1 CONDUCTED OUTPUT POWER .....	15
7.2 PEAK-TO-AVERAGE RATIO .....	15
7.3 OCCUPIED BANDWIDTH .....	16
7.4 CONDUCTED SPURIOUS EMISSIONS .....	16
7.4.1 Band Edge .....	16
7.5 EFFECTIVE RADIATED POWER OUTPUT – Normal.....	17
7.6 EQUIVALENT ISOTROPIC RADIATED POWER .....	18
7.7 RADIATED SPURIOUS EMISSIONS.....	19
7.7.1 RADIATED SPURIOUS EMISSIONS(CDMA Mode).....	19
7.7.2 RADIATED SPURIOUS EMISSIONS(PCS CDMA Mode) .....	20
7.8 FREQUENCY STABILITY / VARIATION OF AMBIENT TEMPERATURE .....	21
7.8.1 FREQUENCY STABILITY (CDMA).....	21
7.8.2 FREQUENCY STABILITY (PCS CDMA) .....	22
8. TEST PLOTS.....	23

# MEASUREMENT REPORT

## 1. GENERAL INFORMATION

**Applicant Name:** Franklin Technology Inc.

**Address:** 906 JEI Platz 459-11 Gasan-dong, Gumcheon-Gu, Seoul, Korea

**FCC ID:** XHGU601

**Application Type:** Certification

**FCC Classification:** PCS Licensed Transmitter (PCB)

**FCC Rule Part(s):** §22, §24, §2,

**EUT Type:** USB Dongle

**FCC Model(s):** U601

**Tx Frequency:** 824.70 — 848.31 MHz (CDMA)  
1 851.25 — 1 908.75 MHz (PCS CDMA)

**Rx Frequency:** 869.70 — 893.31 MHz (CDMA)  
1 931.25 — 1 988.75 MHz (PCS CDMA)

**Max. RF Output Power:** 0.347 W ERP CDMA (25.40 dBm) / 0.601 W EIRP PCS CDMA (27.79 dBm) /  
0.377 W ERP CDMA EVDO (25.76 dBm) / 0.714 W EIRP PCS EVDO (28.54 dBm)

**Emission Designator(s):** 1M28F9W (CDMA), 1M28F9W (PCS CDMA),  
1M27F9W (CDMA EVDO), 1M28F9W (PCS CDMA EVDO)

**Antenna Specification** Manufacturer: KWANG HYUN AIRTECH CO.,LTD  
Antenna type: PIFA Antenna  
Peak Gain: 0.97 dBi

**Date(s) of Tests:** May 20, 2011 ~ June 03, 2011

## **2. INTRODUCTION**

### **2.1. EUT DESCRIPTION**

The U601 USB Dongle consists of Cellular CDMA, PCS CDMA, 1xEVDO Rev.0, A and wimax.

### **2.2. MEASURING INSTRUMENT CALIBRATION**

The measuring equipment, which was utilized in performing the tests documented herein, has been calibrated in accordance with the manufacturer's recommendations for utilizing calibration equipment, which is traceable to recognized national standards.

### **2.3. TEST FACILITY**

The SAC(Semi-Anechoic Chamber) and conducted measurement facility used to collect the radiated data are located at the 105-1, Jangam-ri, Majang-Myeon, Icheon-si, Kyunggi-Do, 467-811, Korea. The site is constructed in conformance with the requirements of ANSI C63.4 and CISPR Publication 22. Detailed description of test facility was submitted to the Commission and accepted dated March 02, 2011 (Registration Number: 90661)

FCC CERTIFICATION REPORT				<a href="http://www.hct.co.kr">www.hct.co.kr</a>
Test Report No. HCTR1106FR22	Test Dates: June 15, 2011	EUT Type: USB Dongle	FCC ID: XHGU601	Page 5 of 42

### 3. DESCRIPTION OF TESTS

#### 3.1 EFFECTIVE RADIATED POWER/EQUIVALENT ISOTROPIC RADIATED POWER

##### Test Set-up

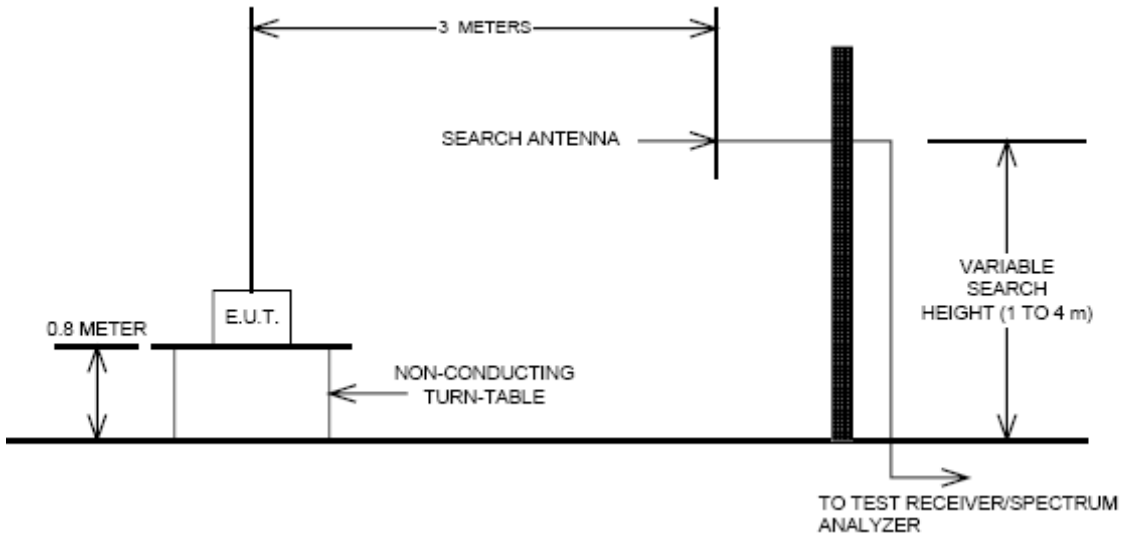

##### Test Procedure

Radiated emission measurements were performed at an SAC(Semi-Anechoic Chamber)

The equipment under test is placed on a non-conductive styrofoam resin table 3-meters from the receive antenna. A styrofoam turntable was rotated 360° and the receiving antenna scanned from 1-4m in order to capture the maximum emission. A half wave dipole was substituted in place of the EUT. This dipole antenna was driven by a signal generator and the previously recorded signal was duplicated.

The maximum EIRP was calculated by adding the forward power to the calibrated source plus its appropriate gain value. These steps were carried out with the receiving antenna in both vertical and horizontal polarization. For readings above 1GHz, the above procedure is repeated using horn antennas and the difference between the gain of the horn and an isotropic antenna are taken into consideration.

Note : This device was tested under all R.C.s and S.O.s and worst case is reported with RC3/SO2(CDMA) and RC3/SO2(PCS), with 'All Up' power control bits.

FCC CERTIFICATION REPORT				<a href="http://www.hct.co.kr">www.hct.co.kr</a>
Test Report No. HCTR1106FR22	Test Dates: June 15, 2011	EUT Type: USB Dongle	FCC ID: XHGU601	Page 6 of 42

### 3.2 PEAK- TO- AVERAGE RATIO

A peak to average ratio measurement is performed at the conducted port of the EUT. For CDMA and WCDMA signals, the spectrum analyzers Complementary Cumulative Distribution Function ( CCDF ) measurement profile is used to determine the largest deviation between the average and the peak power of the EUT in a given bandwidth. The CCDF curve shows how much time the peak waveform spends at or above a given average power level. The percent of time the signal spends at or above the level defines the probability for that particular power level. For GSM signals, an average and a peak trace are used on a spectrum analyzer to determine the largest deviation between the average and the peak power of the EUT in a bandwidth greater than the emission bandwidth. Plots of the EUT's Peak- to- Average Ratio are shown herein.

Note : This device was tested under all R.C.s and S.O.s and worst case is reported with RC3/SO2(CDMA) and RC3/SO2(PCS), with 'All Up' power control bits.

FCC CERTIFICATION REPORT				<a href="http://www.hct.co.kr">www.hct.co.kr</a>
Test Report No. HCTR1106FR22	Test Dates: June 15, 2011	EUT Type: USB Dongle	FCC ID: XHGU601	Page 7 of 42

### 3.3 OCCUPIED BANDWIDTH.

#### Test set-up

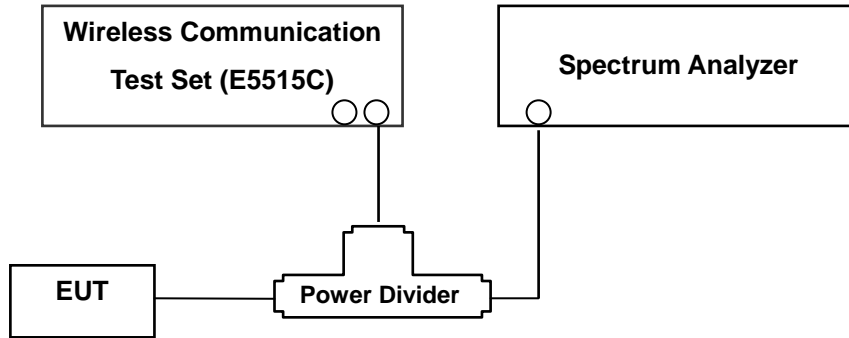

(Configuration of conducted Emission measurement)

#### Test Procedure

The EUT was setup to maximum output power at its lowest channel. The occupied bandwidth was measured using a spectrum analyzer. The measurements are repeated for the highest and a middle channel. The EUT's occupied bandwidth is measured as the width of the signal between two points, one below the carrier center frequency and one above the carrier frequency, outside of which all emissions are attenuated at least 26 dB below the transmitter power. Plots of the EUT's occupied bandwidth are shown herein.

Note : This device was tested under all R.C.s and S.O.s and worst case is reported with RC3/SO2(CDMA) and RC3/SO2(PCS), with 'All Up' power control bits.

±



### 3.4 SPURIOUS AND HARMONIC EMISSIONS AT ANTENNA TERMINAL.

#### Test Procedure

The level of the carrier and the various conducted spurious and harmonic frequencies is measured by means of a calibrated spectrum analyzer.

The EUT was setup to maximum output power at its lowest channel. The Resolution BW of the analyzer is set to 1 % of the emission bandwidth to show compliance with the – 13 dBm limit, in the 1 MHz bands immediately outside and adjacent to the edge of the frequency block. The 1 MHz RBW was used to scan from 30 MHz to 10 GHz. (PCS CDMA Mode: 30 MHz to 20 GHz). A display line was placed at – 13 dBm to show compliance. The high, lowest and a middle channel were tested for out of band measurements.

- Band Edge Requirement : In the 1MHz bands immediately outside and adjacent to the frequency block, a resolution bandwidth of at least 1 percent of the emission bandwidth of the fundamental emission of the transmitter may be employed to measure the out of band Emissions. Limit, -13dBm.

Note : This device was tested under all R.C.s and S.O.s and worst case is reported with RC3/SO2(CDMA) and RC3/SO2(PCS), with 'All Up' power control bits.

FCC CERTIFICATION REPORT				<a href="http://www.hct.co.kr">www.hct.co.kr</a>
Test Report No. HCTR1106FR22	Test Dates: June 15, 2011	EUT Type: USB Dongle	FCC ID: XHGU601	Page 9 of 42

### 3.5 RADIATED SPURIOUS AND HARMONIC EMISSIONS

#### Test Set-up

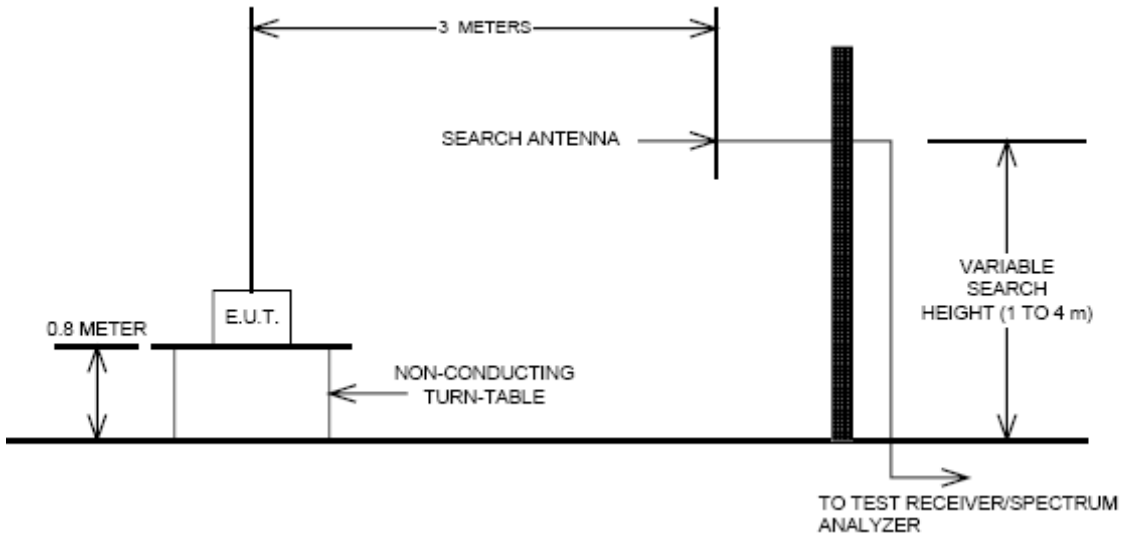

The measurement facilities used for this test have been documented in previous filings with the commission pursuant to section § 2.948. The SAC(Semi-Anechoic Chamber) meets requirements in ANSI C63.4 –2003. A mast capable of lifting the receiving antenna from a height of one to four meters is used together with a rotatable styrofoam platform mounted at three from the antenna mast.

- 1) The unit mounted on a styrofoam turntable 1.5 m × 1.0 m × 0.80 m is 0.8 meter above test site ground level.
- 2) During the emission test, the turntable is rotated and the EUT is manipulated to find the configuration resulting in maximum emission under normal condition of installation and operation.
- 3) The antenna height and polarization are also varied from 1 to 4 meters until the maximum signal is found.
- 4) The spectrum shall be scanned up to the 10<sup>th</sup> harmonic of the fundamental frequency.

#### Test Procedure

The equipment under test is placed on a non-conductive styrofoam resin table 3-meters from the receive antenna. A styrofoam turntable was rotated 360° and the receiving antenna scanned from 1-4m in order to capture the maximum emission. A half wave dipole was substituted in place of the EUT. This dipole antenna was driven by a signal generator and the previously recorded signal was duplicated.

The maximum EIRP was calculated by adding the forward power to the calibrated source plus its appropriate gain value. These steps were carried out with the receiving antenna in both vertical and horizontal polarization. For readings above 1GHz, the above procedure is repeated using horn antennas and the difference between the gain of the horn and an isotropic antenna are taken into consideration.

Note : This device was tested under all R.C.s and S.O.s and worst case is reported with RC3/SO2(CDMA) and RC3/SO2(PCS), with 'All Up' power control bits.

FCC CERTIFICATION REPORT				<a href="http://www.hct.co.kr">www.hct.co.kr</a>
Test Report No. HCTR1106FR22	Test Dates: June 15, 2011	EUT Type: USB Dongle	FCC ID: XHGU601	Page 10 of 42

### 3.6 FREQUENCY STABILITY / VARIATION OF AMBIENT TEMPERATURE

#### Test Set-up

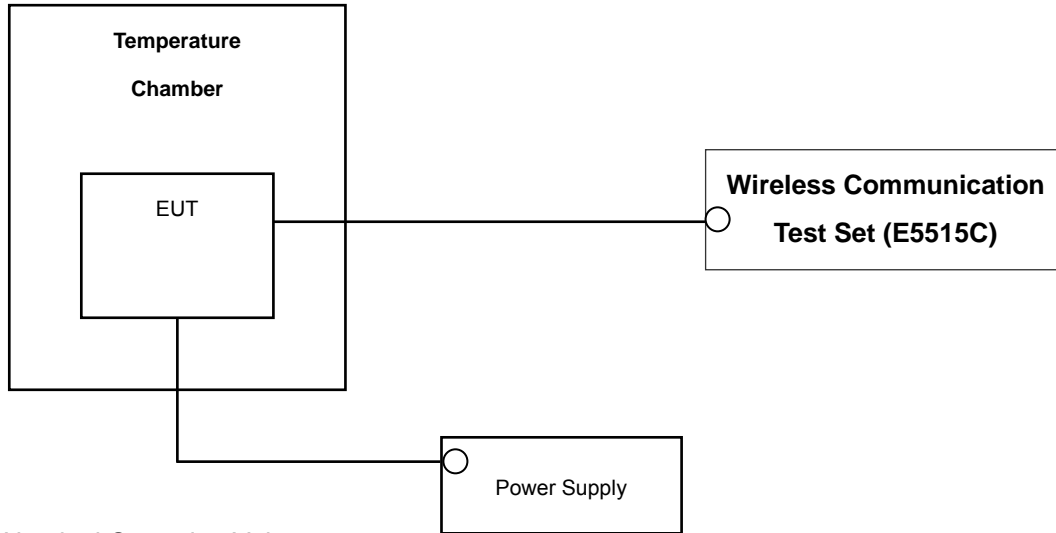

\* Nominal Operating Voltage

#### Test Procedure

The frequency stability of the transmitter is measured by:

- a.) **Temperature:** The temperature is varied from - 30 °C to + 50 °C using an environmental chamber.
- b.) **Primary Supply Voltage:** The primary supply voltage is varied from battery end point to 115 % of the voltage normally at the input to the device or at the power supply terminals if cables are not normally supplied.

Specification — the frequency stability shall be sufficient to ensure that the fundamental emission stays within the authorized frequency block. The frequency stability of the transmitter shall be maintained within  $\pm 0.00025\%$  ( $\pm 2.5$  ppm) of the center frequency.

#### Time Period and Procedure:

The carrier frequency of the transmitter is measured at room temperature (20°C to provide a reference).

1. The equipment is turned on in a “standby” condition for one minute before applying power to the transmitter. Measurement of the carrier frequency of the transmitter is made within one minute after applying power to the transmitter.
2. Frequency measurements are made at 10°C intervals ranging from -30°C to +50°C. A period of at least one half-hour is provided to allow stabilization of the equipment at each temperature level.

**NOTE: The EUT is tested down to the battery endpoint.**

Note : This device was tested under all R.C.s and S.O.s and worst case is reported with RC3/SO2(CDMA) and RC3/SO2(PCS), with 'All Up' power control bits.

FCC CERTIFICATION REPORT				<a href="http://www.hct.co.kr">www.hct.co.kr</a>
Test Report No. HCTR1106FR22	Test Dates: June 15, 2011	EUT Type: USB Dongle	FCC ID: XHGU601	Page 11 of 42

## 4. LIST OF TEST EQUIPMENT

Manufacture	Model/ Equipment	Serial Number	Calibration Interval	Calibration Due
R&S	N9020A	MY51110020	Annual	04/16/2012
Agilent	E4416A/ Power Meter	GB41291412	Annual	01/04/2012
Agilent	E9327A/ Power Sensor	MY4442009	Annual	05/02/2012
Agilent	8960 (E5515C)/ Base Station	GB44400269	Annual	02/10/2012
MITEQ	AMF-6D-001180-35-20P/AMP	990893	Annual	05/02/2012
Wainwright	WHK1.2/15G-10EF/H.P.F	2	Annual	05/02/2012
Wainwright	WHK3.3/18G-10EF/H.P.F	1	Annual	05/02/2012
Agilent	775D/ Dual Directional Coupler	12922	Annual	12/29/2011
Agilent	11636B/ Power Divider	11377	Annual	12/29/2011
Digital	EP-3010/ Power Supply	3110117	Annual	01/04/2012
Schwarzbeck	UHAP/ Dipole Antenna	949	Biennial	03/18/2012
Schwarzbeck	UHAP/ Dipole Antenna	950	Biennial	03/18/2012
Korea Engineering	KR-1005L / Chamber	KRAB07063-2CH	Annual	12/28/2011
Schwarzbeck	BBHA 9120D/ Horn Antenna	296	Biennial	09/23/2011
Schwarzbeck	BBHA 9120D/ Horn Antenna	147	Biennial	04/13/2012
Agilent	E4440A/Spectrum Analyzer	US45303008	Annual	05/02/2012

## 5. SUMMARY OF TEST RESULTS

FCC Part Section(s)	Test Description	Test Limit	Test Condition	Test Result
2.1049, 22.917(a), 24.238(a)	Occupied Bandwidth	N/A	CONDUCTED	PASS
2.1051, 22.917(a), 24.238(a)	Band Edge / Spurious and Harmonic Emissions at Antenna Terminal.	< 43 + 10log <sub>10</sub> (P[Watts]) at Band Edge and for all out-of-band emissions		PASS
2.1046	Conducted Output Power	N/A		PASS
24.232(d)	Peak- to- Average Ratio	< 13 dB		PASS
2.1055, 22.355, 24.235	Frequency stability / variation of ambient temperature	< 2.5 ppm		PASS
22.913(a)(2) 24.232(c)	Effective Radiated Power	< 7 Watts max. ERP	RADIATED	PASS
	Equivalent Isotropic Radiated Power	< 2 Watts max. EIRP		PASS
2.1053, 22.917(a), 24.238(a)	Radiated Spurious and Harmonic Emissions	< 43 + 10log <sub>10</sub> (P[Watts]) for all out-of band emissions		PASS

## 6. SAMPLE CALCULATION

### A. ERP Sample Calculation

Mode	Ch./ Freq.		Measured Level(dBm)	Substitute LEVEL(dBm)	Ant. Gain	C.L	Pol.	ERP	
	channel	Freq.(MHz)						W	dBm
CDMA	384	836.52	-10.96	24.81	2.50	1.19	H	0.41	26.12

### ERP = SubstituteLEVEL(dBm) + Ant. Gain – CL(Cable Loss)

- 1) The EUT mounted on a wooden tripod is 0.8 meter above test site ground level.
- 2) During the test , the turn table is rotated and the antenna height is also varied from 1 to 4 meters until the maximum signal is found.
- 3) Record the field strength meter's level.
- 4) Replace the EUT with dipole/Horn antenna that is connected to a calibrated signal generator.
- 5) Increase the signal generator output till the field strength meter's level is equal to the item (3).
- 6) The signal generator output level with Ant. Gain and cable loss are the rating of effective radiated power (**ERP**).

### B. Emission Designator

#### CDMA Emission Designator

**Emission Designator = 1M27F9W**

CDMA BW = 1.27 MHz (Measured at the 99% power bandwidth)

F = Frequency Modulation

9 = Composite Digital Info

W = Combination (Audio/Data)

## 7. TEST DATA

### 7.1 CONDUCTED OUTPUT POWER

A base station simulator was used to establish communication with The EUT. The base station simulator parameters were set to produce the maximum power from the EUT. This device was tested under all configurations and the highest power is reported. Conducted Output Powers of EUT are reported below.

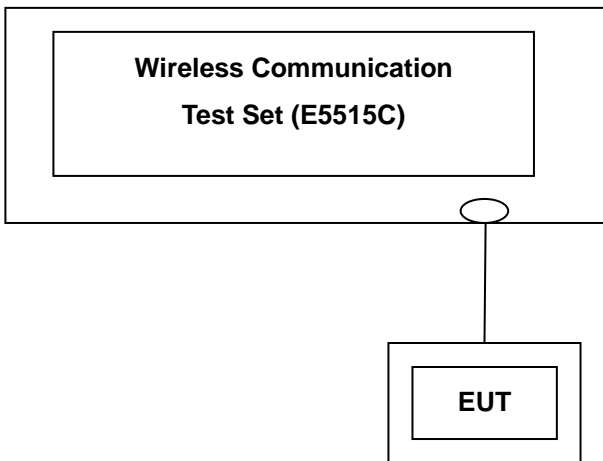

Band	Channel	SO2	SO2	SO55	SO55	TDSO	1xEvD	1xEvD	1xEvD	1xEvD
		RC1/1 (dBm)	RC3/3 (dBm)	RC1/1 (dBm)	RC3/3 (dBm)	SO32 RC3/3 (dBm)	Rev.O (FTAP)	Rev.O (RTAP)	Rev.1 (FTAP)	Rev.1 (RTAP)
CDMA	1013	23.74	23.82	23.74	23.51	23.80	23.74	24.02	23.42	23.44
	384	23.54	23.68	23.54	23.41	23.65	23.57	23.74	23.23	23.24
	777	23.68	23.86	23.79	23.46	23.77	23.72	24.03	23.26	23.29
PCS	25	23.93	24.07	23.86	23.72	23.96	24.08	24.18	23.48	23.44
	600	23.92	24.15	23.83	23.75	24.02	24.00	24.12	23.31	23.29
	1175	23.50	23.74	23.41	23.63	23.66	23.75	23.80	23.25	23.37

(Maximum Conducted Output Powers)

Note : Detecting mode is average.

### 7.2 PEAK-TO-AVERAGE RATIO

- Plots of the EUT's Peak- to- Average Ratio are shown Page 28.

### 7.3 OCCUPIED BANDWIDTH

Band	Channel	Frequency(MHz)	Data (MHz)
CDMA	1013	824.70	1.2824
	384	836.52	1.2795
	777	848.31	1.2807
CDMA EVDO	1013	824.70	1.2698
PCS	25	1851.25	1.2816
	600	1880.00	1.2812
	1175	1908.75	1.2795
PCS EVDO	25	1851.25	1.2822

- Plots of the EUT's Occupied Bandwidth are shown Page 24 ~ 27.

### 7.4 CONDUCTED SPURIOUS EMISSIONS

Band	Channel	Frequency of Maximum Harmonic (GHz)	Maximum Data (dBm)
CDMA	1013	1.6480	-38.41
	384	8.2125	-40.12
	777	6.8750	-40.83
PCS	25	3.7020	-18.79
	600	3.7620	-19.46
	1175	3.8210	-18.58

- Plots of the EUT's Conducted Spurious Emissions are shown Page 37 ~ 42.

#### 7.4.1 Band Edge

- Plots of the EUT's Band Edge are shown Page 29 ~ 36.



## 7.5 EFFECTIVE RADIATED POWER OUTPUT – Normal

### (CDMA Mode)

Mode	Ch./ Freq.		Measured Level(dBm)	Substitute LEVEL (dBm)	Ant. Gain	C.L	Pol.	ERP	
	channel	Freq.(MHz)						W	dBm
CDMA	1013	824.70	-11.92	35.85	-10.25	1.17	H	0.28	24.43
	384	836.52	-11.68	36.95	-10.36	1.19	H	0.35	25.40
	777	848.31	-12.79	36.68	-10.47	1.20	H	0.32	25.01
EVDO	1013	824.70	-11.50	36.27	-10.25	1.17	H	0.31	24.85
	384	836.52	-11.32	37.31	-10.36	1.19	H	0.38	25.76
	777	848.31	-12.48	36.99	-10.47	1.20	H	0.34	25.32

Note: Standard batteries are the only options for this phone

#### NOTES:

#### Effective Radiated Power Output Measurements by Substitution Method

according to ANSI/TIA/EIA-603-C-2004, Aug. 17, 2004:

The EUT was placed on a non-conductive styrofoam resin table 3-meters from the receive antenna. The receive antenna height and turntable rotation was adjusted for the highest reading on the receive spectrum analyzer. For CDMA signals, a peak detector is used, with RBW = VBW = 3 MHz. For WCDMA signals, a peak detector is used, with RBW = VBW = 5MHz. For AMPS, GSM, and NADC TDMA signals, a peak detector is used, with RBW = VBW = 1 MHz. A half-wave dipole was substituted in place of the EUT. This dipole antenna was driven by a signal generator and the level of the signal generator was adjusted to obtain the same receive spectrum analyzer reading. The conducted power at the terminals of the dipole is measured. The ERP is recorded.

This device was tested under all configurations and the highest power is reported. Also, we have done x, y, z planes in EUT and horizontal and vertical polarization in detecting antenna. The worst case of the EUT is in z plane in CDMA mode. Also worst case of detecting Antenna is in horizontal polarization in CDMA mode.

The EVDO mode testing were performed using RTAP on Rev.0 because RTAP on Rev.0 is highest power in EVDO mode.

## 7.6 EQUIVALENT ISOTROPIC RADIATED POWER

### (PCS CDMA Mode)

Mode	Ch./ Freq.		Measured	Substitute	Ant. Gain	C.L	Pol.	EIRP	
	channel	Freq.(MHz)	Level(dBm)	LEVEL (dBm)				W	dBm
PCS	25	1,851.25	-13.57	20.14	10.40	2.83	V	0.59	27.70
	600	1,880.00	-13.92	19.96	10.43	2.81	V	0.57	27.58
	1175	1,908.75	-13.81	20.18	10.47	2.86	V	0.60	27.79
EVDO	25	1,851.25	-13.35	20.36	10.40	2.83	V	0.62	27.92
	600	1,880.00	-13.41	20.47	10.43	2.81	V	0.64	28.09
	1175	1,908.75	-13.06	20.93	10.47	2.86	V	0.71	28.54

Note: Standard batteries are the only options for this phone

#### NOTES:

Equivalent Isotropic Radiated Power Measurements by Substitution Method  
according to ANSI/TIA/EIA-603-C-2004, Aug. 17, 2004:

The EUT was placed on a non-conductive styrofoam resin table 3-meters from the receive antenna. The receive antenna height and turntable rotation was adjusted for the highest reading on the receive spectrum analyzer. For CDMA signals, a peak detector is used, with RBW = VBW = 3 MHz. For WCDMA signals, a peak detector is used, with RBW = VBW = 5MHz. For AMPS, GSM, and NADC TDMA signals, a peak detector is used, with RBW = VBW = 1 MHz. A Horn antenna was substituted in place of the EUT. This Horn antenna was driven by a signal generator and the level of the signal generator was adjusted to obtain the same receive spectrum analyzer reading. The conducted power at the terminals of the Horn antenna is measured. The difference between the gain of the horn and an isotropic antenna is taken into consideration and the EIRP is recorded.

This device was tested under all configurations and the highest power is reported. Also, we have done x, y, z planes in EUT and horizontal and vertical polarization in detecting antenna. And worst case of the EUT is in y plane in PCS mode. Also worst case of detecting Antenna is in vertical in PCS mode.

The EVDO mode testing were performed using RTAP on Rev.0 because RTAP on Rev.0 is highest power in EVDO mode.

## 7.7 RADIATED SPURIOUS EMISSIONS

### 7.7.1 RADIATED SPURIOUS EMISSIONS(CDMA Mode)

- MEASURED OUTPUT POWER: 25.76 dBm = 0.377 W
- MODULATION SIGNAL: CDMA EVDO
- DISTANCE: 3 meters
- LIMIT: - (43 + 10 log<sub>10</sub> (W)) = - 38.76 dBc

Ch.	Freq.(MHz)	<u>Measured Level</u> [dBm]	Ant. Gain	<u>Substitute</u> <u>Level</u> [dBm]	C.L	Pol.	ERP (dBm)	dBc
1013	1,649.40	-47.90	9.66	-56.51	2.63	V	-49.48	-74.88
	2,474.10	-35.45	10.79	-40.57	3.55	H	-33.33	-58.73
	3,298.80	-	-	-	-	-	-	-
384	1,673.04	-49.62	9.77	-58.64	2.67	H	-51.54	-76.94
	2,509.56	-36.24	10.82	-41.81	3.61	H	-34.60	-60.00
	3,346.08	-	-	-	-	-	-	-
777	1,696.62	-45.62	9.94	-54.70	2.61	H	-47.37	-72.77
	2,544.93	-34.20	10.83	-39.29	3.57	H	-32.03	-57.43
	3,393.24	-	-	-	-	-	-	-

- NOTES:**
1. Radiated Spurious Emission Measurements at 3 meters by Substitution Method according to ANSI/TIA/EIA-603-C-2004, Aug. 17, 2004:
  2. The magnitude of spurious emissions attenuated more than 20dB below the limit above 5<sup>th</sup> Harmonic for all channel.
  3. we have done x, y, z planes in EUT and horizontal and vertical polarization in detecting antenna.

### 7.7.2 RADIATED SPURIOUS EMISSIONS(PCS CDMA Mode)

- MEASURED OUTPUT POWER: 28.54 dBm = 0.714 W
- MODULATION SIGNAL: PCS CDMA EVDO
- DISTANCE: 3 meters
- LIMIT: - (43 + 10 log<sub>10</sub> (W)) = - 41.54 dBc

Ch.	Freq.(MHz)	<u>Measured Level</u> [dBm]	Ant. Gain	<u>Substitute</u> <u>Level</u> [dBm]	C.L	Pol.	EIRP (dBm)	dBc
25	3,702.50	-42.40	12.36	-46.05	4.87	V	-38.56	-66.35
	5,553.75	-53.06	12.61	-49.72	6.66	V	-43.77	-71.56
	7,405.00	-52.00	10.96	-40.63	6.55	V	-36.22	-64.01
600	3,760.00	-44.41	12.40	-47.54	4.88	V	-40.02	-67.81
	5,640.00	-51.54	12.66	-48.07	6.64	V	-42.05	-69.84
	7,520.00	-	-	-	-	-	-	-
1175	3,817.50	-41.34	12.45	-44.75	5.02	H	-37.32	-65.11
	5,726.25	-46.97	12.71	-43.89	6.54	H	-37.72	-65.51
	7,635.00	-	-	-	-	-	-	-

- NOTES:**
1. Radiated Spurious Emission Measurements at 3 meters by Substitution Method according to ANSI/TIA/EIA-603-C-2004, Aug. 17, 2004:
  2. The magnitude of spurious emissions attenuated more than 20dB below the limit above 5<sup>th</sup> Harmonic for all channel.
  3. we have done x, y, z planes in EUT and horizontal and vertical polarization in detecting antenna.

## 7.8 FREQUENCY STABILITY / VARIATION OF AMBIENT TEMPERATURE

### 7.8.1 FREQUENCY STABILITY (CDMA)

OPERATING FREQUENCY: 836,520,000 Hz  
 CHANNEL: 384  
 REFERENCE VOLTAGE: 3.7 VDC  
 DEVIATION LIMIT: ± 0.000 25 % or 2.5 ppm

Voltage (%)	Power (VDC)	Temp. (°C)	Frequency (Hz)	Frequency Error (Hz)	Deviation (%)	ppm
100%	3.700	+20(Ref)	836 520 006	0	0.000 000	0.000
100%		-30	836 519 997	-3.30	0.000 000	-0.004
100%		-20	836 519 994	-5.78	-0.000 001	-0.007
100%		-10	836 519 995	-4.83	-0.000 001	-0.006
100%		0	836 520 004	3.58	0.000 000	0.004
100%		+10	836 520 004	4.02	0.000 000	0.005
100%		+30	836 520 006	6.04	0.000 001	0.007
100%		+40	836 520 021	21.02	0.000 003	0.025
100%		+50	836 520 011	11.31	0.000 001	0.014
115%	4.255	+20	836 520 005	4.56	0.000 001	0.005
Batt. Endpoint	3.400	+20	836 520 004	4.21	0.000 001	0.005

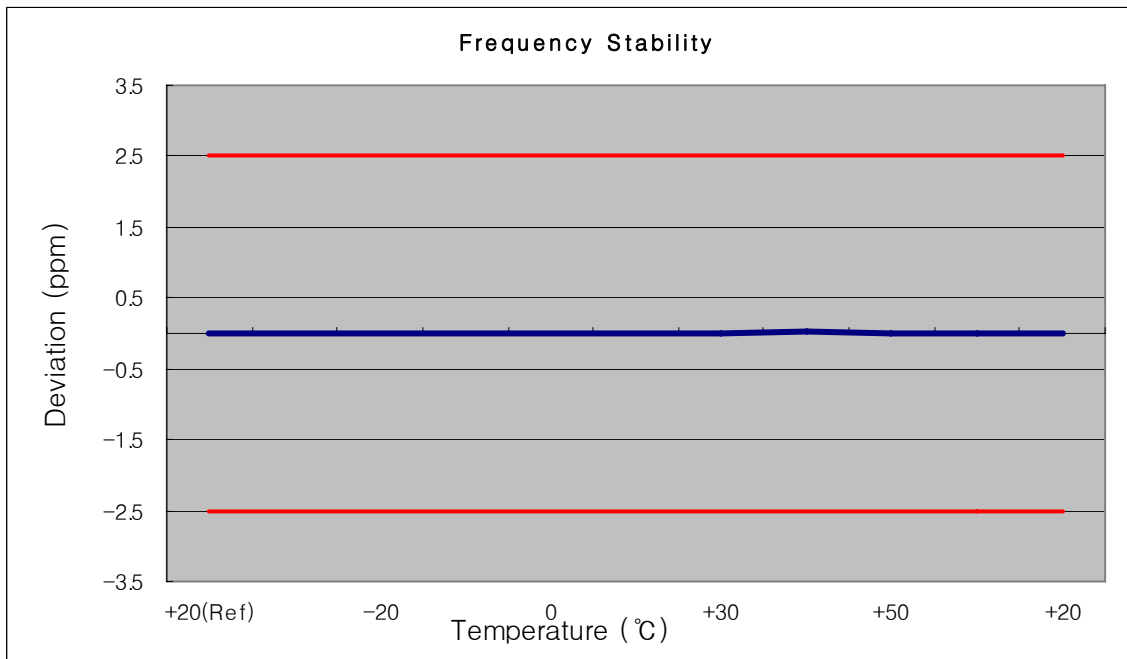

### 7.8.2 FREQUENCY STABILITY (PCS CDMA)

OPERATING FREQUENCY: 1880,000,000 Hz  
 CHANNEL: 600  
 REFERENCE VOLTAGE: 3.7 VDC  
 DEVIATION LIM IT: ± 0.000 25 % or 2.5 ppm

Voltage (%)	Power (VDC)	Temp. (°C)	Frequency (Hz)	Frequency Error (Hz)	Deviation (%)	ppm
100%	3.700	+20(Ref)	1879 999 996	0	0.000 000	0.000
100%		-30	1879 999 993	-6.97	0.000 000	-0.004
100%		-20	1879 999 995	-5.08	0.000 000	-0.003
100%		-10	1879 999 995	-4.94	0.000 000	-0.003
100%		0	1879 999 995	-4.61	0.000 000	-0.002
100%		+10	1879 999 993	-7.43	0.000 000	-0.004
100%		+30	1880 000 027	26.73	0.000 001	0.014
100%		+40	1880 000 003	3.24	0.000 000	0.002
100%		+50	1880 000 013	13.37	0.000 001	0.007
115%		4.255	+20	1880 000 006	5.61	0.000 000
Batt. Endpoint	3.400	+20	1879 999 997	-3.17	0.000 000	-0.002

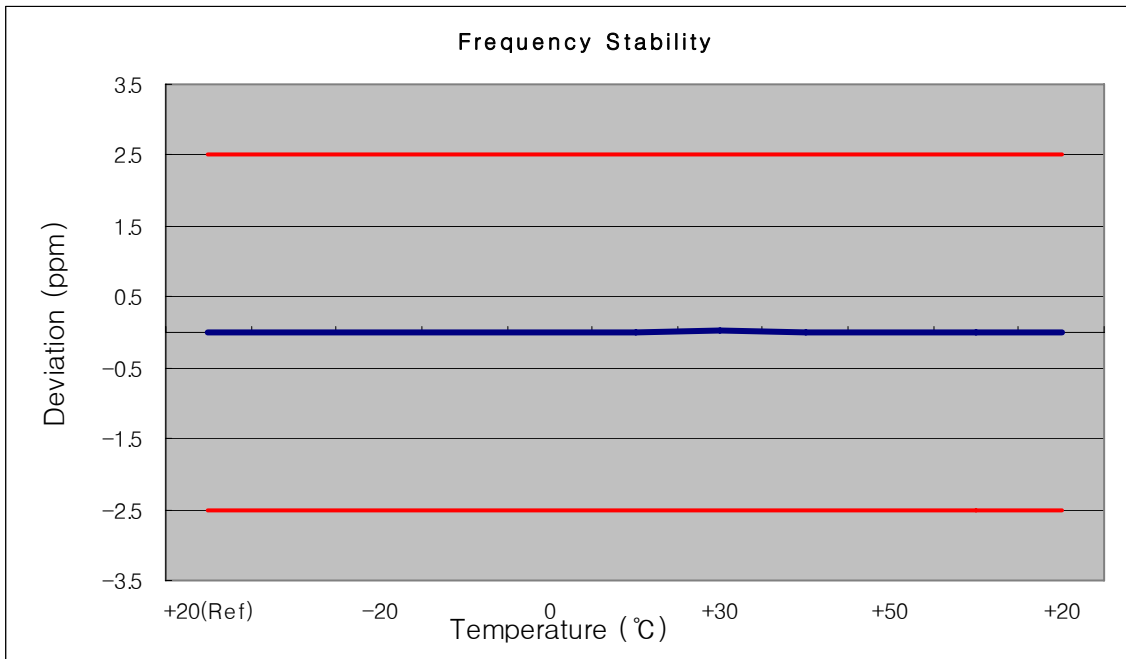

## 8. TEST PLOTS

FCC CERTIFICATION REPORT				<a href="http://www.hct.co.kr">www.hct.co.kr</a>
Test Report No. HCTR1106FR22	Test Dates: June 15, 2011	EUT Type: USB Dongle	FCC ID: XHGU601	Page 23 of 42

■ CDMA MODE (1013 CH.) Occupied Bandwidth

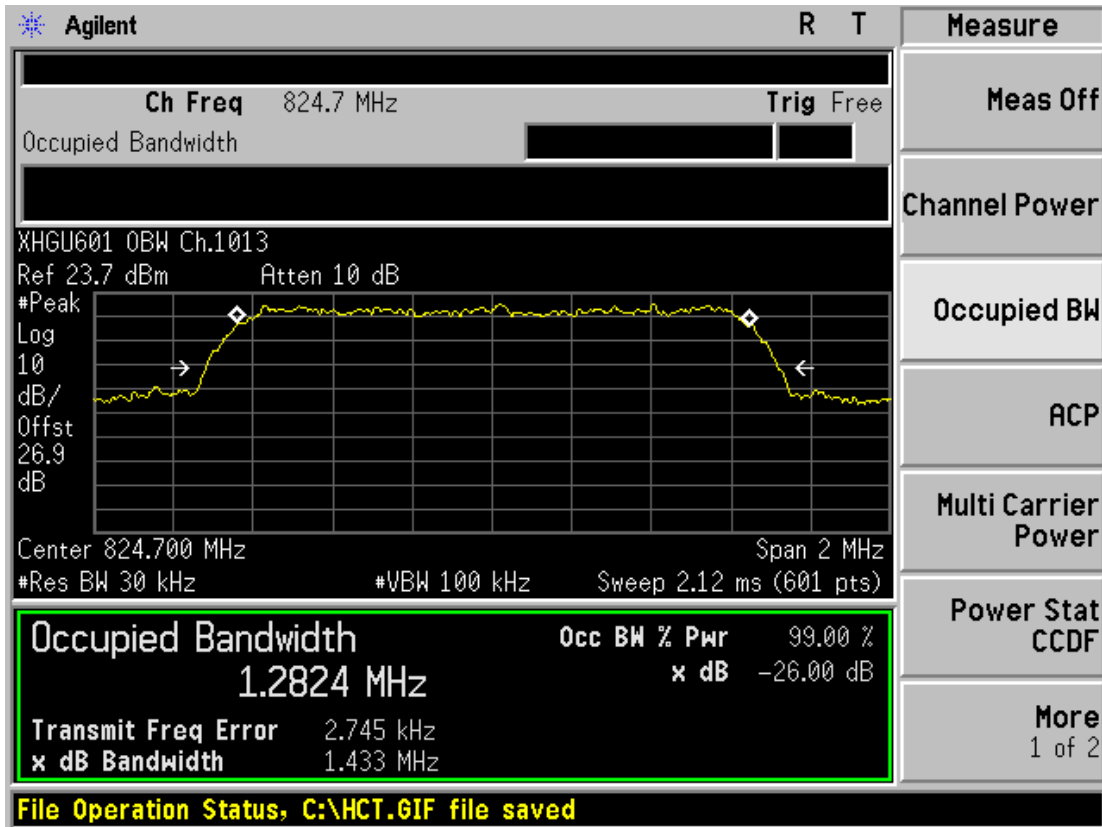

■ CDMA MODE (384 CH.) Occupied Bandwidth

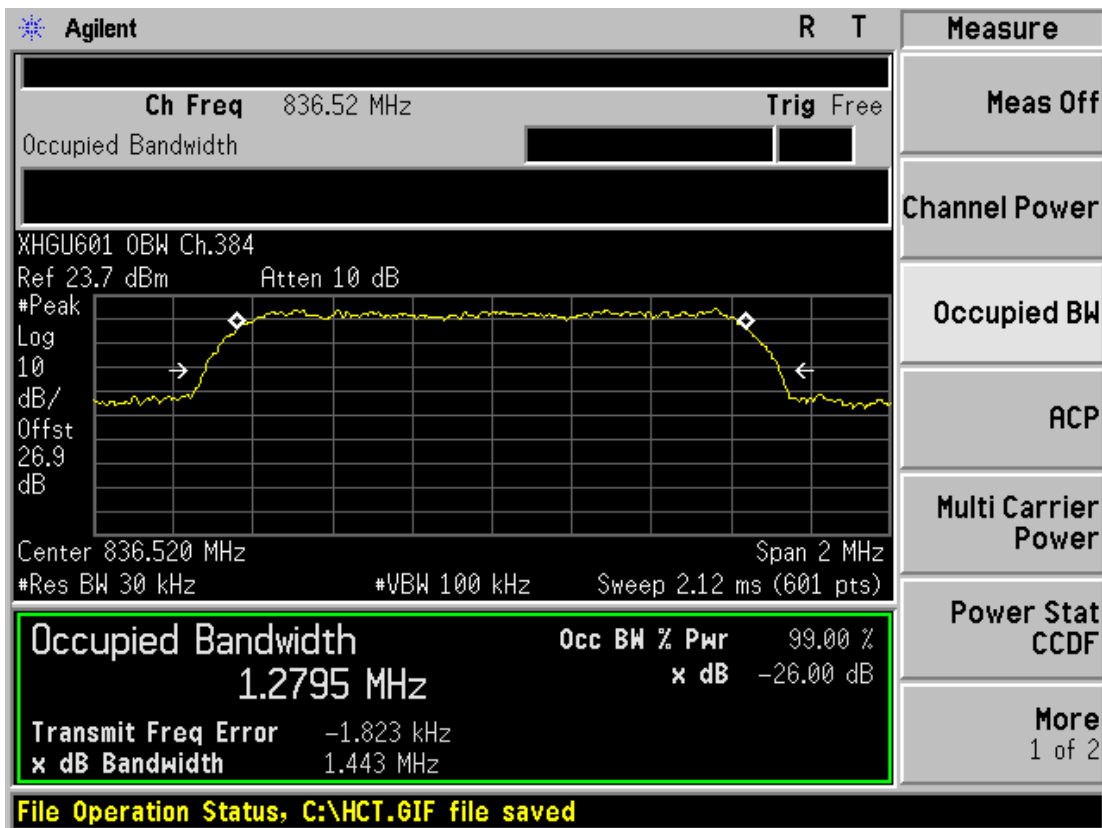



■ CDMA MODE (777 CH.) Occupied Bandwidth

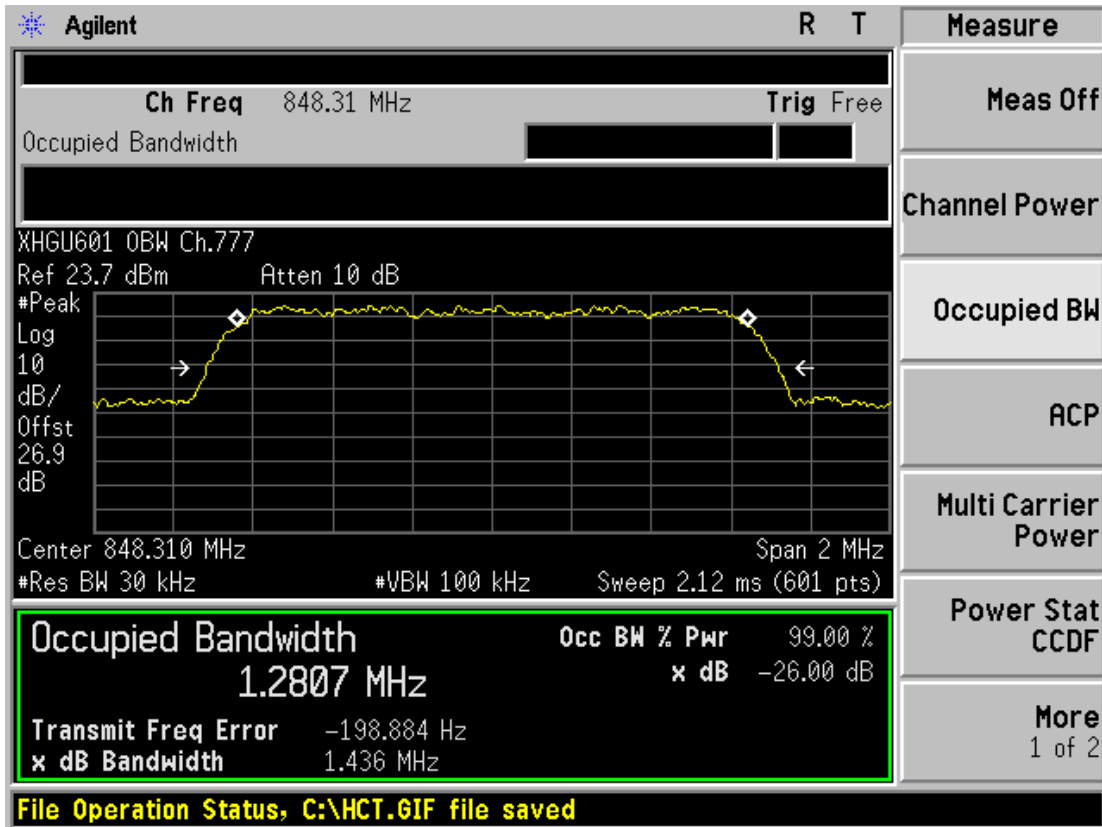

■ CDMA EVDO MODE (1013 CH.) Occupied Bandwidth

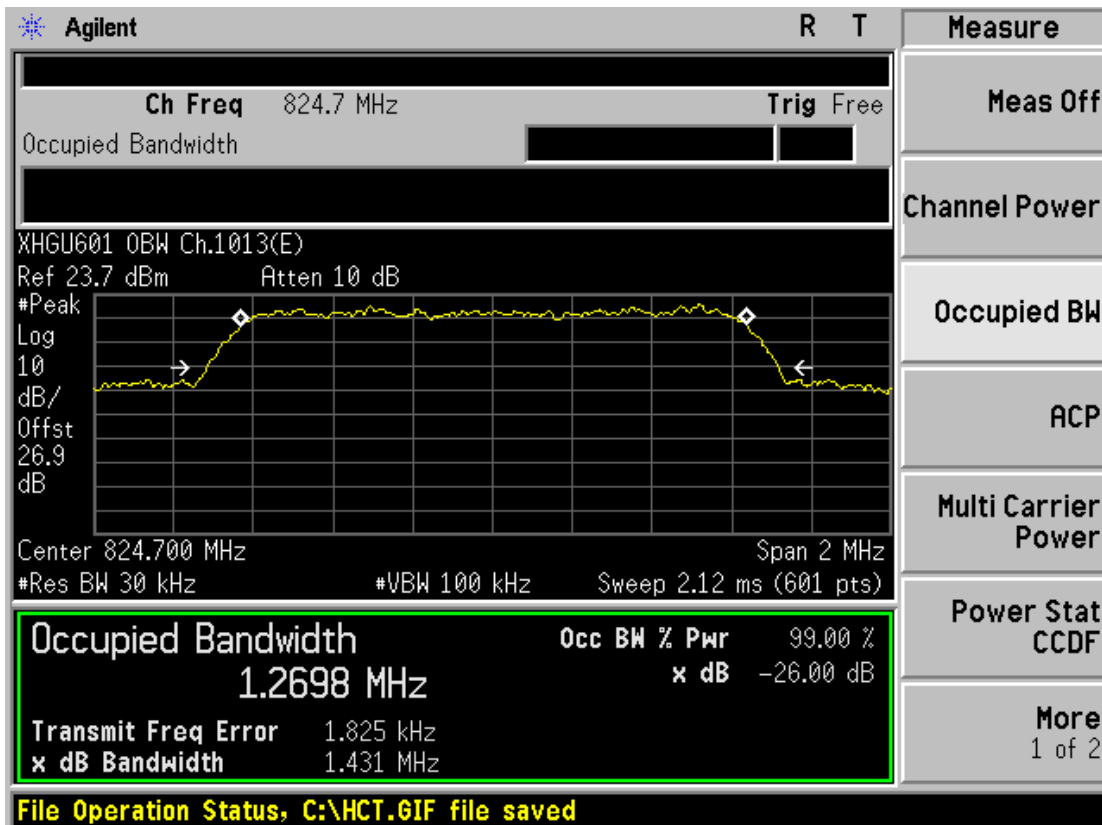

■ PCS CDMA MODE (25 CH.) Occupied Bandwidth

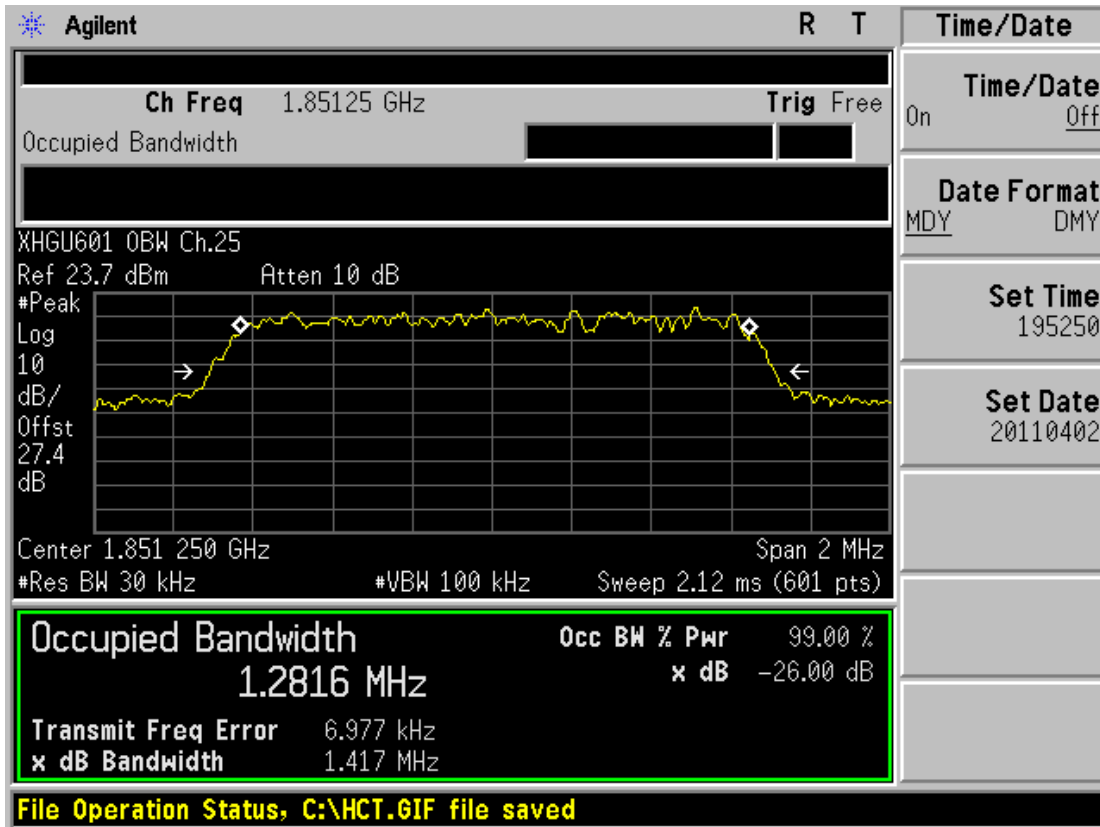

■ PCS CDMA MODE (600 CH.) Occupied Bandwidth

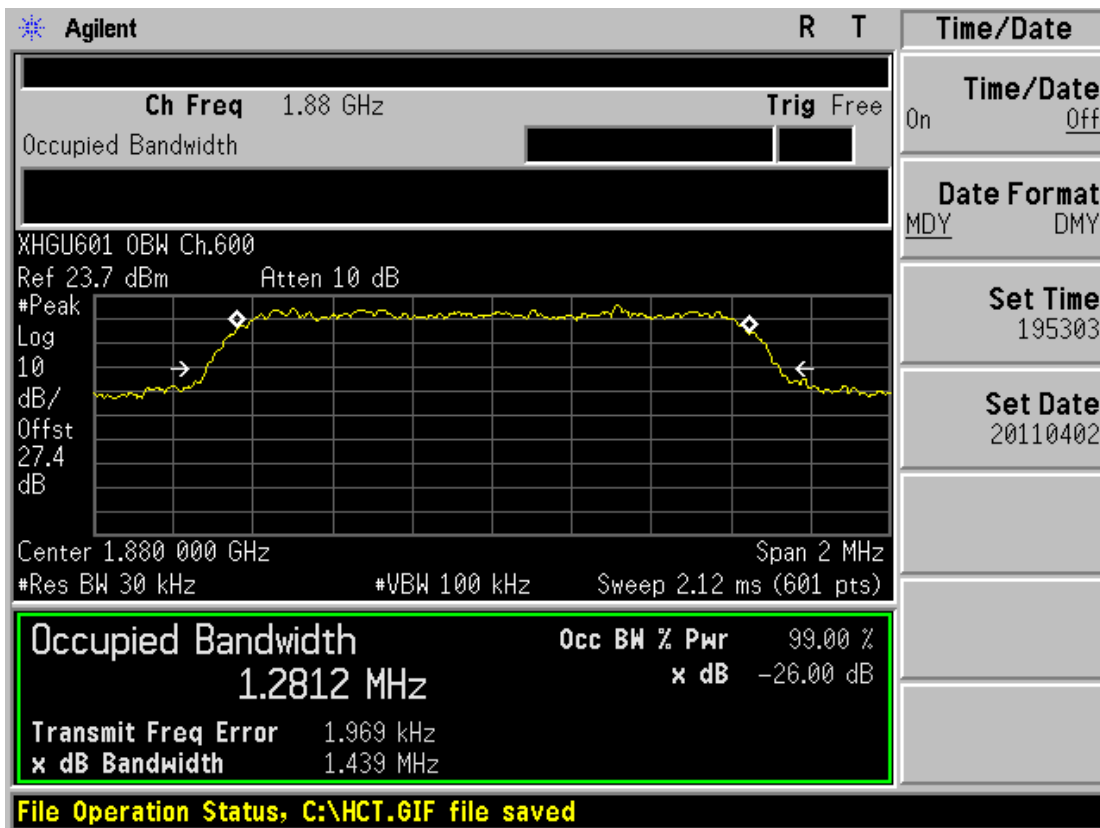

■ PCS CDMA MODE (1175 CH.) Occupied Bandwidth

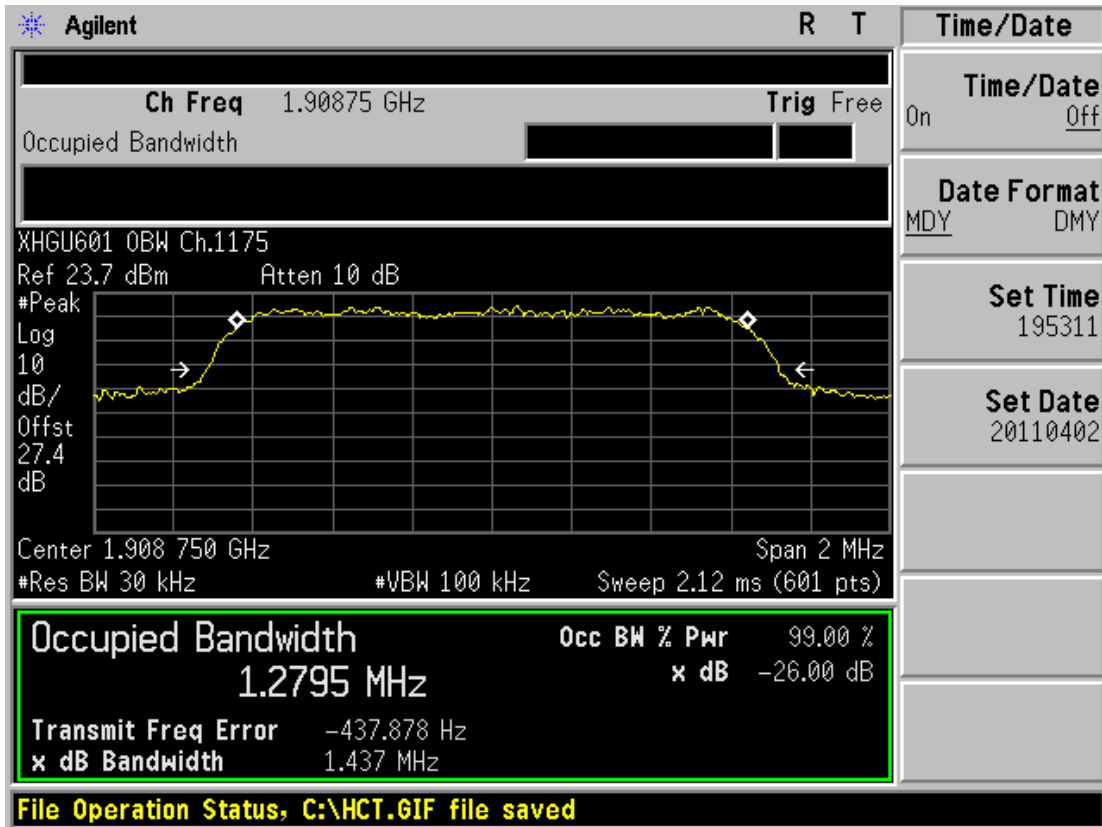

■ PCS CDMA EVDO MODE (25 CH.) Occupied Bandwidth

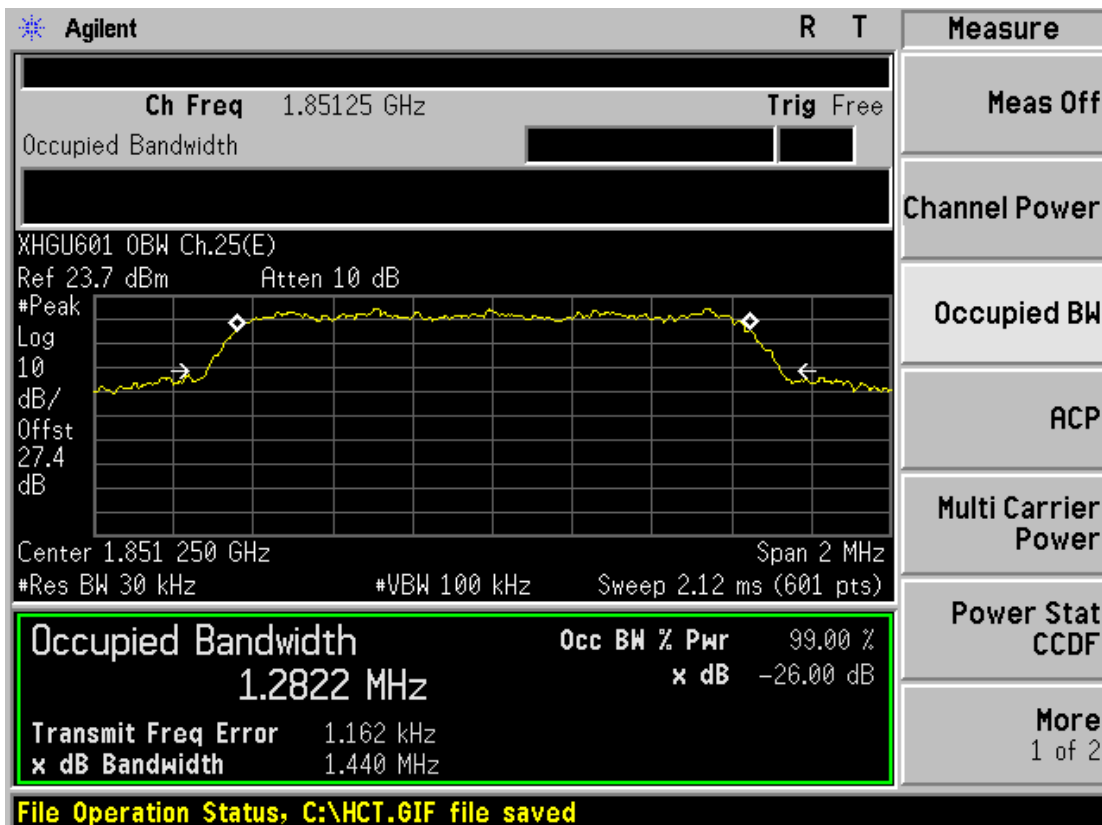

■ PCS CDMA MODE (600 CH.) Peak-to-Average Ratio

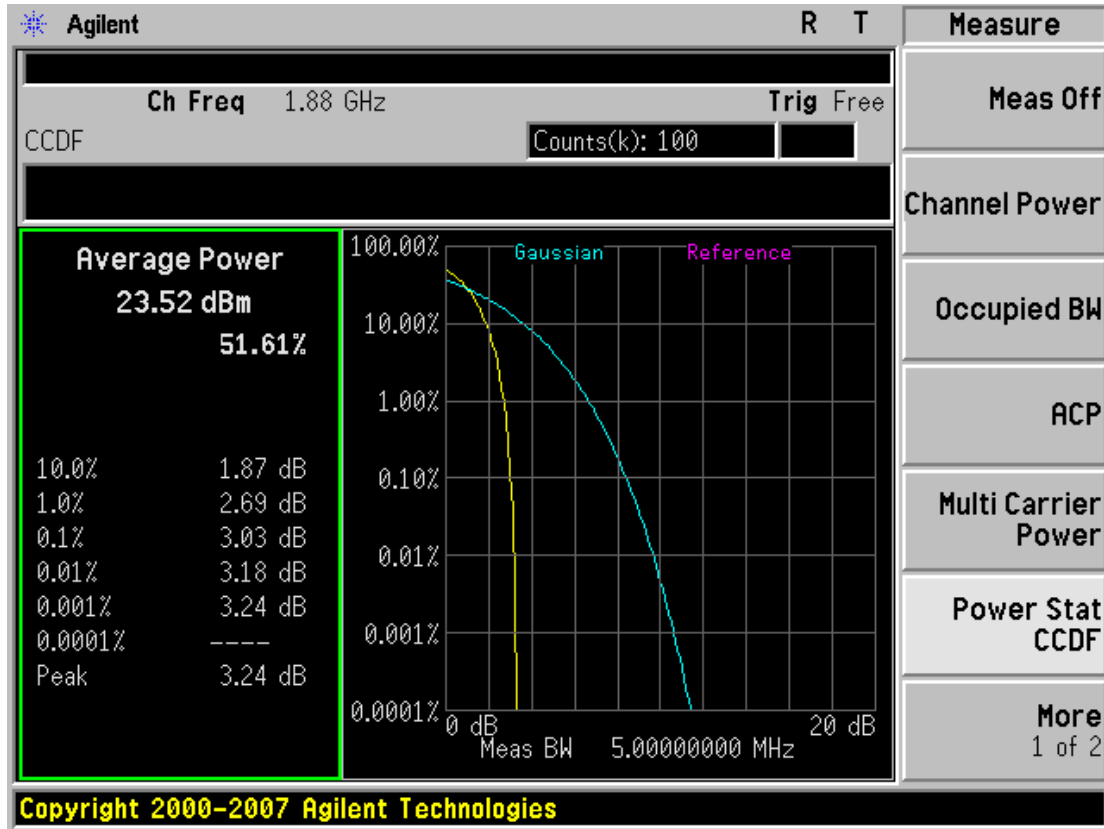

■ PCS CDMA EVDO MODE (600 CH.) Peak-to-Average Ratio

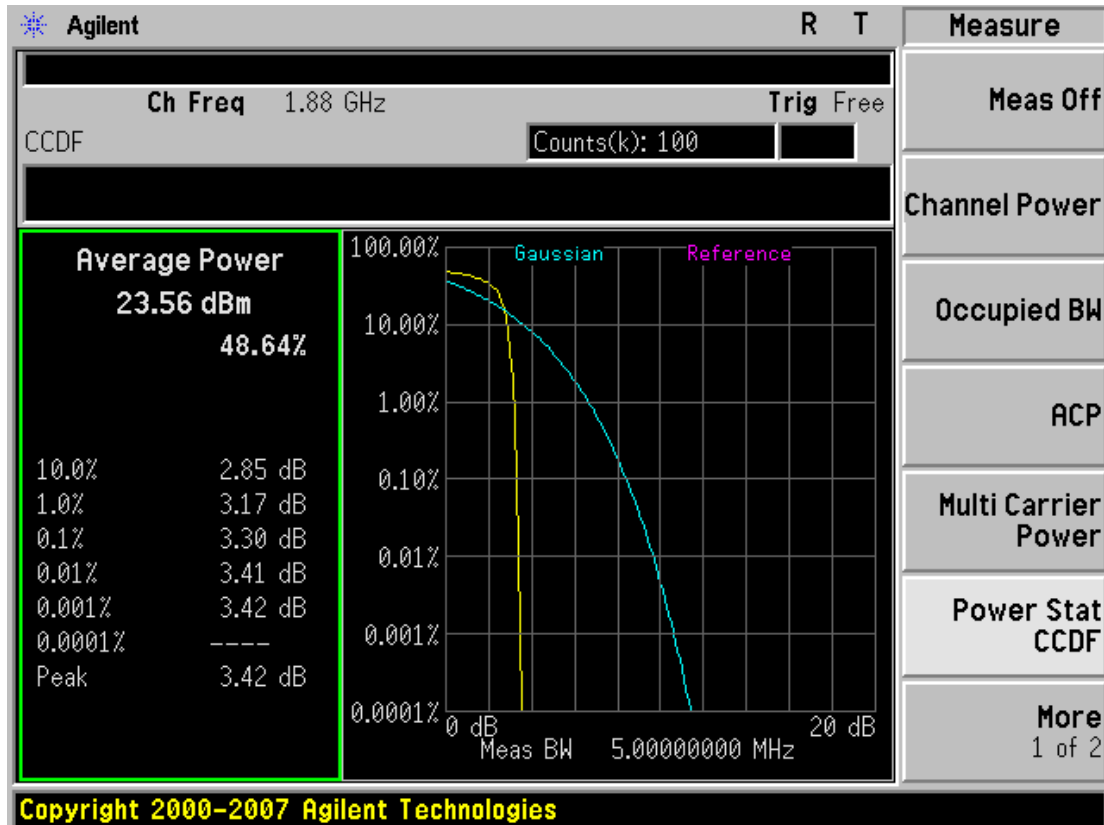

■ CDMA MODE (1013 CH.) Block Edge

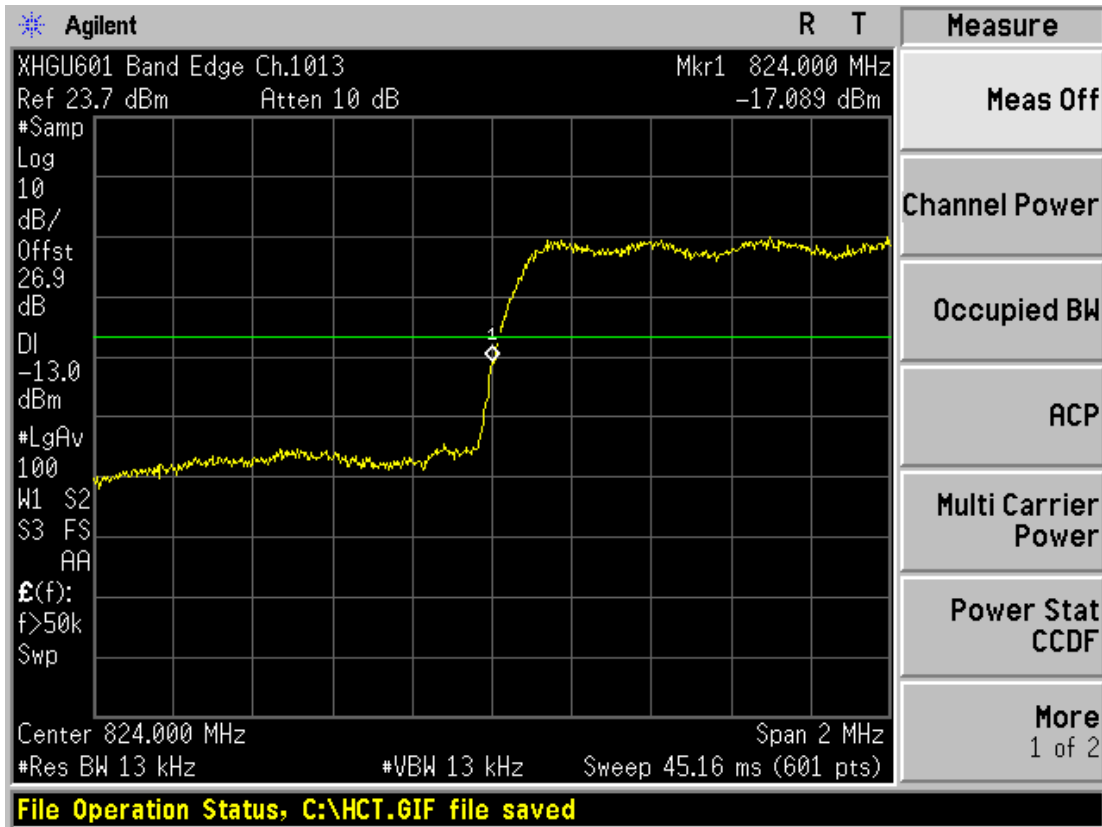

■ CDMA MODE (777 CH.) Block Edge

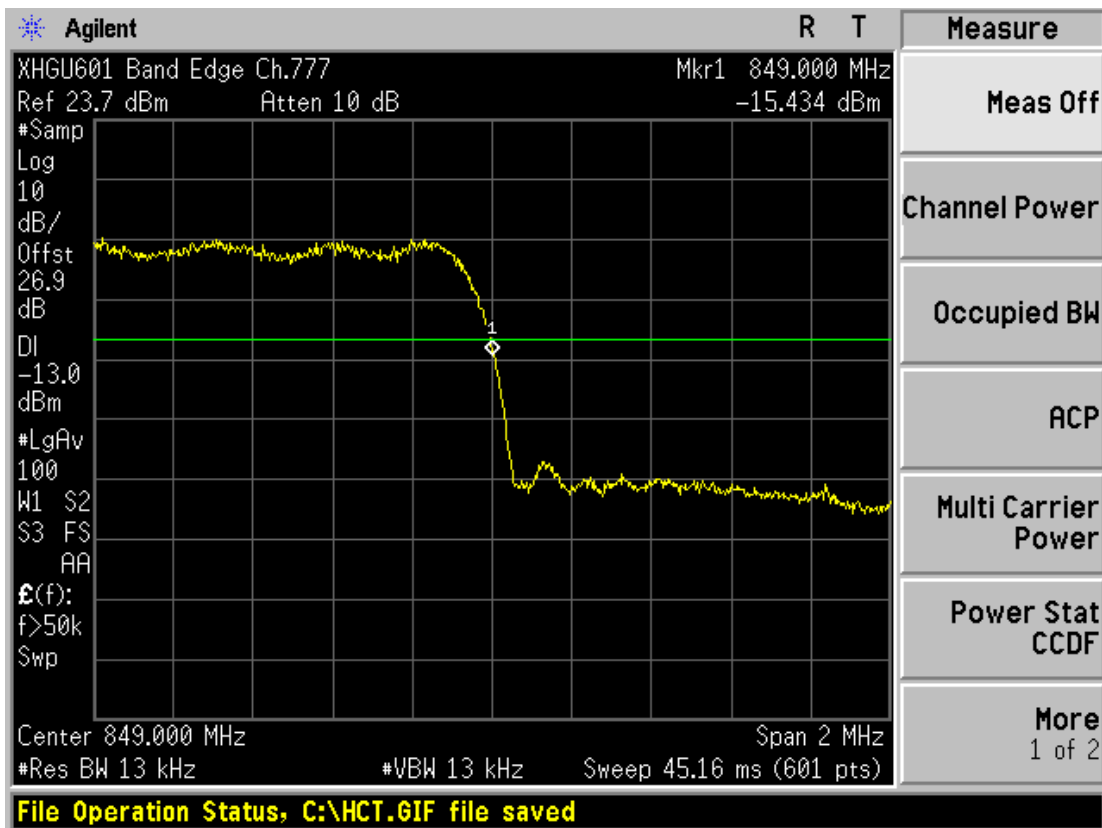

■ CDMA EVDO MODE (1013 CH.) Block Edge

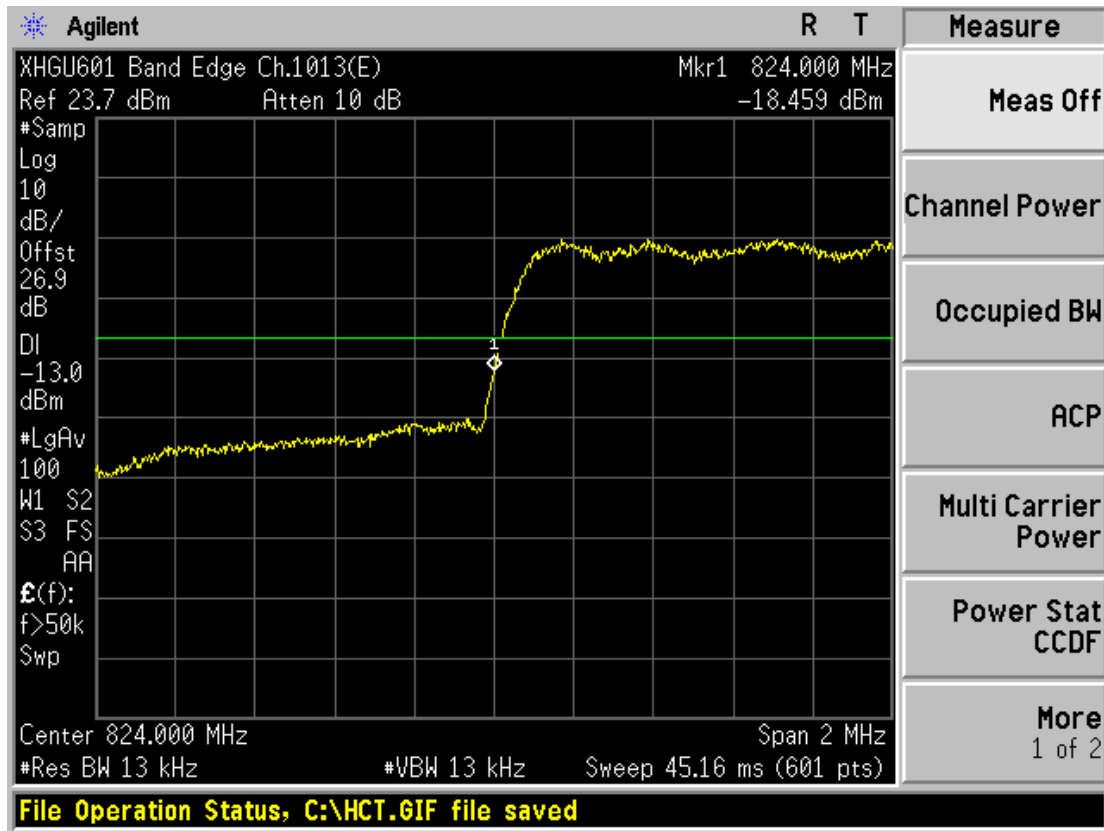

■ CDMA EVDO MODE (777 CH.) Block Edge

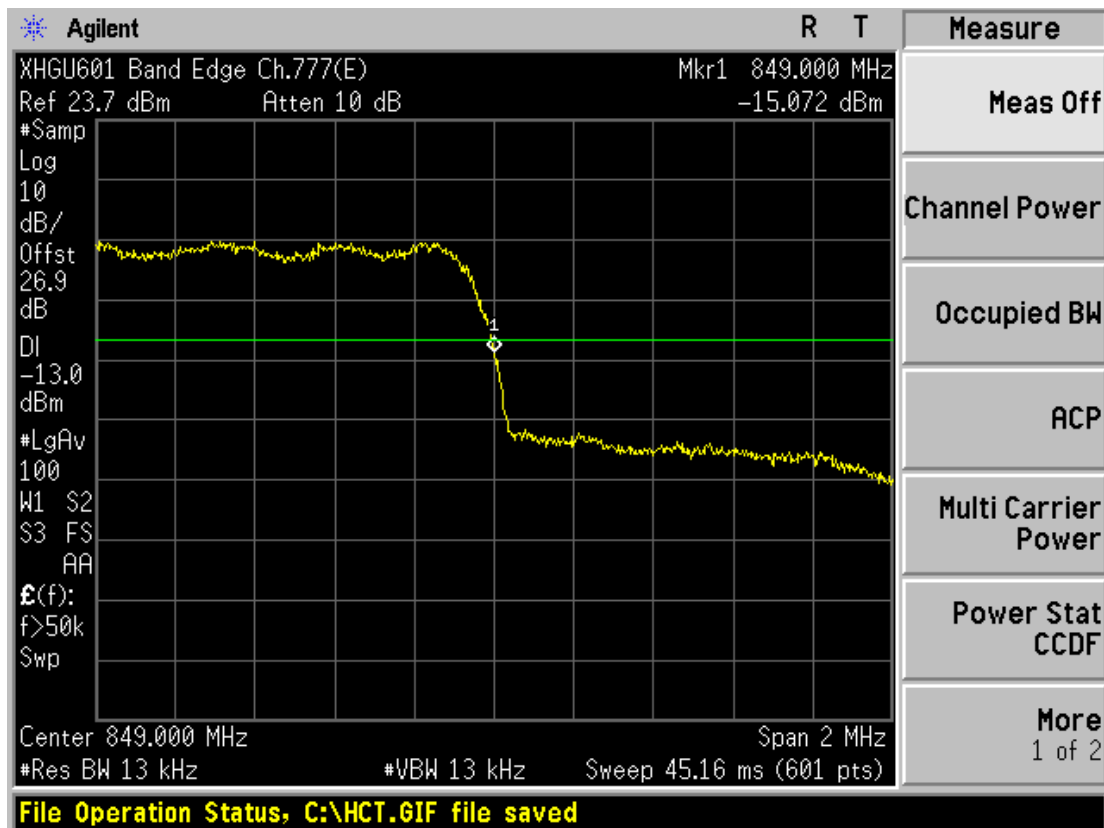

■ CDMA MODE (1013 CH.) 4 MHz Span

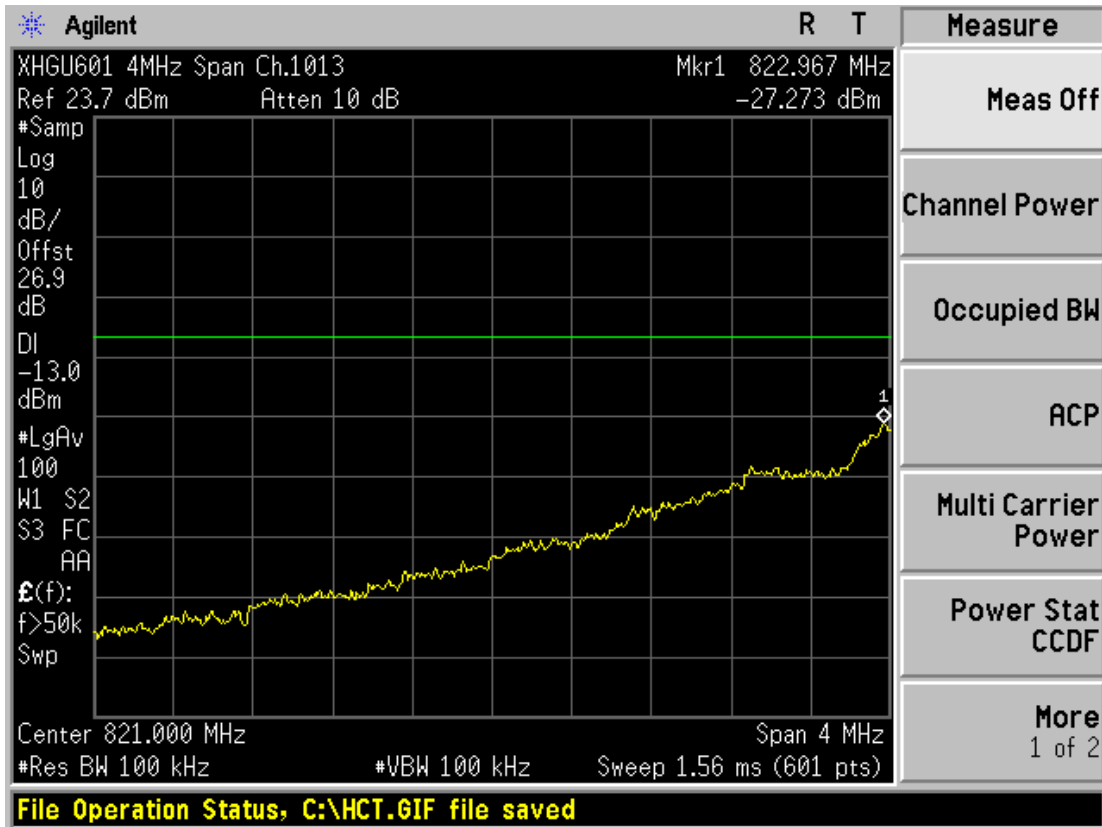

■ CDMA MODE (777 CH.) 4 MHz Span

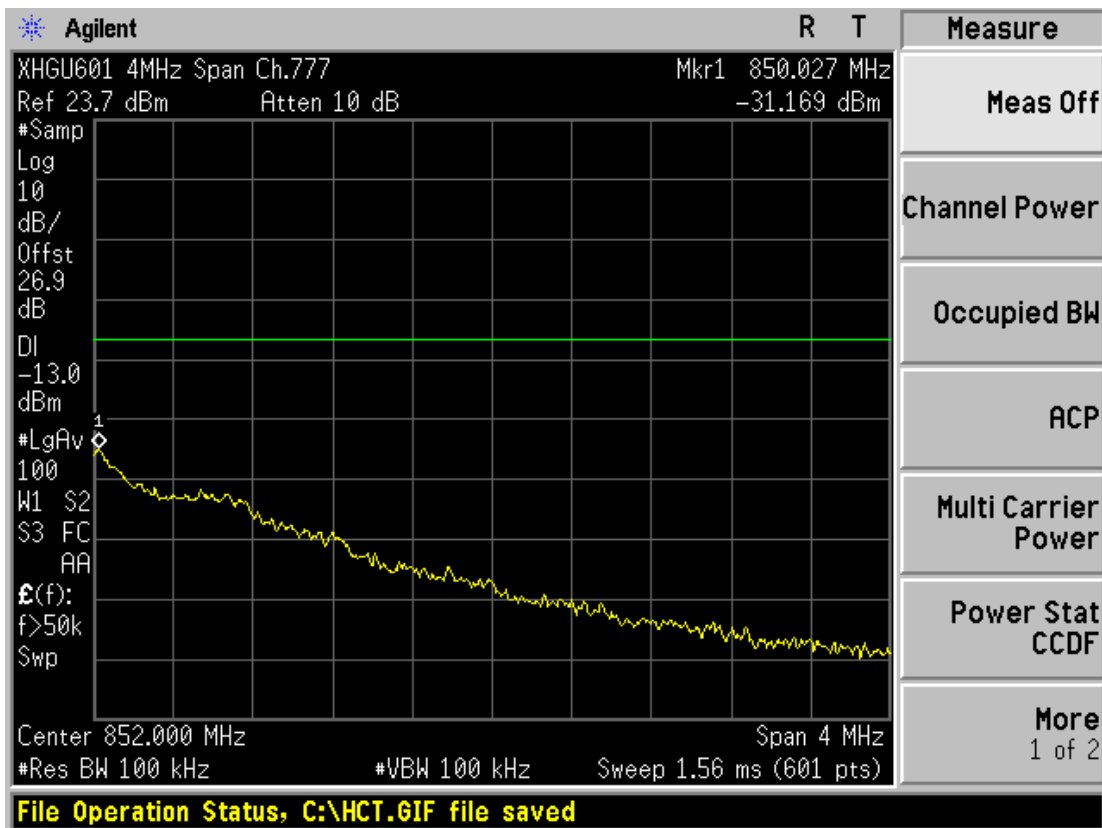

■ CDMA EVDO MODE (1013 CH.) 4 MHz Span

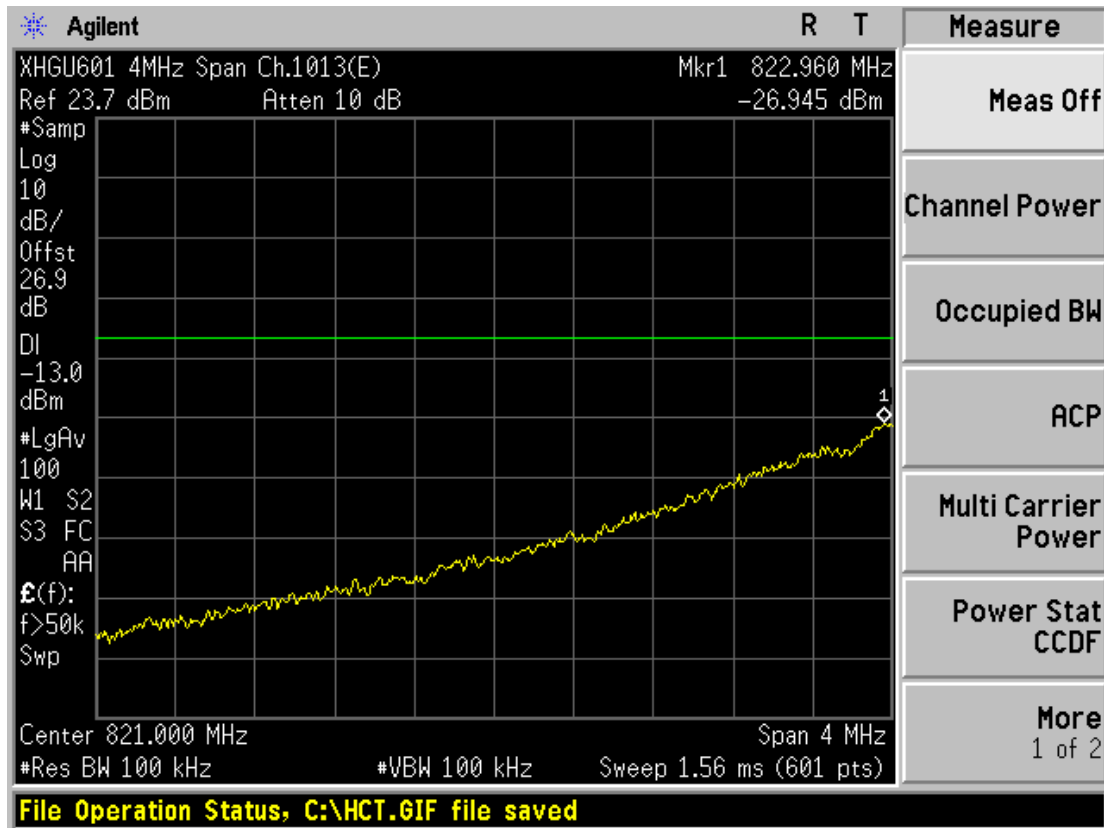

■ CDMA EVDO MODE (777 CH.) 4 MHz Span

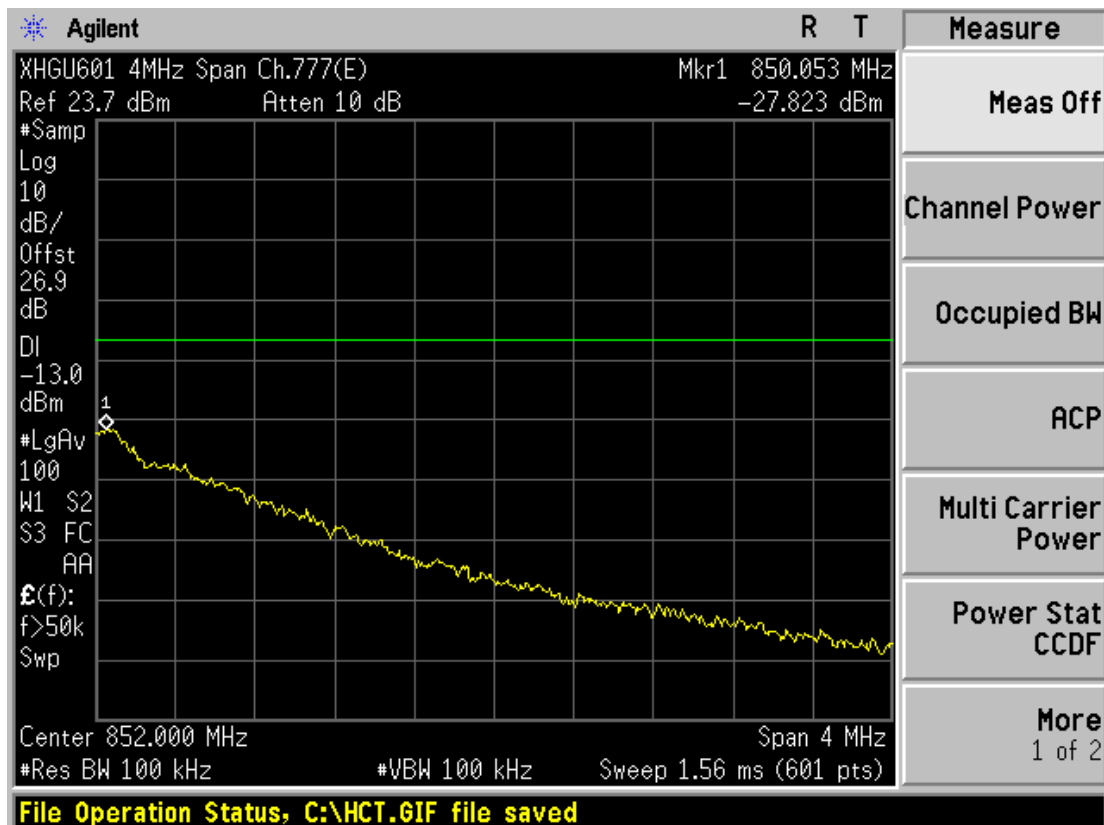



■ PCS CDMA MODE (25 CH.) Block Edge

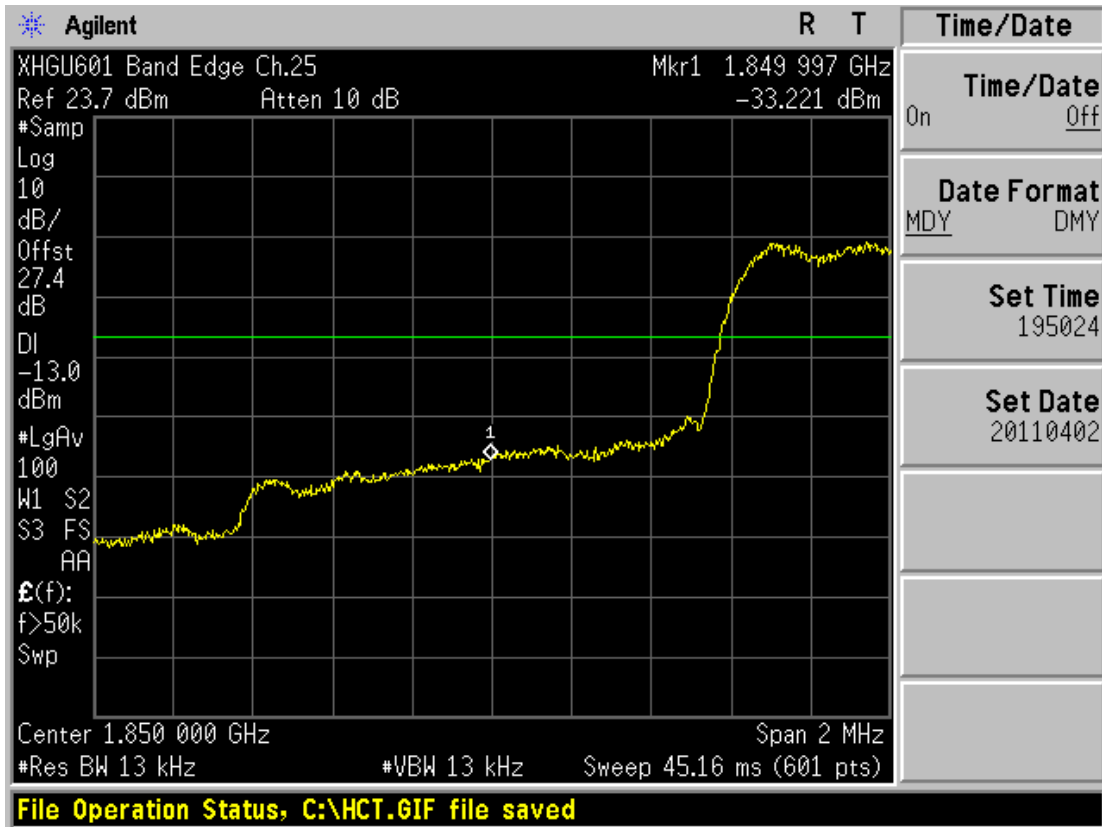

■ PCS CDMA MODE (1175 CH.) Block Edge

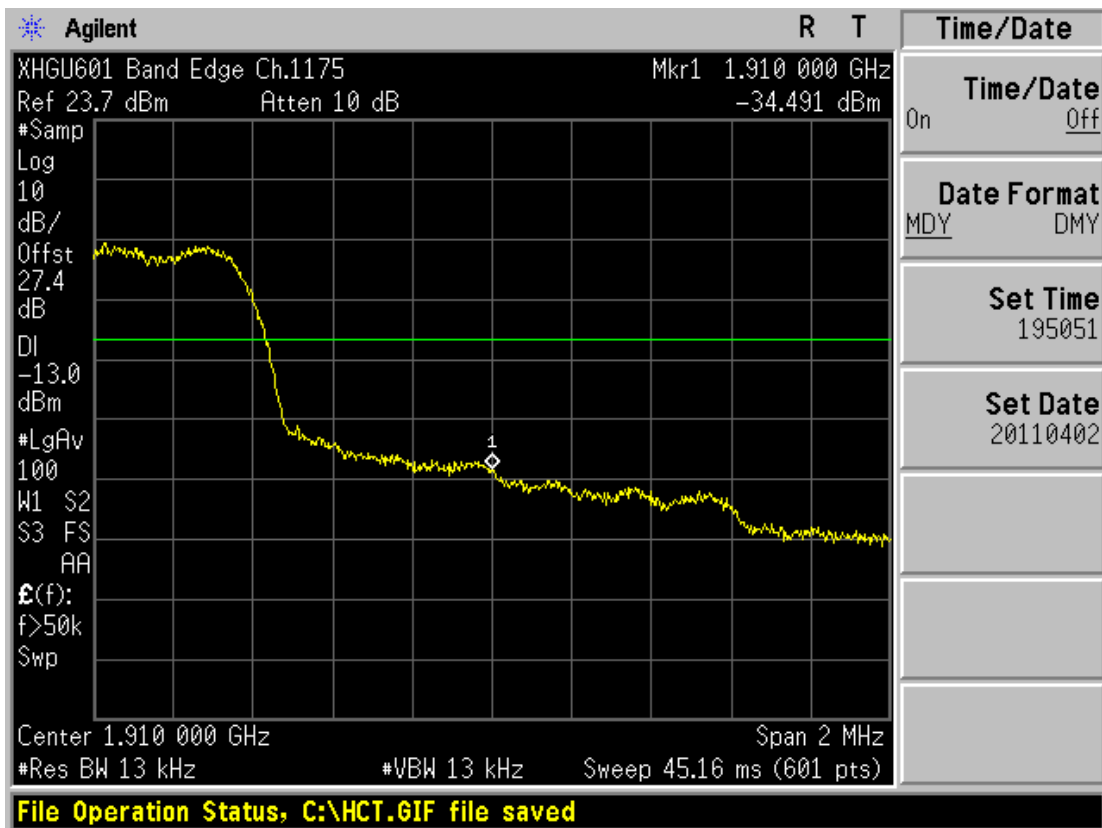

■ PCS CDMA EVDO MODE (25 CH.) Block Edge

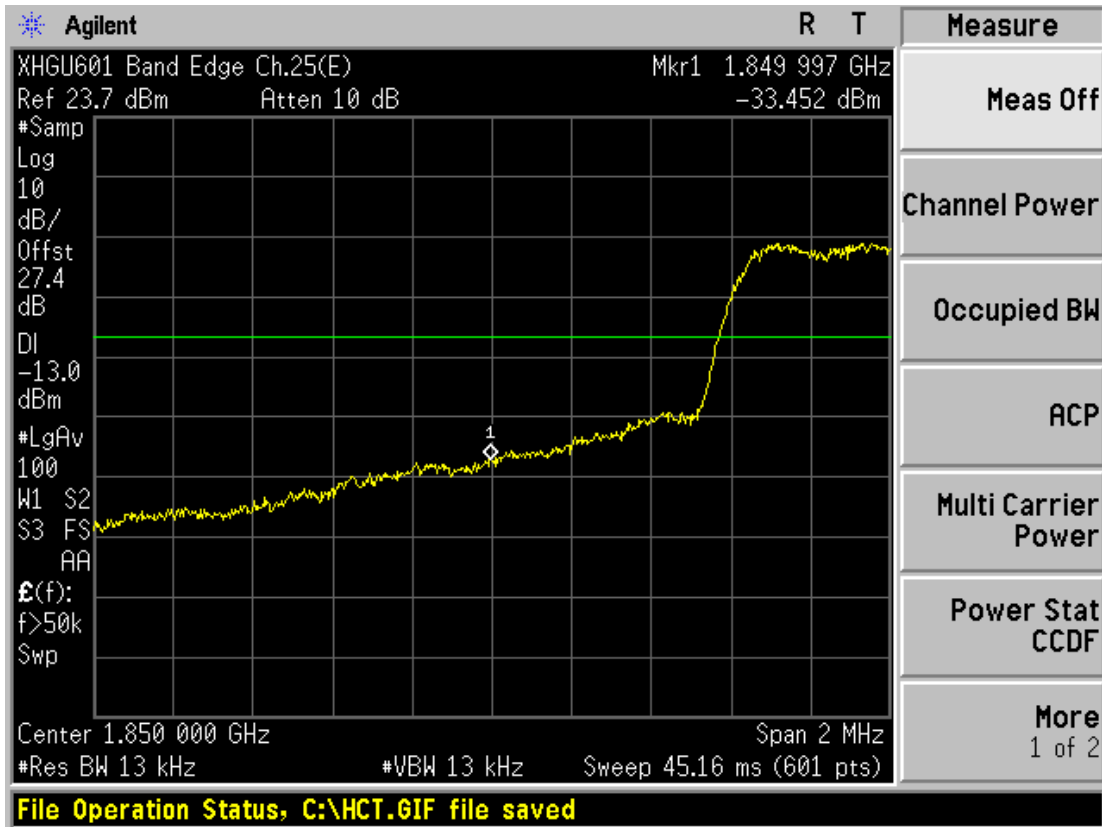

■ PCS CDMA EVDO MODE (1175 CH.) Block Edge

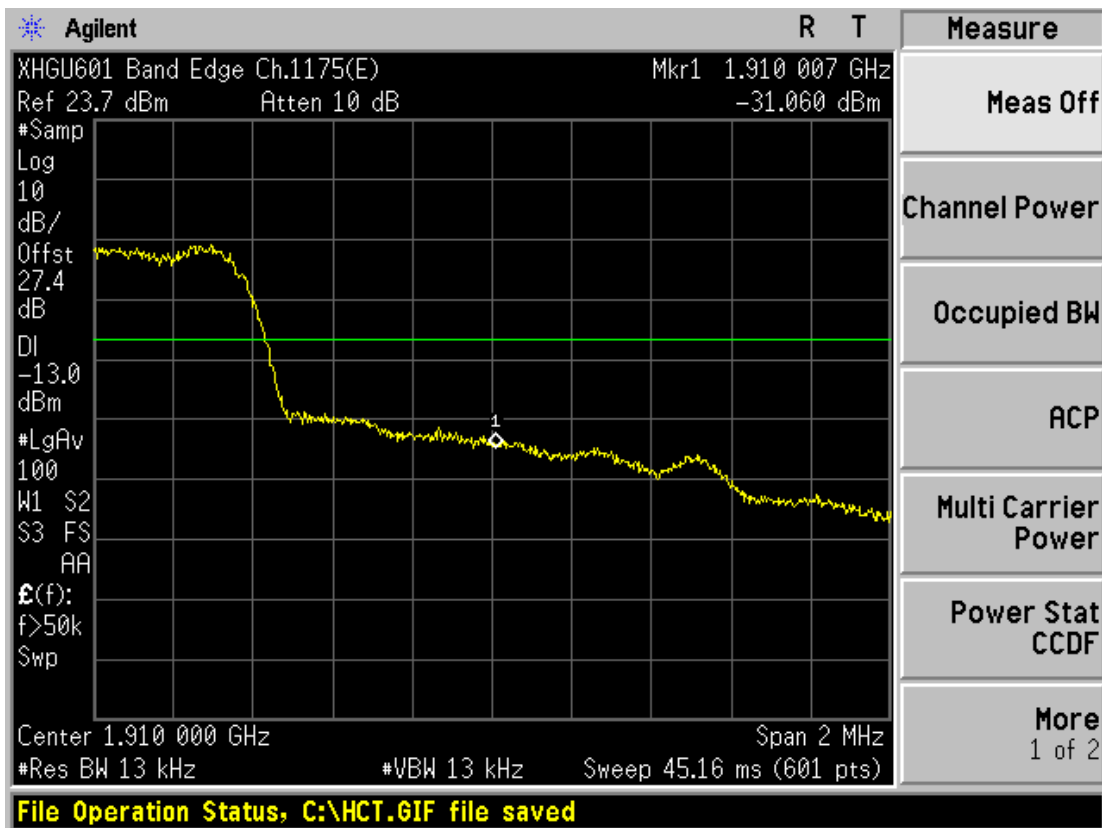

■ PCS CDMA MODE (25 CH.) 4 MHz Span

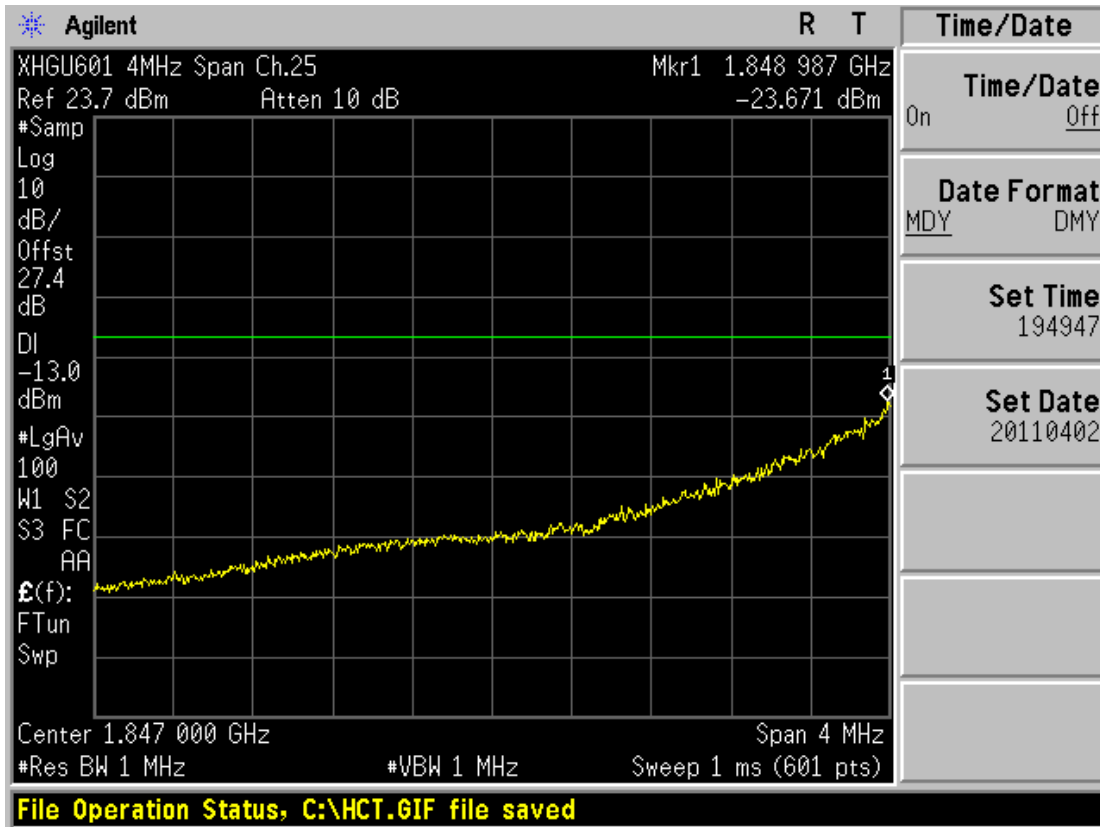

■ PCS CDMA MODE (1175 CH.) 4 MHz Span

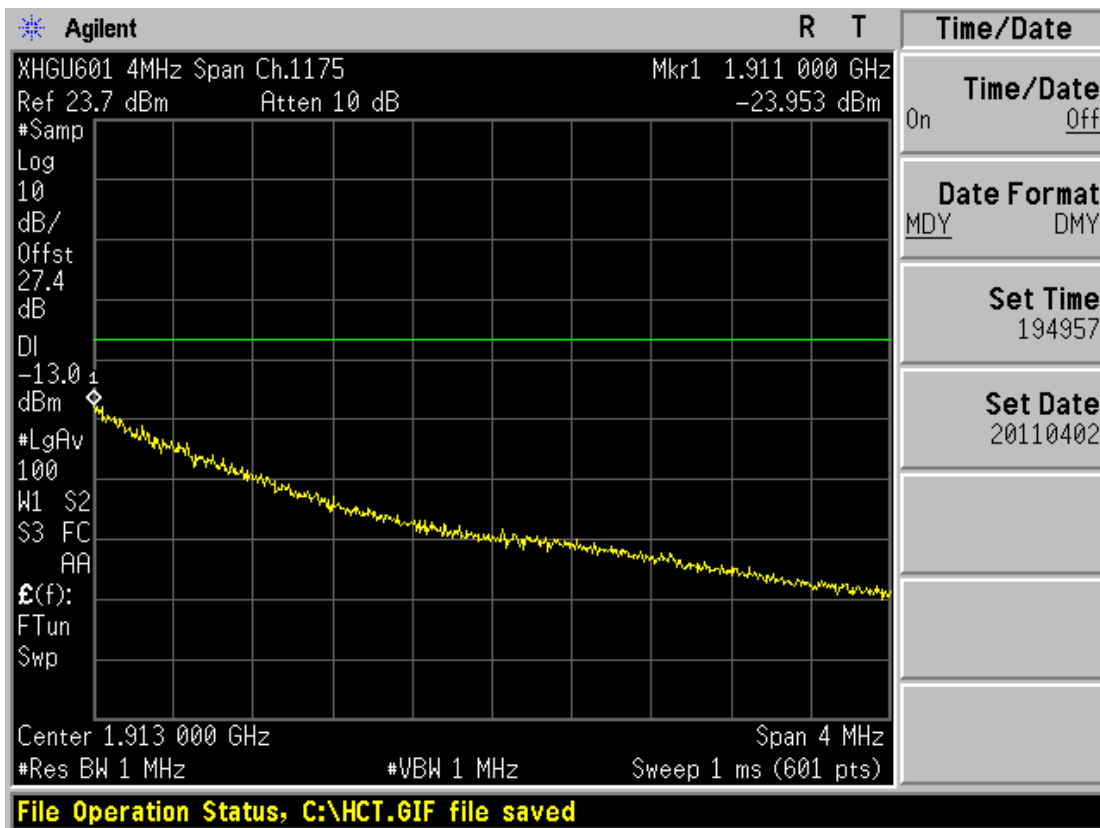

■ PCS CDMA EVDO MODE (25 CH.) 4 MHz Span

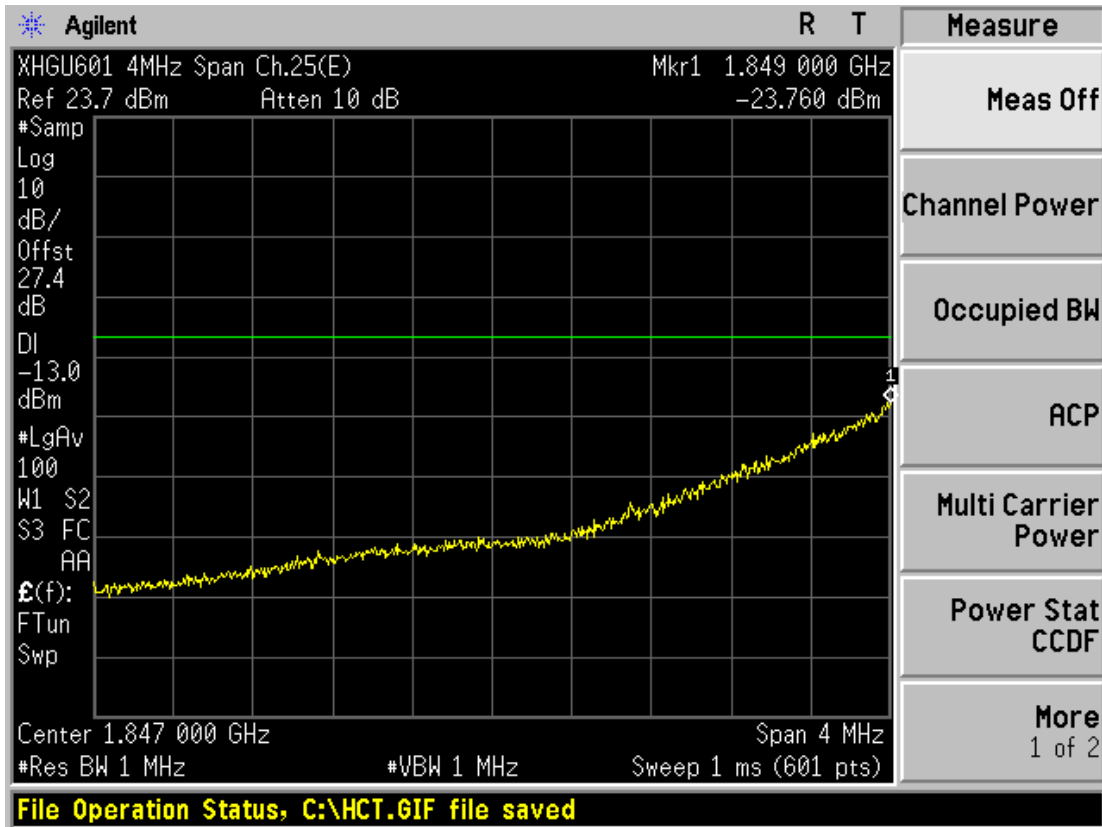

■ PCS CDMA EVDO MODE (1175 CH.) 4 MHz Span

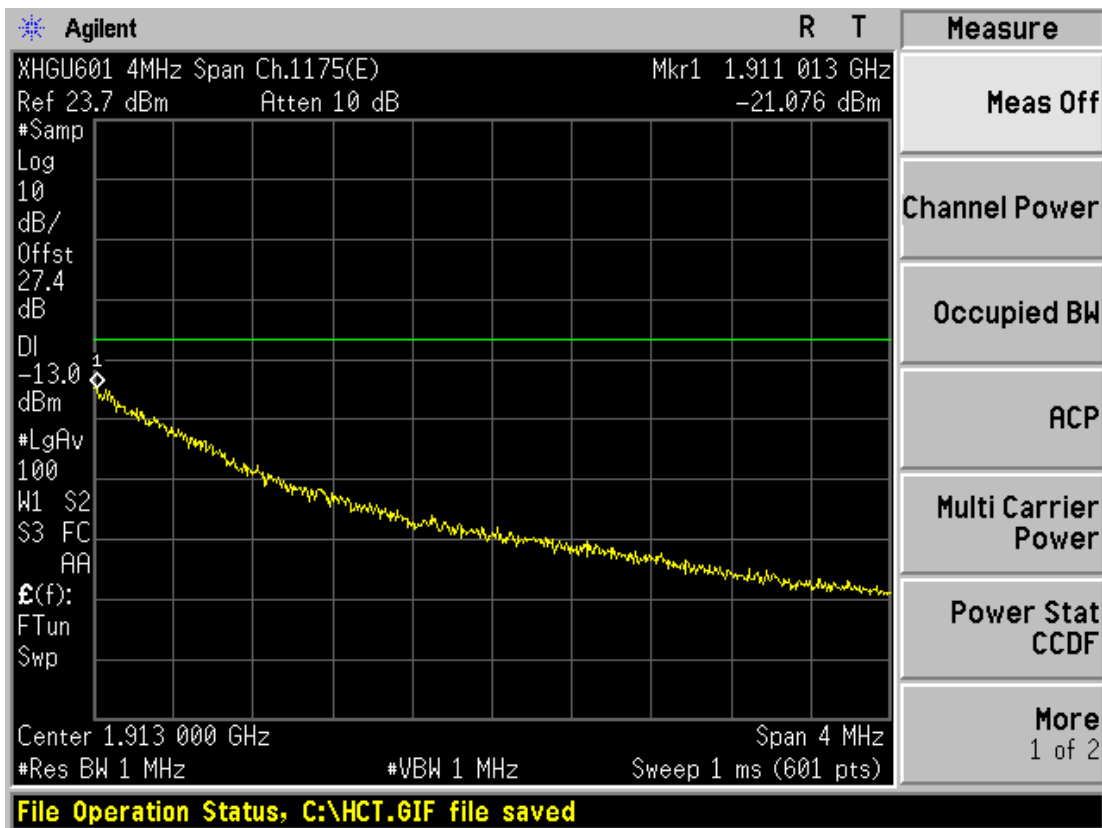

■ CDMA MODE (1013 CH.) Conducted Spurious Emissions - 1

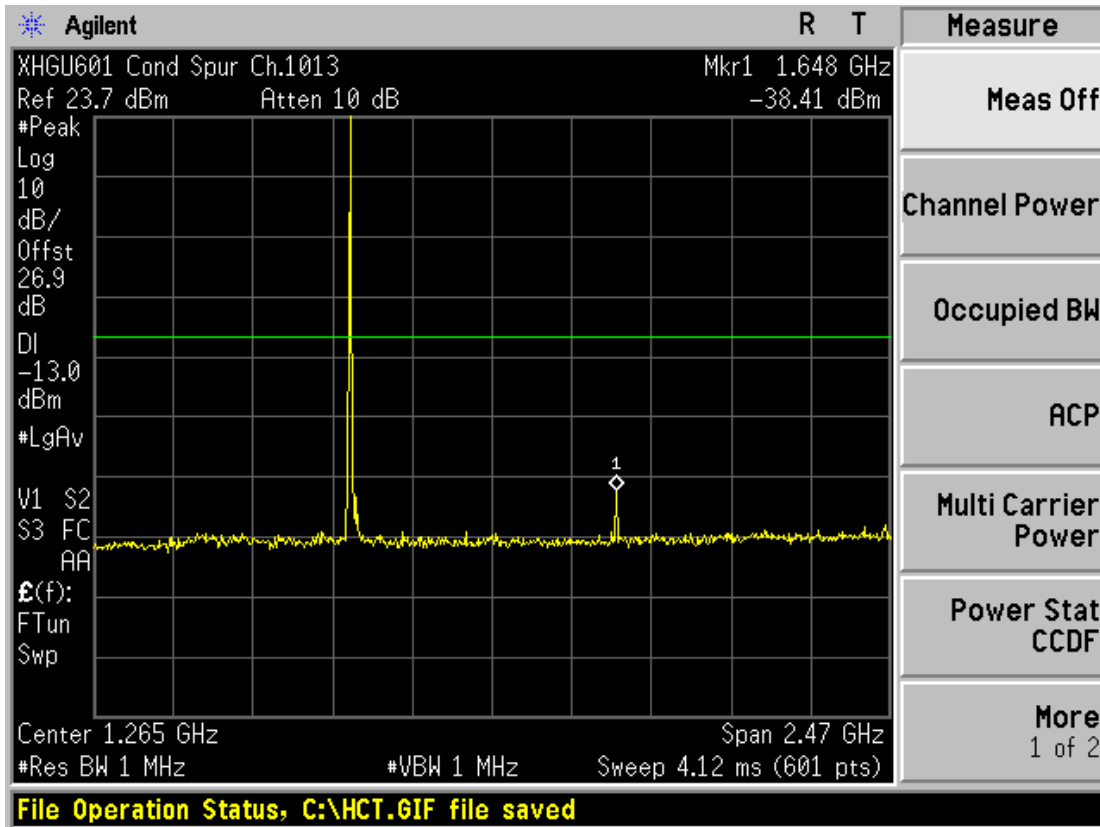

■ CDMA MODE (1013 CH.) Conducted Spurious Emissions - 2

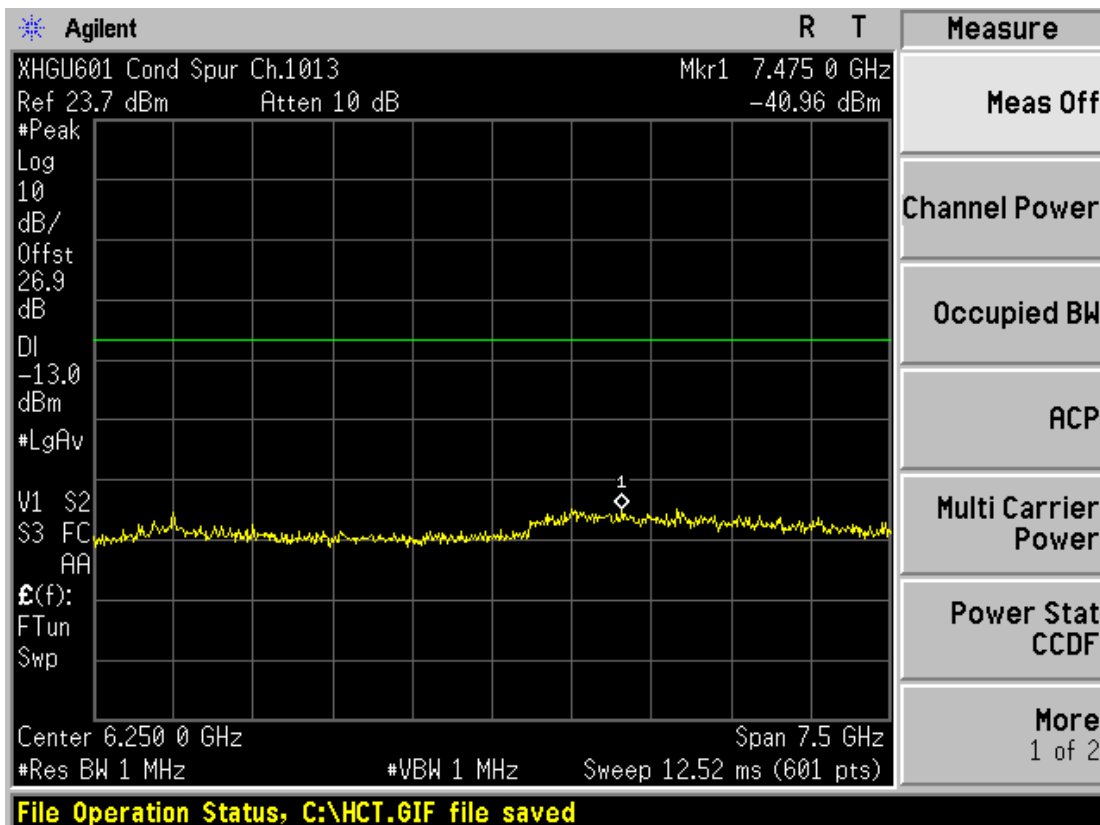

■ CDMA MODE (384 CH.) Conducted Spurious Emissions - 1

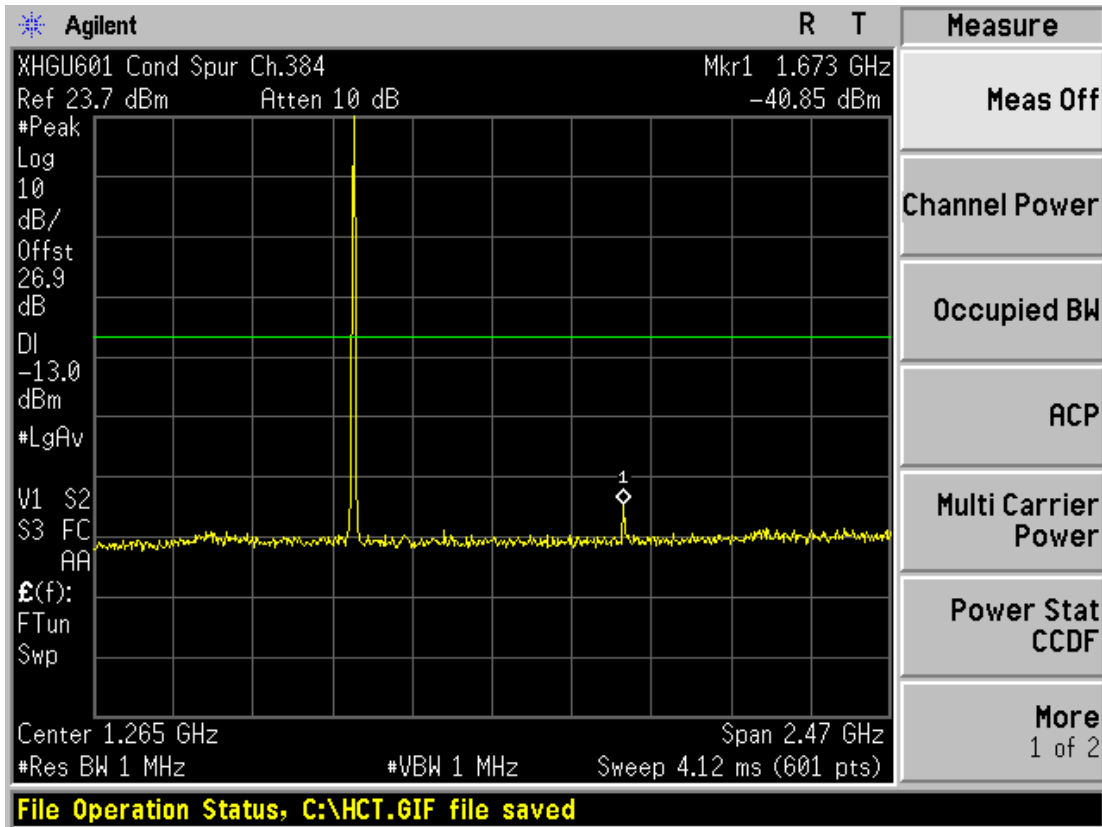

■ CDMA MODE (384 CH.) Conducted Spurious Emissions - 2

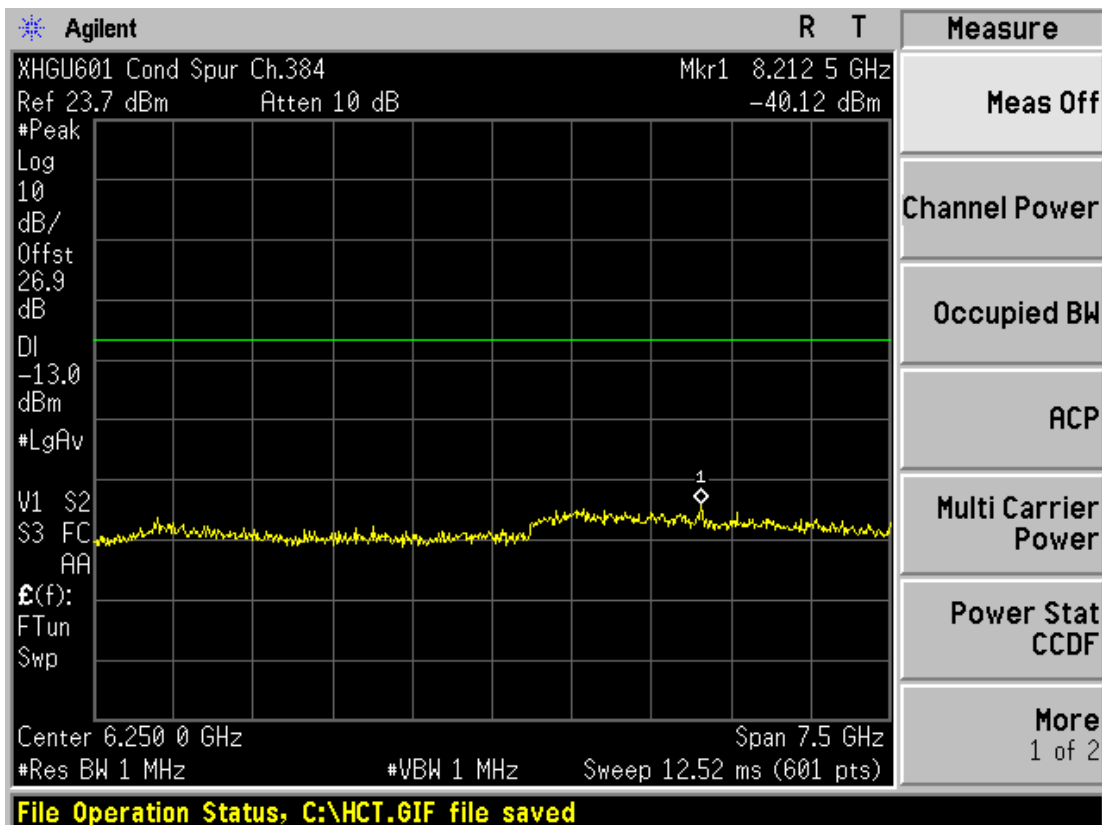

■ CDMA MODE (777 CH.) Conducted Spurious Emissions - 1

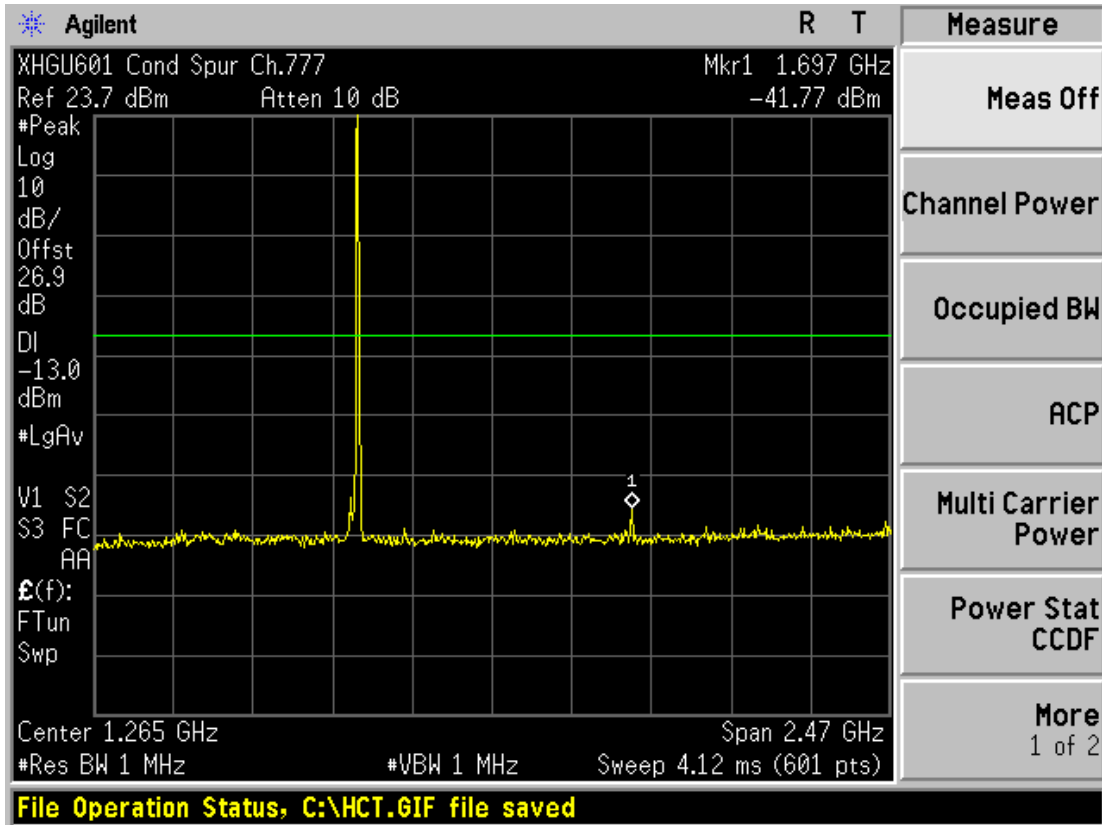

■ CDMA MODE (777 CH.) Conducted Spurious Emissions - 2

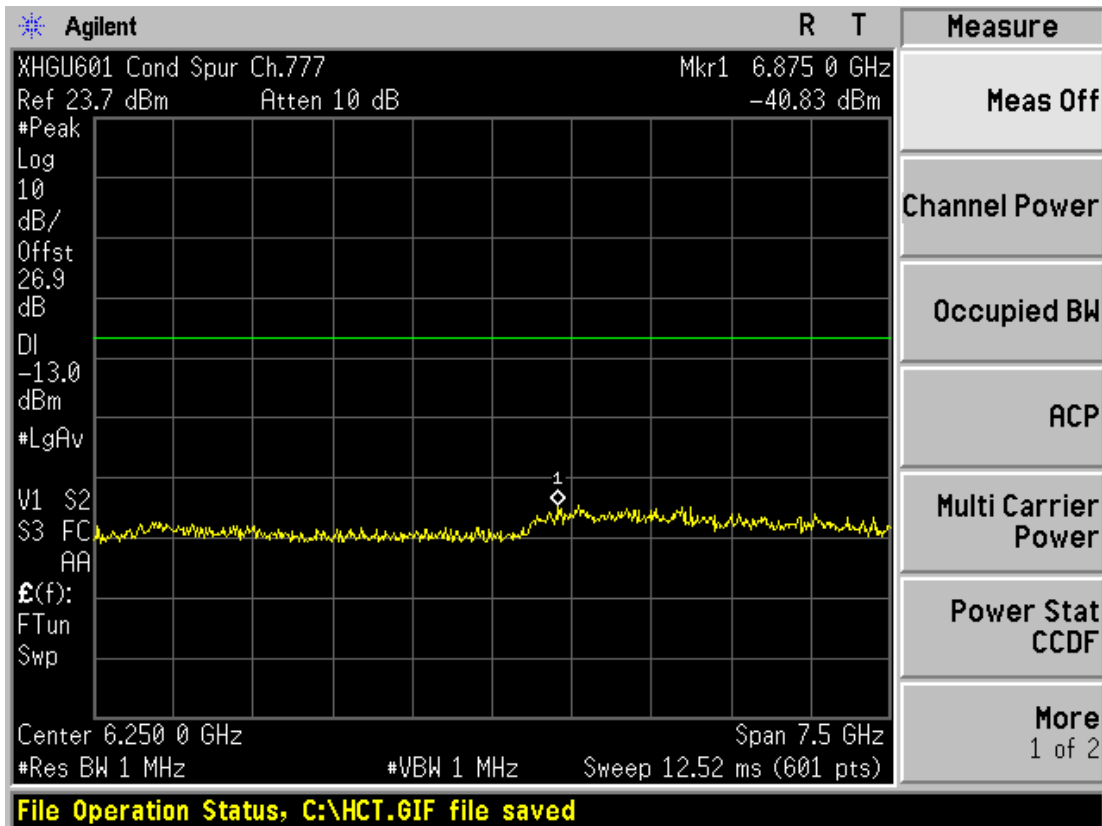

■ PCS CDMA MODE (25 CH.) Conducted Spurious Emissions - 1

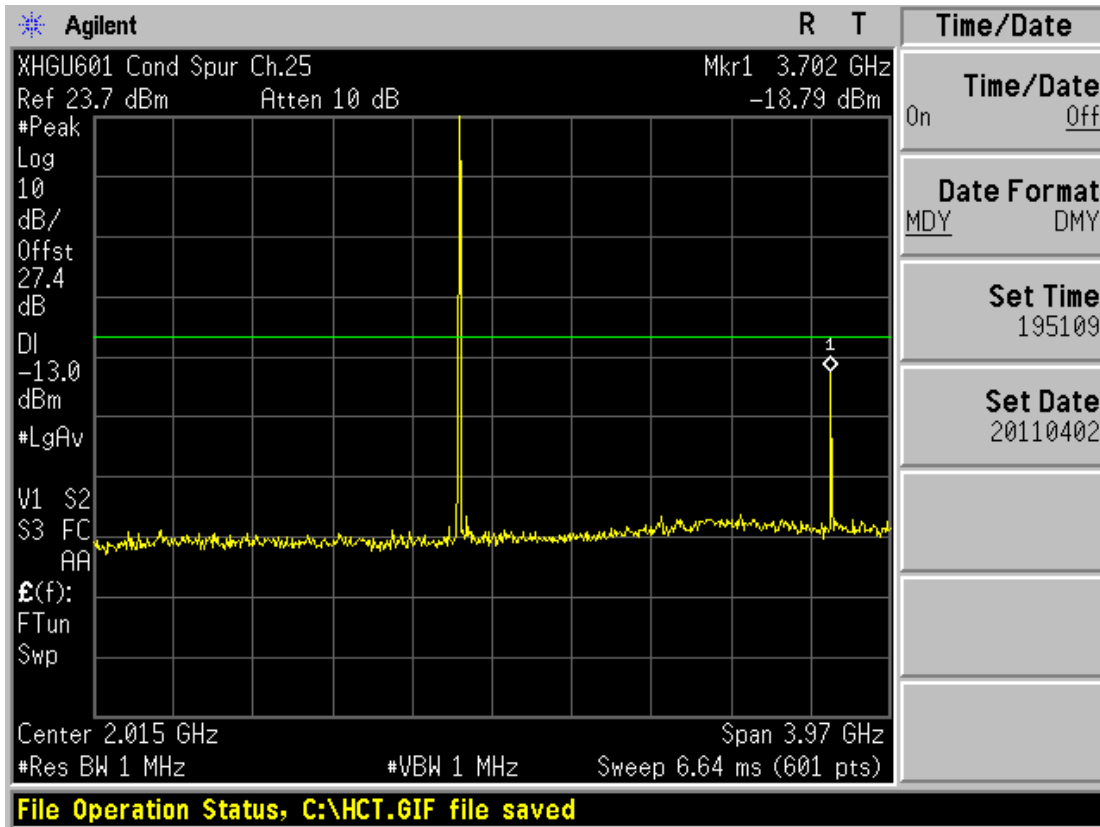

■ PCS CDMA MODE (25 CH.) Conducted Spurious Emissions - 2

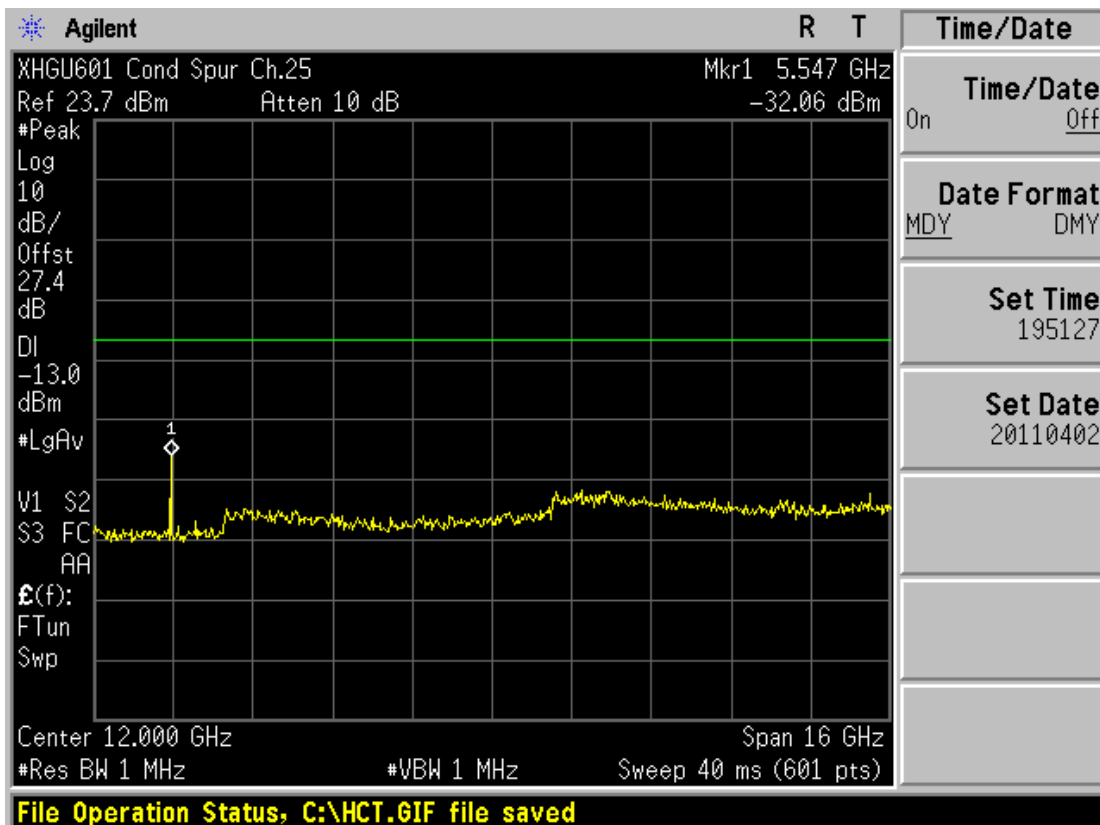



■ PCS CDMA MODE (600 CH.) Conducted Spurious Emissions - 1

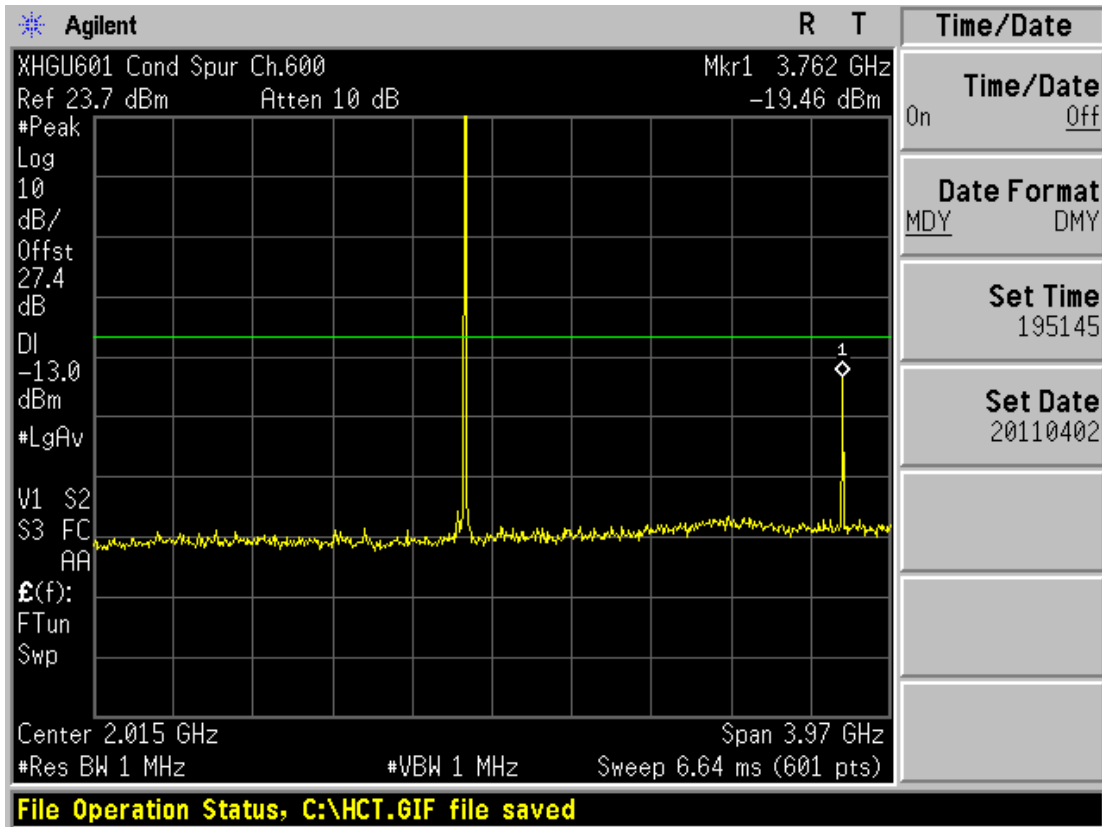

■ PCS CDMA MODE (600 CH.) Conducted Spurious Emissions - 2

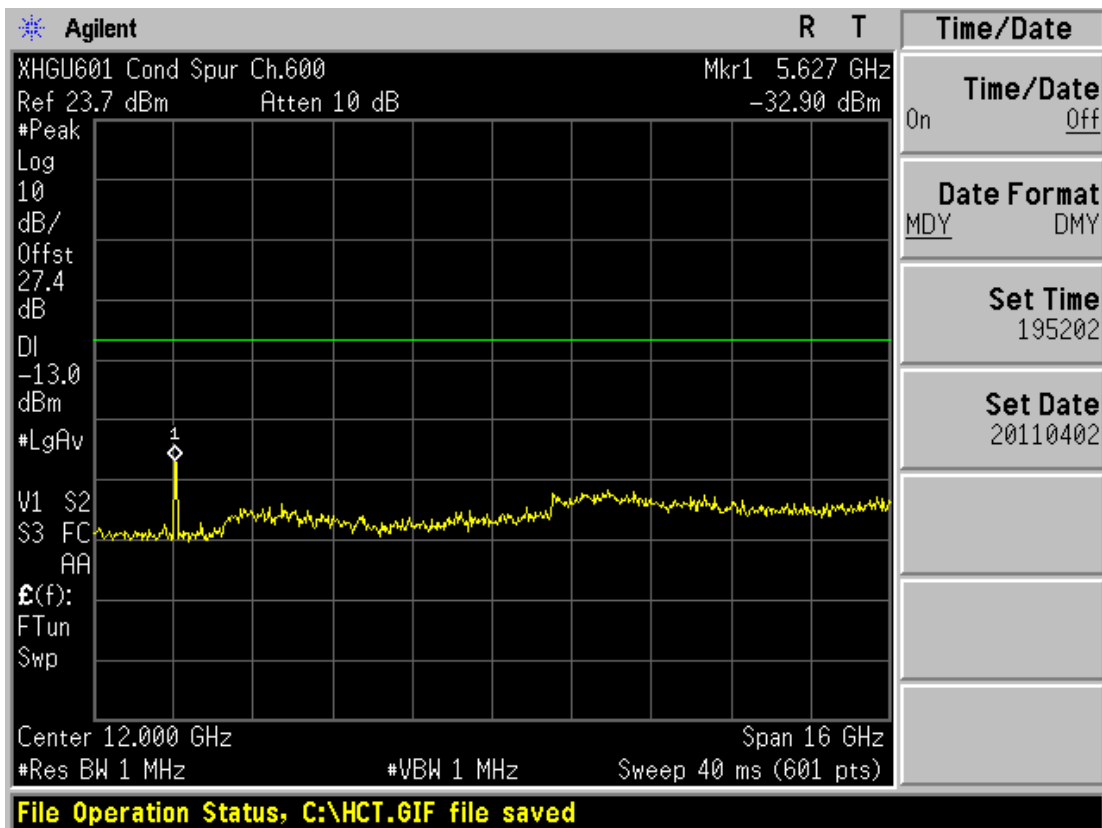

■ PCS CDMA MODE (1175 CH.) Conducted Spurious Emissions - 1

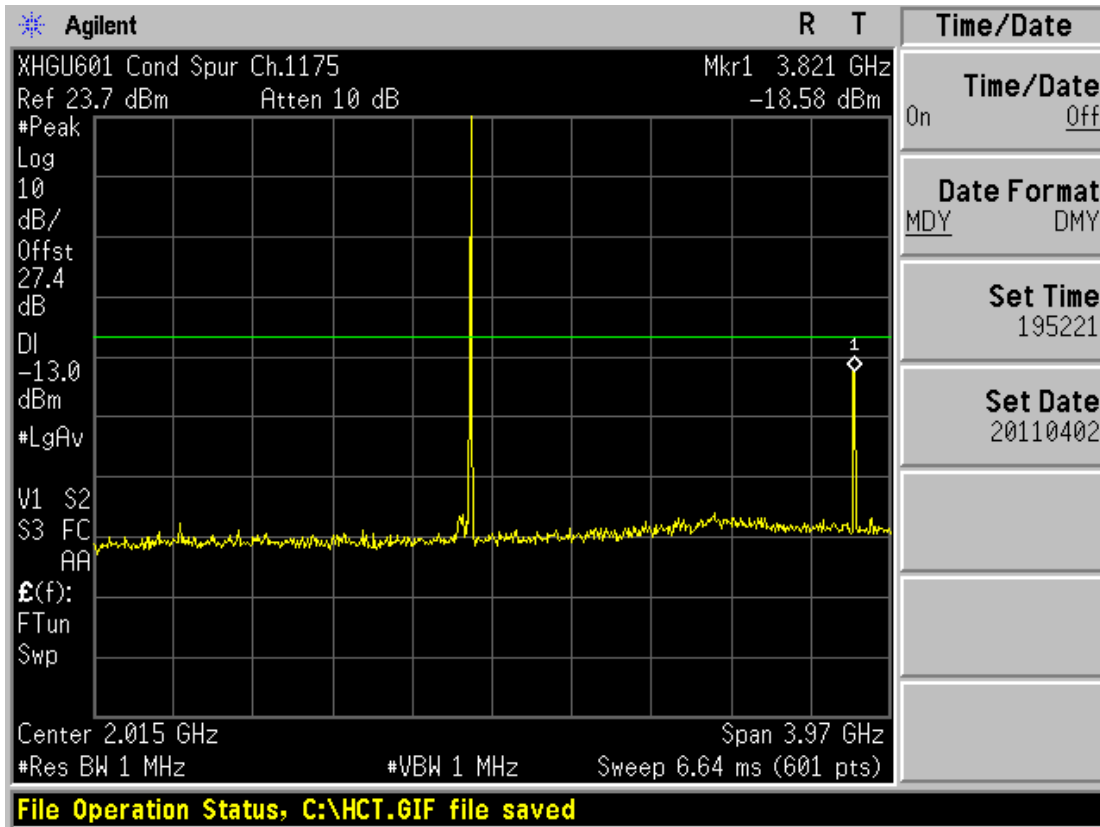

■ PCS CDMA MODE (1175 CH.) Conducted Spurious Emissions - 2

