



HCT CO., LTD.

Product Compliance Division

TEL : +82 31 639 8518 FAX : +82 31 639 8535

FCC Certification

Applicant Name: Franklin Technology Inc.	Date of Issue: November 02, 2010
Address: 1505 Digital Tower Aston, 505-15 Gasan-dong, Gumcheon-gu, Seoul, Korea	Location: HCT CO., LTD., 105-1, Jangam-ri, Majang-Myeon, Icheon-si, Kyunggi-Do, Korea(Lab)
	Test Report No.: HCTR1010FFR12-2
	HCT FRN: 0005866421
	IC Recognition No.: IC 5944A-2

FCC ID	: XHG-M600C
APPLICANT	: Franklin Technology Inc.

Model(s):	M600C
EUT Type:	3G Module
Tx Frequency:	824.70 — 848.31 MHz (CDMA) 1 851.25 — 1 908.75 MHz (PCS CDMA)
Rx Frequency:	869.70 — 893.31 MHz (CDMA) 1 931.25 — 1 988.75 MHz (PCS CDMA)
Max. Conducted Power:	0.254 W CDMA (24.05 dBm) / 0.248 W PCS CDMA (23.96 dBm)/ 0.255 W CDMA EVDO (24.08 dBm) / 0.254 W PCS EVDO (24.06 dBm)
Emission Designator(s):	1M28F9W (CDMA) / 1M28F9W (PCS CDMA) 1M27F9W (CDMA EVDO), 1M28/F9W (PCS CDMA EVDO)
FCC Classification:	PCS Licensed Transmitter (PCB)
FCC Rule Part(s):	§22, §24, §2

The measurements shown in this report were made in accordance with the procedures specified in §2.947. I assume full responsibility for the accuracy and completeness of these measurements, and for the qualifications of all persons taking them.

HCT CO., LTD. Certifies that no party to this application has subject to a denial of Federal benefits that includes FCC benefits pursuant to section 5301 of the Anti-Drug Abuse Act of 1998,21 U.S. C.853(a)

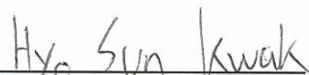
Report prepared by
: Hyo Sun Kwak
Test engineer of RF Team

Approved by
: Sang Jun Lee
Manager of RF Team

This report only responds to the tested sample and may not be reproduced, except in full, without written approval of the HCT Co., Ltd.

FCC CERTIFICATION REPORT			www.hct.co.kr
Test Report No. HCTR1010FFR12-2	Date of Issue: November 02, 2010	EUT Type: 3G Module	FCC ID: XHG-M600C



Version

TEST REPORT NO.	DATE	DESCRIPTION
HCTR1010FR12	October 19, 2010	First Approval Report
HCTR1010FR12-1	October 29, 2010	Change the test site description
HCTR1010FR12-2	November 02, 2010	Delete ERP/ EIRP Test

FCC CERTIFICATION REPORT			www.hct.co.kr
Test Report No. HCTR1010FFR12-2	Test Dates: November 02, 2010	EUT Type: 3G Module	FCC ID: XHG-M600C



Table of Contents

1. GENERAL INFORMATION	4
2. INTRODUCTION	5
2.1. EUT DESCRIPTION.....	5
2.2. MEASURING INSTRUMENT CALIBRATION.....	5
2.3. TEST FACILITY	5
3. DESCRIPTION OF TESTS	6
3.1 EFFECTIVE RADIATED POWER/EQUIVALENT ISOTROPIC RADIATED POWER.....	6
3.2 PEAK- TO- AVERAGE RATIO	7
3.3 OCCUPIED BANDWIDTH.	8
3.4 SPURIOUS AND HARMONIC EMISSIONS AT ANTENNA TERMINAL.....	9
3.5 RADIATED SPURIOUS AND HARMONIC EMISSIONS	10
3.6 FREQUENCY STABILITY / VARIATION OF AMBIENT TEMPERATURE	11
4. LIST OF TEST EQUIPMENT	12
5. SUMMARY OF TEST RESULTS	13
6. SAMPLE CALCULATION	14
7. TEST DATA	15
7.1 CONDUCTED OUTPUT POWER	15
7.2 OCCUPIED BANDWIDTH	16
7.3 CONDUCTED SPURIOUS EMISSIONS	16
7.3.1 BAND EDGE.....	16
7.4 RADIATED SPURIOUS EMISSIONS	17
7.4.1 RADIATED SPURIOUS EMISSIONS(CDMA MODE)	17
7.4.2 RADIATED SPURIOUS EMISSIONS(PCS CDMA MODE).....	18
7.5 FREQUENCY STABILITY / VARIATION OF AMBIENT TEMPERATURE	19
7.5.1 FREQUENCY STABILITY (CDMA).....	19
7.5.2 FREQUENCY STABILITY (PCS CDMA)	20
8. TEST PLOTS.....	21

FCC CERTIFICATION REPORT			www.hct.co.kr
Test Report No. HCTR1010FFR12-2	Test Dates: November 02, 2010	EUT Type: 3G Module	FCC ID: XHG-M600C



MEASUREMENT REPORT

1. GENERAL INFORMATION

Applicant Name: Franklin Technology Inc.

Address: 1505 Digital Tower Aston, 505-15 Gasan-dong, Gumcheon-gu, Seoul, Korea

Contact Person: Name: Michael Chun
Phone #: TEL :+82-70-8260-343 / FAX : +82-2-2082-822

FCC ID: XHG-M600C

Application Type: Certification

FCC Classification: PCS Licensed Transmitter (PCB)

FCC Rule Part(s): §22, §24, §2

EUT Type: 3G Module

Model(s): M600C

Tx Frequency: 824.70 — 848.31 MHz (CDMA)
1 851.25 — 1 908.75 MHz (PCS CDMA)

Rx Frequency: 869.70 — 893.31 MHz (CDMA)
1 931.25 — 1 988.75 MHz (PCS CDMA)

Max. Conducted Power: 0.254 W CDMA (24.05 dBm) / 0.248 W PCS CDMA (23.96 dBm)/
0.255 W CDMA EVDO (24.08 dBm) / 0.254 W PCS EVDO (24.06 dBm)

Emission Designator(s): 1M28F9W (CDMA) / 1M28F9W (PCS CDMA)
1M27F9W (CDMA EVDO), 1M28/F9W (PCS CDMA EVDO)

Date(s) of Tests: October 05, 2010 ~ October 15, 2010

FCC CERTIFICATION REPORT			www.hct.co.kr
Test Report No. HCTR1010FFR12-2	Test Dates: November 02, 2010	EUT Type: 3G Module	FCC ID: XHG-M600C



2. INTRODUCTION

2.1. EUT DESCRIPTION

The M600C 3G Module consists of Cellular CDMA, PCS CDMA, EVDO Rev.0 and EVDO Rev.A.

2.2. MEASURING INSTRUMENT CALIBRATION

The measuring equipment, which was utilized in performing the tests documented herein, has been calibrated in accordance with the manufacturer's recommendations for utilizing calibration equipment, which is traceable to recognized national standards.

2.3. TEST FACILITY

The SAC(Semi-Anechoic Chamber) and conducted measurement facility used to collect the radiated data are located at the 105-1, Jangam-ri , Majang-Myeon, Icheon-si, 467-811, KOREA.

The site is constructed in conformance with the requirements of ANSI C63.4 and CISPR Publication 22. Detailed description of test facility was submitted to the Commission and accepted dated June 10, 2009 (Registration Number: 90661)

FCC CERTIFICATION REPORT			www.hct.co.kr
Test Report No. HCTR1010FFR12-2	Test Dates: November 02, 2010	EUT Type: 3G Module	FCC ID: XHG-M600C

3. DESCRIPTION OF TESTS

3.1 EFFECTIVE RADIATED POWER/EQUIVALENT ISOTROPIC RADIATED POWER

Test Set-up

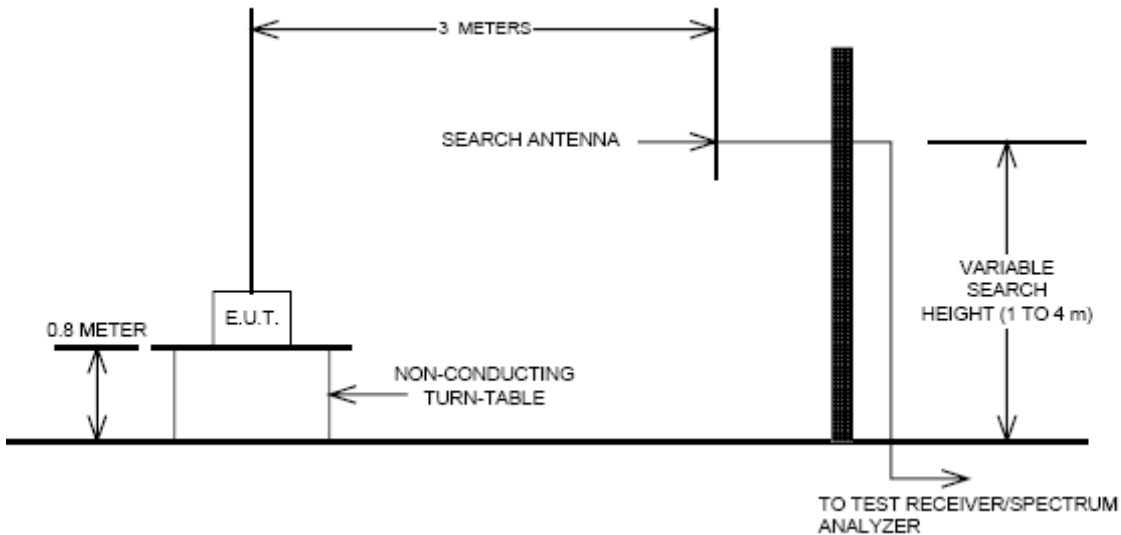

Test Procedure

Radiated emission measurements were performed at an SAC(Semi-Anechoic Chamber)

The equipment under test is placed on a non-conductive styrofoam resin table 3-meters from the receive antenna. A styrofoam turntable was rotated 360° and the receiving antenna scanned from 1-4m in order to capture the maximum emission. A half wave dipole was substituted in place of the EUT. This dipole antenna was driven by a signal generator and the previously recorded signal was duplicated.

The maximum EIRP was calculated by adding the forward power to the calibrated source plus its appropriate gain value. These steps were carried out with the receiving antenna in both vertical and horizontal polarization. For readings above 1GHz, the above procedure is repeated using horn antennas and the difference between the gain of the horn and an isotropic antenna are taken into consideration.

Note : This device was tested under all R.C.s and S.O.s and worst case is reported with RC1/SO02(CDMA) and RC3/SO55(PCS), with 'All Up' power control bits.

FCC CERTIFICATION REPORT			www.hct.co.kr
Test Report No. HCTR1010FFR12-2	Test Dates: November 02, 2010	EUT Type: 3G Module	FCC ID: XHG-M600C



3.2 PEAK- TO- AVERAGE RATIO

A peak to average ratio measurement is performed at the conducted port of the EUT. For CDMA and WCDMA signals, the spectrum analyzers Complementary Cumulative Distribution Function (CCDF) measurement profile is used to determine the largest deviation between the average and the peak power of the EUT in a given bandwidth. The CCDF curve shows how much time the peak waveform spends at or above a given average power level. The percent of time the signal spends at or above the level defines the probability for that particular power level. For GSM signals, an average and a peak trace are used on a spectrum analyzer to determine the largest deviation between the average and the peak power of the EUT in a bandwidth greater than the emission bandwidth. Plots of the EUT's Peak- to- Average Ratio are shown herein.

Note : This device was tested under all R.C.s and S.O.s and worst case is reported with RC1/SO02(CDMA) and RC3/SO55(PCS), with 'All Up' power control bits.

FCC CERTIFICATION REPORT			www.hct.co.kr
Test Report No. HCTR1010FFR12-2	Test Dates: November 02, 2010	EUT Type: 3G Module	FCC ID: XHG-M600C

3.3 OCCUPIED BANDWIDTH.

Test set-up

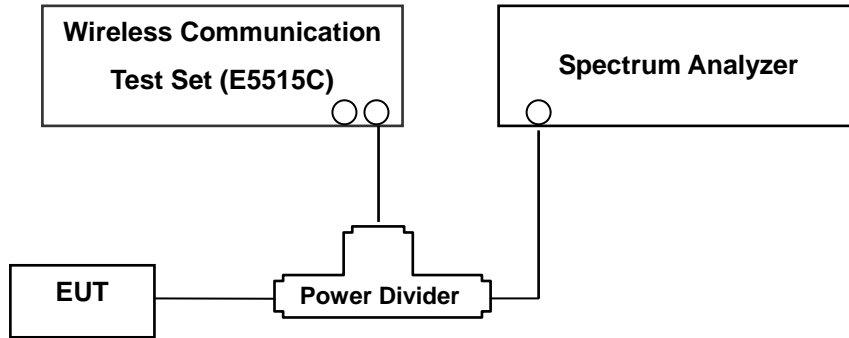

(Configuration of conducted Emission measurement)

Test Procedure

The EUT was setup to maximum output power at its lowest channel. The occupied bandwidth was measured using a spectrum analyzer. The measurements are repeated for the highest and a middle channel. The EUT's occupied bandwidth is measured as the width of the signal between two points, one below the carrier center frequency and one above the carrier frequency, outside of which all emissions are attenuated at least 26 dB below the transmitter power. Plots of the EUT's occupied bandwidth are shown herein.

Note : This device was tested under all R.C.s and S.O.s and worst case is reported with RC1/SO02(CDMA) and RC3/SO55(PCS), with 'All Up' power control bits.

FCC CERTIFICATION REPORT			www.hct.co.kr
Test Report No. HCTR1010FFR12-2	Test Dates: November 02, 2010	EUT Type: 3G Module	FCC ID: XHG-M600C



3.4 SPURIOUS AND HARMONIC EMISSIONS AT ANTENNA TERMINAL.

Test Procedure

The level of the carrier and the various conducted spurious and harmonic frequencies is measured by means of a calibrated spectrum analyzer.

The EUT was setup to maximum output power at its lowest channel. The Resolution BW of the analyzer is set to 1 % of the emission bandwidth to show compliance with the – 13 dBm limit, in the 1 MHz bands immediately outside and adjacent to the edge of the frequency block. The 1 MHz RBW was used to scan from 30 MHz to 10 GHz. (PCS CDMA Mode: 30 MHz to 20 GHz). A display line was placed at – 13 dBm to show compliance. The high, lowest and a middle channel were tested for out of band measurements.

- Band Edge Requirement : In the 1MHz bands immediately outside and adjacent to the frequency block, a resolution bandwidth of at least 1 percent of the emission bandwidth of the fundamental emission of the transmitter may be employed to measure the out of band Emissions. Limit, -13dBm.

Note : This device was tested under all R.C.s and S.O.s and worst case is reported with RC1/SO02(CDMA) and RC3/SO55(PCS), with 'All Up' power control bits.

FCC CERTIFICATION REPORT			www.hct.co.kr
Test Report No. HCTR1010FFR12-2	Test Dates: November 02, 2010	EUT Type: 3G Module	FCC ID: XHG-M600C

3.5 RADIATED SPURIOUS AND HARMONIC EMISSIONS

Test Set-up

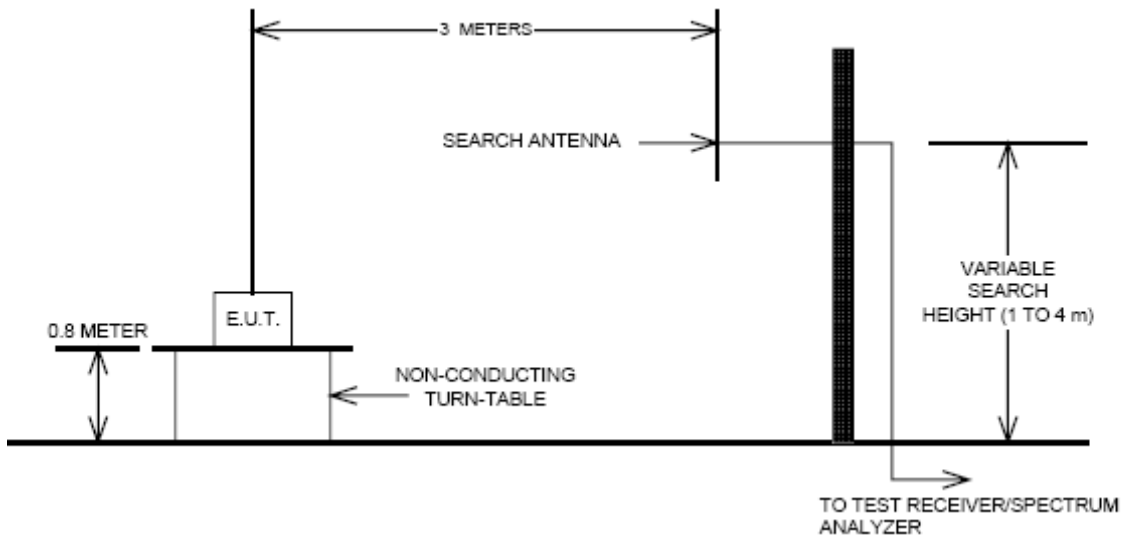

The measurement facilities used for this test have been documented in previous filings with the commission pursuant to section § 2.948. The SAC(Semi-Anechoic Chamber) meets requirements in ANSI C63.4 –2003. A mast capable of lifting the receiving antenna from a height of one to four meters is used together with a rotatable styrofoam platform mounted at three from the antenna mast.

- 1) The unit mounted on a styrofoam turntable 1.5 m × 1.0 m × 0.80 m is 0.8 meter above test site ground level.
- 2) During the emission test, the turntable is rotated and the EUT is manipulated to find the configuration resulting in maximum emission under normal condition of installation and operation.
- 3) The antenna height and polarization are also varied from 1 to 4 meters until the maximum signal is found.
- 4) The spectrum shall be scanned up to the 10th harmonic of the fundamental frequency.

Test Procedure

The equipment under test is placed on a non-conductive styrofoam resin table 3-meters from the receive antenna. A styrofoam turntable was rotated 360° and the receiving antenna scanned from 1-4m in order to capture the maximum emission. A half wave dipole was substituted in place of the EUT. This dipole antenna was driven by a signal generator and the previously recorded signal was duplicated.

The maximum EIRP was calculated by adding the forward power to the calibrated source plus its appropriate gain value. These steps were carried out with the receiving antenna in both vertical and horizontal polarization. For readings above 1GHz, the above procedure is repeated using horn antennas and the difference between the gain of the horn and an isotropic antenna are taken into consideration.

Note : This device was tested under all R.C.s and S.O.s and worst case is reported with RC1/SO02(CDMA) and RC3/SO55(PCS), with 'All Up' power control bits.

FCC CERTIFICATION REPORT			www.hct.co.kr
Test Report No. HCTR1010FFR12-2	Test Dates: November 02, 2010	EUT Type: 3G Module	FCC ID: XHG-M600C

3.6 FREQUENCY STABILITY / VARIATION OF AMBIENT TEMPERATURE

Test Set-up

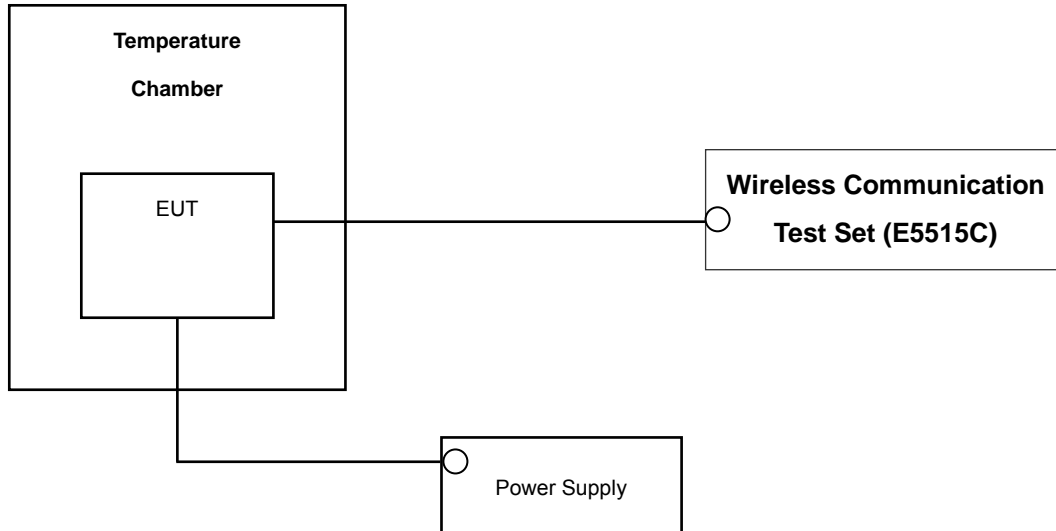

* Nominal Operating Voltage

Test Procedure

The frequency stability of the transmitter is measured by:

- a.) **Temperature:** The temperature is varied from - 30 °C to + 50 °C using an environmental chamber.
- b.) **Primary Supply Voltage:** The primary supply voltage is varied from battery end point to 115 % of the voltage normally at the input to the device or at the power supply terminals if cables are not normally supplied.

Specification — the frequency stability shall be sufficient to ensure that the fundamental emission stays within the authorized frequency block. The frequency stability of the transmitter shall be maintained within $\pm 0.00025\%$ (± 2.5 ppm) of the center frequency.

Time Period and Procedure:

The carrier frequency of the transmitter is measured at room temperature (20°C to provide a reference).

1. The equipment is turned on in a “standby” condition for one minute before applying power to the transmitter. Measurement of the carrier frequency of the transmitter is made within one minute after applying power to the transmitter.
2. Frequency measurements are made at 10°C intervals ranging from -30°C to +50°C. A period of at least one half-hour is provided to allow stabilization of the equipment at each temperature level.

NOTE: The EUT is tested down to the battery endpoint.

Note : This device was tested under all R.C.s and S.O.s and worst case is reported with RC1/SO02(CDMA) and RC3/SO55(PCS), with 'All Up' power control bits.

FCC CERTIFICATION REPORT			www.hct.co.kr
Test Report No. HCTR1010FFR12-2	Test Dates: November 02, 2010	EUT Type: 3G Module	FCC ID: XHG-M600C



4. LIST OF TEST EQUIPMENT

Manufacture	Model/ Equipment	Serial Number	Calibration Interval	Calibration Due
R&S	ESI40/ Spectrum Analyzer	831564/003	Annual	10/30/2010
Agilent	E4416A/ Power Meter	GB41291412	Annual	01/14/2011
Agilent	E9327A/ Power Sensor	MY4442009	Annual	07/23/2011
Agilent	8960 (E5515C)/ Base Station	GB44400269	Annual	02/10/2011
MITEQ	AMF-6D-001180-35-20P/AMP	990893	Annual	05/20/2011
Wainwright	WHK1.2/15G-10EF/H.P.F	2	Annual	06/25/2011
Wainwright	WHK3.3/18G-10EF/H.P.F	1	Annual	06/25/2011
Agilent	775D/ Dual Directional Coupler	12922	Annual	12/24/2010
Agilent	11636B/ Power Divider	11377	Annual	12/24/2010
Digital	EP-3010/ Power Supply	3110117	Annual	01/08/2011
Schwarzbeck	UHAP/ Dipole Antenna	585	Biennial	02/13/2011
Schwarzbeck	UHAP/ Dipole Antenna	558	Biennial	02/13/2011
Korea Engineering	KR-1005L / Chamber	KRAB07063-2CH	Annual	12/28/2010
Schwarzbeck	BBHA 9120D/ Horn Antenna	296	Biennial	09/23/2011
Agilent	E4440A/Spectrum Analyzer	US45303008	Annual	06/09/2011

FCC CERTIFICATION REPORT			www.hct.co.kr
Test Report No. HCTR1010FFR12-2	Test Dates: November 02, 2010	EUT Type: 3G Module	FCC ID: XHG-M600C



5. SUMMARY OF TEST RESULTS

FCC Part Section(s)	Test Description	Test Limit	Test Condition	Test Result
2.1049, 22.917(a), 24.238(a)	Occupied Bandwidth	N/A	CONDUCTED	PASS
2.1051, 22.917(a), 24.238(a)	Band Edge / Spurious and Harmonic Emissions at Antenna Terminal.	< 43 + 10log ₁₀ (P[Watts]) at Band Edge and for all out-of-band emissions		PASS
2.1046	Conducted Output Power	N/A		PASS
24.232(d),	Peak- to- Average Ratio	< 13 dB		PASS
2.1055, 22.355, 24.235	Frequency stability / variation of ambient temperature	< 2.5 ppm		PASS
22.913(a)(2) 24.232(c)	Effective Radiated Power	< 7 Watts max. ERP	RADIATED	PASS
	Equivalent Isotropic Radiated Power	< 2 Watts max. EIRP(PCS)		PASS
2.1053, 22.917(a), 24.238(a)	Radiated Spurious and Harmonic Emissions	< 43 + 10log ₁₀ (P[Watts]) for all out-of band emissions		PASS

FCC CERTIFICATION REPORT			www.hct.co.kr
Test Report No. HCTR1010FFR12-2	Test Dates: November 02, 2010	EUT Type: 3G Module	FCC ID: XHG-M600C



6. SAMPLE CALCULATION

A. ERP Sample Calculation

Mode	Ch./ Freq.		Measured Level(dBm)	Substitute LEVEL(dBm)	Ant. Gain	C.L	Pol.	ERP	
	channel	Freq.(MHz)						W	dBm
CDMA	384	836.52	-10.96	24.81	2.50	1.19	H	0.41	26.12

ERP = SubstituteLEVEL(dBm) + Ant. Gain – CL(Cable Loss)

- 1) The EUT mounted on a wooden tripod is 0.8 meter above test site ground level.
- 2) During the test , the turn table is rotated and the antenna height is also varied from 1 to 4 meters until the maximum signal is found.
- 3) Record the field strength meter's level.
- 4) Replace the EUT with dipole/Horn antenna that is connected to a calibrated signal generator.
- 5) Increase the signal generator output till the field strength meter's level is equal to the item (3).
- 6) The signal generator output level with Ant. Gain and cable loss are the rating of effective radiated power (ERP).

B. Emission Designator

CDMA Emission Designator

Emission Designator = 1M27F9W

CDMA BW = 1.27 MHz (Measured at the 99% power bandwidth)

F = Frequency Modulation

9 = Composite Digital Info

W = Combination (Audio/Data)

FCC CERTIFICATION REPORT			www.hct.co.kr
Test Report No. HCTR1010FFR12-2	Test Dates: November 02, 2010	EUT Type: 3G Module	FCC ID: XHG-M600C

7. TEST DATA

7.1 CONDUCTED OUTPUT POWER

A base station simulator was used to establish communication with The EUT. The base station simulator parameters were set to produce the maximum power from the EUT. This device was tested under all configurations and the highest power is reported. Conducted Output Powers of EUT are reported below.

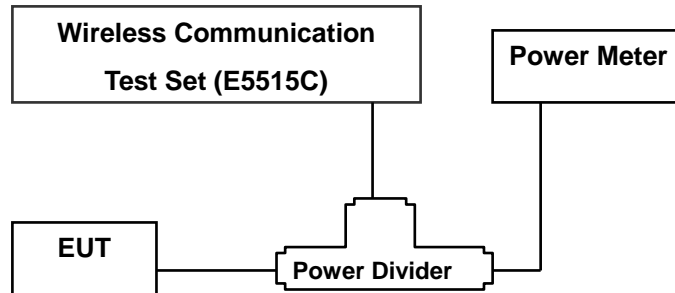

Band	Channel	SO2	SO2	SO55	SO55	TDSO	1xEvD	1xEvD	1xEvDO	1xEvDO
		RC1/1 (dBm)	RC3/3 (dBm)	RC1/1 (dBm)	RC3/3 (dBm)	SO32 (dBm)	Rev.O (FTAP)	Rev.O (RTAP)	Rev.1 (FETAP)	Rev.1 (RETAP)
CDMA	1013	24.05	24.01	24.02	23.94	24.03	24.08	24.05	24.04	23.98
	384	23.90	23.89	23.85	23.89	23.88	24.04	24.02	23.86	23.91
	777	23.79	23.82	23.83	23.94	23.87	23.94	23.98	23.98	23.78
PCS	25	23.87	23.86	23.88	23.96	23.89	24.06	23.97	23.98	23.83
	600	23.63	23.58	23.59	23.67	23.60	23.75	23.58	23.70	23.56
	1175	23.93	23.90	23.91	23.94	23.92	23.95	23.92	23.92	23.76

(Maximum Conducted Output Powers)

Note : Detecting mode is average.

7.2 PEAK-TO-AVERAGE RATIO

- Plots of the EUT's Peak- to- Average Ratio are shown Page 26.



7.2 OCCUPIED BANDWIDTH

Band	Channel	Frequency(MHz)	Data (MHz)
CDMA	1013	824.70	1.2738
	384	836.52	1.2760
	777	848.31	1.2769
CDMA EVDO	777	848.31	1.2735
PCS	25	1851.25	1.2786
	600	1880.00	1.2825
	1175	1908.75	1.2817
PCS EVDO	600	1880.00	1.2763

- Plots of the EUT's Occupied Bandwidth are shown Page 22 ~ 25.

7.3 CONDUCTED SPURIOUS EMISSIONS

Band	Channel	Frequency of Maximum Harmonic (GHz)	Maximum Data (dBm)
CDMA	1013	1.6520	-36.01
	384	1.6730	-33.51
	777	1.6970	-34.45
PCS	25	3.7020	-20.84
	600	3.7620	-23.67
	1175	3.8150	-30.02

- Plots of the EUT's Conducted Spurious Emissions are shown Page 34 ~ 40.

7.3.1 BAND EDGE

- Plots of the EUT's Band Edge are shown Page 26 ~ 34.

FCC CERTIFICATION REPORT			www.hct.co.kr
Test Report No. HCTR1010FFR12-2	Test Dates: November 02, 2010	EUT Type: 3G Module	FCC ID: XHG-M600C



7.4 RADIATED SPURIOUS EMISSIONS

7.4.1 RADIATED SPURIOUS EMISSIONS(CDMA MODE)

- MEASURED OUTPUT POWER: 27.67 dBm = 0.585 W
- MODULATION SIGNAL: CDMA EVDO
- DISTANCE: 3 meters
- LIMIT: $-(43 + 10 \log_{10}(W)) =$ - 40.67 dBc

Ch.	Freq.(MHz)	Measured Level [dBm]	Ant. Gain	Substitute Level [dBm]	C.L	Pol.	ERP (dBm)	dBc
1013	1,649.40	-31.97	7.09	-42.50	1.73	H	-37.14	-64.48
	2,474.10	-	-	-	-	-	-	-
	3,298.80	-	-	-	-	-	-	-
384	1,673.04	-30.87	7.23	-41.63	1.79	H	-36.19	-63.53
	2,509.56	-	-	-	-	-	-	-
	3,346.08	-49.74	9.99	-57.77	2.66	V	-50.44	-77.78
777	1,696.62	-35.43	7.41	-46.04	1.83	V	-40.46	-67.80
	2,544.93	-	-	-	-	-	-	-
	3,393.24	-46.84	9.91	-54.47	2.85	V	-47.41	-74.75

- NOTES:**
1. Radiated Spurious Emission Measurements at 3 meters by Substitution Method according to ANSI/TIA/EIA-603-C-2004, Aug. 17, 2004:
 2. The magnitude of spurious emissions attenuated more than 20dB below the limit above 5th Harmonic for all channel.
 3. we have done x, y, z planes in EUT and horizontal and vertical polarization in detecting antenna.

FCC CERTIFICATION REPORT			www.hct.co.kr
Test Report No. HCTR1010FFR12-2	Test Dates: November 02, 2010	EUT Type: 3G Module	FCC ID: XHG-M600C



7.4.2 RADIATED SPURIOUS EMISSIONS(PCS CDMA MODE)

- MEASURED OUTPUT POWER: 27.59 dBm = 0.574 W
- MODULATION SIGNAL: PCS CDMA EVDO
- DISTANCE: 3 meters
- LIMIT: - (43 + 10 log₁₀(W)) = - 40.59 dBc

Ch.	Freq.(MHz)	Measured Level [dBm]	Ant. Gain	Substitute Level [dBm]	C.L	Pol.	EIRP (dBm)	dBc
25	3,702.50	-35.79	12.46	-42.06	2.73	H	-32.33	-59.15
	5,553.75	-	-	-	-	-	-	-
	7,405.00	-	-	-	-	-	-	-
600	3,760.00	-26.37	12.47	-32.34	2.73	H	-22.60	-49.42
	5,640.00	-	-	-	-	-	-	-
	7,520.00	-	-	-	-	-	-	-
1175	3,817.50	-36.99	12.49	-42.87	2.73	H	-33.11	-59.93
	5,726.25	-	-	-	-	-	-	-
	7,635.00	-	-	-	-	-	-	-

- NOTES:**
1. Radiated Spurious Emission Measurements at 3 meters by Substitution Method according to ANSI/TIA/EIA-603-C-2004, Aug. 17, 2004:
 2. The magnitude of spurious emissions attenuated more than 20dB below the limit above 5th Harmonic for all channel.
 3. we have done x, y, z planes in EUT and horizontal and vertical polarization in detecting antenna.

FCC CERTIFICATION REPORT			www.hct.co.kr
Test Report No. HCTR1010FFR12-2	Test Dates: November 02, 2010	EUT Type: 3G Module	FCC ID: XHG-M600C



7.5 FREQUENCY STABILITY / VARIATION OF AMBIENT TEMPERATURE

7.5.1 FREQUENCY STABILITY (CDMA)

OPERATING FREQUENCY: 836,520,000 Hz
 CHANNEL: 384
 REFERENCE VOLTAGE: 3.7 VDC
 DEVIATION LIM IT: ± 0.000 25 % or 2.5 ppm

Voltage (%)	Power (VDC)	Temp. (°C)	Frequency (Hz)	Frequency Error (Hz)	Deviation (%)	ppm
100%	5.00	+20(Ref)	836 520 003	0	0.000 000	0.000
100%		-30	836 520 002	2.09	0.000 000	0.002
100%		-20	836 520 006	6.12	0.000 001	0.007
100%		-10	836 519 990	-9.88	-0.000 001	-0.012
100%		0	836 520 002	1.90	0.000 000	0.002
100%		+10	836 520 007	7.43	0.000 001	0.009
100%		+30	836 519 990	-10.42	-0.000 001	-0.012
100%		+40	836 519 996	-4.10	0.000 000	-0.005
100%		+50	836 520 003	2.52	0.000 000	0.003
115%		5.75	+20	836 520 005	4.98	0.000 001
Batt. Endpoint	4.25	+20	836 520 011	11.37	0.000 001	0.014

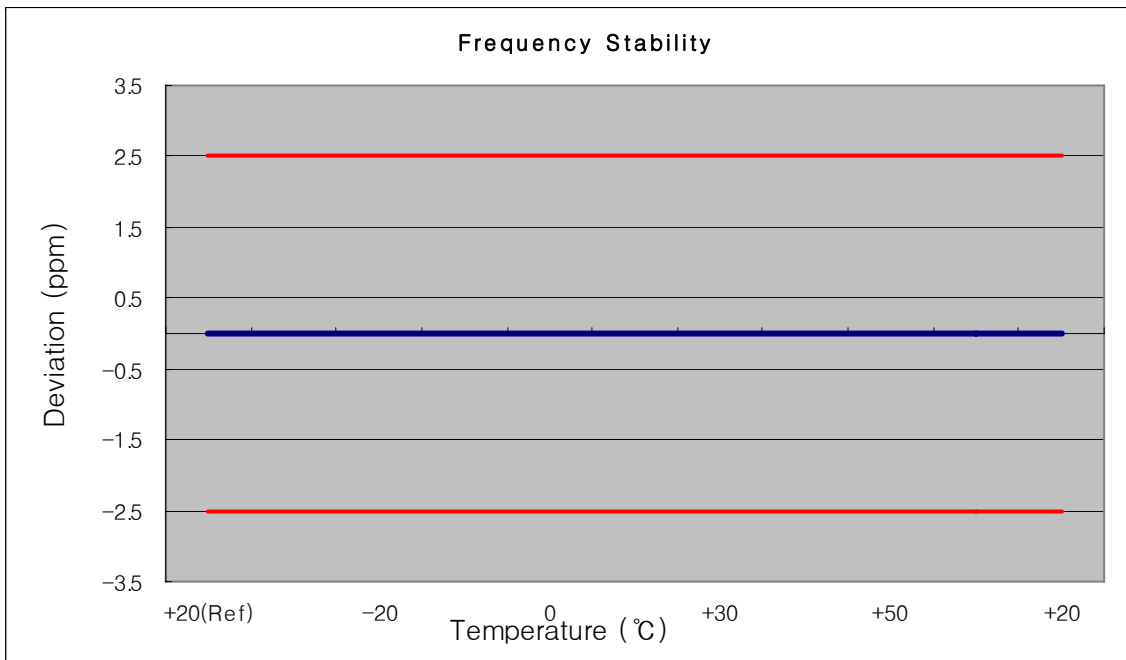



7.5.2 FREQUENCY STABILITY (PCS CDMA)

OPERATING FREQUENCY: 1880,000,000 Hz
 CHANNEL: 600
 REFERENCE VOLTAGE: 3.7 VDC
 DEVIATION LIM IT: ± 0.000 25 % or 2.5 ppm

Voltage (%)	Power (VDC)	Temp. (°C)	Frequency (Hz)	Frequency Error (Hz)	Deviation (%)	ppm
100%	5.00	+20(Ref)	1879 999 995	0	0.000 000	0.000
100%		-30	1880 000 006	6.30	0.000 000	0.003
100%		-20	1880 000 001	0.97	0.000 000	0.001
100%		-10	1879 999 998	-1.57	0.000 000	-0.001
100%		0	1879 999 997	-2.77	0.000 000	-0.001
100%		+10	1880 000 011	10.61	0.000 001	0.006
100%		+30	1880 000 003	3.11	0.000 000	0.002
100%		+40	1880 000 005	5.02	0.000 000	0.003
100%		+50	1879 999 992	-8.10	0.000 000	-0.004
115%	5.75	+20	1879 999 998	-2.17	0.000 000	-0.001
Batt. Endpoint	4.25	+20	1880 000 002	1.76	0.000 000	0.001

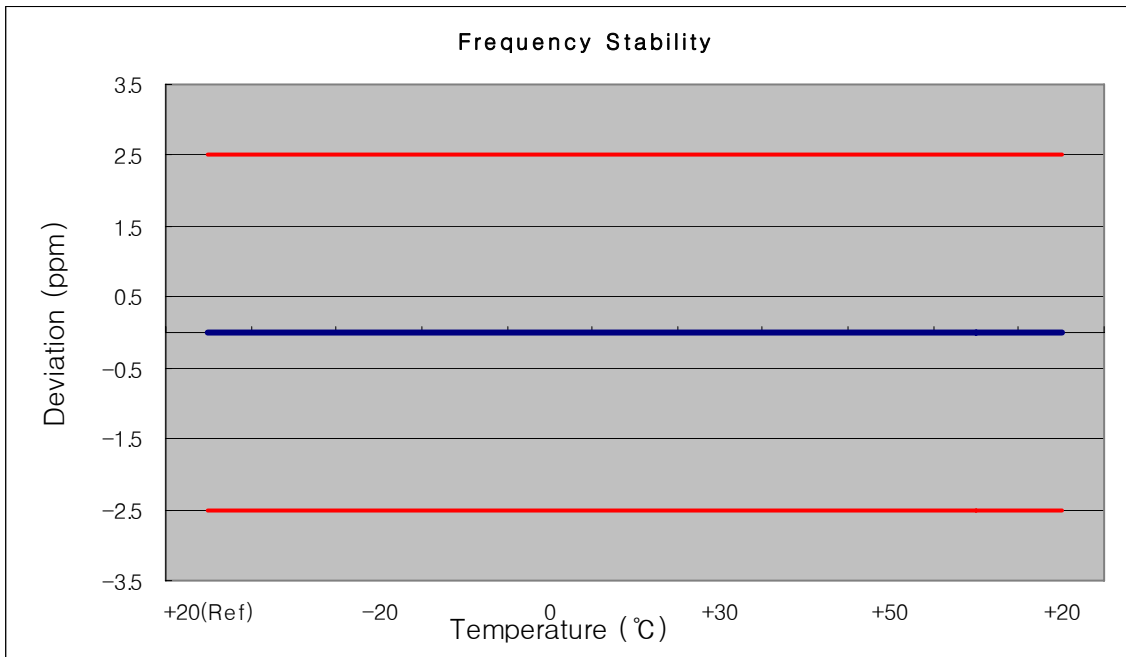



8. TEST PLOTS

FCC CERTIFICATION REPORT			www.hct.co.kr
Test Report No. HCTR1010FFR12-2	Test Dates: November 02, 2010	EUT Type: 3G Module	FCC ID: XHG-M600C

■ CDMA MODE (1013 CH.) Occupied Bandwidth

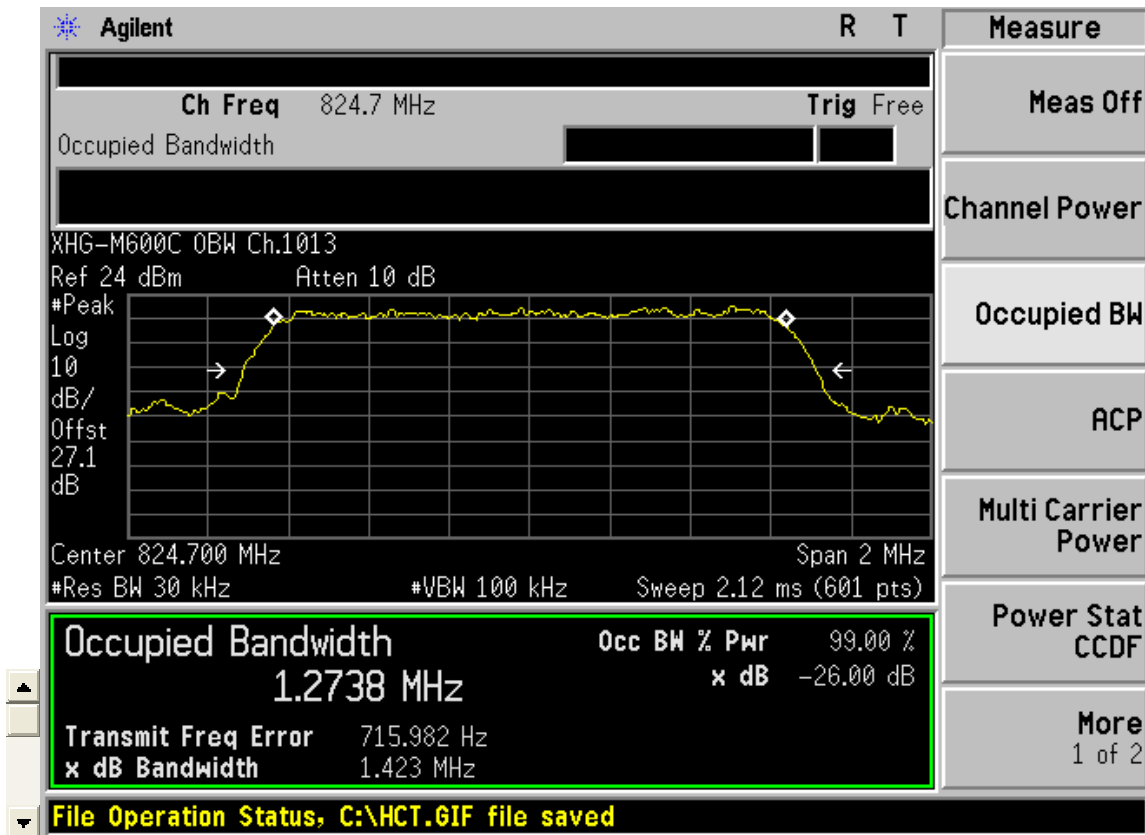

■ CDMA MODE (384 CH.) Occupied Bandwidth

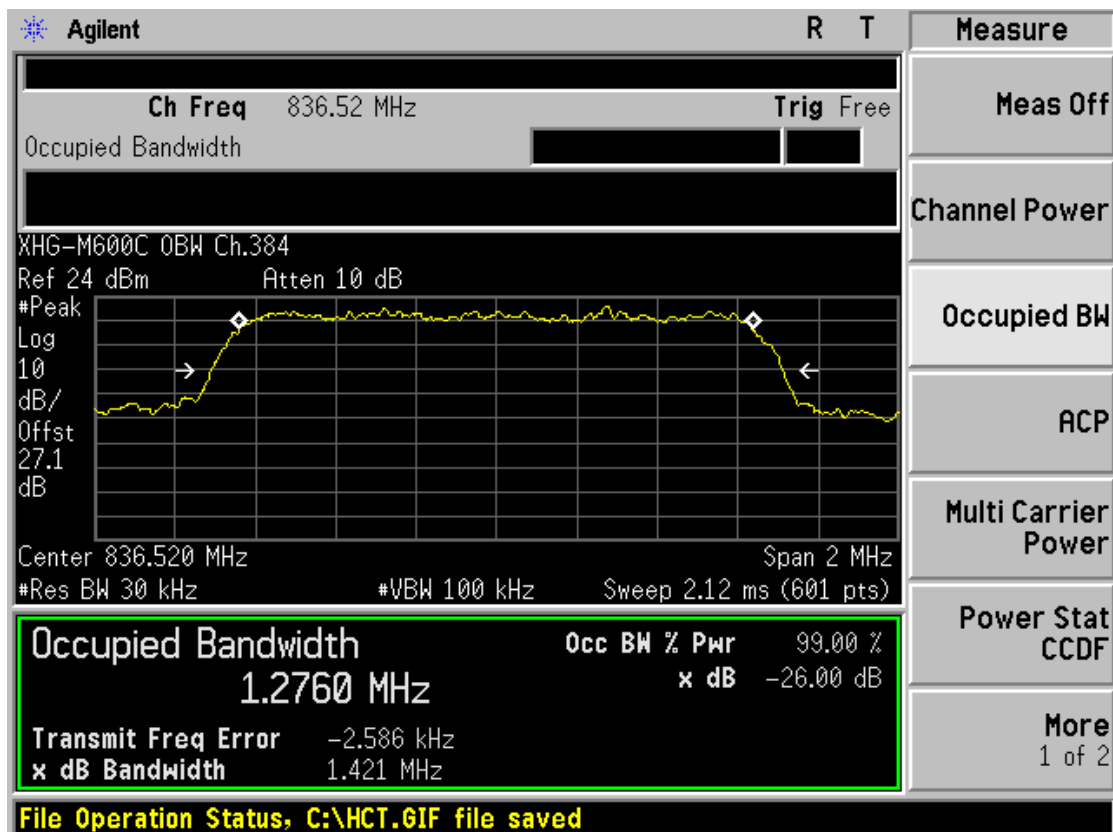



■ CDMA MODE (777 CH.) Occupied Bandwidth

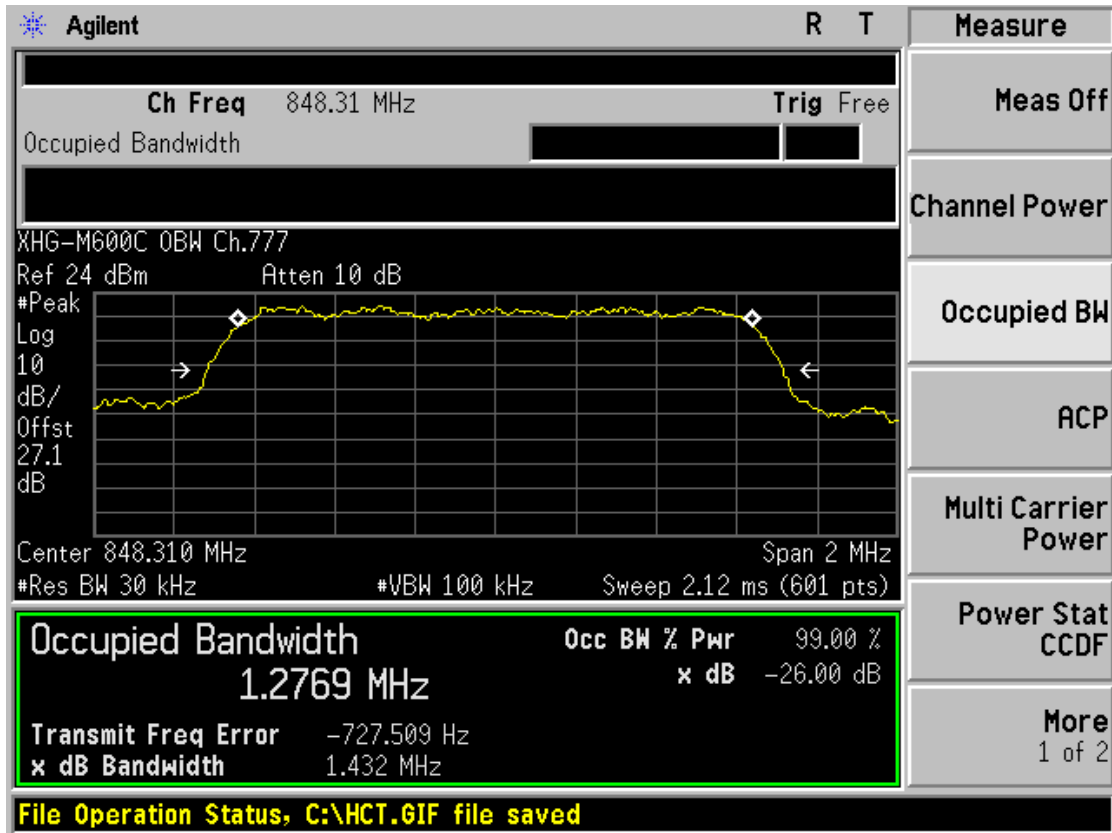

■ CDMA EVDO MODE (777 CH.) Occupied Bandwidth

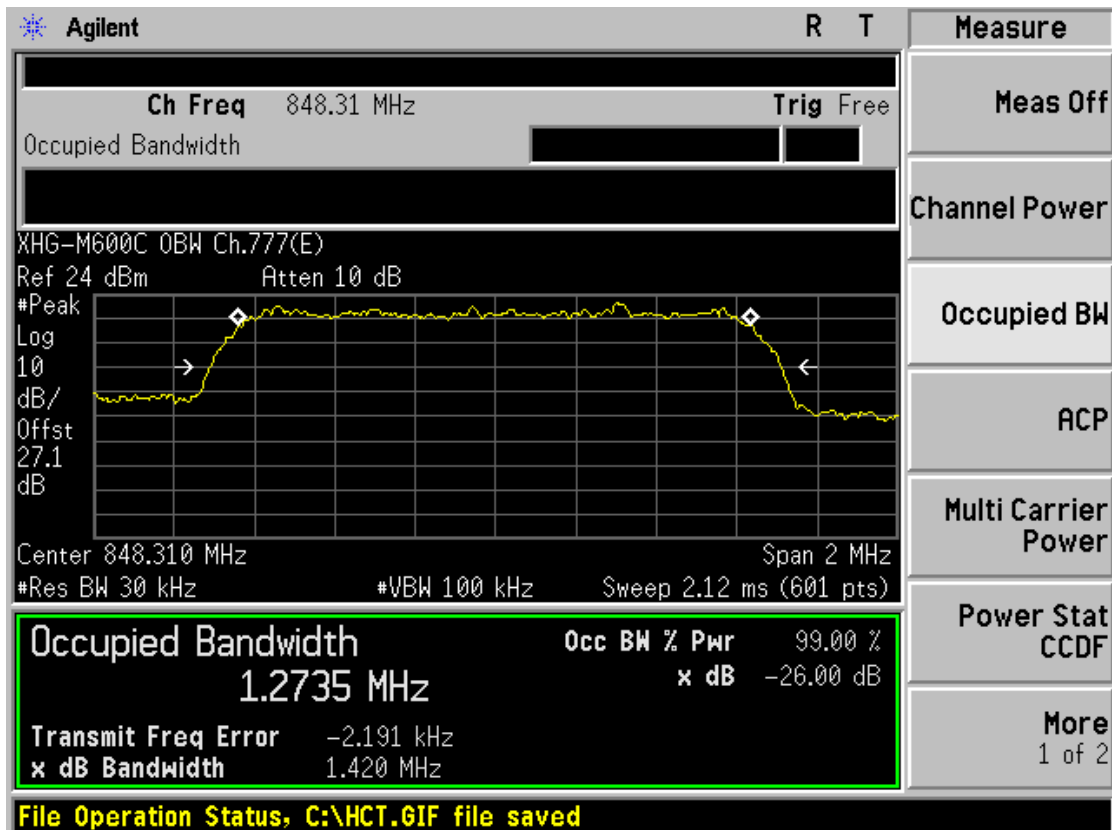

FCC CERTIFICATION REPORT			www.hct.co.kr
Test Report No. HCTR1010FFR12-2	Test Dates: November 02, 2010	EUT Type: 3G Module	FCC ID: XHG-M600C



■ PCS CDMA MODE (25 CH.) Occupied Bandwidth

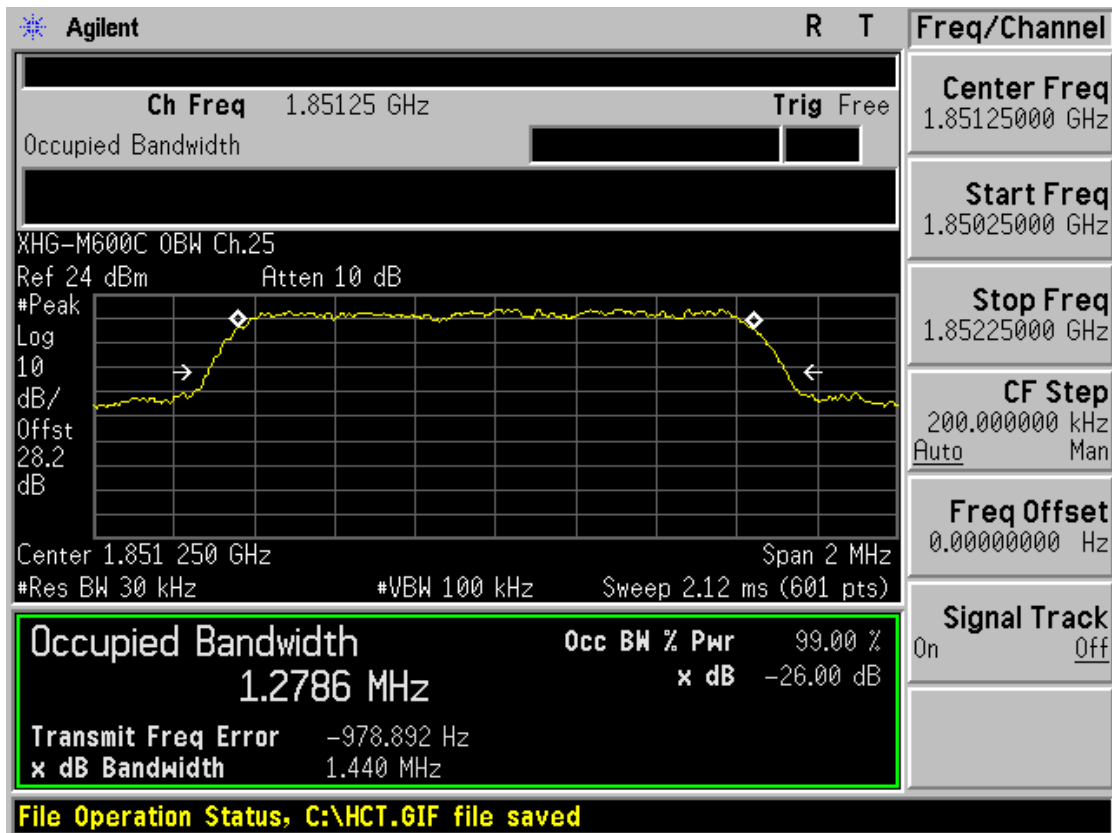

■ PCS CDMA MODE (600 CH.) Occupied Bandwidth

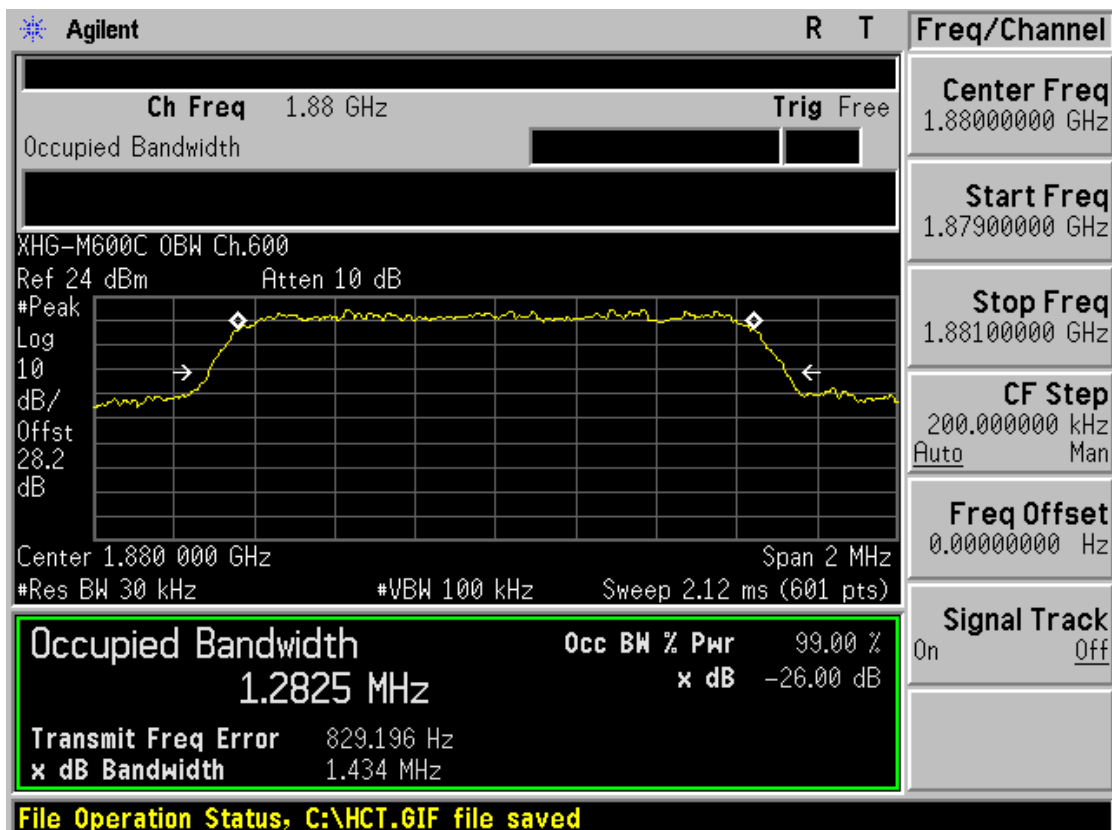

FCC CERTIFICATION REPORT			www.hct.co.kr
Test Report No. HCTR1010FFR12-2	Test Dates: November 02, 2010	EUT Type: 3G Module	FCC ID: XHG-M600C



■ PCS CDMA MODE (1175 CH.) Occupied Bandwidth

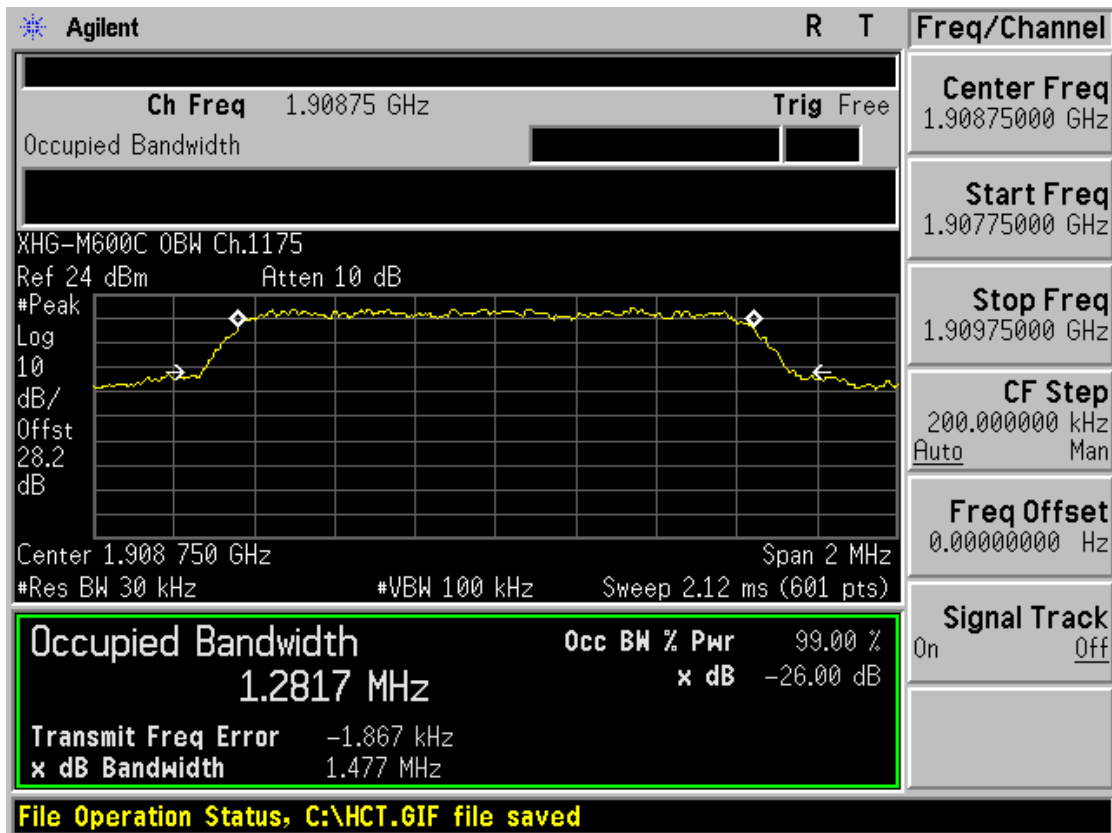

■ PCS CDMA EVDO MODE (600 CH.) Occupied Bandwidth

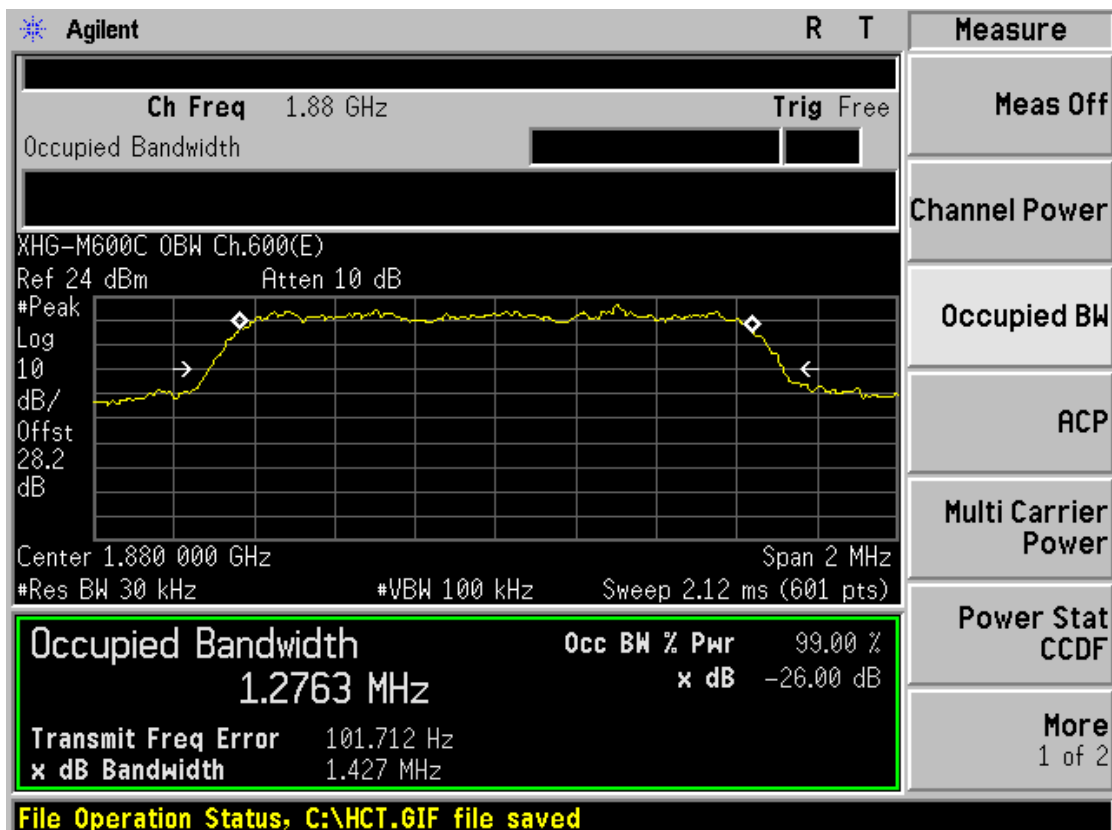

FCC CERTIFICATION REPORT			www.hct.co.kr
Test Report No. HCTR1010FFR12-2	Test Dates: November 02, 2010	EUT Type: 3G Module	FCC ID: XHG-M600C



■ PCS CDMA MODE (600 CH.) Peak-to-Average Ratio

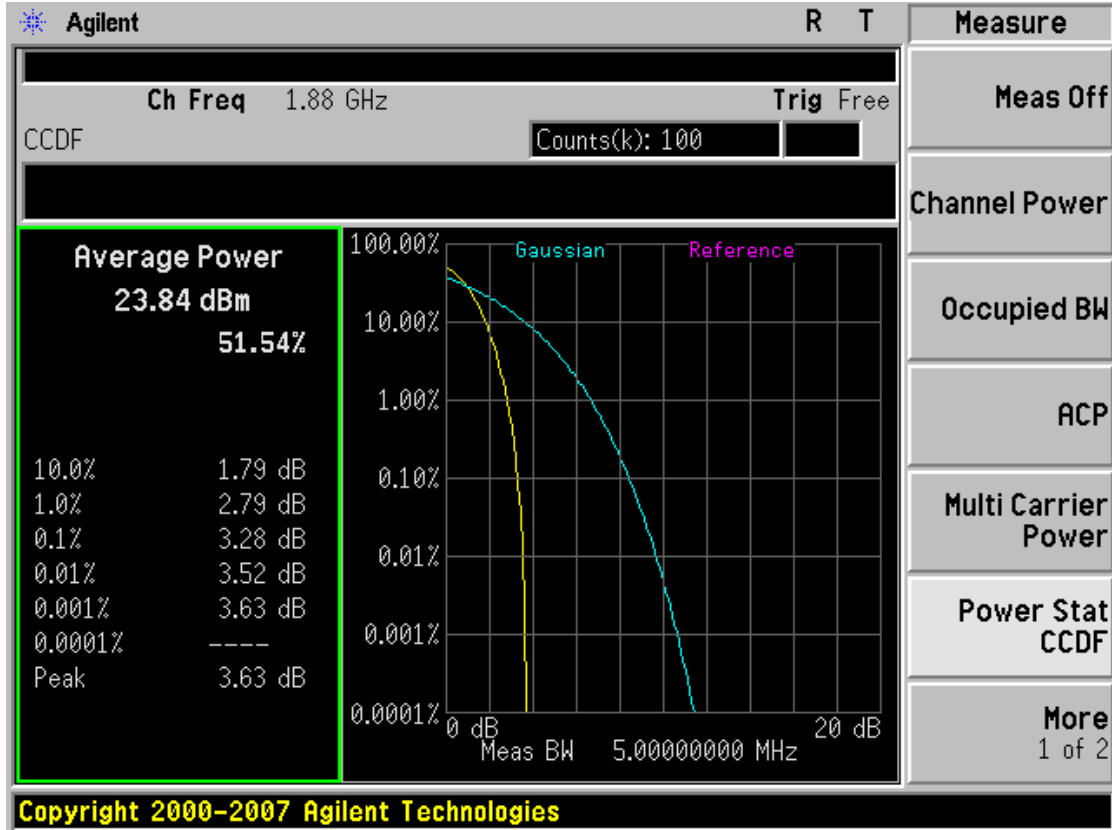

■ CDMA MODE (1013 CH.) Band Edge



FCC CERTIFICATION REPORT			www.hct.co.kr
Test Report No. HCTR1010FFR12-2	Test Dates: November 02, 2010	EUT Type: 3G Module	FCC ID: XHG-M600C



■ CDMA MODE (777 CH.) Band Edge



■ CDMA EVDO MODE (1013 CH.) Band Edge

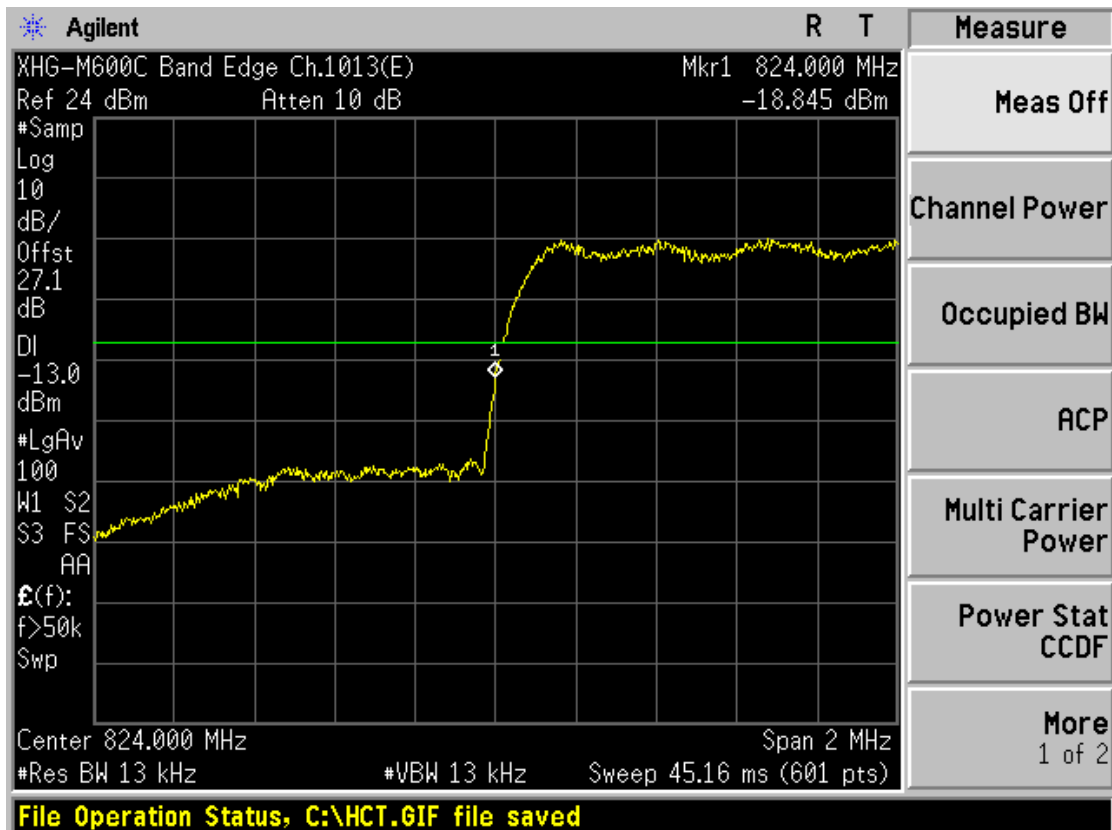

FCC CERTIFICATION REPORT			www.hct.co.kr
Test Report No. HCTR1010FFR12-2	Test Dates: November 02, 2010	EUT Type: 3G Module	FCC ID: XHG-M600C

■ CDMA EVDO MODE (777 CH.) Band Edge

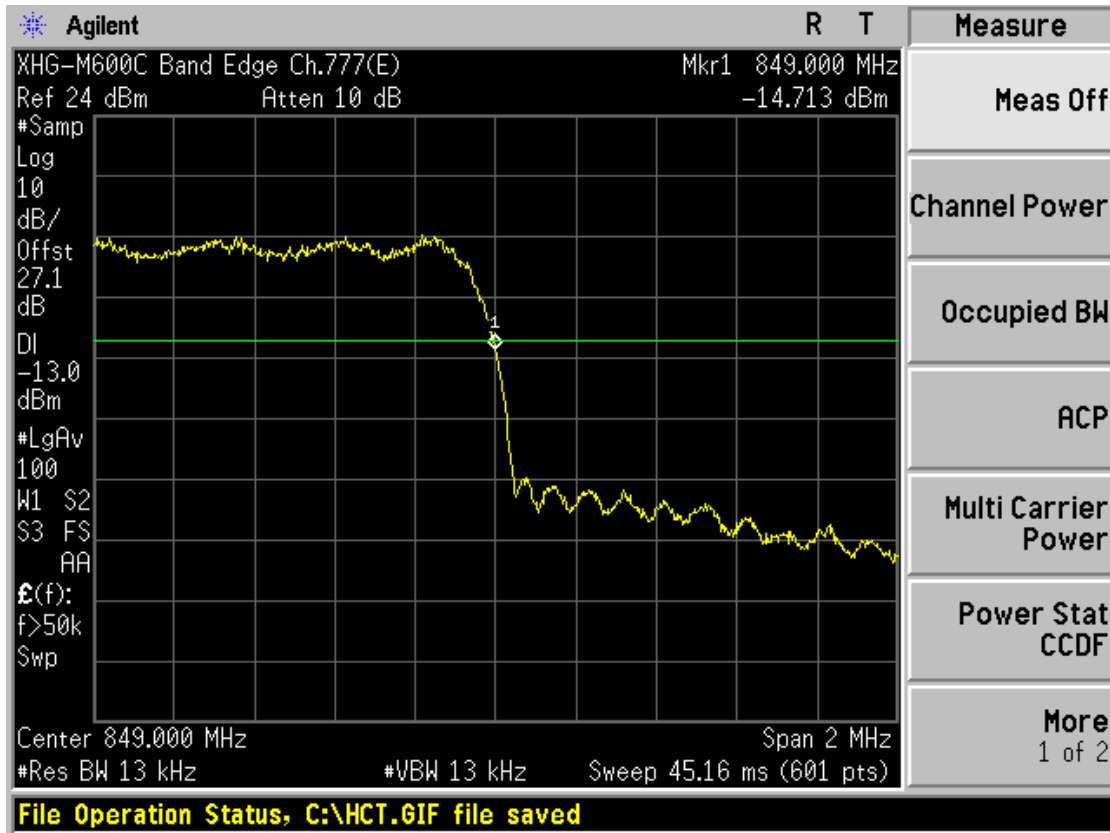

■ CDMA MODE (1013 CH.) 4 MHz Span

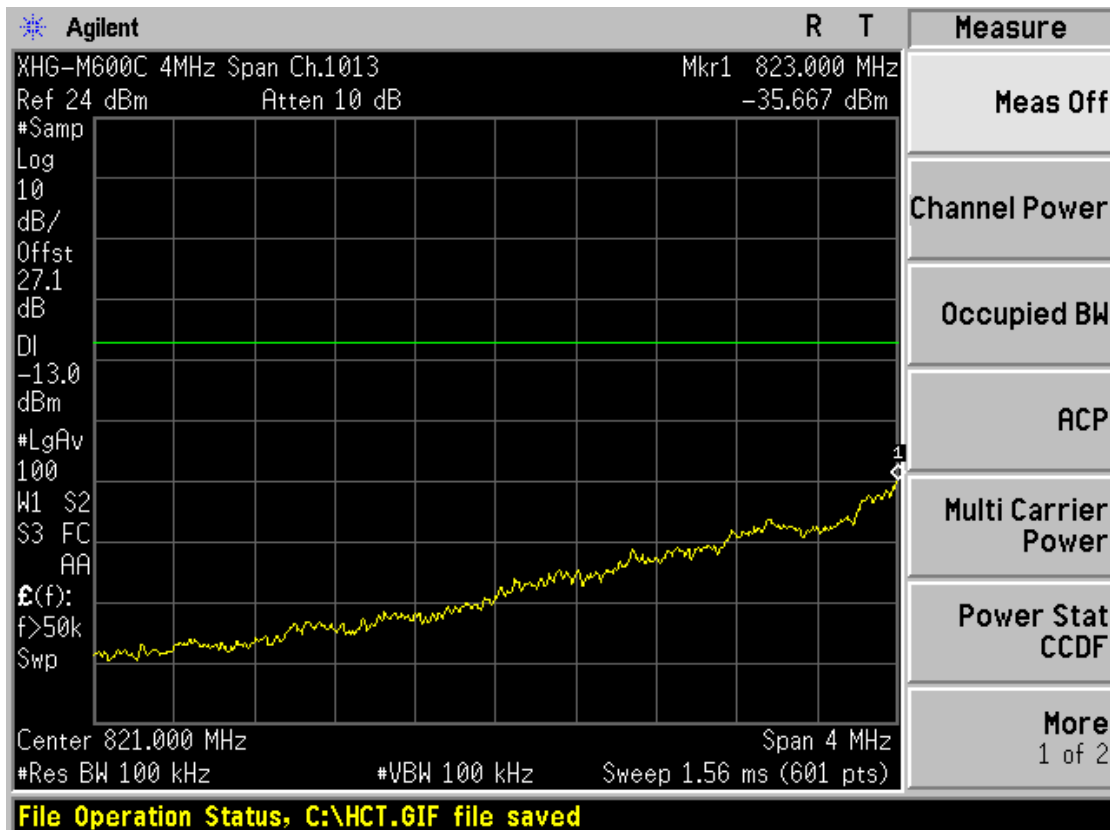

FCC CERTIFICATION REPORT			www.hct.co.kr
Test Report No. HCTR1010FFR12-2	Test Dates: November 02, 2010	EUT Type: 3G Module	FCC ID: XHG-M600C



■ CDMA MODE (777 CH.) 4 MHz Span

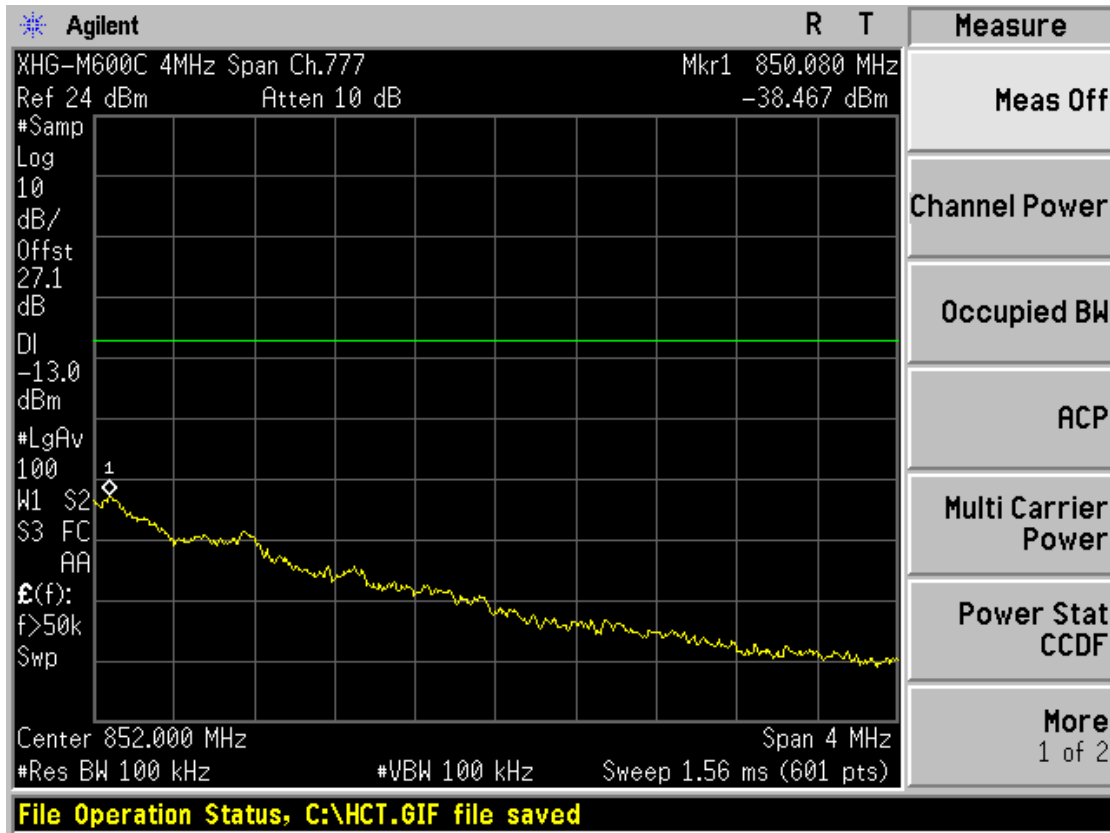

■ CDMA EVDO MODE (1013 CH.) 4 MHz Span

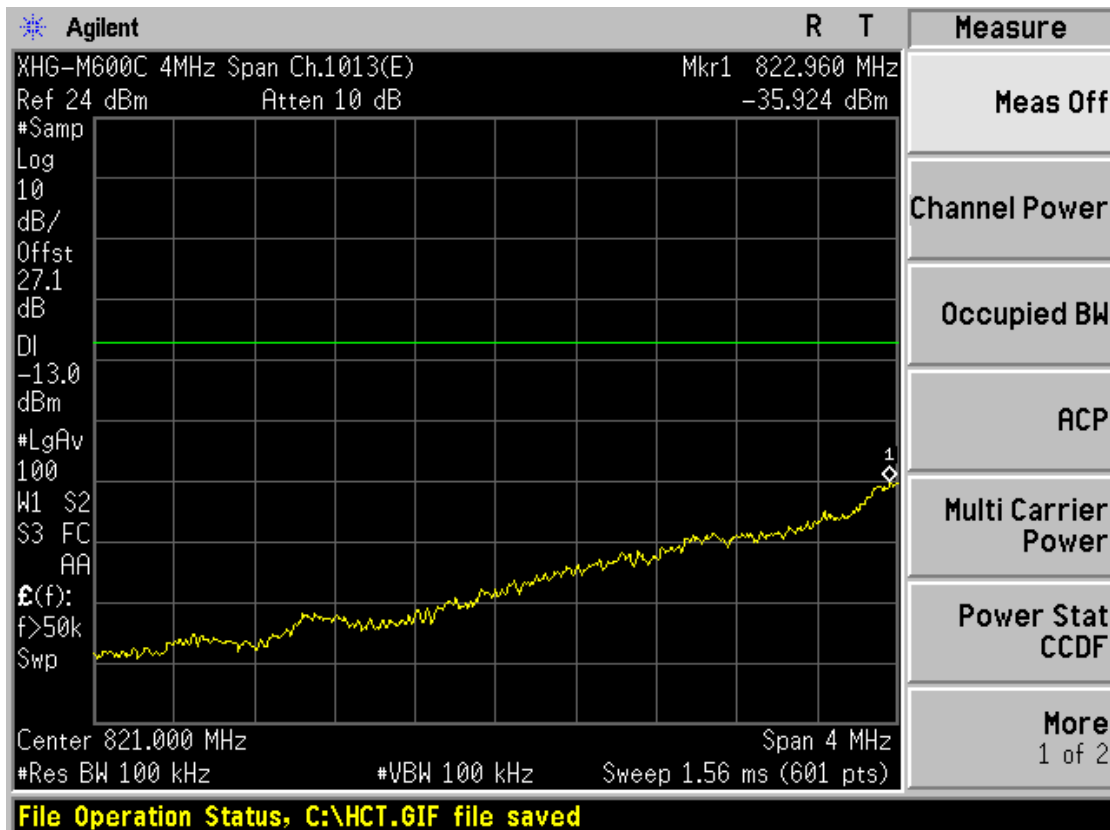

FCC CERTIFICATION REPORT			www.hct.co.kr
Test Report No. HCTR1010FFR12-2	Test Dates: November 02, 2010	EUT Type: 3G Module	FCC ID: XHG-M600C

■ CDMA EVDO MODE (777 CH.) 4 MHz Span

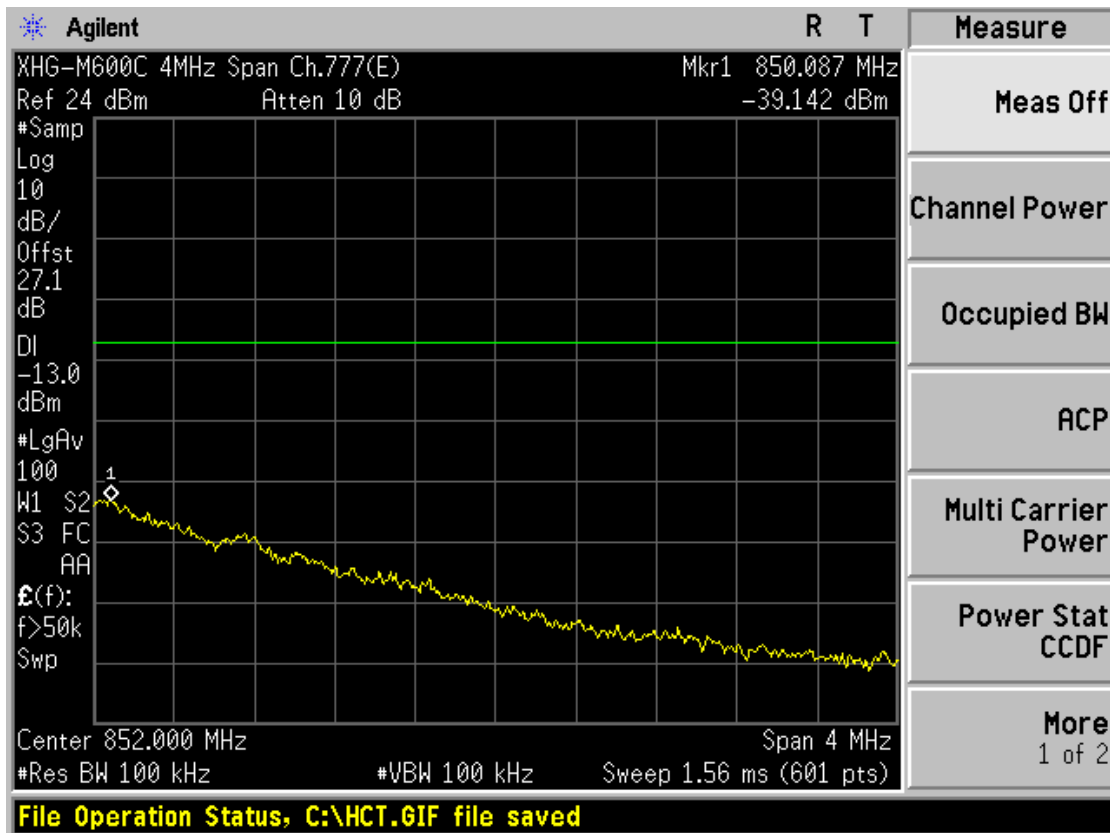

■ PCS CDMA MODE (25 CH.) Band Edge

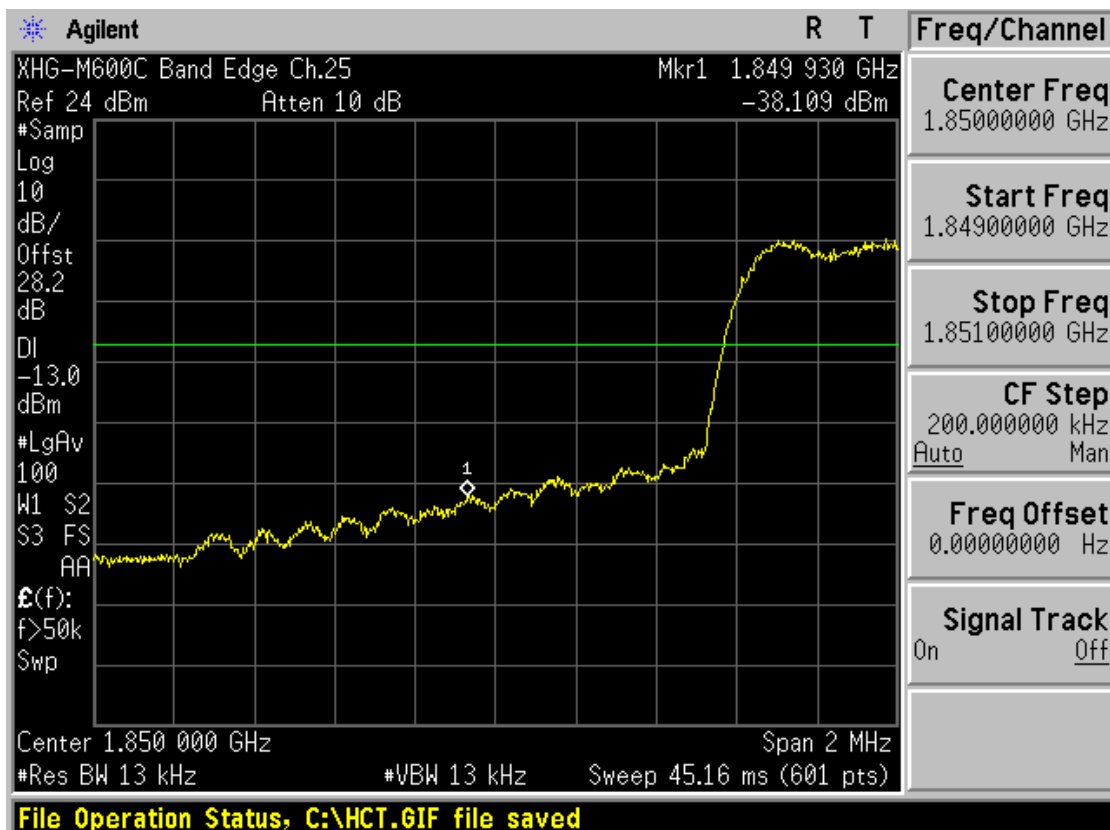

FCC CERTIFICATION REPORT			www.hct.co.kr
Test Report No. HCTR1010FFR12-2	Test Dates: November 02, 2010	EUT Type: 3G Module	FCC ID: XHG-M600C



■ PCS CDMA MODE (1175 CH.) Band Edge



■ PCS CDMA EVDO MODE (25 CH.) Band Edge

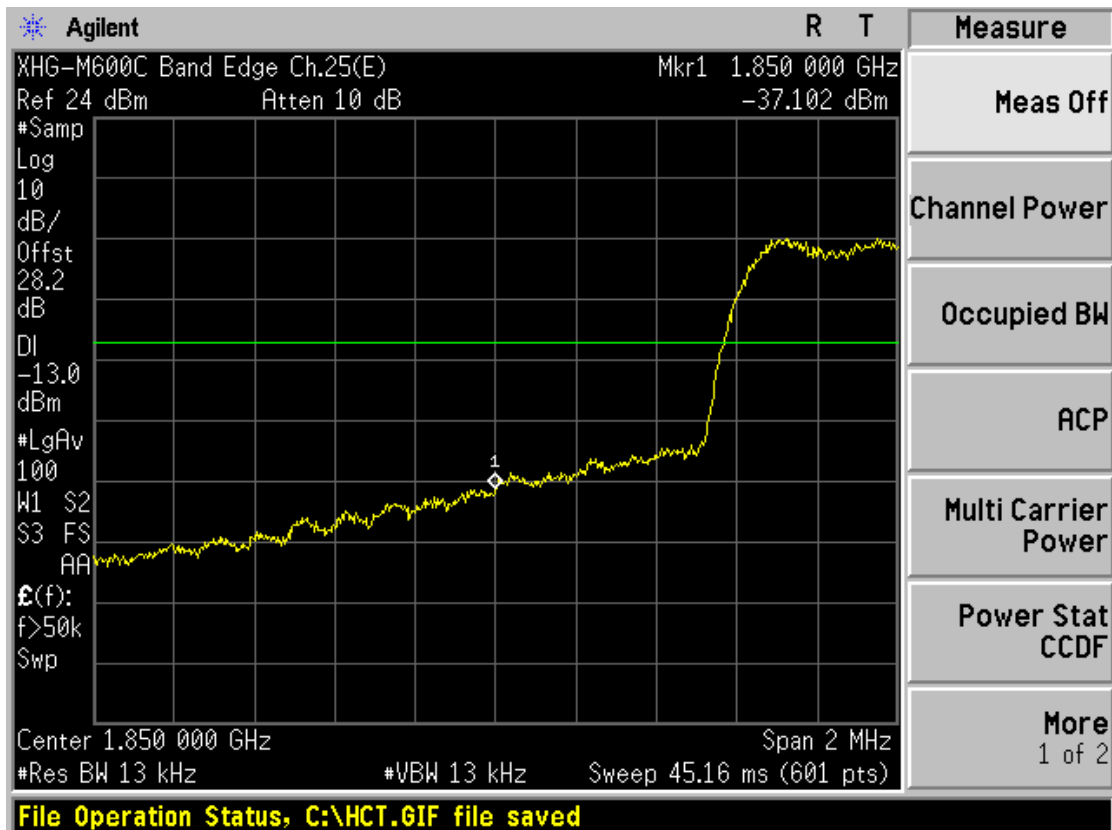

FCC CERTIFICATION REPORT			www.hct.co.kr
Test Report No. HCTR1010FFR12-2	Test Dates: November 02, 2010	EUT Type: 3G Module	FCC ID: XHG-M600C



■ PCS CDMA EVDO MODE (1175 CH.) Band Edge

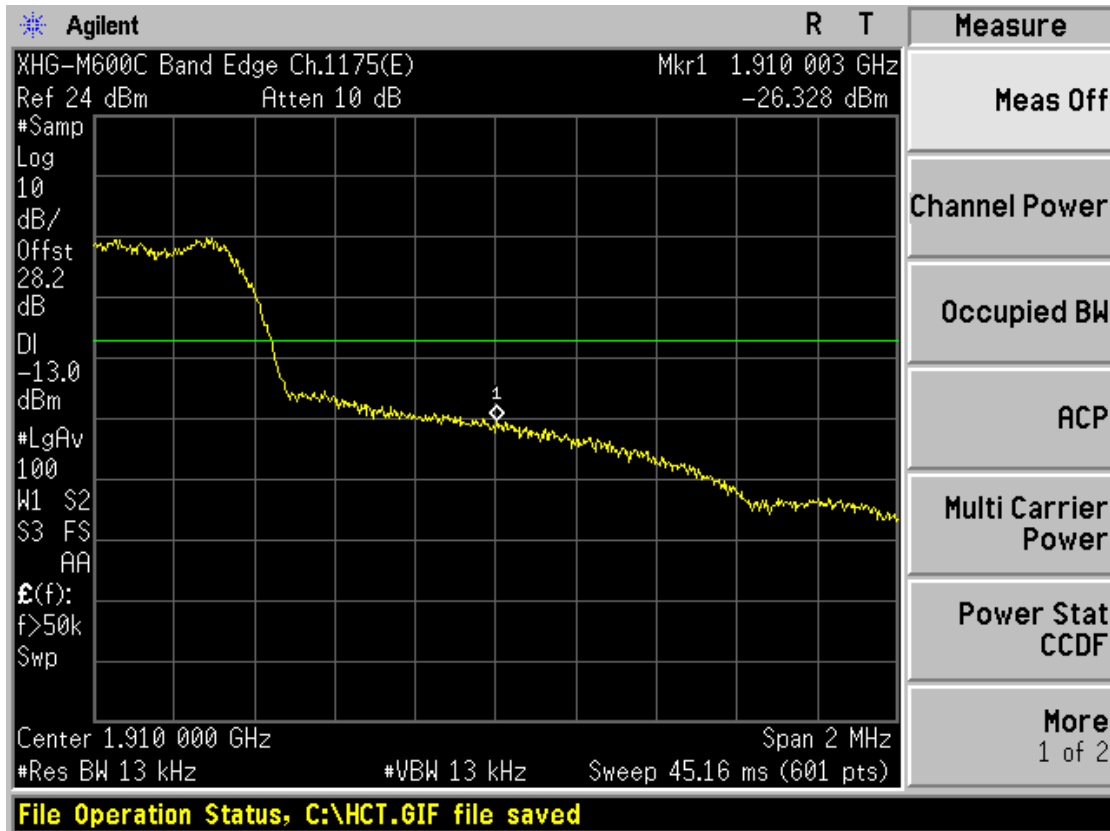

■ PCS CDMA MODE (25 CH.) 4 MHz Span

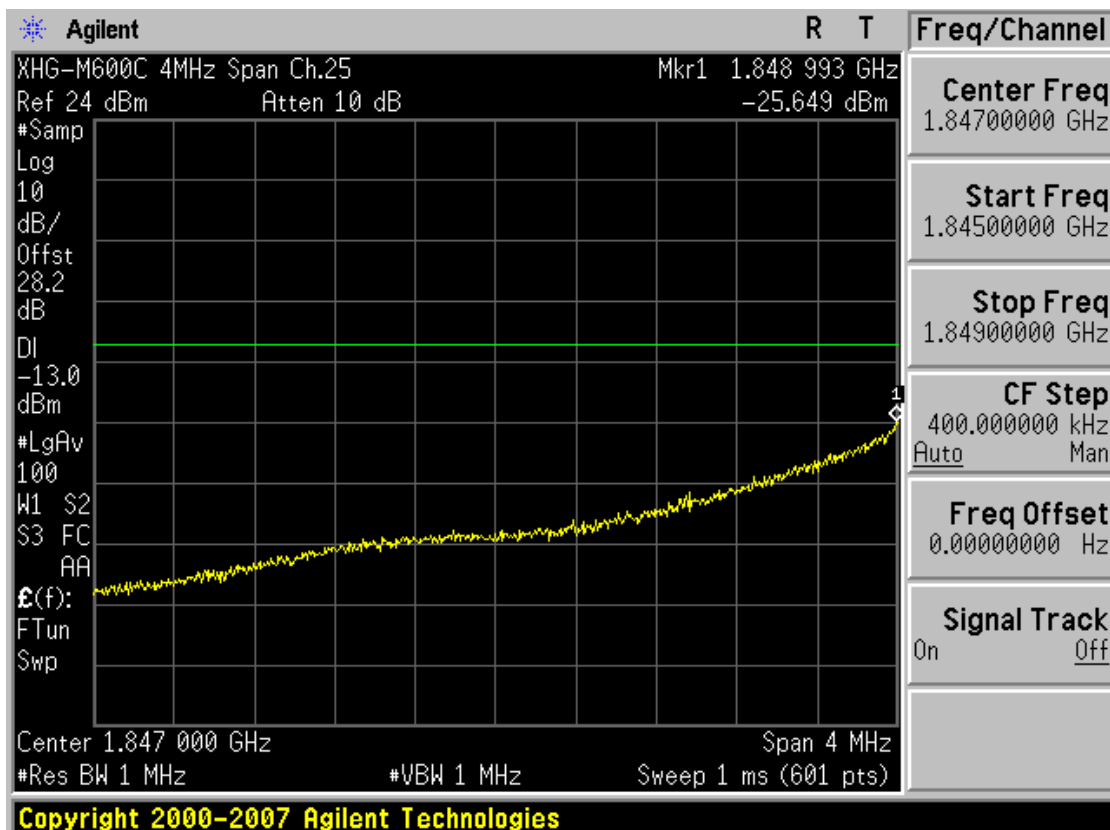

FCC CERTIFICATION REPORT			www.hct.co.kr
Test Report No. HCTR1010FFR12-2	Test Dates: November 02, 2010	EUT Type: 3G Module	FCC ID: XHG-M600C



■ PCS CDMA MODE (1175 CH.) 4 MHz Span

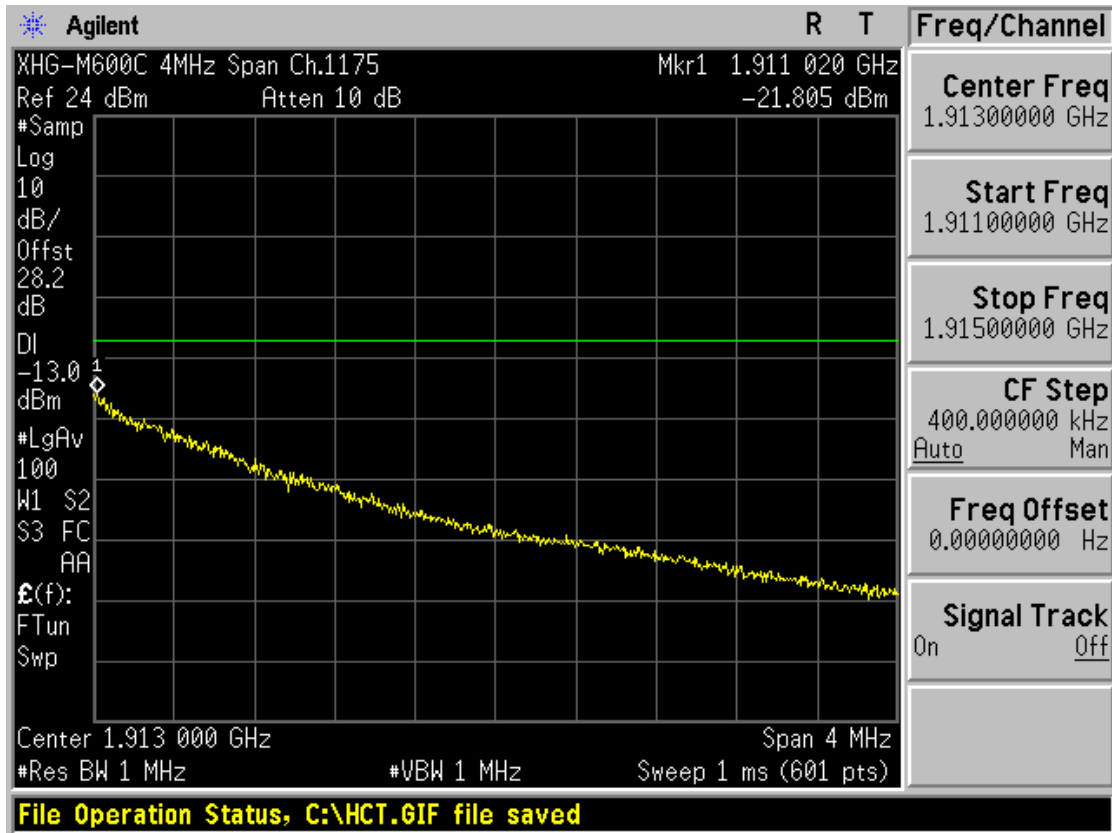

■ PCS CDMA EVDO MODE (25 CH.) 4 MHz Span

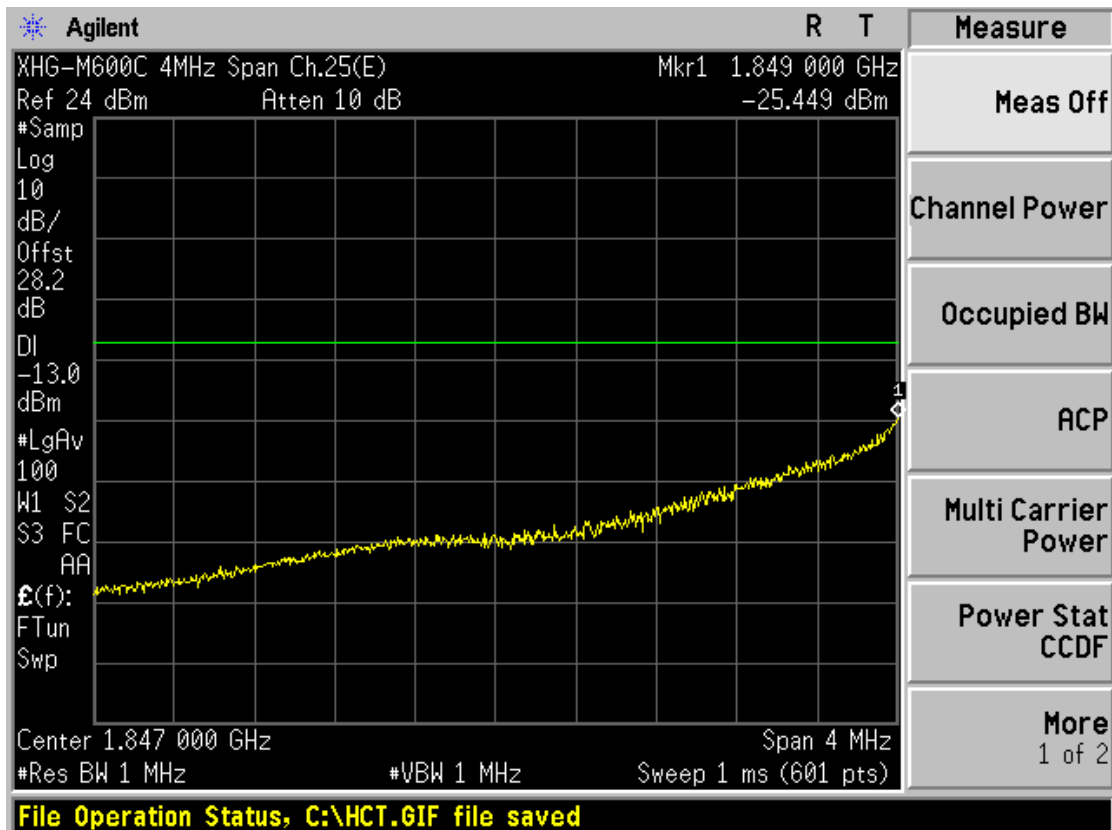

FCC CERTIFICATION REPORT			www.hct.co.kr
Test Report No. HCTR1010FFR12-2	Test Dates: November 02, 2010	EUT Type: 3G Module	FCC ID: XHG-M600C



■ PCS CDMA EVDO MODE (1175 CH.) 4 MHz Span

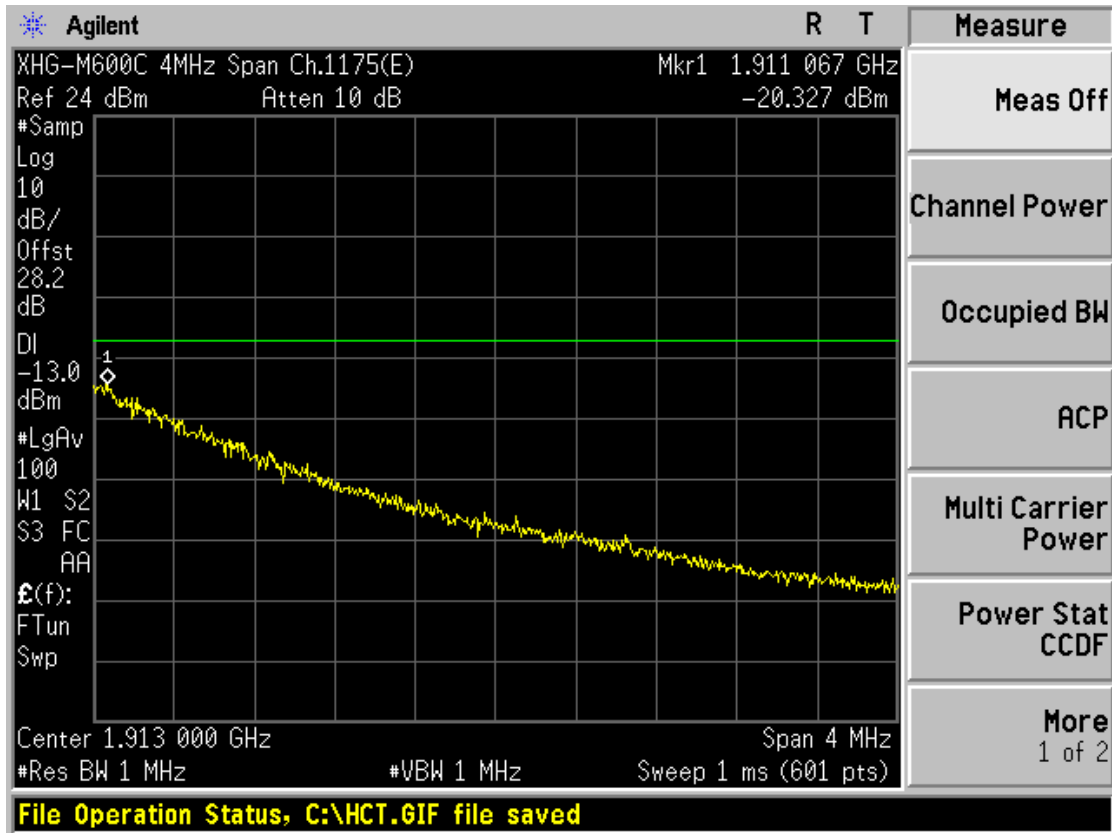

■ CDMA MODE (1013 CH.) Conducted Spurious Emissions - 1

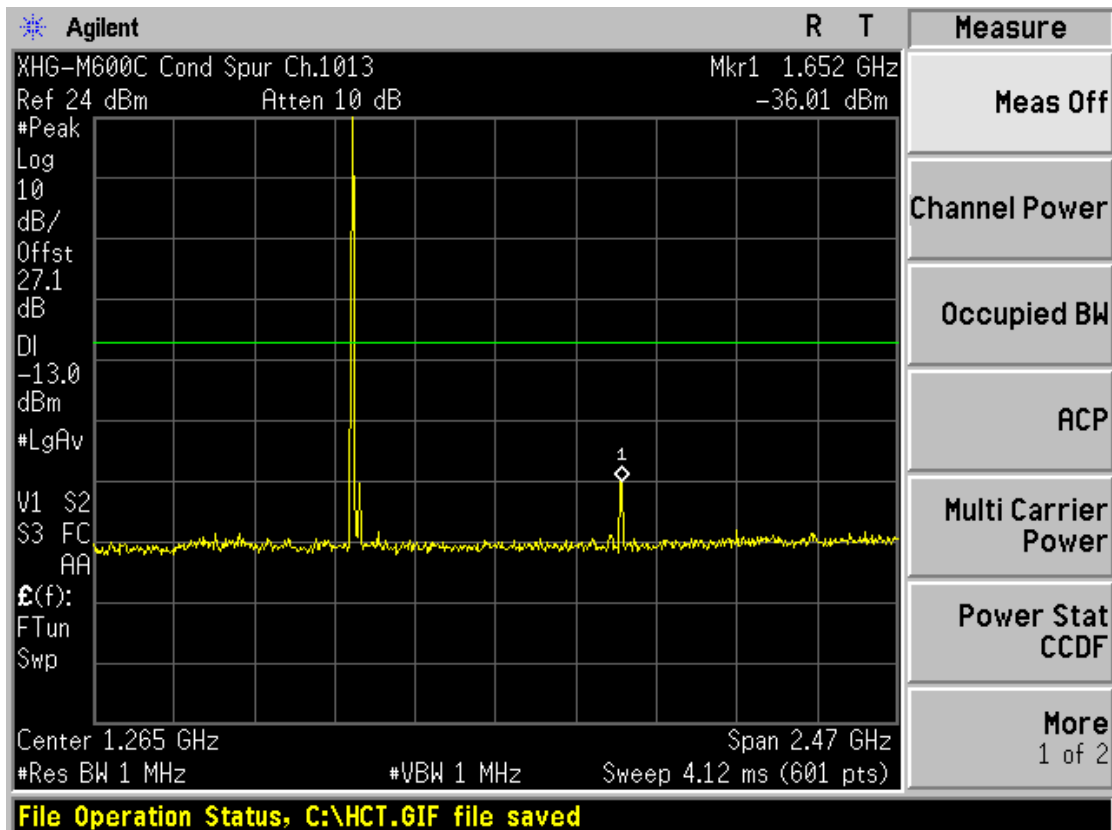

FCC CERTIFICATION REPORT			www.hct.co.kr
Test Report No. HCTR1010FFR12-2	Test Dates: November 02, 2010	EUT Type: 3G Module	FCC ID: XHG-M600C



■ CDMA MODE (1013 CH.) Conducted Spurious Emissions - 2

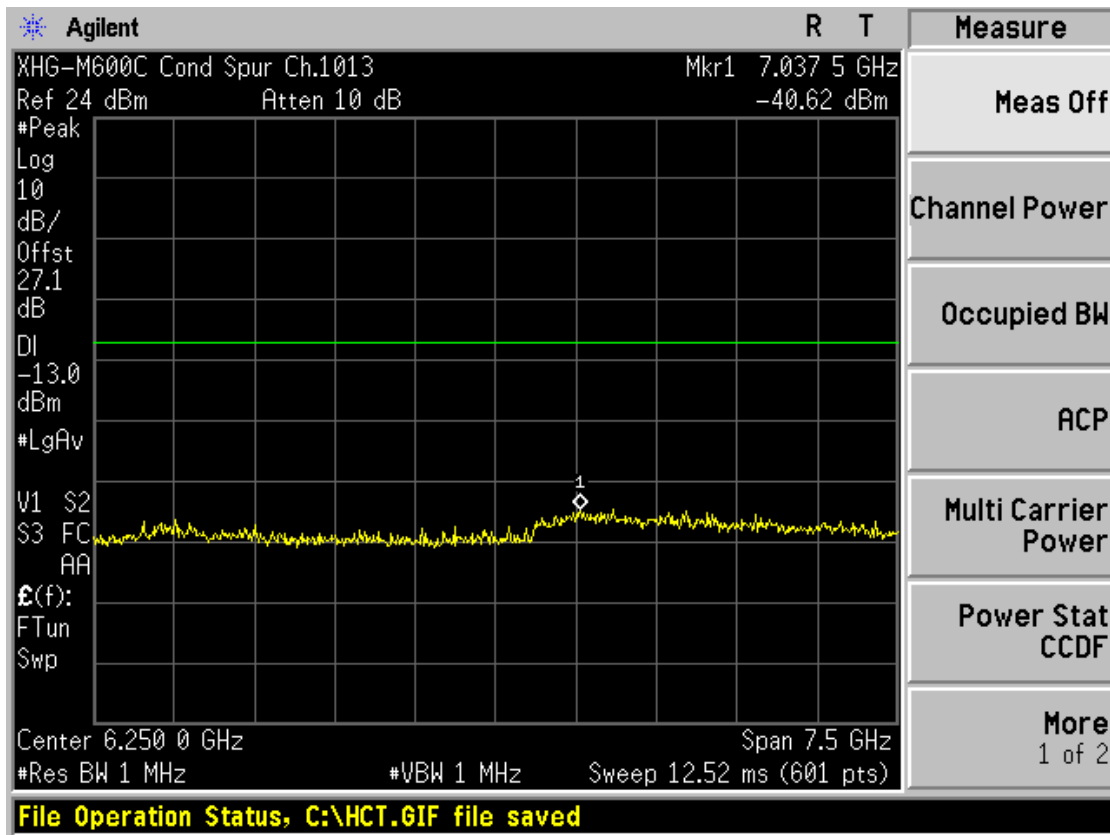

■ CDMA MODE (384 CH.) Conducted Spurious Emissions - 1

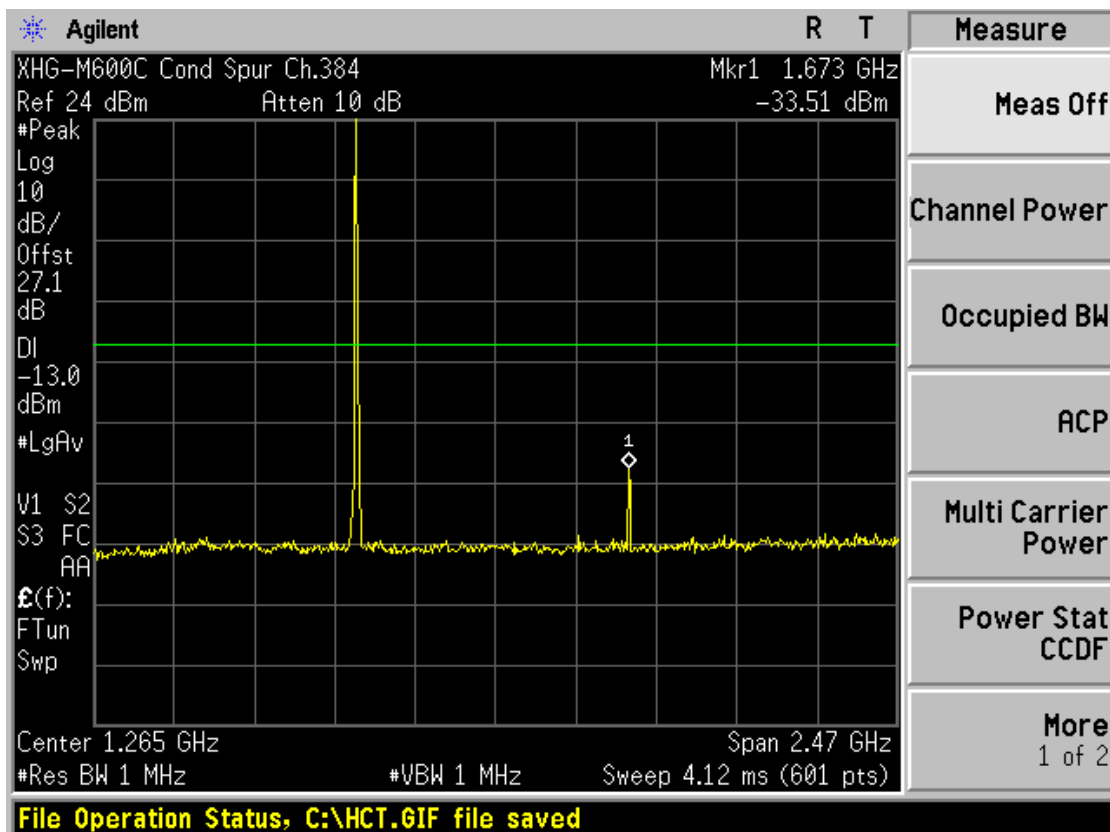

FCC CERTIFICATION REPORT			www.hct.co.kr
Test Report No. HCTR1010FFR12-2	Test Dates: November 02, 2010	EUT Type: 3G Module	FCC ID: XHG-M600C

■ CDMA MODE (384 CH.) Conducted Spurious Emissions - 2

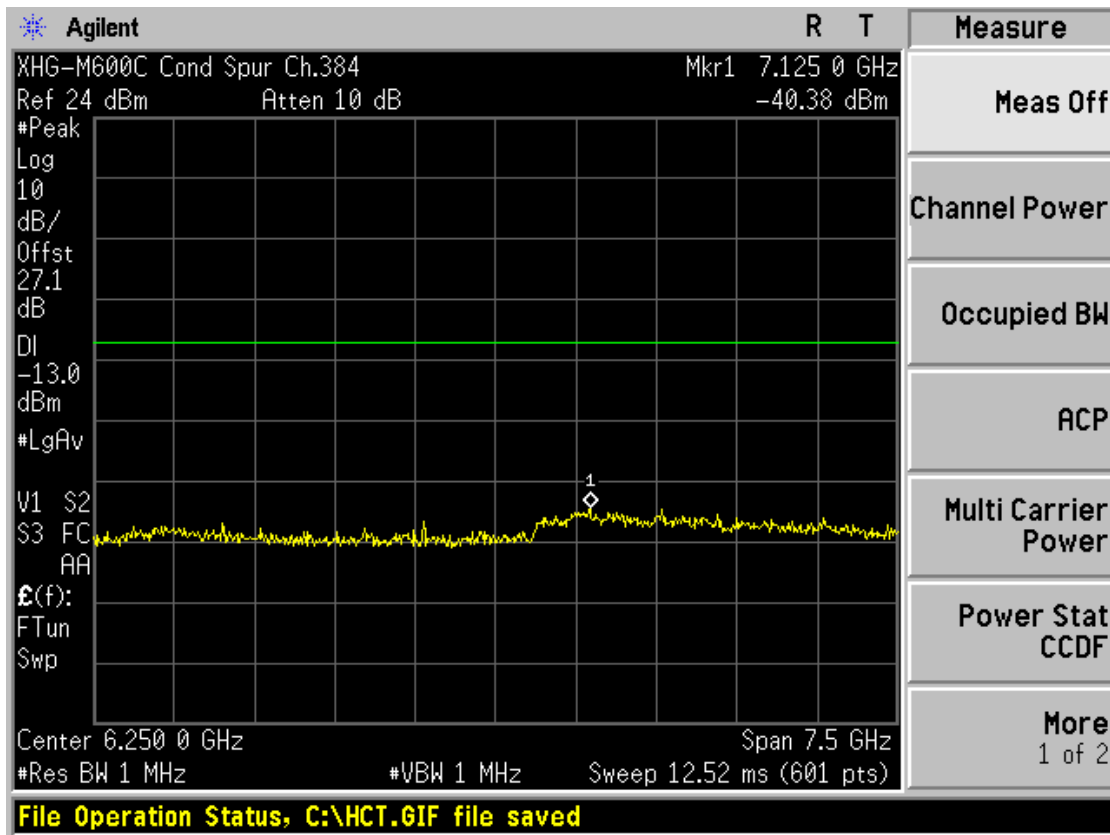

■ CDMA MODE (777 CH.) Conducted Spurious Emissions - 1

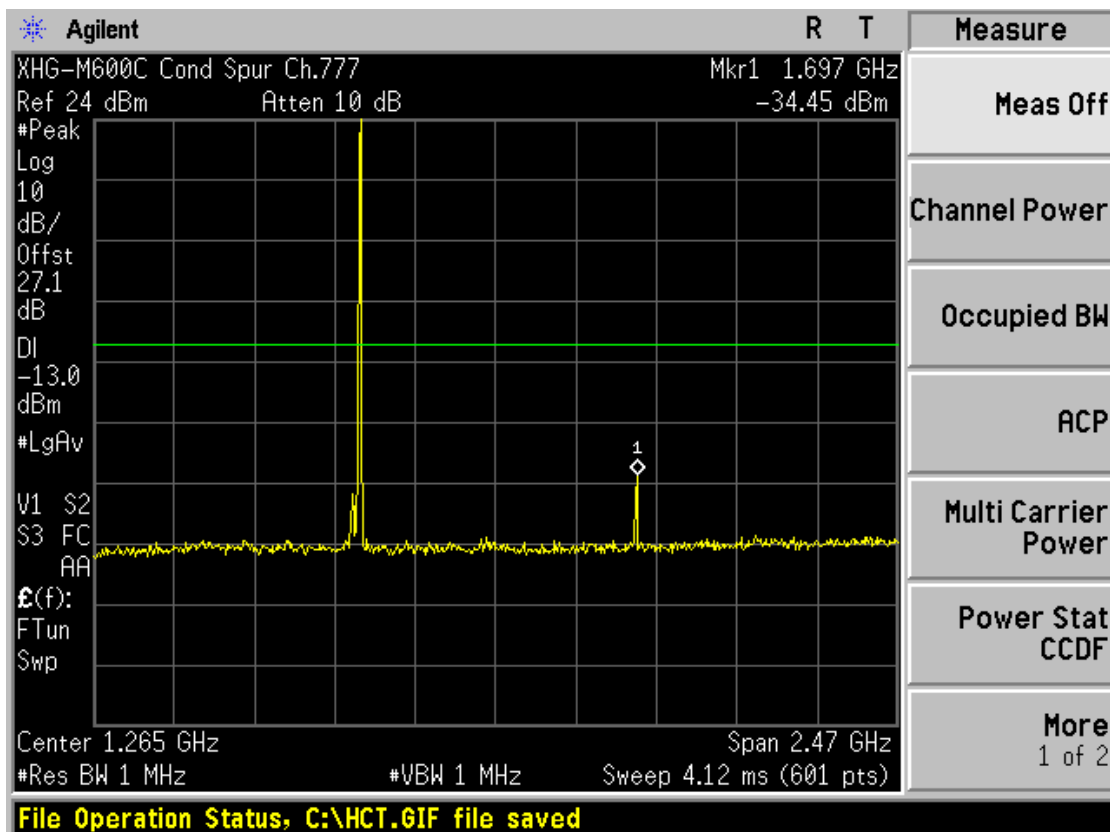

FCC CERTIFICATION REPORT			www.hct.co.kr
Test Report No. HCTR1010FFR12-2	Test Dates: November 02, 2010	EUT Type: 3G Module	FCC ID: XHG-M600C



■ CDMA MODE (777 CH.) Conducted Spurious Emissions - 2

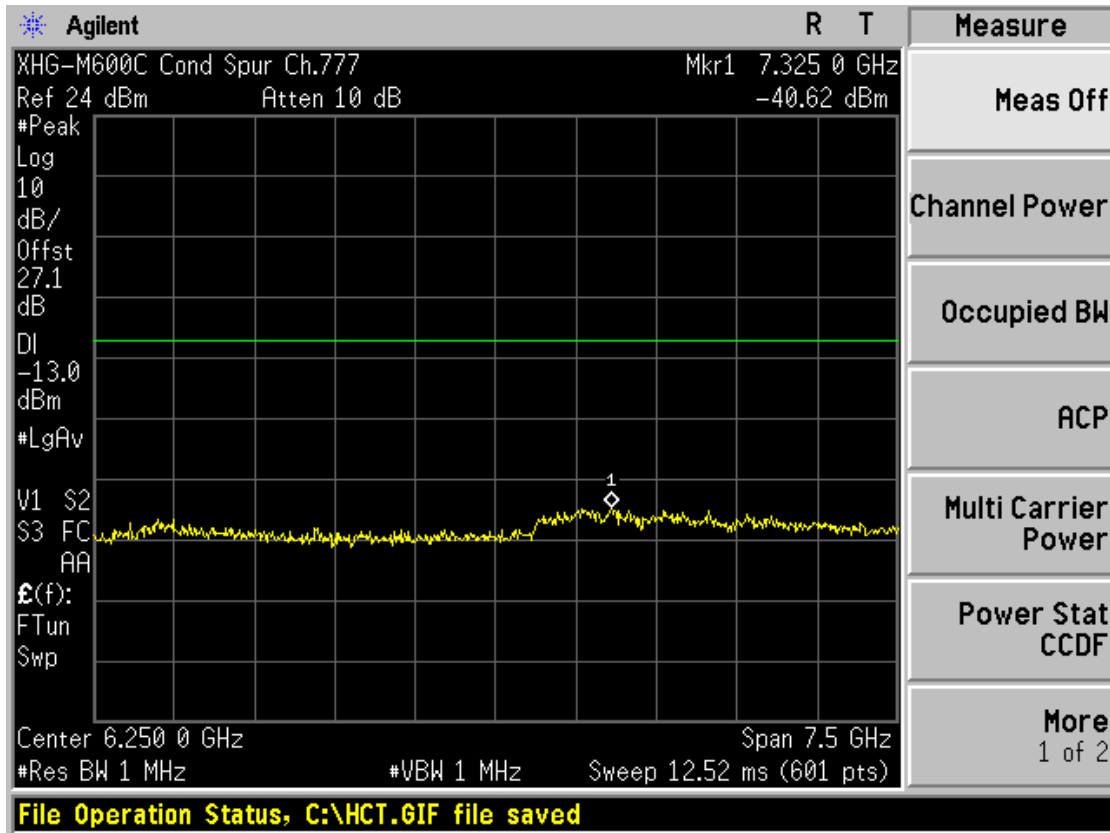

■ PCS CDMA MODE (25 CH.) Conducted Spurious Emissions - 1

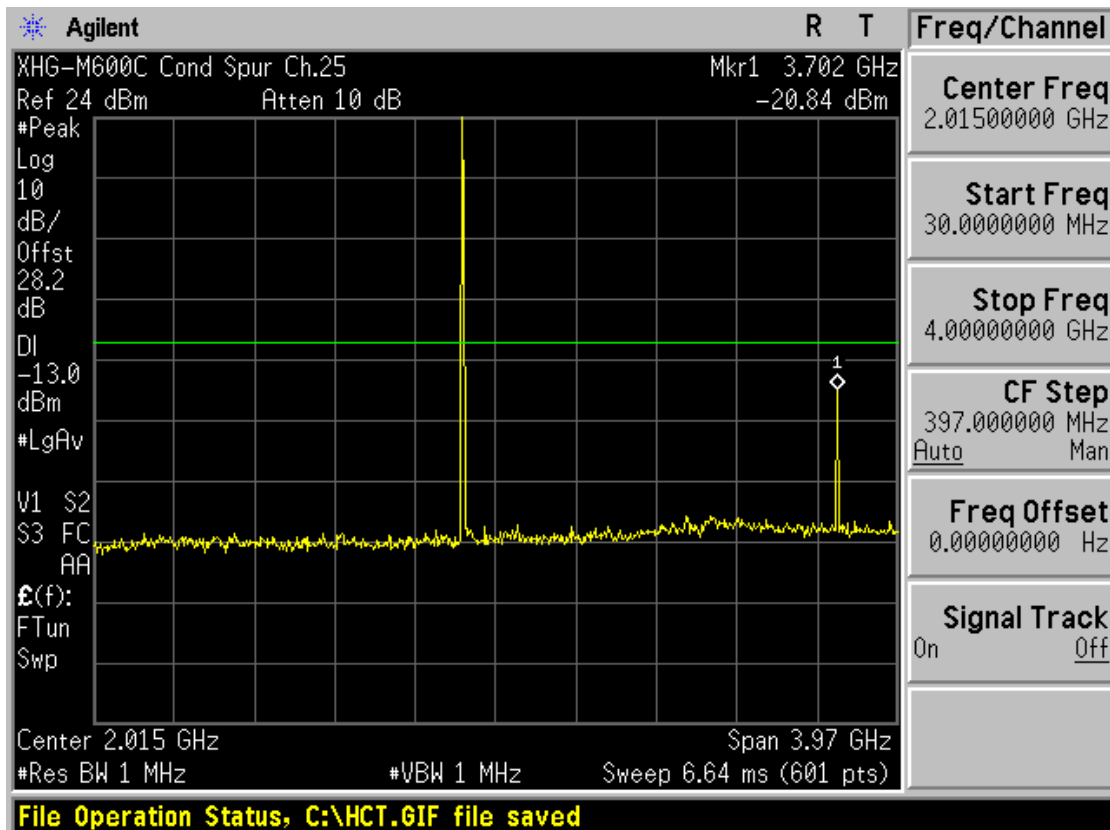

FCC CERTIFICATION REPORT			www.hct.co.kr
Test Report No. HCTR1010FFR12-2	Test Dates: November 02, 2010	EUT Type: 3G Module	FCC ID: XHG-M600C



■ PCS CDMA MODE (25 CH.) Conducted Spurious Emissions - 2

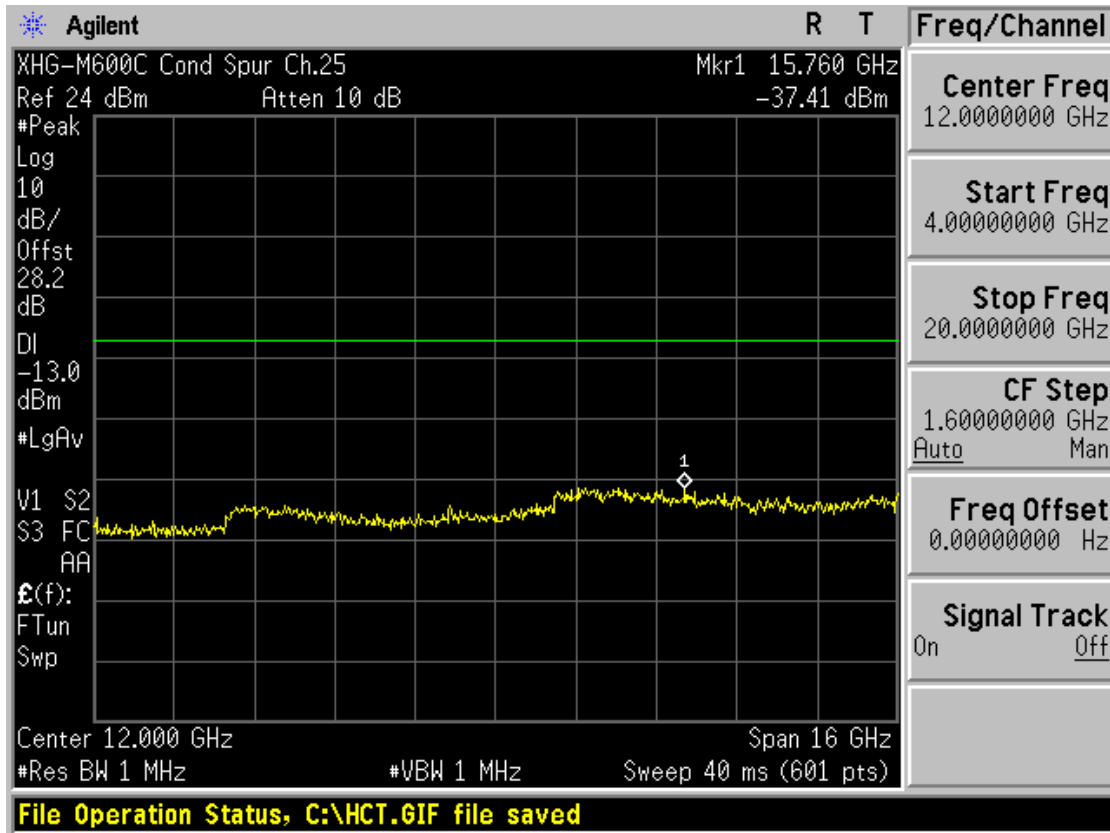

■ PCS CDMA MODE (600 CH.) Conducted Spurious Emissions - 1

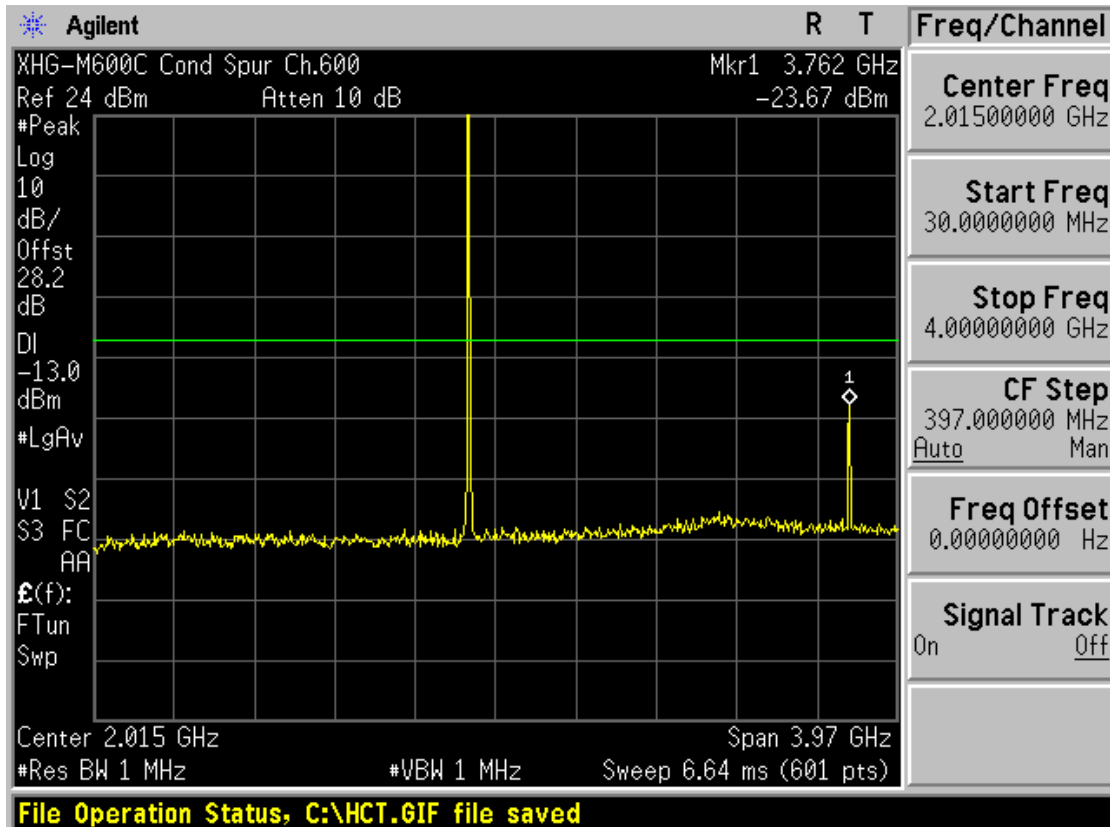

FCC CERTIFICATION REPORT			www.hct.co.kr
Test Report No. HCTR1010FFR12-2	Test Dates: November 02, 2010	EUT Type: 3G Module	FCC ID: XHG-M600C



■ PCS CDMA MODE (600 CH.) Conducted Spurious Emissions - 2

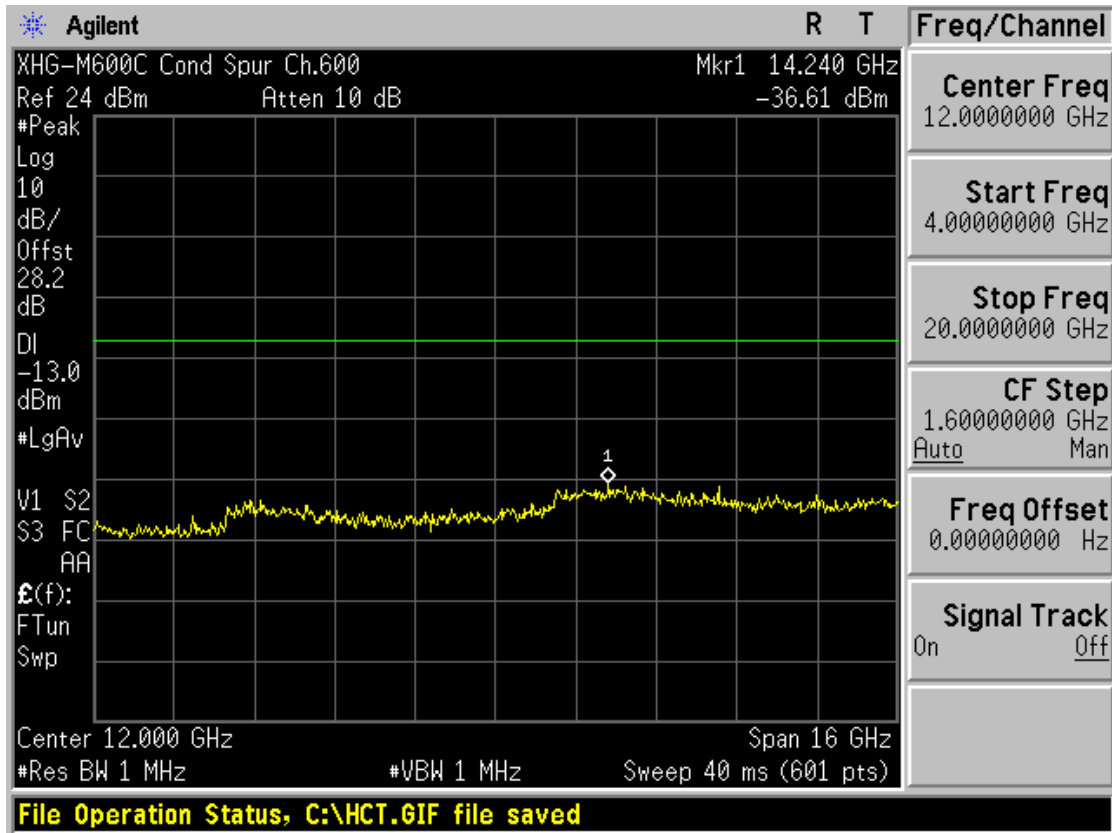

■ PCS CDMA MODE (1175 CH.) Conducted Spurious Emissions - 1

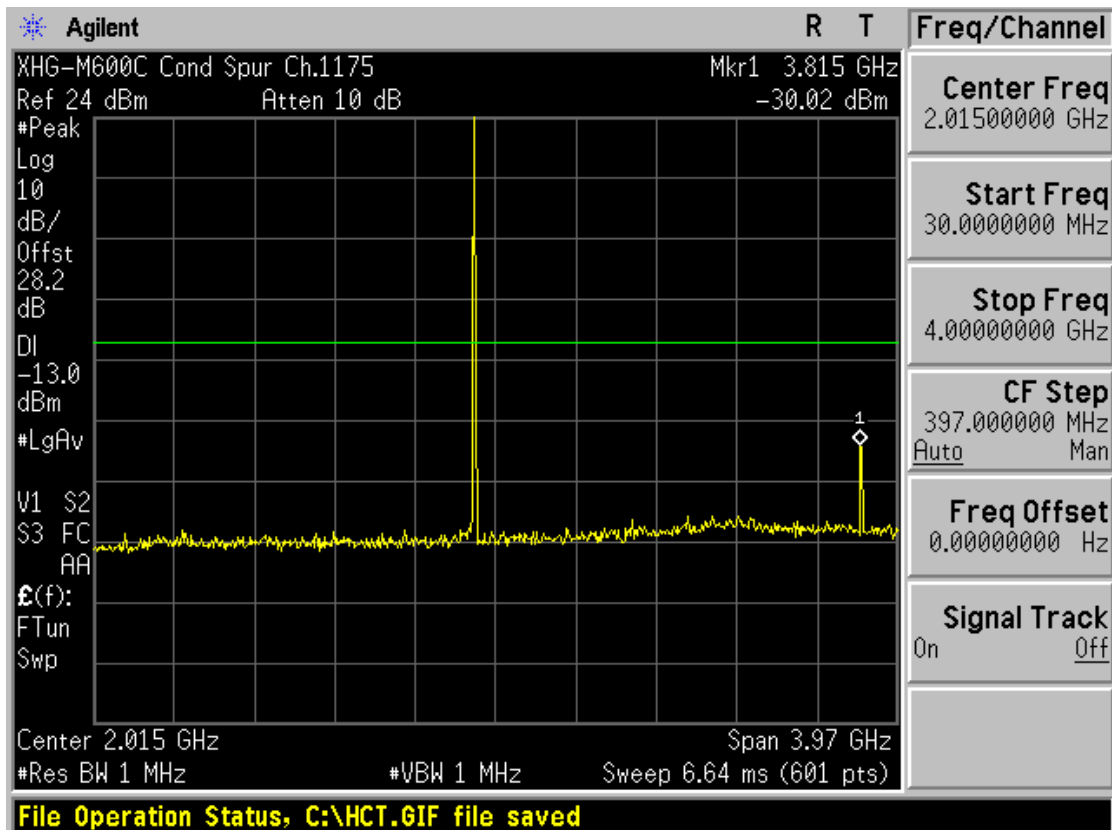

FCC CERTIFICATION REPORT			www.hct.co.kr
Test Report No. HCTR1010FFR12-2	Test Dates: November 02, 2010	EUT Type: 3G Module	FCC ID: XHG-M600C



■ PCS CDMA MODE (1175 CH.) Conducted Spurious Emissions - 2

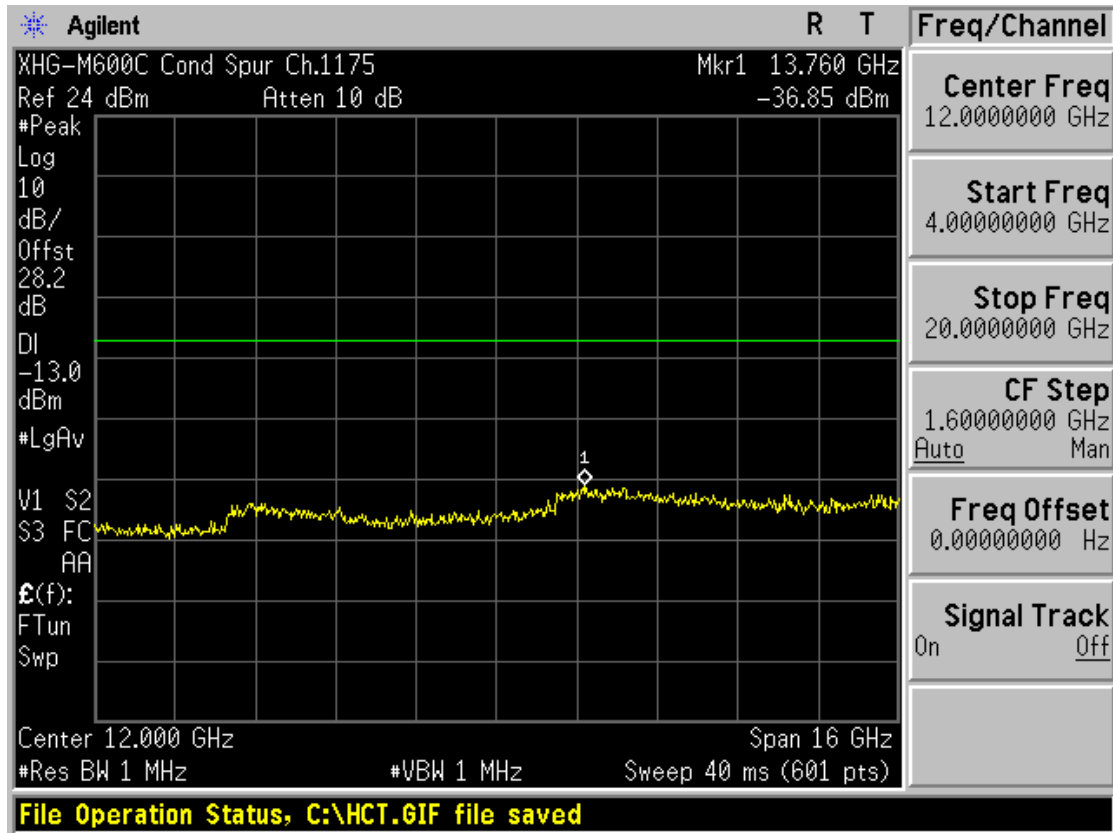

FCC CERTIFICATION REPORT			www.hct.co.kr
Test Report No. HCTR1010FFR12-2	Test Dates: November 02, 2010	EUT Type: 3G Module	FCC ID: XHG-M600C