

TEST REPORT

of

FCC Part 2 Subpart J, Part 90 Subpart S

FCC ID: XHG-RT410

Equipment Under Test : Mobile Hotspot
Model Name : RT410
Variant Model Name(s) : -
Applicant : Franklin Technology Inc.
Manufacturer : Franklin Technology Inc.
Date of Receipt : 2020.09.15
Date of Test(s) : 2020.09.16 ~ 2020.10.29
Date of Issue : 2020.10.29

In the configuration tested, the EUT complied with the standards specified above. This test report does not assure KOLAS accreditation.

- 1) The results of this test report are effective only to the items tested.
- 2) The SGS Korea is not responsible for the sampling, the results of this test report apply to the sample as received.
- 3) This test report cannot be reproduced, except in full, without prior written permission of the Company.

Tested by:



Murphy Kim

Technical
Manager:



Jungmin Yang

SGS Korea Co., Ltd. Gunpo Laboratory



INDEX

<u>Table of Contents</u>	Page
1. General Information -----	3
2. RF Radiated Output Power & Spurious Radiated Emission -----	7
3. Occupied Bandwidth -----	15
4. Spurious Emissions at Antenna Terminal -----	19
5. Band Edge -----	22
6. Frequency Stability -----	28

1. General Information

1.1. Testing Laboratory

SGS Korea Co., Ltd. (Gunpo Laboratory)

- 10-2, LS-ro 182beon-gil, Gunpo-si, Gyeonggi-do, Korea, 15807
- 4, LS-ro 182beon-gil, Gunpo-si, Gyeonggi-do, Korea, 15807
- Designation number: KR0150

All SGS services are rendered in accordance with the applicable SGS conditions of service available on request and accessible at <http://www.sgs.com/en/Terms-and-Conditions.aspx>.

Phone No. : +82 31 688 0901

Fax No. : +82 31 688 0921

1.2. Details of Applicant

Applicant : Franklin Technology Inc.

Address : 906 JEI Platz, 186, Gasan digital 1-ro, Gumcheon-Gu, Seoul, South Korea, 08502

Contact Person : Lee, James

Phone No. : +82 70 8228 6445

1.3. Details of Manufacturer

Company : Same as applicant

Address : Same as applicant

1.4. Description of EUT

Kind of Product	Mobile Hotspot
Model Name	RT410
Power Supply	DC 3.8 V
Rated Power	LTE Band 26: 23 dB m
Frequency Range	LTE Band 26: 814 MHz ~ 824 MHz
Modulation Technique	QPSK, 16QAM
Antenna Type	FPCB type antenna
Antenna gain	1.07 dB i

1.5. Test Equipment List

Equipment	Manufacturer	Model	S/N	Cal. Date	Cal. Interval	Cal. Due
Signal Generator	Agilent	E8257D	MY51501169	Nov. 21, 2019	Annual	Nov. 21, 2020
Spectrum Analyzer	R&S	FSV30	103455	Dec. 22, 2019	Annual	Dec. 22, 2020
Mobile Test Unit	R&S	CMW500	144034	Feb. 28, 2020	Annual	Feb. 28, 2021
Power Meter	Anritsu	ML2495A	1223004	Jun. 01, 2020	Annual	Jun. 01, 2021
Power Sensor	Anritsu	MA2411B	1207272	Jun. 01, 2020	Annual	Jun. 01, 2021
Directional Coupler	KRYTAR	152613	122660	Jun. 11, 2020	Annual	Jun. 11, 2021
Temperature Chamber	ESPEC CORP.	PL-1J	15000793	Jun. 02, 2020	Annual	Jun. 02, 2021
High Pass Filter	Wainwright Instrument GmbH	WHKX10-900-1000-18000-40SS	7	Mar. 04, 2020	Annual	Mar. 04, 2021
DC Power Supply	Agilent	U8002A	MY49030063	Feb. 03, 2020	Annual	Feb. 03, 2021
Preamplifier	H.P.	8447F	2944A03909	Aug. 06, 2020	Annual	Aug. 06, 2021
Signal Conditioning Unit	R&S	SCU-18	10117	Jun. 10, 2020	Annual	Jun. 10, 2021
Loop Antenna	SCHWARZBECK MESSELEKTRONIK	FMZB 1519	1519-039	Aug. 23, 2017	Biennial	Aug. 23, 2019
Bilog Antenna	SCHWARZBECK MESSELEKTRONIK	VULB9163	396	Mar. 21, 2019	Biennial	Mar. 21, 2021
Horn Antenna	R&S	HF906	100326	Feb. 14, 2020	Annual	Feb. 14, 2021
Antenna Master	Innco systems GmbH	MA4640-XP-ET	N/A	N.C.R.	N/A	N.C.R.
Turn Table	Innco systems GmbH	DS 1200S	N/A	N.C.R.	N/A	N.C.R.
Controller	Innco systems GmbH	CONTROLLER CO3000-4P	CO3000/963/38330516/L	N.C.R.	N/A	N.C.R.
Anechoic Chamber	SY Corporation	L x W x H (9.6 m x 6.4 m x 6.4 m)	N/A	N.C.R.	N/A	N.C.R.
Coaxial Cable	RFONE	SFX086-NMNM-5M (5m)	20200323001	Aug. 10, 2020	Semi-annual	Feb. 10, 2021
Coaxial Cable	RFONE	PL520-NMNM-10M (10 m)	20200324001	Aug. 10, 2020	Semi-annual	Feb. 10, 2021
Coaxial Cable	Rosenberger	LA1-C006-1500	131014 01/20	Aug. 21, 2020	Semi-annual	Feb. 21, 2021
Coaxial Cable	Rosenberger	LA1-C006-1500	131014 05/20	Aug. 21, 2020	Semi-annual	Feb. 21, 2021
Coaxial Cable	Rosenberger	LA1-C006-1500	131014 10/20	Aug. 21, 2020	Semi-annual	Feb. 21, 2021

► **Support Equipment**

Description	Manufacturer	Model	Serial Number
N/A	-	-	-

1.6. Summary of Test Results

The EUT has been tested according to the following specifications:

APPLIED STANDARD: FCC Part 2 and 90		
Section	Test Item	Result
§2.1046 §90.635(b)	RF Radiated Output Power	Complied
§2.1053 §90.691(a)	Spurious Radiated Emission	Complied
§2.1046	Conducted Output Power	N/A ¹⁾
§2.1049	Occupied Bandwidth	Complied
§90.691(a)	Spurious Emission at Antenna Terminal	Complied
§90.691(a)	Band Edge	Complied
§2.1055 §90.213(a)	Frequency Stability	Complied

Note;

1) Refer to SAR Report.

1.7. Sample Calculation for Offset

Where relevant, the following sample calculation is provided:

1.7.1. Conducted Test

Offset value (dB) = Directional Coupler (dB) + Cable loss (dB)

1.7.2. Radiation Test

- E.I.R.P. (dB m) = Measured level (dB μ V) + Antenna factor (dB/m) + Cable loss (dB) + 20 Log D - 104.5; where D is the measurement distance in meters.
- E.R.P. (dB m) = E.I.R.P. (dB m) - 2.15 (dB)

1.8. Measurement Uncertainty

Where relevant, the following measurement uncertainty levels have been estimated for tests performed on the apparatus:

Parameter	Uncertainty
Radiated Emission, 9 kHz to 30 MHz	± 3.59 dB
Radiated Emission, below 1 GHz	± 5.88 dB
Radiated Emission, above 1 GHz	± 5.94 dB

Uncertainty figures are valid to a confidence level of 95 %.

1.9. Test Report Revision

Revision	Report Number	Date of Issue	Description
0	F690501-RF-RTL001276	2020.10.29	Initial

1.10. Emission Designator and Max Power

Mode	Frequency Range (MHz)	Modulation	Emission Designator	E.R.P. / E.I.R.P.	
				Max power (dB m)	Max power (mW)
LTE Band 26	814.7 ~ 823.3	QPSK	1M10G7D	24.05	254.10
		16QAM	1M10D7D	23.05	201.84
	815.5 ~ 822.5	QPSK	2M69G7D	23.96	248.89
		16QAM	2M69D7D	22.93	196.34
	816.5 ~ 821.5	QPSK	4M50G7D	24.20	263.03
		16QAM	4M51D7D	23.62	230.14
	819.0	QPSK	8M91G7D	23.74	236.59
		16QAM	8M93D7D	22.99	199.07
	821.5	QPSK	13M5G7D	23.99	250.61
		16QAM	13M5D7D	23.23	210.38

2. RF Radiated Output Power & Spurious Radiated Emission

2.1. Test Setup

The diagram below shows the test setup that is utilized to make the measurements for emission from 9 MHz to 30 MHz.

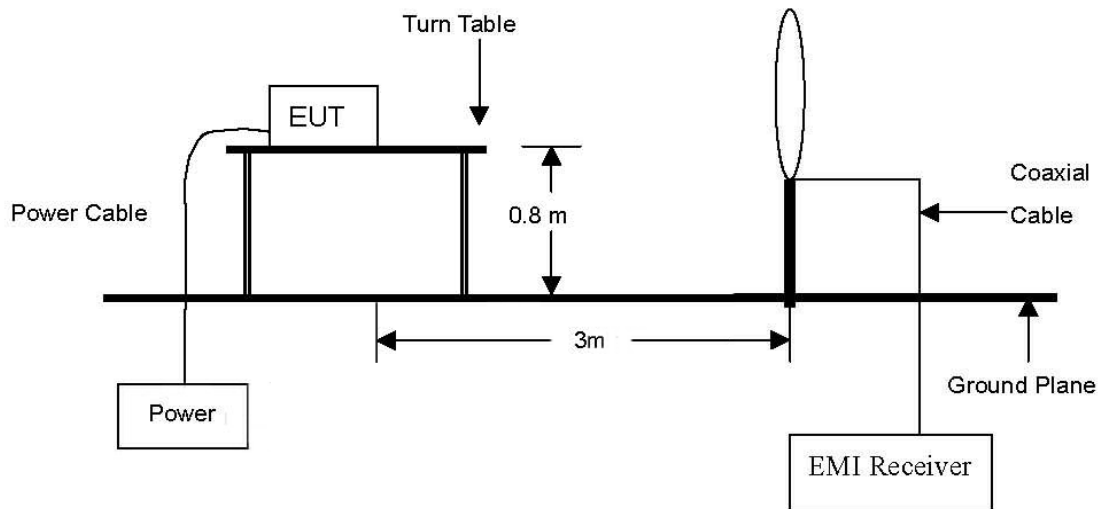

The diagram below shows the test setup that is utilized to make the measurements for emission from 30 MHz to 1 GHz.

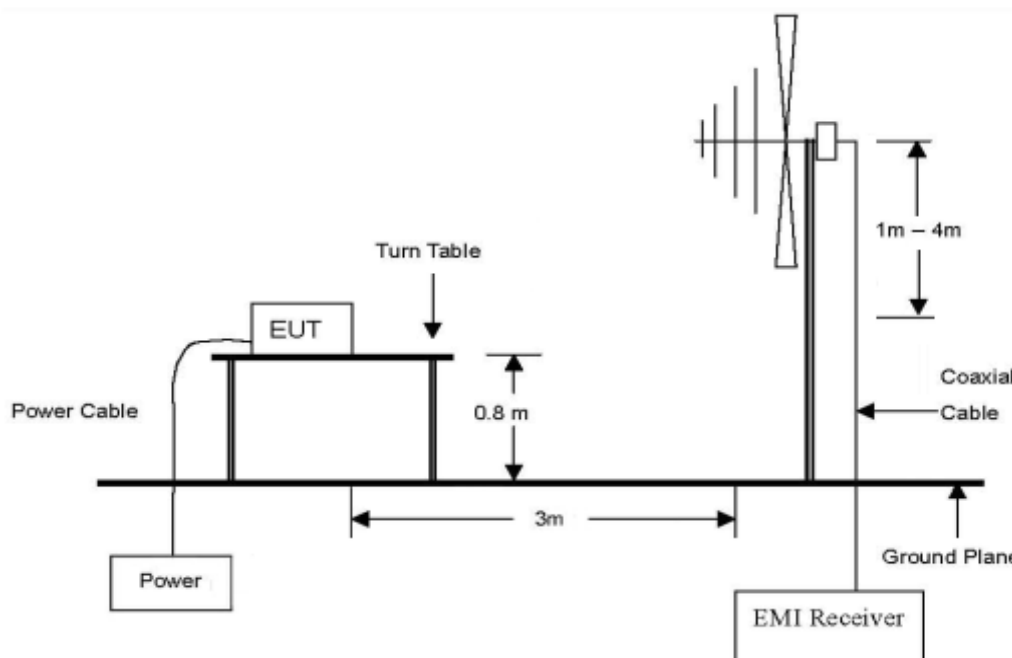

The diagram below shows the test setup that is utilized to make the measurements for emission from 1 GHz to 9 GHz.

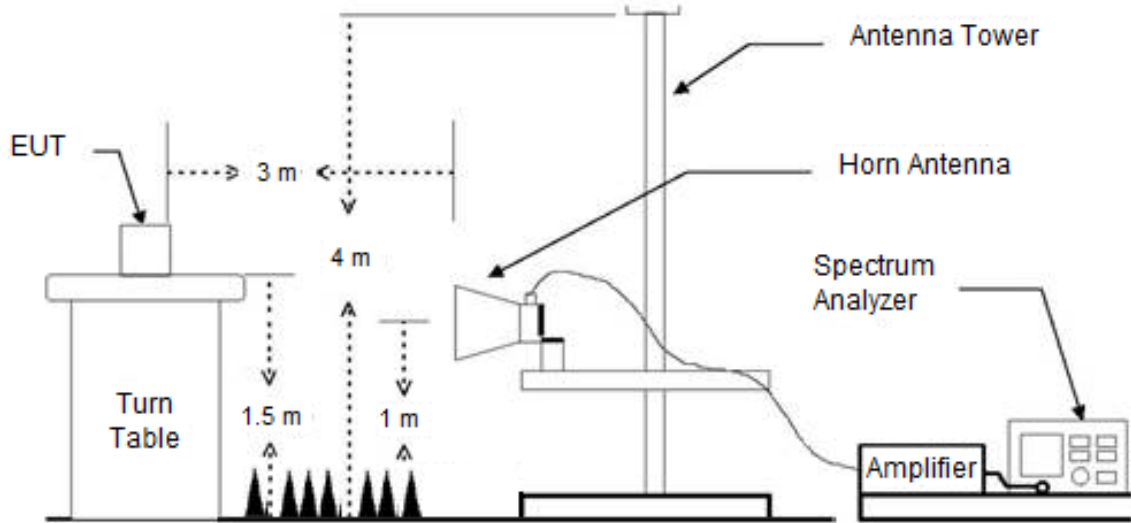

2.2. Limit

2.2.1. Limit of Radiated Output Power

- §90.635(b), The maximum output power of the transmitter for mobile stations is 100 watts (20 dBw).

2.2.2. Limit of Spurious Radiated Emission

- §90.691(a), Out-of-band emission requirement shall apply only to the "outer" channels included in an EA license and to spectrum adjacent to interior channels used by incumbent licensees. The emission limits are as follows:

(1) For any frequency removed from the EA licensee's frequency block by up to and including 37.5 kHz, the power of any emission shall be attenuated below the transmitter power (P) in watts by at least $116 \text{ Log}_{10}(f/6.1)$ decibels or $50 + 10 \text{ Log}_{10}(P)$ decibels or 80 decibels, whichever is the lesser attenuation, where f is the frequency removed from the center of the outer channel in the block in kilohertz and where f is greater than 12.5 kHz.

(2) For any frequency removed from the EA licensee's frequency block greater than 37.5 kHz, the power of any emission shall be attenuated below the transmitter power (P) in watts by at least $43 + 10 \text{ Log}_{10}(P)$ decibels or 80 decibels, whichever is the lesser attenuation, where f is the frequency removed from the center of the outer channel in the block in kilohertz and where f is greater than 37.5 kHz.

2.3. Test Procedure: Based on ANSI/TIA 603E: 2016 and ANSI C63.26-2015, KDB 971168 D01 Power Meas License Digital Systems v03r01.

1. On a test site, the EUT shall be placed at 0.8 m or 1.5 m height on a turn table, and in the position close to normal use as declared by the applicant.
2. The test antenna shall be oriented initially for vertical polarization located 3 m from EUT to correspond to the fundamental frequency of the transmitter.
3. The output of the test antenna shall be connected to the measuring receiver and the peak detector is used for the measurement.
4. The maximized power level is recorded using the spectrum analyzer "Channel Power" function with the integration band set to the emissions occupied bandwidth, $RBW = 1-5\%$ of the OBW (not to exceed 1 MHz), $VBW \geq 3 \times RBW$, Detector = power averaging (rms), sweep time = auto, trace average at least 100 traces in power averaging (rms) mode, per the guidelines of KDB 971168 D01 Power Meas License Digital Systems v03r01.
5. Radiated spurious emissions measurement method was set as follows:
RBW = 100 kHz for emissions below 1 GHz and 1 MHz for emissions above 1 GHz, $VBW \geq 3 \times RBW$,
Detector = RMS, trace mode = max hold, per the guidelines of KDB 971168 D01 Power Meas License Digital Systems v03r01.
6. The transmitter shall be switched on, the measuring receiver shall be tuned to the frequency of the transmitter under test.
7. The test antenna shall be raised and lowered through the specified range of height until the maximum signal level is detected by the measuring receiver.
8. The transmitter shall be rotated through 360° in the horizontal plane, until the maximum signal level is detected by the measuring receiver.
9. The test antenna shall be raised and lowered again through the specified range of height until the maximum signal level is detected by the measuring receiver.
10. The maximum signal level detected by the measuring receiver shall be noted.
11. In necessary, the input attenuator setting on the measuring receiver shall be adjusted in order to increase the sensitivity of the measuring receiver.
12. The test antenna shall be raised and lowered through the specified range of height to ensure that the maximum signal is received.
13. The measurement shall be repeated with the test antenna orientated for horizontal polarization.

2.4. Test Result for RF Radiated Output Power

Ambient temperature : (23 ± 1) °C
 Relative humidity : 47 % R.H.

LTE band 26 (1.4 MHz)

Frequency (MHz)	Mode	Measured Level (dB μ V)	Ant. Pol.	AF (dB/m)	CL (dB)	E (dB μ V/m)	CF (dB)	E.R.P.	
								(dB m)	(mW)
814.70	QPSK	89.36	H	26.80	5.30	121.46	-97.41	24.05	254.10
814.70		88.46	V	26.80	5.30	120.56	-97.41	23.15	206.54
823.30		89.15	H	26.87	5.36	121.38	-97.41	23.97	249.46
823.30		88.19	V	26.87	5.36	120.42	-97.41	23.01	199.99
814.70	16QAM	88.17	H	26.80	5.30	120.27	-97.41	22.86	193.20
814.70		87.24	V	26.80	5.30	119.34	-97.41	21.93	155.96
823.30		88.23	H	26.87	5.36	120.46	-97.41	23.05	201.84
823.30		87.27	V	26.87	5.36	119.50	-97.41	22.09	161.81

*1 RB size / 0 Offset

LTE band 26 (3 MHz)

Frequency (MHz)	Mode	Measured Level (dB μ V)	Ant. Pol.	AF (dB/m)	CL (dB)	E (dB μ V/m)	CF (dB)	E.R.P.	
								(dB m)	(mW)
815.50	QPSK	89.26	H	26.80	5.31	121.37	-97.41	23.96	248.89
815.50		88.46	V	26.80	5.31	120.57	-97.41	23.16	207.01
822.50		89.06	H	26.85	5.36	121.27	-97.41	23.86	243.22
822.50		88.23	V	26.85	5.36	120.44	-97.41	23.03	200.91
815.50	16QAM	88.08	H	26.80	5.31	120.19	-97.41	22.78	189.67
815.50		87.32	V	26.80	5.31	119.43	-97.41	22.02	159.22
822.50		88.13	H	26.85	5.36	120.34	-97.41	22.93	196.34
822.50		87.32	V	26.85	5.36	119.53	-97.41	22.12	162.93

*1 RB size / 0 Offset

LTE band 26 (5 MHz)

Frequency (MHz)	Mode	Measured Level (dB μ V)	Ant. Pol.	AF (dB/m)	CL (dB)	E (dB μ V/m)	CF (dB)	E.R.P.	
								(dB m)	(mW)
816.50	QPSK	89.49	H	26.80	5.32	121.61	-97.41	24.20	263.03
816.50		88.54	V	26.80	5.32	120.66	-97.41	23.25	211.35
821.50		88.88	H	26.83	5.35	121.06	-97.41	23.65	231.74
821.50		87.94	V	26.83	5.35	120.12	-97.41	22.71	186.64
816.50	16QAM	88.91	H	26.80	5.32	121.03	-97.41	23.62	230.14
816.50		87.48	V	26.80	5.32	119.60	-97.41	22.19	165.58
821.50		88.03	H	26.83	5.35	120.21	-97.41	22.80	190.55
821.50		87.16	V	26.83	5.35	119.34	-97.41	21.93	155.96

*1 RB size / 0 Offset

LTE band 26 (10 MHz)

Frequency (MHz)	Mode	Measured Level (dB μ V)	Ant. Pol.	AF (dB/m)	CL (dB)	E (dB μ V/m)	CF (dB)	E.R.P.	
								(dB m)	(mW)
819.00	QPSK	89.01	H	26.80	5.34	121.15	-97.41	23.74	236.59
819.00		88.34	V	26.80	5.34	120.48	-97.41	23.07	202.77
819.00	16QAM	88.26	H	26.80	5.34	120.40	-97.41	22.99	199.07
819.00		87.32	V	26.80	5.34	119.46	-97.41	22.05	160.32

*1 RB size / 0 Offset

LTE band 26 (15 MHz)

Frequency (MHz)	Mode	Measured Level (dB μ V)	Ant. Pol.	AF (dB/m)	CL (dB)	E (dB μ V/m)	CF (dB)	E.R.P.	
								(dB m)	(mW)
821.50	QPSK	89.22	H	26.83	5.35	121.40	-97.41	23.99	250.61
821.50		88.45	V	26.83	5.35	120.63	-97.41	23.22	209.89
821.50	16QAM	88.46	H	26.83	5.35	120.64	-97.41	23.23	210.38
821.50		87.36	V	26.83	5.35	119.54	-97.41	22.13	163.31

*1 RB size / 0 Offset

Remark;

1. AF = Antenna Factor, CL = Cable Loss, CF = Conversion Factor.
2. E (dB μ V/m) = Measured Level (dB μ V) + Antenna Factor (dB/m) + Cable Loss (dB).
3. E.I.R.P. (dB m) = E (dB μ V/m) + CF (dB).
4. E.R.P. (dB m) = E (dB μ V/m) + CF (dB) - 2.15 (dB); where E.R.P. and E.I.R.P. are expressed in consistent units.
5. CF (dB) = 20 log D - 104.8; where D is the measurement distance in meters, According to KDB 971168 D01 v03r01 5.8.4.

2.5. Spurious Radiated Emission

LTE band 26 (1.4 MHz - QPSK)

Frequency (MHz)	Measured Level (dB μ V)	Ant. Pol.	AF (dB/m)	AMP+CL (dB)	E (dB μ V/m)	CF (dB)	E.R.P. (dB m)	Limit (dB m)	Margin (dB)
Low Channel (814.7 MHz)									
1 628.73	52.68	H	25.46	-36.93	41.21	-97.41	-56.20	-13	43.20
High Channel (823.3 MHz)									
1 645.72	56.33	H	25.73	-36.82	45.24	-97.41	-52.17	-13	39.17

*1 RB size / 0 Offset

LTE band 26 (3 MHz - QPSK)

Frequency (MHz)	Measured Level (dB μ V)	Ant. Pol.	AF (dB/m)	AMP+CL (dB)	E (dB μ V/m)	CF (dB)	E.R.P. (dB m)	Limit (dB m)	Margin (dB)
Low Channel (815.5 MHz)									
1 628.58	52.21	H	25.46	-36.93	40.74	-97.41	-56.67	-13	43.67
High Channel (822.5 MHz)									
1 642.45	56.12	H	25.68	-36.84	44.96	-97.41	-52.45	-13	39.45

*1 RB size / 0 Offset

LTE band 26 (5 MHz - QPSK)

Frequency (MHz)	Measured Level (dB μ V)	Ant. Pol.	AF (dB/m)	AMP+CL (dB)	E (dB μ V/m)	CF (dB)	E.R.P. (dB m)	Limit (dB m)	Margin (dB)
Low Channel (816.5 MHz)									
1 628.83	52.45	H	25.46	-36.93	40.98	-97.41	-56.43	-13	43.43
High Channel (821.5 MHz)									
1 638.45	54.94	H	25.62	-36.87	43.69	-97.41	-53.72	-13	40.72

*1 RB size / 0 Offset

LTE band 26 (10 MHz - QPSK)

Frequency (MHz)	Measured Level (dB μ V)	Ant. Pol.	AF (dB/m)	AMP+CL (dB)	E (dB μ V/m)	CF (dB)	E.R.P. (dB m)	Limit (dB m)	Margin (dB)
Middle Channel (819.0 MHz)									
1 629.13	52.49	H	25.47	-36.93	41.03	-97.41	-56.38	-13	43.38

*1 RB size / 0 Offset

LTE band 26 (15 MHz - QPSK)

Frequency (MHz)	Measured Level (dB μ V)	Ant. Pol.	AF (dB/m)	AMP+CL (dB)	E (dB μ V/m)	CF (dB)	E.R.P. (dB m)	Limit (dB m)	Margin (dB)
Middle Channel (821.5 MHz)									
1 629.78	51.95	H	25.48	-36.93	40.50	-97.41	-56.91	-13	43.91

*1 RB size / 0 Offset

Remark;

1. AF = Antenna Factor, AMP= Amplifier Gain, CL = Cable Loss, CF = Conversion Factor.
2. E (dB μ V/m) = Measured Level (dB μ V) + Antenna Factor (dB/m) + AMP (dB) + Cable Loss (dB).
3. E.I.R.P. (dB m) = E (dB μ V/m) + CF (dB).
4. E.R.P. (dB m) = E (dB μ V/m) + CF (dB) - 2.15 (dB); where E.R.P. and E.I.R.P. are expressed in consistent units.
5. CF (dB) = 20 log D - 104.8; where D is the measurement distance in meters, According to KDB 971168 D01 v03r01 5.8.4.

3. Occupied Bandwidth

3.1. Limit

CFR 47, Section FCC §2.1049.

3.2. Test Procedure

The test follows section 5.4.4 of ANSI C63.26-2015.

- a. The spectrum analyzer center frequency is set to the nominal EUT channel center frequency. The frequency span for the spectrum analyzer shall be set wide enough to capture all modulation products including the emission skirts (typically a span of $1.5 \times \text{OBW}$ is sufficient).
- b. The nominal IF filter 3 dB bandwidth (RBW) shall be in the range of 1 % to 5 % of the anticipated OBW, and the VBW shall be set $\geq 3 \times \text{RBW}$.
- c. Set the reference level of the instrument as required to prevent the signal amplitude from exceeding the maximum spectrum analyzer input mixer level for linear operation. See guidance provided in 4.2.3.
- d. Set the detection mode to peak, and the trace mode to max-hold.
- e. If the instrument does not have a 99 % OBW function, recover the trace data points and sum directly in linear power terms. Place the recovered amplitude data points, beginning at the lowest frequency, in a running sum until 0.5 % of the total is reached. Record that frequency as the lower OBW frequency. Repeat the process until 99.5 % of the total is reached and record that frequency as the upper OBW frequency. The 99 % power OBW can be determined by computing the difference these two frequencies.
- f. The OBW shall be reported and plot(s) of the measuring instrument display shall be provided with the test report. The frequency and amplitude axis and scale shall be clearly labeled. Tabular data can be reported in addition to the plot(s).

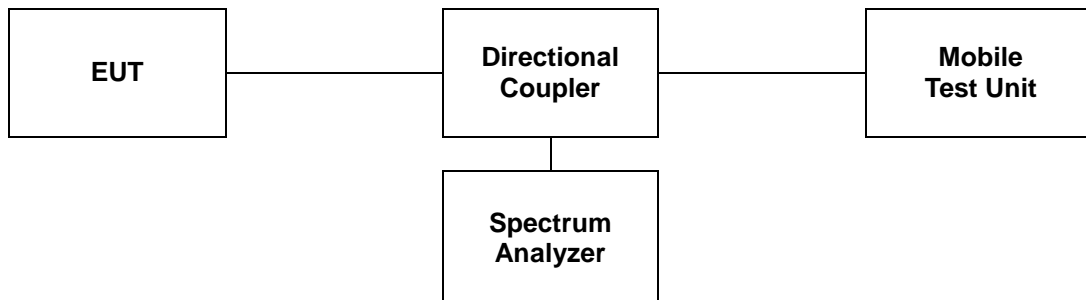

3.3 Test Results

Ambient temperature : (23 ± 1) °C
 Relative humidity : 47 % R.H.

Band	Bandwidth (MHz)	Frequency (MHz)	Occupied Bandwidth (MHz)	
			QPSK	16QAM
26	1.4	814.7	1.103	1.097
	3	815.5	2.691	2.685
	5	816.5	4.496	4.505
	10	819.0	8.911	8.931
	15	821.5	13.457	13.457

- Test plots

LTE band 26

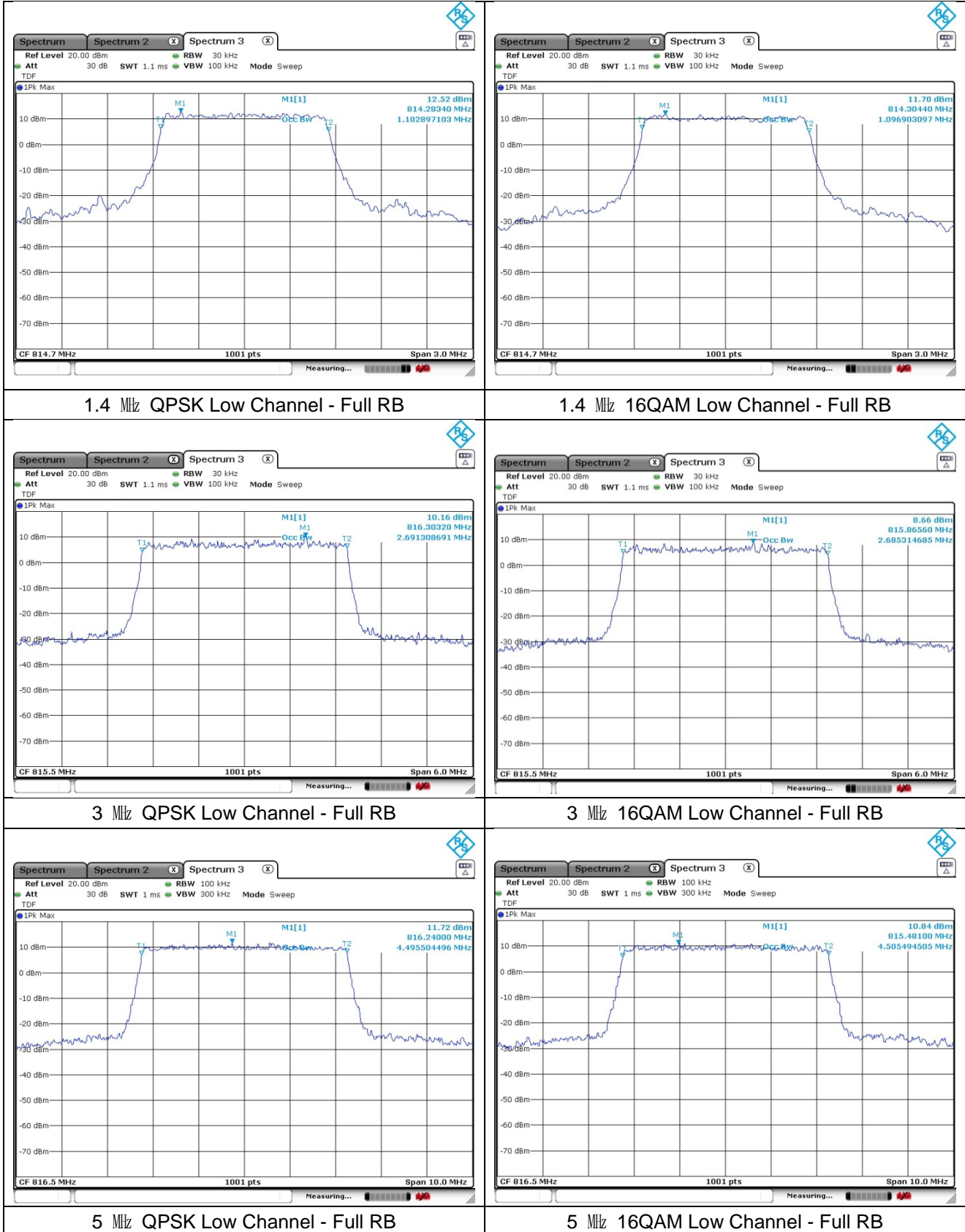

LTE band 26

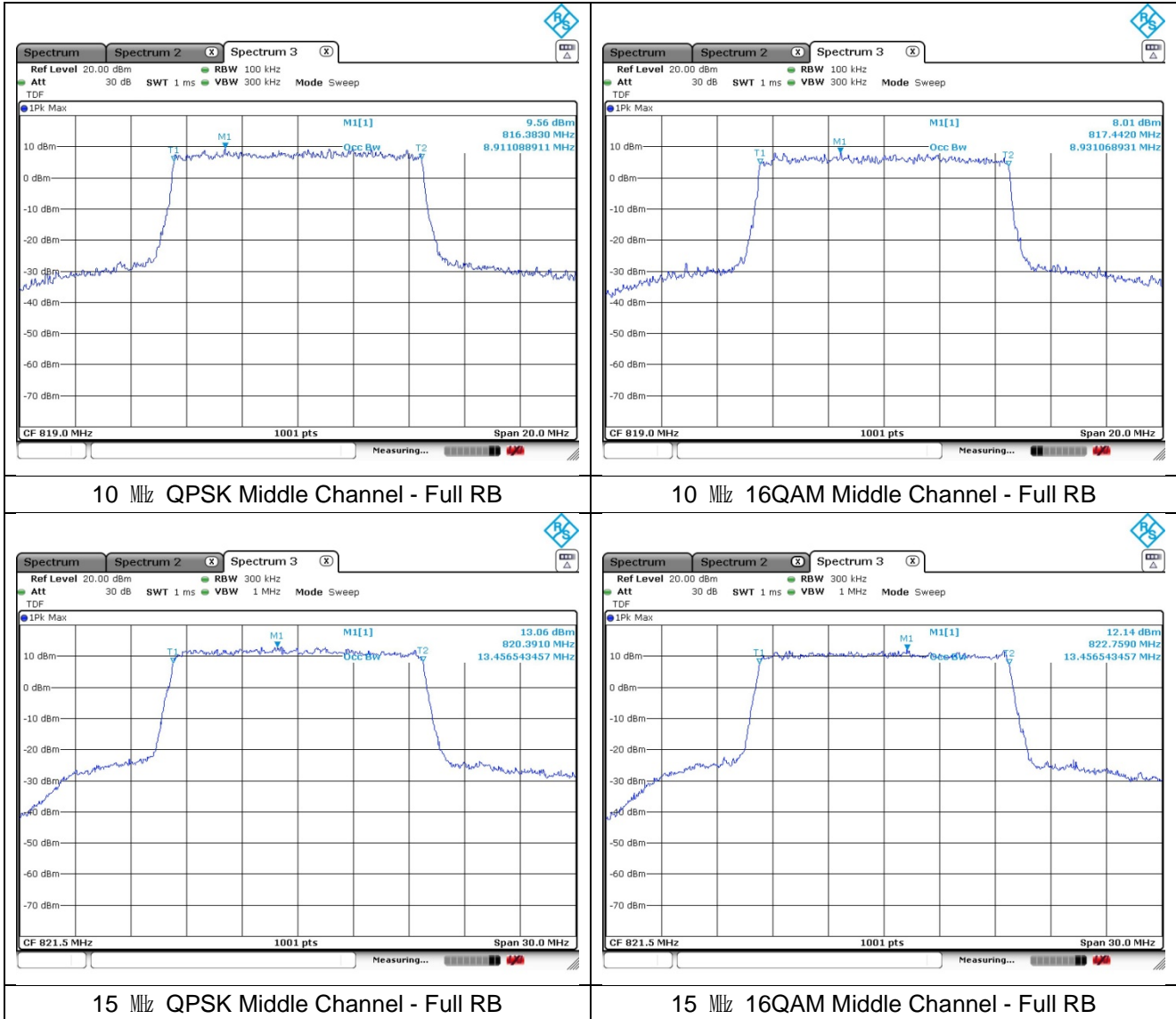

4. Spurious Emissions at Antenna Terminal

4.1. Limit

- §90.691(a), Out-of-band emission requirement shall apply only to the “outer” channels included in an EA license and to spectrum adjacent to interior channels used by incumbent licensees. The emission limits are as follows:

(1) For any frequency removed from the EA licensee's frequency block by up to and including 37.5 kHz, the power of any emission shall be attenuated below the transmitter power (P) in watts by at least $116 \text{ Log}_{10}(f/6.1)$ decibels or $50 + 10 \text{ Log}_{10}(P)$ decibels or 80 decibels, whichever is the lesser attenuation, where f is the frequency removed from the center of the outer channel in the block in kilohertz and where f is greater than 12.5 kHz.

(2) For any frequency removed from the EA licensee's frequency block greater than 37.5 kHz, the power of any emission shall be attenuated below the transmitter power (P) in watts by at least $43 + 10 \text{ Log}_{10}(P)$ decibels or 80 decibels, whichever is the lesser attenuation, where f is the frequency removed from the center of the outer channel in the block in kilohertz and where f is greater than 37.5 kHz.

4.2. Test Procedure

The test follows section 5.7 of ANSI C63.26-2015.

1. Start frequency was set to 9 kHz and stop frequency was set to at least 10* the fundamental frequency.
2. Detector = Peak.
3. Trace mode = Max hold.
4. Sweep time = Auto couple.
5. The trace was allowed to stabilize.
6. Please see notes below for RBW and VBW settings.
7. For plots showing conducted spurious emissions from 9 kHz to 9 GHz, all path loss of wide frequency range was investigated and compensated to spectrum analyzer as correction factor.

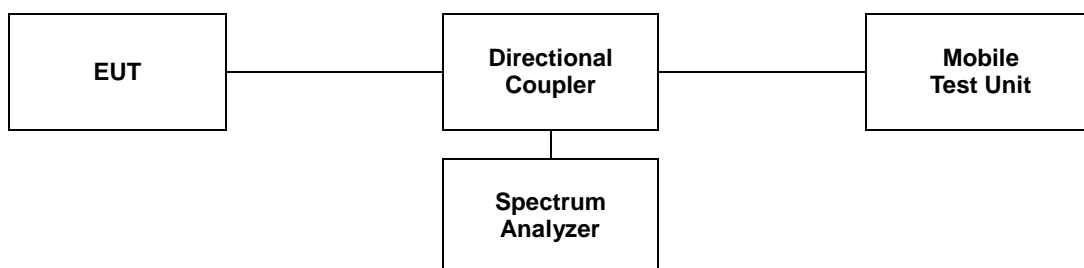

Note;

Compliance with the applicable limits is based on the use of measurement instrumentation employing a resolution bandwidth of 100 kHz or greater for frequencies less than 1 GHz and frequencies greater than 1 GHz. However, in the 1 MHz bands immediately outside and adjacent to the frequency block a resolution bandwidth of at least one percent of the emission bandwidth of the fundamental emission of the transmitter may be employed. The emission bandwidth is defined as the width of the signal between two point, one below the carrier center frequency and one above the carrier center frequency, outside of which all emission are attenuated at least 26 dB below the transmitter power.

4.3. Test Results

Ambient temperature : (23 ± 1) °C
 Relative humidity : 47 % R.H.

- Test plots

LTE band 26

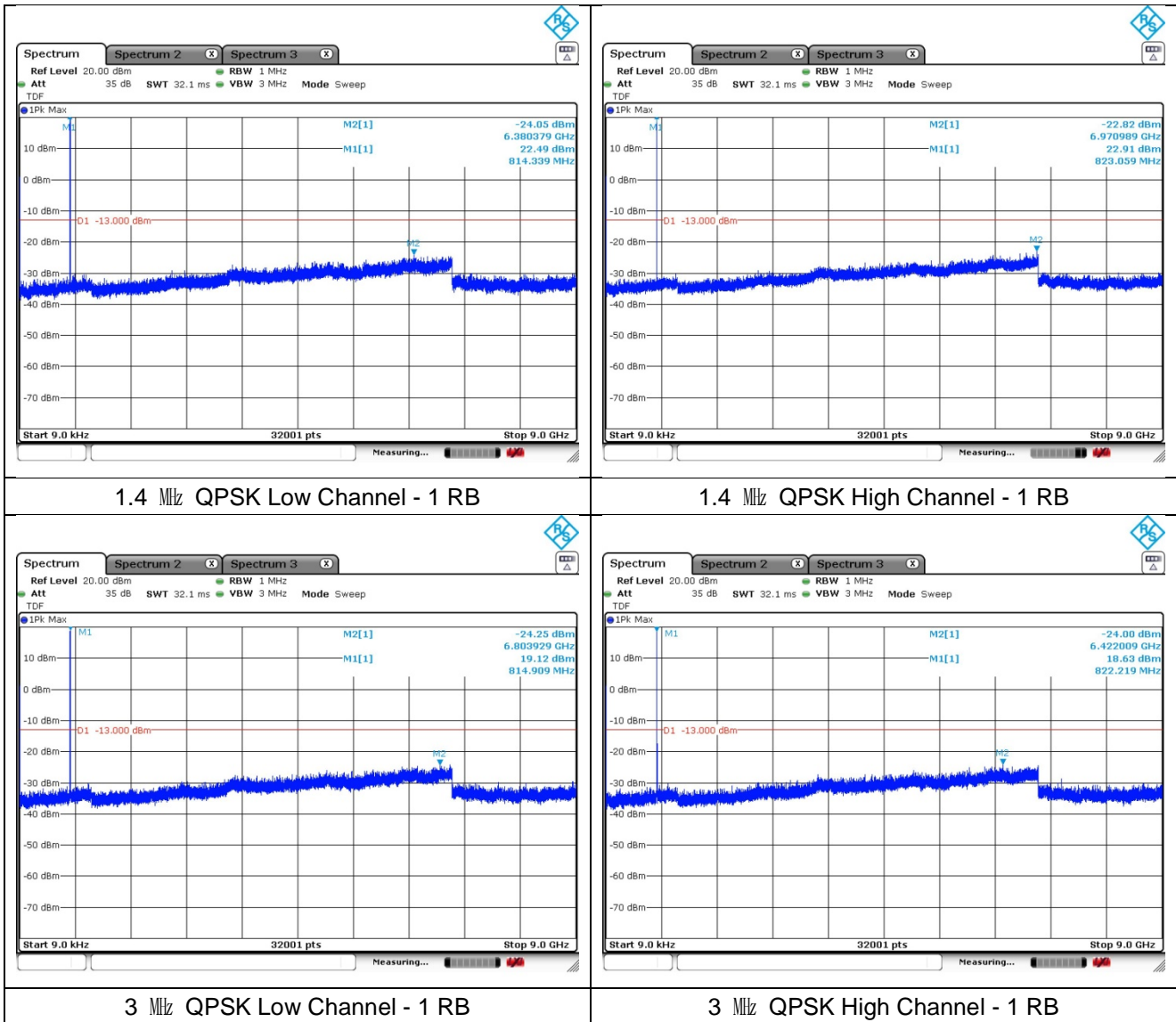

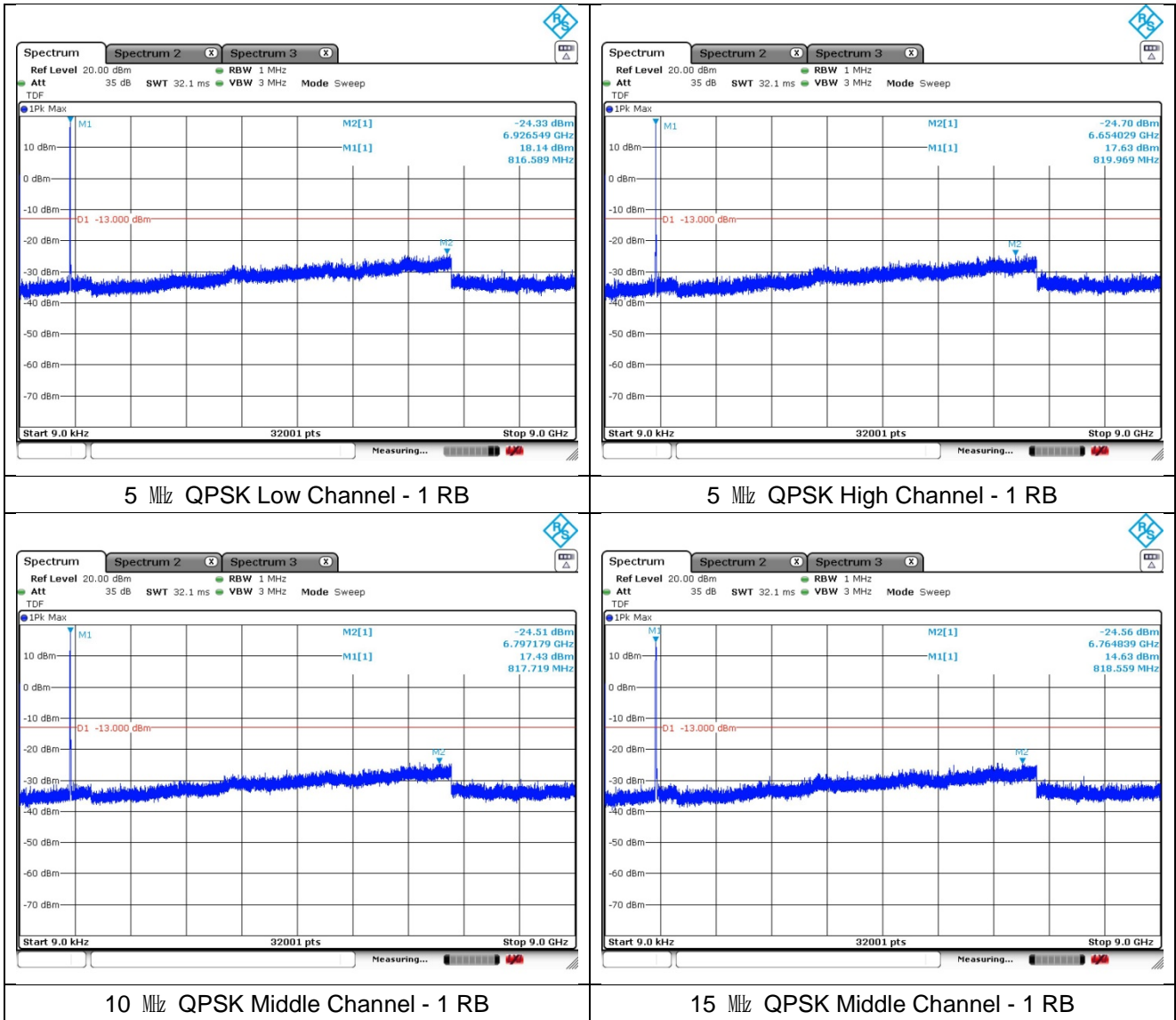

5. Band Edge

5.1. Limit

- §90.691(a), Out-of-band emission requirement shall apply only to the “outer” channels included in an EA license and to spectrum adjacent to interior channels used by incumbent licensees. The emission limits are as follows:

(1) For any frequency removed from the EA licensee's frequency block by up to and including 37.5 kHz, the power of any emission shall be attenuated below the transmitter power (P) in watts by at least $116 \text{ Log}_{10}(f/6.1)$ decibels or $50 + 10 \text{ Log}_{10}(P)$ decibels or 80 decibels, whichever is the lesser attenuation, where f is the frequency removed from the center of the outer channel in the block in kilohertz and where f is greater than 12.5 kHz.

(2) For any frequency removed from the EA licensee's frequency block greater than 37.5 kHz, the power of any emission shall be attenuated below the transmitter power (P) in watts by at least $43 + 10 \text{ Log}_{10}(P)$ decibels or 80 decibels, whichever is the lesser attenuation, where f is the frequency removed from the center of the outer channel in the block in kilohertz and where f is greater than 37.5 kHz.

5.2. Test Procedure

The test follows section 5.7.2 of ANSI C63.26-2015.

- a. Span was set large enough so as to capture all out of band emissions near the band edge.
- b. RBW $\geq 1\%$ of OBW.
- c. VBW $\geq 3 \times$ RBW.
- d. Detector = RMS.
- e. Trace mode = Average.
- f. Sweep time = Auto.
- g. The trace was allowed to stabilize.
- h. All path loss of frequency range was investigated and compensated to spectrum analyzer as TDF function.

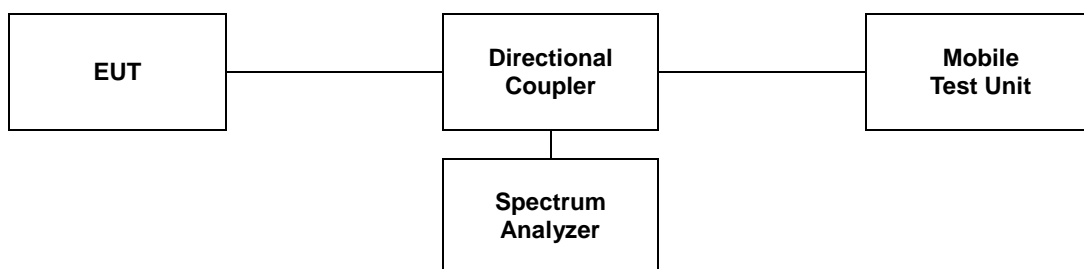

Note;

Compliance with the applicable limits is based on the use of measurement instrumentation employing a resolution bandwidth of 100 kHz or greater for frequencies less than 1 GHz and frequencies greater than 1 GHz. However, in the 1 MHz bands immediately outside and adjacent to the frequency block a resolution bandwidth of at least one percent of the emission bandwidth of the fundamental emission of the transmitter may be employed. The emission bandwidth is defined as the width of the signal between two point, one below the carrier center frequency and one above the carrier center frequency, outside of which all emission are attenuated at least 26 dB below the transmitter power.

5.3. Test Results

Ambient temperature : (23 ± 1) °C
 Relative humidity : 47 % R.H.

- Test plots

LTE band 26

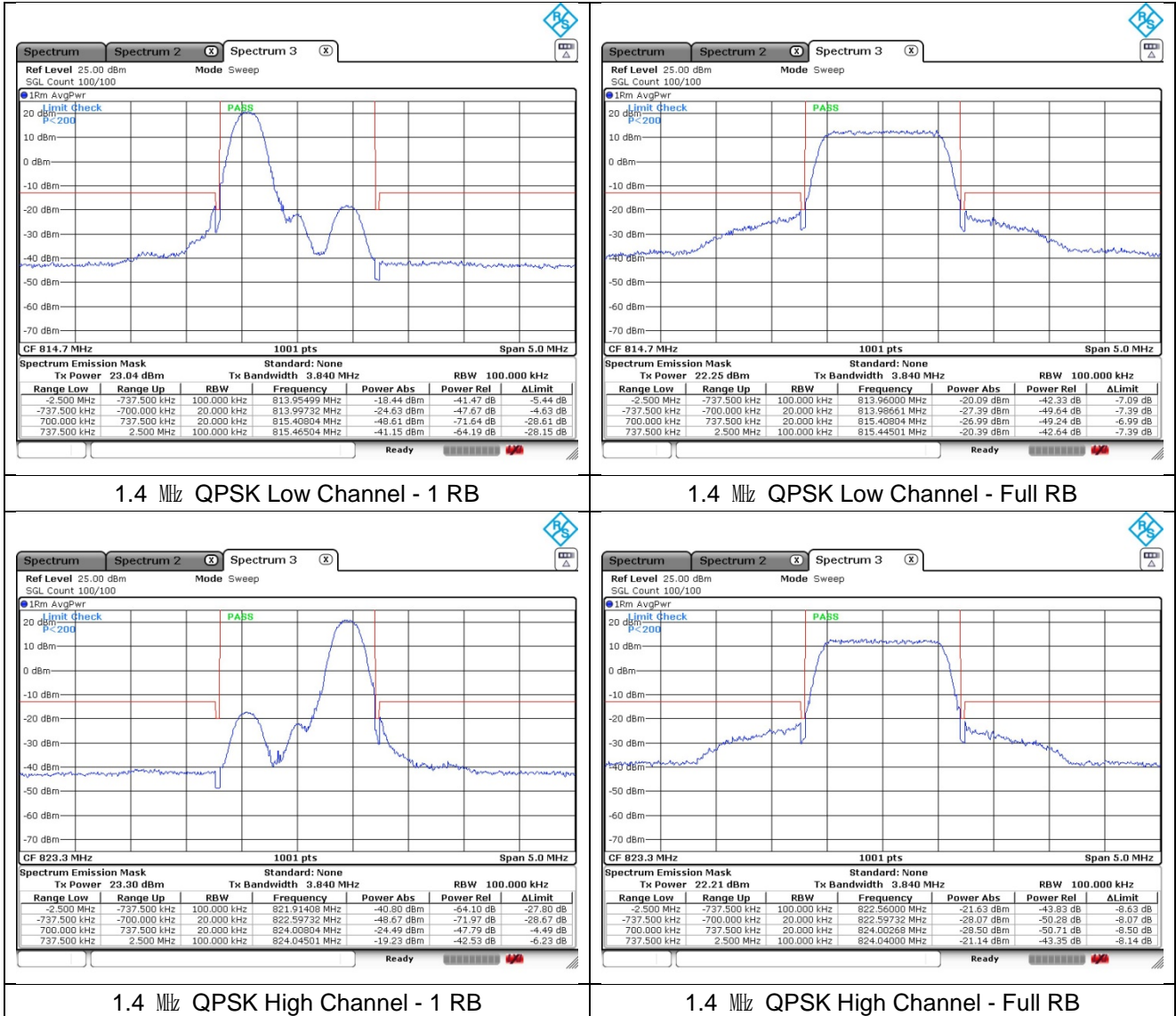

LTE band 26

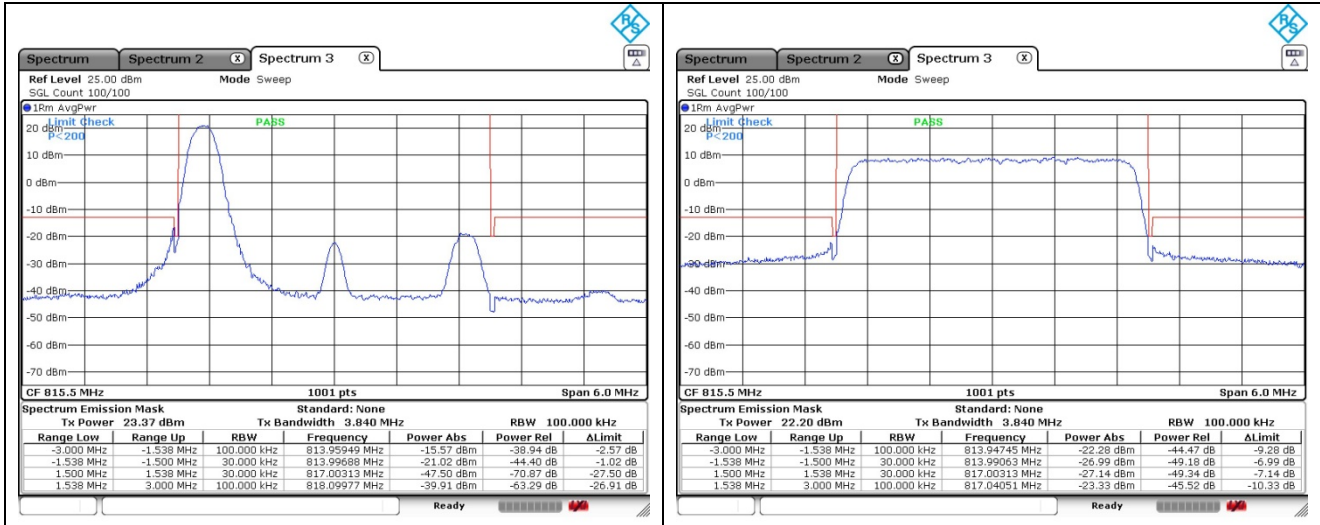

3 MHz QPSK Low Channel - 1 RB

3 MHz QPSK Low Channel - Full RB

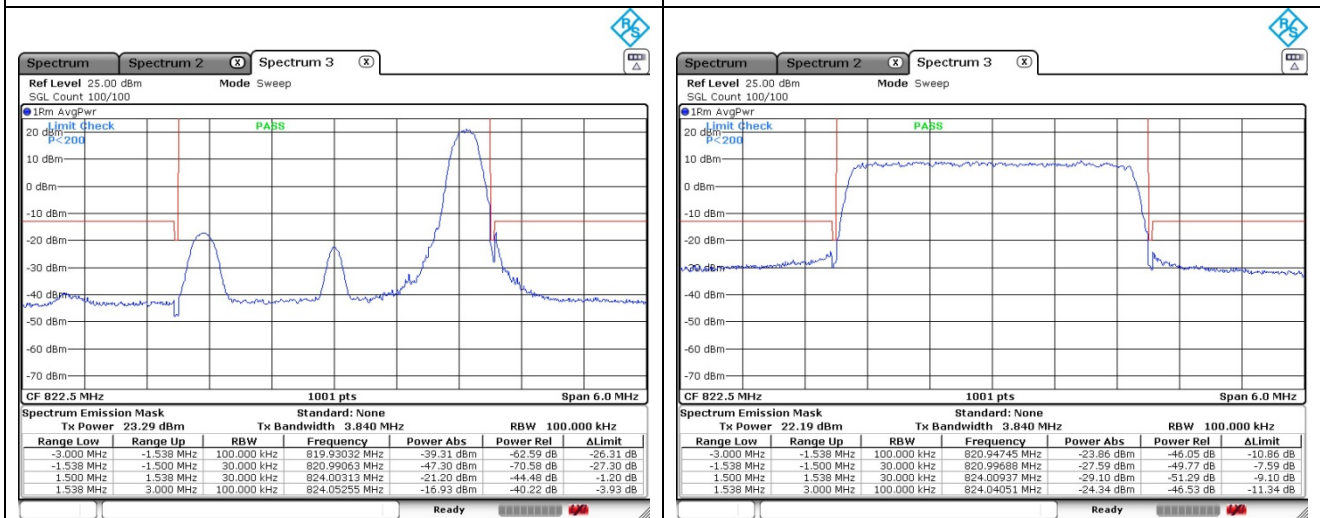

3 MHz QPSK High Channel - 1 RB

3 MHz QPSK High Channel - Full RB

LTE band 26

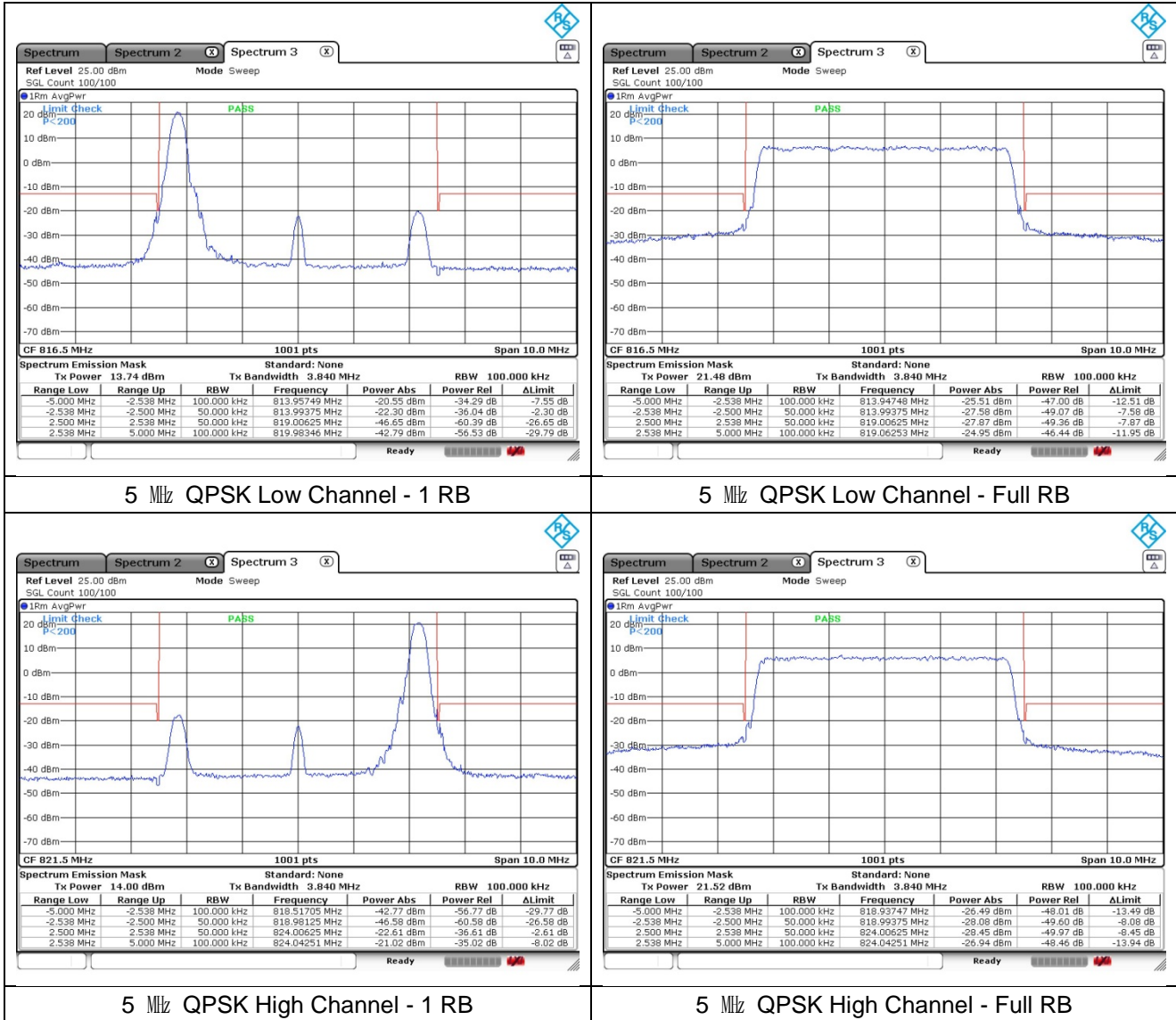

LTE band 26

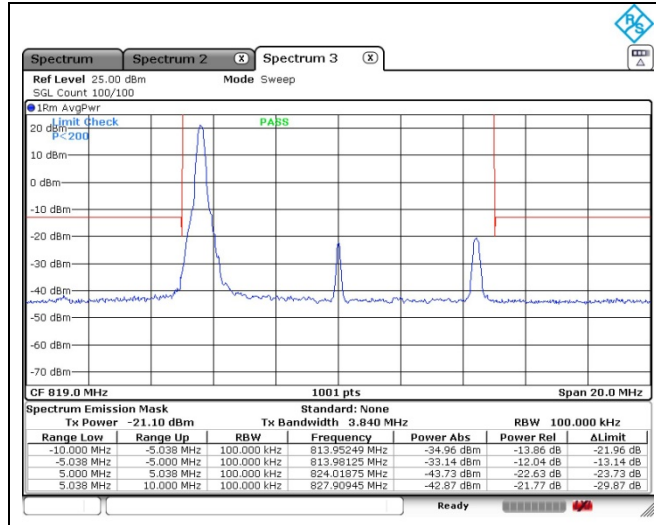

10 MHz QPSK Middle Channel - 1 RB Low

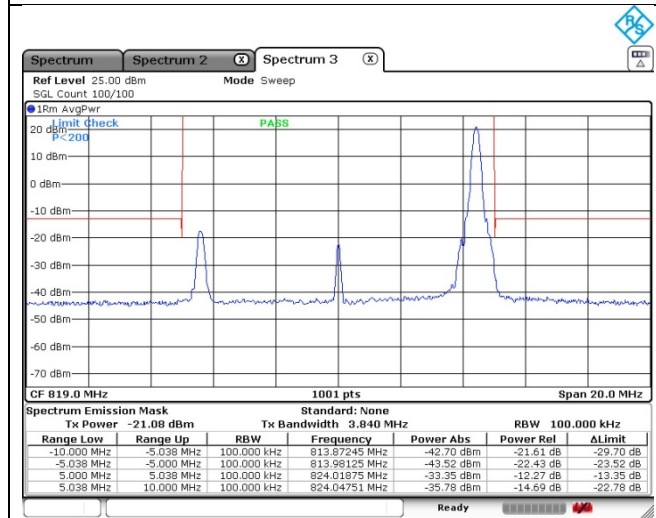

10 MHz QPSK Middle Channel - 1 RB High

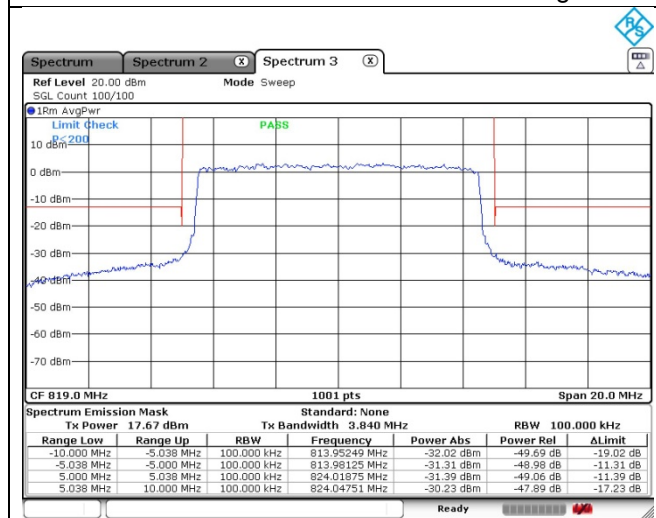

10 MHz QPSK Middle Channel - Full RB

LTE band 26

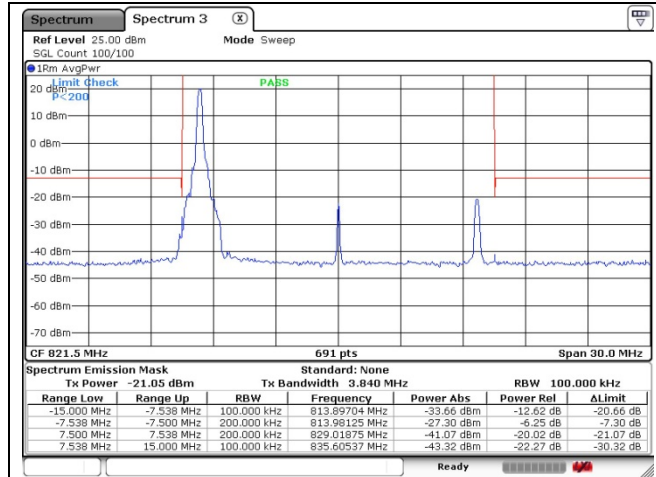

15 MHz QPSK Middle Channel - 1 RB Low

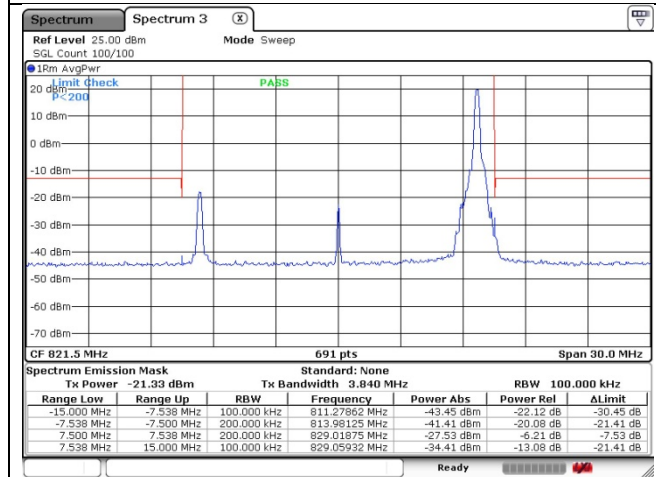

15 MHz QPSK Middle Channel - 1 RB High

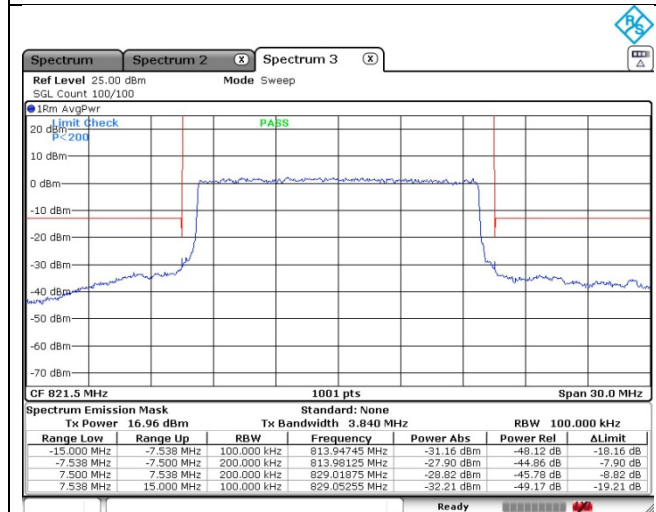

15 MHz QPSK Middle Channel - Full RB

6. Frequency Stability

6.1. Limit

- § 2.1055(a), § 2.1055(d) & following:

- §90.213, transmitters used in the services governed by this part must have a minimum frequency stability as specified in the following table.

For Mobile devices operating in the 809 to 824 MHz band at a power level 2 Watts or less, the limit specified in Table is +/- 2.5 ppm.

6.2. Test Procedure

1. Frequency Stability vs. Temperature: The equipment under test was connected to an external DC power supply and the RF output was connected to a Mobile Test Unit via feed-through attenuators.
2. The EUT was placed inside the temperature chamber.
3. After the temperature stabilized for approximately 20 minutes, the frequency output was recorded from Mobile Test Unit.

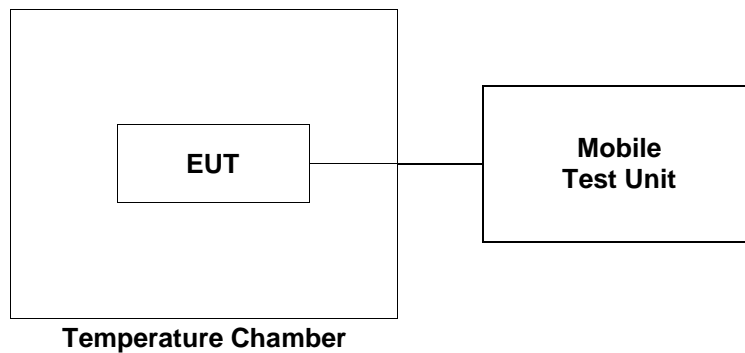

6.3. Test Results

Ambient temperature : (23 ± 1) °C
 Relative humidity : 47 % R.H.

Operating Frequency: 821.5 MHz			
Frequency Stability versus Temperature			
Environment Temperature (°C)	Power Supplied (V)	Frequency Measure with Time Elapse	
		Frequency Error (Hz)	ppm
50	3.8	-5	-0.006 1
40		4	0.004 9
30		4	0.004 9
20 (Ref.)		-7	-
10		3	0.003 7
0		6	0.007 3
-10		-4	-0.004 9
-20		-5	-0.006 1
-30		-6	-0.007 3
Frequency Stability versus Power Supply			
Environment Temperature (°C)	Power Supplied (V)	Frequency Measure with Time Elapse	
		Frequency Error (Hz)	ppm
20	4.37	6	0.007 3
	3.40 (End point)	-5	-0.006 1

- End of the Test Report -