



# RF Exposure Report

(Part 2: Test Under Dynamic Transmission Condition)

FCC ID : XHG-RG1000  
Equipment : Mobile Hotspot  
Model Name : RG1000  
Applicant : Franklin Technology Inc.  
906 JEI Platz, 186, Gasan digital 1-ro,  
Gumcheon-Gu, Seoul, South Korea,  
08502

We, SPORTON INTERNATIONAL INC., would like to declare that the tested sample has been evaluated in accordance with the test procedures and has been in compliance with the applicable technical standards.

The test results in this report apply exclusively to the tested model / sample. Without written approval of SPORTON INTERNATIONAL INC. EMC & Wireless Communications Laboratory, the test report shall not be reproduced except in full.

Approved by: Cona Huang / Deputy Manager

**Sporton International Inc.**

No. 52, Huaya 1st Rd., Guishan Dist., Taoyuan City, Taiwan



### History of this test report

Report No.	Version	Description	Issued Date
FA140849C	01	Initial issue of report	Sep. 14, 2021



# Contents

- 1 Introduction ..... 5**
- 2 Tx Varying Transmission Test Cases and Test Proposal ..... 6**
- 3 SAR Time Averaging Validation Test Procedures ..... 9**
  - 3.1 Test sequence determination for validation .....9
  - 3.2 Test configuration selection criteria for validating Smart Transmit feature .....9
    - 3.2.1 Test configuration selection for time-varying Tx power transmission .....9
    - 3.2.2 Test configuration selection for change in call ..... 10
    - 3.2.3 Test configuration selection for change in technology/band ..... 10
    - 3.2.4 Test configuration selection for change in DSI ..... 10
    - 3.2.5 Test configuration selection for SAR exposure switching ..... 10
  - 3.3 Test procedures for conducted power measurements ..... 11
    - 3.3.1 Time-varying Tx power transmission scenario ..... 11
    - 3.3.2 Change in call scenario ..... 13
    - 3.3.3 Change in technology and band ..... 14
    - 3.3.4 Change in antenna ..... 15
    - 3.3.5 Change in DSI ..... 15
    - 3.3.6 Change in time window ..... 15
    - 3.3.7 SAR exposure switching ..... 17
  - 3.4 Test procedure for time-varying SAR measurements ..... 18
- 4 PD Time Averaging Validation Test Procedures ..... 20**
  - 4.1 Test sequence for validation in mmW NR transmission ..... 20
  - 4.2 Test configuration selection criteria for validating Smart Transmit feature ..... 20
    - 4.2.1 Test configuration selection for time-varying Tx power transmission ..... 20
    - 4.2.2 Test configuration selection for change in antenna configuration (beam) ..... 20
    - 4.2.3 Test configuration selection for SAR vs. PD exposure switch during transmission ..... 20
  - 4.3 Test procedures for mmW radiated power measurements ..... 20
    - 4.3.1 Time-varying Tx power scenario ..... 21
    - 4.3.2 Switch in SAR vs. PD exposure during transmission ..... 22
    - 4.3.3 Change in antenna configuration (beam) ..... 24
  - 4.4 Test procedure for time-varying PD measurements ..... 26
- 5 Test Configurations ..... 28**
  - 5.1 WWAN (sub-6) transmission ..... 28
  - 5.2 LTE + mmW NR transmission ..... 31
- 6 Conducted Power Test Results for Sub-6 Smart Transmit Feature Validation ..... 32**
  - 6.1 Measurement setup ..... 32
  - 6.2  $P_{limit}$  and  $P_{max}$  measurement results ..... 35
  - 6.3 Time-varying Tx power measurement results ..... 36
    - 6.3.1 WCDMA B2 ..... 37
    - 6.3.2 LTE B2 ..... 39
    - 6.3.3 LTE B41 ..... 41
    - 6.3.4 5G NR SA n77 ..... 43
  - 6.4 Change in Call Test Results ..... 45
  - 6.5 Change in technology/band test results ..... 47
  - 6.6 Change in Time window / antenna switch test results ..... 49



- 6.6.1 Test case 1: transition from LTE B41 to LTE B48 (i.e., 100s to 60s), then back to LTE B41 ..... 49
- 6.6.2 Test case 2: transition from LTE B48 to LTE B41 (i.e., 60s to 100s), then back to LTE B48..... 51
- 6.7 Switch in SAR exposure test results ..... 53
- 7 SAR Test Results for Sub-6 Smart Transmit Feature Validation ..... 55**
  - 7.1 Measurement setup ..... 55
  - 7.2 SAR measurement results for time-varying Tx power transmission scenario ..... 56
    - 7.2.1 WCDMA B2 SAR test results ..... 57
    - 7.2.2 LTE B2 SAR test results ..... 59
    - 7.2.3 LTE B41 SAR test results ..... 61
    - 7.2.4 5G NR SA n77 SAR test results ..... 63
- 8 Radiated Power Test Results for mmW Smart Transmit Feature Validation ..... 65**
  - 8.1 Measurement Setup..... 65
  - 8.2 mmW NR radiated power test results ..... 66
    - 8.2.1 Maximum Tx power test results for n260 ..... 69
    - 8.2.2 Maximum Tx power test results for n261 ..... 71
    - 8.2.3 Switch in SAR vs. PD exposure test results for n260 ..... 73
    - 8.2.4 Switch in SAR vs. PD exposure test results for n261 ..... 75
    - 8.2.5 Change in Beam test results for n260 ..... 77
    - 8.2.6 Change in Beam test results for n261 ..... 79
- 9 PD Test Results for mmW Smart Transmit Feature Validation ..... 81**
  - 9.1 Measurement setup ..... 81
  - 9.2 PD measurement results for maximum power transmission scenario..... 82
    - 9.2.1 PD test results for n260 ..... 83
    - 9.2.2 PD test results for n261 ..... 84
- 10 Conclusions ..... 85**



# 1 Introduction

The equipment under test (EUT) is a portable handset (FCC ID: XHG-RG1000), it contains the Qualcomm modem supporting 2G/3G/4G technologies and 5G NR bands. The modem is enabled with Qualcomm Smart Transmit feature to control and manage transmitting power in real time and to ensure at all times the time-averaged RF exposure is in compliance with the FCC requirement.

This purpose of the Part 2 report is to demonstrate the EUT complies with FCC RF exposure requirement under Tx varying transmission scenarios, thereby validity of Qualcomm Smart Transmit feature for FCC equipment authorization

The  $P_{limit}$  and *input.power.limit* used in this report is determined in Part 0 and Part 1 reports.

Refer to PART 0 SAR AND POWER DENSITY CHAR REPORT, for product description and terminology used in this report.

### Test Lab Information

Test Firm Name	Sporton International Inc.
Test Firm Information	No. 52, Huaya 1st Rd., Guishan Dist., Taoyuan City, Taiwan TEL: +886-3-327-3456 FAX: +886-3-328-4978
Test Firm Registration Number for FCC	553509
Date of Start during the Test	08/24/2021
Date of End during the Test	09/03/2021
Test Engineers	Steven Chang, Aaron Chen
Report Producer	Wan Liu



## 2 Tx Varying Transmission Test Cases and Test Proposal

---

To validate time averaging feature and demonstrate the compliance in Tx varying transmission conditions, the following transmission scenarios are covered in Part 2 test:

During a time-varying Tx power transmission: To prove that the Smart Transmit feature accounts for Tx power variations in time accurately.

During a call disconnect and re-establish scenario: To prove that the Smart Transmit feature accounts for history of past Tx power transmissions accurately.

During technology/band handover: To prove that the Smart Transmit feature functions correctly during transitions in technology/band.

During DSI (Device State Index) change: To prove that the Smart Transmit feature functions correctly during transition from one device state (DSI) to another.

During antenna (or beam) switch: To prove that the Smart Transmit feature functions correctly during transitions in antenna (such as AsDiv scenario) or beams (different antenna array configurations).

SAR vs. PD exposure switching during sub-6+mmW transmission: To prove that the Smart Transmit feature functions correctly and ensures total RF exposure compliance during transitions in SAR dominant exposure, SAR+PD exposure, and PD dominant exposure scenarios.

SAR exposure switching between two active radios (radio1 and radio2): To prove that the Smart Transmit feature functions correctly and ensures total RF exposure compliance when exposure varies among SAR\_radio1 only, SAR\_radio1 + SAR\_radio2, and SAR\_radio2 only scenarios.

As described in Part 0 report, the RF exposure is proportional to the Tx power for a SAR- and PD-characterized wireless device. Thus, feature validation in Part 2 can be effectively performed through conducted (for  $f < 6\text{GHz}$ ) and radiated (for  $f \geq 6\text{GHz}$ ) power measurement. Therefore, the compliance demonstration under dynamic transmission conditions and feature validation are done in conducted/radiated power measurement setup for transmission scenario 1 through 8.

To add confidence in the feature validation, the time-averaged SAR and PD measurements are also performed but only performed for transmission scenario 1 to avoid the complexity in SAR and PD measurement (such as, for scenario 3 requiring change in SAR probe calibration file to accommodate different bands and/or tissue simulating liquid).

The strategy for testing in Tx varying transmission condition is outlined as follows:

- Demonstrate the total RF exposure averaged over FCC defined time windows does not exceed FCC's SAR and PD limits, through time-averaged power measurements
  - Measure conducted Tx power (for  $f < 6\text{GHz}$ ) versus time, and radiated Tx power (EIRP for  $f > 10\text{GHz}$ ) versus time.
  - Convert it into RF exposure and divide by respective FCC limits to get normalized exposure versus time.
  - Perform running time-averaging over FCC defined time windows.



- Demonstrate that the total normalized time-averaged RF exposure is less than 1 for all transmission scenarios at all times.

Mathematical expression:

- For sub-6 transmission only:

$$1g\_or\_10gSAR(t) = \frac{conducted\_Tx\_power(t)}{conducted\_Tx\_power\_P_{limit}} * 1g\_or\_10gSAR\_P_{limit} \quad (1a)$$

$$\frac{\frac{1}{T_{SAR}} \int_{t-T_{SAR}}^t 1g\_or\_10gSAR(t) dt}{FCC\ SAR\ limit} \leq 1 \quad (1b)$$

- For sub-6+mmW transmission:

$$1g\_or\_10gSAR(t) = \frac{conducted\_Tx\_power(t)}{conducted\_Tx\_power\_P_{limit}} * 1g\_or\_10gSAR\_P_{limit} \quad (2a)$$

$$4cm^2PD(t) = \frac{radiated\_Tx\_power(t)}{radiated\_Tx\_power\_input.power.limit} * 4cm^2PD\_input.power.limit$$

(2b)

$$\frac{\frac{1}{T_{SAR}} \int_{t-T_{SAR}}^t 1g\_or\_10gSAR(t) dt}{FCC\ SAR\ limit} + \frac{\frac{1}{T_{PD}} \int_{t-T_{PD}}^t 4cm^2PD(t) dt}{FCC\ 4cm^2\ PD\ limit} \leq 1 \quad (2c)$$

where, *conducted\_Tx\_power(t)*, *conducted\_Tx\_power\_P<sub>limit</sub>*, and *1g\_or\_10gSAR\_P<sub>limit</sub>* correspond to the measured instantaneous conducted Tx power, measured conducted Tx power at *P<sub>limit</sub>*, and measured *1gSAR* or *10gSAR* values at *P<sub>limit</sub>* corresponding to sub-6 transmission. Similarly, *radiated\_Tx\_power(t)*, *radiated\_Tx\_power\_input.power.limit*, and *4cm<sup>2</sup>PD\_input.power.limit* correspond to the measured instantaneous radiated Tx power, radiated Tx power at *input.power.limit* (i.e., radiated power limit), and *4cm<sup>2</sup>PD* value at *input.power.limit* corresponding to mmW transmission. Both *P<sub>limit</sub>* and *input.power.limit* are the parameters pre-defined in Part 0 and loaded via Embedded File System (EFS) onto the EUT. *T<sub>SAR</sub>* is the FCC defined time window for sub-6 radio; *T<sub>PD</sub>* is the FCC defined time window for mmW radio.

- Demonstrate the total RF exposure averaged over FCC defined time windows does not exceed FCC’s SAR and PD limits, through time-averaged SAR and PD measurements. Note as mentioned earlier, this measurement is performed for transmission scenario 1 only.
  - For sub-6 transmission only, measure instantaneous SAR versus time; for LTE+sub6 NR transmission, request low power (or all-down bits) on LTE so that measured SAR predominantly corresponds to sub6 NR.



- For LTE + mmW transmission, measure instantaneous E-field versus time for mmW radio and instantaneous conducted power versus time for LTE radio.
- Convert it into RF exposure and divide by respective FCC limits to obtain normalized exposure versus time.
- Perform time averaging over FCC defined time window.
- Demonstrate that the total normalized time-averaged RF exposure is less than 1 for transmission scenario 1 at all times.

Mathematical expression:

- For sub-6 transmission only:

$$1g\_or\_10gSAR(t) = \frac{pointSAR(t)}{pointSAR\_P_{limit}} * 1g\_or\_10gSAR(t)\_P_{limit} \quad (3a)$$

$$\frac{\frac{1}{T_{SAR}} \int_{t-T_{SAR}}^t 1g\_or\_10gSAR(t) dt}{FCC\ SAR\ limit} \leq 1 \quad (3b)$$

- For LTE+mmW transmission:

$$1g\_or\_10gSAR(t) = \frac{conducted\_Tx\_power(t)}{conducted\_Tx\_power\_P_{limit}} * 1g\_or\_10gSAR\_P_{limit} \quad (4a)$$

$$4cm^2PD(t) = \frac{[pointE(t)]^2}{[pointE\_input.power.limit]^2} * 4cm^2PD\_input.power.limit \quad (4b)$$

$$\frac{\frac{1}{T_{SAR}} \int_{t-T_{SAR}}^t 1g\_or\_10gSAR(t) dt}{FCC\ SAR\ limit} + \frac{\frac{1}{T_{PD}} \int_{t-T_{PD}}^t 4cm^2PD(t) dt}{FCC\ 4cm^2PD\ limit} \leq 1 \quad (4c)$$

where,  $pointSAR(t)$ ,  $pointSAR\_P_{limit}$ , and  $1g\_or\_10gSAR\_P_{limit}$  correspond to the measured instantaneous point SAR, measured point SAR at  $P_{limit}$ , and measured 1gSAR or 10gSAR values at  $P_{limit}$  corresponding to sub-6 transmission. Similarly,  $pointE(t)$ ,  $pointE\_input.power.limit$ , and  $4cm^2PD\_input.power.limit$  correspond to the measured instantaneous E-field, E-field at  $input.power.limit$ , and  $4cm^2PD$  value at  $input.power.limit$  corresponding to mmW transmission.

**NOTE:** cDASY6 measurement system by Schmid & Partner Engineering AG (SPEAG ) of Zurich, Switzerland measures relative E-field, and provides ratio of  $\frac{[pointE(t)]^2}{[pointE\_input.power.limit]^2}$  versus time.





### 3 SAR Time Averaging Validation Test Procedures

---

This chapter provides the test plan and test procedure for validating Qualcomm Smart Transmit feature for sub-6 transmission. The 100 seconds time window for operating  $f < 3\text{GHz}$  is used as an example to detail the test procedures in this chapter.

#### 3.1 Test sequence determination for validation

Following the FCC recommendation, two test sequences having time-variation in Tx power are predefined for sub-6 ( $f < 6\text{GHz}$ ) validation:

- Test sequence 1: request EUT's Tx power to be at maximum power, measured  $P_{max}^{\dagger}$ , for 80s, then requesting for half of the maximum power, i.e., measured  $P_{max}/2$ , for the rest of the time.
- Test sequence 2: request EUT's Tx power to vary with time. This sequence is generated relative to measured  $P_{max}$ , measured  $P_{limit}$  and calculated  $P_{reserve}$  (= measured  $P_{limit}$  in dBm - Reserve\_power\_margin in dB) of EUT based on measured  $P_{limit}$ .

The details for generating these two test sequences is described and listed in Appendix A.

**NOTE:** For test sequence generation, “measured  $P_{limit}$ ” and “measured  $P_{max}$ ” are used instead of the “ $P_{limit}$ ” specified in EFS entry and “ $P_{max}$ ” specified for the device, because Smart Transmit feature operates against the actual power level of the “ $P_{limit}$ ” that was calibrated for the EUT. The “measured  $P_{limit}$ ” accurately reflects what the feature is referencing to, therefore, it should be used during feature validation testing. The RF tune up and device-to-device variation are already considered in Part 0 report prior to determining  $P_{limit}$ .

#### 3.2 Test configuration selection criteria for validating Smart Transmit feature

For validating Smart Transmit feature, this section provides a general guidance to select test cases. In practice, an adjustment can be made in test case selection. The justification/clarification may be provided.

##### 3.2.1 Test configuration selection for time-varying Tx power transmission

The Smart Transmit time averaging feature operation is independent of bands, modes, and channels for a given technology. Hence, validation of Smart Transmit in one band/mode/channel per technology is sufficient.

The criteria for the selection are based on the  $P_{limit}$  values determined in Part 0 report. Select the band in each supported technology that corresponds to the  $P_{limit}$  value that is less than  $P_{max}$  for validating Smart Transmit.

\*



### 3.2.2 Test configuration selection for change in call

The criteria to select a test configuration for call-drop measurement is:

- Select technology/band with least  $P_{limit}$  among all supported technologies/bands, and select the radio configuration (e.g., # of RBs, channel#) in this technology/band that corresponds to the highest *measured* 1gSAR at  $P_{limit}$  listed in Part 1 report.
- In case of multiple bands having same least  $P_{limit}$ , then select the band having the highest *measured* 1gSAR at  $P_{limit}$  in Part 1 report.

This test is performed with the EUT's Tx power requested to be at maximum power, the above band selection will result in Tx power enforcement (i.e., EUT forced to have Tx power at  $P_{reserve}$ ) for longest duration in one FCC defined time window. The call change (call drop/reestablish) is performed during the Tx power enforcement duration (i.e., during the time when EUT is forced to have Tx power at  $P_{reserve}$ ). One test is sufficient as the feature operation is independent of technology and band.

### 3.2.3 Test configuration selection for change in technology/band

The selection criteria for this measurement is, for a given antenna, to have EUT switch from a technology/band with lowest  $P_{limit}$  within the technology group (in case of multiple bands having the same  $P_{limits}$ , then select the band with highest *measured* 1gSAR at  $P_{limit}$ ) to a technology/band with highest  $P_{limit}$  within the technology group, in case of multiple bands having the same  $P_{limits}$ , then select the band with lowest *measured* 1gSAR at  $P_{limit}$  in Part 1 report, or vice versa.

This test is performed with the EUT's Tx power requested to be at maximum power, the technology/band switch is performed during Tx power enforcement duration (i.e., during the time when EUT is forced to have Tx power at  $P_{reserve}$ ).

### 3.2.4 Test configuration selection for change in DSI

The criteria to select a test configuration for DSI change test is

- Select a technology/band having the  $P_{limit} < P_{max}$  within any technology and DSI group, and for the same technology/band having a different  $P_{limit}$  in any other DSI group. Note that the selected DSI transition need to be supported by the device.

This test is performed with the EUT's Tx power requested to be at maximum power in selected technology/band, and DSI change is conducted during Tx power enforcement duration (i.e., during the time when EUT is forced to have Tx power at  $P_{reserve}$ ).

### 3.2.5 Test configuration selection for SAR exposure switching

If supported, the test configuration for SAR exposure switching should cover

1. SAR exposure switch when two active radios are in the same time window
2. SAR exposure switch when two active radios are in different time windows. One test with two active radios in any two different time windows is sufficient as Smart Transmit operation is the same for RF exposure switch in any combination of two different time windows. For device supporting LTE + mmW NR, this test is covered in Section 8.2.3 and 8.2.4.



The Smart Transmit time averaging operation is independent of the source of SAR exposure (for example, LTE vs. Sub6 NR) and ensures total time-averaged RF exposure compliance. Hence, validation of Smart Transmit in any one simultaneous SAR transmission scenario (i.e., one combination for LTE + Sub6 NR transmission) is sufficient, where the SAR exposure varies among SAR<sub>radio1</sub> only, SAR<sub>radio1</sub> + SAR<sub>radio2</sub>, and SAR<sub>radio2</sub> only scenarios.

The criteria to select a test configuration for validating Smart Transmit feature during SAR exposure switching scenarios is

- Select any two < 6GHz technologies/bands that the EUT supports simultaneous transmission (for example, LTE+Sub6 NR).
- Among all supported simultaneous transmission configurations, the selection order is
  1. select one configuration where both  $P_{limit}$  of radio1 and radio2 is less than their corresponding  $P_{max}$ , preferably, with different  $P_{limits}$ . If this configuration is not available, then,
  2. select one configuration that has  $P_{limit}$  less than its  $P_{max}$  for at least one radio. If this can not be found, then,
  3. select one configuration that has  $P_{limit}$  of radio1 and radio2 greater than  $P_{max}$  but with least ( $P_{limit} - P_{max}$ ) delta.

Test for one simultaneous transmission scenario is sufficient as the feature operation is the same.

### 3.3 Test procedures for conducted power measurements

This section provides general conducted power measurement procedures to perform compliance test under dynamic transmission scenarios described in Section 2. In practice, an adjustment can be made in these procedures. The justification/clarification may be provided.

#### 3.3.1 Time-varying Tx power transmission scenario

This test is performed with the two pre-defined test sequences described in Section 3.1 for all the technologies and bands selected in Section 3.2.1. The purpose of the test is to demonstrate the effectiveness of power limiting enforcement and that the time-averaged SAR (corresponding time-averaged Tx power) does not exceed the FCC limit at all times (see Eq. (1a) and (1b)).

#### Test procedure

1. Measure  $P_{max}$ , measure  $P_{limit}$  and calculate  $P_{reserve}$  (= measured  $P_{limit}$  in dBm – *Reserve\_power\_margin* in dB) and follow Section 3.1 to generate the test sequences for all the technologies and bands selected in Section 3.2.1. Both test sequence 1 and test sequence 2 are created based on measured  $P_{max}$  and measured  $P_{limit}$  of the EUT. Test condition to measure  $P_{max}$  and  $P_{limit}$  is:
  - Measure  $P_{max}$  with Smart Transmit disabled and callbox set to request maximum power.

- Measure  $P_{limit}$  with Smart Transmit enabled and *Reserve\_power\_margin* set to 0 dB, callbox set to request maximum power.

Set *Reserve\_power\_margin* to actual (intended) value (3dB for this EUT based on Part 1 report) and reset power on EUT to enable Smart Transmit, establish radio link in desired radio configuration, with callbox requesting the EUT’s Tx power to be at pre-defined test sequence 1, measure and record Tx power versus time, and then convert the conducted Tx power into 1gSAR or 10gSAR value (see Eq. (1a)) using measured  $P_{limit}$  from above Step 1. Perform running time average to determine time-averaged power and 1gSAR or 10gSAR versus time as illustrated in Figure 3-1 where using 100-seconds time window as an example.

**NOTE:** In Eq.(1a), instantaneous Tx power is converted into instantaneous 1gSAR or 10gSAR value by applying the measured worst-case 1gSAR or 10gSAR value at  $P_{limit}$  for the corresponding technology/band/antenna/DSI reported in Part 1 report.

**NOTE:** For an easier computation of the running time average, 0 dBm can be added at the beginning of the test sequences the length of the responding time window, for example, add 0dBm for 100-seconds so the running time average can be directly performed starting with the first 100-seconds data using excel spreadsheet. This technique applies to all tests performed in this Part 2 report for easier time-averaged computation using excel spreadsheet.

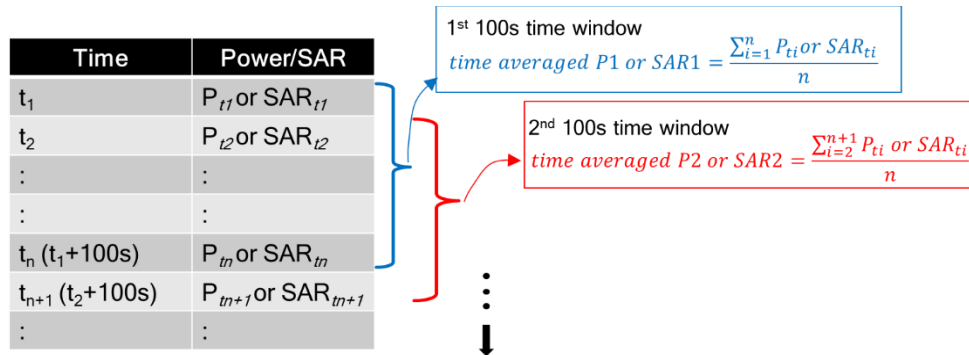

**Figure 3-1 100s running average illustration**

Make one plot containing:

Instantaneous Tx power versus time measured in Step 2,

Requested Tx power used in Step 2 (test sequence 1),

Computed time-averaged power versus time determined in Step 2,

Time-averaged power limit (corresponding to FCC SAR limit of 1.6 W/kg for 1gSAR or 4.0W/kg for 10gSAR) given by

$$Time\ avearged\ power\ limit = meas.P_{limit} + 10 \times \log\left(\frac{FCC\ SAR\ limit}{meas.SAR\_Plimit}\right) \quad (5a)$$

where  $meas.P_{limit}$  and  $meas.SAR\_Plimit$  correspond to measured power at  $P_{limit}$  and measured SAR at  $P_{limit}$ .

Make another plot containing:



Computed time-averaged 1gSAR or 10gSAR versus time determined in Step 2

FCC  $1gSAR_{limit}$  of 1.6W/kg or FCC  $10gSAR_{limit}$  of 4.0W/kg.

Repeat Steps 2 ~ 4 for pre-defined test sequence 2 and replace the requested Tx power (test sequence 1) in Step 2 with test sequence 2.

Repeat Steps 2 ~ 5 for all the selected technologies and bands.

The validation criteria are, at all times, the time-averaged power versus time shown in Step 3 plot shall not exceed the time-averaged power limit (defined in Eq. (5a)), in turn, the time-averaged 1gSAR or 10gSAR versus time shown in Step 4 plot shall not exceed the FCC limit of 1.6 W/kg for 1gSAR or 4.0 W/kg for 10gSAR (i.e., Eq. (1b)).

### 3.3.2 Change in call scenario

This test is to demonstrate that Smart Transmit feature accurately accounts for the past Tx powers during time-averaging when a new call is established.

The call disconnect and re-establishment needs to be performed during power limit enforcement, i.e., when the EUT's Tx power is at  $P_{reserve}$  level, to demonstrate the continuity of RF exposure management and limiting in call change scenario. In other words, the RF exposure averaged over any FCC defined time window (including the time windows containing the call change) doesn't exceed FCC limit of 1.6 W/kg for 1gSAR or 4.0 W/kg for 10gSAR.

#### Test procedure

1. Measure  $P_{limit}$  for the technology/band selected in Section 3.2.2. Measure  $P_{limit}$  with Smart Transmit enabled and *Reserve\_power\_margin* set to 0 dB, callbox set to request maximum power.

Set *Reserve\_power\_margin* to actual (intended) value and reset power on EUT to enable Smart Transmit.

Establish radio link with callbox in the selected technology/band.

Request EUT's Tx power at 0 dBm for at least one time window specified for the selected technology/band, followed by requesting EUT's Tx power to be at maximum power for about ~60 seconds, and then drop the call for ~10 seconds. Afterwards, re-establish another call in the same radio configuration (i.e., same technology/band/channel) and continue callbox requesting EUT's Tx power to be at maximum power for the remaining time of at least another full duration of the specified time window. Measure and record Tx power versus time. Once the measurement is done, extract instantaneous Tx power versus time, convert the measured conducted Tx power into 1gSAR or 10gSAR value using Eq. (1a), and then perform the running time average to determine time-averaged power and 1gSAR or 10gSAR versus time.

**NOTE:** In Eq.(1a), instantaneous Tx power is converted into instantaneous 1gSAR or 10gSAR value by applying the measured worst-case 1gSAR or 10gSAR value at  $P_{limit}$  for the corresponding technology/band/antenna/DSI reported in Part 1 report.

Make one plot containing: (a) instantaneous Tx power versus time, (b) requested power, (c) computed time-averaged power, (d) time-averaged power limit calculated using Eq.(5a).



Make another plot containing: (a) computed time-averaged 1gSAR or 10gSAR versus time, and (b) FCC limit of 1.6 W/kg for 1gSAR or 4.0 W/kg for 10gSAR.

The validation criteria are, at all times, the time-averaged power versus time shall not exceed the time-averaged power limit (defined in Eq.(5a)), in turn, the time-averaged 1gSAR or 10gSAR versus time shall not exceed the FCC limit of 1.6 W/kg for 1gSAR or 4.0 W/kg for 10gSAR (i.e., Eq. (1b)).

### 3.3.3 Change in technology and band

This test is to demonstrate the correct power control by Smart Transmit during technology switches and/or band handovers.

Similar to the change in call test in Section 3.3.2, to validate the continuity of RF exposure limiting during the transition, the technology and band handover needs to be performed when EUT's Tx power is at  $P_{reserve}$  level (i.e., during Tx power enforcement) to make sure that the EUT's Tx power from previous  $P_{reserve}$  level to the new  $P_{reserve}$  level (corresponding to new technology/band). Since the  $P_{limit}$  could vary with technology and band, Eq. (1a) can be written as follows to convert the instantaneous Tx power in 1gSAR or 10gSAR exposure for the two given radios, respectively:

$$1g\_or\_10gSAR_1(t) = \frac{conducted\_Tx\_power\_1(t)}{conducted\_Tx\_power\_P_{limit\_1}} * 1g\_or\_10gSAR\_P_{limit\_1} \quad (6a)$$

$$1g\_or\_10gSAR_2(t) = \frac{conducted\_Tx\_power\_2(t)}{conducted\_Tx\_power\_P_{limit\_2}} * 1g\_or\_10gSAR\_P_{limit\_2} \quad (6b)$$

$$\frac{1}{T_{SAR}} \left[ \int_{t-T_{SAR}}^{t_1} \frac{1g\_or\_10gSAR_1(t)}{FCC\ SAR\ limit} dt + \int_{t-T_{SAR}}^t \frac{1g\_or\_10gSAR_2(t)}{FCC\ SAR\ limit} dt \right] \leq 1 \quad (6c)$$

where,  $conducted\_Tx\_power\_1(t)$ ,  $conducted\_Tx\_power\_P_{limit\_1}$ , and  $1g\_or\_10gSAR\_P_{limit\_1}$  correspond to the measured instantaneous conducted Tx power, measured conducted Tx power at  $P_{limit}$ , and measured 1gSAR or 10gSAR value at  $P_{limit}$  of technology1/band1;  $conducted\_Tx\_power\_2(t)$ ,  $conducted\_Tx\_power\_P_{limit\_2}(t)$ , and  $1g\_or\_10gSAR\_P_{limit\_2}$  correspond to the measured instantaneous conducted Tx power, measured conducted Tx power at  $P_{limit}$ , and measured 1gSAR or 10gSAR value at  $P_{limit}$  of technology2/band2. Transition from technology1/band1 to the technology2/band2 happens at time-instant ' $t_1$ '.

#### Test procedure

1. Measure  $P_{limit}$  for both the technologies and bands selected in Section 3.2.3. Measure  $P_{limit}$  with Smart Transmit enabled and *Reserve\_power\_margin* set to 0 dB, callbox set to request maximum power.

Set *Reserve\_power\_margin* to actual (intended) value and reset power on EUT to enable Smart Transmit

Establish radio link with callbox in first technology/band selected.

Request EUT's Tx power at 0 dBm for at least one time window specified for the selected technology/band, followed by requesting EUT's Tx power to be at maximum power for about ~60 seconds, and then switch to second technology/band selected. Continue with callbox requesting EUT's Tx power to be at maximum power for the remaining time of at least another full duration of the specified time window. Measure and record Tx power versus time for the full duration of the test.



Once the measurement is done, extract instantaneous Tx power versus time, and convert the conducted Tx power into 1gSAR or 10gSAR value using Eq. (6a) and (6b) and corresponding measured  $P_{limit}$  values from Step 1 of this section. Perform the running time average to determine time-averaged power and 1gSAR or 10gSAR versus time.

**NOTE:** In Eq.(6a) & (6b), instantaneous Tx power is converted into instantaneous 1gSAR or 10gSAR value by applying the measured worst-case 1gSAR or 10gSAR value at  $P_{limit}$  for the corresponding technology/band/antenna/DSI reported in Part 1 report.

Make one plot containing: (a) instantaneous Tx power versus time, (b) requested power, (c) computed time-averaged power, (d) time-averaged power limit calculated using Eq.(5a).

Make another plot containing: (a) computed time-averaged 1gSAR or 10gSAR versus time, and (b) FCC limit of 1.6 W/kg for 1gSAR or 4.0 W/kg for 10gSAR.

The validation criteria are, at all times, the time-averaged 1gSAR or 10gSAR versus time shall not exceed the FCC limit of 1.6 W/kg for 1gSAR or 4.0 W/kg for 10gSAR (i.e., Eq. (6c)).

### 3.3.4 Change in antenna

This test is to demonstrate the correct power control by Smart Transmit during antenna switches from one antenna to another. The test procedure is identical to Section 3.3.3, by replacing technology/band switch operation with antenna switch. The validation criteria are, at all times, the time-averaged 1gSAR or 10gSAR versus time shall not exceed FCC limit of 1.6 W/kg for 1gSAR or 4.0 W/kg for 10gSAR.

**NOTE:** If the EUT does not support antenna switch within the same technology/band, but has multiple antennas to support different frequency bands, then the antenna switch test is included as part of change in technology and band (Section 3.3.3) test.

### 3.3.5 Change in DSI

This test is to demonstrate the correct power control by Smart Transmit during DSI switches from one DSI to another. The test procedure is identical to Section 3.3.3, by replacing technology/band switch operation with DSI switch. The validation criteria are, at all times, the time-averaged 1gSAR or 10gSAR versus time shall not exceed FCC limit of 1.6 W/kg for 1gSAR or 4.0 W/kg for 10gSAR.

### 3.3.6 Change in time window

This test is to demonstrate the correct power control by Smart Transmit during the change in averaging time window when a specific band handover occurs. FCC specifies time-averaging windows of 100s for Tx frequency < 3GHz, and 60s for Tx frequency between 3GHz and 6GHz.

To validate the continuity of RF exposure limiting during the transition, the band handover test needs to be performed when EUT handovers from operation band less than 3GHz to greater than 3GHz and vice versa. The equations (3a) and (3b) in Section 2 can be written as follows for transmission scenario having change in time window,

$$1gSAR_1(t) = \frac{\text{conducted\_Tx\_power\_1}(t)}{\text{conducted\_Tx\_power\_Plimit\_1}} * 1g\_or\ 10g\_SAR\_Plimit\_1 \quad (7a)$$

$$1gSAR_2(t) = \frac{\text{conducted\_Tx\_power\_2}(t)}{\text{conducted\_Tx\_power\_Plimit\_2}} * 1g\_or\ 10g\_SAR\_Plimit\_2 \quad (7b)$$

$$\frac{1}{T1_{SAR}} \left[ \int_{t-T1_{SAR}}^{t_1} \frac{1g\_or\ 10g\_SAR_1(t)}{FCC\ SAR\ limit} dt \right] + \frac{1}{T2_{SAR}} \left[ \int_{t-T2_{SAR}}^t \frac{1g\_or\ 10g\_SAR_2(t)}{FCC\ SAR\ limit} dt \right] \leq 1 \quad (7c)$$

where, *conducted\_Tx\_power\_1(t)*, *conducted\_Tx\_power\_Plimit\_1(t)*, and *1g\_ or 10g\_SAR\_Plimit\_1* correspond to the instantaneous Tx power, conducted Tx power at  $P_{limit_1}$  and compliance *1g\_ or 10g\_SAR* values at  $P_{limit_1}$  of band1 with time-averaging window ' $T1_{SAR}$ '; *conducted\_Tx\_power\_2(t)*, *conducted\_Tx\_power\_Plimit\_2(t)*, and *1g\_ or 10g\_SAR\_Plimit\_2* correspond to the instantaneous Tx power, conducted Tx power at  $P_{limit_2}$  and compliance *1g\_ or 10g\_SAR* values at  $P_{limit_2}$  of band2 with time-averaging window ' $T2_{SAR}$ '. One of the two bands is less than 3GHz, another is greater than 3GHz. Transition from first band with time-averaging window ' $T1_{SAR}$ ' to the second band with time-averaging window ' $T2_{SAR}$ ' happens at time-instant ' $t_1$ '.

### Test procedure

2. Measure  $P_{limit}$  for both the technologies and bands selected in Section 3.2.6. Measure  $P_{limit}$  with Smart Transmit enabled and *Reserve\_power\_margin* set to 0 dB, callbox set to request maximum power.
3. Set *Reserve\_power\_margin* to actual (intended) value and enable Smart Transmit

### Transition from 100s time window to 60s time window, and vice versa

4. Establish radio link with callbox in the technology/band having 100s time window selected in Section 3.2.6.
5. Request EUT's Tx power to be at 0 dBm for at least 100 seconds, followed by requesting EUT's Tx power to be at maximum power for about ~140 seconds, and then switch to second technology/band (having 60s time window) selected in Section 3.2.6. Continue with callbox requesting EUT's Tx power to be at maximum power for about ~60s in this second technology/band, and then switch back to the first technology/band. Continue with callbox requesting EUT's Tx power to be at maximum power for at least another 100s. Measure and record Tx power versus time for the entire duration of the test.
6. Once the measurement is done, extract instantaneous Tx power versus time, and convert the conducted Tx power into 1gSAR or 10gSAR value (see Eq. (7a) and (7b)) using corresponding technology/band Step 1 result, and then perform 100s running average to determine time-averaged 1gSAR or 10gSAR versus time. Note that in Eq.(7a) & (7b), instantaneous Tx power is converted into instantaneous 1gSAR or 10gSAR value by applying the worst-case 1gSAR or 10gSAR value tested in Part 1 for the selected technologies/bands at  $P_{limit}$ .
7. Make one plot containing: (a) instantaneous Tx power versus time measured in Step 4.





8. Make another plot containing: (a) instantaneous 1gSAR versus time determined in Step 5, (b) computed time-averaged 1gSAR versus time determined in Step 5, and (c) corresponding regulatory  $1gSAR_{limit}$  of 1.6W/kg or  $10gSAR_{limit}$  of 4.0W/kg.

#### Transition from 60s time window to 100s time window, and vice versa

9. Establish radio link with callbox in the technology/band having 60s time window selected in Section 3.2.6.
10. Request EUT's Tx power to be at 0 dBm for at least 60 seconds, followed by requesting EUT's Tx power to be at maximum power for about ~80 seconds, and then switch to second technology/band (having 100s time window) selected in Section 3.2.6. Continue with callbox requesting EUT's Tx power to be at maximum power for about ~100s in this second technology/band, and then switch back to the first technology/band. Continue with callbox requesting EUT's Tx power to be at maximum power for the remaining time for a total test time of 500 seconds. Measure and record Tx power versus time for the entire duration of the test.
11. Repeat above Step 5~7 to generate the plots

The validation criteria is, at all times, the time-averaged 1gSAR or 10gSAR versus time shall not exceed the regulatory  $1gSAR_{limit}$  of 1.6W/kg or  $10gSAR_{limit}$  of 4.0W/kg

### 3.3.7 SAR exposure switching

This test is to demonstrate that Smart Transmit feature accurately accounts for switching in exposures among SAR from radio1 only, SAR from both radio1 and radio2, and SAR from radio2 only scenarios, and ensures total time-averaged RF exposure complies with the FCC limit. Here, radio1 represents primary radio (for example, LTE anchor in a NR non-standalone mode call) and radio2 represents secondary radio (for example, sub6 NR or mmW NR). The detailed test procedure for SAR exposure switching in the case of LTE+Sub6 NR non-standalone mode transmission scenario is provided in Appendix B.2.

#### Test procedure:

1. Measure conducted Tx power corresponding to  $P_{limit}$  for radio1 and radio2 in selected band. Test condition to measure conducted  $P_{limit}$  is:
  - Establish device in call with the callbox for radio1 technology/band. Measure conducted Tx power corresponding to radio1  $P_{limit}$  with Smart Transmit enabled and Reserve\_power\_margin set to 0 dB, callbox set to request maximum power.
  - Repeat above step to measure conducted Tx power corresponding to radio2  $P_{limit}$ . If radio2 is dependent on radio1 (for example, non-standalone mode of Sub6 NR requiring radio1 LTE as anchor), then establish radio1 + radio2 call with callbox, and request all down bits for radio1 LTE. In this scenario, with callbox requesting maximum power from radio2 Sub6 NR, measured conducted Tx power corresponds to radio2  $P_{limit}$  (as radio1 LTE is at all-down bits)
2. Set Reserve\_power\_margin to actual (intended) value, with EUT setup for radio1 + radio2 call. In this description, it is assumed that radio2 has lower priority than radio1. Establish device in radio1+radio2 call, and request all-down bits or low power on



radio1, with callbox requesting EUT's Tx power to be at maximum power in radio2 for at least one time window. After one time window, set callbox to request EUT's Tx power to be at maximum power on radio1, i.e., all-up bits. Continue radio1+radio2 call with both radios at maximum power for at least one time window, and drop (or request all-down bits on) radio2. Continue radio1 at maximum power for at least one time window. Record the conducted Tx power for both radio1 and radio2 for the entire duration of this test.

3. Once the measurement is done, extract instantaneous Tx power versus time for both radio1 and radio2 links. Convert the conducted Tx power for both these radios into 1gSAR or 10gSAR value (see Eq. (6a) and (6b)) using corresponding technology/band  $P_{limit}$  measured in Step 1, and then perform the running time average to determine time-averaged 1gSAR or 10gSAR versus time.
4. Make one plot containing: (a) instantaneous Tx power versus time measured in Step 2.
5. Make another plot containing: (a) instantaneous 1gSAR versus time determined in Step 3, (b) computed time-averaged 1gSAR versus time determined in Step 3, and (c) corresponding regulatory  $1gSAR_{limit}$  of 1.6W/kg or  $10gSAR_{limit}$  of 4.0W/kg.

The validation criteria is, at all times, the time-averaged 1gSAR or 10gSAR versus time shall not exceed the regulatory  $1gSAR_{limit}$  of 1.6W/kg or  $10gSAR_{limit}$  of 4.0W/kg.

### 3.4 Test procedure for time-varying SAR measurements

This section provides general time-varying SAR measurement procedures to perform compliance test under dynamic transmission scenarios described in Section 2. In practice, an adjustment can be made in these procedures. The justification/clarification may be provided.

To perform the validation through SAR measurement for transmission scenario 1 described in Section 2, the "path loss" between callbox antenna and EUT needs to be calibrated to ensure that the EUT Tx power reacts to the requested power from callbox in a radiated call. It should be noted that when signaling in closed loop mode, protocol-level power control is in play, resulting in EUT not solely following callbox TPC (Tx power control) commands. In other words, EUT response has many dependencies (RSSI, quality of signal, path loss variation, fading, etc.) other than just TPC commands. These dependencies have less impact in conducted setup (as it is a controlled environment and the path loss can be very well calibrated) but have significant impact on radiated testing in an uncontrolled environment, such as SAR test setup. Therefore, the deviation in EUT Tx power from callbox requested power is expected, however the time-averaged SAR should not exceed FCC SAR requirement at all times as Smart Transmit controls Tx power at EUT.

The following steps are for time averaging feature validation through SAR measurement:

1. "Path Loss" calibration: Place the EUT against the phantom in the worst-case position determined based on Section 3.2.1. For each band selected, prior to SAR measurement, perform "path loss" calibration between callbox antenna and EUT. Since the SAR test environment is not controlled and well calibrated for OTA (Over the Air) test, extreme care needs to be taken to avoid the influence from reflections. The test setup is described in Section 7.1.



## Time averaging feature validation:

For a given radio configuration (technology/band) selected in Section 3.2.1, enable Smart Transmit and set *Reserve\_power\_margin* to 0 dB, with callbox to request maximum power, perform area scan, conduct pointSAR measurement at peak location of the area scan. This point SAR value, *pointSAR\_P<sub>limit</sub>*, corresponds to point SAR at the measured *P<sub>limit</sub>* (i.e., measured *P<sub>limit</sub>* from the EUT in Step 1 of Section 3.3.1).

Set *Reserve\_power\_margin* to actual (intended) value and reset power on EUT to enable Smart Transmit. Note, if *Reserve\_power\_margin* cannot be set wirelessly, care must be taken to re-position the EUT in the exact same position relative to the SAM phantom as in above Step 2.i. Establish radio link in desired radio configuration, with callbox requesting the EUT's Tx power at power levels described by test sequence 1 generated in Step 1 of Section 3.3.1, conduct point SAR measurement versus time at peak location of the area scan determined in Step 2.i of this section. Once the measurement is done, extract instantaneous point SAR vs time data, *pointSAR(t)*, and convert it into instantaneous 1gSAR or 10gSAR vs. time using Eq. (3a), re-written below:

$$1g\_or\_10gSAR(t) = \frac{pointSAR(t)}{pointSAR\_P_{limit}} * 1g\_or\_10gSAR\_P_{limit}$$

where, *pointSAR\_P<sub>limit</sub>* is the value determined in Step 2.i, and *pointSAR(t)* is the instantaneous point SAR measured in Step 2.ii, *1g\_or\_10gSAR\_P<sub>limit</sub>* is the measured 1gSAR or 10gSAR value listed in Part 1 report.

Perform 100s running average to determine time-averaged 1gSAR or 10gSAR versus time.

Make one plot containing: (a) time-averaged 1gSAR or 10gSAR versus time determined in Step 2.iii of this section, (b) FCC limit of 1.6 W/kg for 1gSAR or 4.0 W/kg for 10gSAR.

Repeat 2.ii ~ 2.iv for test sequence 2 generated in Step 1 of Section 3.3.1.

Repeat 2.i ~ 2.v for all the technologies and bands selected in Section 3.2.1.

The time-averaging validation criteria for SAR measurement is that, at all times, the time-averaged 1gSAR or 10gSAR versus time shall not exceed FCC limit of 1.6 W/kg for 1gSAR or 4.0 W/kg for 10gSAR (i.e., Eq. (3b)).



## 4 PD Time Averaging Validation Test Procedures

---

This chapter provides the test plan and test procedures for validating Qualcomm Smart Transmit feature for mmW transmission. For this EUT, millimeter wave (mmW) transmission is only in non-standalone mode, i.e., it requires an LTE link as anchor.

### 4.1 Test sequence for validation in mmW NR transmission

In 5G mmW NR transmission, the test sequence for validation is with the callbox requesting EUT's Tx power in 5G mmW NR at maximum power all the time.

### 4.2 Test configuration selection criteria for validating Smart Transmit feature

#### 4.2.1 Test configuration selection for time-varying Tx power transmission

The Smart Transmit time averaging feature operation is independent of bands, modes, channels, and antenna configurations (beams) for a given technology. Hence, validation of Smart Transmit in any one band/mode/channel per technology is sufficient.

#### 4.2.2 Test configuration selection for change in antenna configuration (beam)

The Smart Transmit time averaging feature operation is independent of bands, modes, channels, and antenna configurations (beams) for a given technology. Hence, validation of Smart Transmit with beam switch between any two beams is sufficient.

#### 4.2.3 Test configuration selection for SAR vs. PD exposure switch during transmission

The Smart Transmit time averaging feature operation is independent of the nature of exposure (SAR vs. PD) and ensures total time-averaged RF exposure compliance. Hence, validation of Smart Transmit in any one band/mode/channel/beam for mmW + sub-6 (LTE) transmission is sufficient, where the exposure varies among SAR dominant scenario, SAR+PD scenario, and PD dominant scenario.

### 4.3 Test procedures for mmW radiated power measurements

Perform conducted power measurement (for  $f < 6\text{GHz}$ ) and radiated power measurement (for  $f > 6\text{GHz}$ ) for LTE + mmW transmission to validate Smart Transmit time averaging feature in the various transmission scenarios described in Section 2.

This section provides general conducted power measurement procedures to perform compliance test under dynamic transmission scenarios described in Section 2. In practice, an adjustment can be made in these procedures. The justification/clarification may be provided.



### 4.3.1 Time-varying Tx power scenario

The purpose of the test is to demonstrate the effectiveness of power limiting enforcement and that the time-averaged Tx power when converted into RF exposure values does not exceed the FCC limit at all times (see Eq. (2a), (2b) & (2c) in Section 2).

#### Test procedure:

1. Measure conducted Tx power corresponding to  $P_{limit}$  for LTE in selected band, and measure radiated Tx power corresponding to *input.power.limit* in desired mmW band/channel/beam by following below steps:
  - a. Measure radiated power corresponding to mmW *input.power.limit* by setting up the EUT's Tx power in desired band/channel/beam at *input.power.limit* in Factory Test Mode (FTM). This test is performed in a calibrated anechoic chamber. Rotate the EUT to obtain maximum radiated Tx power, keep the EUT in this position and do not disturb the position of the EUT inside the anechoic chamber for the rest of this test.
  - b. Reset EUT to place in online mode and establish radio link in LTE, measure conducted Tx power corresponding to LTE  $P_{limit}$  with Smart Transmit enabled and *Reserve\_power\_margin* set to 0 dB, callbox set to request maximum power.

Set *Reserve\_power\_margin* to actual (intended) value and reset power on EUT to enable Smart Transmit. With EUT setup for a mmW NR call in the desired/selected LTE band and mmW NR band, perform the following steps:

Establish LTE and mmW NR connection in desired band/channel/beam used in Step 1. As soon as the mmW connection is established, immediately request all-down bits on LTE link. With callbox requesting EUT's Tx power to be at maximum mmW power to test predominantly PD exposure scenario (as SAR exposure is less when LTE's Tx power is at low power).

After 120s, request LTE to go all-up bits for at least 100s. SAR exposure is dominant. There are two scenarios:

If  $P_{limit} < P_{max}$  for LTE, then the RF exposure margin (provided to mmW NR) gradually runs out (due to high SAR exposure). This results in gradual reduction in the 5G mmW NR transmission power and eventually seized 5G mmW NR transmission when LTE goes to  $P_{reserve}$  level.

If  $P_{limit} \geq P_{max}$  for LTE, then the 5G mmW NR transmission's averaged power should gradually reduce but the mmW NR connection can sustain all the time (assuming TxAGC uncertainty = 0dB).

Record the conducted Tx power of LTE and radiated Tx power of mmW for the full duration of this test of at least 300s.

Once the measurement is done, extract instantaneous Tx power versus time for both LTE and mmW links. Convert the conducted Tx power for LTE into 1gSAR or 10gSAR value using Eq. (2a) and  $P_{limit}$  measured in Step 1.b, and then divide by FCC limit of 1.6 W/kg for 1gSAR or 4.0 W/kg for 10gSAR to obtain instantaneous normalized 1gSAR or 10gSAR versus time. Perform 100s running average to determine normalized 100s-averaged 1gSAR or 10gSAR versus time.



**NOTE:** In Eq.(2a), instantaneous Tx power is converted into instantaneous 1gSAR or 10gSAR value by applying the measured worst-case 1gSAR or 10gSAR value at  $P_{limit}$  for the corresponding technology/band/antenna/DSI reported in Part 1 report.

Similarly, convert the radiated Tx power for mmW into  $4\text{cm}^2\text{PD}$  value using Eq. (2b) and the radiated Tx power limit (i.e., radiated Tx power at *input.power.limit*) measured in Step 1.a, then divide by FCC  $4\text{cm}^2\text{PD}$  limit of  $10\text{W}/\text{m}^2$  to obtain instantaneous normalized  $4\text{cm}^2\text{PD}$  versus time. Perform 4s running average to determine normalized 4s-averaged  $4\text{cm}^2\text{PD}$  versus time.

**NOTE:** In Eq.(2b), instantaneous radiated Tx power is converted into instantaneous  $4\text{cm}^2\text{PD}$  by applying the worst-case  $4\text{cm}^2\text{PD}$  value measured at *input.power.limit* for the selected band/beam in Part 1 report.

Make one plot containing: (a) instantaneous conducted Tx power for LTE versus time, (b) computed 100s-averaged conducted Tx power for LTE versus time, (c) instantaneous radiated Tx power for mmW versus time, as measured in Step 2, (d) computed 4s-averaged radiated Tx power for mmW versus time, and (e) time-averaged conducted and radiated power limits for LTE and mmW radio using Eq. (5a) & (5b), respectively:

$$\text{Time averaged LTE power limit} = \text{meas. } P_{limit} + 10 \times \log\left(\frac{\text{FCC SAR limit}}{\text{meas.SAR\_Plimit}}\right) \quad (5a)$$

$$\text{Time averaged mmW NR power limit} = \text{meas. } EIRP_{input.power.limit} + 10 \times \log\left(\frac{\text{FCC PD limit}}{\text{meas.PD\_input.power.limit}}\right) \quad (5b)$$

where *meas. EIRP<sub>input.power.limit</sub>* and *meas. PD\_input.power.limit* correspond to measured EIRP at *input.power.limit* and measured power density at *input.power.limit*.

Make another plot containing: (a) computed normalized 100s-averaged 1gSAR or 10gSAR versus time determined in Step 3, (b) computed normalized 4s-averaged  $4\text{cm}^2\text{PD}$  versus time determined in Step 4, and (c) corresponding total normalized time-averaged RF exposure (sum of steps (6.a) and (6.b)) versus time.

The validation criteria are, at all times, the total normalized time-averaged RF exposure versus time determined in Step 6.c shall not exceed the normalized limit of 1.0 of FCC requirement (i.e., Eq. (2c)).

### 4.3.2 Switch in SAR vs. PD exposure during transmission

This test is to demonstrate that Smart Transmit feature is independent of the nature of exposure (SAR vs. PD), accurately accounts for switching in exposures among SAR dominant, SAR+PD, and PD dominant scenarios, and ensures total time-averaged RF exposure compliance.

#### Test procedure:

1. Measure conducted Tx power corresponding to  $P_{limit}$  for LTE in selected band, and measure radiated Tx power corresponding to *input.power.limit* in desired mmW band/channel/beam by following below steps:



- a. Measure radiated power corresponding to *input.power.limit* by setting up the EUT's Tx power in desired band/channel/beam at *input.power.limit* in FTM. This test is performed in a calibrated anechoic chamber. Rotate the EUT to obtain maximum radiated Tx power, keep the EUT in this position and do not disturb the position of the EUT inside the anechoic chamber for the rest of this test.
- b. Reset EUT to place in online mode and establish radio link in LTE, measure conducted Tx power corresponding to LTE  $P_{limit}$  with Smart Transmit enabled and *Reserve\_power\_margin* set to 0 dB, callbox set to request maximum power.

Set *Reserve\_power\_margin* to actual (intended) value and reset power in EUT, with EUT setup for LTE + mmW call, perform the following steps:

- a. Establish LTE (sub-6) and mmW NR connection with callbox.
- b. As soon as the mmW connection is established, immediately request all-down bits on LTE link. Continue LTE (all-down bits) + mmW transmission for more than 100s duration to test predominantly PD exposure scenario (as SAR exposure is negligible from all-down bits in LTE).
- c. After 120s, request LTE to go all-up bits, mmW transmission should gradually run out of RF exposure margin if LTE's  $P_{limit} < P_{max}$  and seize mmW transmission (SAR only scenario); or mmW transmission should gradually reduce in Tx power and will sustain the connection if LTE's  $P_{limit} > P_{max}$ .
- d. After 120s, request LTE to go all-down bits, mmW transmission should start getting back RF exposure margin and resume transmission again.
- e. Record the conducted Tx power of LTE and radiated Tx power of mmW for the entire duration of this test of at least 300s.

Once the measurement is done, extract instantaneous Tx power versus time for both LTE and mmW links. Convert the conducted Tx power for LTE into 1gSAR or 10gSAR value using Eq. (2a) and  $P_{limit}$  measured in Step 1.b, and then divide by FCC limit of 1.6 W/kg for 1gSAR or 4.0 W/kg for 10gSAR to obtain instantaneous normalized 1gSAR or 10gSAR versus time. Perform 100s running average to determine normalized 100s-averaged 1gSAR or 10gSAR versus time.

**NOTE:** In Eq.(2a), instantaneous Tx power is converted into instantaneous 1gSAR or 10gSAR value by applying the measured worst-case 1gSAR or 10gSAR value at  $P_{limit}$  for the corresponding technology/band/antenna/DSI reported in Part 1 report.

Similarly, convert the radiated Tx power for mmW into  $4\text{cm}^2\text{PD}$  value using Eq. (2b) and the radiated Tx power limit (i.e., radiated Tx power at *input.power.limit*) measured in Step 1.a, then divide this by FCC  $4\text{cm}^2\text{PD}$  limit of  $10\text{W}/\text{m}^2$  to obtain instantaneous normalized  $4\text{cm}^2\text{PD}$  versus time. Perform 4s running average to determine normalized 4s-averaged  $4\text{cm}^2\text{PD}$  versus time.

**NOTE:** In Eq.(2b), instantaneous radiated Tx power is converted into instantaneous  $4\text{cm}^2\text{PD}$  by applying the worst-case  $4\text{cm}^2\text{PD}$  value measured at *input.power.limit* for the selected band/beam in Part 1 report.



Make one plot containing: (a) instantaneous conducted Tx power for LTE versus time, (b) computed 100s-averaged conducted Tx power for LTE versus time, (c) instantaneous radiated Tx power for mmW versus time, as measured in Step 2, (d) computed 4s-averaged radiated Tx power for mmW versus time, and (e) time-averaged conducted and radiated power limits for LTE and mmW radio using Eq. (5a) & (5b), respectively.

Make another plot containing: (a) computed normalized 100s-averaged 1gSAR or 10gSAR versus time determined in Step 3, (b) computed normalized 4s-averaged 4cm<sup>2</sup>PD versus time determined in Step 4, and (c) corresponding total normalized time-averaged RF exposure (sum of steps (6.a) and (6.b)) versus time.

The validation criteria are, at all times, the total normalized time-averaged RF exposure versus time determined in Step 6.c shall not exceed the normalized limit of 1.0 of FCC requirement (i.e., Eq. (2c)).

### 4.3.3 Change in antenna configuration (beam)

This test is to demonstrate the correct power control by Smart Transmit during changes in antenna configuration (beam). Since the *input.power.limit* varies with beam, the Eq. (2a), (2b) and (2c) in Section 2 are written as below for transmission scenario having change in beam,

$$1g\_or\_10gSAR(t) = \frac{conducted\_Tx\_power(t)}{conducted\_Tx\_power\_P_{limit}} * 1g\_or\_10gSAR\_P_{limit} \quad (8a)$$

$$4cm^2PD_1(t) = \frac{radiated\_Tx\_power\_1(t)}{radiated\_Tx\_power\_input.power.limit_1} * 4cm^2PD\_input.power.limit_1 \quad (8b)$$

$$4cm^2PD_2(t) = \frac{radiated\_Tx\_power\_2(t)}{radiated\_Tx\_power\_input.power.limit_2} * 4cm^2PD\_input.power.limit_2 \quad (8c)$$

$$\frac{\frac{1}{T_{SAR}} \int_{t-T_{SAR}}^t 1g\_or\_10gSAR(t) dt}{FCC\ SAR\ limit} + \frac{\frac{1}{T_{PD}} \left[ \int_{t-T_{PD}}^{t_1} 4cm^2PD_1(t) dt + \int_{t_1}^t 4cm^2PD_2(t) dt \right]}{FCC\ 4cm^2\ PD\ limit} \leq 1 \quad (8d)$$

where, *conducted\_Tx\_power(t)*, *conducted\_Tx\_power\_P<sub>limit</sub>*, and *1g\_or\_10gSAR\_P<sub>limit</sub>* correspond to the measured instantaneous conducted Tx power, measured conducted Tx power at *P<sub>limit</sub>*, and measured 1gSAR or 10gSAR values at *P<sub>limit</sub>* corresponding to LTE transmission. Similarly, *radiated\_Tx\_power\_1(t)*, *radiated\_Tx\_power\_input.power.limit\_1*, and *4cm<sup>2</sup>PD\_input.power.limit\_1* correspond to the measured instantaneous radiated Tx power, radiated Tx power at *input.power.limit*, and *4cm<sup>2</sup>PD* value at *input.power.limit* of beam 1; *radiated\_Tx\_power\_2(t)*, *radiated\_Tx\_power\_input.power.limit\_2*, and *4cm<sup>2</sup>PD\_input.power.limit\_2* correspond to the measured instantaneous radiated Tx power, radiated Tx power at *input.power.limit*, and *4cm<sup>2</sup>PD* value at *input.power.limit* of beam 2 corresponding to mmW transmission.



**Test procedure:**

1. Measure conducted Tx power corresponding to  $P_{limit}$  for LTE in selected band, and measure radiated Tx power corresponding to *input.power.limit* in desired mmW band/channel/beam by following below steps:
  - a. Measure radiated power corresponding to mmW *input.power.limit* by setting up the EUT's Tx power in desired band/channel at *input.power.limit* of beam 1 in FTM. Do not disturb the position of the EUT inside the anechoic chamber for the rest of this test. Repeat this Step 1.a for beam 2.
  - b. Reset EUT to place in online mode and establish radio link in LTE, measure conducted Tx power corresponding to LTE  $P_{limit}$  with Smart Transmit enabled and *Reserve\_power\_margin* set to 0 dB, callbox set to request maximum power.

Set *Reserve\_power\_margin* to actual (intended) value and reset power in EUT, With EUT setup for LTE + mmW connection, perform the following steps:

- a. Establish LTE (sub-6) and mmW NR connection in beam 1. As soon as the mmW connection is established, immediately request all-down bits on LTE link with the callbox requesting EUT's Tx power to be at maximum mmW power.
- b. After beam 1 continues transmission for at least 20s, request the EUT to change from beam 1 to beam 2, and continue transmitting with beam 2 for at least 20s.
- c. Record the conducted Tx power of LTE and radiated Tx power of mmW for the entire duration of this test.

Once the measurement is done, extract instantaneous Tx power versus time for both LTE and mmW links. Convert the conducted Tx power for LTE into 1gSAR or 10gSAR value using the similar approach described in Step 3 of Section 4.3.2. Perform 100s running average to determine normalized 100s-averaged 1gSAR versus time.

Similarly, convert the radiated Tx power for mmW NR into  $4\text{cm}^2\text{PD}$  value using Eq. (8b), (8c) and the radiated Tx power limits (i.e., radiated Tx power at *input.power.limit*) measured in Step 1.a for beam 1 and beam 2, respectively, and then divide the resulted PD values by FCC  $4\text{cm}^2\text{PD}$  limit of  $10\text{W}/\text{m}^2$  to obtain instantaneous normalized  $4\text{cm}^2\text{PD}$  versus time for beam 1 and beam 2. Perform 4s running average to determine normalized 4s-averaged  $4\text{cm}^2\text{PD}$  versus time.

**NOTE:** In Eq.(8b) and (8c), instantaneous radiated Tx power of beam 1 and beam 2 is converted into instantaneous  $4\text{cm}^2\text{PD}$  by applying the worst-case  $4\text{cm}^2\text{PD}$  value measured at the *input.power.limit* of beam 1 and beam 2 in Part 1 report, respectively.

Since the measured radiated powers for beam 1 and beam 2 in Step 1.a were performed at an arbitrary rotation of EUT in anechoic chamber, repeat Step 1.a of this procedure by rotating the EUT to determine maximum radiated power at *input.power.limit* in FTM mode for both beams separately. Re-scale the measured instantaneous radiated power in Step 2.c by the delta in radiated power measured in Step 5 and the radiated power measured in Step 1.a for plotting purposes in next Step. In other words, this step essentially converts measured instantaneous



radiated power during the measurement in Step 2 into maximum instantaneous radiated power for both beams. Perform 4s running average to compute 4s-averaged radiated Tx power. Additionally, use these EIRP values measured at *input.power.limit* at respective peak locations to determine the EIRP limits (using Eq. (5b)) for both these beams.

Make one plot containing: (a) instantaneous conducted Tx power for LTE versus time, (b) computed 100s-averaged conducted Tx power for LTE versus time, (c) instantaneous radiated Tx power for mmW versus time, as obtained in Step 5, (d) computed 4s-averaged radiated Tx power for mmW versus time, as obtained in Step 5, and (e) time-averaged conducted and radiated power limits for LTE and mmW radio, respectively.

Make another plot containing: (a) computed normalized 100s-averaged 1gSAR versus time determined in Step 3, (b) computed normalized 4s-averaged 4cm<sup>2</sup>PD versus time determined in Step 4, and (c) corresponding total normalized time-averaged RF exposure (sum of steps (6.a) and (6.b)) versus time.

The validation criteria are, at all times, the total normalized time-averaged RF exposure versus time determined in Step 6.c shall not exceed the normalized limit of 1.0 of FCC requirement (i.e., (8d)).

#### 4.4 Test procedure for time-varying PD measurements

The following steps are used to perform the validation through PD measurement for transmission scenario 1 described in Section 2:

1. Place the EUT on the cDASY6 platform to perform PD measurement in the worst-case position/surface for the selected mmW band/beam. In PD measurement, the callbox is set to request maximum Tx power from EUT all the time. Hence, “path loss” calibration between callbox antenna and EUT is not needed in this test.

Time averaging feature validation:

Measure conducted Tx power corresponding to  $P_{limit}$  for LTE in selected band, and measure point E-field corresponding to *input.power.limit* in desired mmW band/channel/beam by following the below steps:

- i. Measure conducted Tx power corresponding to LTE  $P_{limit}$  with Smart Transmit enabled and *Reserve\_power\_margin* set to 0 dB, with callbox set to request maximum power.
- ii. Measure point E-field at peak location of fast area scan corresponding to *input.power.limit* by setting up the EUT's Tx power in desired mmW band/channel/beam at *input.power.limit* in FTM. Do not disturb the position of EUT and mmW cDASY6 probe.

Set *Reserve\_power\_margin* to actual value (i.e., intended value) and reset power on EUT, place EUT in online mode. With EUT setup for LTE (sub-6) + mmW NR call, as soon as the mmW NR connection is established, request all-down bits on LTE link. Continue LTE (all-down bits) + mmW transmission for more than 100s duration to test predominantly PD exposure scenario. After 120s, request LTE to go all-up bits, mmW transmission should gradually reduce. Simultaneously, record the conducted Tx power of LTE transmission using power meter and point E-field (in terms of ratio of  $\frac{[pointE(t)]^2}{[pointE_{input.power.limit}]^2}$ ) of mmW transmission using cDASY6 E-field probe at peak location identified in Step 2.a.ii for the entire duration of this test of at least 300s.



Once the measurement is done, extract instantaneous conducted Tx power versus time for LTE transmission and  $\frac{[pointE(t)]^2}{[pointE\_input.power.limit]^2}$  ratio versus time from cDASY6 system for mmW transmission. Convert the conducted Tx power for LTE into 1gSAR or 10gSAR value using Eq. (4a) and  $P_{limit}$  measured in Step 2.a.i, and then divide this by FCC limit of 1.6 W/kg for 1gSAR or 4.0 W/kg for 10gSAR to obtain instantaneous normalized 1gSAR or 10gSAR versus time. Perform 100s running average to determine normalized 100s-averaged 1gSAR or 10gSAR versus time

**NOTE:** In Eq.(4a), instantaneous Tx power is converted into instantaneous 1gSAR or 10gSAR value by applying the measured worst-case 1gSAR or 10gSAR value at  $P_{limit}$  for the corresponding technology/band reported in Part 1 report.

Similarly, convert the point E-field for mmW transmission into  $4cm^2PD$  value using Eq. (4b) and radiated power limit measured in Step 2.a.ii, and then divide this by FCC  $4cm^2PD$  limit of  $10W/m^2$  to obtain instantaneous normalized  $4cm^2PD$  versus time. Perform 4s running average to determine normalized 4s-averaged  $4cm^2PD$  versus time.

Make one plot containing: (i) computed normalized 100s-averaged 1gSAR or 10gSAR versus time determined in Step 2.c, (ii) computed normalized 4s-averaged  $4cm^2PD$  versus time determined in Step 2.d, and (iii) corresponding total normalized time-averaged RF exposure (sum of steps (2.e.i) and (2.e.ii)) versus time.

The validation criteria are, at all times, the total normalized time-averaged RF exposure versus time determined in Step 2.e.iii shall not exceed the normalized limit of 1.0 of FCC requirement (i.e., Eq. (4c)).



## 5 Test Configurations

### 5.1 WWAN (sub-6) transmission

The Plimit values, corresponding to SAR\_design\_target, for technologies and bands supported by EUT are derived in Part 0 report and summarized in Table 5-1. Note all  $P_{limit}$  power levels entered in Table 5-1 correspond to average power levels after accounting for duty cycle in the case of TDD modulation schemes (for e.g., GSM, LTE TDD & Sub6 NR TDD).

**Table 5-1:  $P_{limit}$  for supported technologies and bands ( $P_{limit}$  in EFS file)**

Band	Antenna	1g SAR design target (W/kg)	TDD duty cycle	Plimit*	Pmax * (dBm)
				Body (DSI:1)	
WCDMA II	TX0	0.95	100.00%	21.9	23.0
WCDMA V	TX0	0.95	100.00%	25.2	23.0
LTE B2	TX0	0.95	100.00%	22.1	23.0
LTE B2	TX1	0.95	100.00%	25.6	23.0
LTE B66/4	TX0	0.95	100.00%	21.5	23.0
LTE B66	TX1	0.95	100.00%	22.9	23.0
LTE B5	TX0	0.95	100.00%	26.5	23.0
LTE B12/B17	TX0	0.95	100.00%	25.6	23.0
LTE B13	TX0	0.95	100.00%	24.2	23.0
LTE B41(PC3)**	TX0	0.95	63.30%	15.7	21.0
LTE B48(PC3)**	TX0	0.95	63.30%	25.7	21.0
n2	TX0	0.95	100.00%	22.8	23.0
n2	TX1	0.95	100.00%	24.8	23.0
n5	TX0	0.95	100.00%	25.5	23.0
n66	TX0	0.95	100.00%	22.8	23.0
n66	TX1	0.95	100.00%	23.8	23.0
n77/n78(PC3)	TX0	0.55	100.00%	22.0	23.0
n77(PC2)	TX0	0.55	100.00%		25.0

\*Pmax is used for RF tune up procedure. The maximum allowed output power is equal to Pmax + device uncertainty.

\*\*All Plimit power levels entered in the Table correspond to average power levels after accounting for duty cycle in the case TDD modulation schemes (for e.g., GSM & LTE TDD & NR TDD).



Based on selection criteria described in Section 3.2.1, the selected technologies/bands for testing time-varying test sequences are listed in Table 5-3, the Reserve\_power\_margin (dB) for XHG-RG1000 is set to 3dB in EFS, and is used in Part 2 test.

The radio configurations used in Part 2 test for selected technologies, bands, DSIs and antennas are listed in Table 5-2. The corresponding worst-case radio configuration 1gSAR or 10gSAR values for selected technology/band/DSI are extracted from Part 1 report and are listed in the last column of Table 5-2.

Based on equations (1a), (2a), (3a) and (4a), it is clear that Part 2 testing outcome is normalized quantity, which implies that it can be applied to any radio configuration within a selected technology/band/DSI. Thus, as long as applying the worst-case SAR obtained from the worst radio configuration in Part 1 testing to calculate time-varying SAR exposure in equations (1a), (2a), (3a) and (4a), the accuracy in compliance demonstration remains the same.

**Table 5-2: Radio configurations selected for Part 2 test**

Test case #	Test scenario	Tech	Band	Transmit Ant	Channel	Freq (MHz)	BW	RB size	RB offset	mode	position	Position details	Part 1, SAR@Plimit 1-g SAR (W/kg)
1	Time-Varying TX power transmission	WCDMA	B2	0	9262	1852.4	-	-	-	RMC	Body,10mm	Back	1.040
2		LTE	B2	0	18700	1860	20M	1	0	QPSK	Body,10mm	Back	1.010
3		LTE	B41(PC3)	0	39750	2506	20M	1	0	QPSK	Body,10mm	Bottom Side	1.080
4		5G NR SA PC2	n77(PC2)	0	656000	3840	100M	1	1	BPSK	Body,10mm	Back	0.553
5	Call Drop	LTE	B41(PC3)	0	39750	2506	20M	1	0	QPSK	Body,10mm	Bottom Side	1.080
6	Tech/band switch	LTE	B41(PC3)	0	39750	2506	20M	1	0	QPSK	Body,10mm	Bottom Side	1.080
		WCDMA	2	0	9262	1852.4	-	-	-	RMC	Body,10mm	Back	1.040
7	Change in Time Window (100-60-100s)/ Antenna switch	LTE	B41(PC3)	0(MLB Antenna)	39750	2506	20M	1	0	QPSK	Body,10mm	Bottom Side	1.080
		LTE	B48	0(UHB Antenna)	55340	3560	20M	1	0	QPSK	Body,10mm	Front	0.419
8	Change in Time Window (60-100-60s)/ Antenna switch	LTE	B48	0(UHB Antenna)	55340	3560	20M	1	0	QPSK	Body,10mm	Front	0.419
		LTE	B41(PC3)	0(MLB Antenna)	39750	2506	20M	1	0	QPSK	Body,10mm	Bottom Side	1.080
9	EN-DC SAR vs SAR	LTE	B66	0	132572	1770	20M	1	0	QPSK	Body,10mm	Back	0.836
		5G NR NSA PC2	n77(PC2)	0	656000	3840	100M	1	1	BPSK	Body,10mm	Back	0.553

Note: the maximum 1gSAR/or 10gSAR among all exposure scenarios is used in Smart Transmit feature for time averaging operation.



Based on the selection criteria described in Section 3.2, the radio configurations for the Tx varying transmission test cases listed in Section 2 are:

1. Technologies and bands for time-varying Tx power transmission: The test case 1~4 listed in Table 5-2 are selected to test with the test sequences defined in Section 3.1 in both time-varying conducted power measurement and time-varying SAR measurement.
2. Technology and band for change in call test: The test case 5 listed in Table 5-2 are selected for performing the call drop test in conducted power setup. LTE B41 having the lowest  $P_{limit}$  among all technologies and bands
3. Technologies and bands for change in technology/band test: The test case 6 listed in Table 5-2 is selected for handover test from a technology/band to another technology/band, in conducted power setup.
4. Technologies and bands for change in time-window/antenna: The test case 7~8 listed in Table 5-2 is selected for time window switch between 60s window (LTE B48) and 100s window (LTE B41) in conducted power setup. LTE B48 is using different antenna from LTE B41, so this test also address the antenna change.
5. Technologies and bands for switch in SAR exposure: The test case 9 listed in Table 5-2 are selected for SAR exposure switching test in one of the supported simultaneous WWAN transmission scenario, i.e., LTE + 5G NR active in the same 100s time window, in conducted power setup. Since this device supports LTE+mmW NR, test for Section 3.2.7 Scenario 2 for RF exposure switch is covered in Sections 8.2.3 and 8.2.4 between LTE (100s window) and mmW NR (4s window)



### 5.2 LTE + mmW NR transmission

Based on the selection criteria described in Section 4.2, the selections for LTE and mmW NR validation test are listed in Table 5-4. The radio configurations used in this test are listed in Table 5-5.

**Table 5-3 Selections for LTE + mmW NR validation measurements**

Transmission Scenario	Test	Technology and Band	mmW Beam
Time-varying Tx power test	1. Cond. & Rad. Power meas.	LTE Band 66 and n260	Beam ID 36
		LTE Band 66 and n261	Beam ID 28
Switch in SAR vs. PD	1. Cond. & Rad. Power meas.	LTE Band 66 and n260	Beam ID 36
		LTE Band 66 and n261	Beam ID 28
Beam switch test	1. Cond. & Rad. Power meas.	LTE Band 66 and n260	Beam ID 27 to Beam ID 5
		LTE Band 66 and n261	Beam ID 36 to Beam ID 5

**Table 5-4: Test configuration for LTE + mmW NR validation**

Tech	Band	Bean ID	Antenna	Mode	UL Duty Cycle
LTE	66	-	1	QPSK	100%
mmW NR	N260	27,5	Module 0	CP-OFDM, QPSK	>75%
	N261	36,5	Module 0	CP-OFDM, QPSK	>75%

\* mmW NR callbox UL duty cycle should be configured to be greater than 75% for all LTE+mmW NR Part 2 tests. The base station uplink is configured in 76 slots among total 79 slots.



## 6 Conducted Power Test Results for Sub-6 Smart Transmit Feature Validation

---

### 6.1 Measurement setup

The Rohde & Schwarz CMW500 callbox is used in this test. The test setup schematic are shown in Figures 6-1. For single antenna measurement, one port (RF1 COM) of the callbox is connected to the RF port of the EUT using a directional coupler. For antenna & technology switch measurement, two ports (RF1 COM and RF3 COM) of the callbox used for signaling two different technologies are connected to a combiner, which is in turn connected to a directional coupler. The other end of the directional coupler is connected to a splitter to connect to two RF ports of the EUT corresponding to the two antennas of interest. In both the setups, power meter is used to tap the directional coupler for measuring the conducted output power of the EUT. For time averaging validation test (Section 3.3.1), call drop test (Section 3.3.2), and DSI switch test (Section 3.3.4), only RF1 COM port of the callbox is used to communicate with the EUT. For technology/band switch measurement (Section. 3.3.3), both RF1 COM and RF3 COM port of callbox are used to switch from one technology communicating on RF1 COM port to another technology communicating on RF3 COM port. All the path losses from RF port of EUT to the callbox RF COM port and to the power meter are calibrated and automatically entered as offsets in the callbox and the power meter via test scripts on the PC used to control callbox and power meter.

#### LTE+Sub6 NR test setup:

The Keysight UXME7515B callbox is used in this test. If LTE conducted port and Sub6 NR conducted port are same on this EUT (i.e., they share the same antenna), therefore, low-/high-pass filter are used to separate LTE and Sub6 NR signals for power meter measurement via directional couplers, as shown in below Figure 6-1 C (Appendix E – Test Setup Photo ).

All the path losses from RF port of DUT to the callbox RF COM port and to the power meter are calibrated and automatically entered as offsets in the callbox and the power meter via test scripts on the PC used to control callbox and power meter.



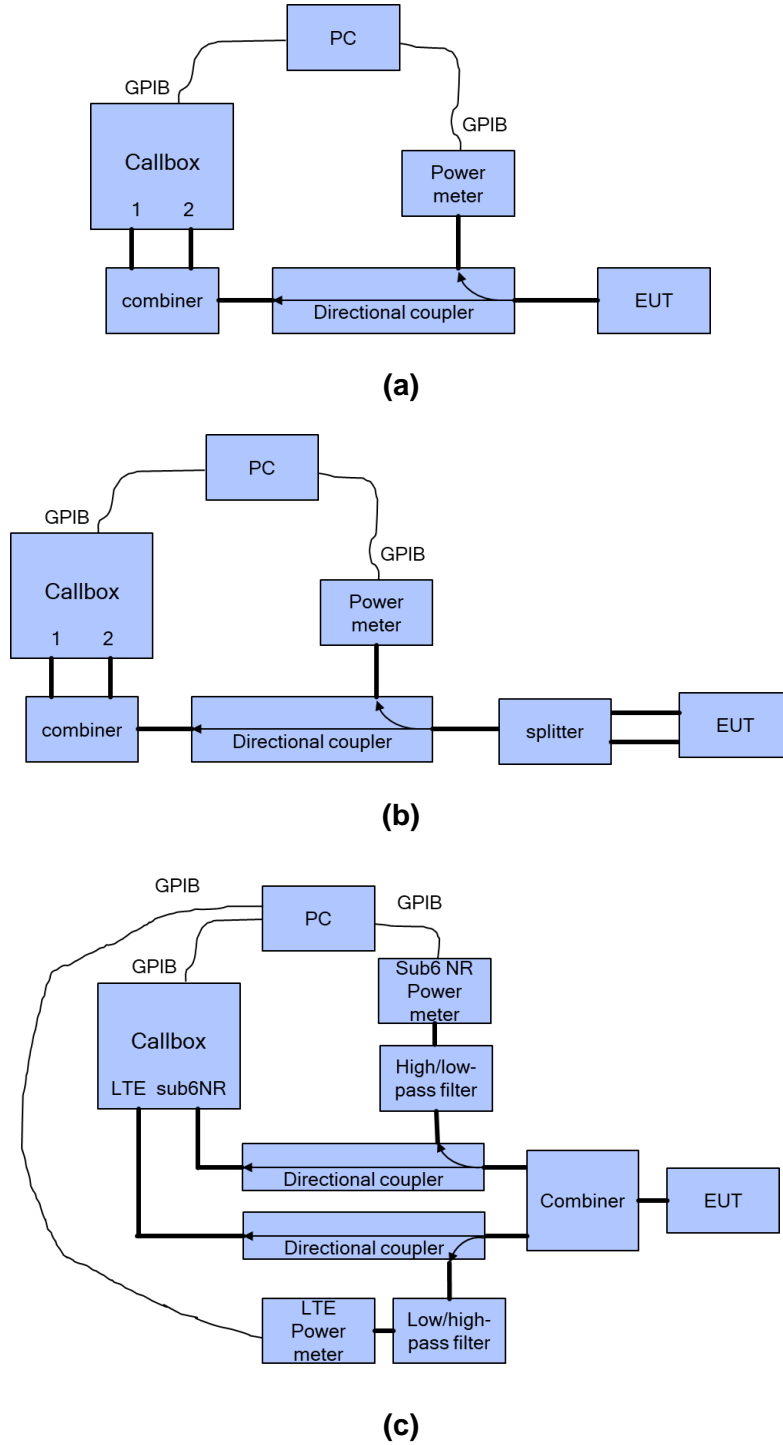

**Figure 6-1 Conducted power measurement setup**

Both the callbox and power meter are connected to the PC using GPIB cables. Two test scripts are custom made for automation, and the test duration set in the test scripts is 500 seconds.



For time-varying Tx power measurement, the PC runs the 1<sup>st</sup> test script to send GPIB commands to control the callbox's requested power versus time, while at the same time to record the conducted power measured at EUT RF port using the power meter. The commands sent to the callbox to request power are:

- 0dBm for 100 seconds
- test sequence 1 or test sequence 2 (defined in Section 3.1 and generated in Section 3.2.1), for 360 seconds
- stay at the last power level of test sequence 1 or test sequence 2 for the remaining time.

Power meter readings are periodically recorded every 100ms. A running average of this measured Tx power over 100 seconds is performed in the post-data processing to determine the 100s-time averaged power.

For call drop, technology/band/antenna switch, and DSI switch tests, after the call is established, the callbox is set to request the EUT's Tx power at 0dBm for 100 seconds while simultaneously starting the 2<sup>nd</sup> test script runs at the same time to start recording the Tx power measured at EUT RF port using the power meter. After the initial 100 seconds since starting the Tx power recording, the callbox is set to request maximum power from the EUT for the rest of the test. Note that the call drop/re-establish, or technology/band/antenna switch or DSI switch is manually performed when the Tx power of EUT is at  $P_{reserve}$  level. See Section 3.3 for detailed test procedure of call drop test, technology/band/antenna switch test and DSI switch test.



### 6.2 $P_{limit}$ and $P_{max}$ measurement results

The measured  $P_{limit}$  for all the selected radio configurations given in Table 5-2 are listed in below Table 6-1.  $P_{max}$  was also measured for radio configurations selected for testing time-varying Tx power transmission scenarios in order to generate test sequences following the test procedures in Section 3.1.

**Table 6-1: Measured  $P_{limit}$  and  $P_{max}$  of selected radio configurations**

Test case #	Test scenario	Tech	Band	Ant	Channel	Freq (MHz)	BW	RB size	RB offset	mode	position	Position details	Plimit EFS setting(dBm)	target pmax (dBm)	measured plimit (dBm)	measured pmax (dBm)
1		WCDMA	B2	0	9262	1852.4	-	-	-	RMC	Body,10mm	Back	21.9	24	22.5	23.5
2	Time-Varying TX power transmission	LTE	B2	0	18700	1860	20M	1	0	QPSK	Body,10mm	Back	22.1	24	22.5	23.6
3		LTE	B41(PC3)	0	39750	2506	20M	1	0	QPSK	Body,10mm	Bottom Side	15.7	22	16.2	21.3
4		5G NR SA PC2	n77(PC2)	0	656000	3840	100M	1	1	BPSK	Body,10mm	Back	22	25	22.3	24.1
5		Call Drop	LTE	B41(PC3)	0	39750	2506	20M	1	0	QPSK	Body,10mm	Bottom Side	15.7	22	16.2
6	Tech/band switch	LTE	B41(PC3)	0	39750	2506	20M	1	0	QPSK	Body,10mm	Bottom Side	15.7	22	16.2	21.3
		WCDMA	2	0	9262	1852.4	-	-	-	RMC	Body,10mm	Back	21.9	24	22.5	23.5
7	Change in Time Window (100-60-100s)/ Antenna switch	LTE	B41(PC3)	0(MLB Antenna)	39750	2506	20M	1	0	QPSK	Body,10mm	Bottom Side	15.7	22	16.2	21.3
		LTE	B48	0(UHB Antenna)	55340	3560	20M	1	0	QPSK	Body,10mm	Front	25.7	22	21.6	21.6
8	Change in Time Window (60-100-60s)/ Antenna switch	LTE	B48	0(UHB Antenna)	55340	3560	20M	1	0	QPSK	Body,10mm	Front	25.7	22	21.6	21.6
		LTE	B41(PC3)	0(MLB Antenna)	39750	2506	20M	1	0	QPSK	Body,10mm	Bottom Side	15.7	22	16.2	21.3
9	EN-DC SAR vs SAR	LTE	B66	0	132572	1770	20M	1	0	QPSK	Body,10mm	Back	21.5	24	22	23.5
		5G NR NSA PC2	n77(PC2)	0	656000	3840	100M	1	1	BPSK	Body,10mm	Back	22	25	22.3	24.1

Note: the device uncertainty of  $P_{max}$  is +1dB/-1dB as provided by manufacturer.



### 6.3 Time-varying Tx power measurement results

The measurement setup is shown in Figures 6-1(a) and 6-1(c). The purpose of the time-varying Tx power measurement is to demonstrate the effectiveness of power limiting enforcement and that the time-averaged Tx power when represented in time-averaged 1gSAR or 10gSAR values does not exceed FCC limit as shown in Eq. (1a) and (1b), rewritten below:

$$1g\_or\_10gSAR(t) = \frac{conducted\_Tx\_power(t)}{conducted\_Tx\_power\_P_{limit}} * 1g\_or\_10gSAR\_P_{limit} \quad (1a)$$

$$\frac{\frac{1}{T_{SAR}} \int_{t-T_{SAR}}^t 1g\_or\_10gSAR(t) dt}{FCC\ SAR\ limit} \leq 1 \quad (1b)$$

where,  $conducted\_Tx\_power(t)$ ,  $conducted\_Tx\_power\_P_{limit}$ , and  $1g\_or\_10gSAR\_P_{limit}$  correspond to the measured instantaneous conducted Tx power, measured conducted Tx power at  $P_{limit}$ , and measured 1gSAR and 10gSAR values at  $P_{limit}$  reported in Part 1 test (listed in Table 5-2 of this report as well).

Following the test procedure in Section 3.3, the conducted Tx power measurement for all selected configurations are reported in this section. In all the conducted Tx power plots, the dotted line represents the requested power by callbox (test sequence 1 or test sequence 2), the blue curve represents the instantaneous conducted Tx power measured using power meter, the green curve represents time-averaged power and red line represents the conducted power limit that corresponds to FCC limit of 1.6 W/kg for 1gSAR or 4.0 W/kg for 10gSAR.

Similarly, in all the 1g or 10gSAR plots (when converted using Eq. (1a)), the green curve represents the 100s/60s-time averaged 1gSAR or 10gSAR value calculated based on instantaneous 1gSAR or 10gSAR; and the red line limit represents the FCC limit of 1.6 W/kg for 1gSAR or 4.0 W/kg for 10gSAR.



### 6.3.1 WCDMA B2

Test result for test sequence 1:

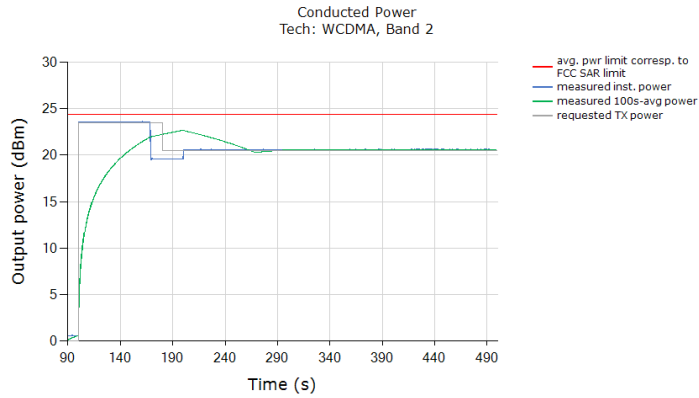

Above time-averaged conducted Tx power is converted/calculated into time-averaged 1gSAR using Equation (1a) and plotted below to demonstrate that the time-averaged 1gSAR versus time does not exceed the FCC limit of 1.6 W/kg for 1gSAR:

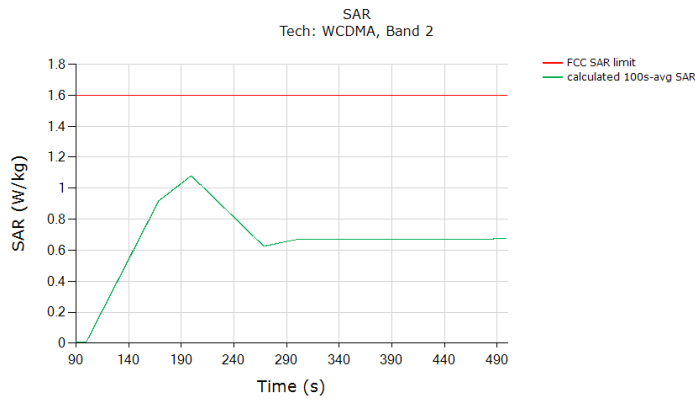

	(W/kg)
FCC 1gSAR limit	1.6
Max 100s-time averaged 1gSAR (green curve)	1.080
<b>Validated:</b> Max time averaged SAR (green curve) does not exceed SAR design target +1dB device uncertainty	



Test result for test sequence 2:

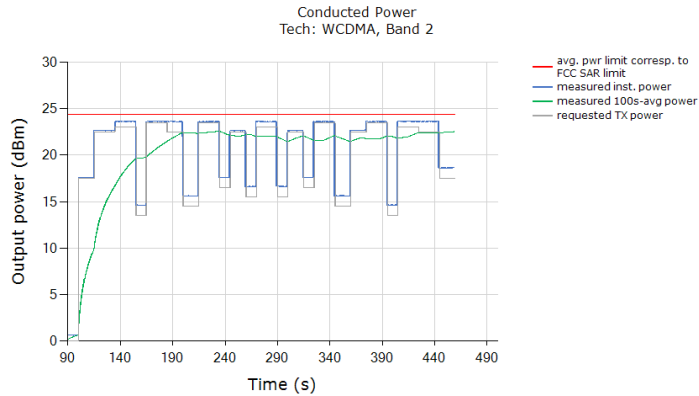

Above time-averaged conducted Tx power is converted/calculated into time-averaged 1gSAR using Equation (1a) and plotted below to demonstrate that the time-averaged 1gSAR versus time does not exceed the FCC limit of 1.6 W/kg for 1gSAR:

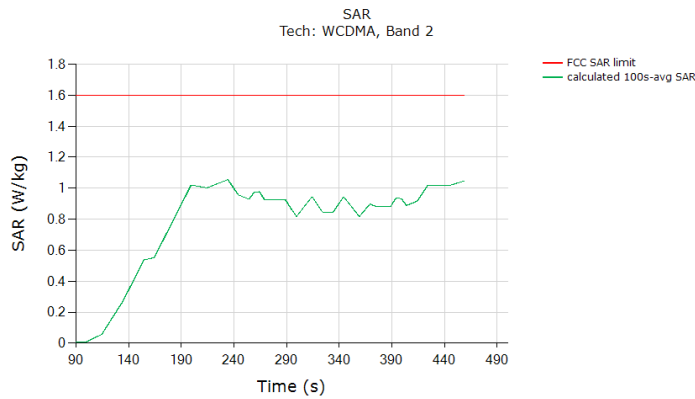

	(W/kg)
FCC 1gSAR limit	1.6
Max 100s-time averaged 1gSAR (green curve)	1.055
<b>Validated:</b> Max time averaged SAR (green curve) does not exceed SAR design target +1dB device uncertainty	



### 6.3.2 LTE B2

Test result for test sequence 1:

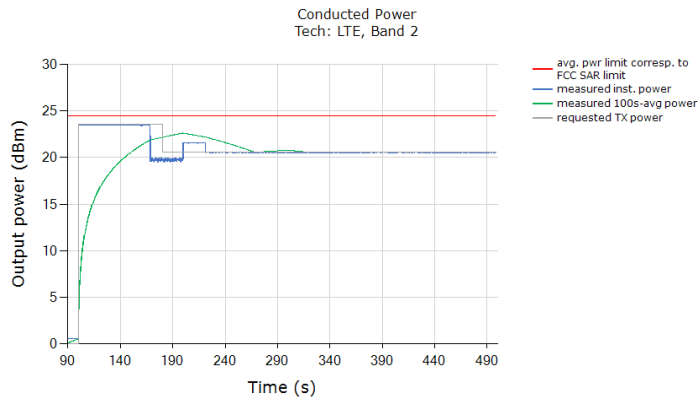

Above time-averaged conducted Tx power is converted/calculated into time-averaged 1gSAR using Equation (1a) and plotted below to demonstrate that the time-averaged 1gSAR versus time does not exceed the FCC limit of 1.6 W/kg for 1gSAR:

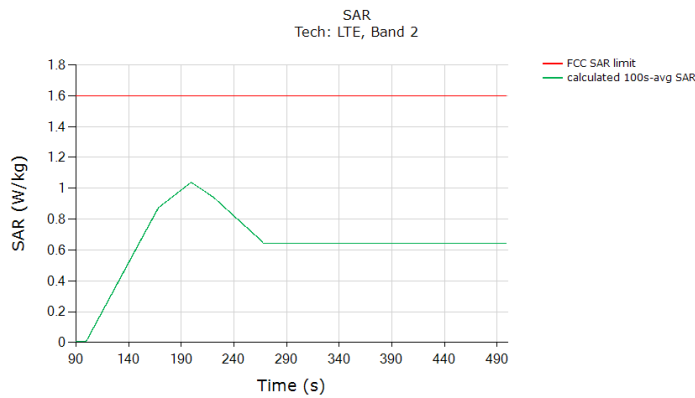

	(W/kg)
FCC 1gSAR limit	1.6
Max 100s-time averaged 10gSAR (green curve)	1.039
<b>Validated:</b> Max time averaged SAR (green curve) does not exceed SAR design target +1dB device uncertainty	



Test result for test sequence 2:

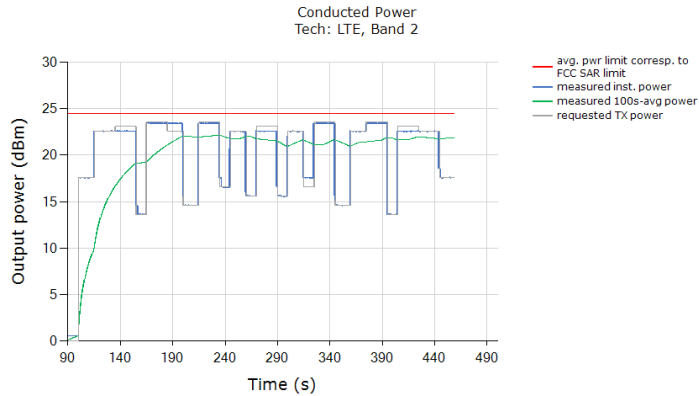

Above time-averaged conducted Tx power is converted/calculated into time-averaged 1gSAR using Equation (1a) and plotted below to demonstrate that the time-averaged 1gSAR versus time does not exceed the FCC limit of 1.6 W/kg for 1gSAR:

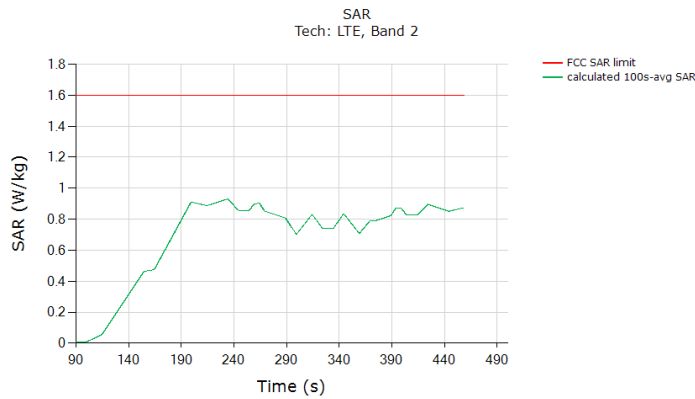

	(W/kg)
FCC 1gSAR limit	1.6
Max 100s-time averaged 1gSAR (green curve)	0.931
<b>Validated:</b> Max time averaged SAR (green curve) does not exceed SAR design target +1dB device uncertainty	





### 6.3.3 LTE B41

Test result for test sequence 1:

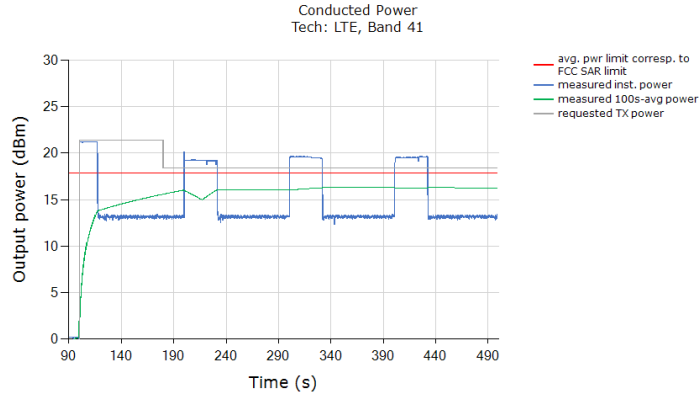

Above time-averaged conducted Tx power is converted/calculated into time-averaged 1gSAR using Equation (1a) and plotted below to demonstrate that the time-averaged 1gSAR versus time does not exceed the FCC limit of 1.6 W/kg for 1gSAR:

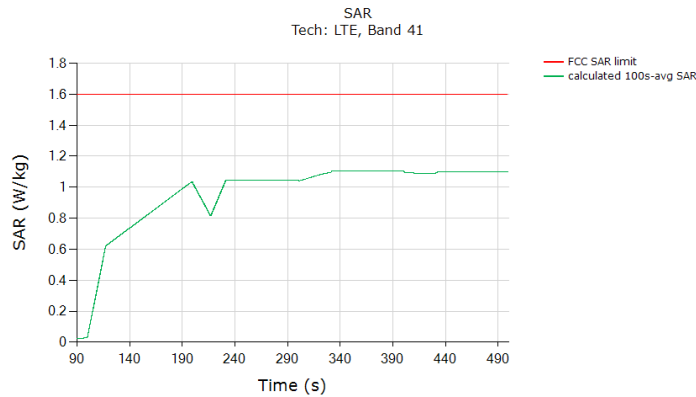

	(W/kg)
FCC 1gSAR limit	1.6
Max 100s-time averaged 1gSAR (green curve)	1.104
<b>Validated:</b> Max time averaged SAR (green curve) does not exceed SAR design target +1dB device uncertainty	



Test result for test sequence 2:

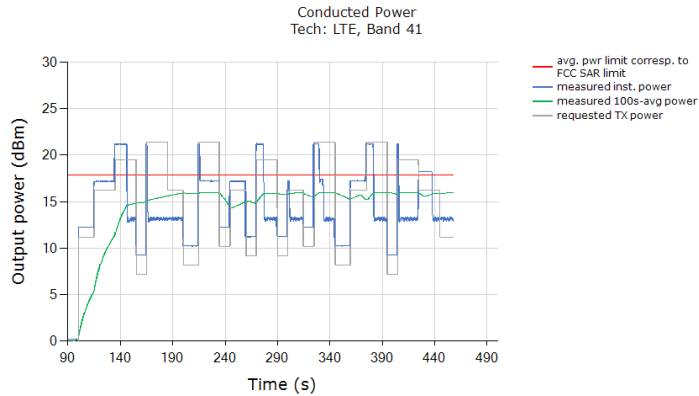

Above time-averaged conducted Tx power is converted/calculated into time-averaged 1gSAR using Equation (1a) and plotted below to demonstrate that the time-averaged 1gSAR versus time does not exceed the FCC limit of 1.6 W/kg for 1gSAR:

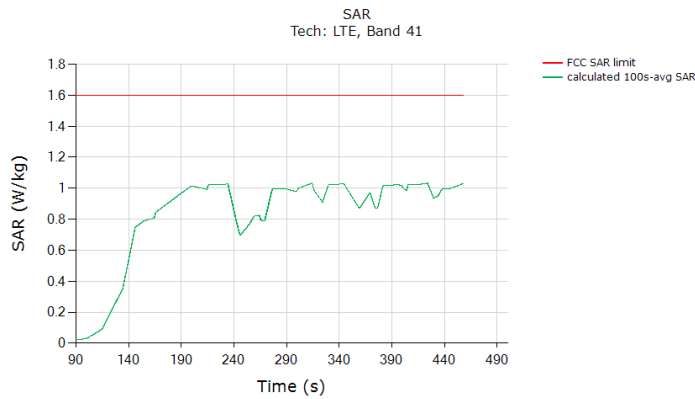

	(W/kg)
FCC 1gSAR limit	1.6
Max 100s-time averaged 1gSAR (green curve)	1.032
<b>Validated:</b> Max time averaged SAR (green curve) does not exceed SAR design target +1dB device uncertainty	



### 6.3.4 5G NR SA n77

#### Test result for test sequence 1:

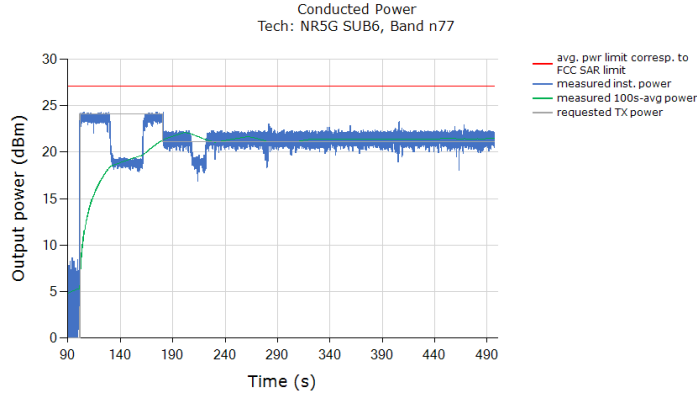

Above time-averaged conducted Tx power is converted/calculated into time-averaged 1gSAR using Equation (1a) and plotted below to demonstrate that the time-averaged 1gSAR versus time does not exceed the FCC limit of 1.6 W/kg for 1gSAR:

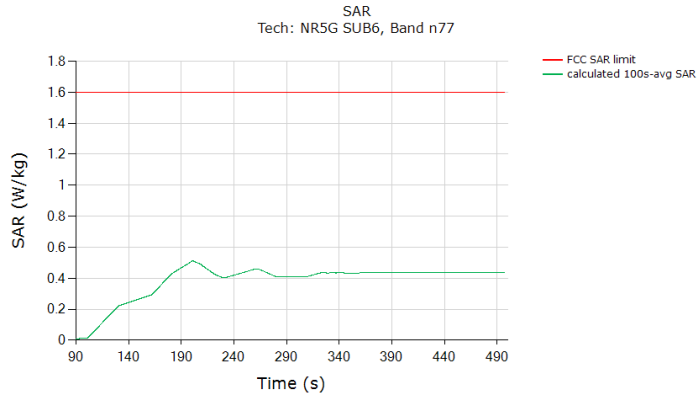

	(W/kg)
FCC 1gSAR limit	1.6
Max 100s-time averaged 1gSAR (green curve)	0.512
<b>Validated:</b> Max time averaged SAR (green curve) does not exceed SAR design target +1dB device uncertainty	



Test result for test sequence 2:

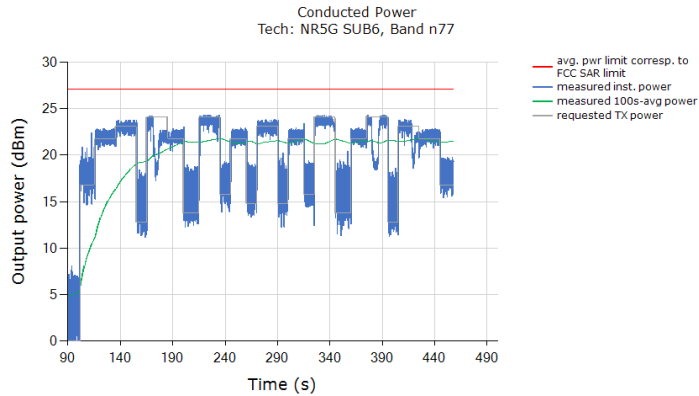

Above time-averaged conducted Tx power is converted/calculated into time-averaged 1gSAR using Equation (1a) and plotted below to demonstrate that the time-averaged 1gSAR versus time does not exceed the FCC limit of 1.6 W/kg for 1gSAR:

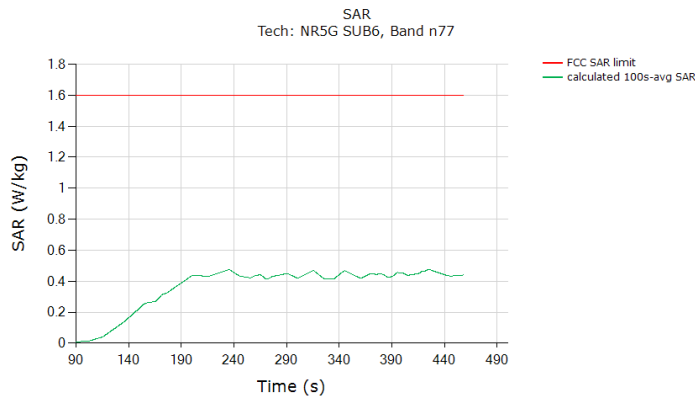

	(W/kg)
FCC 1gSAR limit	1.6
Max 100s-time averaged 1gSAR (green curve)	0.476
<b>Validated:</b> Max time averaged SAR (green curve) does not exceed SAR design target +1dB device uncertainty	



### 6.4 Change in Call Test Results

This test was measured with LTE B41, and with callbox requesting maximum power. The call drop was manually performed when the EUT is transmitting at  $P_{reserve}$  level as shown in the plot below (dotted black region). The measurement setup is shown in Figure 6-1. The detailed test procedure is described in Section 3.3.2.

Call drop test result:

Plot 1: Measured Tx power (dBm) versus time shows that the transmitting power kept the same  $P_{reserve}$  level of LTE B41 after the call was re-established:

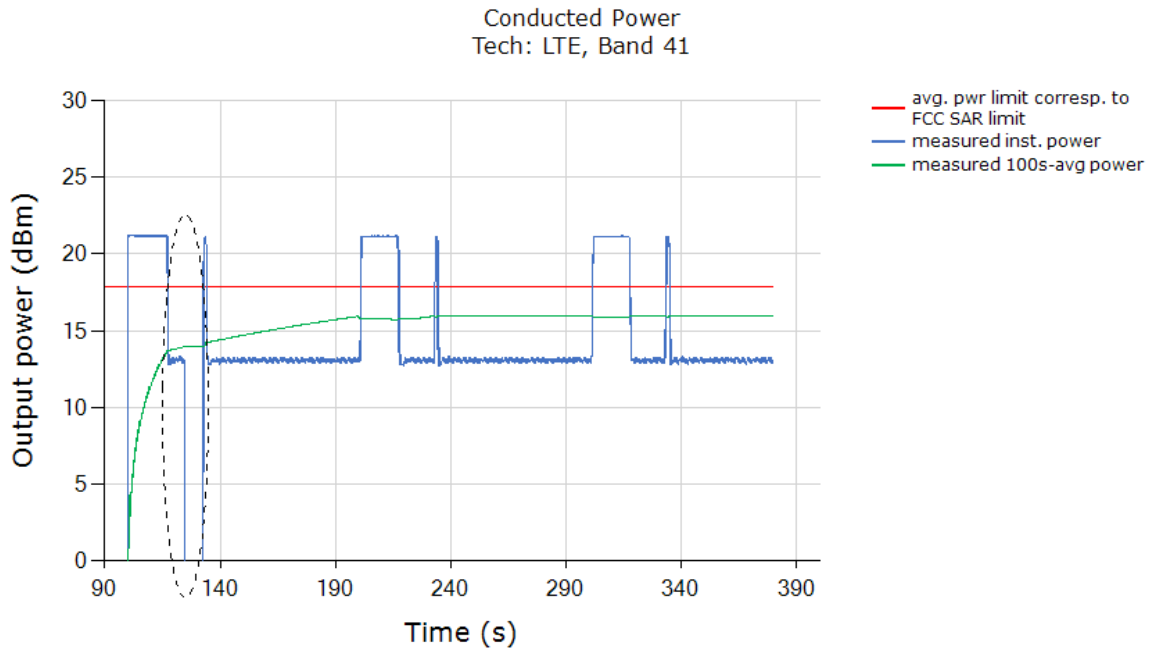

Plot Notes: ... The conducted power plot shows expected Tx transition.



Plot 2: Above time-averaged conducted Tx power is converted/calculated into time-averaged 1gSAR using Equation (1a) and plotted below to demonstrate that the time-averaged 1gSAR versus time does not exceed the FCC limit of 1.6 W/kg for 1gSAR:

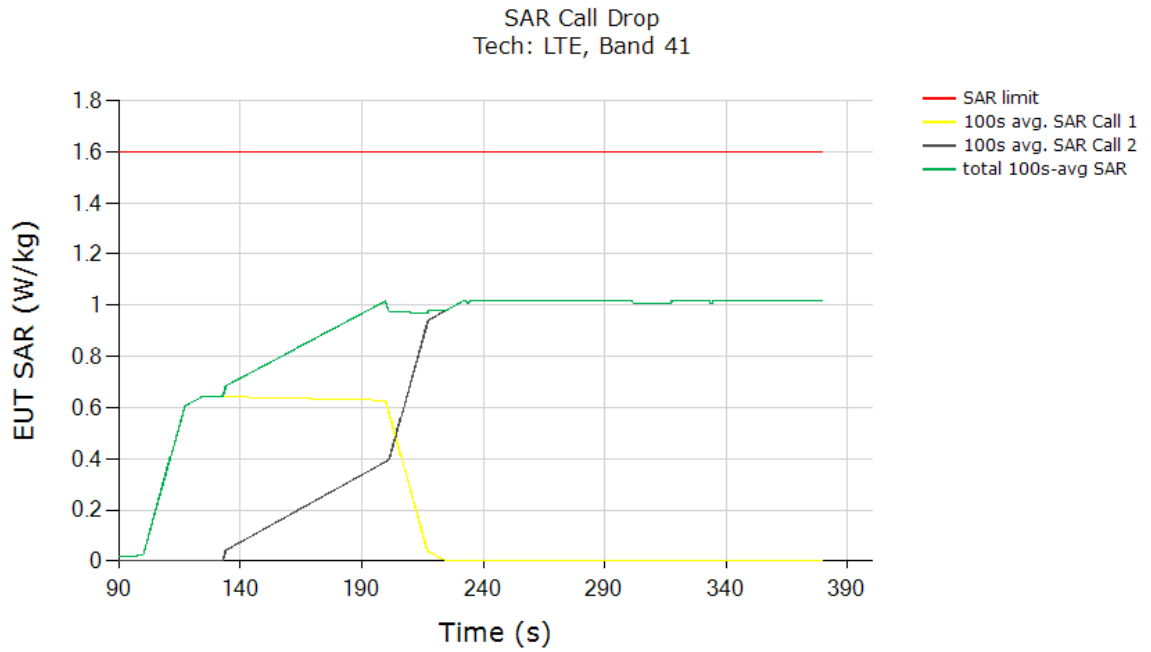

	(W/kg)
FCC 1gSAR limit	1.6
Max 100s-time averaged 1gSAR (green curve)	1.020
Validated	

The test result validated the continuity of power limiting in DSI switch scenario.



### 6.5 Change in technology/band test results

This test was conducted with callbox requesting maximum power, and with antenna & technology switch from LTE B41 to WCDMA B2. Following procedure detailed in Section 3.3.3, and using the measurement setup shown in Figure 6-1(a) and (c), the technology/band switch was performed when the EUT is transmitting at  $P_{reserve}$  level as shown in the plot below (dotted black region).

Plot 1: Measured Tx power (dBm) versus time shows that the transmitting power changed from LTE B41  $P_{reserve}$  level to WCDMA B2

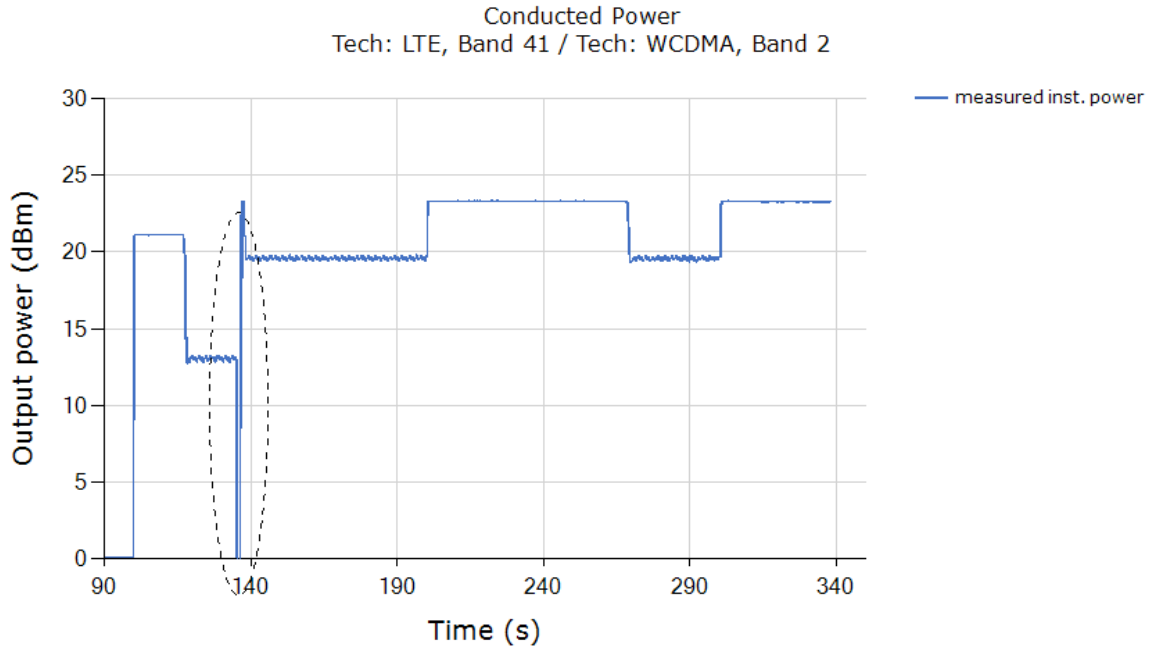

Plot 2: All the time-averaged conducted Tx power measurement results were converted into time-averaged normalized SAR values using Equation (6a), (6b) and (6c), and plotted below to demonstrate that the time-averaged normalized exposure versus time does not exceed the normalized FCC limit of 1.0:



Total Normalized Time-averaged RF Exposure  
Tech: LTE, Band 41 / Tech: WCDMA, Band 2

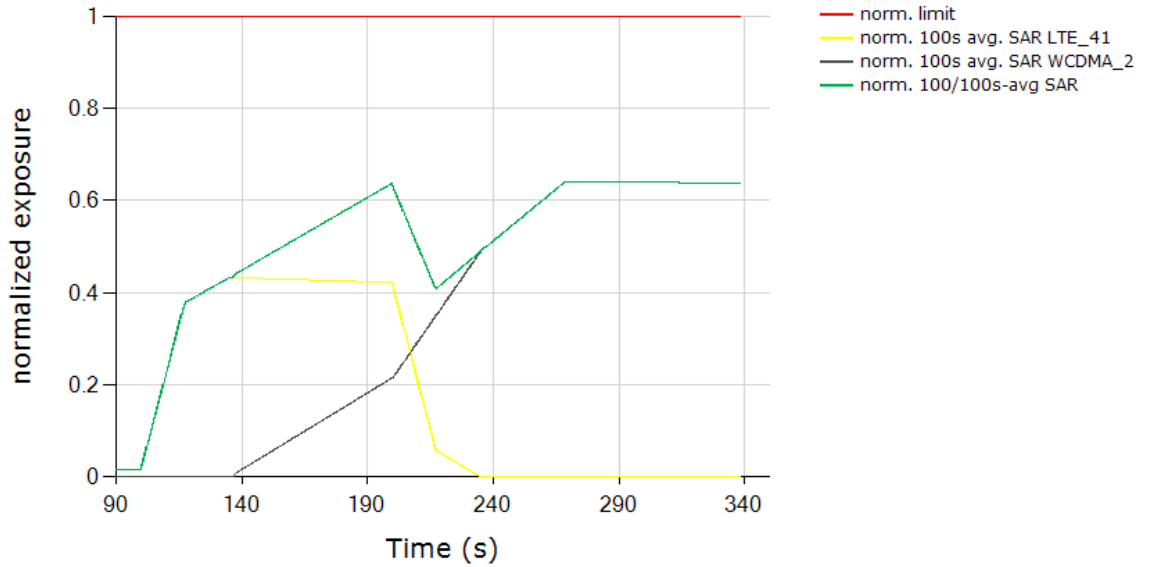

	Exposure Ratio
FCC normalized Exposure Ratio limit	1.0
Max 100s-time averaged normalized Exposure Ratio (green curve)	0.642
Validated	

The test result validated the continuity of power limiting in technology/band switch scenario.





### 6.6 Change in Time window / antenna switch test results

#### 6.6.1 Test case 1: transition from LTE B41 to LTE B48 (i.e., 100s to 60s), then back to LTE B41

Test result for change in time-window (from 100s to 60s to 100s):

Plot 1: Measured Tx power (dBm) versus time shows that the transmitting power changed when LTE B41 switches to LTE Band 48 (~245 seconds timestamp) and switches back to LTE Band 48 (~315 seconds timestamp):

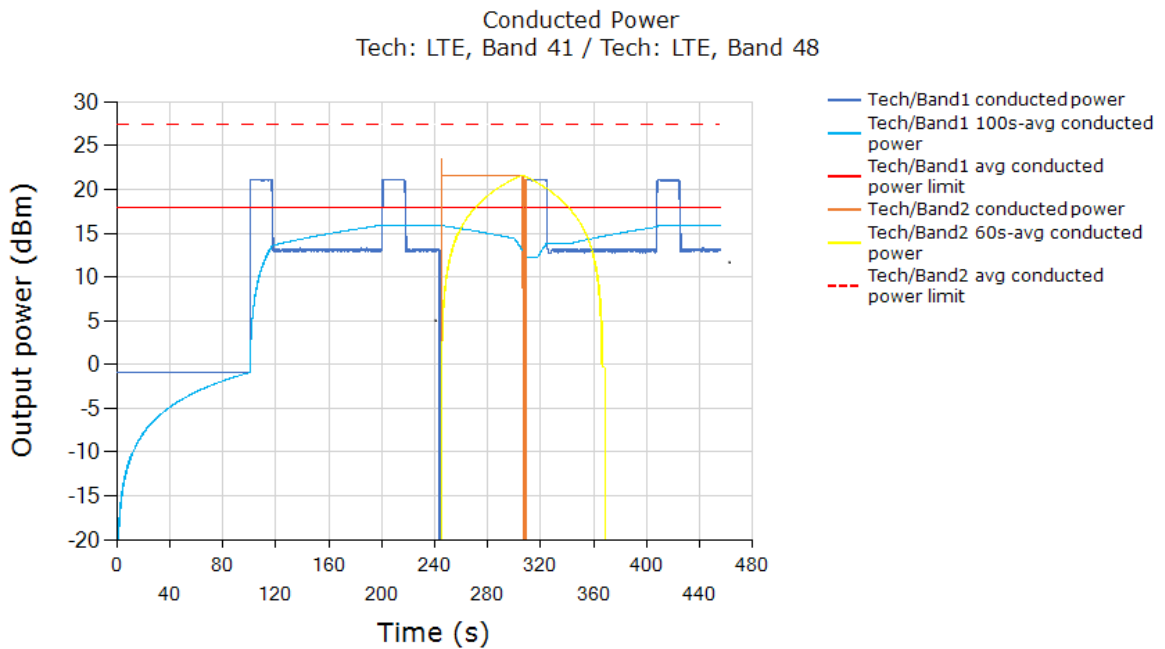

Plot Notes: ... The conducted power plot shows expected transitions in Tx power at ~245 seconds (100s-to-60s transition) and at ~315 seconds (60s-to-100s transition) in order to maintain total time-averaged RF exposure compliance across time windows, as show in next plot.



Plot 2: All the conducted Tx power measurement results were converted into time-averaged normalized SAR values using Equation (7a), (7b) and (7c), and plotted below to demonstrate that the time-averaged normalized SAR versus time does not exceed the FCC limit of 1 unit. Equation (7a) is used to convert the Tx power of device to obtain 100s-averaged normalized SAR in LTE B41 as shown in black curve. Similarly, equation (7b) is used to obtain 60s-averaged normalized SAR in LTE Band 48 as shown in orange curve. Equation (7c) is used to obtain total time-averaged normalized SAR as shown in green curve (i.e., sum of black and orange curves).

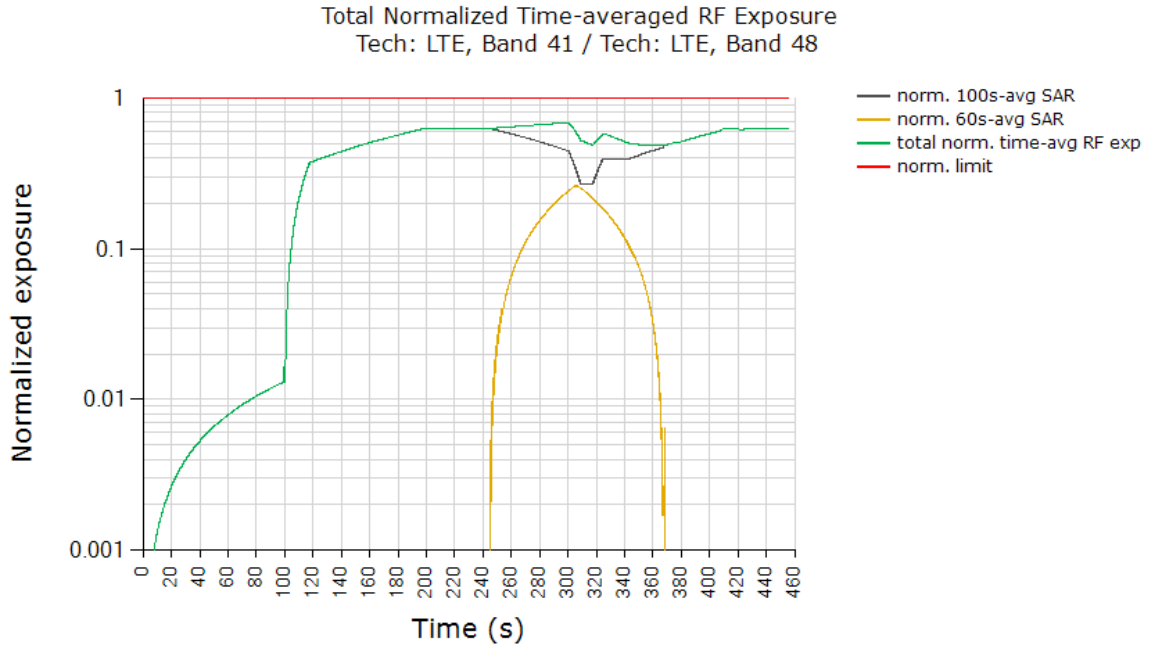

	Exposure Ratio
FCC normalized Exposure Ratio	1.0
Max time averaged normalized Exposure Ratio (green curve)	0.686
Validated	

Plot Notes:

Maximum power is requested by callbox for the entire duration of the test, with tech/band switches from 100s-to-60s window at ~245s time stamp, and from 60s-to-100s window at ~315s time stamp. Smart Transmit controls the Tx power during these time-window switches to ensure total time-averaged RF exposure, i.e., sum of black and orange curves given by equation (7c), is always compliant. In time-window switch test, at all times the total time averaged normalized RF exposure (green curve) should not exceed normalized SAR\_design\_target +1dB device uncertainty. In this test, with a maximum normalized SAR of 0.686 being  $\leq 0.75$  ( $=0.95/1.6 +1\text{dB device uncertainty}$ ), the above test result validated the continuity of power limiting in time-window switch scenario.



### 6.6.2 Test case 2: transition from LTE B48 to LTE B41 (i.e., 60s to 100s), then back to LTE B48

Test result for change in time-window (from 60s to 100s to 60s):

Plot 1: Measured Tx power (dBm) versus time shows that the transmitting power changed when LTE Band 48 switches to LTE B41 (~180 seconds timestamp) and switches back to LTE Band 48 (~290 seconds timestamp):

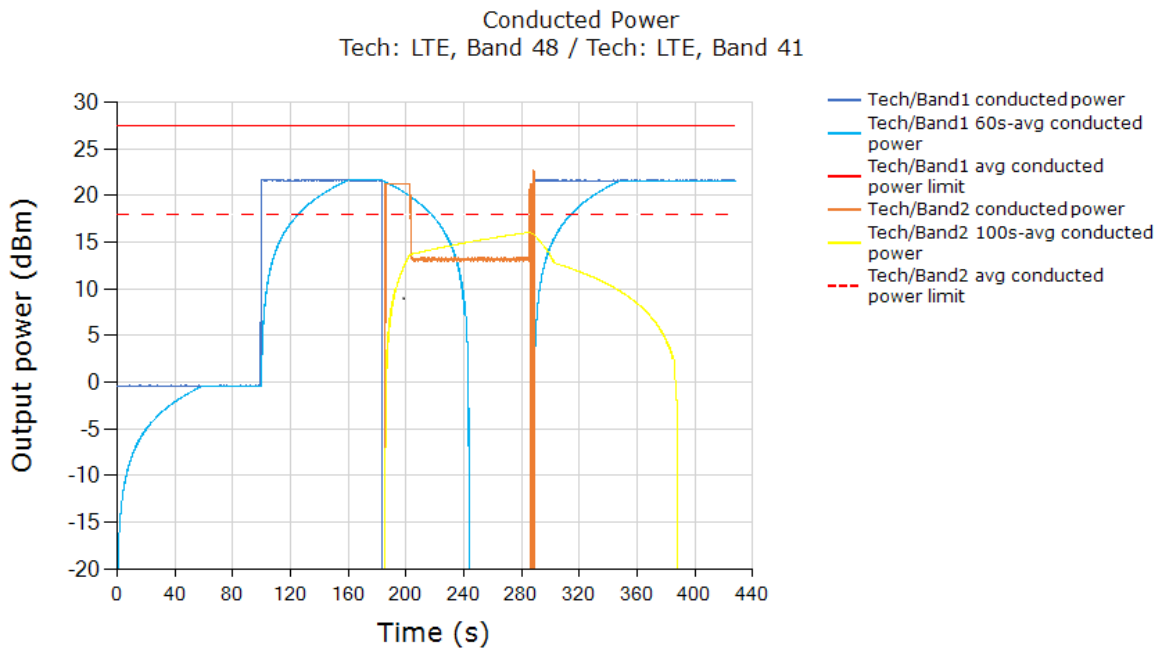

Plot Notes: ... The conducted power plot shows expected transitions in Tx power at ~180 seconds (60s-to-100s transition) and at ~290 seconds (100s-to-60s transition) in order to maintain total time-averaged RF exposure compliance across time windows, as show in next plot.



Plot 2: All the conducted Tx power measurement results were converted into time-averaged normalized SAR values using Equation (7a), (7b) and (7c), and plotted below to demonstrate that the time-averaged normalized SAR versus time does not exceed the FCC limit of 1 unit. Equation (7a) is used to convert the Tx power of device to obtain 60s-averaged normalized SAR in LTE Band 48 as shown in black curve. Similarly, equation (7b) is used to obtain 100s-averaged normalized SAR in LTE B41 as shown in orange curve. Equation (7c) is used to obtain total time-averaged normalized SAR as shown in green curve (i.e., sum of black and orange curves).

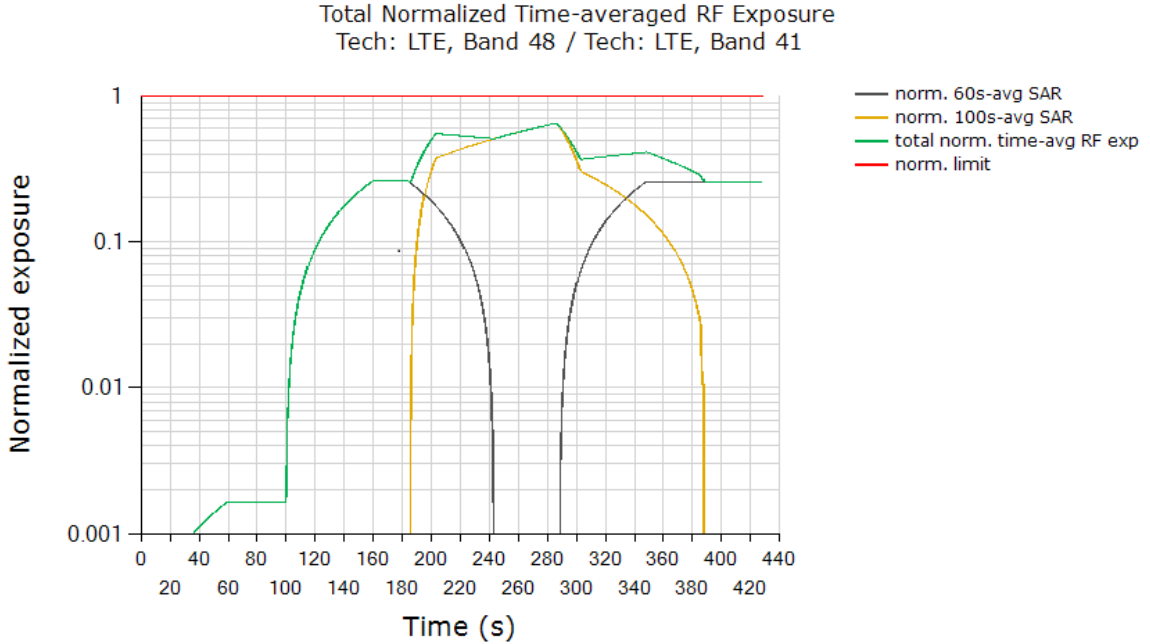

	Exposure Ratio
FCC normalized Exposure Ratio limit	1.0
Max time averaged normalized Exposure Ratio (green curve)	0.649
Validated	

Plot Notes:

Maximum power is requested by callbox for the entire duration of the test, with tech/band switches from 60s-to-100s window at ~190s time stamp, and from 100s-to-60s window at ~295s time stamp. Smart Transmit controls the Tx power during these time-window switches to ensure total time-averaged RF exposure, i.e., sum of black and orange curves given by equation (7c), is always compliant. In time-window switch test, at all times the total time averaged normalized RF exposure (green curve) should not exceed normalized SAR<sub>design\_target</sub> +1dB device uncertainty. In this test, with a maximum normalized SAR of 0.649 being  $\leq 0.75$  ( $=0.95/1.6 +1\text{dB device uncertainty}$ ), the above test result validated the continuity of power limiting in time-window switch scenario.



### 6.7 Switch in SAR exposure test results

This test was conducted with callbox requesting maximum power, and with the EUT in LTE B66 + 5G NR NSA n77 call. Following procedure detailed in Section 3.3.7 and Appendix B.2, and using the measurement setup shown in Figure 6-1, the SAR exposure switch measurement is performed with the EUT in various SAR exposure scenarios.

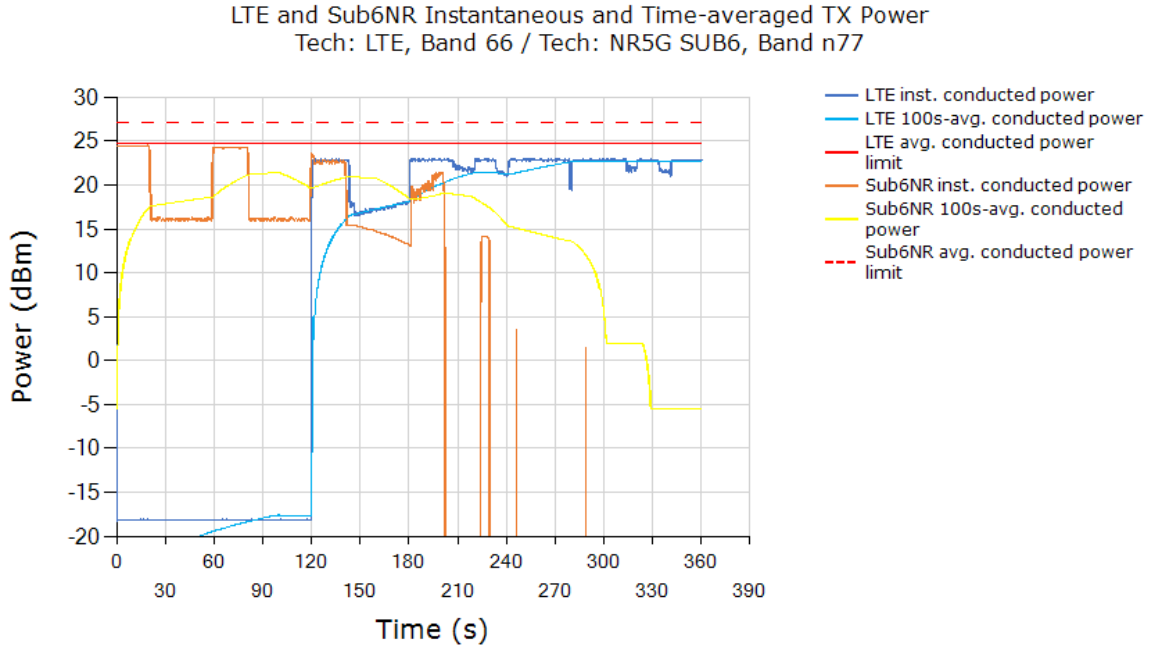

Plot 2: All the conducted Tx power measurement results were converted into time-averaged normalized SAR values using Equation (7a), (7b) and (7c), and plotted below to demonstrate that the time-averaged normalized SAR versus time does not exceed the FCC limit of 1 unit. Equation (7a) is used to convert the LTE Tx power of device to obtain 100s-averaged normalized SAR in LTE B66 as shown in black curve. Similarly, equation (7b) is used to obtain 100s-averaged normalized SAR in 5G NR NSA n77 as shown in orange curve. Equation (7c) is used to obtain total time-averaged normalized SAR as shown in green curve (i.e., sum of black and orange curves).



Total Normalized Time-averaged RF Exposure  
Tech: LTE, Band 66 / Tech: NR5G SUB6, Band n77

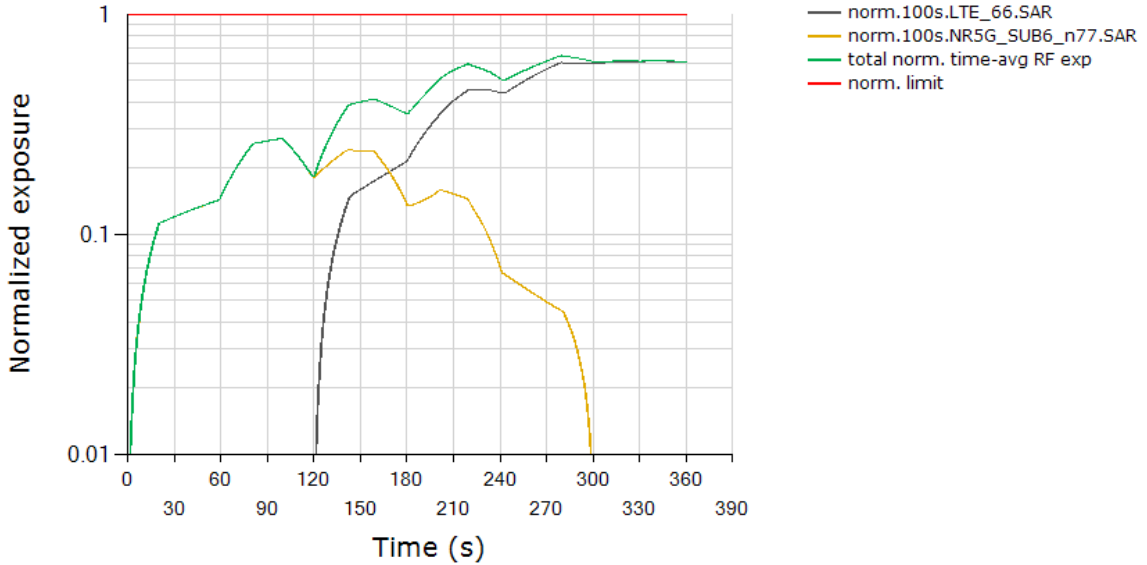

	Exposure Ratio
FCC normalized Exposure Ratio limit	1.0
Max time averaged normalized Exposure Ratio (green curve)	0.650
Validated	

Plot Notes:

Device starts predominantly in Sub6 NR SAR exposure scenario between 0s and 120s, and in LTE SAR + Sub6 NR SAR exposure scenario between 120s and 240s, and in predominantly in LTE SAR exposure scenario after t=240s. Here, Smart Transmit allocates a maximum of 75% of exposure margin (based on 3dB reserve margin setting) for Sub6 NR. This corresponds to a normalized 1gSAR exposure value = 75% \* 0.553W/kg measured SAR at Sub6 NR Plimit / 1.6W/kg limit = 0.259+ “+1dB~ -1dB” device related uncertainty (see orange curve between 0s~120s). For predominantly LTE SAR exposure scenario, maximum normalized 1gSAR exposure should correspond to 100% exposure margin = 0.836W/kg measured SAR at LTE Plimit /1.6W/kg limit = 0.523+ “+1dB~ -1dB” device related uncertainty (see black curve after t = 240s). Additionally, in SAR exposure switch test, at all times the total time-averaged normalized RF exposure (green curve) should not exceed normalized SAR\_design\_target +1dB device uncertainty. In this test, with a maximum normalized SAR of 0.650 being ≤ 0.75 (=0.95/1.6 +1dB device uncertainty), the above test result validated the continuity of power limiting in SAR exposure switch scenario.



## 7 SAR Test Results for Sub-6 Smart Transmit Feature Validation

---

### 7.1 Measurement setup

The measurement setup in Figure 7-1 is similar to normal SAR measurements (see Appendix E). The difference in SAR measurement setup for time averaging feature validation is that the callbox is signaling in close loop power control mode (instead of requesting maximum power in open loop control mode) and callbox is connected to the PC using GPIB so that the test script executed on PC can send GPIB commands to control the callbox's requested power over time (test sequence). The same test script used in conducted setup for time-varying Tx power measurements is also used in this section for running the test sequences during SAR measurements, and the recorded values from the disconnected power meter by the test script were discarded.

As mentioned in Section 3.4, for EUT to follow TPC command sent from the callbox wirelessly, the "path loss" between callbox antenna and the EUT needs to be very well calibrated. Since the SAR chamber is in uncontrolled environment, precautions must be taken to minimize the environmental influences on "path loss". Similarly, in the case of time-varying SAR measurements in 5G NR (with LTE as anchor), "path loss" between callbox antenna and the EUT needs to be carefully calibrated for both LTE link as well as for 5G NR link.

The EUT is placed in worst-case position according to Table 5-2.



## 7.2 SAR measurement results for time-varying Tx power transmission scenario

Following Section 3.4 procedure, time-averaged SAR measurements are conducted using EX3DV4 probe at peak location of area scan over 500 seconds. cDASY6 system verification for SAR measurement is provided in Appendix C, and the associated SPEAG certificates are attached in Appendix D.

SAR probe integration times depend on the communication signal being tested. Integration times used by SPEAG for their probe calibrations can be downloaded from here (integration time is listed on the bottom of the first page for each tech):

<https://www.speag.com/assets/downloads/services/cs/UIDSummary171205.pdf>

Since the sampling rate used by cDASY6 for pointSAR measurements is not in user control, the number of points in 100s or 60s interval is determined from the scan duration setting in cDASY6 time-average pointSAR measurement by (100s or 60s / cDASY6\_scan\_duration \* total number of pointSAR values recorded). Running average is performed over these number of points in excel spreadsheet to obtain 100s-/60s-averaged pointSAR.

Following Section 3.4, for each of selected technology/band (listed in Table 5-2):

2. With *Reserve\_power\_margin* set to 0 dB, area scan is performed at  $P_{limit}$ , and time-averaged pointSAR measurements are conducted to determine the pointSAR at  $P_{limit}$  at peak location, denoted as  $pointSAR_{P_{limit}}$ .
6. With *Reserve\_power\_margin* set to actual (intended) value, two more time-averaged pointSAR measurements are performed at the same peak location for test sequences 1 and 2.

To demonstrate compliance, all the pointSAR measurement results were converted into 1gSAR or 10gSAR values by using Equation (3a), rewritten below:

$$1g\_or\_10gSAR(t) = \frac{pointSAR(t)}{pointSAR_{P_{limit}}} * 1g\_or\_10gSAR_{P_{limit}} \quad (3a)$$

where,  $pointSAR(t)$ ,  $pointSAR_{P_{limit}}$ , and  $1g\_or\_10gSAR_{P_{limit}}$  correspond to the measured instantaneous point SAR, measured point SAR at  $P_{limit}$  from above step 1 and 2, and measured 1gSAR or 10gSAR values at  $P_{limit}$  obtained from Part 1 report and listed in Table 5-2 in Section 5.1 of this report.





### 7.2.1 WCDMA B2 SAR test results

SAR test results for test sequence 1:

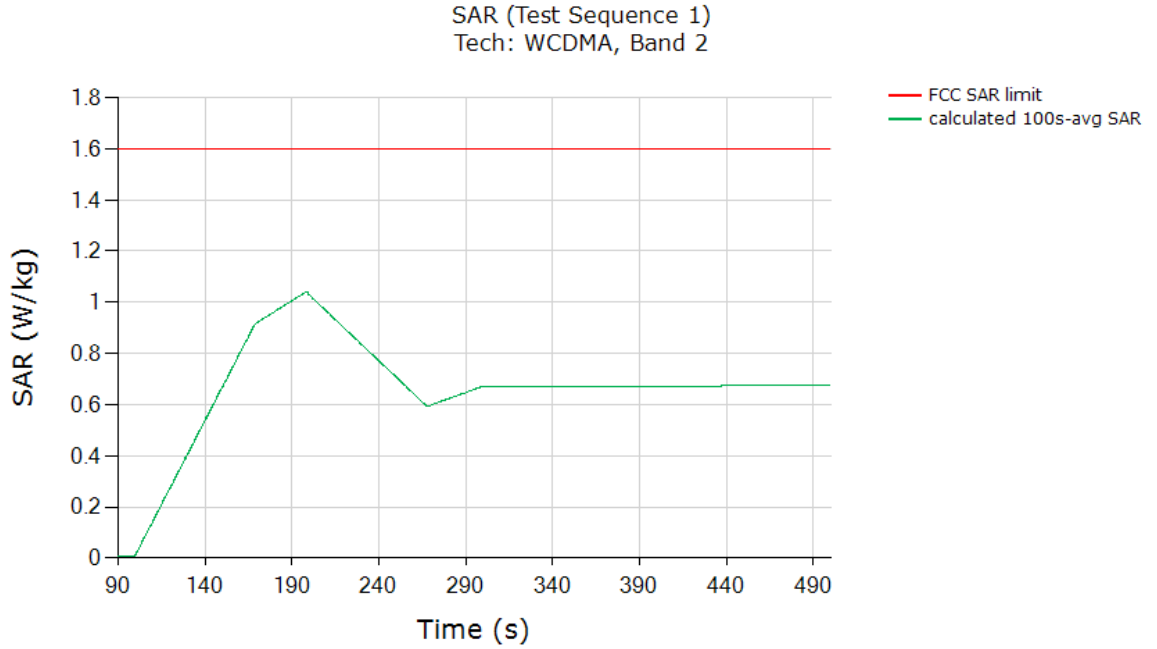

	(W/kg)
FCC 1gSAR limit	1.6
Max 100s-time averaged 1gSAR (green curve)	1.042
<b>Validated:</b> Max time averaged SAR (green curve) does not exceed measured SAR at Plimit +1dB device uncertainty	



SAR test results for test sequence 2:

SAR (Test Sequence 2)  
Tech: WCDMA, Band 2

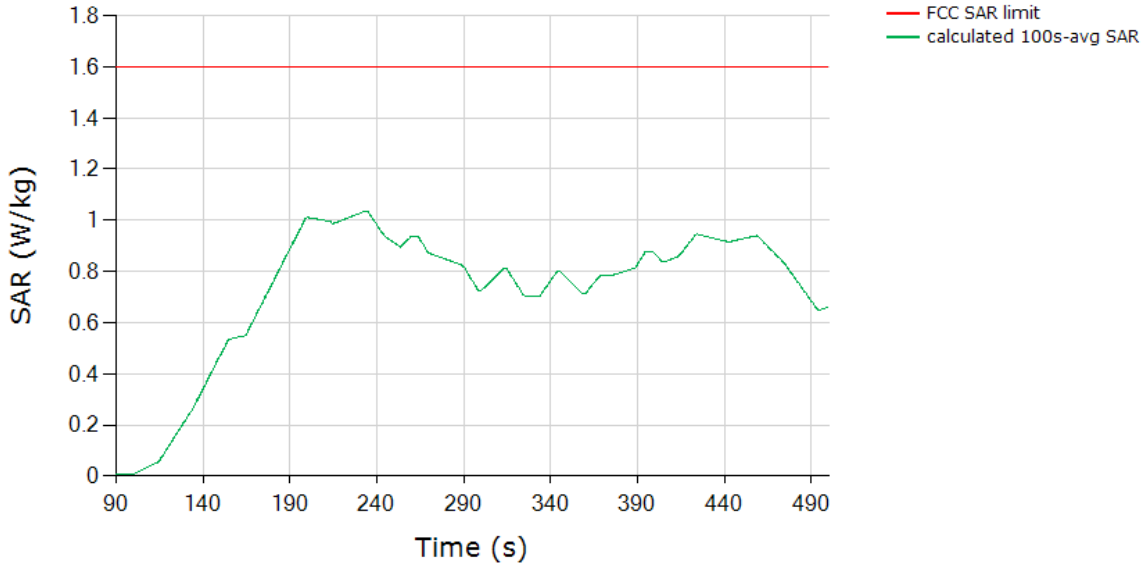

	(W/kg)
FCC 1gSAR limit	1.6
Max 100s-time averaged 1gSAR (green curve)	1.036
Validated: Max time averaged SAR (green curve) does not exceed measured SAR at Plimit +1dB device uncertainty	



### 7.2.2 LTE B2 SAR test results

SAR test results for test sequence 1:

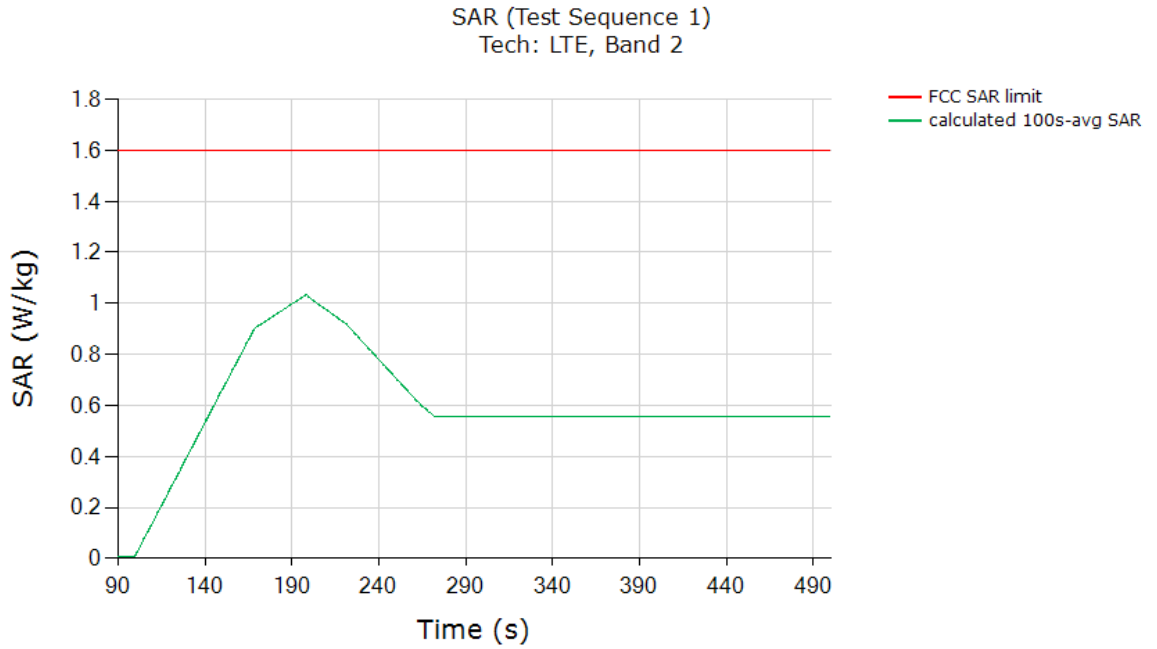

	(W/kg)
FCC 1gSAR limit	1.6
Max 100s-time averaged 1gSAR (green curve)	1.034
<i>Validated:</i> Max time averaged SAR (green curve) does not exceed measured SAR at Plimit +1dB device uncertainty	



SAR test results for test sequence 2:

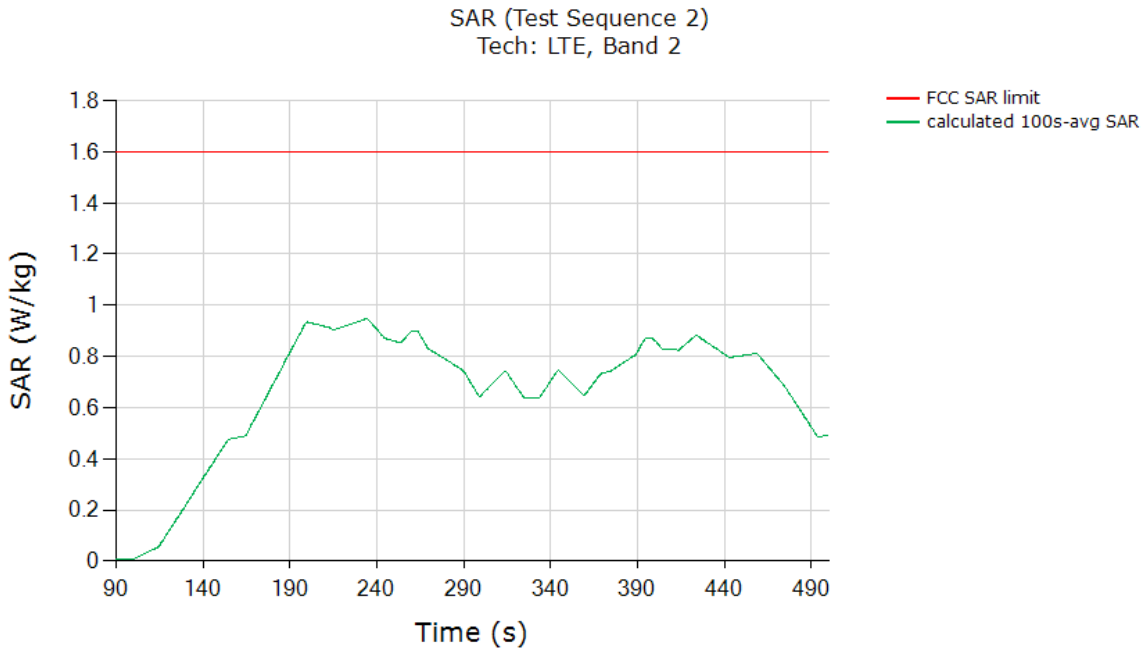

	(W/kg)
FCC 1gSAR limit	1.6
Max 100s-time averaged 1gSAR (green curve)	0.947
<b>Validated:</b> Max time averaged SAR (green curve) does not exceed measured SAR at Plimit +1dB device uncertainty	



### 7.2.3 LTE B41 SAR test results

SAR test results for test sequence 1:

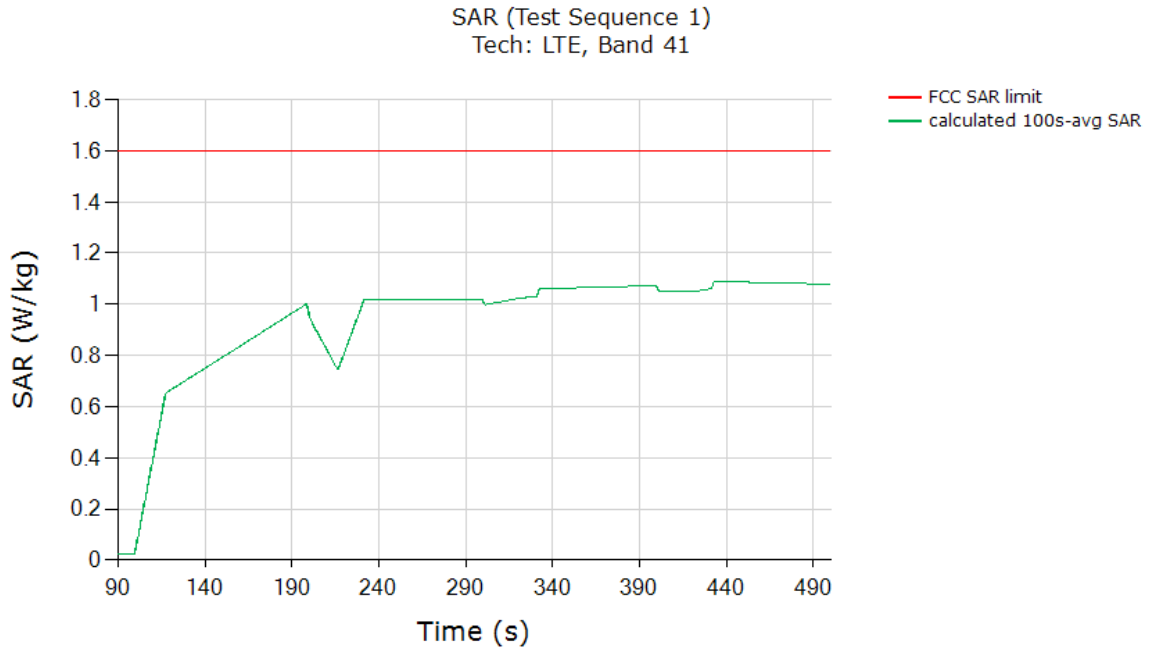

	(W/kg)
FCC 1gSAR limit	1.6
Max 100s-time averaged 1gSAR (green curve)	1.089
Validated: Max time averaged SAR (green curve) does not exceed measured SAR at Plimit +1dB device uncertainty	



SAR test results for test sequence 2:

SAR (Test Sequence 2)  
Tech: LTE, Band 41

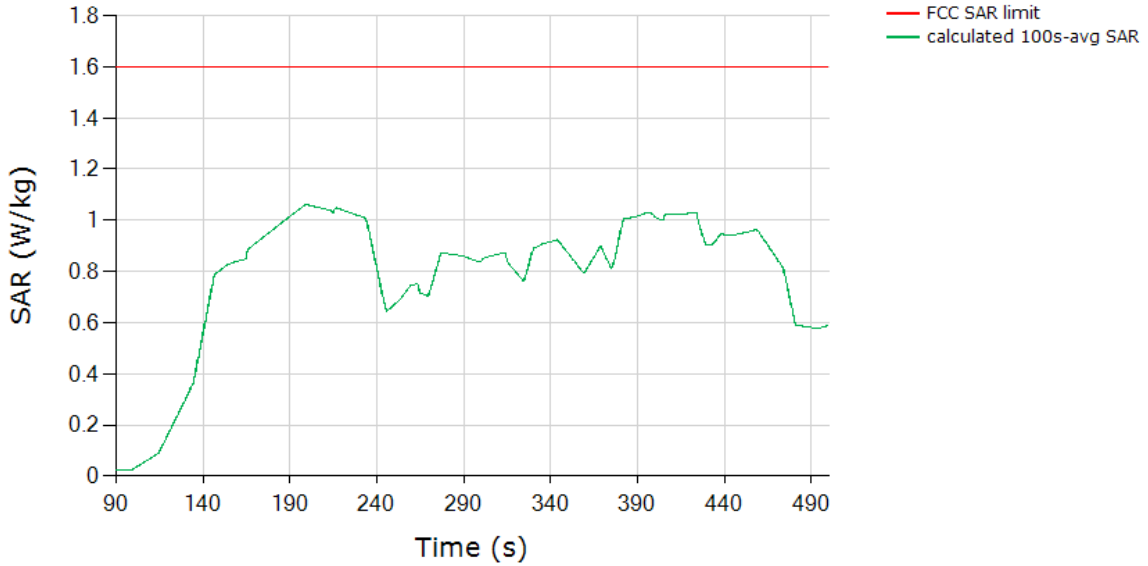

	(W/kg)
FCC 1gSAR limit	1.6
Max 100s-time averaged 1gSAR (green curve)	1.060
<b>Validated:</b> Max time averaged SAR (green curve) does not exceed measured SAR at Plimit +1dB device uncertainty	



### 7.2.4 5G NR SA n77 SAR test results

SAR test results for test sequence 1:

SAR (Test Sequence 1)  
Tech: 5GNR, Band n77

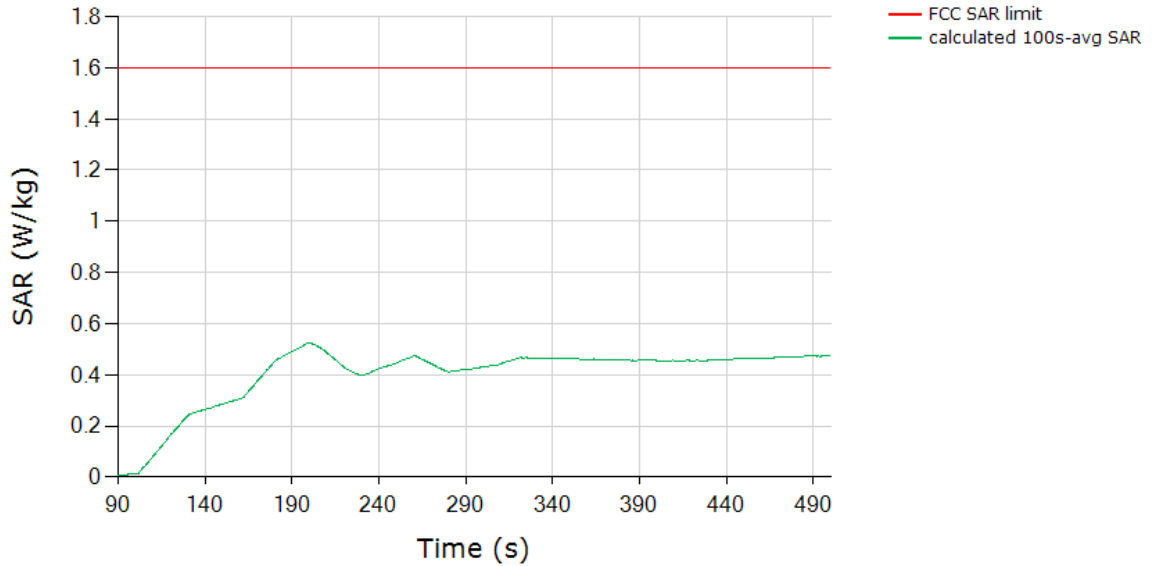

	(W/kg)
FCC 1gSAR limit	1.6
Max 100s-time averaged 1gSAR (green curve)	0.526
<b>Validated:</b> Max time averaged SAR (green curve) does not exceed measured SAR at Plimit +1dB device uncertainty	



SAR test results for test sequence 2:

SAR (Test Sequence 2)  
Tech: 5GNR, Band n77

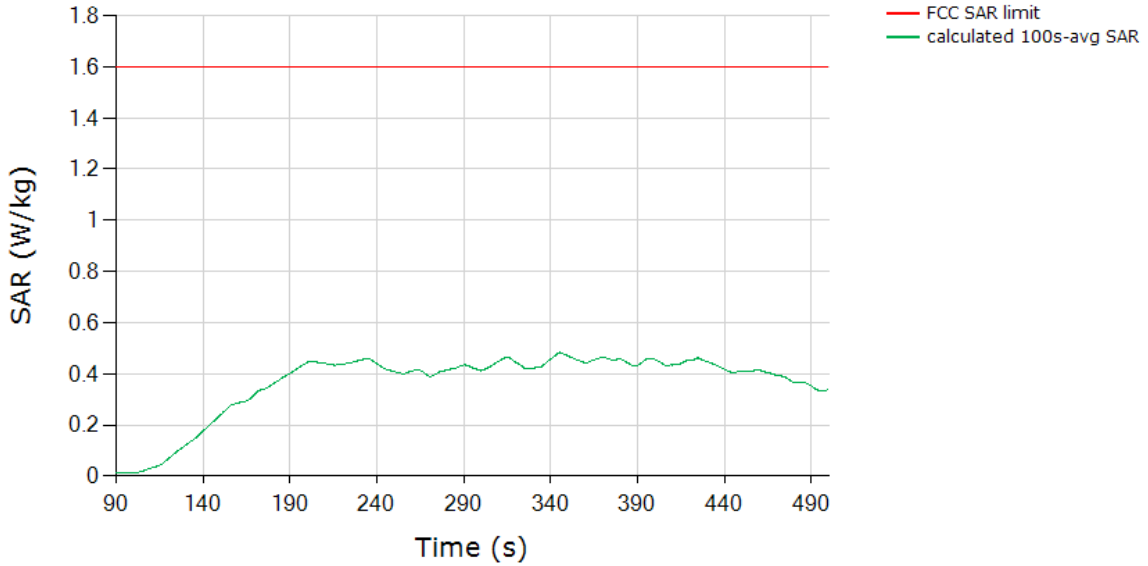

	(W/kg)
FCC 1gSAR limit	1.6
Max 100s-time averaged 1gSAR (green curve)	0.483
<b>Validated:</b> Max time averaged SAR (green curve) does not exceed measured SAR at Plimit +1dB device uncertainty	



## 8 Radiated Power Test Results for mmW Smart Transmit Feature Validation

### 8.1 Measurement Setup

The Keysight Technologies E7515B UXM callbox is used in this test. The test setup is shown in Figure 7-1a and the test setup is shown in Appendix E. The UXM callbox has two RF radio heads to up/down convert IF to mmW frequencies, which in turn are connected to two horn antennas for V- and H-polarizations for downlink communication. In the uplink, a directional coupler is used in the path of one of the horn antennas to measure and record radiated power using a Rohde & Schwarz NR50S power sensor. Note here that the isolation of the directional coupler may not be sufficient to attenuate the downlink signal from the callbox, which will result in high noise floor masking the recording of radiated power from EUT. In that case, either lower the downlink signal strength emanating from the RF radio heads of callbox or add an attenuator between callbox radio heads and directional coupler. Additionally, note that since the measurements performed in this validation are all relative, measurement of EUT's radiated power in one polarization is sufficient. The EUT is placed inside an anechoic chamber with V- and H-pol horn antennas to establish the radio link as shown in Figure 8-1. The callbox's LTE port is directly connected to the EUT's RF port via a directional coupler to measure the EUT's conducted Tx power using a Rohde & Schwarz NR8S power sensor. Additionally, EUT is connected to the PC via USB connection for sending beam switch command. Care is taken to route the USB cable and RF cable (for LTE connection) away from the EUT's mmW antenna modules.

Setup in Figure 8-1 is used for the test scenario 1, 5 and 6 described in Section 2. The test procedures described in Section 4 are followed. The path losses from the EUT to both the power meters are calibrated and used as offset in the power meter.

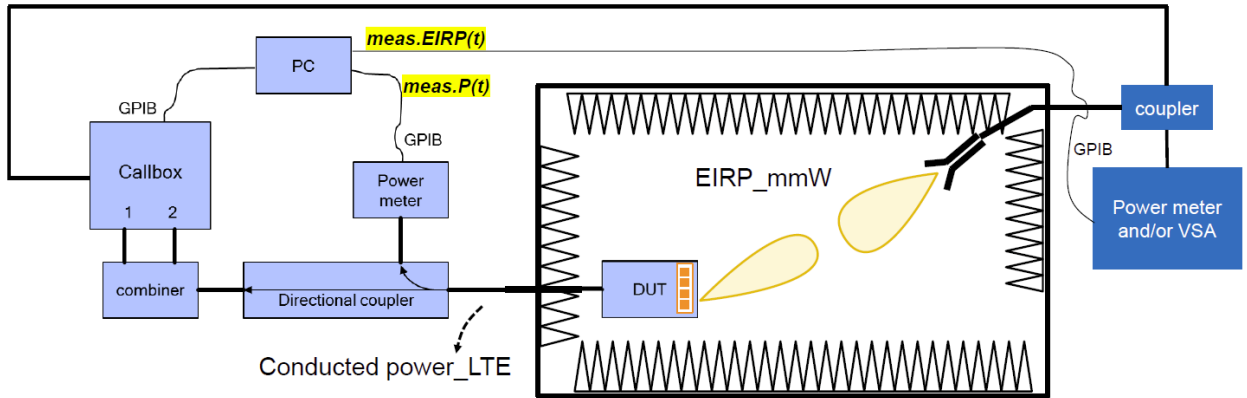

Figure 7-1 mmW NR radiated power measurement setup

Both the callbox and power meters are connected to the PC using USB cables. Test scripts are custom made for automation of establishing LTE + mmW call, conducted Tx power recording for LTE and radiated Tx power recording for mmW. These tests are manually stopped after desired time duration. Test script is programmed to set LTE Tx



power to all-down bits on the callbox immediately after the mmW link is established, and programmed to set toggle between all-up and all-down bits depending on the transmission scenario being evaluated. Similarly, test script is also programmed to send beam switch command manually to the EUT via USB connection. For all the tests, the callbox is set to request maximum Tx power in mmW NR radio from EUT all the time.

Test configurations for this validation are detailed in Section 5.2. Test procedures are listed in Section 4.3.

### 8.2 mmW NR radiated power test results

To demonstrate the compliance, the conducted Tx power of LTE B66 is converted to 1gSAR exposure by applying the corresponding worst-case 1gSAR value at  $P_{limit}$  as reported in Part 1 report and listed in Table 5-2 of this report.

Similarly, following Step 4 in Section 4.3.1, radiated Tx power of mmW Band n260 and n261 for the beams tested is converted by applying the corresponding worst-case  $4cm^2PD$  values from Part 1 report, and listed in below Table 8-1. Qualcomm Smart Transmit feature operates based on time-averaged Tx power reported on a per symbol basis, which is independent of modulation, channel and bandwidth (RBs), therefore the worst-case  $4cm^2PD$  was conducted with the EUT in FTM mode, with CW modulation and 100% duty cycle. cDASY6 system verification for power density measurement is provided in Appendix C, and the associated SPEAG certificates are attached in Appendix D.

Both the worst-case 1gSAR and  $4cm^2PD$  values used in this section are listed in Table 8-1. The measured EIRP at *input.power.limit* for the beams tested in this section are also listed in Table 8-1.

**Table 8-1: Worst-case 1gSAR,  $4cm^2$  avg. PD and EIRP measured at *input.power.limit* for the selected configurations**

Tech	Band	Antenna	Beam ID	Input.power.limit (dBm)	Meas. $4cm^2PD$		Meas. EIRP at Input.power.limit (dBm)
					at Input.power.limit (W/m <sup>2</sup> )	configuration	
mmW NR	N260	Module 0	36	4.26	2.05	Front	11.2
			27	4.64	2.57	Front	9.77
			5	11.05	4.41	Front	8.18
mmW NR	N261	Module 0	28	4.81	2.3	Front	12.79
			36	6.21	1.9	Front	9.02
			5	10.54	2.29	Front	5.17

Tech	Band	Antenna	DSI	Meas. P <sub>limit</sub> (dBm)	Meas. 1gSAR At P <sub>limit</sub> (W/kg)	configuration
LTE	66	1	-	21.5	0.836	Back

The  $4cm^2$ -averaged PD distributions for the highest PD value per band, as listed in Table 8-1, are plotted below:

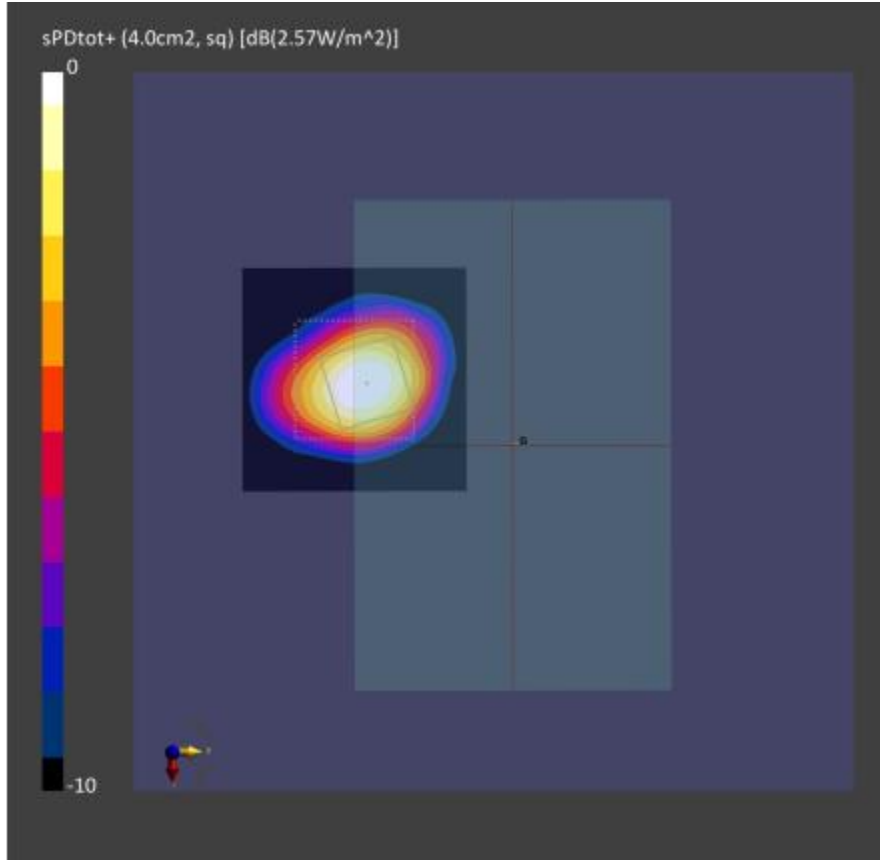
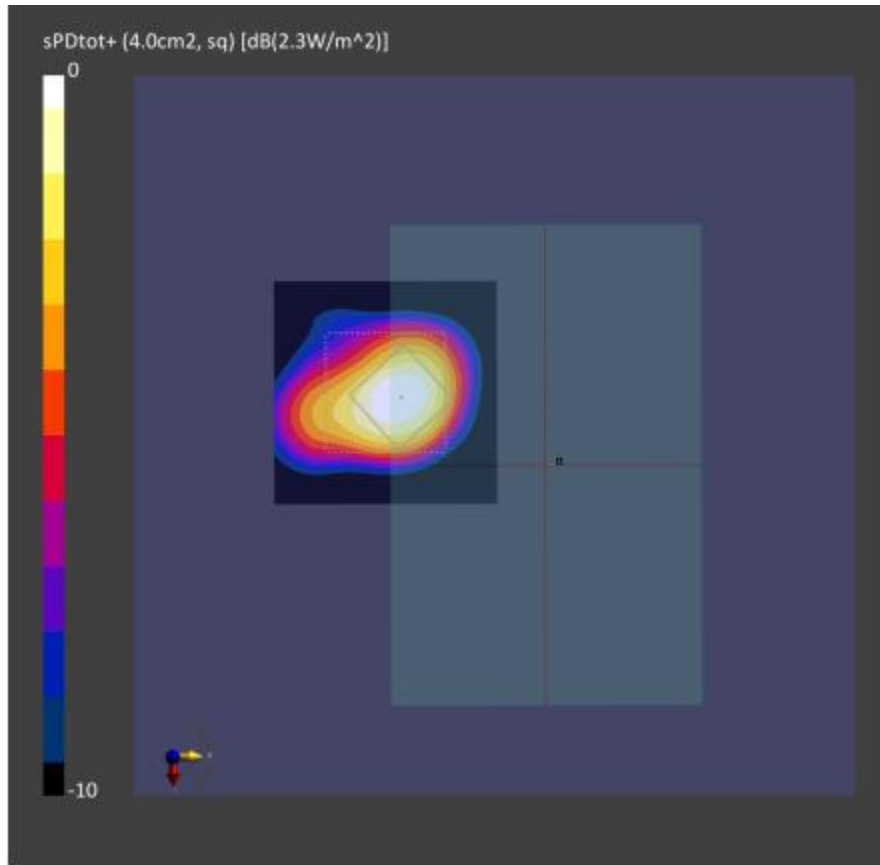

Figure 8-2: 4cm2-averaged power density distribution measured at *input.power.limit* of 4.64dBm on the Front for n260 beam 27



**Figure 8-3: 4cm2-averaged power density distribution measured at *input.power.limit* of 4.81dBm on the Front for n261 beam 28**



### 8.2.1 Maximum Tx power test results for n260

This test was measured with LTE B66 and mmW Band n260 Beam ID 36, by following the detailed test procedure described in Section 4.3.1.

Instantaneous and 100s-averaged conducted LTE Tx power versus time, instantaneous and 4s-averaged radiated mmW Tx power versus time, time-averaged conducted LTE Tx power limit and time-averaged radiated mmW Tx power limit:

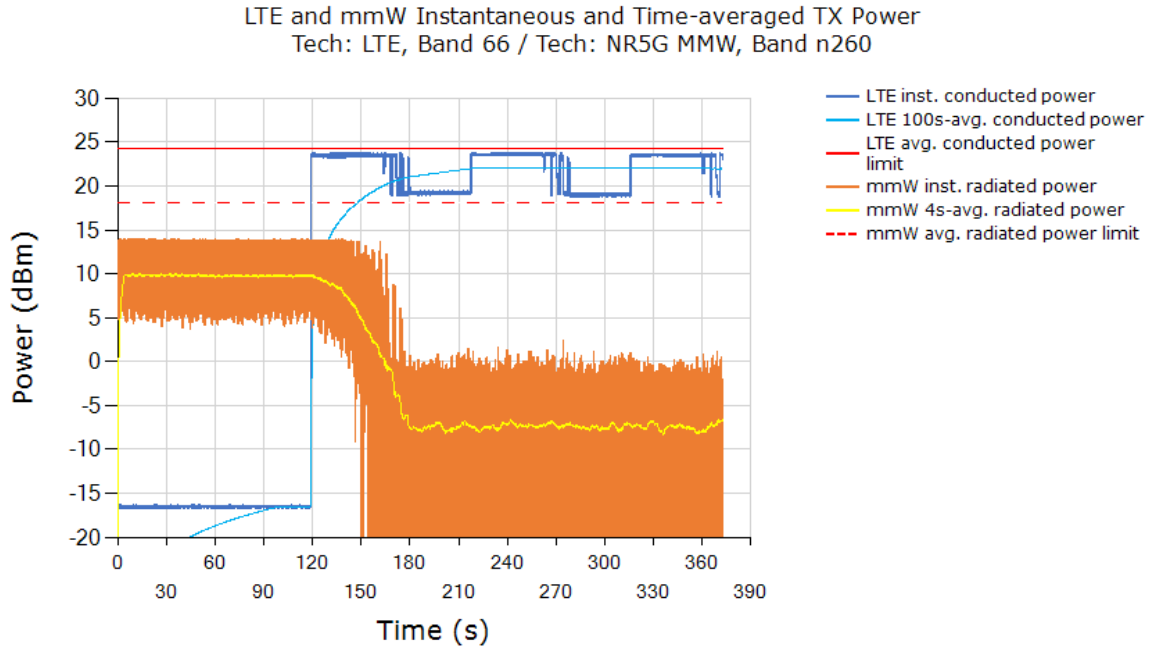

Above time-averaged conducted Tx power for LTE B66 and radiated Tx power for mmW NR Band n260 Beam ID 36 are converted into time-averaged 1gSAR and time-averaged 4cm2PD using Equation (2a) and (2b), which are divided by FCC 1gSAR limit of 1.6 W/kg and 4cm2PD limit of 10 W/m2, respectively, to obtain normalized exposures versus time. Below plot shows (a) normalized time-averaged 1gSAR versus time, (b) normalized time-averaged 4cm2-avg.PD versus time, (c) sum of normalized time-averaged 1gSAR and normalized time-averaged 4cm2-avg.PD:



Total Normalized Time-averaged RF Exposure  
 Tech: LTE, Band 66 / Tech: NR5G MMW, Band n260

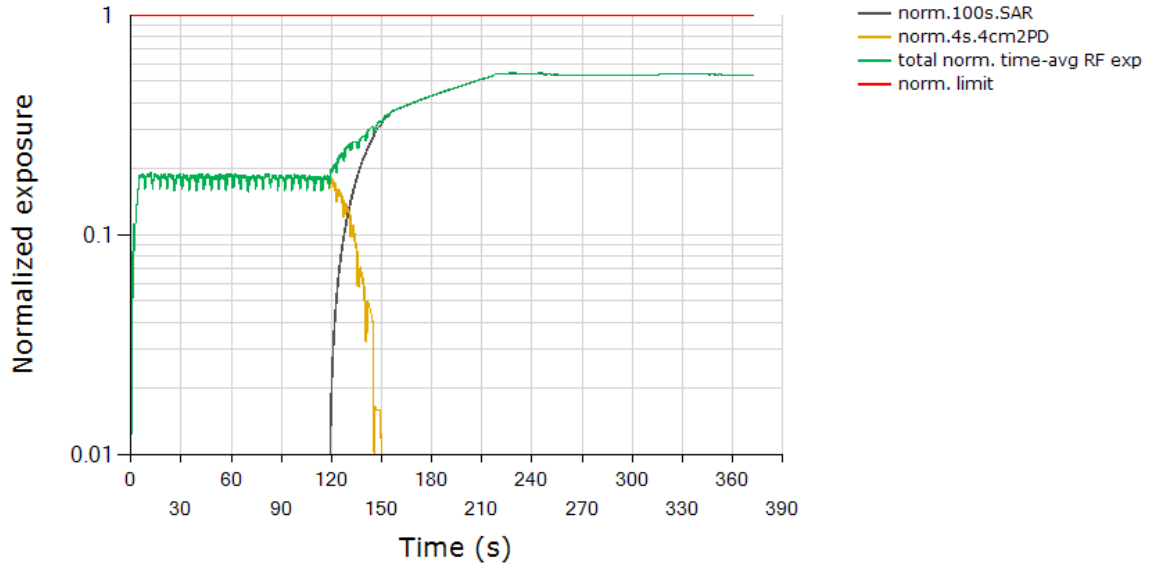

	Exposure ratio
FCC requirement for total RF exposure (normalized)	1.0
Max total normalized time-averaged RF exposure (green curve)	0.604
Validated	

**Plot notes:**

5G mmW NR call was established at ~0s time mark and LTE was placed in all-down bits immediately after 5G mmW NR call was established. Between 0s~120s, mmW exposure is the dominant contributor. Here, Smart Transmit feature allocates a maximum of 75% for mmW. From Table 8-1, this corresponds to a normalized 4cm<sup>2</sup>PD exposure value for Beam ID 36 of (75% \* 2.05W/m<sup>2</sup>)/(10 W/m<sup>2</sup>) = 15.38% ±2.1dB device related uncertainty (see green/orange curve between 0s~120s). At ~120s time mark, LTE is set to all-up bits, taking away margin from mmW exposure gradually. Towards the end of test, LTE is the dominant contributor towards RF exposure, i.e., corresponding normalized 1gSAR exposure value of (100% \* 0.836W/kg)/(1.6 W/kg) = 52.25%+“+1dB~ -1dB” design related uncertainty.

As can be seen, the power limiting enforcement is effective and the total normalized time-averaged RF exposure does not exceed 1.0. Therefore, Qualcomm® Smart Transmit time averaging feature is validated.



### 8.2.2 Maximum Tx power test results for n261

This test was measured with LTE B66 and mmW Band n261 Beam ID 28, by following the detailed test procedure described in Section 4.3.1.

Instantaneous and 100s-averaged conducted LTE Tx power versus time, instantaneous and 4s-averaged radiated mmW Tx power versus time, time-averaged conducted LTE Tx power limit and time-averaged radiated mmW Tx power limit:

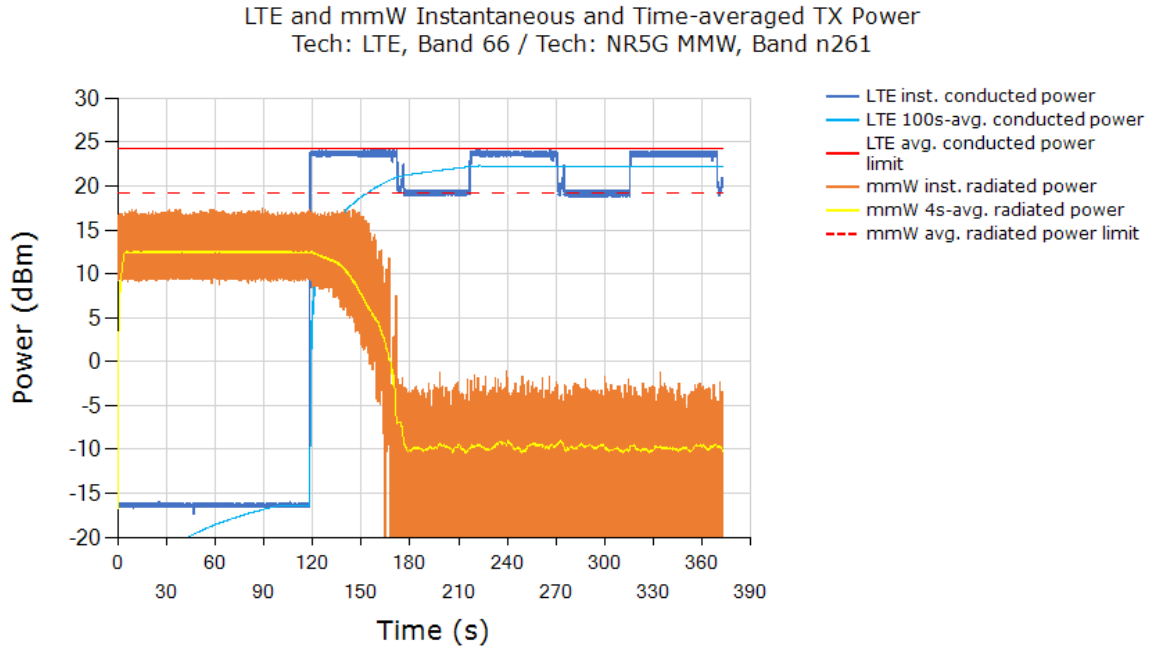

Above time-averaged conducted Tx power for LTE B66 and radiated Tx power for mmW NR n261 Beam ID 28 are converted into time-averaged 1gSAR and time-averaged 4cm<sup>2</sup>PD using Equation (2a) and (2b), which are divided by FCC 1gSAR limit of 1.6 W/kg and 4cm<sup>2</sup>PD limit of 10 W/m<sup>2</sup>, respectively, to obtain normalized exposures versus time. Below plot shows (a) normalized time-averaged 1gSAR versus time, (b) normalized time-averaged 4cm<sup>2</sup>-avg.PD versus time, (c) sum of normalized time-averaged 1gSAR and normalized time-averaged 4cm<sup>2</sup>-avg.PD:



Total Normalized Time-averaged RF Exposure  
 Tech: LTE, Band 66 / Tech: NR5G MMW, Band n261

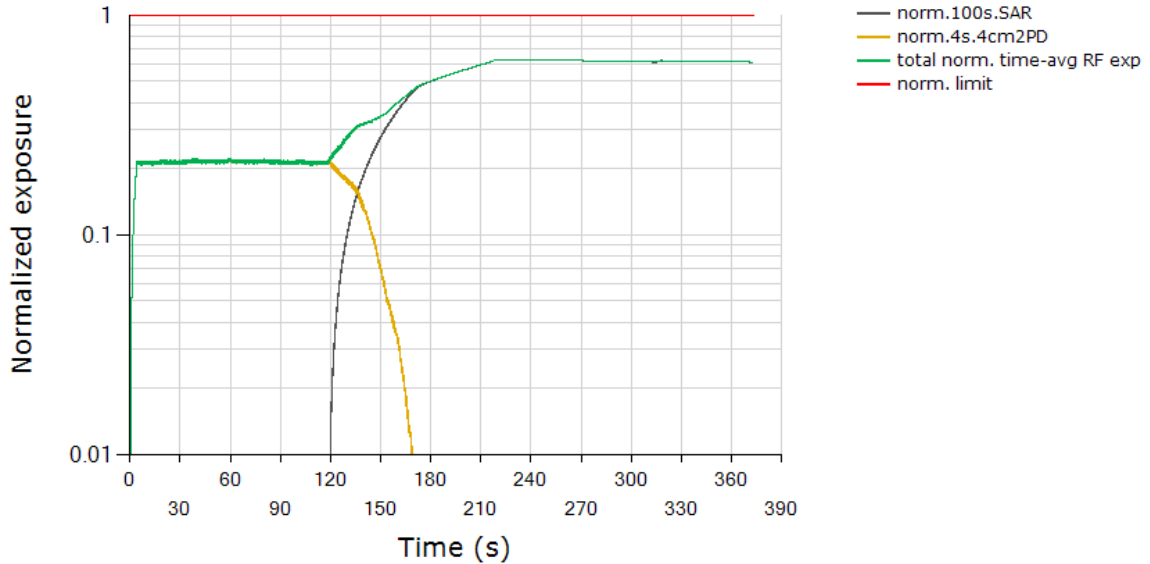

	Exposure Ratio
FCC requirement for total RF exposure (normalized)	1.0
Max total normalized time-averaged RF exposure (green curve)	0.631
Validated	

**Plot notes:**

5G mmW NR call was established at 0s time mark and LTE was placed in all-down bits immediately after 5G mmW NR call was established. Between 0s~120s, mmW exposure is the dominant contributor. Here, Smart Transmit feature allocates a maximum of 75% for mmW. From Table 8-1, this corresponds to a normalized 4cm2PD exposure value for Beam ID 28 of  $(75\% * 2.3W/m^2) / (10 W/m^2) = 17.25\% \pm 2.1dB$  device related uncertainty (see green/orange curve between 0s~120s). At ~120s time mark, LTE is set to all-up bits, taking away margin from mmW exposure gradually. Towards the end of test, LTE is the dominant contributor towards RF exposure, i.e., corresponding normalized 1gSAR exposure value of  $(100\% * 0.836 W/kg) / (1.6 W/kg) = 52.25\% +1dB \sim -1dB$  design related uncertainty.

As can be seen, the power limiting enforcement is effective and the total normalized time-averaged RF exposure does not exceed 1.0. Therefore, Qualcomm® Smart Transmit time averaging feature is validated.





### 8.2.3 Switch in SAR vs. PD exposure test results for n260

This test was measured with LTE B66 and mmW Band n260 Beam ID 36, by following the detailed test procedure is described in Section 4.3.2.

Instantaneous and 100s-averaged conducted LTE Tx power versus time, instantaneous and 4s-averaged radiated mmW Tx power versus time, time-averaged conducted LTE Tx power limit and time-averaged radiated mmW Tx power limit:

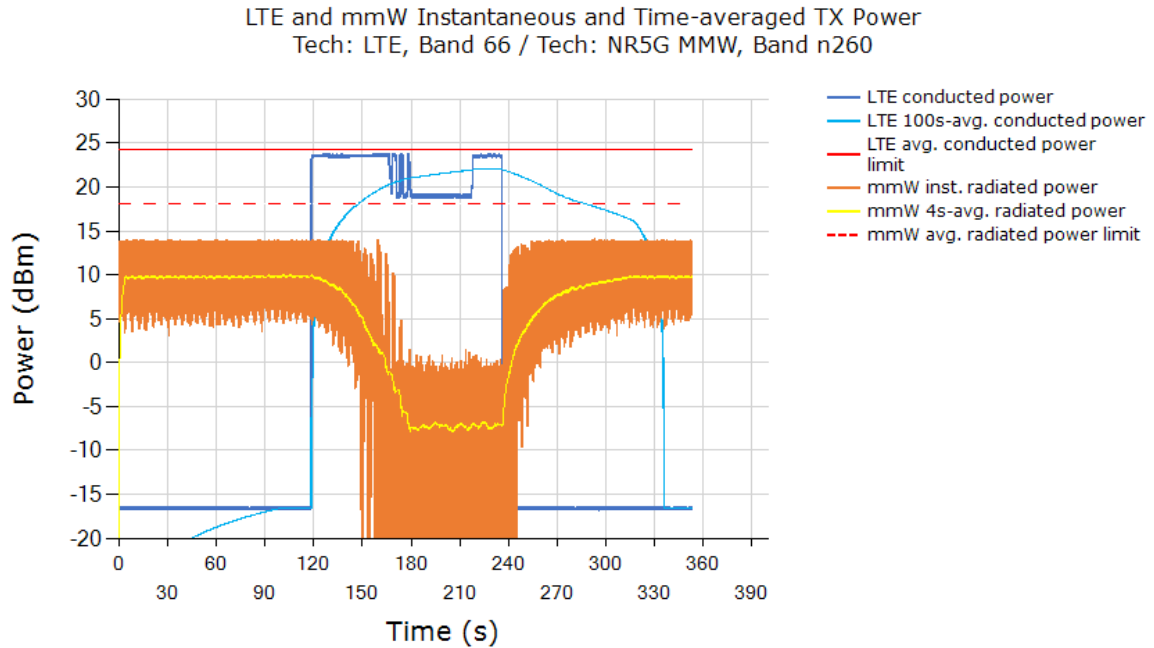

From the above plot, it is predominantly instantaneous PD exposure between 0s ~ 120s, it is instantaneous SAR+PD exposure between 120s ~ 145s, it is predominantly instantaneous SAR exposure between 145s ~ 235s, and above 235s, it is predominantly instantaneous PD exposure.

Normalized time-averaged exposures for LTE (1gSAR) and mmW (4cm<sup>2</sup>PD), as well as total normalized time-averaged exposure versus time:



Total Normalized Time-averaged RF Exposure  
Tech: LTE, Band 66 / Tech: NR5G MMW, Band n260

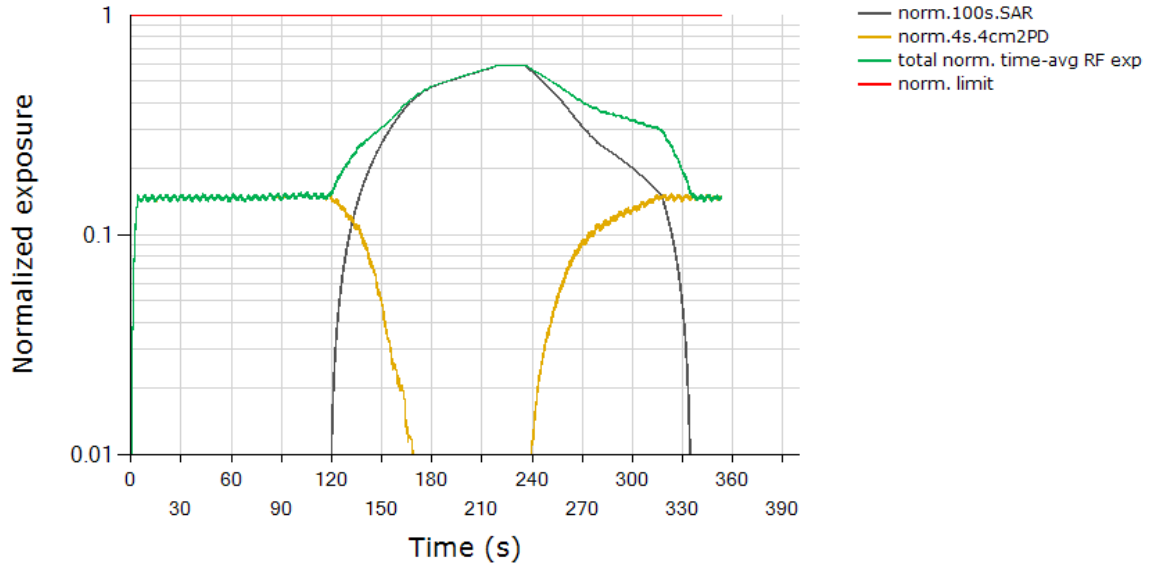

	Exposure Ratio
FCC requirement for total RF exposure (normalized)	1.0
Max total normalized time-averaged RF exposure (green curve)	0.594
Validated	

Plot notes: ...

5G mmW NR call was established at ~0s time mark and LTE was placed in all-down bits immediately after 5G mmW NR call was established. Between 0s~120s, mmW exposure is the dominant contributor. Here, Smart Transmit feature allocates a maximum of 75% for mmW. From Table 8-1, this corresponds to a normalized 4cm2PD exposure value for Beam ID 36 of  $(75\% * 2.05W/m^2)/(10 W/m^2) = 15.38\% \pm 2.1dB$  device related uncertainty (see orange/green curve between 0s~120s). At ~120s time mark, LTE is set to all-up bits, taking away margin from mmW exposure gradually (orange curve for mmW exposure goes down while black curve for LTE exposure goes up). At ~235s time mark, LTE is set to all-down bits, which results in mmW getting back RF margin slowly as seen by gradual increase in mmW exposure (orange curve for mmW exposure goes up while black curve for LTE exposure goes down). The calculated maximum RF exposure from LTE corresponds to normalized 1gSAR exposure value of  $(100\% * 0.836W/kg)/(1.6 W/kg) = 52.25\% + " +1dB \sim -1dB "$  design related uncertainty.

As can be seen, the power limiting enforcement is effective during transmission when SAR and PD exposures are switched, and the total normalized time-averaged RF exposure does not exceed 1.0. Therefore, Qualcomm® Smart Transmit time averaging feature is validated.



### 8.2.4 Switch in SAR vs. PD exposure test results for n261

This test was measured with LTE B66 and mmW Band n261 Beam ID 28, by following the detailed test procedure is described in Section 4.3.2.

Instantaneous and 100s-averaged conducted LTE Tx power versus time, instantaneous and 4s-averaged radiated mmW Tx power versus time, time-averaged conducted LTE Tx power limit and time-averaged radiated mmW Tx power limit:

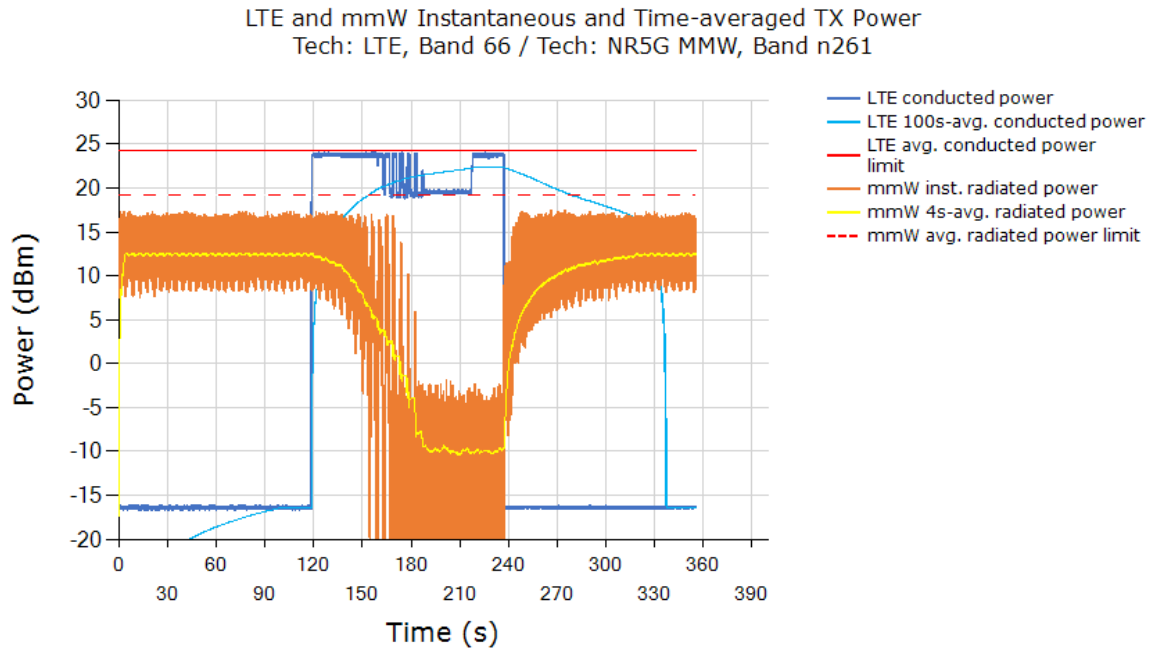

From the above plot, it is predominantly instantaneous PD exposure between 0s ~ 120s, it is instantaneous SAR+PD exposure between 120s ~ 145s, it is predominantly instantaneous SAR exposure between 145s ~ 235s, and above 235s, it is predominantly instantaneous PD exposure.

Normalized time-averaged exposures for LTE (1gSAR) and mmW (4cm<sup>2</sup>PD), as well as total normalized time-averaged exposure versus time:



Total Normalized Time-averaged RF Exposure  
 Tech: LTE, Band 66 / Tech: NR5G MMW, Band n261

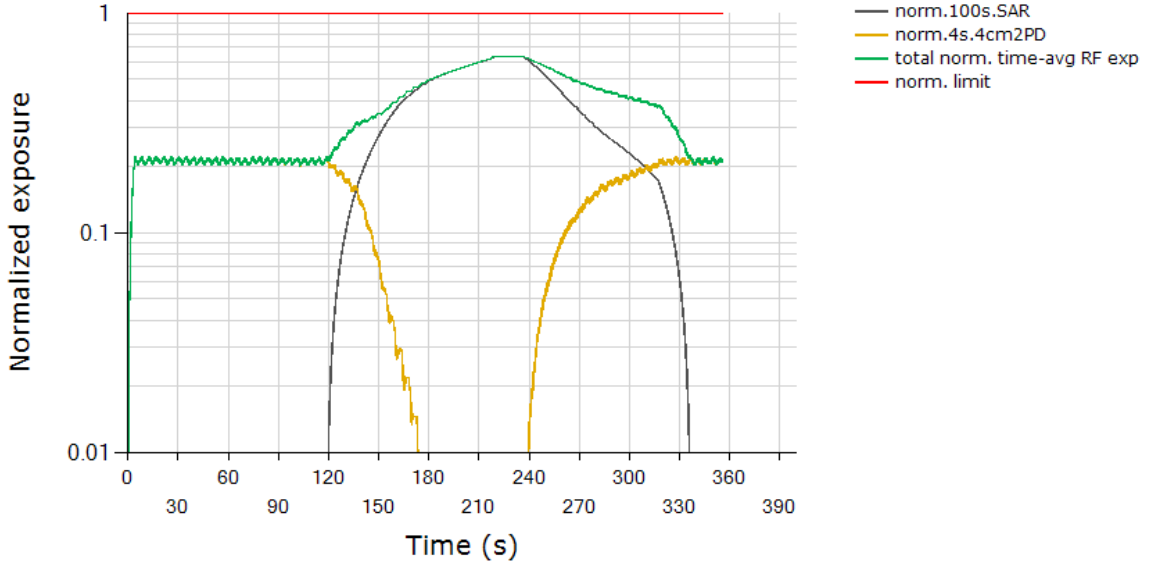

	Exposure Ratio
FCC requirement for total RF exposure (normalized)	1.0
Max total normalized time-averaged RF exposure (green curve)	0.635
Validated	

Plot notes: ...

5G mmW NR call was established at ~0s time mark and LTE was placed in all-downbits immediately after 5G mmW NR call was established. Between 0s~120s, mmW exposure is the dominant contributor. Here, Smart Transmit feature allocates a maximum of 75% for mmW. From Table 8-1, this corresponds to a normalized 4cm2PD exposure value for Beam ID 28 of  $(75\% * 2.3W/m^2)/(10 W/m^2) = 17.25\% \pm 2.1dB$  device related uncertainty (see orange/green curve between 0s~120s). At ~120s time mark, LTE is set to all-up bits, taking away margin from mmW exposure gradually (orange curve for mmW exposure goes down while black curve for LTE exposure goes up). At ~240s time mark, LTE is set to all-down bits, which results in mmW getting back RF margin slowly as seen by gradual increase in mmW exposure (orange curve for mmW exposure goes up while black curve for LTE exposure goes down). The calculated maximum RF exposure from LTE corresponds to normalized 1gSAR exposure value of  $(100\% * 0.836W/kg)/(1.6 W/kg) = 52.25\% +1dB \sim -1dB$  design related uncertainty

As can be seen, the power limiting enforcement is effective during transmission when SAR and PD exposures are switched, and the total normalized time-averaged RF exposure does not exceed 1.0. Therefore, Qualcomm® Smart Transmit time averaging feature is validated



### 8.2.5 Change in Beam test results for n260

This test was measured with LTE B66 and mmW Band n260, with beam switch from Beam ID 27 to Beam ID 5, by following the test procedure is described in Section 4.3.3.

Instantaneous conducted LTE Tx power versus time, instantaneous and 4s-averaged radiated mmW Tx power versus time, time-averaged radiated mmW Tx power limits for Beam ID 27 and Beam ID 5::

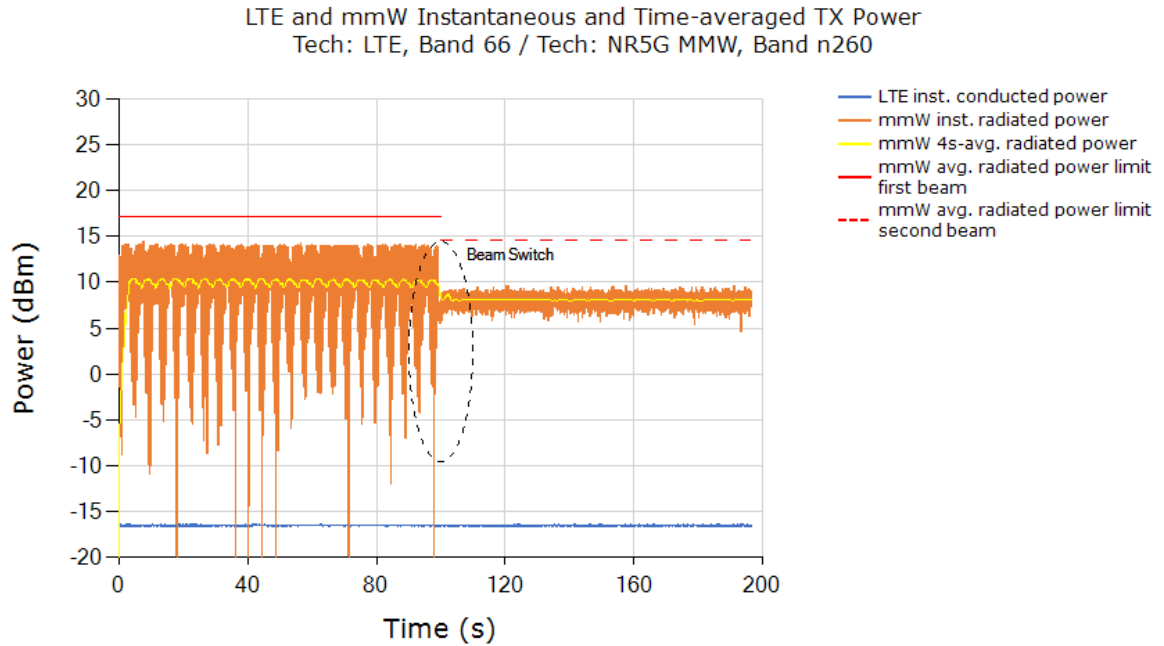

Normalized time-averaged exposures for LTE and mmW (4cm<sup>2</sup>PD), as well as total normalized time-averaged exposure versus time:



Total Normalized Time-averaged RF Exposure  
 Tech: LTE, Band 66 / Tech: NR5G MMW, Band n260

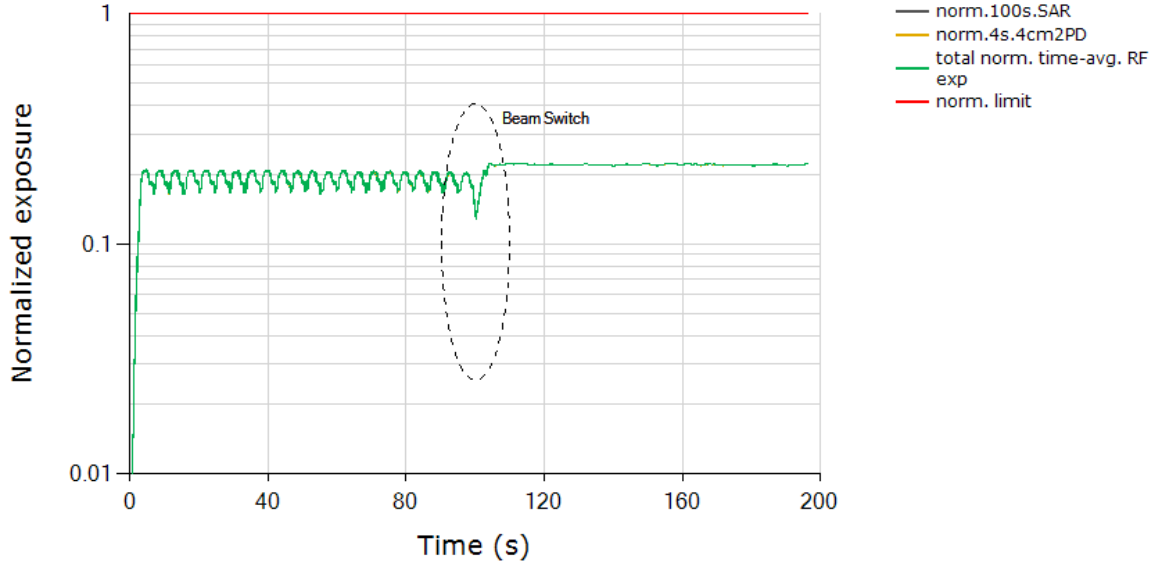

	Exposure Ratio
FCC requirement for total RF exposure (normalized)	1.0
Max total normalized time-averaged RF exposure (green curve)	0.224
Validated	

Plot notes: ...

5G mmW NR call was established at ~10s time mark and LTE was placed in all-down bits during the test. For this test, mmW exposure is the dominant contributor as LTE is left in all-down bits. Here, Smart Transmit feature allocates a maximum of 75% for mmW. From Table 8-1 exposure between 10s ~100s corresponds to a normalized 4cm2PD exposure value for Beam ID 27 of  $(75% * 2.57W/m^2)/(10 W/m^2) = 19.28% \pm 2.1dB$  device related uncertainty. At ~100s time mark (shown in black dotted ellipse), beam was switched to Beam ID 5 resulting in a normalized 4cm2PD exposure value of  $(75% * 4.41W/m^2)/(10 W/m^2) = 33.08% \pm 2.1dB$  device related uncertainty. Additionally, during the switch, the ratio between the averaged radiated powers of the two beams (yellow curve) should correspond to the difference in EIRPs measured at each corresponding input.power.limit for these beams listed in Table 8-1, i.e.,  $1.59dB \pm 2.1dB$  device uncertainty.

As can be seen, the power limiting enforcement is effective during transmission when SAR and PD exposures are switched, and the total normalized time-averaged RF exposure does not exceed 1.0. Therefore, Qualcomm® Smart Transmit time averaging feature is validated



### 8.2.6 Change in Beam test results for n261

This test was measured with LTE B66 and mmW Band n261, with beam switch from Beam ID 36 to Beam ID 5, by following the test procedure is described in Section 4.3.3.

Instantaneous conducted LTE Tx power versus time, instantaneous and 4s-averaged radiated mmW Tx power versus time, time-averaged radiated mmW Tx power limits for Beam ID 36 and Beam ID 5:

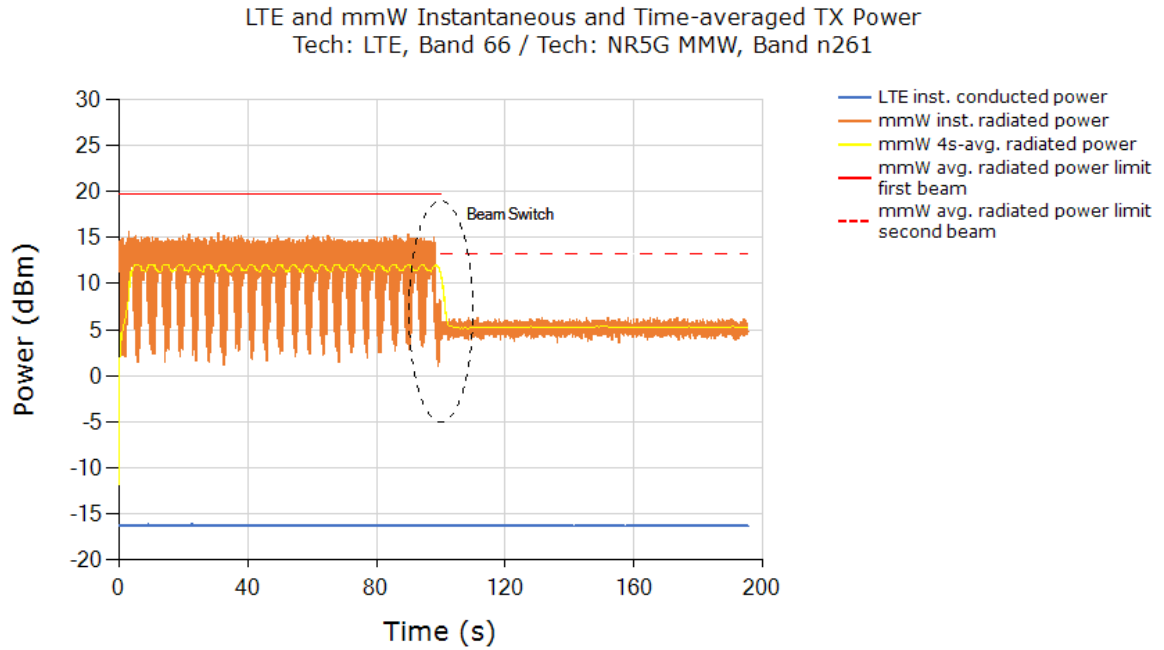

Normalized time-averaged exposures for LTE and mmW ( $4\text{cm}^2\text{PD}$ ), as well as total normalized time-averaged exposure versus time:



Total Normalized Time-averaged RF Exposure  
Tech: LTE, Band 66 / Tech: NR5G MMW, Band n261

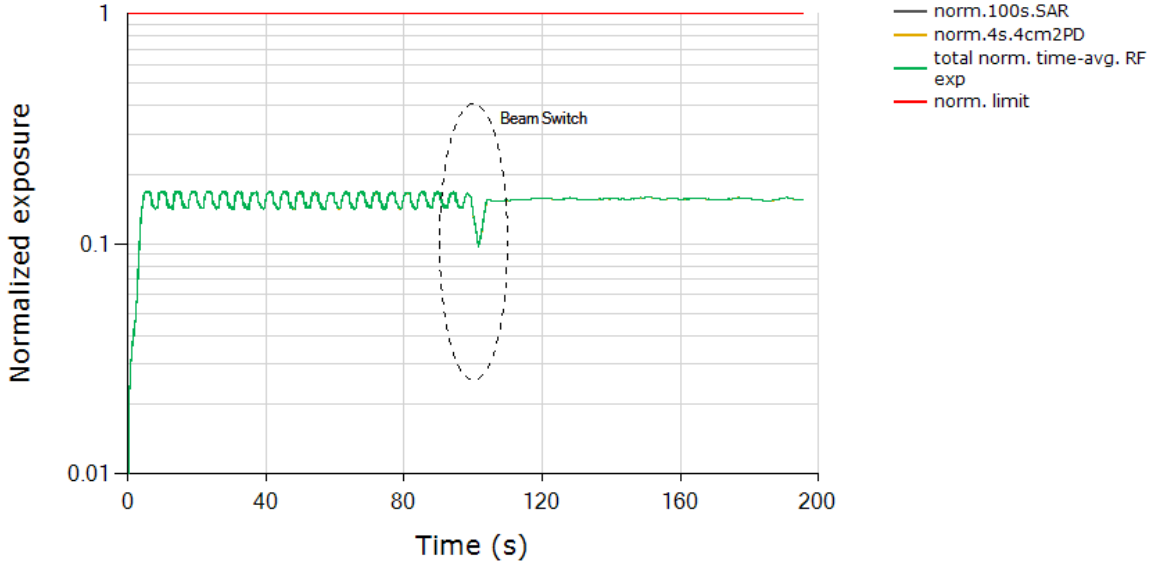

	Exposure ratio
FCC requirement for total RF exposure (normalized)	1.0
Max total normalized time-averaged RF exposure (green curve)	0.170
Validated	

Plot notes: ...

5G mmW NR call was established at ~10s time mark and LTE was placed in all-down bits during this test. For this test, mmW exposure is the dominant contributor as LTE is left in all-down bits. Here, Smart Transmit feature allocates a maximum of 75% for mmW. From Table 8-1 exposure between 10s ~100s corresponds to a normalized 4cm2PD exposure value for r Beam ID 36 of  $(75\% * 1.9W/m^2)/(10 W/m^2) = 14.25\% \pm 2.1dB$  device related uncertainty. At ~100s time mark (shown in black dotted ellipse), beam was switched to Beam ID 5 resulting in a normalized 4cm2PD exposure value of  $(75\% * 2.29W/m^2)/(10 W/m^2) = 17.18\% \pm 2.1dB$  device related uncertainty. Additionally, during the switch, the ratio between the averaged radiated powers of the two beams (yellow curve) should correspond to the difference in EIRPs measured at each corresponding input.power.limit for these beams listed in Table 8-1, i.e.,  $3.85dB \pm 2.1dB$  device uncertainty.

As can be seen, the power limiting enforcement is effective during switching beam switching, and the normalized time-averaged RF exposure does not exceed 1.0. Therefore, Qualcomm® Smart Transmit time averaging feature is validated



## 9 PD Test Results for mmW Smart Transmit Feature Validation

### 9.1 Measurement setup

The measurement setup is similar to normal PD measurements, the EUT is positioned on cDASY6 platform, and is connected with the callbox (conducted for LTE and wirelessly for mmW). Keysight UXM callbox is set to request maximum mmW Tx power from EUT all the time. Hence, “path loss” calibration between callbox antenna and EUT is not needed in this test. The callbox’s LTE port is directly connected to the EUT’s RF port via a directional coupler to measure the EUT’s conducted Tx power using a Rohde & Schwarz NR8S power sensor. Additionally, EUT is connected to the PC via USB connection for toggling between FTM and online mode with Smart Transmit enabled following the test procedures described Section 4.4.

Figure 9-1 shows the schematic of this measurement setup.

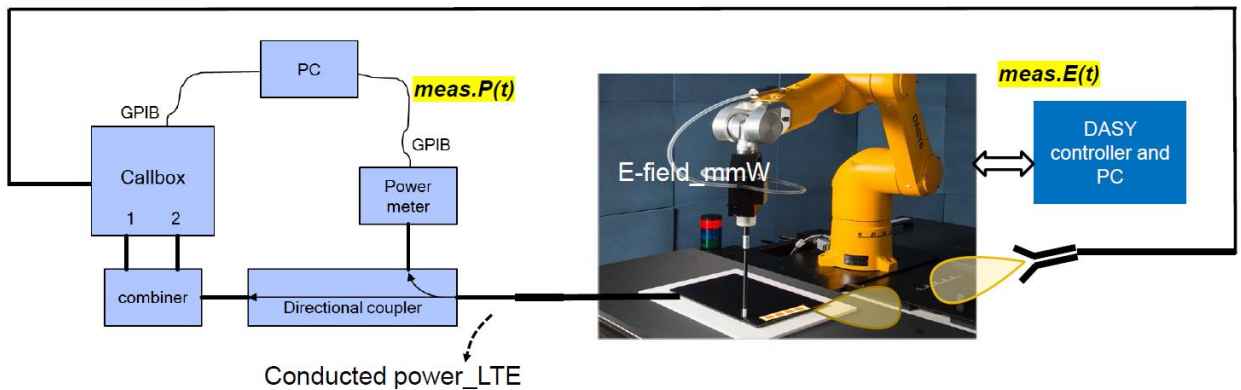

**Figure 9-1 PD measurement setup**

Both callbox and power meters are connected to the PC using USB cables. Test scripts are custom made for automation of establishing LTE + mmW call, and for conducted Tx power recording of LTE transmission. These tests are manually stopped after desired time duration. Once the mmW link is established, LTE Tx power is programmed to toggle between all-up and all-down bits on the callbox. For all the tests, the callbox is set to request maximum Tx power in mmW NR radio from EUT all the time. Therefore, the calibration for the pathloss between the EUT and the horn antenna connected to the remote radio head of the callbox is not required.

Power meter readings are periodically recorded every 10ms on NR8S power sensor for LTE conducted Tx power. Time-averaged E-field measurements are performed using EUmmWVx mmW probe at peak location of fast area scan. The distance between EUmmWVx mmW probe tip to EUT surface is ~0.5 mm, and the distance between EUmmWVx mmW probe sensor to probe tip is 1.5 mm. cDASY6 records relative point E-field (i.e., ratio  $\frac{[pointE(t)]^2}{[pointE\_input.power.limit]^2}$ ) versus time for mmW NR transmission.



## 9.2 PD measurement results for maximum power transmission scenario

The following configurations were measured by following the detailed test procedure is described in Section 4.4:

1. LTE B66 and mmW Band n260 Beam ID 36
2. LTE B66 and mmW Band n261 Beam ID 28

The measured conducted Tx power of LTE and ratio of  $\frac{[pointE(t)]^2}{[pointE\_input.power.limit]^2}$  of mmW is converted into 1gSAR and 4cm<sup>2</sup>PD value, respectively, using Eq. (4a) and (4b), rewritten below:

$$1g\_or\_10gSAR(t) = \frac{conducted\_Tx\_power(t)}{conducted\_Tx\_power\_P_{limit}} * 1g\_or\_10gSAR\_P_{limit} \quad (4a)$$

$$4cm^2PD(t) = \frac{[pointE(t)]^2}{[pointE\_input.power.limit]^2} * 4cm^2PD\_input.power.limit \quad (4b)$$

$$\frac{\frac{1}{T_{SAR}} \int_{t-T_{SAR}}^t 1g\_or\_10gSAR(t) dt}{FCC\ SAR\ limit} + \frac{\frac{1}{T_{PD}} \int_{t-T_{PD}}^t 4cm^2PD(t) dt}{FCC\ 4cm^2PD\ limit} \leq 1 \quad (4c)$$

where,  $conducted\_Tx\_power(t)$ ,  $conducted\_Tx\_power\_P_{limit}$ , and  $1g\_or\_10gSAR\_P_{limit}$  correspond to the measured instantaneous conducted Tx power, measured conducted Tx power at  $P_{limit}$ , and measured 1gSAR or 10gSAR values at  $P_{limit}$  corresponding to LTE transmission. Similarly,  $pointE(t)$ ,  $pointE\_input.power.limit$ , and  $4cm^2PD@input.power.limit$  correspond to the measured instantaneous E-field, E-field at  $input.power.limit$ , and 4cm<sup>2</sup>PD value at  $input.power.limit$  corresponding to mmW transmission.

**NOTE:** cDASY6 system measures relative E-field, and provides ratio of

$$\frac{[pointE(t)]^2}{[pointE\_input.power.limit]^2} \text{ versus time.}$$

The radio configurations tested are described in Table 5-3 and 5-4. The 1gSAR at  $P_{limit}$  for LTE B66 the measured 4cm<sup>2</sup>PD at  $input.power.limit$  of mmW n260 Beam ID 36, and Band n261 Beam ID 28, are all listed in Table 8-1.



### 9.2.1 PD test results for n260

Step 2.e plot (in Section 4.4) for normalized instantaneous and time-averaged exposures for LTE and mmW n260 Beam ID 36

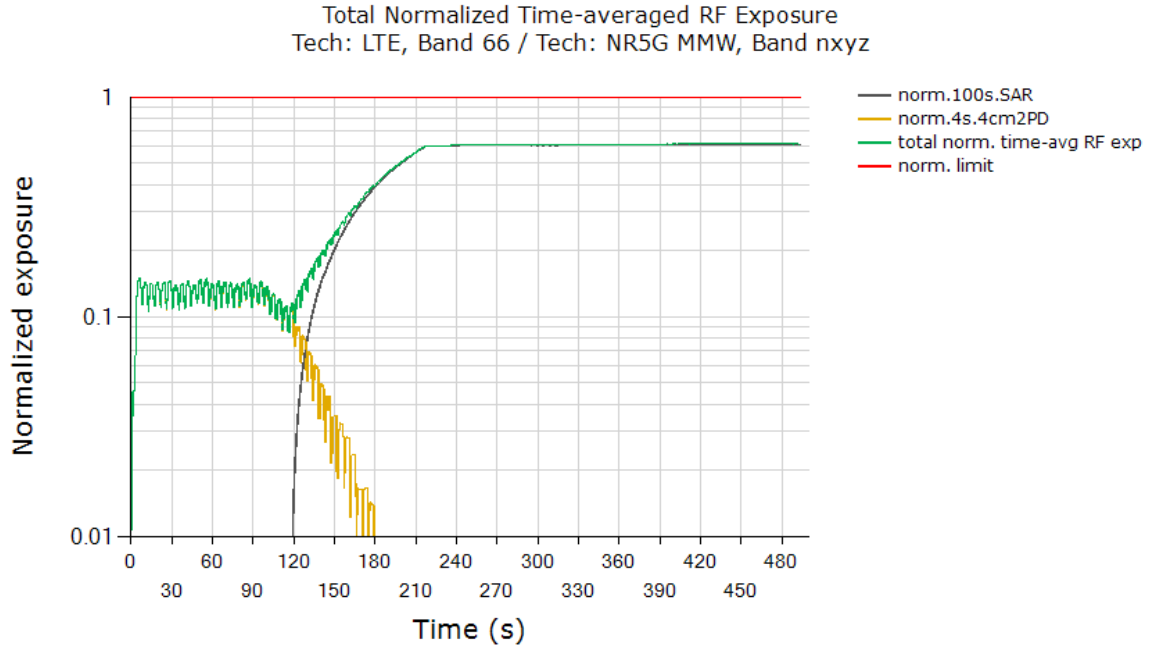

FCC limit for total RF exposure (normalized)	1.0
Max total normalized time-averaged RF exposure (green curve)	0.618
Validated	

Plot notes:

LTE was placed in all-down bits immediately after 5G mmW NR call was established. Between 0s~120s, mmW exposure is the dominant contributor. Here, Smart Transmit feature allocates a maximum of 75% for mmW. From Table 8-1, this corresponds to a normalized 4cm2PD exposure value for Beam ID 36 of  $(75\% * 2.05W/m^2)/(10 W/m^2) = 15.38\% \pm 2.1dB$  device related uncertainty (see orange/green curve between 0s~120s). Around 120s time mark, LTE is set to all-up bits, taking away margin from mmW exposure gradually. Towards the end of the test, LTE is the dominant contributor towards RF exposure, i.e., corresponding normalized 1gSAR exposure value of  $(100\% * 0.836W/kg)/(1.6 W/kg) = 52.25\% + " +1dB \sim -1dB "$  design related uncertainty.

As can be seen, the power limiting enforcement is effective and the total normalized time-averaged RF exposure does not exceed 1.0. Therefore, Qualcomm® Smart Transmit time averaging feature is validated.



### 9.2.2 PD test results for n261

Step 2.e plot (in Section 4.4) for normalized instantaneous and time-averaged exposures for LTE and mmW n261 Beam ID 28:1

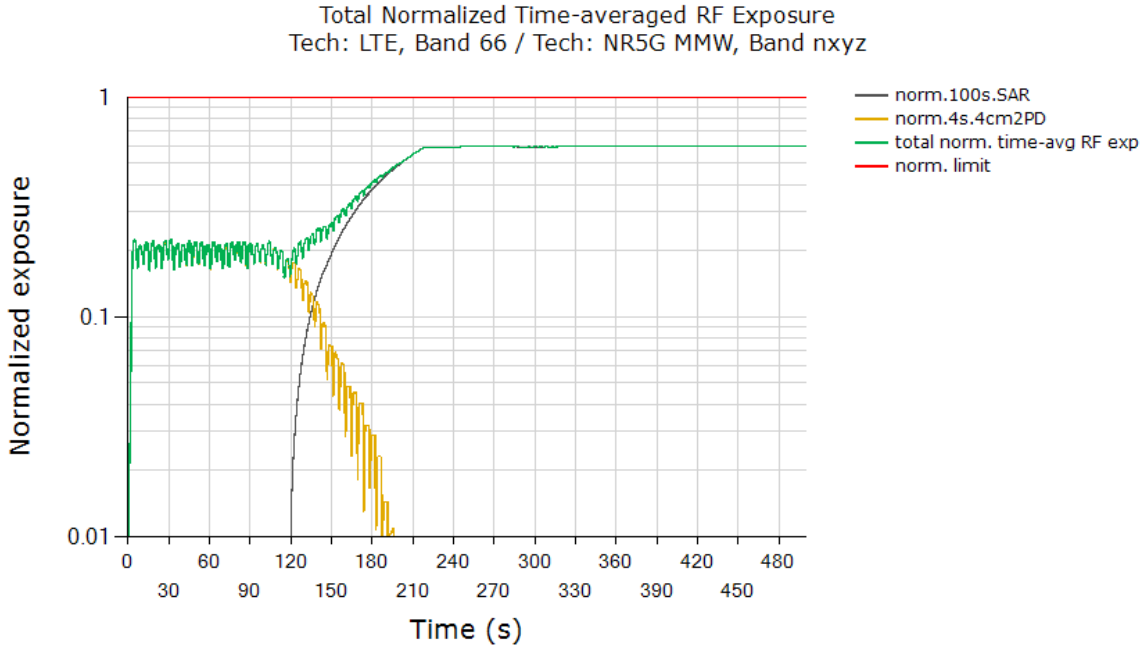

FCC limit for total RF exposure	1.0
Max total normalized time-averaged RF exposure (green curve)	0.604
Validated	

Plot notes: ....

LTE was placed in all-down bits immediately after 5G mmW NR call was established. Between 0s~120s, mmW exposure is the dominant contributor. Here, Smart Transmit feature allocates a maximum of 75% for mmW. From Table 8-1, this corresponds to a normalized 4cm2PD exposure value for Beam ID 28 of  $(75\% * 2.3W/m^2)/(10 W/m^2) = 17.25\% \pm 2.1dB$  device related uncertainty (see orange/green curve between 0s~120s). Around 120s time mark, LTE is set to all-up bits, taking away margin from mmW exposure gradually. Towards the end of the test, LTE is the dominant contributor towards RF exposure, i.e., corresponding normalized 1gSAR exposure value of  $(100\% * 0.836W/kg)/(1.6 W/kg) = 52.25\% + "1dB \sim -1dB"$  design related uncertainty.

As can be seen, the power limiting enforcement is effective and the total normalized time-averaged RF exposure does not exceed 1.0. Therefore, Qualcomm® Smart Transmit time averaging feature is validated



## 10 Conclusions

---

Qualcomm Smart Transmit feature employed has been validated through the conducted/radiated power measurement (as demonstrated in Chapters 6 and 8), as well as SAR and PD measurement (as demonstrated in Chapters 7 and 9).

As demonstrated in this report, the power limiting enforcement is effective and the total normalized time-averaged RF exposure does not exceed 1.0 for all the transmission scenarios described in Section 2. Therefore, the EUT complies with FCC RF exposure requirement



## Appendix A. Test Sequences

1. Test sequence is generated based on below parameters of the EUT:

Measured maximum power ( $P_{max}$ )

Measured Tx\_power\_at\_SAR\_design\_target ( $P_{limit}$ )

Reserve\_power\_margin (dB)

- $P_{reserve}$  (dBm) = measured  $P_{limit}$  (dBm) – Reserve\_power\_margin (dB)

SAR\_time\_window (100s for FCC)

Test Sequence 1 Waveform:

Based on the parameters above, the Test Sequence 1 is generated with one transition between high and low Tx powers. Here, high power =  $P_{max}$ ; low power =  $P_{max}/2$ , and the transition occurs after 80 seconds at high power  $P_{max}$ . As long as the power enforcement is taking into effective during one 100s/60s time window, the validation test with this defined test sequence 1 is valid, otherwise, select other radio configuration (band/DSI within the same technology group) having lower  $P_{limit}$  for this test. The Test sequence 1 waveform is shown below:

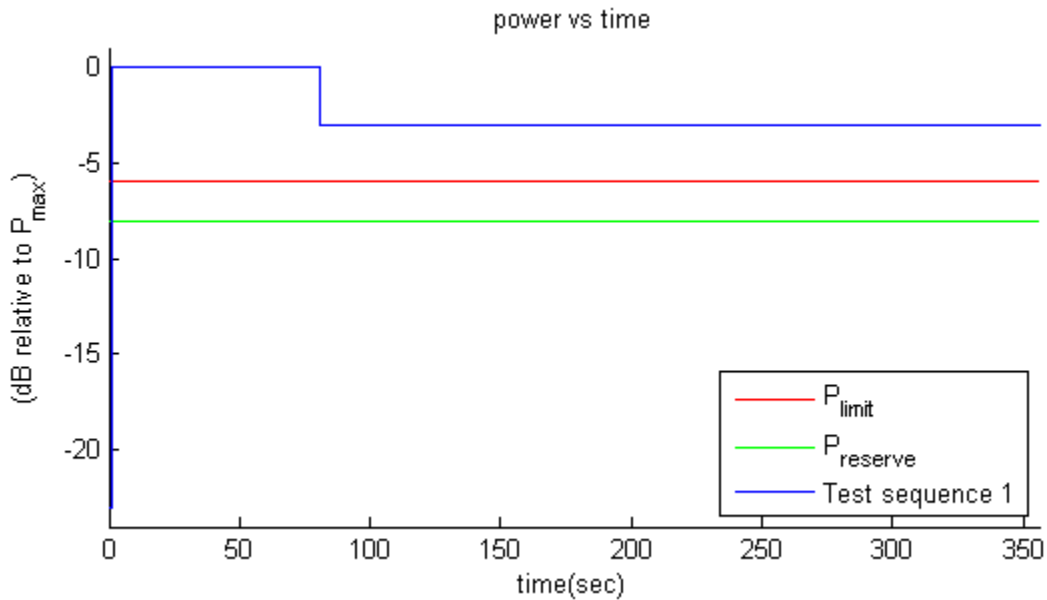

Figure 0-1 Test sequence 1 waveform



Test Sequence 2 Waveform:

Based on the parameters in A-1, the Test Sequence 2 is generated as described in Table 10-1, which contains two 170 second-long sequences (yellow and green highlighted rows) that are mirrored around the center row of 20s, resulting in a total duration of 360 seconds:

**Table 0-1 Test Sequence 2**

Time duration (seconds)	dB relative to $P_{limit}$ or $P_{reserve}$
15	$P_{reserve} - 2$
20	$P_{limit}$
20	$(P_{limit} + P_{max})/2$ averaged in mW and rounded to nearest 0.1 dB step
10	$P_{reserve} - 6$
20	$P_{max}$
15	$P_{limit}$
15	$P_{reserve} - 5$
20	$P_{max}$
10	$P_{reserve} - 3$
15	$P_{limit}$
10	$P_{reserve} - 4$
20	$(P_{limit} + P_{max})/2$ averaged in mW and rounded to nearest 0.1 dB step
10	$P_{reserve} - 4$
15	$P_{limit}$
10	$P_{reserve} - 3$
20	$P_{max}$
15	$P_{reserve} - 5$
15	$P_{limit}$
20	$P_{max}$
10	$P_{reserve} - 6$
20	$(P_{limit} + P_{max})/2$ averaged in mW and rounded to nearest 0.1 dB step
20	$P_{limit}$
15	$P_{reserve} - 2$



The Test Sequence 2 waveform is shown in Figure A-2.

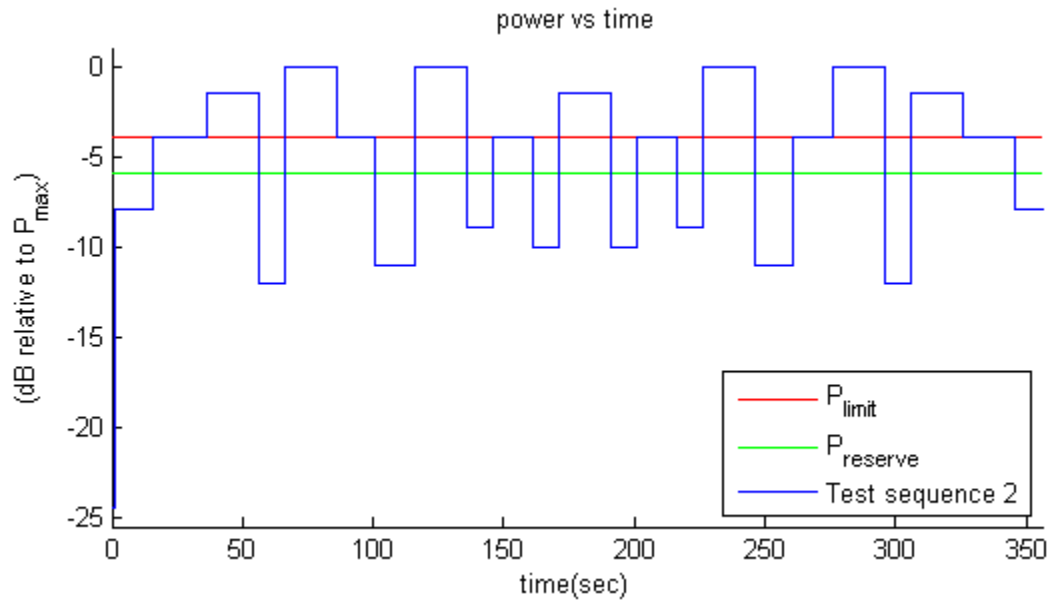





## Appendix B. Test Procedures for sub6 NR + LTE Radio

---

Appendix B provides the test procedures for validating Qualcomm Smart Transmit feature for LTE + Sub6 NR non-standalone (NSA) mode transmission scenario, where sub-6GHz LTE link acts as an anchor.

### 1 Time-varying Tx power test for sub6 NR in NSA mode

Follows Section 3.2.1 to select test configurations for time-varying test. This test is performed with two pre-defined test sequences (described in Section 3.1) applied to Sub6 NR (with LTE on all-down bits or low power for the entire test after establishing the LTE+Sub6 NR call with the callbox). Follow the test procedures described in Section 3.3.1 to demonstrate the effectiveness of power limiting enforcement and that the time averaged Tx power of Sub6 NR when converted into 1gSAR values does not exceed the regulatory limit at all times (see Eq. (1a) and (1b)). Sub6 NR response to test sequence1 and test sequence2 will be similar to other technologies (say, LTE), and are shown in Sections 6.3.7 and 6.3.8.

### 2 Switch in SAR exposure between LTE vs. Sub6 NR during transmission

This test is to demonstrate that Smart Transmit feature accurately accounts for switching in exposures among SAR for LTE radio only, SAR from both LTE radio and sub6 NR, and SAR from sub6 NR only scenarios, and ensures total time-averaged RF exposure compliance with FCC limit.

#### Test procedure:

1. Measure conducted Tx power corresponding to  $P_{limit}$  for LTE and sub6 NR in selected band. Test condition to measure conducted  $P_{limit}$  is:
  - Establish device in call with the callbox for LTE in desired band. Measure conducted Tx power corresponding to LTE  $P_{limit}$  with Smart Transmit enabled and *Reserve\_power\_margin* set to 0 dB, callbox set to request maximum power.
  - Repeat above step to measure conducted Tx power corresponding to Sub6 NR  $P_{limit}$ . If testing LTE+Sub6 NR in non-standalone mode, then establish LTE+Sub6 NR call with callbox and request all down bits for radio1 LTE. In this scenario, with callbox requesting maximum power from Sub6 NR, measured conducted Tx power corresponds to radio2  $P_{limit}$  (as radio1 LTE is at all-down bits)
3. Set *Reserve\_power\_margin* to actual (intended) value with EUT setup for LTE + Sub6 NR call. First, establish LTE connection in all-up bits with the callbox, and then Sub6 NR connection is added with callbox requesting UE to transmit at maximum power in Sub6 NR. As soon as the Sub6 NR connection is established, request all-down bits on LTE link (otherwise, Sub6 NR will not have sufficient RF exposure margin to sustain the call with LTE in all-up bits). Continue LTE (all-down bits)+Sub6 NR transmission for more than one time-window duration to test predominantly Sub6 NR SAR exposure scenario (as SAR exposure is negligible from all-down bits in



- LTE). After at least one time-window, request LTE to go all-up bits to test LTE SAR and Sub6 NR SAR exposure scenario. After at least one more time-window, drop (or request all-down bits) Sub6 NR transmission to test predominantly LTE SAR exposure scenario. Continue the test for at least one more time-window. Record the conducted Tx powers for both LTE and Sub6 NR for the entire duration of this test.
4. Once the measurement is done, extract instantaneous Tx power versus time for both LTE and Sub6 NR links. Similar to technology/band switch test in Section 3.3.3, convert the conducted Tx power for both these radios into 1gSAR value (see Eq. (6a) and (6b)) using corresponding technology/band  $P_{limit}$  measured in Step 1, and then perform 100s running average to determine time-averaged 1gSAR versus time as illustrated in Figure 3-1.
  5. Make one plot containing: (a) instantaneous Tx power versus time measured in Step 2.
  6. Make another plot containing: (a) instantaneous 1gSAR versus time determined in Step 3, (b) computed time-averaged 1gSAR versus time determined in Step 3, and (c) corresponding regulatory  $1gSAR_{limit}$  of 1.6W/kg.

The validation criteria is, at all times, the time-averaged 1gSAR versus time shall not exceed the regulatory  $1gSAR_{limit}$  of 1.6W/kg.

## Appendix C. cDASY6 System Verification

### 1 The system to be used for the near field power density measurement

- SPEAG DASY6 system
- SPEAG cDASY6 5G module software
- EUmmWVx probe
- 5G Phantom cover

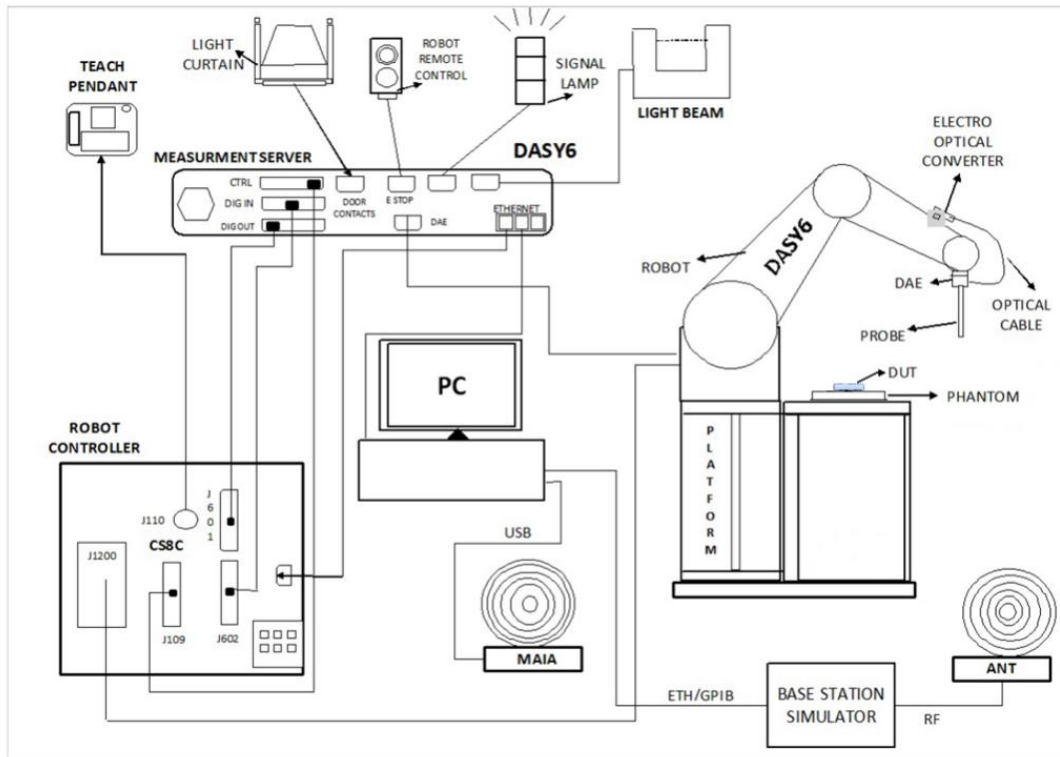

### 2 Test Side Location

Sporton Lab and below test site location are accredited to ISO 17025 by Taiwan Accreditation Foundation (TAF code: 1190) and the FCC designation No. TW1190 under the FCC 2.948(e) by Mutual Recognition Agreement (MRA) in FCC test.

Test Site	SPORTON INTERNATIONAL INC. EMC & Wireless Communications Laboratory TW1190
Test Site Location	No. 52, Huaya 1st Rd., Guishan Dist., Taoyuan City 333, CHINESE TAIPEI
Test Site No.	SAR06-HY

### 3 E UmmWave Probe

The probe design allows measurements at distances as small as 2 mm from the sensors to the surface of the device under test (DUT). The typical sensor to probe tip distance is 1.5 mm.

Frequency	750 MHz – 110 GHz
Probe Overall Length	320 mm
Probe Body Diameter	8.0 mm
Tip Length	23.0 mm
Tip Diameter	8.0 mm
Probe's two dipoles length	0.9 mm – Diode loaded
Dynamic Range	< 20 V/m - 10000 V/m with PRE-10 (min < 50 V/m - 3000 V/m)
Position Precision	< 0.2 mm
Distance between diode sensors and probe's tip	1.5 mm
Minimum Mechanical separation between probe tip and a Surface	0.5 mm
Applications	E-field measurements of 5G devices and other mm-wave transmitters operating above 10GHz in < 2 mm distance from device (free-space) Power density, H-field and far-field analysis using total field reconstruction.
Compatibility	cDASY6 + 5G-Module SW1.0 and higher

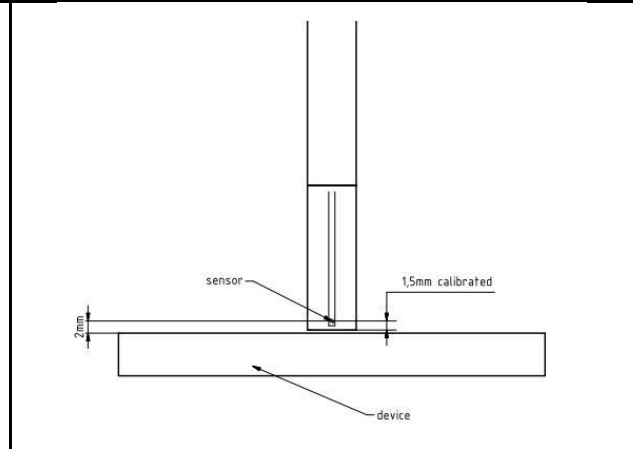

#### 4 EUmWave Verification source

Model	Ka-band horn antenna
Calibrated frequency:	30 GHz at 10mm from the case surface
Frequency accuracy	± 100 MHz
E-field polarization	linear
Harmonics	-20 dBc
Total radiated power	14 dBm
Power stability	0.05 dB
Power consumption	5 W
Size	00 x 100 x 100 mm
Weight	1 kg

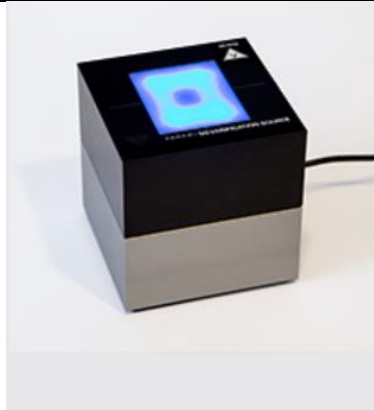

#### 5 SAR E-Field Probe

Construction	Symmetric design with triangular core Built-in shielding against static charges PEEK enclosure material (resistant to organic solvents, e.g., DGBE)	
Frequency	10 MHz – >6 GHz Linearity: ±0.2 dB (30 MHz – 6 GHz)	
Directivity	±0.3 dB in TSL (rotation around probe axis) ±0.5 dB in TSL (rotation normal to probe axis)	
Dynamic Range	10 µW/g – >100 mW/g Linearity: ±0.2 dB (noise: typically <1 µW/g)	
Dimensions	Overall length: 337 mm (tip: 20 mm) Tip diameter: 2.5 mm (body: 12 mm) Typical distance from probe tip to dipole centers: 1 mm	



## 6 Data Acquisition Electronics (DAE)

The data acquisition electronics (DAE) consists of a highly sensitive electrometer-grade preamplifier with auto-zeroing, a channel and gain-switching multiplexer, a fast 16 bit AD-converter and a command decoder and control logic unit. Transmission to the measurement server is accomplished through an optical downlink for data and status information as well as an optical uplink for commands and the clock.

The input impedance of the DAE is 200 MOhm; the inputs are symmetrical and floating. Common mode rejection is above 80 dB.

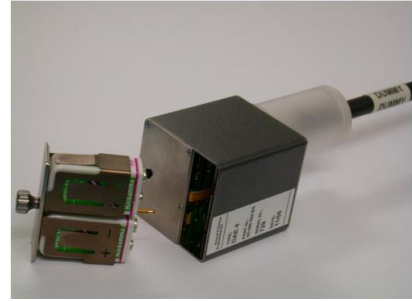



## 7 Test Equipment List

Manufacturer	Name of Equipment	Type/Model	Serial Number	Calibration	
				Last Cal.	Due Date
SPEAG	1900MHz System Validation Kit <sup>(2)</sup>	D1900V2	5d041	Sep. 11, 2018	Sep. 08, 2021
SPEAG	2600MHz System Validation Kit <sup>(2)</sup>	D2600V2	1008	Aug. 31, 2018	Aug. 28, 2021
SPEAG	3700MHz System Validation Kit <sup>(2)</sup>	D3700V2	1006	Mar. 05, 2019	Mar. 02, 2022
SPEAG	5G Verification Source	30GHz	1009	May. 25, 2021	May. 24, 2022
SPEAG	E-Field mmWave Probe	EUmmWV4	9441	Nov. 24, 2020	Nov. 23, 2021
SPEAG	Data Acquisition Electronics	DAE4	316	Jan. 19, 2021	Jan. 18, 2022
SPEAG	Data Acquisition Electronics	DAE4	1424	Jan. 19, 2021	Jan. 18, 2022
SPEAG	Dosimetric E-Field Probe	EX3DV4	3728	Feb. 23, 2021	Feb. 22, 2022
SPEAG	Dosimetric E-Field Probe	EX3DV4	3931	Oct. 22, 2020	Oct. 21, 2021
Keysight	5G Wireless Test Platform	E7515B	MY59321826	Mar. 23, 2021	Mar. 22, 2022
Bojay	mmwave measurement horn antenna	AQRH-15	000023	Note 1	
R&S	Wideband Radio Communication Tester	CMW500	115793	Nov. 23, 2020	Nov. 22, 2021
Anritsu	Power Meter	ML2495A	1419002	Aug. 18, 2021	Aug. 17, 2022
Anritsu	Power Sensor	MA2411B	1911176	Aug. 18, 2021	Aug. 17, 2022
Anritsu	Power Meter	ML2495A	1804003	Oct. 21, 2020	Oct. 20, 2021
Anritsu	Power Sensor	MA2411B	1726150	Oct. 21, 2020	Oct. 20, 2021
Mini-Circuits	Power Amplifier	ZVE-8G+	6418	Oct. 21, 2020	Oct. 20, 2021
Anritsu	Spectrum Analyzer	N9010A	MY53470118	Jan. 15, 2021	Jan. 14, 2022
Anritsu	Signal Generator	MG3710A	6201502524	Nov. 11, 2020	Nov. 10, 2021
Bojay	mmwave measurement horn antenna	AQRH-15	000023	Note 1	
Warison	10-50 GHz Directional Coupler	WCOU-10-50S-10	WR889BMC481	Note 1	
ATM	500M-18GHz Dual Directional Coupler	C122H-10	P610410z-02	Note 1	
Woken	Attenuator 1	WK0602-XX	N/A	Note 1	
PE	Attenuator 2	PE7005-10	N/A	Note 1	
PE	Attenuator 3	PE7005-3	N/A	Note 1	

**General Note:**

1. Prior to system verification and validation, the path loss from the signal generator to the system check source and the power meter, which includes the amplifier, cable, attenuator and directional coupler, was measured by the network analyzer. The reading of the power meter was offset by the path loss difference between the path to the power meter and the path to the system check source to monitor the actual power level fed to the system check source.
2. The dipole calibration interval can be extended to 3 years with justification according to KDB 865664 D01. The dipoles are also not physically damaged, or repaired during the interval. The justification data in appendix C can be found which the return loss is < -20dB, within 20% of prior calibration, the impedance is within 5 ohm of prior calibration for each dipole.



## 8 SAR system verification and validation

### 8.1. Tissue Verification

The following tissue formulations are provided for reference only as some of the parameters have not been thoroughly verified. The composition of ingredients may be modified accordingly to achieve the desired target tissue parameters required for routine SAR evaluation.

Frequency (MHz)	Water (%)	Sugar (%)	Cellulose (%)	Salt (%)	Preventol (%)	DGBE (%)	Conductivity ( $\sigma$ )	Permittivity ( $\epsilon_r$ )
835	40.3	57.9	0.2	1.4	0.2	0	0.90	41.5
1750, 1900, 2000	55.2	0	0	0.3	0	44.5	1.40	40.0
2300	55.0	0	0	0	0	45.0	1.67	39.5
2600	54.8	0	0	0.1	0	45.1	1.96	39.0

#### Simulating Liquid for 5GHz, Manufactured by SPEAG

Ingredients	(% by weight)
Water	64~78%
Mineral oil	11~18%
Emulsifiers	9~15%
Additives and Salt	2~3%

#### <Tissue Check Results>

Frequency (MHz)	Liquid Temp. (°C)	Conductivity ( $\sigma$ )	Permittivity ( $\epsilon_r$ )	Conductivity Target ( $\sigma$ )	Permittivity Target ( $\epsilon_r$ )	Delta ( $\sigma$ ) (%)	Delta ( $\epsilon_r$ ) (%)	Limit (%)	Date
1900	22.4	1.400	40.800	1.40	40.00	0.00	2.00	±5	2021/9/1
2600	22.4	1.930	38.300	1.96	39.00	-1.53	-1.79	±5	2021/8/24
3700	22.4	3.200	38.100	3.12	37.70	2.56	1.06	±5	2021/9/1

### 8.1. System Verification

Comparing to the original SAR value provided by SPEAG, the verification data should be within its specification of 10 %. Below table shows the target SAR and measured SAR after normalized to 1W input power. The table below indicates the system performance check can meet the variation criterion and the plots can be referred to Appendix D.

#### <System Verification Results>

Date	Frequency (MHz)	Input Power (mW)	Dipole S/N	Probe S/N	DAE S/N	Measured 1g SAR (W/kg)	Targeted 1g SAR (W/kg)	Normalized 1g SAR (W/kg)	Deviation (%)	Test Site
2021/9/1	1900	250	D1900V2-5d041	EX3DV4 - SN3931	DAE4 Sn1424	9.34	40.20	37.36	-7.06	SAR06
2021/8/24	2600	250	D2600V2-1008	EX3DV4 - SN3931	DAE4 Sn1424	13.80	56.40	55.2	-2.13	SAR06
2021/9/1	3700	100	D3700V2-1006	EX3DV4 - SN3728	DAE4 Sn1424	7.02	67.30	70.2	4.31	SAR06





### 9 Power Density system verification and validation

The system performance check verifies that the system operates within its specifications.

The EUT is replaced by a calibrated source, the same spatial resolution, measurement region and the test separation used in the calibration was applied to system check. Through visual inspection into the measured power density distribution, both spatially (shape) and numerically (level) have no noticeable difference. The measured results should be within 1 of the calibrated targets.

Frequency [GHz]	Grid step	Grid extent X/Y [mm]	Measurement points
10	0.25 ( $\frac{\lambda}{4}$ )	120/120	16 × 16
30	0.25 ( $\frac{\lambda}{4}$ )	60/60	24 × 24
60	0.25 ( $\frac{\lambda}{4}$ )	32.5/32.5	26 × 26
90	0.25 ( $\frac{\lambda}{4}$ )	30/30	36 × 36

#### Settings for measurement of verification sources

#### <PD System Verification Results>

Frequency (GHz)	5G Verification Source	Probe S/N	DAE S/N	Distance (mm)	Measured 4 cm <sup>2</sup> (W/m <sup>2</sup> )	Targeted 4 cm <sup>2</sup> (W/m <sup>2</sup> )	Deviation (dB)	Date	Test Site
30G	30GHz_1009	9441	316	10	26.8	25.9	0.15	2021/9/3	SAR06