

## FCC Test Report

**Report No.:** RF170713C17-6

**FCC ID:** XHG-R910

**Test Model:** FRKR910KIT

**Received Date:** Jul. 13, 2017

**Test Date:** Jul. 27, 2017 ~ Aug. 04, 2017

**Issued Date:** Aug. 18, 2017

**Applicant:** Franklin Technology Inc.

**Address:** 906 JEI Platz, 186, Gasan digital 1-ro,Gumcheon-Gu,Seoul, 08502 , South Korea

**Issued By:** Bureau Veritas Consumer Products Services (H.K.) Ltd., Taoyuan Branch

**Lab Address:** No. 47-2, 14th Ling, Chia Pau Vil., Lin Kou Dist., New Taipei City, Taiwan ( R.O.C )

**Test Location:** No. 19, Hwa Ya 2nd Rd, Wen Hwa Tsuen, Kwei Shan Hsiang, Taoyuan Hsien 333, Taiwan, R.O.C.



This report is for your exclusive use. Any copying or replication of this report to or for any other person or entity, or use of our name or trademark, is permitted only with our prior written permission. This report sets forth our findings solely with respect to the test samples identified herein. The results set forth in this report are not indicative or representative of the quality or characteristics of the lot from which a test sample was taken or any similar or identical product unless specifically and expressly noted. Our report includes all of the tests requested by you and the results thereof based upon the information that you provided to us. You have 60 days from date of issuance of this report to notify us of any material error or omission caused by our negligence, provided, however, that such notice shall be in writing and shall specifically address the issue you wish to raise. A failure to raise such issue within the prescribed time shall constitute your unqualified acceptance of the completeness of this report, the tests conducted and the correctness of the report contents. Unless specific mention, the uncertainty of measurement has been explicitly taken into account to declare the compliance or non-compliance to the specification. The report must not be used by the client to claim product certification, approval, or endorsement by TAF or any government agencies.

## Table of Contents

<b>Release Control Record</b> .....	<b>4</b>
<b>1 Certificate of Conformity</b> .....	<b>5</b>
<b>2 Summary of Test Results</b> .....	<b>6</b>
2.1 Measurement Uncertainty.....	6
2.2 Modification Record .....	6
<b>3 General Information</b> .....	<b>7</b>
3.1 General Description of EUT .....	7
3.2 Description of Test Modes.....	8
3.2.1 Test Mode Applicability and Tested Channel Detail.....	9
3.3 Duty Cycle of Test Signal .....	11
3.4 Description of Support Units .....	12
3.4.1 Configuration of System under Test .....	12
3.5 General Description of Applied Standards.....	12
<b>4 Test Types and Results</b> .....	<b>13</b>
4.1 Radiated Emission and Bandedge Measurement .....	13
4.1.1 Limits of Radiated Emission and Bandedge Measurement .....	13
4.1.2 Limits of Unwanted Emission Out of the Restricted Bands .....	14
4.1.3 Test Instruments .....	15
4.1.4 Test Procedures.....	16
4.1.5 Deviation from Test Standard .....	16
4.1.6 Test Set Up .....	17
4.1.7 EUT Operating Conditions.....	18
4.1.8 Test Results .....	19
4.2 Conducted Emission Measurement.....	37
4.2.1 Limits of Conducted Emission Measurement .....	37
4.2.2 Test Instruments .....	37
4.2.3 Test Procedures.....	38
4.2.4 Deviation from Test Standard .....	38
4.2.5 Test Setup.....	38
4.2.6 EUT Operating Conditions.....	38
4.2.7 Test Results .....	39
4.3 Transmit Power Measurement.....	41
4.3.1 Limits of Transmit Power Measurement .....	41
4.3.2 Test Setup.....	41
4.3.3 Test Instruments .....	42
4.3.4 Test Procedure .....	42
4.3.5 Deviation from Test Standard .....	42
4.3.6 EUT Operating Conditions.....	42
4.3.7 Test Result .....	43
4.4 Peak Power Spectral Density Measurement .....	46
4.4.1 Limits of Peak Power Spectral Density Measurement .....	46
4.4.2 Test Setup.....	46
4.4.3 Test Instruments .....	46
4.4.4 Test Procedures.....	46
4.4.5 Deviation from Test Standard .....	47
4.4.6 EUT Operating Conditions.....	47
4.4.7 Test Results .....	48
4.5 Frequency Stability .....	52
4.5.1 Limit of Frequency Stability Measurement .....	52
4.5.2 Test Setup.....	52
4.5.3 Test Instruments .....	52
4.5.4 Test Procedure .....	52
4.5.5 Deviation from Test Standard .....	52

4.5.6	EUT Operating Condition .....	52
4.5.7	Test Results .....	53
4.6	6 dB Bandwidth Measurement.....	54
4.6.1	Limits of 6 dB Bandwidth Measurement.....	54
4.6.2	Test Setup .....	54
4.6.3	Test Instruments .....	54
4.6.4	Test Procedure .....	54
4.6.5	Deviation from Test Standard .....	54
4.6.6	EUT Operating Condition .....	54
4.6.7	Test Results .....	55
4.7	Occupied Bandwidth Measurement.....	57
4.7.1	Test Setup.....	57
4.7.2	Test Instruments .....	57
4.7.3	Test Procedure .....	57
4.7.4	Deviation from Test Standard .....	57
4.7.5	EUT Operating Conditions.....	57
4.7.6	Test Results .....	58
<b>5</b>	<b>Pictures of Test Arrangements.....</b>	<b>60</b>
	<b>Annex A- Radiated Out of Band Emision (OOBE) Measurement (For U-NII-3 band).....</b>	<b>61</b>
	<b>Appendix – Information on the Testing Laboratories .....</b>	<b>63</b>

### Release Control Record

Issue No.	Description	Date Issued
RF170713C17-6	Original Release	Aug. 18, 2017

## 1 Certificate of Conformity

**Product:** Mobile Hotspot  
**Brand:** Franklin Wireless  
**Test Model:** FRKR910KIT  
**Sample Status:** Production Unit  
**Applicant:** Franklin Technology Inc.  
**Test Date:** Jul. 27, 2017 ~ Aug. 04, 2017  
**Standards:** 47 CFR FCC Part 15, Subpart E (Section 15.407)  
ANSI C63.10:2013

The above equipment has been tested by **Bureau Veritas Consumer Products Services (H.K.) Ltd., Taoyuan Branch**, and found compliance with the requirement of the above standards. The test record, data evaluation & Equipment Under Test (EUT) configurations represented herein are true and accurate accounts of the measurements of the sample's EMC characteristics under the conditions specified in this report.

**Prepared by :** Gina Liu , **Date:** Aug. 18, 2017  
Gina Liu / Specialist

**Approved by :** David Huang , **Date:** Aug. 18, 2017  
David Huang / Project Engineer

## 2 Summary of Test Results

47 CFR FCC Part 15, Subpart E (Section 15.407)			
FCC Clause	Test Item	Result	Remarks
15.407(b)(6)	AC Power Conducted Emissions	Pass	Meet the requirement of limit. Minimum passing margin is -16.88 dB at 0.57620 MHz.
15.407(b) (1/2/3/4(i/ii)/6)	Radiated Emissions & Band Edge Measurement	Pass	Meet the requirement of limit. Minimum passing margin is -4.57 dB at 5721.72 MHz.
15.407(a)(1/2/3)	Max Average Transmit Power	Pass	Meet the requirement of limit.
15.407(a)(1/2/3)	Peak Power Spectral Density	Pass	Meet the requirement of limit.
15.407(e)	6 dB Bandwidth	Pass	Meet the requirement of limit. (U-NII-3 Band only)
15.407(g)	Frequency Stability	Pass	Meet the requirement of limit.
15.203	Antenna Requirement	Pass	No antenna connector is used.

\*For U-NII-3 band compliance with rule part 15.407(b)(4)(i), the OOB test plots were recorded in Annex A.

### 2.1 Measurement Uncertainty

Where relevant, the following measurement uncertainty levels have been estimated for tests performed on the EUT as specified in CISPR 16-4-2:

Measurement	Frequency	Expanded Uncertainty (k=2) (±)
Conducted Emissions at mains ports	150 kHz ~ 30 MHz	2.44 dB
Radiated Emissions up to 1 GHz	30 MHz ~ 200 MHz	2.93 dB
	200 MHz ~ 1000 MHz	2.95 dB
Radiated Emissions above 1 GHz	1 GHz ~ 18 GHz	2.26 dB
	18 GHz ~ 40 GHz	1.94 dB

### 2.2 Modification Record

There were no modifications required for compliance.

### 3 General Information

#### 3.1 General Description of EUT

<b>Product</b>	Mobile Hotspot	
<b>Brand</b>	Franklin Wireless	
<b>Test Model</b>	FRKR910KIT	
<b>Status of EUT</b>	Production Unit	
<b>Power Supply Rating</b>	5.0 Vdc (adapter or host equipment) 3.8 Vdc (Li-ion battery)	
<b>Modulation Type</b>	256QAM, 64QAM, 16QAM, QPSK, BPSK	
<b>Modulation Technology</b>	OFDM	
<b>Transfer Rate</b>	802.11n: up to MCS15 802.11ac: up to V9	
<b>Operating Frequency</b>	5180 ~ 5240 MHz, 5745 ~ 5825 MHz	
<b>Number of Channel</b>	5180 ~ 5240 MHz: 4 for 802.11n (HT20) 2 for 802.11n (HT40) 1 for 802.11ac (VHT80) 5745 ~ 5825 MHz: 5 for 802.11n (HT20) 2 for 802.11n (HT40) 1 for 802.11ac (VHT80)	
<b>Output Power</b>	13.309 mW for 5180 ~ 5240 MHz 13.762 mW for 5745 ~ 5825 MHz	
<b>Antenna Type</b>	PCB antenna with	Main: 4.63 dBi / Aux.: -1.68 dBi (5180 ~ 5240 MHz) Main: 2.51 dBi / Aux.: 3.56 dBi (5745 ~ 5825 MHz)
<b>Antenna Connector</b>	N/A	
<b>Accessory Device</b>	Refer to Note as below	
<b>Data Cable Supplied</b>	Refer to Note as below	

#### Note:

- The EUT incorporates a MIMO function. Physically, the EUT provides two completed transmitters and two receivers.

Modulation Mode	Tx Function
802.11n (HT20)	2TX
802.11n (HT40)	2TX
802.11ac (VHT80)	2TX

\* The modulation and bandwidth are similar for 802.11n mode for HT20 / HT40 and 802.11ac mode for HT20 / HT40, therefore investigated worst case to representative mode in test report. (Final test mode refer section 3.2.1)

- The EUT contains following accessory devices.

Product	Brand	Model	Description
Adapter	JIANGSU CHENYANG ELECTRON	CYSE12-050200U	I/P: 100-240 Vac, 50/60 Hz, 0.35 mA O/P: 5 Vdc, 2000 mA
Battery	BAK	R910	3.8 Vdc, 3000 mAh
Main Board	BOMIN	R910	--
BT/WLAN Module	Qualcomm Atheros	QCA-6174A-1	--

- The above EUT information is declared by manufacturer and for more detailed features description, please refer to the manufacturer's specifications or user's manual.

### 3.2 Description of Test Modes

#### For 5180 ~ 5240 MHz

4 channels are provided for 802.11n (HT20):

Channel	Frequency (MHz)	Channel	Frequency (MHz)
36	5180	44	5220
40	5200	48	5240

2 channels are provided for 802.11n (HT40):

Channel	Frequency (MHz)	Channel	Frequency (MHz)
38	5190	46	5230

1 channel is provided for 802.11ac (VHT80):

Channel	Frequency (MHz)
42	5210

#### For 5745 ~ 5825 MHz:

5 channels are provided for 802.11n (HT20):

Channel	Frequency (MHz)	Channel	Frequency (MHz)
149	5745	161	5805
153	5765	165	5825
157	5785		

2 channels are provided for 802.11n (HT40):

Channel	Frequency (MHz)	Channel	Frequency (MHz)
151	5755	159	5795

1 channel is provided for 802.11ac (VHT80):

Channel	Frequency (MHz)
155	5775



### 3.2.1 Test Mode Applicability and Tested Channel Detail

EUT Configure Mode	Applicable To				Description
	RE $\geq$ 1G	RE $<$ 1G	PLC	APCM	
-	√	√	√	√	-

Where **RE $\geq$ 1G**: Radiated Emission above 1 GHz      **RE $<$ 1G**: Radiated Emission below 1 GHz  
**PLC**: Power Line Conducted Emission      **APCM**: Antenna Port Conducted Measurement

**Note:**

1. The EUT had been pre-tested on the positioned of each 3 axis. The worst case was found when positioned on **Z-plane**.
2. "-" means no effect.

#### **Radiated Emission Test (Above 1 GHz):**

- Pre-Scan has been conducted to determine the worst-case mode from all possible combinations between available modulations, data rates and antenna ports (if EUT with antenna diversity architecture).
- Following channel(s) was (were) selected for the final test as listed below.

EUT Configure Mode	Frequency Band (MHz)	Mode	Available Channel	Tested Channel	Modulation Technology	Modulation Type	Data Rate (Mbps)
-	5180-5240	802.11n (HT20)	36 to 48	36, 44, 48	OFDM	BPSK	MCS0
-		802.11n (HT40)	38 to 46	38, 46	OFDM	BPSK	MCS0
-		802.11ac (VHT80)	42	42	OFDM	BPSK	MCS0
-	5745-5825	802.11n (HT20)	149 to 165	149, 157, 165	OFDM	BPSK	6.0
-		802.11n (HT40)	151 to 159	151, 159	OFDM	BPSK	MCS0
-		802.11ac (VHT80)	155	155	OFDM	BPSK	MCS0

#### **Radiated Emission Test (Below 1 GHz):**

- Pre-Scan has been conducted to determine the worst-case mode from all possible combinations between available modulations, data rates and antenna ports (if EUT with antenna diversity architecture).
- Following channel(s) was (were) selected for the final test as listed below.

EUT Configure Mode	Frequency Band (MHz)	Mode	Available Channel	Tested Channel	Modulation Technology	Modulation Type	Data Rate (Mbps)
-	5180-5240	802.11n (HT20)	36 to 48	36	OFDM	BPSK	MCS0
-	5745-5825	802.11n (HT40)	151 to 159	151	OFDM	BPSK	MCS0

#### **Power Line Conducted Emission Test:**

- Pre-Scan has been conducted to determine the worst-case mode from all possible combinations between available modulations, data rates and antenna ports (if EUT with antenna diversity architecture).
- Following channel(s) was (were) selected for the final test as listed below.

EUT Configure Mode	Frequency Band (MHz)	Mode	Available Channel	Tested Channel	Modulation Technology	Modulation Type	Data Rate (Mbps)
-	5745-5825	802.11n (HT40)	151 to 159	151	OFDM	BPSK	MCS0

**Antenna Port Conducted Measurement:**

- This item includes all test value of each mode, but only includes spectrum plot of worst value of each mode.
- Pre-Scan has been conducted to determine the worst-case mode from all possible combinations between available modulations, data rates and antenna ports (if EUT with antenna diversity architecture).
- Following channel(s) was (were) selected for the final test as listed below.

EUT Configure Mode	Frequency Band (MHz)	Mode	Available Channel	Tested Channel	Modulation Technology	Modulation Type	Data Rate (Mbps)
-	5180-5240	802.11n (HT20)	36 to 48	36, 44, 48	OFDM	BPSK	6.0
-		802.11n (HT40)	38 to 46	38, 46	OFDM	BPSK	MCS0
-		802.11ac (VHT80)	42	42	OFDM	BPSK	MCS0
-	5745-5825	802.11n (HT20)	149 to 165	149, 157, 165	OFDM	BPSK	6.0
-		802.11n (HT40)	151 to 159	151, 159	OFDM	BPSK	MCS0
-		802.11ac (VHT80)	155	155	OFDM	BPSK	MCS0

**Test Condition:**

Applicable To	Environmental Conditions	Input Power	Tested by
RE≥1G	25 deg. C, 65 % RH	120 Vac, 60 Hz	Gavin Wu, Getaz Yang
RE<1G	25 deg. C, 65 % RH	120 Vac, 60 Hz	Gavin Wu
PLC	25 deg. C, 65 % RH	120 Vac, 60 Hz	Getaz Yang
APCM	25 deg. C, 65 % RH	3.8 Vdc	Carlos Chen

### 3.3 Duty Cycle of Test Signal

#### MODULATION TYPE: BPSK

**802.11n (HT20):** Duty cycle =  $1.922/2.037 = 0.944$ , Duty factor =  $10 * \log(1/0.944) = 0.25$

**802.11n (HT40):** Duty cycle =  $0.945/1.07 = 0.883$ , Duty factor =  $10 * \log(1/0.883) = 0.54$

**802.11ac (VHT80):** Duty cycle =  $0.462/0.562 = 0.822$ , Duty factor =  $10 * \log(1/0.822) = 0.85$

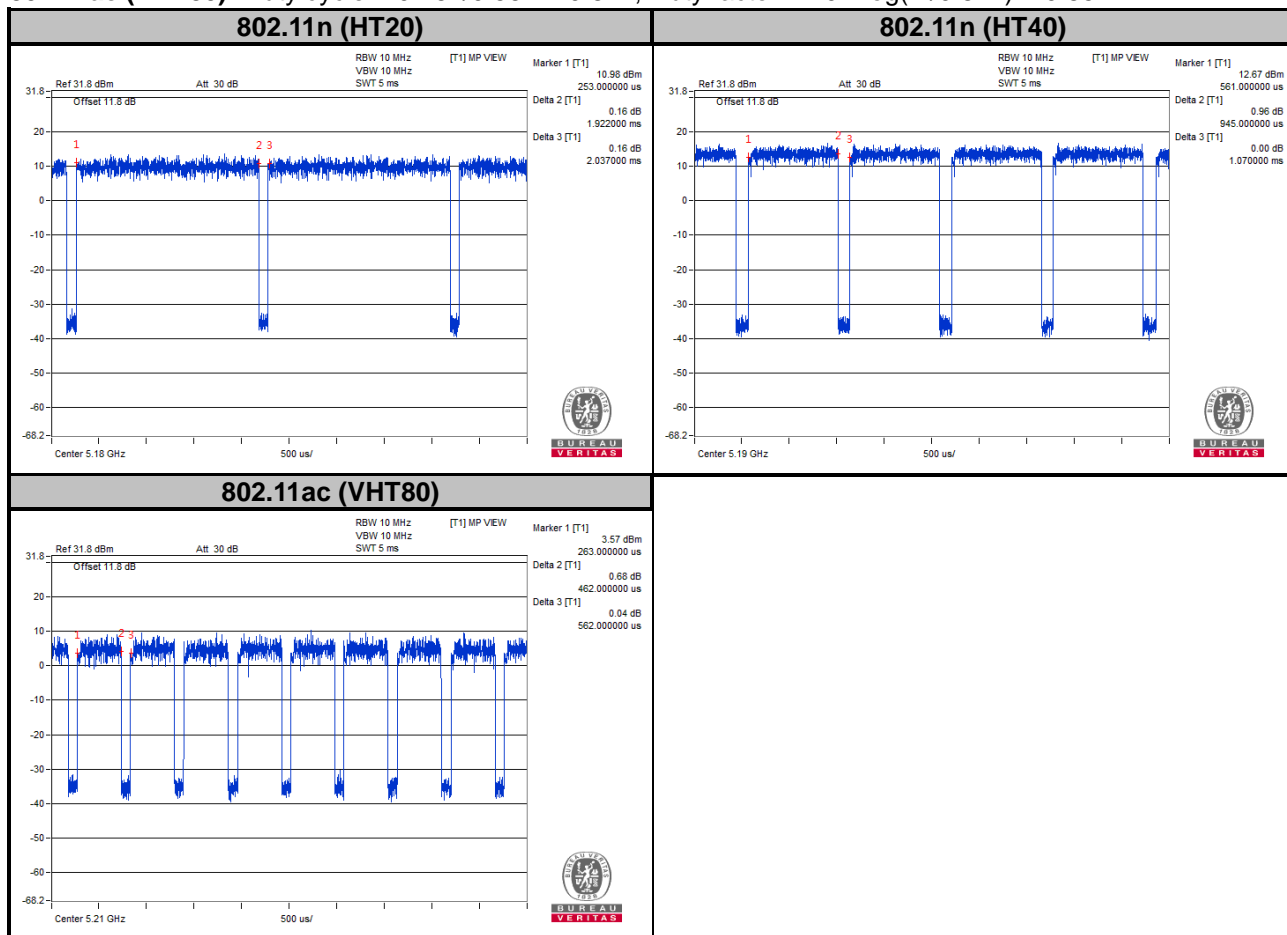

### 3.4 Description of Support Units

The EUT has been tested as an independent unit together with other necessary accessories or support units.

#### 3.4.1 Configuration of System under Test

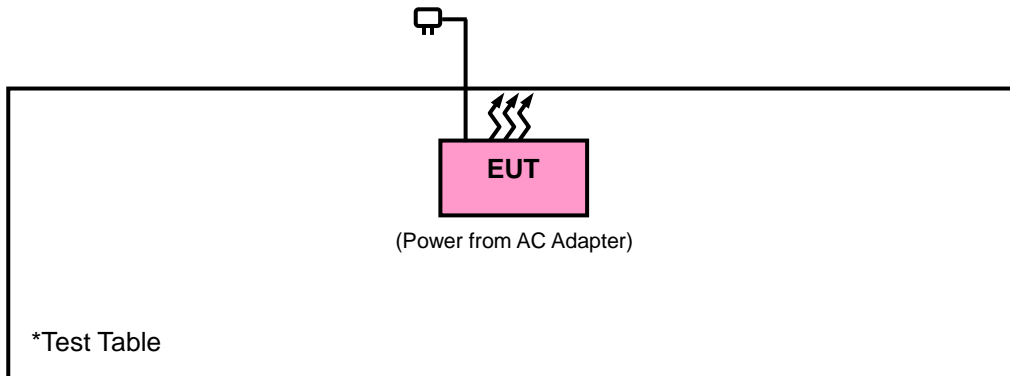

### 3.5 General Description of Applied Standards

The EUT is a RF Product. According to the specifications of the manufacturer, it must comply with the requirements of the following standards:

#### **FCC Part 15, Subpart E (15.407)**

**789033 D02 General UNII Test Procedures New Rules v01r04**

**644545 D01 Guidance for IEEE 802 11ac v01r02**

**662911 D01 Multiple Transmitter Output v02r01**

ANSI C63.10-2013

All test items have been performed and recorded as per the above standards.

**Note:** The EUT has been verified to comply with the requirements of FCC Part 15, Subpart B, Class B (DoC).  
The test report has been issued separately.

## 4 Test Types and Results

### 4.1 Radiated Emission and Bandedge Measurement

#### 4.1.1 Limits of Radiated Emission and Bandedge Measurement

Radiated emissions which fall in the restricted bands must comply with the radiated emission limits specified as below table. Other emissions shall be at least 20 dB below the highest level of the desired power:

Frequencies (MHz)	Field Strength (microvolts/meter)	Measurement Distance (meters)
0.009 ~ 0.490	2400/F (kHz)	300
0.490 ~ 1.705	24000/F (kHz)	30
1.705 ~ 30.0	30	30
30 ~ 88	100	3
88 ~ 216	150	3
216 ~ 960	200	3
Above 960	500	3

**Note:**

1. The lower limit shall apply at the transition frequencies.
2. Emission level (dBuV/m) = 20 log Emission level (uV/m).
3. For frequencies above 1000 MHz, the field strength limits are based on average detector, however, the peak field strength of any emission shall not exceed the maximum permitted average limits, specified above by more than 20 dB under any condition of modulation.

## 4.1.2 Limits of Unwanted Emission Out of the Restricted Bands

Applicable To		Limit	
789033 D02 General UNII Test Procedures New Rules v01r04		Field Strength at 3 m	
		PK: 74 (dBµV/m)	AV: 54 (dBµV/m)
Frequency Band	Applicable To	EIRP Limit	Equivalent Field Strength at 3 m
5150~5250 MHz	15.407(b)(1)	PK: -27 (dBm/MHz)	PK: 68.2 (dBµV/m)
5250~5350 MHz	15.407(b)(2)		
5470~5725 MHz	15.407(b)(3)		
5725~5850 MHz	15.407(b)(4)(i)	PK:-27 (dBm/MHz) <sup>*1</sup> PK:10 (dBm/MHz) <sup>*2</sup> PK:15.6 (dBm/MHz) <sup>*3</sup> PK:27 (dBm/MHz) <sup>*4</sup>	PK: 68.2 (dBµV/m) <sup>*1</sup> PK:105.2 (dBµV/m) <sup>*2</sup> PK: 110.8 (dBµV/m) <sup>*3</sup> PK:122.2 (dBµV/m) <sup>*4</sup>
	15.407(b)(4)(ii)	Emission limits in section 15.247(d)	

<sup>\*1</sup> beyond 75 MHz or more above of the band edge.

<sup>\*2</sup> below the band edge increasing linearly to 10 dBm/MHz at 25 MHz above.

<sup>\*3</sup> below the band edge increasing linearly to a level of 15.6 dBm/MHz at 5 MHz above.

<sup>\*4</sup> from 5 MHz above or below the band edge increasing linearly to a level of 27 dBm/MHz at the band edge.

**Note:**

The following formula is used to convert the equipment isotropic radiated power (eirp) to field strength:

$$E = \frac{1000000\sqrt{30P}}{3} \mu\text{V/m, where } P \text{ is the eirp (Watts).}$$

#### 4.1.3 Test Instruments

Description & Manufacturer	Model No.	Serial No.	Date of Calibration	Due Date of Calibration
Test Receiver Agilent	N9038A	MY51210203	Feb. 17, 2017	Feb. 16, 2018
Spectrum Analyzer Agilent	N9010A	MY52220314	Dec. 16, 2016	Dec. 15, 2017
Spectrum Analyzer ROHDE & SCHWARZ	FSU43	101261	Dec. 13, 2016	Dec. 12, 2017
BILOG Antenna SCHWARZBECK	VULB9168	9168-472	Dec. 26, 2016	Dec. 27, 2017
HORN Antenna SCHWARZBECK	BBHA 9120 D	9120D-969	Dec. 12, 2016	Dec. 13, 2017
HORN Antenna SCHWARZBECK	BBHA 9170	9170-480	Dec. 14, 2016	Dec. 13, 2017
Loop Antenna	EM-6879	269	Aug. 11, 2016	Aug. 10, 2017
Bluetooth Tester	CBT	100980	Jun. 28, 2017	Jun. 27, 2019
Preamplifier EMCI	EMC 012645	980115	Oct. 21, 2016	Oct. 20, 2017
Preamplifier EMCI	EMC 184045	980116	Oct. 21, 2016	Oct. 20, 2017
Preamplifier EMCI	EMC 330H	980112	Oct. 21, 2016	Oct. 20, 2017
Power Meter Anritsu	ML2495A	1232002	Sep. 08, 2016	Sep. 07, 2017
Power Sensor Anritsu	MA2411B	1207325	Sep. 08, 2016	Sep. 07, 2017
RF signal cable HUBER+SUHNNER	SUCOFLEX 104	309219/4 2950114	Oct. 21, 2016	Oct. 20, 2017
RF signal cable HUBER+SUHNNER	SUCOFLEX 104	250130/4	Oct. 21, 2016	Oct. 20, 2017
RF Coaxial Cable Worken	8D-FB	Cable-Ch10-01	Oct. 21, 2016	Oct. 20, 2017
Software BV ADT	E3 6.120103	NA	NA	NA
Antenna Tower MF	MFA-440H	NA	NA	NA
Turn Table MF	MFT-201SS	NA	NA	NA
Antenna Tower & Turn Table Controller MF	MF-7802	NA	NA	NA
Temperature & Humidity Chamber	GTH-120-40-CP-AR	MAA1306-019	Sep. 02, 2016	Sep. 01, 2017
DC Power Supply Topward	33010D	807748	Oct. 25, 2016	Oct. 24, 2018
Digital Multimeter Fluke	87-III	70360742	Jul. 30, 2017	Jul. 29, 2018

- Note:
1. The calibration interval of the above test instruments is 12 / 24 months and the calibrations are traceable to NML/ROC and NIST/USA.
  2. The test was performed in HwaYa Chamber 10.
  3. The horn antenna and preamplifier (model: EMC 184045) are used only for the measurement of emission frequency above 1 GHz if tested.
  4. The IC Site Registration No. is IC7450F-10.

#### 4.1.4 Test Procedures

- a. The EUT was placed on the top of a rotating table 0.8 meters (for below 1 GHz) / 1.5 meters (for above 1 GHz) above the ground at 3 meter chamber room for test. The table was rotated 360 degrees to determine the position of the highest radiation.
- b. The EUT was set 3 meters away from the interference-receiving antenna, which was mounted on the top of a variable-height antenna tower.
- c. The height of antenna is varied from one meter to four meters above the ground to determine the maximum value of the field strength. Both horizontal and vertical polarizations of the antenna are set to make the measurement.
- d. For each suspected emission, the EUT was arranged to its worst case and then the antenna was tuned to heights from 1 meter to 4 meters and the rotatable table was turned from 0 degrees to 360 degrees to find the maximum reading.
- e. The test-receiver system was set to quasi-peak detect function and specified bandwidth with maximum hold mode when the test frequency is below 1 GHz.
- f. The test-receiver system was set to peak and average detected function and specified bandwidth with maximum hold mode when the test frequency is above 1 GHz. If the peak reading value also meets average limit, measurement with the average detector is unnecessary.

**Note:**

1. The resolution bandwidth and video bandwidth of test receiver/spectrum analyzer is 120 kHz & 360 kHz for Quasi-peak detection (QP) at frequency below 1 GHz.
2. The resolution bandwidth of test receiver/spectrum analyzer is 1 MHz and the video bandwidth is 3 MHz for Peak detection (PK) at frequency above 1 GHz.
3. The resolution bandwidth of test receiver/spectrum analyzer is 1 MHz and the video bandwidth is 1/T for Average (Duty cycle < 98 %) detection at frequency above 1 GHz.
4. The resolution bandwidth of test receiver/spectrum analyzer is 1 MHz and the video bandwidth is 10 Hz (Duty cycle ≥ 98 %) for Average detection (AV) at frequency above 1 GHz.
5. All modes of operation were investigated and the worst-case emissions are reported.

#### 4.1.5 Deviation from Test Standard

No deviation.



4.1.6 Test Set Up

<Radiated emission below 30MHz>

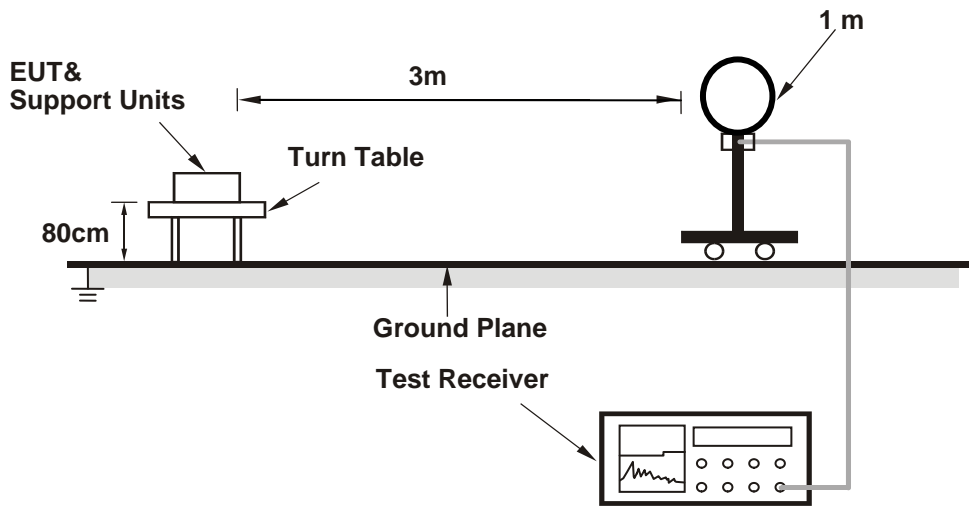

<Frequency Range below 1 GHz>

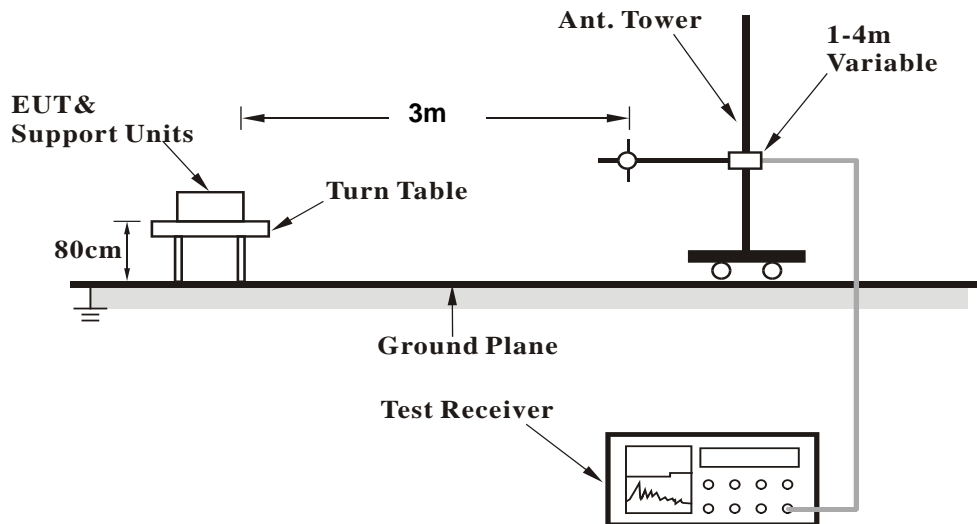

<Frequency Range above 1 GHz>

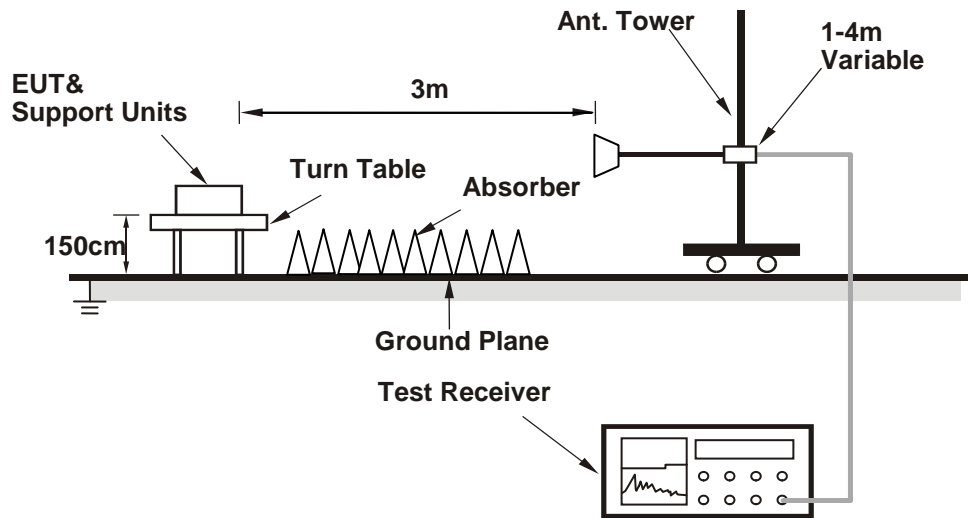

For the actual test configuration, please refer to the attached file (Test Setup Photo).

#### 4.1.7 EUT Operating Conditions

- a. Placed the EUT on a testing table.
- b. Use the software to control the EUT under transmission condition continuously at specific channel frequency.

## 4.1.8 Test Results

## Above 1 GHz Data :

## 802.11n (HT20)

EUT Test Condition		Measurement Detail	
Channel	Channel 36	Frequency Range	1 GHz ~ 40 GHz
Input Power	120 Vac, 60 Hz	Detector Function	Peak (PK) Average (AV)
Environmental Conditions	25 deg. C, 65 % RH	Tested By	Gavin Wu

Antenna Polarity & Test Distance: Horizontal at 3 m										
Frequency (MHz)	Emission Level (dBuV/m)	Read Level (dBuV)	Limit (dBuV/m)	Margin (dB)	Antenna Factor (dB/m)	Cable Loss (dB)	Preamp Factor (dB)	Antenna Height (cm)	Table Angle (Degree)	Remark
5127.05	51.73	51.4	74	-22.27	31.31	6.32	37.3	212	243	Peak
5146.4	39.55	39.21	54	-14.45	31.32	6.34	37.32	212	243	Average
5180	89.73	89.35			31.35	6.37	37.34	212	243	Average
5180	98.8	98.42			31.35	6.37	37.34	212	243	Peak
*10360	66.24	69.29	68.2	-1.96	39.19	10.21	52.45	169	214	Peak
Antenna Polarity & Test Distance: Vertical at 3 m										
Frequency (MHz)	Emission Level (dBuV/m)	Read Level (dBuV)	Limit (dBuV/m)	Margin (dB)	Antenna Factor (dB/m)	Cable Loss (dB)	Preamp Factor (dB)	Antenna Height (cm)	Table Angle (Degree)	Remark
5133.05	51.77	51.44	74	-22.23	31.31	6.32	37.3	200	300	Peak
5149.7	40.54	40.2	54	-13.46	31.32	6.34	37.32	200	300	Average
5180	92.56	92.18			31.35	6.37	37.34	200	300	Average
5180	102.16	101.78			31.35	6.37	37.34	200	300	Peak
*10360	66.13	68.87	68.2	-2.07	39.19	10.21	52.14	157	4	Peak

## Remarks:

- Emission Level = Read Level + Antenna Factor + Cable Loss - Preamp Factor  
Margin value = Emission level – Limit value
- 5180 MHz: Fundamental Frequency
- \*: Out of Restricted Band

EUT Test Condition		Measurement Detail	
Channel	Channel 44	Frequency Range	1 GHz ~ 40 GHz
Input Power	120 Vac, 60 Hz	Detector Function	Peak (PK) Average (AV)
Environmental Conditions	25 deg. C, 65 % RH	Tested By	Gavin Wu

Antenna Polarity & Test Distance: Horizontal at 3 m										
Frequency (MHz)	Emission Level (dBuV/m)	Read Level (dBuV)	Limit (dBuV/m)	Margin (dB)	Antenna Factor (dB/m)	Cable Loss (dB)	Preamp Factor (dB)	Antenna Height (cm)	Table Angle (Degree)	Remark
5127.2	38.86	38.53	54	-15.14	31.31	6.32	37.3	195	251	Average
5128.7	50.61	50.28	74	-23.39	31.31	6.32	37.3	195	251	Peak
5220	88.91	88.5			31.37	6.4	37.36	195	251	Average
5220	98.6	98.19			31.37	6.4	37.36	195	251	Peak
5427.99	51.38	50.49	74	-22.62	31.53	6.49	37.13	195	251	Peak
5453.07	38.97	37.98	54	-15.03	31.56	6.51	37.08	195	251	Average
*10440	64.77	67.79	68.2	-3.43	39.29	10.21	52.52	162	324	Peak
Antenna Polarity & Test Distance: Vertical at 3 m										
Frequency (MHz)	Emission Level (dBuV/m)	Read Level (dBuV)	Limit (dBuV/m)	Margin (dB)	Antenna Factor (dB/m)	Cable Loss (dB)	Preamp Factor (dB)	Antenna Height (cm)	Table Angle (Degree)	Remark
5127.05	51.99	51.66	74	-22.01	31.31	6.32	37.3	194	301	Peak
5132.3	39.64	39.31	54	-14.36	31.31	6.32	37.3	194	301	Average
5220	92.7	92.29			31.37	6.4	37.36	194	301	Average
5220	101.57	101.16			31.37	6.4	37.36	194	301	Peak
5409.62	51.08	50.26	74	-22.92	31.52	6.48	37.18	194	301	Peak
5426.56	39.2	38.31	54	-14.8	31.53	6.49	37.13	194	301	Average
*10440	63.71	66.69	68.2	-4.49	39.29	10.21	52.48	176	273	Peak

Remarks:

- Emission Level = Read Level + Antenna Factor + Cable Loss - Preamp Factor  
Margin value = Emission level – Limit value
- 5220 MHz: Fundamental Frequency
- \*: Out of Restricted Band

EUT Test Condition		Measurement Detail	
Channel	Channel 48	Frequency Range	1 GHz ~ 40 GHz
Input Power	120 Vac, 60 Hz	Detector Function	Peak (PK) Average (AV)
Environmental Conditions	25 deg. C, 65 % RH	Tested By	Gavin Wu

Antenna Polarity & Test Distance: Horizontal at 3 m										
Frequency (MHz)	Emission Level (dBuV/m)	Read Level (dBuV)	Limit (dBuV/m)	Margin (dB)	Antenna Factor (dB/m)	Cable Loss (dB)	Preamp Factor (dB)	Antenna Height (cm)	Table Angle (Degree)	Remark
5005.55	51.22	51.03	74	-22.78	31.21	6.21	37.23	194	259	Peak
5079.5	38.76	38.49	54	-15.24	31.27	6.27	37.27	194	259	Average
5240	89.15	88.66			31.39	6.42	37.32	194	259	Average
5240	98.43	97.94			31.39	6.42	37.32	194	259	Peak
5431.18	50.94	50.03	74	-23.06	31.55	6.49	37.13	194	259	Peak
5450.32	38.96	37.97	54	-15.04	31.56	6.51	37.08	194	259	Average
*10480	64.99	68.06	68.2	-3.21	39.37	10.22	52.66	162	234	Peak

Antenna Polarity & Test Distance: Vertical at 3 m										
Frequency (MHz)	Emission Level (dBuV/m)	Read Level (dBuV)	Limit (dBuV/m)	Margin (dB)	Antenna Factor (dB/m)	Cable Loss (dB)	Preamp Factor (dB)	Antenna Height (cm)	Table Angle (Degree)	Remark
5127.5	39.14	38.81	54	-14.86	31.31	6.32	37.3	206	297	Average
5142.35	50.81	50.46	74	-23.19	31.32	6.33	37.3	206	297	Peak
5240	91.98	91.49			31.39	6.42	37.32	206	297	Average
5240	101.15	100.66			31.39	6.42	37.32	206	297	Peak
5358.47	51.31	50.54	74	-22.69	31.48	6.47	37.18	206	297	Peak
5399.28	39.05	38.24	54	-14.95	31.52	6.47	37.18	206	297	Average
*10480	61.75	64.87	68.2	-6.45	39.37	10.22	52.71	182	114	Peak

Remarks:

- Emission Level = Read Level + Antenna Factor + Cable Loss - Preamp Factor  
Margin value = Emission level – Limit value
- 5240 MHz: Fundamental Frequency
- \*: Out of Restricted Band

EUT Test Condition		Measurement Detail	
Channel	Channel 149	Frequency Range	1 GHz ~ 40 GHz
Input Power	120 Vac, 60 Hz	Detector Function	Peak (PK) Average (AV)
Environmental Conditions	25 deg. C, 65 % RH	Tested By	Getaz Yang

<Spurious Emission>

Antenna Polarity & Test Distance: Horizontal at 3 m										
Frequency (MHz)	Emission Level (dBuV/m)	Read Level (dBuV)	Limit (dBuV/m)	Margin (dB)	Antenna Factor (dB/m)	Cable Loss (dB)	Preamp Factor (dB)	Antenna Height (cm)	Table Angle (Degree)	Remark
5745	98.48	97.18			31.99	6.78	37.47	209	301	Average
5745	106.93	105.63			31.99	6.78	37.47	209	301	Peak
11490	47.65	49.86	54	-6.35	39.91	10.66	52.78	145	58	Average
11490	57.86	60.07	74	-16.14	39.91	10.66	52.78	145	58	Peak
Antenna Polarity & Test Distance: Vertical at 3 m										
Frequency (MHz)	Emission Level (dBuV/m)	Read Level (dBuV)	Limit (dBuV/m)	Margin (dB)	Antenna Factor (dB/m)	Cable Loss (dB)	Preamp Factor (dB)	Antenna Height (cm)	Table Angle (Degree)	Remark
5745	100.96	99.66			31.99	6.78	37.47	200	296	Average
5745	109.07	107.77			31.99	6.78	37.47	200	296	Peak
11490	46.57	48.83	54	-7.43	39.91	10.66	52.83	112	94	Average
11490	55.12	57.38	74	-18.88	39.91	10.66	52.83	112	94	Peak

<Out of Band Emission (OOBE)>

Antenna Polarity & Test Distance: Horizontal at 3 m										
Frequency (MHz)	Emission Level (dBuV/m)	Read Level (dBuV)	Limit (dBuV/m)	Margin (dB)	Antenna Factor (dB/m)	Cable Loss (dB)	Preamp Factor (dB)	Antenna Height (cm)	Table Angle (Degree)	Remark
5617.45	51.79	50.53	68.2	-16.41	31.79	6.69	37.22	209	301	Peak
5652.125	53.73	52.45	69.78	-16.05	31.85	6.71	37.28	209	301	Peak
5922.875	50.67	49.02	69.77	-19.1	32.29	6.86	37.5	209	301	Peak
6021.2	51.82	49.97	68.2	-16.38	32.45	6.9	37.5	209	301	Peak
Antenna Polarity & Test Distance: Vertical at 3 m										
Frequency (MHz)	Emission Level (dBuV/m)	Read Level (dBuV)	Limit (dBuV/m)	Margin (dB)	Antenna Factor (dB/m)	Cable Loss (dB)	Preamp Factor (dB)	Antenna Height (cm)	Table Angle (Degree)	Remark
5626	54.26	53	68.2	-13.94	31.79	6.69	37.22	200	296	Peak
5652.6	53.06	51.78	70.13	-17.07	31.85	6.71	37.28	200	296	Peak
5921.45	51.93	50.31	70.82	-18.89	32.26	6.86	37.5	200	296	Peak
5933.8	52.07	50.42	68.2	-16.13	32.29	6.86	37.5	200	296	Peak

Remarks:

- Emission Level = Read Level + Antenna Factor + Cable Loss - Preamp Factor  
Margin value = Emission level – Limit value
- 5745 MHz: Fundamental Frequency

EUT Test Condition		Measurement Detail	
Channel	Channel 157	Frequency Range	1 GHz ~ 40 GHz
Input Power	120 Vac, 60 Hz	Detector Function	Peak (PK) Average (AV)
Environmental Conditions	25 deg. C, 65 % RH	Tested By	Getaz Yang

<Spurious Emission>

Antenna Polarity & Test Distance: Horizontal at 3 m										
Frequency (MHz)	Emission Level (dBuV/m)	Read Level (dBuV)	Limit (dBuV/m)	Margin (dB)	Antenna Factor (dB/m)	Cable Loss (dB)	Preamp Factor (dB)	Antenna Height (cm)	Table Angle (Degree)	Remark
5705.16	53.07	51.83	74	-20.93	31.93	6.74	37.43	205	304	Peak
5722.84	53.47	52.18	74	-20.53	31.96	6.76	37.43	205	304	Peak
5785	97.31	95.99			32.04	6.82	37.54	205	304	Average
5785	106.58	105.26			32.04	6.82	37.54	205	304	Peak
5857.6	53.41	51.89	74	-20.59	32.18	6.85	37.51	205	304	Peak
5861.68	52.67	51.14	74	-21.33	32.18	6.85	37.5	205	304	Peak
11570	47.39	49.86	54	-6.61	39.78	10.76	53.01	141	49	Average
11570	54.92	57.39	74	-19.08	39.78	10.76	53.01	141	49	Peak
Antenna Polarity & Test Distance: Vertical at 3 m										
Frequency (MHz)	Emission Level (dBuV/m)	Read Level (dBuV)	Limit (dBuV/m)	Margin (dB)	Antenna Factor (dB/m)	Cable Loss (dB)	Preamp Factor (dB)	Antenna Height (cm)	Table Angle (Degree)	Remark
5707.48	54.94	53.7	74	-19.06	31.93	6.74	37.43	199	297	Peak
5719.4	56.41	55.13	74	-17.59	31.96	6.75	37.43	199	297	Peak
5785	100.8	99.48			32.04	6.82	37.54	199	297	Average
5785	109.28	107.96			32.04	6.82	37.54	199	297	Peak
5850.56	53.99	52.5	74	-20.01	32.15	6.85	37.51	199	297	Peak
5868.16	54.1	52.57	74	-19.9	32.18	6.85	37.5	199	297	Peak
11570	46.76	49.55	54	-7.24	39.78	10.76	53.33	109	89	Average
11570	56.28	59.07	74	-17.72	39.78	10.76	53.33	109	89	Peak

<Out of Band Emission (OOBE)>

**Antenna Polarity & Test Distance: Horizontal at 3 m**

Frequency (MHz)	Emission Level (dBuV/m)	Read Level (dBuV)	Limit (dBuV/m)	Margin (dB)	Antenna Factor (dB/m)	Cable Loss (dB)	Preamp Factor (dB)	Antenna Height (cm)	Table Angle (Degree)	Remark
5631.225	52.24	51.03	68.2	-15.96	31.79	6.7	37.28	205	304	Peak
5654.025	49.23	48.01	71.19	-21.96	31.85	6.71	37.34	205	304	Peak
5922.875	52.13	50.48	69.77	-17.64	32.29	6.86	37.5	205	304	Peak
5936.65	52.11	50.46	68.2	-16.09	32.29	6.86	37.5	205	304	Peak

**Antenna Polarity & Test Distance: Vertical at 3 m**

Frequency (MHz)	Emission Level (dBuV/m)	Read Level (dBuV)	Limit (dBuV/m)	Margin (dB)	Antenna Factor (dB/m)	Cable Loss (dB)	Preamp Factor (dB)	Antenna Height (cm)	Table Angle (Degree)	Remark
5633.125	52.95	51.71	68.2	-15.25	31.82	6.7	37.28	199	297	Peak
5654.975	51.61	50.39	71.9	-20.29	31.85	6.71	37.34	199	297	Peak
5921.45	49.93	48.31	70.82	-20.89	32.26	6.86	37.5	199	297	Peak
5997.45	52.81	51.03	68.2	-15.39	32.4	6.89	37.51	199	297	Peak

Remarks:

1. Emission Level = Read Level + Antenna Factor + Cable Loss - Preamp Factor  
Margin value = Emission level – Limit value
2. 5785 MHz: Fundamental Frequency



EUT Test Condition		Measurement Detail	
Channel	Channel 165	Frequency Range	1 GHz ~ 40 GHz
Input Power	120 Vac, 60 Hz	Detector Function	Peak (PK) Average (AV)
Environmental Conditions	25 deg. C, 65 % RH	Tested By	Getaz Yang

**<Spurious Emission>**

Antenna Polarity & Test Distance: Horizontal at 3 m										
Frequency (MHz)	Emission Level (dBuV/m)	Read Level (dBuV)	Limit (dBuV/m)	Margin (dB)	Antenna Factor (dB/m)	Cable Loss (dB)	Preamp Factor (dB)	Antenna Height (cm)	Table Angle (Degree)	Remark
5710.12	51.93	50.69	74	-22.07	31.93	6.74	37.43	207	306	Peak
5717.08	52.82	51.57	74	-21.18	31.93	6.75	37.43	207	306	Peak
5825	97.26	95.83			32.12	6.84	37.53	207	306	Average
5825	106	104.57			32.12	6.84	37.53	207	306	Peak
5857.04	54.37	52.85	74	-19.63	32.18	6.85	37.51	207	306	Peak
5862.72	55.09	53.56	74	-18.91	32.18	6.85	37.5	207	306	Peak
11650	46.98	49.67	54	-7.02	39.65	10.8	53.14	141	48	Average
11650	54.33	57.02	74	-19.67	39.65	10.8	53.14	141	48	Peak

Antenna Polarity & Test Distance: Vertical at 3 m										
Frequency (MHz)	Emission Level (dBuV/m)	Read Level (dBuV)	Limit (dBuV/m)	Margin (dB)	Antenna Factor (dB/m)	Cable Loss (dB)	Preamp Factor (dB)	Antenna Height (cm)	Table Angle (Degree)	Remark
5707.08	54.36	53.12	74	-19.64	31.93	6.74	37.43	196	297	Peak
5722.04	54.02	52.74	74	-19.98	31.96	6.75	37.43	196	297	Peak
5825	100.79	99.36			32.12	6.84	37.53	196	297	Average
5825	109.68	108.25			32.12	6.84	37.53	196	297	Peak
5851.68	56.77	55.28	74	-17.23	32.15	6.85	37.51	196	297	Peak
5866.24	55.9	54.37	74	-18.1	32.18	6.85	37.5	196	297	Peak
11650	46.61	49.51	54	-7.39	39.65	10.8	53.35	109	94	Average
11650	54.12	57.02	74	-19.88	39.65	10.8	53.35	109	94	Peak

<Out of Band Emission (OOBE)>

**Antenna Polarity & Test Distance: Horizontal at 3 m**

Frequency (MHz)	Emission Level (dBuV/m)	Read Level (dBuV)	Limit (dBuV/m)	Margin (dB)	Antenna Factor (dB/m)	Cable Loss (dB)	Preamp Factor (dB)	Antenna Height (cm)	Table Angle (Degree)	Remark
5643.1	52	50.76	68.2	-16.2	31.82	6.7	37.28	207	306	Peak
5654.5	50.17	48.95	71.54	-21.37	31.85	6.71	37.34	207	306	Peak
5923.35	49.85	48.2	69.42	-19.57	32.29	6.86	37.5	207	306	Peak
5928.1	52.62	50.97	68.2	-15.58	32.29	6.86	37.5	207	306	Peak

**Antenna Polarity & Test Distance: Vertical at 3 m**

Frequency (MHz)	Emission Level (dBuV/m)	Read Level (dBuV)	Limit (dBuV/m)	Margin (dB)	Antenna Factor (dB/m)	Cable Loss (dB)	Preamp Factor (dB)	Antenna Height (cm)	Table Angle (Degree)	Remark
5649.275	54.28	53.04	68.2	-13.92	31.82	6.7	37.28	196	297	Peak
5653.075	52.06	50.78	70.49	-18.43	31.85	6.71	37.28	196	297	Peak
5922.4	50.96	49.31	70.12	-19.16	32.29	6.86	37.5	196	297	Peak
5939.5	53.33	51.64	68.2	-14.87	32.32	6.87	37.5	196	297	Peak

Remarks:

1. Emission Level = Read Level + Antenna Factor + Cable Loss - Preamp Factor  
Margin value = Emission level – Limit value
2. 5825 MHz: Fundamental Frequency

**802.11n (HT40)**

EUT Test Condition		Measurement Detail	
Channel	Channel 38	Frequency Range	1 GHz ~ 40 GHz
Input Power	120 Vac, 60 Hz	Detector Function	Peak (PK) Average (AV)
Environmental Conditions	25 deg. C, 65 % RH	Tested By	Gavin Wu

**Antenna Polarity & Test Distance: Horizontal at 3 m**

Frequency (MHz)	Emission Level (dBuV/m)	Read Level (dBuV)	Limit (dBuV/m)	Margin (dB)	Antenna Factor (dB/m)	Cable Loss (dB)	Preamp Factor (dB)	Antenna Height (cm)	Table Angle (Degree)	Remark
5141.3	58.54	58.19	74	-15.46	31.32	6.33	37.3	191	351	Peak
5150	41.24	40.9	54	-12.76	31.32	6.34	37.32	191	351	Average
5190	86.98	86.59			31.35	6.38	37.34	191	351	Average
5190	96.64	96.25			31.35	6.38	37.34	191	351	Peak
*10380	59	62.03	68.2	-9.2	39.21	10.21	52.45	112	213	Peak

**Antenna Polarity & Test Distance: Vertical at 3 m**

Frequency (MHz)	Emission Level (dBuV/m)	Read Level (dBuV)	Limit (dBuV/m)	Margin (dB)	Antenna Factor (dB/m)	Cable Loss (dB)	Preamp Factor (dB)	Antenna Height (cm)	Table Angle (Degree)	Remark
5120	58.26	57.96	74	-15.74	31.29	6.31	37.3	196	296	Peak
5150	42.37	42.03	54	-11.63	31.32	6.34	37.32	196	296	Average
5190	89.04	88.65			31.35	6.38	37.34	196	296	Average
5190	98.68	98.29			31.35	6.38	37.34	196	296	Peak
*10380	58.98	61.81	68.2	-9.22	39.21	10.21	52.25	124	177	Peak

## Remarks:

- Emission Level = Read Level + Antenna Factor + Cable Loss - Preamp Factor  
Margin value = Emission level – Limit value
- 5190 MHz: Fundamental Frequency
- \*: Out of Restricted Band

EUT Test Condition		Measurement Detail	
Channel	Channel 46	Frequency Range	1 GHz ~ 40 GHz
Input Power	120 Vac, 60 Hz	Detector Function	Peak (PK) Average (AV)
Environmental Conditions	25 deg. C, 65 % RH	Tested By	Gavin Wu

Antenna Polarity & Test Distance: Horizontal at 3 m										
Frequency (MHz)	Emission Level (dBuV/m)	Read Level (dBuV)	Limit (dBuV/m)	Margin (dB)	Antenna Factor (dB/m)	Cable Loss (dB)	Preamp Factor (dB)	Antenna Height (cm)	Table Angle (Degree)	Remark
5141.9	39.22	38.87	54	-14.78	31.32	6.33	37.3	212	296	Average
5144.3	51.64	51.31	74	-22.36	31.32	6.33	37.32	212	296	Peak
5230	88.17	87.69			31.39	6.41	37.32	212	296	Average
5230	97.36	96.88			31.39	6.41	37.32	212	296	Peak
5374.42	51.57	50.79	74	-22.43	31.49	6.47	37.18	212	296	Peak
5420.62	39.13	38.3	54	-14.87	31.53	6.48	37.18	212	296	Average
*10460	58.1	61.12	68.2	-10.1	39.35	10.22	52.59	115	268	Peak
Antenna Polarity & Test Distance: Vertical at 3 m										
Frequency (MHz)	Emission Level (dBuV/m)	Read Level (dBuV)	Limit (dBuV/m)	Margin (dB)	Antenna Factor (dB/m)	Cable Loss (dB)	Preamp Factor (dB)	Antenna Height (cm)	Table Angle (Degree)	Remark
5141.9	39.76	39.41	54	-14.24	31.32	6.33	37.3	197	298	Average
5145.35	55.35	55.01	74	-18.65	31.32	6.34	37.32	197	298	Peak
5230	89.58	89.1			31.39	6.41	37.32	197	298	Average
5230	98.03	97.55			31.39	6.41	37.32	197	298	Peak
5434.48	51.06	50.15	74	-22.94	31.55	6.49	37.13	197	298	Peak
5449.55	39	38.07	54	-15	31.56	6.5	37.13	197	298	Average
*10460	57.3	60.33	68.2	-10.9	39.35	10.22	52.6	122	174	Peak

Remarks:

- Emission Level = Read Level + Antenna Factor + Cable Loss - Preamp Factor  
Margin value = Emission level – Limit value
- 5230 MHz: Fundamental Frequency
- \*: Out of Restricted Band

EUT Test Condition		Measurement Detail	
Channel	Channel 151	Frequency Range	1 GHz ~ 40 GHz
Input Power	120 Vac, 60 Hz	Detector Function	Peak (PK) Average (AV)
Environmental Conditions	25 deg. C, 65 % RH	Tested By	Getaz Yang

**<Spurious Emission>**

Antenna Polarity & Test Distance: Horizontal at 3 m										
Frequency (MHz)	Emission Level (dBuV/m)	Read Level (dBuV)	Limit (dBuV/m)	Margin (dB)	Antenna Factor (dB/m)	Cable Loss (dB)	Preamp Factor (dB)	Antenna Height (cm)	Table Angle (Degree)	Remark
5707	62.69	61.45	74	-11.31	31.93	6.74	37.43	206	303	Peak
5721.48	65.8	64.52	74	-8.2	31.96	6.75	37.43	206	303	Peak
5755	95.31	93.98			32.01	6.79	37.47	206	303	Average
5755	103.82	102.49			32.01	6.79	37.47	206	303	Peak
5850.48	55.3	53.81	74	-18.7	32.15	6.85	37.51	206	303	Peak
5865.68	56.22	54.69	74	-17.78	32.18	6.85	37.5	206	303	Peak
Antenna Polarity & Test Distance: Vertical at 3 m										
Frequency (MHz)	Emission Level (dBuV/m)	Read Level (dBuV)	Limit (dBuV/m)	Margin (dB)	Antenna Factor (dB/m)	Cable Loss (dB)	Preamp Factor (dB)	Antenna Height (cm)	Table Angle (Degree)	Remark
5708.44	67.07	65.83	74	-6.93	31.93	6.74	37.43	194	296	Peak
5721.72	69.43	68.15	74	-4.57	31.96	6.75	37.43	194	296	Peak
5755	99.02	97.69			32.01	6.79	37.47	194	296	Average
5755	107.32	105.99			32.01	6.79	37.47	194	296	Peak
5850.48	54.37	52.88	74	-19.63	32.15	6.85	37.51	194	296	Peak
5866.8	60.75	59.22	74	-13.25	32.18	6.85	37.5	194	296	Peak
11510	47.16	49.64	54	-6.84	39.9	10.69	53.07	135	57	Average
11510	54.78	57.26	74	-19.22	39.9	10.69	53.07	135	57	Peak

<Out of Band Emission (OOBE)>

**Antenna Polarity & Test Distance: Horizontal at 3 m**

Frequency (MHz)	Emission Level (dBuV/m)	Read Level (dBuV)	Limit (dBuV/m)	Margin (dB)	Antenna Factor (dB/m)	Cable Loss (dB)	Preamp Factor (dB)	Antenna Height (cm)	Table Angle (Degree)	Remark
5645.475	52.51	51.27	68.2	-15.69	31.82	6.7	37.28	206	303	Peak
5653.075	52	50.72	70.49	-18.49	31.85	6.71	37.28	206	303	Peak
5920.025	51.87	50.25	71.87	-20	32.26	6.86	37.5	206	303	Peak
5963.725	52.24	50.53	68.2	-15.96	32.34	6.88	37.51	206	303	Peak

**Antenna Polarity & Test Distance: Vertical at 3 m**

Frequency (MHz)	Emission Level (dBuV/m)	Read Level (dBuV)	Limit (dBuV/m)	Margin (dB)	Antenna Factor (dB/m)	Cable Loss (dB)	Preamp Factor (dB)	Antenna Height (cm)	Table Angle (Degree)	Remark
5620.3	53.45	52.19	68.2	-14.75	31.79	6.69	37.22	194	296	Peak
5650.225	61.86	60.58	68.37	-6.51	31.85	6.71	37.28	194	296	Peak
5922.875	50.21	48.56	69.77	-19.56	32.29	6.86	37.5	194	296	Peak
6006	52.32	50.54	68.2	-15.88	32.4	6.89	37.51	194	296	Peak

Remarks:

1. Emission Level = Read Level + Antenna Factor + Cable Loss - Preamp Factor  
Margin value = Emission level – Limit value
2. 5755 MHz: Fundamental Frequency

EUT Test Condition		Measurement Detail	
Channel	Channel 159	Frequency Range	1 GHz ~ 40 GHz
Input Power	120 Vac, 60 Hz	Detector Function	Peak (PK) Average (AV)
Environmental Conditions	25 deg. C, 65 % RH	Tested By	Getaz Yang

<Spurious Emission>

Antenna Polarity & Test Distance: Horizontal at 3 m										
Frequency (MHz)	Emission Level (dBuV/m)	Read Level (dBuV)	Limit (dBuV/m)	Margin (dB)	Antenna Factor (dB/m)	Cable Loss (dB)	Preamp Factor (dB)	Antenna Height (cm)	Table Angle (Degree)	Remark
5710.6	57.93	56.69	74	-16.07	31.93	6.74	37.43	208	305	Peak
5721.16	58.31	57.03	74	-15.69	31.96	6.75	37.43	208	305	Peak
5795	94.16	92.8			32.07	6.83	37.54	208	305	Average
5795	103.21	101.85			32.07	6.83	37.54	208	305	Peak
5854.48	60.86	59.34	74	-13.14	32.18	6.85	37.51	208	305	Peak
5863.76	58.53	57	74	-15.47	32.18	6.85	37.5	208	305	Peak
11590	46.92	49.41	54	-7.08	39.74	10.78	53.01	141	58	Average
11590	54.89	57.38	74	-19.11	39.74	10.78	53.01	141	58	Peak
Antenna Polarity & Test Distance: Vertical at 3 m										
Frequency (MHz)	Emission Level (dBuV/m)	Read Level (dBuV)	Limit (dBuV/m)	Margin (dB)	Antenna Factor (dB/m)	Cable Loss (dB)	Preamp Factor (dB)	Antenna Height (cm)	Table Angle (Degree)	Remark
5709.4	62.65	61.41	74	-11.35	31.93	6.74	37.43	194	296	Peak
5721.56	62.48	61.2	74	-11.52	31.96	6.75	37.43	194	296	Peak
5795	98.43	97.07			32.07	6.83	37.54	194	296	Average
5795	107	105.64			32.07	6.83	37.54	194	296	Peak
5852.72	62.99	61.5	74	-11.01	32.15	6.85	37.51	194	296	Peak
5868.4	56.38	54.85	74	-17.62	32.18	6.85	37.5	194	296	Peak
11590	46.35	49.16	54	-7.65	39.74	10.78	53.33	111	92	Average
11590	54.23	57.04	74	-19.77	39.74	10.78	53.33	111	92	Peak

<Out of Band Emission (OOBE)>

**Antenna Polarity & Test Distance: Horizontal at 3 m**

Frequency (MHz)	Emission Level (dBuV/m)	Read Level (dBuV)	Limit (dBuV/m)	Margin (dB)	Antenna Factor (dB/m)	Cable Loss (dB)	Preamp Factor (dB)	Antenna Height (cm)	Table Angle (Degree)	Remark
5625.525	52.73	51.47	68.2	-15.47	31.79	6.69	37.22	208	305	Peak
5653.55	50.31	49.03	70.84	-20.53	31.85	6.71	37.28	208	305	Peak
5923.35	48.92	47.27	69.42	-20.5	32.29	6.86	37.5	208	305	Peak
5970.85	52.33	50.62	68.2	-15.87	32.34	6.88	37.51	208	305	Peak

**Antenna Polarity & Test Distance: Vertical at 3 m**

Frequency (MHz)	Emission Level (dBuV/m)	Read Level (dBuV)	Limit (dBuV/m)	Margin (dB)	Antenna Factor (dB/m)	Cable Loss (dB)	Preamp Factor (dB)	Antenna Height (cm)	Table Angle (Degree)	Remark
5643.1	53.48	52.24	68.2	-14.72	31.82	6.7	37.28	194	296	Peak
5653.075	52.05	50.77	70.49	-18.44	31.85	6.71	37.28	194	296	Peak
5921.45	56.87	55.25	70.82	-13.95	32.26	6.86	37.5	194	296	Peak
5944.725	52.44	50.75	68.2	-15.76	32.32	6.87	37.5	194	296	Peak

Remarks:

1. Emission Level = Read Level + Antenna Factor + Cable Loss - Preamp Factor  
Margin value = Emission level – Limit value
2. 5795 MHz: Fundamental Frequency



**802.11ac (VHT80)**

EUT Test Condition		Measurement Detail	
Channel	Channel 42	Frequency Range	1 GHz ~ 40 GHz
Input Power	120 Vac, 60 Hz	Detector Function	Peak (PK) Average (AV)
Environmental Conditions	25 deg. C, 65 % RH	Tested By	Gavin Wu

**Antenna Polarity & Test Distance: Horizontal at 3 m**

Frequency (MHz)	Emission Level (dBuV/m)	Read Level (dBuV)	Limit (dBuV/m)	Margin (dB)	Antenna Factor (dB/m)	Cable Loss (dB)	Preamp Factor (dB)	Antenna Height (cm)	Table Angle (Degree)	Remark
5131.1	56.34	56.01	74	-17.66	31.31	6.32	37.3	209	296	Peak
5147.45	44.63	44.29	54	-9.37	31.32	6.34	37.32	209	296	Average
5210	84.01	83.6			31.37	6.4	37.36	209	296	Average
5210	95.32	94.91			31.37	6.4	37.36	209	296	Peak
5355.17	40.63	39.86	54	-13.37	31.48	6.47	37.18	209	296	Average
5356.16	52.73	51.96	74	-21.27	31.48	6.47	37.18	209	296	Peak
*10420	61.37	64.34	68.2	-6.83	39.27	10.21	52.45	107	69	Peak

**Antenna Polarity & Test Distance: Vertical at 3 m**

Frequency (MHz)	Emission Level (dBuV/m)	Read Level (dBuV)	Limit (dBuV/m)	Margin (dB)	Antenna Factor (dB/m)	Cable Loss (dB)	Preamp Factor (dB)	Antenna Height (cm)	Table Angle (Degree)	Remark
5142.05	46.09	45.74	54	-7.91	31.32	6.33	37.3	193	301	Average
5149.25	57.63	57.29	74	-16.37	31.32	6.34	37.32	193	301	Peak
5210	85.94	85.53			31.37	6.4	37.36	193	301	Average
5210	97.07	96.66			31.37	6.4	37.36	193	301	Peak
5351.21	40.73	39.96	54	-13.27	31.48	6.47	37.18	193	301	Average
5399.17	53.02	52.21	74	-20.98	31.52	6.47	37.18	193	301	Peak
*10420	60.63	63.51	68.2	-7.57	39.27	10.21	52.36	172	167	Peak

## Remarks:

- Emission Level = Read Level + Antenna Factor + Cable Loss - Preamp Factor  
Margin value = Emission level – Limit value
- 5210 MHz: Fundamental Frequency
- \*: Out of Restricted Band

EUT Test Condition		Measurement Detail	
Channel	Channel 155	Frequency Range	1 GHz ~ 40 GHz
Input Power	120 Vac, 60 Hz	Detector Function	Peak (PK) Average (AV)
Environmental Conditions	25 deg. C, 65 % RH	Tested By	Getaz Yang

**<Spurious Emission>**

Antenna Polarity & Test Distance: Horizontal at 3 m										
Frequency (MHz)	Emission Level (dBuV/m)	Read Level (dBuV)	Limit (dBuV/m)	Margin (dB)	Antenna Factor (dB/m)	Cable Loss (dB)	Preamp Factor (dB)	Antenna Height (cm)	Table Angle (Degree)	Remark
5775	94.73	93.38			32.04	6.81	37.5	208	306	Average
5775	104.57	103.22			32.04	6.81	37.5	208	306	Peak
11550	47.01	49.4	54	-6.99	39.81	10.74	52.94	138	56	Average
11550	58.04	60.43	74	-15.96	39.81	10.74	52.94	138	56	Peak
Antenna Polarity & Test Distance: Vertical at 3 m										
Frequency (MHz)	Emission Level (dBuV/m)	Read Level (dBuV)	Limit (dBuV/m)	Margin (dB)	Antenna Factor (dB/m)	Cable Loss (dB)	Preamp Factor (dB)	Antenna Height (cm)	Table Angle (Degree)	Remark
5775	97.85	96.5			32.04	6.81	37.5	196	298	Average
5775	107.22	105.87			32.04	6.81	37.5	196	298	Peak
11550	46.81	49.5	54	-7.19	39.81	10.74	53.24	110	91	Average
11550	57.31	60	74	-16.69	39.81	10.74	53.24	110	91	Peak

**<Out of Band Emission (OOBE)>**

Antenna Polarity & Test Distance: Horizontal at 3 m										
Frequency (MHz)	Emission Level (dBuV/m)	Read Level (dBuV)	Limit (dBuV/m)	Margin (dB)	Antenna Factor (dB/m)	Cable Loss (dB)	Preamp Factor (dB)	Antenna Height (cm)	Table Angle (Degree)	Remark
5635.975	55.97	54.73	68.2	-12.23	31.82	6.7	37.28	208	306	Peak
5653.55	55.08	53.8	70.84	-15.76	31.85	6.71	37.28	208	306	Peak
5923.35	49.94	48.29	69.42	-19.48	32.29	6.86	37.5	208	306	Peak
5932.375	52.43	50.78	68.2	-15.77	32.29	6.86	37.5	208	306	Peak
Antenna Polarity & Test Distance: Vertical at 3 m										
Frequency (MHz)	Emission Level (dBuV/m)	Read Level (dBuV)	Limit (dBuV/m)	Margin (dB)	Antenna Factor (dB/m)	Cable Loss (dB)	Preamp Factor (dB)	Antenna Height (cm)	Table Angle (Degree)	Remark
5647.85	58.58	57.34	68.2	-9.62	31.82	6.7	37.28	196	298	Peak
5653.075	58.78	57.5	70.49	-11.71	31.85	6.71	37.28	196	298	Peak
5923.35	53.67	52.02	69.42	-15.75	32.29	6.86	37.5	196	298	Peak
5936.65	53.98	52.33	68.2	-14.22	32.29	6.86	37.5	196	298	Peak

Remarks:

- Emission Level = Read Level + Antenna Factor + Cable Loss - Preamp Factor  
Margin value = Emission level – Limit value
- 5775 MHz: Fundamental Frequency

### 9 kHz ~ 30 MHz DATA:

The amplitude of spurious emissions attenuated more than 20 dB below the permissible value is not required to be report.

### 30 MHz ~ 1 GHz WORST-CASE DATA:

#### 802.11n (HT20)

EUT Test Condition		Measurement Detail	
Channel	Channel 36	Frequency Range	30 MHz ~ 1 GHz
Input Power	120 Vac, 60 Hz	Detector Function	Peak (PK) Quasi-peak (QP)
Environmental Conditions	25 deg. C, 65 % RH	Tested By	Gavin Wu

#### Antenna Polarity & Test Distance: Horizontal at 3 m

Frequency (MHz)	Emission Level (dBuV/m)	Read Level (dBuV)	Limit (dBuV/m)	Margin (dB)	Antenna Factor (dB/m)	Cable Loss (dB)	Preamp Factor (dB)	Antenna Height (cm)	Table Angle (Degree)	Remark
129.91	23.21	42.27	43.5	-20.29	11.68	1.14	31.88	129	263	Peak
217.21	26.38	46.6	46	-19.62	10.09	1.36	31.67	128	6	Peak
532.46	21.08	32.57	46	-24.92	18.06	2.15	31.7	114	216	Peak
632.37	23.09	32.9	46	-22.91	20	2.32	32.13	124	193	Peak
674.08	24.21	33.12	46	-21.79	20.5	2.41	31.82	102	323	Peak
701.24	23.62	32.12	46	-22.38	20.83	2.45	31.78	120	113	Peak

#### Antenna Polarity & Test Distance: Vertical at 3 m

Frequency (MHz)	Emission Level (dBuV/m)	Read Level (dBuV)	Limit (dBuV/m)	Margin (dB)	Antenna Factor (dB/m)	Cable Loss (dB)	Preamp Factor (dB)	Antenna Height (cm)	Table Angle (Degree)	Remark
38.73	31.41	48.39	40	-8.59	13.39	0.63	31	128	352	Peak
56.19	24.77	43	40	-15.23	12.35	0.76	31.34	127	84	Peak
122.15	26.44	46.04	43.5	-17.06	11.15	1.15	31.9	114	6	Peak
411.21	18.77	33.28	46	-27.23	15.56	1.93	32	100	307	Peak
580.96	22.11	32.84	46	-23.89	19.17	2.22	32.12	137	54	Peak
687.66	23.66	32.4	46	-22.34	20.67	2.43	31.84	124	273	Peak

Remarks:

1. Emission Level = Read Level + Antenna Factor + Cable Loss - Preamp Factor

Margin value = Emission level – Limit value

**802.11n (HT40)**

EUT Test Condition		Measurement Detail	
Channel	Channel 151	Frequency Range	30 MHz ~ 1 GHz
Input Power	120 Vac, 60 Hz	Detector Function	Peak (PK) Quasi-peak (QP)
Environmental Conditions	25 deg. C, 65 % RH	Tested By	Gavin Wu

**Antenna Polarity & Test Distance: Horizontal at 3 m**

Frequency (MHz)	Emission Level (dBuV/m)	Read Level (dBuV)	Limit (dBuV/m)	Margin (dB)	Antenna Factor (dB/m)	Cable Loss (dB)	Preamp Factor (dB)	Antenna Height (cm)	Table Angle (Degree)	Remark
129.91	21.05	40.11	43.5	-22.45	11.68	1.14	31.88	121	316	Peak
209.45	28.01	48.52	43.5	-15.49	9.77	1.33	31.61	107	269	Peak
218.18	26.14	46.33	46	-19.86	10.13	1.37	31.69	129	182	Peak
648.86	22.5	31.98	46	-23.5	20.2	2.35	32.03	116	279	Peak
676.99	23.38	32.26	46	-22.62	20.54	2.41	31.83	105	209	Peak
697.36	23.65	32.22	46	-22.35	20.78	2.45	31.8	113	31	Peak

**Antenna Polarity & Test Distance: Vertical at 3 m**

Frequency (MHz)	Emission Level (dBuV/m)	Read Level (dBuV)	Limit (dBuV/m)	Margin (dB)	Antenna Factor (dB/m)	Cable Loss (dB)	Preamp Factor (dB)	Antenna Height (cm)	Table Angle (Degree)	Remark
38.73	31.32	48.3	40	-8.68	13.39	0.63	31	102	292	Peak
126.03	24.34	43.67	43.5	-19.16	11.42	1.14	31.89	130	237	Peak
486.87	21.6	34.27	46	-24.4	17.06	2.06	31.79	136	270	Peak
606.18	21.64	31.84	46	-24.36	19.68	2.27	32.15	108	308	Peak
655.65	24.21	33.54	46	-21.79	20.28	2.37	31.98	139	293	Peak
692.51	23.89	32.55	46	-22.11	20.73	2.44	31.83	108	193	Peak

Remarks:

- Emission Level = Read Level + Antenna Factor + Cable Loss - Preamp Factor  
Margin value = Emission level – Limit value

## 4.2 Conducted Emission Measurement

### 4.2.1 Limits of Conducted Emission Measurement

Frequency (MHz)	Conducted Limit (dBuV)	
	Quasi-peak	Average
0.15 - 0.5	66 - 56	56 - 46
0.50 - 5.0	56	46
5.0 - 30.0	60	50

Note: 1. The lower limit shall apply at the transition frequencies.

2. The limit decreases in line with the logarithm of the frequency in the range of 0.15 to 0.50 MHz.

### 4.2.2 Test Instruments

Description & Manufacturer	Model No.	Serial No.	Date Of Calibration	Due Date Of Calibration
Test Receiver ROHDE & SCHWARZ	ESCI	100613	Nov. 21, 2016	Nov. 20, 2017
RF signal cable (with 10dB PAD) Woken	5D-FB	Cable-cond1-01	Dec. 22, 2016	Dec. 21, 2017
LISN ROHDE & SCHWARZ (EUT)	ESH3-Z5	835239/001	Mar. 10, 2017	Mar. 09, 2018
LISN ROHDE & SCHWARZ (Peripheral)	ESH3-Z5	100311	Jul. 28, 2016	Jul. 27, 2017
Software ADT	BV ADT_Cond_ V7.3.7.3	NA	NA	NA

- Note:**
1. The calibration interval of the above test instruments is 12 months and the calibrations are traceable to NML/ROC and NIST/USA.
  2. The test was performed in HwaYa Shielded Room 1.
  3. The VCCI Site Registration No. is C-2040.

#### 4.2.3 Test Procedures

- a. The EUT was placed 0.4 meters from the conducting wall of the shielded room with EUT being connected to the power mains through a line impedance stabilization network (LISN). Other support units were connected to the power mains through another LISN. The two LISNs provide 50 ohm/ 50uH of coupling impedance for the measuring instrument.
- b. Both lines of the power mains connected to the EUT were checked for maximum conducted interference.
- c. The frequency range from 150 kHz to 30 MHz was searched. Emission levels under (Limit -20 dB) was not recorded.

**Note:** All modes of operation were investigated and the worst-case emissions are reported.

#### 4.2.4 Deviation from Test Standard

No deviation.

#### 4.2.5 Test Setup

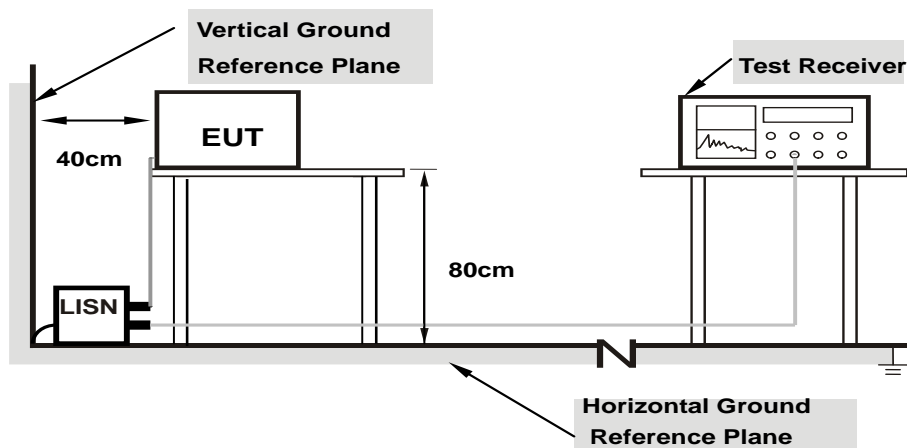

- Note:**
- 1.Support units were connected to second LISN.
  - 2.Both of LISNs (AMN) are 80 cm from EUT and at least 80 from other units and other metal planes

For the actual test configuration, please refer to the attached file (Test Setup Photo).

#### 4.2.6 EUT Operating Conditions

- a. Placed the EUT on a testing table.
- b. Use the software to control the EUT under transmission condition continuously at specific channel frequency.

#### 4.2.7 Test Results

Frequency Range	150kHz ~ 30MHz	Detector Function & Resolution Bandwidth	Quasi-Peak (QP) / Average (AV), 9kHz
Input Power	120Vac, 60Hz	Environmental Conditions	25°C, 65%RH
Tested by	Getaz Yang	Test Date	2017/7/27

Phase Of Power : Line (L)										
No	Frequency (MHz)	Correction Factor (dB)	Reading Value (dBuV)		Emission Level (dBuV)		Limit (dBuV)		Margin (dB)	
			Q.P.	AV.	Q.P.	AV.	Q.P.	AV.	Q.P.	AV.
1	0.16745	10.35	22.21	13.42	32.56	23.77	65.09	55.09	-32.53	-31.32
2	0.24384	10.38	16.17	4.24	26.55	14.62	61.96	51.96	-35.41	-37.34
3	0.34941	10.39	18.32	9.77	28.71	20.16	58.98	48.98	-30.27	-28.82
<b>4</b>	<b>0.57620</b>	<b>10.40</b>	<b>23.80</b>	<b>18.72</b>	<b>34.20</b>	<b>29.12</b>	<b>56.00</b>	<b>46.00</b>	<b>-21.80</b>	<b>-16.88</b>
5	1.72573	10.44	13.62	4.65	24.06	15.09	56.00	46.00	-31.94	-30.91
6	5.10006	10.62	19.23	8.56	29.85	19.18	60.00	50.00	-30.15	-30.82

Remarks:

1. Q.P. and AV. are abbreviations of quasi-peak and average individually.
2. The emission levels of other frequencies were very low against the limit.
3. Margin value = Emission level – Limit value
4. Correction factor = Insertion loss + Cable loss
5. Emission Level = Correction Factor + Reading Value

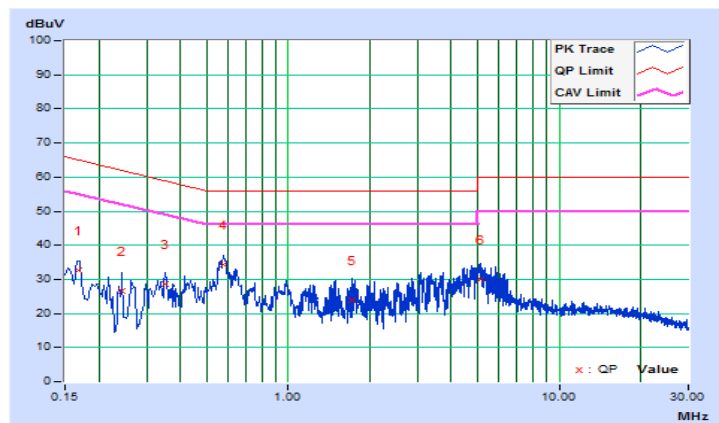

Frequency Range	150kHz ~ 30MHz	Detector Function & Resolution Bandwidth	Quasi-Peak (QP) / Average (AV), 9kHz
Input Power	120Vac, 60Hz	Environmental Conditions	25°C, 65%RH
Tested by	Getaz Yang	Test Date	2017/7/27

Phase Of Power : Neutral (N)										
No	Frequency (MHz)	Correction Factor (dB)	Reading Value (dBuV)		Emission Level (dBuV)		Limit (dBuV)		Margin (dB)	
			Q.P.	AV.	Q.P.	AV.	Q.P.	AV.	Q.P.	AV.
1	0.16569	10.12	24.58	17.44	34.70	27.56	65.17	55.17	-30.47	-27.61
2	0.21256	10.14	22.27	14.18	32.41	24.32	63.10	53.10	-30.69	-28.78
3	0.33377	10.15	19.11	10.62	29.26	20.77	59.36	49.36	-30.10	-28.59
4	0.56866	10.16	22.83	16.25	32.99	26.41	56.00	46.00	-23.01	-19.59
5	1.51068	10.20	19.27	10.84	29.47	21.04	56.00	46.00	-26.53	-24.96
6	3.34056	10.30	18.01	9.71	28.31	20.01	56.00	46.00	-27.69	-25.99

Remarks:

1. Q.P. and AV. are abbreviations of quasi-peak and average individually.
2. The emission levels of other frequencies were very low against the limit.
3. Margin value = Emission level – Limit value
4. Correction factor = Insertion loss + Cable loss
5. Emission Level = Correction Factor + Reading Value

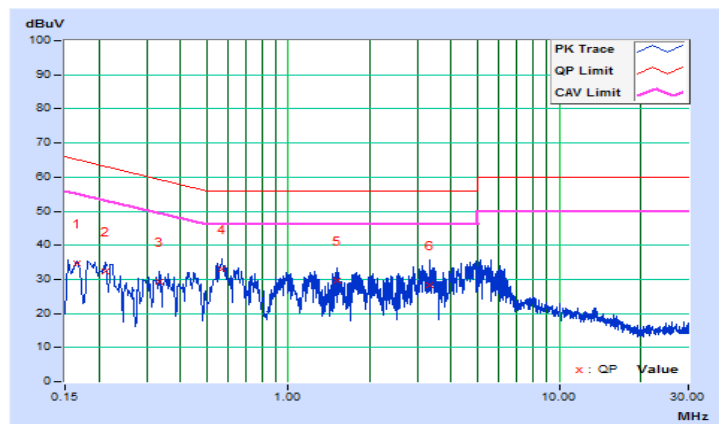



### 4.3 Transmit Power Measurement

#### 4.3.1 Limits of Transmit Power Measurement

Operation Band	EUT Category		Limit
U-NII-1		Outdoor Access Point	1 Watt (30 dBm) (Max. e.i.r.p $\leq$ 125 mW (21 dBm) at any elevation angle above 30 degrees as measured from the horizon)
		Fixed point-to-point Access Point	1 Watt (30 dBm)
	√	Indoor Access Point	1 Watt (30 dBm)
		Mobile and Portable client device	250 mW (24 dBm)
U-NII-2A			250 mW (24 dBm) or 11 dBm+10 log B*
U-NII-2C			250 mW (24 dBm) or 11 dBm+10 log B*
U-NII-3	√		1 Watt (30 dBm)

\*B is the 26 dB emission bandwidth in megahertz

Per KDB 662911 Method of conducted output power measurement on IEEE 802.11 devices,

Array Gain = 0 dB (i.e., no array gain) for  $N_{ANT} \leq 4$ ;

Array Gain = 0 dB (i.e., no array gain) for channel widths  $\geq 40$  MHz for any  $N_{ANT}$ ;

Array Gain =  $5 \log(N_{ANT}/N_{SS})$  dB or 3 dB, whichever is less for 20 MHz channel widths with  $N_{ANT} \geq 5$ .

For power measurements on all other devices: Array Gain =  $10 \log(N_{ANT}/N_{SS})$  dB.

#### 4.3.2 Test Setup

##### <Power Output Measurement>

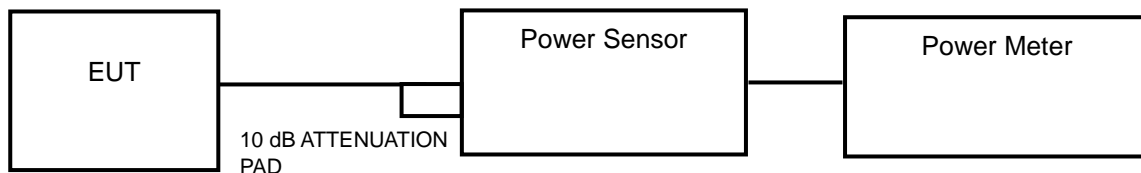

or

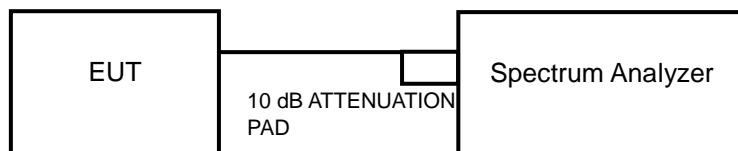

##### <26 dB Bandwidth>

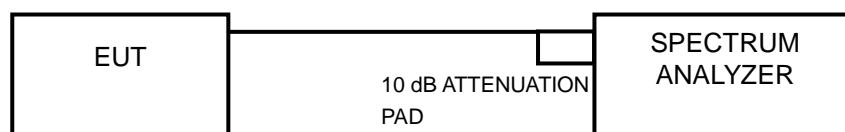

#### 4.3.3 Test Instruments

Refer to section 4.1.2 to get information of above instrument.

#### 4.3.4 Test Procedure

##### **Average Power Measurement**

<802.11a, 802.11n (HT20), 802.11n (HT40)>

Method PM is used to perform output power measurement, trigger and gating function of wide band power meter is enabled to measure max output power of TX on burst. Duty factor is not added to measured value.

<802.11ac (VHT80)>

Method SA-1 is used to perform output power measurement, trigger and gating function of spectrum analyzer is enabled to measure max output power of TX on burst. Duty factor is not added to measured value.

##### **26 dB Bandwidth**

- 1) Set RBW = approximately 1 % of the emission bandwidth.
- 2) Set the VBW > RBW.
- 3) Detector = Peak.
- 4) Trace mode = max hold.
- 5) Measure the maximum width of the emission that is 26 dB down from the peak of the emission. Compare this with the RBW setting of the analyzer. Readjust RBW and repeat measurement as needed until the RBW/EBW ratio is approximately 1 %.

#### 4.3.5 Deviation from Test Standard

No deviation.

#### 4.3.6 EUT Operating Conditions

The software provided by client to enable the EUT under transmission condition continuously at lowest, middle and highest channel frequencies individually.

4.3.7 Test Result

**Power Output:**

**802.11n (HT20)**

Channel	Frequency (MHz)	Maximum Conducted Power (dBm)		Total Power (mW)	Total Power (dBm)	Power Limit (dBm)	Pass / Fail
		Chain 0	Chain 1				
36	5180	7.74	8.66	13.288	11.23	30	Pass
44	5220	7.87	8.51	13.22	11.21	30	Pass
48	5240	7.78	8.64	13.309	11.24	30	Pass
149	5745	7.57	8.68	13.094	11.17	30	Pass
157	5785	7.45	8.56	12.737	11.05	30	Pass
165	5825	7.48	8.51	12.694	11.04	30	Pass

**802.11n (HT40)**

Channel	Frequency (MHz)	Maximum Conducted Power (dBm)		Total Power (mW)	Total Power (dBm)	Power Limit (dBm)	Pass / Fail
		Chain 0	Chain 1				
38	5190	7.73	8.53	13.058	11.16	30	Pass
46	5230	7.75	8.22	12.594	11.00	30	Pass
151	5755	7.87	8.83	13.762	11.39	30	Pass
159	5795	7.79	8.72	13.459	11.29	30	Pass

**802.11ac (VHT80)**

Channel	Frequency (MHz)	Maximum Conducted Power (dBm)		Total Power (mW)	Total Power (dBm)	Power Limit (dBm)	Pass / Fail
		Chain 0	Chain 1				
42	5210	7.65	8.35	12.66	11.02	30	Pass
155	5775	8.61	7.42	12.782	11.07	30	Pass

**802.11n (HT20)**

Channel	Frequency (MHz)	26 dBc Bandwidth (MHz)	
		Chain 0	Chain 1
36	5180	20.68	20.29
44	5220	20.55	20.55
48	5240	20.62	20.33

**802.11n (HT40)**

Channel	Frequency (MHz)	26 dBc Bandwidth (MHz)	
		Chain 0	Chain 1
38	5190	41.79	42.00
46	5230	41.73	41.96

**802.11ac (VHT80)**

Channel	Frequency (MHz)	26 dBc Bandwidth (MHz)	
		Chain 0	Chain 1
42	5210	78.70	78.20

### Spectrum Plot of Worst Value

#### 802.11n (HT20)

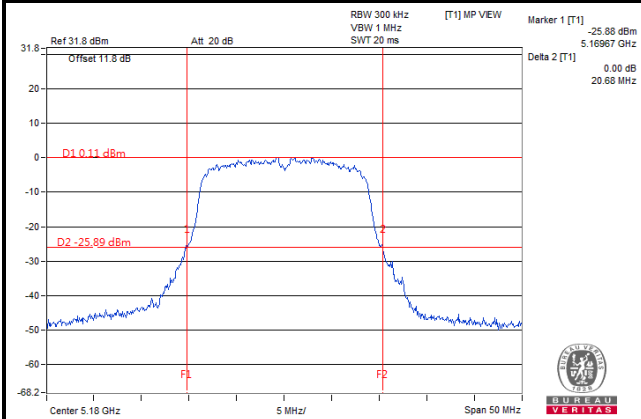

#### 802.11n (HT40)

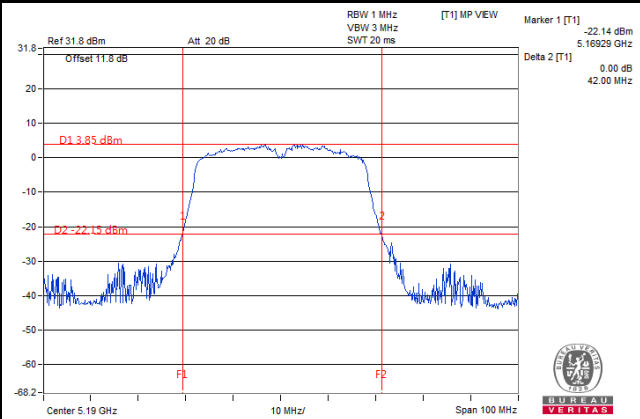

#### 802.11ac (VHT80)

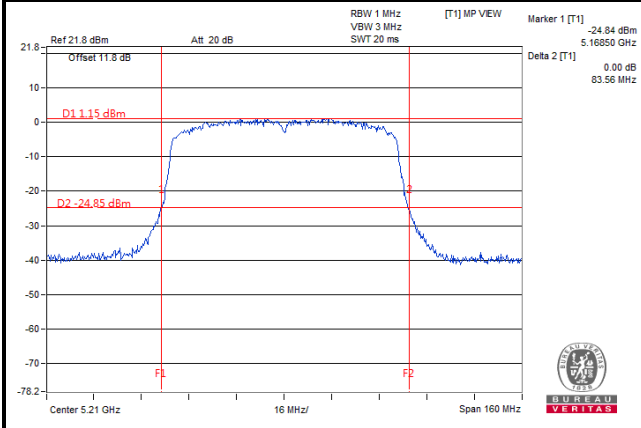

#### 4.4 Peak Power Spectral Density Measurement

##### 4.4.1 Limits of Peak Power Spectral Density Measurement

Operation Band	EUT Category		Limit
U-NII-1		Outdoor Access Point	17 dBm/MHz
		Fixed point-to-point Access Point	
	√	Indoor Access Point	
		Mobile and Portable client device	11 dBm/MHz
U-NII-2A			11 dBm/MHz
U-NII-2C			11 dBm/MHz
U-NII-3		√	30 dBm/500 kHz

##### 4.4.2 Test Setup

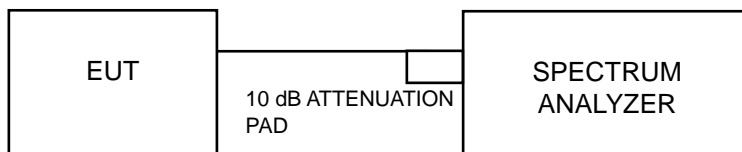

##### 4.4.3 Test Instruments

Refer to section 4.1.3 to get information of above instrument.

##### 4.4.4 Test Procedures

###### For U-NII-1 band:

Using method SA-2

1. Set span to encompass the entire emission bandwidth (EBW) of the signal.
2. Set RBW = 1 MHz, Set VBW ≥ 3 RBW, Detector = RMS
3. Sweep time = auto, trigger set to “free run”.
4. Trace average at least 100 traces in power averaging mode.
5. Record the max value and add 10 log (1/duty cycle)

###### ※For U-NII-3:

1. Set span to encompass the entire emission bandwidth (EBW) of the signal.
2. Set RBW = 500 kHz, Set VBW ≥ 3 RBW, Detector = RMS
3. Use the peak marker function to determine the maximum power level in any 500 kHz band segment within the fundamental EBW.
4. Sweep time = auto, trigger set to “free run”.
5. Trace average at least 100 traces in power averaging mode.
6. Record the max value and add 10 log (1/duty cycle)

#### 4.4.5 Deviation from Test Standard

No deviation.

#### 4.4.6 EUT Operating Conditions

The software provided by client to enable the EUT under transmission condition continuously at lowest, middle and highest channel frequencies individually.

#### 4.4.7 Test Results

##### 802.11n (HT20)

Channel	Frequency (MHz)	PSD (dBm/MHz)		Duty Factor (dB)	Total PSD with Duty Factor (dBm/MHz)	Max. Limit (dBm/MHz)	Pass / Fail
		Chain 0	Chain 1				
36	5180	-3.24	-2.61	0.25	0.35	14.18	Pass
44	5220	-3.24	-2.66	0.25	0.32	14.18	Pass
48	5240	-3.26	-2.37	0.25	0.47	14.18	Pass

**Note:**

- Method 1 of power density measurement of KDB 662911 is using for calculating total power density. Total power density is summing entire spectra across corresponding frequency bins on the various outputs by computer.
- For U-NII-1 Band:**  
 $\text{Directional gain} = 10\log[(10^{G1/20} + 10^{G2/20})^2 / N_{ANT}] = 8.82 \text{ dBi} > 6 \text{ dBi}$ , so the power density limit shall be reduced to  $17 - (8.82 - 6) = 14.18 \text{ dBm}$ .
- Refer to section 3.3 for duty cycle spectrum plot.

##### 802.11n (HT40)

Channel	Frequency (MHz)	PSD (dBm/MHz)		Duty Factor (dB)	Total PSD with Duty Factor (dBm/MHz)	Max. Limit (dBm/MHz)	Pass / Fail
		Chain 0	Chain 1				
38	5190	-6.57	-6.03	0.54	-2.74	14.18	Pass
46	5230	-6.61	-5.85	0.54	-2.66	14.18	Pass

**Note:**

- Method 1 of power density measurement of KDB 662911 is using for calculating total power density. Total power density is summing entire spectra across corresponding frequency bins on the various outputs by computer.
- For U-NII-1 Band:**  
 $\text{Directional gain} = 10\log[(10^{G1/20} + 10^{G2/20})^2 / N_{ANT}] = 8.82 \text{ dBi} > 6 \text{ dBi}$ , so the power density limit shall be reduced to  $17 - (8.82 - 6) = 14.18 \text{ dBm}$ .
- Refer to section 3.3 for duty cycle spectrum plot.

##### 802.11ac (VHT80)

Channel	Frequency (MHz)	PSD (dBm/MHz)		Duty Factor (dB)	Total PSD with Duty Factor (dBm/MHz)	Max. Limit (dBm/MHz)	Pass / Fail
		Chain 0	Chain 1				
42	5210	-9.52	-8.89	0.85	-5.33	14.18	Pass

**Note:**

- Method 1 of power density measurement of KDB 662911 is using for calculating total power density. Total power density is summing entire spectra across corresponding frequency bins on the various outputs by computer.
- For U-NII-1 Band:**  
 $\text{Directional gain} = 10\log[(10^{G1/20} + 10^{G2/20})^2 / N_{ANT}] = 8.82 \text{ dBi} > 6 \text{ dBi}$ , so the power density limit shall be reduced to  $17 - (8.82 - 6) = 14.18 \text{ dBm}$ .
- Refer to section 3.3 for duty cycle spectrum plot.



### Spectrum Plot of Worst Value

#### 802.11n (HT20)

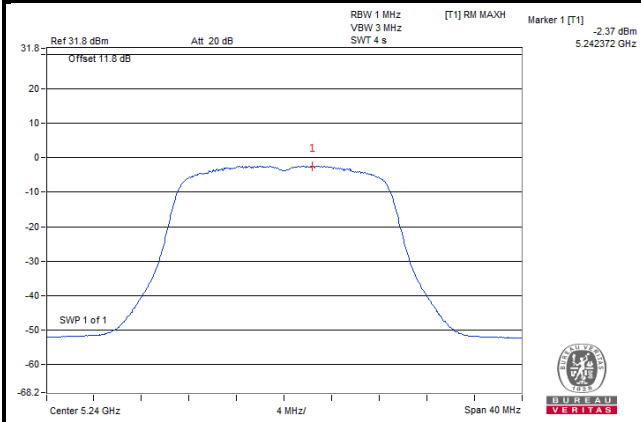

#### 802.11n (HT40)

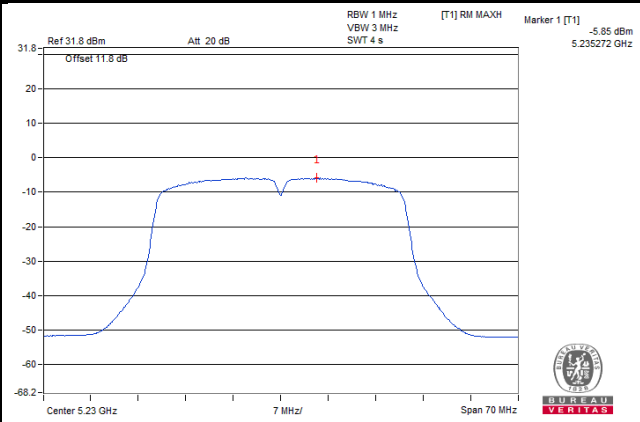

#### 802.11ac (VHT80)

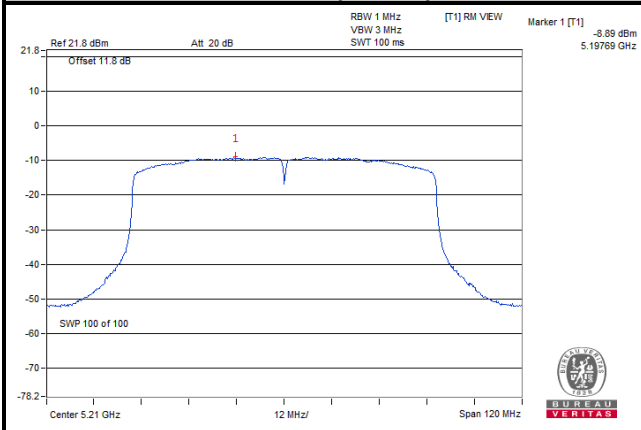

## For U-NII-3 Band

### 802.11n (HT20)

TX Chain	Channel	Frequency (MHz)	PSD (dBm/500 kHz)	10 log (N=2) dB	Duty Factor (dB)	Total PSD with Duty Factor (dBm/500 kHz)	Limit (dBm/500 kHz)	Pass / Fail
0	149	5745	-6.59	3.01	0.25	-3.33	28.04	Pass
	157	5785	-6.43	3.01	0.25	-3.17	28.04	Pass
	165	5825	-6.04	3.01	0.25	-2.78	28.04	Pass
1	149	5745	-5.42	3.01	0.25	-2.16	28.04	Pass
	157	5785	-5.48	3.01	0.25	-2.22	28.04	Pass
	165	5825	-5.23	3.01	0.25	-1.97	28.04	Pass

**Note:**

- Method 1 of power density measurement of KDB 662911 is using for calculating total power density. Total power density is summing entire spectra across corresponding frequency bins on the various outputs by computer.
- Directional gain =  $10 \log[(10^{G1/20} + 10^{G2/20})^2 / N_{ANT}] = 7.96 > 6$  dBi, so the power density limit shall be reduced to  $30 - (7.96 - 6) = 28.04$  dBm.
- Refer to section 3.3 for duty cycle spectrum plot.

### 802.11n (HT40)

TX Chain	Channel	Frequency (MHz)	PSD (dBm/500 kHz)	10 log (N=2) dB	Duty Factor (dB)	Total PSD with Duty Factor (dBm/500 kHz)	Limit (dBm/500 kHz)	Pass / Fail
0	151	5755	-9.45	3.01	0.54	-5.90	28.04	Pass
	159	5795	-8.99	3.01	0.54	-5.44	28.04	Pass
1	151	5755	-8.45	3.01	0.54	-4.90	28.04	Pass
	159	5795	-8.25	3.01	0.54	-4.70	28.04	Pass

**Note:**

- Method 1 of power density measurement of KDB 662911 is using for calculating total power density. Total power density is summing entire spectra across corresponding frequency bins on the various outputs by computer.
- Directional gain =  $10 \log[(10^{G1/20} + 10^{G2/20})^2 / N_{ANT}] = 7.96 > 6$  dBi, so the power density limit shall be reduced to  $30 - (7.96 - 6) = 28.04$  dBm.
- Refer to section 3.3 for duty cycle spectrum plot.

### 802.11ac (VHT80)

TX Chain	Channel	Frequency (MHz)	PSD (dBm/500 kHz)	10 log (N=2) dB	Duty Factor (dB)	Total PSD with Duty Factor (dBm/500 kHz)	Limit (dBm/500 kHz)	Pass / Fail
0	155	5775	-10.25	3.01	0.85	-6.39	28.04	Pass
1	155	5775	-9.28	3.01	0.85	-5.42	28.04	Pass

**Note:**

- Method 1 of power density measurement of KDB 662911 is using for calculating total power density. Total power density is summing entire spectra across corresponding frequency bins on the various outputs by computer.
- Directional gain =  $10 \log[(10^{G1/20} + 10^{G2/20})^2 / N_{ANT}] = 7.96 > 6$  dBi, so the power density limit shall be reduced to  $30 - (7.96 - 6) = 28.04$  dBm.3. Refer to section 3.3 for duty cycle spectrum plot.
- Refer to section 3.3 for duty cycle spectrum plot.

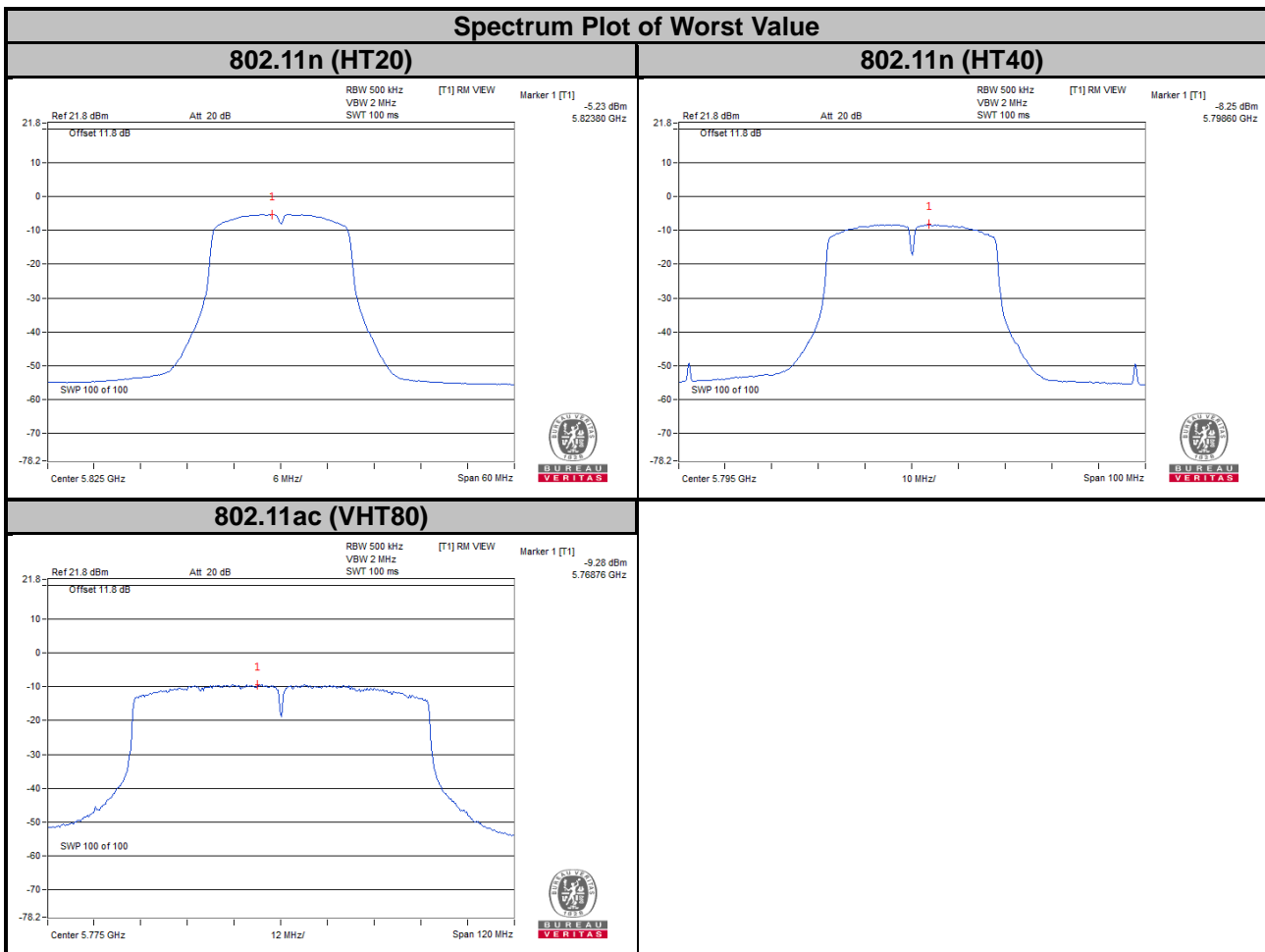

## 4.5 Frequency Stability

### 4.5.1 Limit of Frequency Stability Measurement

The frequency of the carrier signal shall be maintained within band of operation.

### 4.5.2 Test Setup

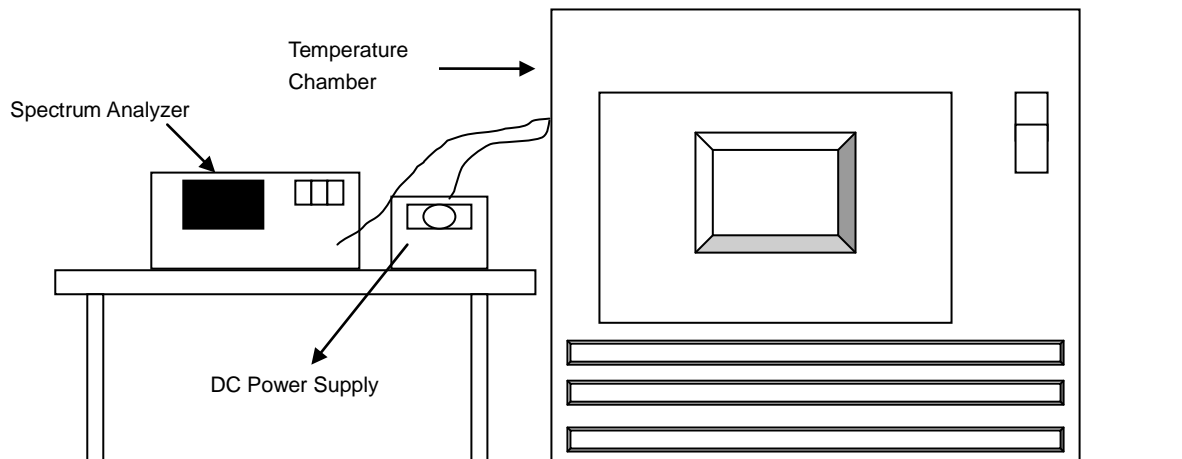

### 4.5.3 Test Instruments

Refer to section 4.1.3 to get information of above instrument.

### 4.5.4 Test Procedure

- To ensure emission at the band edge is maintained within the authorized band, those values shall be measured by radiation emissions at upper and lower frequency points, and finally compensated by frequency deviation as procedures below.
- The EUT was operated at the maximum output power, and connected to the spectrum analyzer, which is set to maximum hold function and peak detector. The peak value of the power envelope was measured and noted. The upper and lower frequency points were respectively measured relatively 10 dB lower than the measured peak value.
- The frequency deviation was calculated by adding the upper frequency point and the lower frequency point divided by two. Those detailed values of frequency deviation are provided in table below.

### 4.5.5 Deviation from Test Standard

No deviation.

### 4.5.6 EUT Operating Condition

Set the EUT transmit at un-modulation mode to test frequency stability.

#### 4.5.7 Test Results

Frequency Stability Versus Temp.									
Operating Frequency: 5320 MHz									
Temp. (°C)	Power Supply (Vdc)	0 Minute		2 Minute		5 Minute		10 Minute	
		Measured Frequency (MHz)	Frequency Drift (ppm)	Measured Frequency (MHz)	Frequency Drift (ppm)	Measured Frequency (MHz)	Frequency Drift (ppm)	Measured Frequency (MHz)	Frequency Drift (ppm)
50	3.8	5179.995	-0.97000	5179.9945	-1.06000	5179.9967	-0.64000	5179.9921	-1.53000
40	3.8	5179.999	-0.19000	5180.0012	0.23000	5180.0025	0.48000	5180.0002	0.04000
30	3.8	5179.9816	-3.55000	5179.9779	-4.27000	5179.9813	-3.61000	5179.9794	-3.98000
20	3.8	5179.9818	-3.51000	5179.9834	-3.20000	5179.9824	-3.40000	5179.9819	-3.49000
10	3.8	5179.9787	-4.11000	5179.9794	-3.98000	5179.9806	-3.75000	5179.9807	-3.73000
0	3.8	5179.9837	-3.15000	5179.9824	-3.40000	5179.9859	-2.72000	5179.9866	-2.59000
-10	3.8	5179.9947	-1.02000	5179.9909	-1.76000	5179.9917	-1.60000	5179.9913	-1.68000
-20	3.8	5180.0189	3.65000	5180.0187	3.61000	5180.0158	3.05000	5180.0159	3.07000
-30	3.8	5180.0229	4.42000	5180.0234	4.52000	5180.02	3.86000	5180.0242	4.67000

Frequency Stability Versus Temp.									
Operating Frequency: 5320 MHz									
Temp. (°C)	Power Supply (Vdc)	0 Minute		2 Minute		5 Minute		10 Minute	
		Measured Frequency (MHz)	Frequency Drift (ppm)	Measured Frequency (MHz)	Frequency Drift (ppm)	Measured Frequency (MHz)	Frequency Drift (ppm)	Measured Frequency (MHz)	Frequency Drift (ppm)
20	4.37	5179.9808	-3.71000	5179.9835	-3.19000	5179.9816	-3.55000	5179.982	-3.47000
	3.8	5179.9818	-3.51000	5179.9834	-3.20000	5179.9824	-3.40000	5179.9819	-3.49000
	3.23	5179.9823	-3.42000	5179.9844	-3.01000	5179.9823	-3.42000	5179.9823	-3.42000

## 4.6 6 dB Bandwidth Measurement

### 4.6.1 Limits of 6 dB Bandwidth Measurement

The minimum of 6 dB Bandwidth Measurement is 0.5 MHz.

### 4.6.2 Test Setup

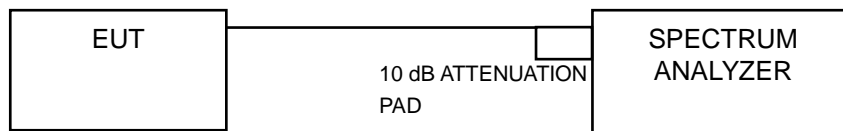

### 4.6.3 Test Instruments

Refer to section 4.1.3 to get information of above instrument.

### 4.6.4 Test Procedure

#### MEASUREMENT PROCEDURE REF

- Set resolution bandwidth (RBW) = 100 kHz
- Set the video bandwidth (VBW)  $\geq 3 \times$  RBW, Detector = Peak.
- Trace mode = max hold.
- Sweep = auto couple.
- Measure the maximum width of the emission that is constrained by the frequencies associated with the two amplitude points (upper and lower) that are attenuated by 6 dB relative to the maximum level measured in the fundamental emission

### 4.6.5 Deviation from Test Standard

No deviation.

### 4.6.6 EUT Operating Condition

The software provided by client to enable the EUT under transmission condition continuously at lowest, middle and highest channel frequencies individually.

## 4.6.7 Test Results

## 802.11n (HT20)

Channel	Frequency (MHz)	6 dB Bandwidth (MHz)		Minimum Limit (MHz)	Pass / Fail
		Chain 0	Chain 1		
149	5745	15.15	15.08	0.5	Pass
157	5785	15.17	15.13	0.5	Pass
165	5825	15.18	15.17	0.5	Pass

## 802.11n (HT40)

Channel	Frequency (MHz)	6 dB Bandwidth (MHz)		Minimum Limit (MHz)	Pass / Fail
		Chain 0	Chain 1		
151	5755	15.15	15.08	0.5	Pass
159	5795	15.17	15.13	0.5	Pass

## 802.11ac (VHT80)

Channel	Frequency (MHz)	6 dB Bandwidth (MHz)		Minimum Limit (MHz)	Pass / Fail
		Chain 0	Chain 1		
155	5775	75.26	75.32	0.5	Pass

### Spectrum Plot of Worst Value

#### 802.11n (HT20)

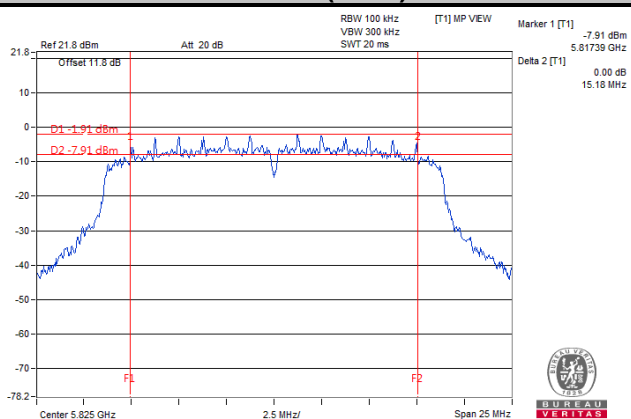

#### 802.11n (HT40)

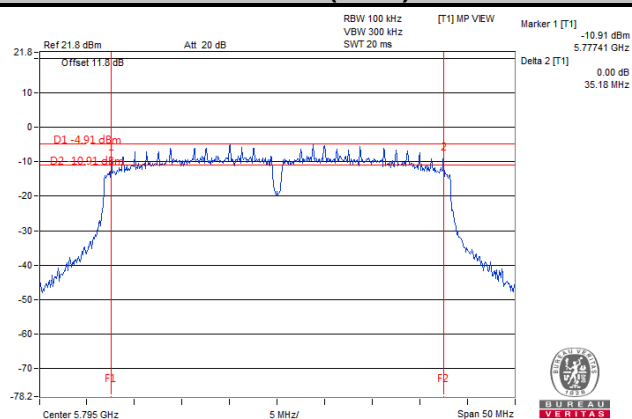

#### 802.11ac (VHT80)

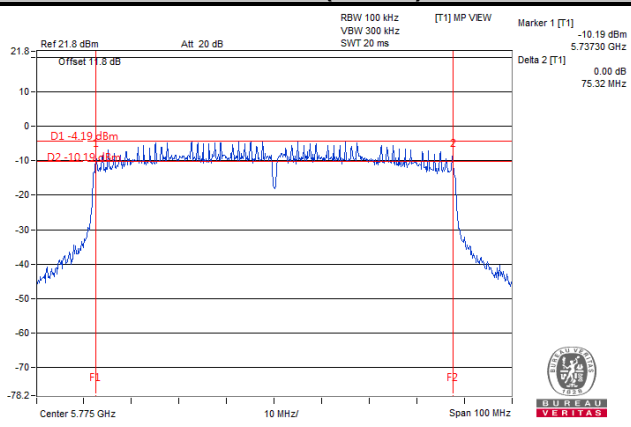



## 4.7 Occupied Bandwidth Measurement

### 4.7.1 Test Setup

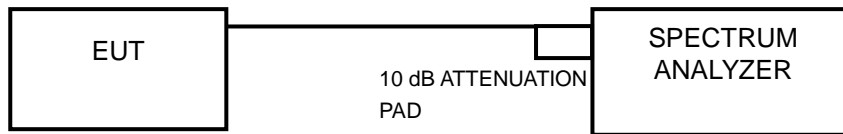

### 4.7.2 Test Instruments

Refer to section 4.1.3 to get information of above instrument.

### 4.7.3 Test Procedure

The transmitter output was connected to the spectrum analyzer through an attenuator. The bandwidth of the fundamental frequency was measured by spectrum analyzer with resolution bandwidth in the range of 1 % to 5 % of the anticipated emission bandwidth, and a video bandwidth at least 3x the resolution bandwidth and set the detector to PEAK. The width of a frequency band such that, below the lower and above the upper frequency limits, the mean powers emitted are each equal to a specified percentage 0.5 % of the total mean power of a given emission.

### 4.7.4 Deviation from Test Standard

No deviation.

### 4.7.5 EUT Operating Conditions

The software provided by client to enable the EUT under transmission condition continuously at lowest, middle and highest channel frequencies individually.

## 4.7.6 Test Results

## 802.11n (HT20)

Channel	Frequency (MHz)	Occupied Bandwidth (MHz)		Pass / Fail
		Chain 0	Chain 1	
149	5745	17.45	17.50	Pass
157	5785	17.40	17.45	Pass
165	5825	17.45	17.50	Pass

## 802.11n (HT40)

Channel	Frequency (MHz)	Occupied Bandwidth (MHz)		Pass / Fail
		Chain 0	Chain 1	
151	5755	36.05	36.05	Pass
159	5795	35.83	36.00	Pass

## 802.11ac (VHT80)

Channel	Frequency (MHz)	Occupied Bandwidth (MHz)		Pass / Fail
		Chain 0	Chain 1	
155	5775	75.16	75.16	Pass

### Spectrum Plot of Worst Value

#### 802.11n (HT20)

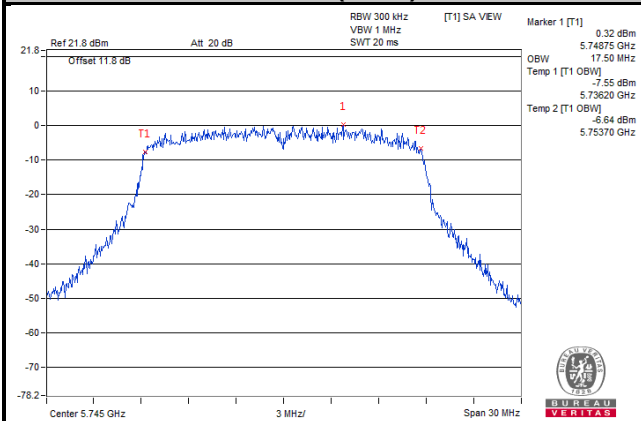

#### 802.11n (HT40)

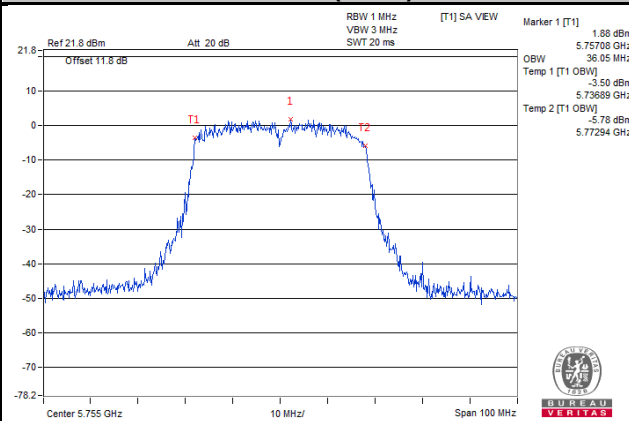

#### 802.11ac (VHT80)

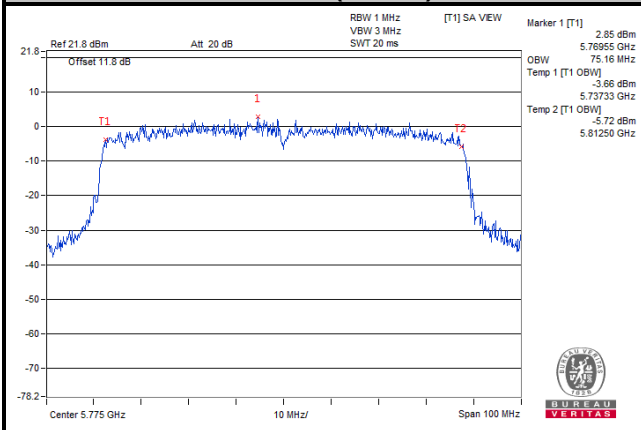

## 5 Pictures of Test Arrangements

Please refer to the attached file (Test Setup Photo).

# Annex A- Radiated Out of Band Emisison (OOBE) Measurement (For U-NII-3 band)

## 802.11n (HT20)

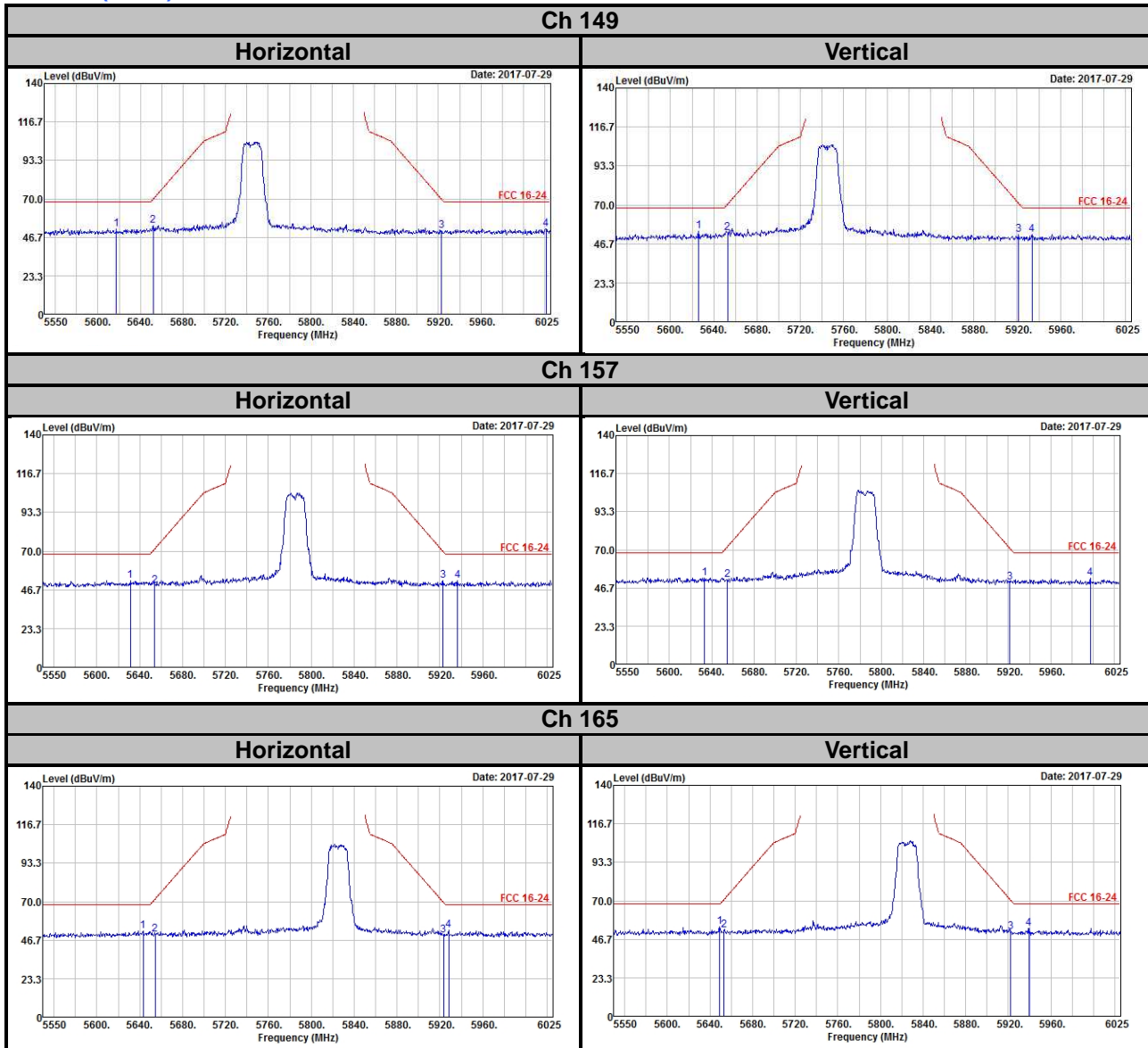

### 802.11n (HT40)

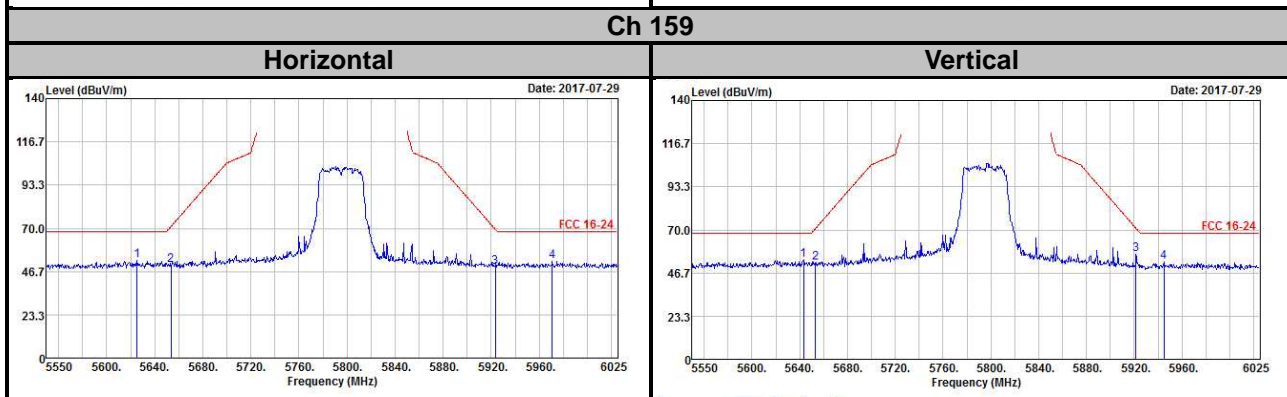
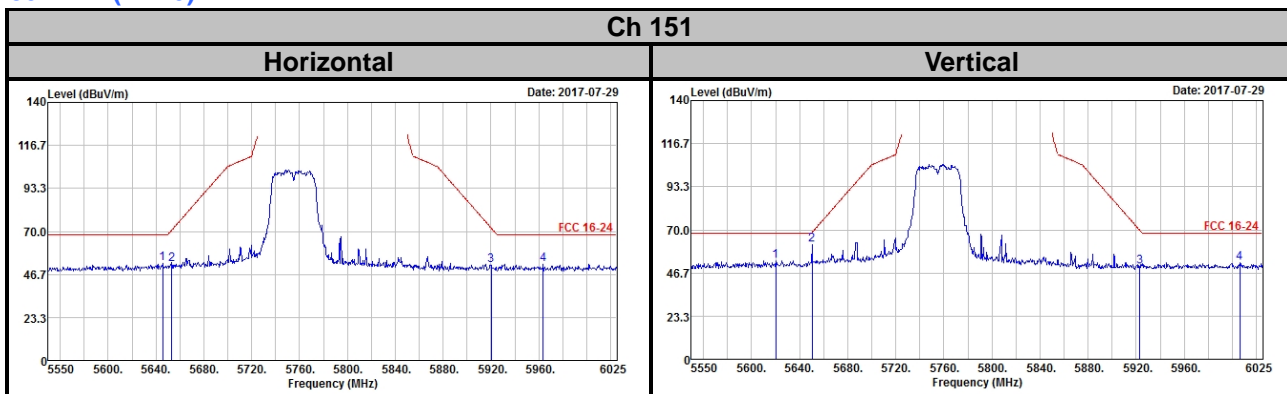

### 802.11ac (VHT80)

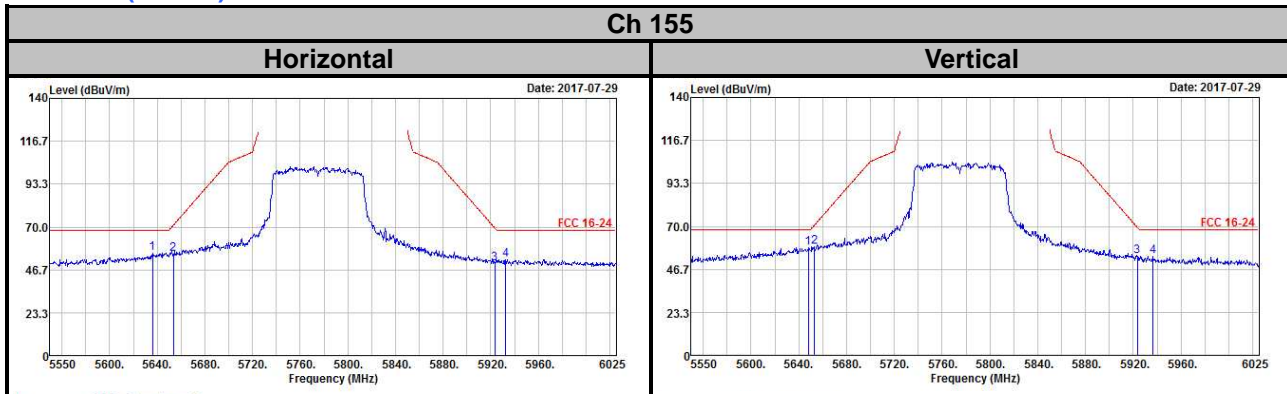

## Appendix – Information on the Testing Laboratories

We, Bureau Veritas Consumer Products Services (H.K.) Ltd., Taoyuan Branch, were founded in 1988 to provide our best service in EMC, Radio, Telecom and Safety consultation. Our laboratories are accredited and approved according to ISO/IEC 17025.

If you have any comments, please feel free to contact us at the following:

**Linko EMC/RF Lab**

Tel: 886-2-26052180

Fax: 886-2-26051924

**Hsin Chu EMC/RF/Telecom Lab**

Tel: 886-3-6668565

Fax: 886-3-6668323

**Hwa Ya EMC/RF/Safety**

Tel: 886-3-3183232

Fax: 886-3-3270892

**Email:** [service.adt@tw.bureauveritas.com](mailto:service.adt@tw.bureauveritas.com)

**Web Site:** [www.bureauveritas-adt.com](http://www.bureauveritas-adt.com)

The address and road map of all our labs can be found in our web site also.

--- END ---