

FCC LTE REPORT

FCC Certification

Applicant Name:
Franklin Technology Inc.

Date of Issue:
January 20, 2017

Address:
906 JEI Platz, 186, Gasan digital 1-ro,
Geumcheon-gu, Seoul, Korea, (08502)

Location:
HCT CO., LTD.,
74, Seoicheon-ro 578beon-gil, Majang-myeon,
Icheon-si, Gyeonggi-do, 17383, Rep. of KOREA

Report No.: HCT-R-1701-F028
HCT FRN: 0005866421

FCC ID: XHG-R900

APPLICANT: Franklin Technology Inc.

FCC Model(s): MHS900L
EUT Type: Mobile Router
FCC Classification: PCS Licensed Transmitter (PCB)
FCC Rule Part(s): §27, §2

| Mode (MHz) | Tx Frequency (MHz) | Emission Designator | Modulation | EIRP | |
|------------------|--------------------|---------------------|------------|----------------|------------------|
| | | | | Max. Power (W) | Max. Power (dBm) |
| LTE – Band4 (5) | 1712.5 – 1752.5 | 4M56G7D | QPSK | 0.065 | 18.14 |
| | | 4M56W7D | 16QAM | 0.055 | 17.44 |
| LTE – Band4 (10) | 1715.0 – 1750.0 | 9M06G7D | QPSK | 0.066 | 18.21 |
| | | 9M02W7D | 16QAM | 0.055 | 17.44 |
| LTE – Band4 (15) | 1717.5 – 1747.5 | 13M6G7D | QPSK | 0.074 | 18.71 |
| | | 13M6W7D | 16QAM | 0.061 | 17.88 |
| LTE – Band4 (20) | 1720.0 – 1745.0 | 18M0G7D | QPSK | 0.075 | 18.72 |
| | | 18M1W7D | 16QAM | 0.062 | 17.91 |

| Mode (MHz) | Tx Frequency (MHz) | Emission Designator | Modulation | ERP | |
|-------------------|--------------------|---------------------|------------|----------------|------------------|
| | | | | Max. Power (W) | Max. Power (dBm) |
| LTE – Band13 (5) | 779.5 – 784.5 | 4M54G7D | QPSK | 0.075 | 18.75 |
| | | 4M58W7D | 16QAM | 0.064 | 18.09 |
| LTE – Band13 (10) | 782.0 | 9M06G7D | QPSK | 0.061 | 17.85 |
| | | 9M05W7D | 16QAM | 0.051 | 17.12 |

The measurements shown in this report were made in accordance with the procedures specified in CFR47 section §2.947. I assume full responsibility for the accuracy and completeness of these measurements, and for the qualifications of all persons taking them.

HCT CO., LTD. Certifies that no party to this application has subject to a denial of Federal benefits that includes FCC benefits pursuant to section 5301 of the Anti-Drug Abuse Act of 1998, 21 U.S. C. 853(a)



Report prepared by
: Jeong Ho Kim
Test engineer of RF Team



Approved by
: Jong Seok Lee
Manager of RF Team

This report only responds to the tested sample and may not be reproduced, except in full, without written approval of the HCT Co., Ltd.

Version

| TEST REPORT NO. | DATE | DESCRIPTION |
|-----------------|------------------|-------------------------|
| HCT-R-1701-F028 | January 20, 2017 | - First Approval Report |
| | | |
| | | |
| | | |

Table of Contents

| | |
|--|----|
| 1. GENERAL INFORMATION | 6 |
| 2. INTRODUCTION | 7 |
| 2.1. EUT DESCRIPTION..... | 7 |
| 2.2. MEASURING INSTRUMENT CALIBRATION..... | 7 |
| 2.3. TEST FACILITY | 7 |
| 3. DESCRIPTION OF TESTS | 8 |
| 3.1 ERP/EIRP RADIATED POWER AND RADIATED SPURIOUS EMISSIONS..... | 8 |
| 3.2 AWS – MOBILE FREQUENCY BLOCKS (1710 – 1755 MHz) | 9 |
| 3.3 BLOCK B FREQUENCY RANGE (775 – 788 MHz) | 9 |
| 3.4 PEAK-AVERAGE RATIO. | 10 |
| 3.5 OCCUPIED BANDWIDTH. | 12 |
| 3.6 SPURIOUS AND HARMONIC EMISSIONS AT ANTENNA TERMINAL..... | 13 |
| 3.7 FREQUENCY STABILITY / VARIATION OF AMBIENT TEMPERATURE | 14 |
| 4. LIST OF TEST EQUIPMENT | 15 |
| 5. MEASUREMENT UNCERTAINTY..... | 16 |
| 6. SUMMARY OF TEST RESULTS | 17 |
| 7. SAMPLE CALCULATION..... | 18 |
| 8. TEST DATA | 19 |
| 8.1 EQUIVALENT ISOTROPIC RADIATED POWER (Band 4) | 19 |
| 8.2 EFFECTIVE RADIATED POWER (Band 13)..... | 22 |
| 8.3 RADIATED SPURIOUS EMISSIONS..... | 23 |
| 8.3.1 RADIATED SPURIOUS EMISSIONS (5 MHz Band 4 LTE) | 23 |
| 8.3.2 RADIATED SPURIOUS EMISSIONS (10 MHz Band 4 LTE) | 24 |
| 8.3.3 RADIATED SPURIOUS EMISSIONS (15 MHz Band 4 LTE) | 25 |
| 8.3.4 RADIATED SPURIOUS EMISSIONS (20 MHz Band 4 LTE) | 26 |
| 8.3.5 RADIATED SPURIOUS EMISSIONS (5 MHz Band 13 LTE)..... | 27 |
| 8.3.6 RADIATED SPURIOUS EMISSIONS (10 MHz Band 13 LTE)..... | 28 |
| 8.3.6.1 RADIATED SPURIOUS EMISSIONS (1559 ~ 1610 MHz Band) | 29 |
| 8.3.6.2 RADIATED SPURIOUS EMISSIONS (1559 ~ 1610 MHz Band) | 29 |
| 8.4 PEAK-TO-AVERAGE RATIO | 30 |
| 8.5 OCCUPIED BANDWIDTH | 31 |
| 8.6 CONDUCTED SPURIOUS EMISSIONS | 32 |
| 8.6.1 BAND EDGE..... | 33 |
| 8.7 FREQUENCY STABILITY / VARIATION OF AMBIENT TEMPERATURE | 34 |
| 8.7.1 FREQUENCY STABILITY (5 MHz Band 4 LTE) | 34 |

| | |
|--|----|
| 8.7.1 FREQUENCY STABILITY (10 MHz Band 4 LTE) | 35 |
| 8.7.2 FREQUENCY STABILITY (15 MHz Band 4 LTE) | 36 |
| 8.7.3 FREQUENCY STABILITY (20 MHz Band 4 LTE) | 37 |
| 8.7.4 FREQUENCY STABILITY (5 MHz Band 13 LTE) | 38 |
| 8.7.5 FREQUENCY STABILITY (10 MHz Band 13 LTE) | 39 |
| 9. TEST PLOTS..... | 40 |

MEASUREMENT REPORT

1. GENERAL INFORMATION

| | | |
|--------------------------------|---|--|
| Applicant Name: | Franklin Technology Inc. | |
| Address: | 906 JEI Platz, 186, Gasan digital 1-ro, Geumcheon-gu, Seoul, Korea, (08502) | |
| FCC ID: | XHG-R900 | |
| Application Type: | Certification | |
| FCC Classification: | PCS Licensed Transmitter (PCB) | |
| FCC Rule Part(s): | §27, §2 | |
| EUT Type: | Mobile Router | |
| FCC Model(s): | MHS900L | |
| Tx Frequency: | 1712.5 MHz – 1752.5 MHz (LTE – Band 4 (5 MHz)) 1715.0 MHz – 1750.0 MHz (LTE – Band 4 (10 MHz)) 1717.5 MHz – 1747.5 MHz (LTE – Band 4 (15 MHz)) 1720.0 MHz – 1745.0 MHz (LTE – Band 4 (20 MHz)) 779.5 MHz – 784.5 MHz (LTE – Band 13 (5MHz)) 782 MHz (LTE – Band 13 (10 MHz)) | |
| Max. RF Output Power: | Band 4 (5 MHz): | 0.065 W (QPSK) (18.14 dBm) 0.055 W (16-QAM) (17.44 dBm) |
| | Band 4 (10 MHz): | 0.066 W (QPSK) (18.21 dBm) 0.055 W (16-QAM) (17.44 dBm) |
| | Band 4 (15 MHz): | 0.074 W (QPSK) (18.71 dBm) 0.061 W (16-QAM) (17.88 dBm) |
| | Band 4 (20 MHz): | 0.075 W (QPSK) (18.72 dBm) 0.062 W (16-QAM) (17.91 dBm) |
| | Band 13 (5 MHz) : | 0.075 W (QPSK) (18.75 dBm) 0.064 W (16-QAM) (18.09 dBm) |
| | Band 13 (10 MHz) : | 0.061 W (QPSK) (17.85 dBm) 0.051 W (16-QAM) (17.12 dBm) |
| Emission Designator(s): | Band 4 (5 MHz): | 4M56G7D (QPSK) / 4M56W7D (16-QAM) |
| | Band 4 (10 MHz): | 9M06G7D (QPSK) / 9M02W7D (16-QAM) |
| | Band 4 (15 MHz): | 13M6G7D (QPSK) / 13M6W7D (16-QAM) |
| | Band 4 (20 MHz): | 18M0G7D (QPSK) / 18M1W7D (16-QAM) |
| | Band 13 (5 MHz) : | 4M54G7D (QPSK) / 4M58W7D (16-QAM) |
| | Band 13 (10 MHz) : | 9M06G7D (QPSK) / 9M05W7D (16-QAM) |
| Date(s) of Tests: | December 27, 2016 ~ January 19, 2017 | |
| Antenna Specification: | Manufacturer: | HUTEC Co.,ltd |
| | Antenna type: | Internal Antenna |
| | Peak Gain: | Band 4: 4.32 dBi Band 13: 1.10 dBi |

2. INTRODUCTION

2.1. EUT DESCRIPTION

The Franklin Technology Inc. MHS900L Mobile Router consists of LTE 4 and LTE 13.

2.2. MEASURING INSTRUMENT CALIBRATION

The measuring equipment, which was utilized in performing the tests documented herein, has been calibrated in accordance with the manufacturer's recommendations for utilizing calibration equipment, which is traceable to recognized national standards.

2.3. TEST FACILITY

The Fully-anechoic chamber and conducted measurement facility used to collect the radiated data are located at the **74, Seoicheon-ro 578beon-gil, Majang-myeon, Icheon-si, Gyeonggi-do, 17383, Rep. of KOREA.**

3. DESCRIPTION OF TESTS

3.1 ERP/EIRP RADIATED POWER AND RADIATED SPURIOUS EMISSIONS

Note: ERP(Effective Radiated Power), EIRP(Effective Isotropic Radiated Power)

Test Procedure

Radiated emission measurements are performed in the Fully-anechoic chamber. The equipment under test is placed on a non-conductive table 3-meters away from the receive antenna in accordance with ANSI/TIA-603-D-2010 Clause 2.2.17. The turntable is rotated through 360 degrees, and the receiving antenna scans in order to determine the level of the maximized emission. The level and position of the maximized emission is recorded with the spectrum analyzer using a RMS detector.

A half wave dipole is then substituted in place of the EUT. For emissions above 1GHz, a horn antenna is substituted in place of the EUT. The substitute antenna is driven by a signal generator and the previously recorded signal was duplicated.

The power is calculated by the following formula;

$$P_{d(dBm)} = P_{g(dBm)} - \text{cable loss (dB)} + \text{antenna gain (dB)}$$

Where: P_d is the dipole equivalent power and P_g is the generator output power into the substitution antenna.

The maximum EIRP is calculated by adding the forward power to the calibrated source plus its appropriate gain value. These steps are repeated with the receiving antenna in both vertical and horizontal polarization. the difference between the gain of the horn and an isotropic antenna are taken into consideration

Radiated spurious emissions

: Frequency Range : 9 kHz ~ 10th Harmonics of highest channel fundamental frequency.

3.2 AWS – MOBILE FREQUENCY BLOCKS (1710 – 1755 MHz)

§27.5(h)

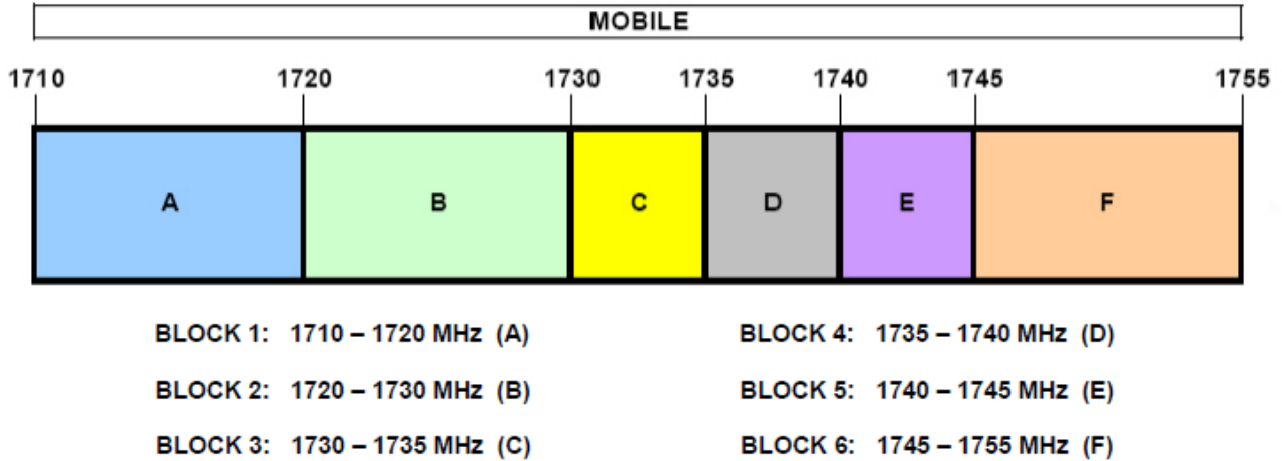

3.3 BLOCK B FREQUENCY RANGE (775 – 788 MHz)

§27.5(b)

746-758 MHz, 775-788 MHz, and 805-806 MHz bands. The following frequencies are available for licensing pursuant to this part in the 746-758 MHz, 775-788 MHz, and 805-806 MHz bands:

- (1) Two paired channels of 1 megahertz each are available for assignment in Block A in the 757-758 MHz and 787-788 MHz bands.
- (2) Two paired channels of 1 megahertz each are available for assignment in Block B in the 775-776 MHz and 805-806 MHz bands.
- (3) Two paired channels of 11 megahertz each are available for assignment in Block C in the 746-757 MHz and 776-787 MHz bands. In the event that no licenses for two channels in this Block C are assigned based on the results of the first auction in which such licenses were offered because the auction results do not satisfy the applicable reserve price, the spectrum in the 746-757 MHz and 776-787 MHz bands will instead be made available for assignment at a subsequent auction as follows:
 - (i) Two paired channels of 6 megahertz each available for assignment in Block C1 in the 746-752 MHz and 776-782 MHz bands.
 - (ii) Two paired channels of 5 megahertz each available for assignment in Block C2 in the 752-757 MHz and 782-787 MHz band.

3.4 PEAK-AVERAGE RATIO.

Test Procedure

Peak to Average Power Ratio is tested in accordance with KDB971168 D01 Power Meas License Digital Systems v02r02, October 17, 2014, Section 5.7.

- Section 5.7.1 CCDF Procedure

- a) Set resolution/measurement bandwidth \geq signal's occupied bandwidth;
- b) Set the number of counts to a value that stabilizes the measured CCDF curve;
- c) Set the measurement interval as follows:
 - 1) for continuous transmissions, set to 1 ms,
 - 2) for burst transmissions, employ an external trigger that is synchronized with the EUT burst timing sequence, or use the internal burst trigger with a trigger level that allows the burst to stabilize and set the measurement interval to a time that is less than or equal to the burst duration.
- d) Record the maximum PAPR level associated with a probability of 0.1%.

- Section 5.7.2 Alternate Procedure

Use one of the procedures presented in 5.1 to measure the total peak power and record as P_{Pk} . Use one of the applicable procedures presented 5.2 to measure the total average power and record as P_{Avg} . Determine the P.A.R. from: $P.A.R_{(dB)} = P_{Pk (dBm)} - P_{Avg (dBm)}$ (P_{Avg} = Average Power + Duty cycle Factor)

5.1.1 Peak power measurements with a spectrum/signal analyzer or EMI receiver

The following procedure can be used to determine the total peak output power.

- a) Set the RBW \geq OBW.
- b) Set VBW $\geq 3 \times$ RBW.
- c) Set span $\geq 2 \times$ RBW
- d) Sweep time = auto couple.
- e) Detector = peak.
- f) Ensure that the number of measurement points \geq span/RBW.
- g) Trace mode = max hold.
- h) Allow trace to fully stabilize.
- i) Use the peak marker function to determine the peak amplitude level.

5.2.2 Procedures for use with a spectrum/signal analyzer when EUT cannot be configured to transmit continuously and sweep triggering/signal gating cannot be properly implemented

If the EUT cannot be configured to transmit continuously (burst duty cycle < 98%), then one of the following procedures can be used. The selection of the applicable procedure will depend on the characteristics of the measured burst duty cycle.

Measure the burst duty cycle with a spectrum/signal analyzer or EMC receiver can be used in zero-span mode if the response time and spacing between bins on the sweep are sufficient to permit accurate measurement of the burst on/off time of the transmitted signal.

5.2.2.2 Constant burst duty cycle

If the measured burst duty cycle is constant (i.e., duty cycle variations are less than ± 2 percent), then:

- a) Set span to at least 1.5 times the OBW.
- b) Set RBW = 1-5% of the OBW, not to exceed 1 MHz.
- c) Set VBW $\geq 3 \times$ RBW.
- d) Number of points in sweep $\geq 2 \times$ span / RBW. (This gives bin-to-bin spacing \leq RBW/2, so that narrowband signals are not lost between frequency bins.)
- e) Sweep time = auto.
- f) Detector = RMS (power averaging).
- g) Set sweep trigger to "free run".
- h) Trace average at least 100 traces in power averaging (i.e., RMS) mode.
- i) Compute power by integrating the spectrum across the OBW of the signal using the instrument's band power measurement function with band limits set equal to the OBW band edges. If the instrument does not have a band power function, sum the spectrum levels (in power units) at intervals equal to the RBW extending across the entire OBW of the spectrum.
- j) Add $10 \log (1/x)$, where x is the duty cycle, to the measured power in order to compute the average power during the actual transmission times (because the measurement represents an average over both the on and off times of the transmission).

For example, add $10 \log (1/0.25) = 6$ dB if the duty cycle is a constant 25%.

3.5 OCCUPIED BANDWIDTH.

Test set-up

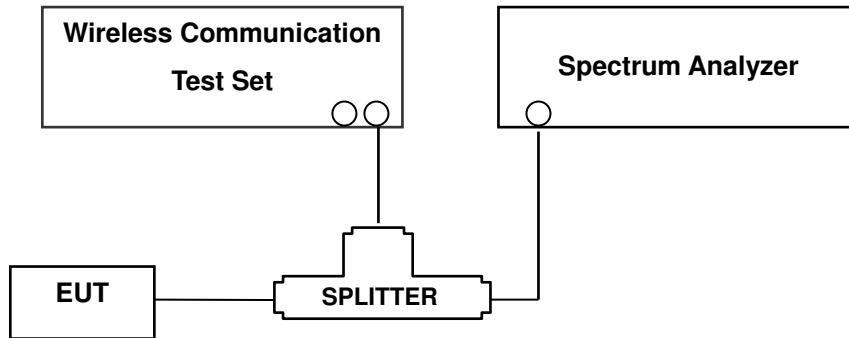

(Configuration of conducted Emission measurement)

The width of a frequency band such that, below the lower and above the upper frequency limits, the mean powers emitted are each equal to a specified percentage 0.5 % of the total mean power of a given emission.

Test Procedure

OBW is tested in accordance with KDB971168 D01 Power Meas License Digital Systems v02r02, October 17, 2014, Section 4.2.

The EUT makes a call to the communication simulator. The power was measured with R&S Spectrum Analyzer. All measurements were done at 3 channels(low, middle and high operational range.)

The conducted occupied bandwidth used the power splitter via EUT RF power connector between simulation base station and spectrum analyzer.

The communication simulator station system controlled a EUT to export maximum output power under transmission mode and specific channel frequency. Use OBW measurement function of Spectrum analyzer to measure 99 % occupied bandwidth

3.6 SPURIOUS AND HARMONIC EMISSIONS AT ANTENNA TERMINAL.

Test Procedure

Spurious and harmonic emissions at antenna terminal is tested in accordance with KDB971168 D01 Power Meas License Digital Systems v02r02, October 17, 2014, Section 6.0.

The level of the carrier and the various conducted spurious and harmonic frequencies is measured by means of a calibrated spectrum analyzer.

The spectrum is scanned from the lowest frequency generated in the equipment up to a frequency including its 10th harmonic. On any frequency outside a licensee's frequency block, the power of any emission shall be attenuated below the transmitter power (P) by at least $43 + 10 \log(P)$ dB. Compliance with these provisions is based on the use of measurement instrumentation employing a resolution bandwidth of 1 MHz or greater. However, in the 100 kHz bands immediately outside and adjacent to the frequency block a resolution bandwidth of at least 30 kHz bandwidth may be employed. The emission bandwidth is defined as the width of the signal between two points, one below the carrier center frequency and one above the carrier center frequency

Additionally, for operations in the 776-788MHz band, the power of any emission outside the licensee's frequency band of operation shall be attenuated below the transmitted power (P) within the licensed band(s) of operation, measured in watts, in accordance with the following:

- (1) On any frequency outside the 776-788MHz band, the power of any emission shall be attenuated outside the band below the transmitter power (P) by at least $43+10\log(P)$ dB.
- (2) On all frequencies between 763-775 and 793-805MHz, by a factor not less than $65+10\log(P)$ dB in a 6.25kHz band segment.

For operations in the 788–793 MHz band, the power of any emission outside the licensee's frequency bands of operation shall be attenuated below the transmitter power (P) within the licensed band(s) of operation, measured in watts, in accordance with the following:

- (1) On all frequencies between 769–775 MHz and 799–805 MHz, by a factor not less than $65 + 10 \log (P)$ dB in a 6.25 kHz band segment, for mobile and portable stations;
- (2) On any frequency between 775–788 MHz, above 805 MHz, and below 758 MHz, by at least $43 + 10 \log (P)$ dB

NOTES: The analyzer plot offsets were determined by below conditions.

- For LTE Band 4, total offset 27.0 dB = 20 dB attenuator + 6 dB Divider + 1.0 dB RF cables.
- For LTE Band 13 total offset 26.6 dB = 20 dB attenuator + 6 dB Divider + 0.6 dB RF cables.

3.7 FREQUENCY STABILITY / VARIATION OF AMBIENT TEMPERATURE

Test Set-up

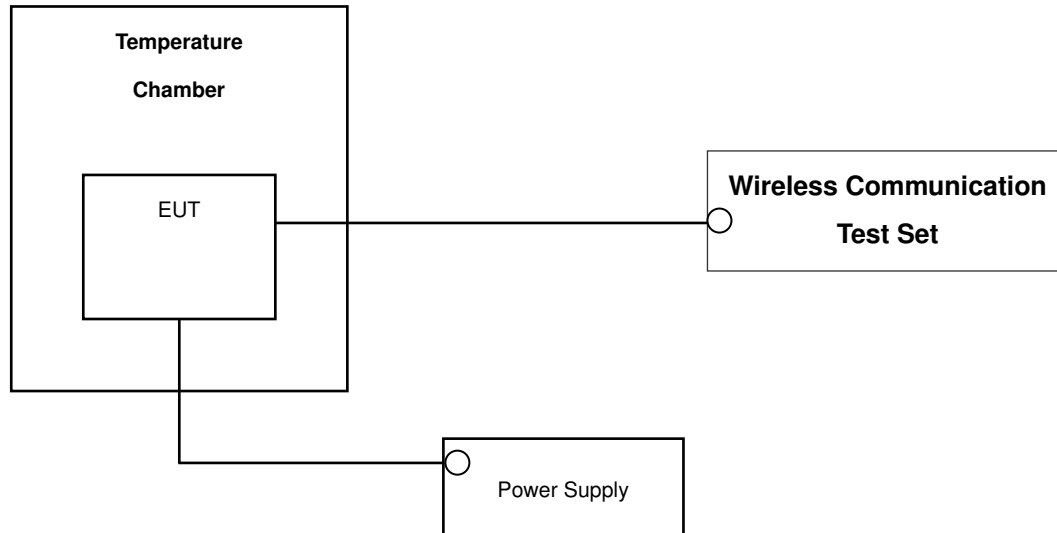

* Nominal Operating Voltage

Test Procedure

Frequency stability is tested in accordance with ANSI/TIA-603-D-2010 section 2.2.2

The frequency stability of the transmitter is measured by:

- a.) **Temperature:** The temperature is varied from - 30 °C to + 50 °C using an environmental chamber.
- b.) **Primary Supply Voltage:** The primary supply voltage is varied from the end point to 100 % of the voltage normally at the input to the device or at the power supply terminals if cables are not normally supplied.

Specification — the frequency stability shall be sufficient to ensure that the fundamental emission stays within the authorized frequency block

Time Period and Procedure:

The carrier frequency of the transmitter is measured at room temperature (20°C to provide a reference).

1. The equipment is turned on in a "standby" condition for one minute before applying power to the transmitter. Measurement of the carrier frequency of the transmitter is made within one minute after applying power to the transmitter.
2. Frequency measurements are made at 10°C intervals ranging from -30°C to +50°C. A period of at least one half-hour is provided to allow stabilization of the equipment at each temperature level.

NOTE: The EUT is tested down to the battery endpoint.

4. LIST OF TEST EQUIPMENT

| Manufacture | Model/ Equipment | Serial Number | Calibration Date | Calibration Interval | Calibration Due |
|-----------------|---|------------------------|------------------|----------------------|-----------------|
| REOHDE&SCHWARZ | SCU 18 / AMPLIFIER | 10094 | 09/07/2016 | Annual | 09/07/2017 |
| Wainwright | WHK1.2/15G-10EF/H.P.F | 4 | 04/11/2016 | Annual | 04/11/2017 |
| Wainwright | WHK3.3/18G-10EF/H.P.F | 2 | 04/11/2016 | Annual | 04/11/2017 |
| Hewlett Packard | 11667B / Power Splitter | 10545 | 02/15/2016 | Annual | 02/15/2017 |
| Hewlett Packard | 11667B / Power Splitter | 11275 | 04/29/2016 | Annual | 04/29/2017 |
| Agilent | E3632A/DC Power Supply | KR75303243 | 07/12/2016 | Annual | 07/12/2017 |
| Schwarzbeck | UHAP/ Dipole Antenna | 557 | 03/23/2015 | Biennial | 03/23/2017 |
| Schwarzbeck | UHAP/ Dipole Antenna | 558 | 03/23/2015 | Biennial | 03/23/2017 |
| EXP | EX-TH400/ Chamber | None | 05/31/2016 | Annual | 05/31/2017 |
| Schwarzbeck | BBHA 9120D/ Horn Antenna | 147 | 09/09/2016 | Biennial | 09/09/2018 |
| Schwarzbeck | BBHA 9120D/ Horn Antenna | 1299 | 05/15/2015 | Biennial | 05/15/2017 |
| Schwarzbeck | BBHA 9170/ Horn Antenna(15~40GHz) | BBHA9170342 | 04/30/2015 | Biennial | 04/30/2017 |
| Schwarzbeck | BBHA 9170/ Horn Antenna(15~35GHz) | BBHA9170124 | 04/30/2015 | Biennial | 04/30/2017 |
| Agilent | N9020A/Signal Analyzer | MY52090906 | 05/13/2016 | Annual | 05/13/2017 |
| Hewlett Packard | 8493C/ATTENUATOR | 17280 | 06/22/2016 | Annual | 06/22/2017 |
| REOHDE&SCHWARZ | FSV40/Spectrum Analyzer | 1307.9002K40-100931-NK | 06/15/2016 | Annual | 06/15/2017 |
| Agilent | 8960 (E5515C)/ Base Station(Now) | MY48360800 | 10/19/2016 | Annual | 10/19/2017 |
| Schwarzbeck | FMZB1513/ Loop Antenna(9kHz~30MHz) | 1513-175 | 02/23/2016 | Biennial | 02/23/2018 |
| Schwarzbeck | VULB9160/ Bilog Antenna | 3150 | 09/30/2016 | Biennial | 09/30/2018 |
| Schwarzbeck | VULB9160/ Bilog Antenna | 3368 | 10/14/2016 | Biennial | 10/14/2018 |
| Anritsu Corp. | MT8820C/Wideband Radio Communication Tester | 6200863156 | 02/26/2016 | Annual | 02/26/2017 |
| Anritsu Corp. | MT8820C/Wideband Radio Communication Tester | 6201026545 | 02/16/2016 | Annual | 02/16/2017 |

5. MEASUREMENT UNCERTAINTY

The measurement uncertainties shown below were calculated in accordance with the requirements of ANSI C63.4:2014.

All measurement uncertainty values are shown with a coverage factor of $k = 2$ to indicate a 95 % level of confidence.

| Parameter | Expanded Uncertainty (\pmdB) |
|--|--|
| Conducted Disturbance (150 kHz ~ 30 MHz) | 1.82 |
| Radiated Disturbance (9 kHz ~ 30 MHz) | 3.40 |
| Radiated Disturbance (30 MHz ~ 1 GHz) | 4.80 |
| Radiated Disturbance (1 GHz ~ 18 GHz) | 6.07 |

6. SUMMARY OF TEST RESULTS

| FCC Part Section(s) | Test Description | Test Limit | Test Condition | Test Result |
|----------------------------|--|--|----------------|-------------|
| 2.1049 | Occupied Bandwidth | N/A | CONDUCTED | PASS |
| 2.1051, 27.53(h), 27.53(c) | Band Edge / Spurious and Harmonic Emissions at Antenna Terminal. | < 43 + 10 log ₁₀ (P[Watts]) at Band Edge and for all-of-band emissions <65 + 10 log (P[Watts]) in a 6.25kHz bandwidth for emissions in the 777–787 MHz bands | | PASS |
| 27.50(d)(5) | Peak-Average Ratio | < 13 dB | | PASS |
| 2.1046 | * Conducted Output Power | N/A | | PASS |
| 2.1055, 27.54 | Frequency stability / variation of ambient temperature | Emission must remain in band | | PASS |
| 27.50(b)(10) | Effective Radiated Power (Band 13) | < 3 Watts max. ERP | RADIATED | PASS |
| 27.50(d)(4) | Equivalent Isotropic Radiated Power (Band 4) | < 1 Watts max. EIRP | | PASS |
| 2.1053, 27.53(h) | Undesirable Out-of-Band Emissions | < 43 + 10 log ₁₀ (P[Watts]) for all out-of-band emissions | | PASS |
| 2.1053, 27.53(f) | Undesirable Emissions in the 1559 – 1610 MHz band | < -70dBW/MHz EIRP (wideband) < -80dBW EIRP (narrowband) | | PASS |

Note regarding all Emission Mask test plots:

The FCC limit is $65 + 10\log_{10}(P_{\text{Watts}}) = -35 \text{ dBm}$ in a 6.25 kHz bandwidth. Since it was not possible to set the resolution bandwidth to 6.25 kHz with the available equipment, a bandwidth of 10 kHz was used instead to show compliance. By using a 10 kHz bandwidth, the limit was adjusted by $10\log_{10}(10 \text{ kHz}/6.25 \text{ kHz}) = 2.04 \text{ dB}$. Thus, the limit shown in all emission mask plots for all available modulation types was $-35 \text{ dBm} + 2.04 \text{ dB} = -32.96 \text{ dBm}$.

*: See SAR Report

7. SAMPLE CALCULATION

A. EIRP Sample Calculation

| Mode | Ch./ Freq. | | Measured Level(dBm) | Substitute LEVEL(dBm) | Ant. Gain (dBi) | C.L | Pol. | Limit W | EIRP | |
|-----------|------------|------------|---------------------|-----------------------|-----------------|------|------|---------|-------|-------|
| | channel | Freq.(MHz) | | | | | | | W | dBm |
| LTE Band4 | 20175 | 1,732.50 | -15.75 | 18.45 | 9.90 | 1.76 | H | < 1.00 | 0.456 | 26.59 |

EIRP = Substitute LEVEL(dBm) + Ant. Gain – CL(Cable Loss)

- 1) The EUT mounted on a wooden tripod is 2.5 meter above test site ground level.
- 2) During the test , the turn table is rotated and the antenna height is found.
- 3) Record the field strength meter's level.
- 4) Replace the EUT with dipole/Horn antenna that is connected to a calibrated signal generator.
- 5) Increase the signal generator output till the field strength meter's level is equal to the item (3).
- 6) The signal generator output level with Ant. Gain and cable loss are the rating of equivalent isotropic radiated power (EIRP).

B. Emission Designator

QPSK Modulation

Emission Designator = 4M48G7D

LTE BW = 4.48 MHz

G = Phase Modulation

7 = Quantized/Digital Info

D = Data transmission; telemetry; telecommand

16QAM Modulation

Emission Designator = 4M48W7D

LTE BW = 4.48 MHz

W = main carrier modulated in a combination of two

or more of the following modes;

amplitude, angle, pulse

7 = Quantized/Digital Info

D = Data transmission; telemetry; telecommand

8. TEST DATA

8.1 EQUIVALENT ISOTROPIC RADIATED POWER (Band 4)

| Freq (MHz) | Bandwidth | Modulation | Measured Level (dBm) | Substitute Level (dBm) | Ant. Gain(dBi) | C.L | Pol | Limit | EIRP | |
|------------|-----------|------------|----------------------|------------------------|----------------|------|-----|--------|-------|-------|
| | | | | | | | | W | W | dBm |
| 1712.5 | 5 MHz | QPSK | -22.12 | 11.22 | 9.37 | 2.45 | H | < 1.00 | 0.065 | 18.14 |
| | | 16-QAM | -22.82 | 10.52 | 9.37 | 2.45 | H | | 0.055 | 17.44 |
| 1732.5 | | QPSK | -23.92 | 9.40 | 9.44 | 2.47 | H | | 0.043 | 16.37 |
| | | 16-QAM | -24.74 | 8.58 | 9.44 | 2.47 | H | | 0.036 | 15.55 |
| 1752.5 | | QPSK | -22.45 | 10.87 | 9.51 | 2.47 | H | | 0.062 | 17.91 |
| | | 16-QAM | -23.25 | 10.07 | 9.51 | 2.47 | H | | 0.051 | 17.11 |

Equivalent Isotropic Radiated Power Data (5 MHz Band4 LTE)

Note: All of RB size has been tested for emissions and EIRP, with the 1RB configuration observed as the worst case

| Freq (MHz) | Bandwidth | Modulation | Measured Level (dBm) | Substitute Level (dBm) | Ant. Gain(dBi) | C.L | Pol | Limit | EIRP | |
|------------|-----------|------------|----------------------|------------------------|----------------|------|-----|--------|-------|-------|
| | | | | | | | | W | W | dBm |
| 1715.0 | 10 MHz | QPSK | -22.09 | 11.25 | 9.39 | 2.46 | H | < 1.00 | 0.066 | 18.18 |
| | | 16-QAM | -22.83 | 10.51 | 9.39 | 2.46 | H | | 0.055 | 17.44 |
| 1732.5 | | QPSK | -24.01 | 9.31 | 9.44 | 2.47 | H | | 0.042 | 16.28 |
| | | 16-QAM | -24.82 | 8.50 | 9.44 | 2.47 | H | | 0.035 | 15.47 |
| 1750.0 | | QPSK | -22.15 | 11.17 | 9.51 | 2.47 | H | | 0.066 | 18.21 |
| | | 16-QAM | -23.00 | 10.32 | 9.51 | 2.47 | H | | 0.054 | 17.36 |

Equivalent Isotropic Radiated Power Data (10 MHz Band4 LTE)

Note: All of RB size has been tested for emissions and EIRP, with the 1RB configuration observed as the worst case

| Freq (MHz) | Bandwidth | Modulation | Measured Level (dBm) | Substitute Level (dBm) | Ant. Gain(dBi) | C.L | Pol | Limit | EIRP | |
|------------|-----------|------------|----------------------|------------------------|----------------|------|-----|--------|-------|-------|
| | | | | | | | | W | W | dBm |
| 1717.5 | 15 MHz | QPSK | -21.56 | 11.78 | 9.40 | 2.47 | H | < 1.00 | 0.074 | 18.71 |
| | | 16-QAM | -22.39 | 10.95 | 9.40 | 2.47 | H | | 0.061 | 17.88 |
| 1732.5 | | QPSK | -23.18 | 10.14 | 9.44 | 2.47 | H | | 0.051 | 17.11 |
| | | 16-QAM | -23.91 | 9.41 | 9.44 | 2.47 | H | | 0.043 | 16.38 |
| 1747.5 | | QPSK | -21.91 | 11.41 | 9.51 | 2.47 | H | | 0.070 | 18.45 |
| | | 16-QAM | -22.64 | 10.68 | 9.51 | 2.47 | H | | 0.059 | 17.72 |

Equivalent Isotropic Radiated Power Data (15 MHz Band4 LTE)

Note: All of RB size has been tested for emissions and EIRP, with the 1RB configuration observed as the worst case

| Freq (MHz) | Bandwidth | Modulation | Measured Level (dBm) | Substitute Level (dBm) | Ant. Gain(dBi) | C.L | Pol | Limit | EIRP | |
|------------|-----------|------------|----------------------|------------------------|----------------|------|-----|--------|-------|-------|
| | | | | | | | | W | W | dBm |
| 1720.0 | 20 MHz | QPSK | -21.55 | 11.79 | 9.40 | 2.47 | H | < 1.00 | 0.075 | 18.72 |
| | | 16-QAM | -22.36 | 10.98 | 9.40 | 2.47 | H | | 0.062 | 17.91 |
| 1732.5 | | QPSK | -22.86 | 10.46 | 9.44 | 2.47 | H | | 0.055 | 17.43 |
| | | 16-QAM | -23.58 | 9.74 | 9.44 | 2.47 | H | | 0.047 | 16.71 |
| 1745.0 | | QPSK | -22.58 | 10.78 | 9.49 | 2.47 | H | | 0.060 | 17.80 |
| | | 16-QAM | -23.33 | 10.03 | 9.49 | 2.47 | H | | 0.051 | 17.05 |

Equivalent Isotropic Radiated Power Data (20 MHz Band4 LTE)

Note: All of RB size has been tested for emissions and EIRP, with the 1RB configuration observed as the worst case

NOTES:

Equivalent Isotropic Radiated Power Measurements by Substitution Method

according to ANSI/TIA/EIA-603-D-2010 June 24, 2010:

The EUT was placed on a non-conductive styrofoam resin table 3-meters from the receive antenna. The receive antenna height and turntable rotation was adjusted for the highest reading on the receive spectrum analyzer. For LTE signals, RBW = 1-5% of the OBW, not to exceed 1MHz, VBW $\geq 3 \times$ RBW, Detector = RMS. A Horn antenna was substituted in place of the EUT. This Horn antenna was driven by a signal generator and the level of the signal generator was adjusted to obtain the same receive spectrum analyzer reading. The conducted power at the terminals of the Horn antenna is measured. The difference between the gain of the horn and an isotropic antenna is taken into consideration and the EIRP is recorded.

Also, we have done x, y, z planes in EUT and horizontal and vertical polarization in detecting antenna. The worst case of the EUT is x plane in LTE mode. Also worst case of detecting Antenna is horizontal polarization in LTE mode.

8.2 EFFECTIVE RADIATED POWER (Band 13)

| Freq (MHz) | Bandwidth | Modulation | Measured Level (dBm) | Substitute Level (dBm) | Ant. Gain(dBd) | C.L | Pol | Limit | ERP | |
|------------|-----------|------------|----------------------|------------------------|----------------|------|-----|--------|-------|-------|
| | | | | | | | | W | W | dBm |
| 779.5 | 5 MHz | QPSK | -31.21 | 30.16 | -10.58 | 1.63 | H | < 3.00 | 0.062 | 17.95 |
| | | 16-QAM | -31.95 | 29.42 | -10.58 | 1.63 | H | | 0.053 | 17.21 |
| 782.0 | | QPSK | -30.55 | 30.99 | -10.60 | 1.64 | H | | 0.075 | 18.75 |
| | | 16-QAM | -31.21 | 30.33 | -10.60 | 1.64 | H | | 0.064 | 18.09 |
| 784.5 | | QPSK | -31.29 | 30.46 | -10.61 | 1.64 | H | | 0.066 | 18.21 |
| | | 16-QAM | -32.01 | 29.74 | -10.61 | 1.64 | H | | 0.056 | 17.49 |

Effective Radiated Power Data (5 MHz Band 13 LTE)

Note: All of RB size has been tested for emissions and ERP, with the 1RB configuration observed as the worst case

| Freq (MHz) | Bandwidth | Modulation | Measured Level (dBm) | Substitute Level (dBm) | Ant. Gain(dBd) | C.L | Pol | Limit | ERP | |
|------------|-----------|------------|----------------------|------------------------|----------------|------|-----|--------|-------|-------|
| | | | | | | | | W | W | dBm |
| 782.0 | 10 MHz | QPSK | -31.45 | 30.09 | -10.60 | 1.64 | H | < 3.00 | 0.061 | 17.85 |
| | | 16-QAM | -32.18 | 29.36 | -10.60 | 1.64 | H | | 0.051 | 17.12 |

Effective Radiated Power Data (5 MHz Band 13 LTE)

Note: All of RB size has been tested for emissions and ERP, with the 1RB configuration observed as the worst case

NOTES:

Effective Radiated Power Output Measurements by Substitution Method

according to ANSI/TIA/EIA-603-D-2010 June 24, 2010:

The EUT was placed on a non-conductive styrofoam resin table 3-meters from the receive antenna. The receive antenna height and turntable rotation was adjusted for the highest reading on the receive spectrum analyzer. For LTE signals, RBW = 1-5% of the OBW, not to exceed 1MHz, VBW ≥ 3 x RBW, Detector = RMS. A half-wave dipole was substituted in place of the EUT. This dipole antenna was driven by a signal generator and the level of the signal generator was adjusted to obtain the same receive spectrum analyzer reading. The conducted power at the terminals of the dipole is measured. The ERP is recorded.

Also, we have done x, y, z planes in EUT and horizontal and vertical polarization in detecting antenna. The worst case of the EUT is y plane in LTE mode. Also worst case of detecting Antenna is horizontal polarization in LTE mode.

8.3 RADIATED SPURIOUS EMISSIONS

8.3.1 RADIATED SPURIOUS EMISSIONS (5 MHz Band 4 LTE)

- ▣ OPERATING FREQUENCY: 1712.5 MHz
- ▣ MEASURED OUTPUT POWER: 18.14 dBm = 0.065 W
- ▣ MODULATION SIGNAL: 5 MHz QPSK
- ▣ DISTANCE: 3 meters
- ▣ LIMIT: $43 + 10 \log_{10}(W) =$ 31.14 dBc

| Ch | Freq (MHz) | Measured Level (dBm) | Ant. Gain (dBi) | Substitute Level (dBm) | C.L | Pol | EIRP (dBm) | dBc |
|-------------------|------------|----------------------|-----------------|------------------------|------|-----|------------|-------|
| 19975 (1712.5) | 3,425.00 | -48.49 | 12.20 | -55.78 | 1.50 | V | -45.07 | 63.21 |
| | 5,137.50 | -52.11 | 12.77 | -52.94 | 2.50 | H | -42.67 | 60.81 |
| | 6,850.00 | -56.08 | 12.04 | -52.05 | 3.49 | H | -43.50 | 61.64 |
| 20175 (1732.5) | 3,465.00 | -48.73 | 12.28 | -55.62 | 1.49 | H | -44.83 | 62.97 |
| | 5,197.50 | -54.91 | 12.86 | -56.02 | 2.57 | H | -45.73 | 63.87 |
| | 6,930.00 | -56.86 | 11.87 | -52.26 | 3.53 | H | -43.92 | 62.06 |
| 20375 (1752.5) | 3,505.00 | -50.41 | 12.36 | -56.96 | 1.54 | V | -46.14 | 64.28 |
| | 5,257.50 | -52.75 | 12.95 | -54.54 | 2.63 | V | -44.22 | 62.36 |
| | 7,010.00 | -53.63 | 11.73 | -50.85 | 3.64 | H | -42.76 | 60.90 |

- NOTES:**
1. Radiated Spurious Emission Measurements at 3 meters by Substitution Method according to ANSI/TIA/EIA-603-D-2010 June 24, 2010:
 2. We are performed all frequency to 10th harmonics from 9 kHz. Measurements above show only up to 3 maximum emissions noted, or would be lesser if no specific emissions from the EUT are recorded (ie: margin > 20 dB from the applicable limit) and considered that's already beyond the background noise floor.
 3. We have done x, y, z planes in EUT and horizontal and vertical polarization in detecting antenna.
 4. All of RB size has been tested for emissions and EIRP, with the 1RB configuration observed as the worst case
 5. We are performed 16QAM and QPSK modulations. The worst case data are reported in the table above.

8.3.2 RADIATED SPURIOUS EMISSIONS (10 MHz Band 4 LTE)

- ▣ OPERATING FREQUENCY: 1750.00 MHz
- ▣ MEASURED OUTPUT POWER: 18.21 dBm = 0.066 W
- ▣ MODULATION SIGNAL: 10 MHz QPSK
- ▣ DISTANCE: 3 meters
- ▣ LIMIT: $43 + 10 \log_{10}(W) =$ 31.21 dBc

| Ch | Freq (MHz) | Measured Level (dBm) | Ant. Gain (dBi) | Substitute Level (dBm) | C.L | Pol | EIRP (dBm) | dBc |
|-------------------|------------|----------------------|-----------------|------------------------|------|-----|------------|-------|
| 20000 (1715.0) | 3,430.00 | -42.90 | 12.21 | -50.30 | 1.50 | H | -39.59 | 57.80 |
| | 5,145.00 | -51.23 | 12.78 | -51.99 | 2.51 | H | -41.72 | 59.93 |
| | 6,860.00 | -54.18 | 12.01 | -50.10 | 3.49 | H | -41.58 | 59.79 |
| 20175 (1732.5) | 3,465.00 | -40.22 | 12.28 | -47.11 | 1.49 | H | -36.32 | 54.53 |
| | 5,197.50 | -52.94 | 12.86 | -54.05 | 2.57 | H | -43.76 | 61.97 |
| | 6,930.00 | -56.49 | 11.87 | -51.89 | 3.53 | V | -43.55 | 61.76 |
| 20350 (1750.0) | 3,500.00 | -40.23 | 12.35 | -46.88 | 1.55 | V | -36.08 | 54.29 |
| | 5,250.00 | -50.12 | 12.93 | -51.93 | 2.63 | H | -41.63 | 59.84 |
| | 7,000.00 | -54.27 | 11.73 | -52.14 | 3.63 | H | -44.04 | 62.25 |

- NOTES:**
1. Radiated Spurious Emission Measurements at 3 meters by Substitution Method according to ANSI/TIA/EIA-603-D-2010 June 24, 2010:
 2. We are performed all frequency to 10th harmonics from 9 kHz. Measurements above show only up to 3 maximum emissions noted, or would be lesser if no specific emissions from the EUT are recorded (ie: margin > 20 dB from the applicable limit) and considered that's already beyond the background noise floor.
 3. We have done x, y, z planes in EUT and horizontal and vertical polarization in detecting antenna.
 4. All of RB size has been tested for emissions and EIRP, with the 1RB configuration observed as the worst case
 5. We are performed 16QAM and QPSK modulations. The worst case data are reported in the table above.

8.3.3 RADIATED SPURIOUS EMISSIONS (15 MHz Band 4 LTE)

- ▣ OPERATING FREQUENCY: 1717.50 MHz
- ▣ MEASURED OUTPUT POWER: 18.71 dBm = 0.074 W
- ▣ MODULATION SIGNAL: 15 MHz QPSK
- ▣ DISTANCE: 3 meters
- ▣ LIMIT: $43 + 10 \log_{10}(W) =$ 31.71 dBc

| Ch | Freq (MHz) | Measured Level (dBm) | Ant. Gain (dBi) | Substitute Level (dBm) | C.L | Pol | EIRP (dBm) | dBc |
|-------------------|------------|----------------------|-----------------|------------------------|------|-----|------------|-------|
| 20025 (1717.5) | 3,435.00 | -48.30 | 12.22 | -55.55 | 1.51 | V | -44.84 | 63.55 |
| | 5,152.50 | -52.10 | 12.79 | -52.79 | 2.52 | H | -42.52 | 61.23 |
| | 6,870.00 | -54.71 | 11.99 | -50.95 | 3.44 | V | -42.40 | 61.11 |
| 20175 (1732.5) | 3,465.00 | -48.42 | 12.28 | -55.31 | 1.49 | V | -44.52 | 63.23 |
| | 5,197.50 | -52.77 | 12.86 | -53.88 | 2.57 | H | -43.59 | 62.30 |
| | 6,930.00 | -56.10 | 11.87 | -51.50 | 3.53 | V | -43.16 | 61.87 |
| 20325 (1747.5) | 3,495.00 | -49.56 | 12.34 | -56.17 | 1.54 | V | -45.37 | 64.08 |
| | 5,242.50 | -51.48 | 12.92 | -52.94 | 2.60 | H | -42.62 | 61.33 |
| | 6,990.00 | -56.06 | 11.75 | -51.12 | 3.52 | V | -42.89 | 61.60 |

- NOTES:**
1. Radiated Spurious Emission Measurements at 3 meters by Substitution Method according to ANSI/TIA/EIA-603-D-2010 June 24, 2010:
 2. We are performed all frequency to 10th harmonics from 9 kHz. Measurements above show only up to 3 maximum emissions noted, or would be lesser if no specific emissions from the EUT are recorded (ie: margin > 20 dB from the applicable limit) and considered that's already beyond the background noise floor.
 3. We have done x, y, z planes in EUT and horizontal and vertical polarization in detecting antenna.
 4. All of RB size has been tested for emissions and EIRP, with the 1RB configuration observed as the worst case
 5. We are performed 16QAM and QPSK modulations. The worst case data are reported in the table above.

8.3.4 RADIATED SPURIOUS EMISSIONS (20 MHz Band 4 LTE)

- ▣ OPERATING FREQUENCY: 1720.00 MHz
- ▣ MEASURED OUTPUT POWER: 18.72 dBm = 0.075 W
- ▣ MODULATION SIGNAL: 20 MHz QPSK
- ▣ DISTANCE: 3 meters
- ▣ LIMIT: $43 + 10 \log_{10}(W) =$ 31.72 dBc

| Ch | Freq (MHz) | Measured Level (dBm) | Ant. Gain (dBi) | Substitute Level (dBm) | C.L | Pol | EIRP (dBm) | dBc |
|-------------------|------------|----------------------|-----------------|------------------------|------|-----|------------|-------|
| 20050 (1720.0) | 3,440.00 | -48.61 | 12.23 | -55.72 | 1.52 | H | -45.01 | 63.73 |
| | 5,160.00 | -48.65 | 12.80 | -49.68 | 2.53 | H | -39.41 | 58.13 |
| | 6,880.00 | -55.21 | 11.97 | -51.28 | 3.46 | H | -42.77 | 61.49 |
| 20175 (1732.5) | 3,465.00 | -48.84 | 12.28 | -55.73 | 1.49 | H | -44.94 | 63.66 |
| | 5,197.50 | -53.12 | 12.86 | -54.23 | 2.57 | H | -43.94 | 62.66 |
| | 6,930.00 | -56.02 | 11.87 | -51.42 | 3.53 | H | -43.08 | 61.80 |
| 20300 (1745.0) | 3,490.00 | -48.85 | 12.33 | -55.42 | 1.53 | H | -44.62 | 63.34 |
| | 5,235.00 | -51.37 | 12.91 | -52.90 | 2.59 | H | -42.58 | 61.30 |
| | 6,980.00 | -55.63 | 11.77 | -50.56 | 3.50 | H | -42.29 | 61.01 |

- NOTES:**
1. Radiated Spurious Emission Measurements at 3 meters by Substitution Method according to ANSI/TIA/EIA-603-D-2010 June 24, 2010:
 2. We are performed all frequency to 10th harmonics from 9 kHz. Measurements above show only up to 3 maximum emissions noted, or would be lesser if no specific emissions from the EUT are recorded (ie: margin > 20 dB from the applicable limit) and considered that's already beyond the background noise floor.
 3. We have done x, y, z planes in EUT and horizontal and vertical polarization in detecting antenna.
 4. All of RB size has been tested for emissions and EIRP, with the 1RB configuration observed as the worst case
 5. We are performed 16QAM and QPSK modulations. The worst case data are reported in the table above.

8.3.5 RADIATED SPURIOUS EMISSIONS (5 MHz Band 13 LTE)

- ▣ OPERATING FREQUENCY: 782.00 MHz
- ▣ MEASURED OUTPUT POWER: 18.75 dBm = 0.075 W
- ▣ MODULATION SIGNAL: 5 MHz QPSK
- ▣ DISTANCE: 3 meters
- ▣ LIMIT: $43 + 10 \log_{10}(W) =$ 31.75 dBc

| Ch | Freq (MHz) | Measured Level (dBm) | Ant. Gain (dBd) | Substitute Level (dBm) | C.L | Pol | ERP (dBm) | dBc |
|------------------|------------|----------------------|-----------------|------------------------|------|-----|-----------|-------|
| 23205 (779.5) | 1,559.00 | -49.94 | 8.82 | -54.89 | 1.18 | H | -47.25 | 66.00 |
| | 2,338.50 | -52.68 | 10.77 | -58.18 | 1.17 | V | -48.58 | 67.33 |
| | 3,118.00 | -55.20 | 11.54 | -60.03 | 1.36 | V | -49.85 | 68.60 |
| | 3,897.50 | -55.24 | 12.66 | -58.95 | 1.75 | H | -48.04 | 66.79 |
| | 4,677.00 | -52.11 | 12.68 | -55.31 | 2.28 | H | -44.91 | 63.66 |
| 23230 (782.0) | 1,564.00 | -52.51 | 8.84 | -57.51 | 1.18 | H | -49.85 | 68.60 |
| | 2,346.00 | -52.96 | 10.78 | -58.49 | 1.17 | H | -48.88 | 67.63 |
| | 3,128.00 | -55.05 | 11.56 | -59.80 | 1.38 | H | -49.62 | 68.37 |
| | 3,910.00 | -55.20 | 12.67 | -58.93 | 1.72 | H | -47.98 | 66.73 |
| | 4,692.00 | -51.37 | 12.68 | -54.54 | 2.29 | V | -44.15 | 62.90 |
| 23255 (784.5) | 1,569.00 | -51.73 | 8.86 | -56.79 | 1.18 | V | -49.11 | 67.86 |
| | 2,353.50 | -52.27 | 10.78 | -57.77 | 1.17 | H | -48.16 | 66.91 |
| | 3,138.00 | -55.77 | 11.59 | -60.59 | 1.39 | V | -50.39 | 69.14 |
| | 3,922.50 | -55.34 | 12.67 | -58.92 | 1.72 | H | -47.97 | 66.72 |
| | 4,707.00 | -53.88 | 12.67 | -56.86 | 2.32 | H | -46.51 | 65.26 |

- NOTES:**
1. Radiated Spurious Emission Measurements at 3 meters by Substitution Method according to ANSI/TIA/EIA-603-D-2010 June 24, 2010:
 2. We are performed all frequency to 10th harmonics from 9 kHz. Measurements above show only up to 3 maximum emissions noted, or would be lesser if no specific emissions from the EUT are recorded (ie: margin > 20 dB from the applicable limit) and considered that's already beyond the background noise floor.
 3. We have done x, y, z planes in EUT and horizontal and vertical polarization in detecting antenna.
 4. All of RB size has been tested for emissions and ERP, with the 1RB configuration observed as the worst case
 5. We are performed 16QAM and QPSK modulations. The worst case data are reported in the table above.

8.3.6 RADIATED SPURIOUS EMISSIONS (10 MHz Band 13 LTE)

- ▣ OPERATING FREQUENCY: 782.00 MHz
- ▣ MEASURED OUTPUT POWER: 17.85 dBm = 0.061 W
- ▣ MODULATION SIGNAL: 10 MHz QPSK
- ▣ DISTANCE: 3 meters
- ▣ LIMIT: $43 + 10 \log_{10}(W) =$ 30.85 dBc

| Ch | Freq (MHz) | Measured Level (dBm) | Ant. Gain (dBd) | Substitute Level (dBm) | C.L | Pol | ERP (dBm) | dBc |
|-------------------|------------|----------------------|-----------------|------------------------|------|-----|-----------|-------|
| 23230 (782.00) | 1,564.00 | -49.26 | 8.84 | -59.35 | 1.18 | H | -51.69 | 69.54 |
| | 2,346.00 | -54.74 | 10.78 | -61.69 | 1.17 | V | -52.08 | 69.93 |
| | 3,128.00 | -54.85 | 11.56 | -60.95 | 1.38 | H | -50.77 | 68.62 |
| | 3,910.00 | -55.68 | 12.67 | -61.20 | 1.72 | H | -50.25 | 68.10 |
| | 4,692.00 | -55.43 | 12.68 | -58.60 | 2.29 | V | -48.21 | 66.06 |

- NOTES:**
1. Radiated Spurious Emission Measurements at 3 meters by Substitution Method according to ANSI/TIA/EIA-603-D-2010 June 24, 2010:
 2. We are performed all frequency to 10th harmonics from 9 kHz. Measurements above show only up to 3 maximum emissions noted, or would be lesser if no specific emissions from the EUT are recorded (ie: margin > 20 dB from the applicable limit) and considered that's already beyond the background noise floor.
 3. We have done x, y, z planes in EUT and horizontal and vertical polarization in detecting antenna.
 4. All of RB size has been tested for emissions and ERP, with the 1RB configuration observed as the worst case
 5. We are performed 16QAM and QPSK modulations. The worst case data are reported in the table above.

8.3.6.1 RADIATED SPURIOUS EMISSIONS (1559 ~ 1610 MHz Band)

- ▣ OPERATING FREQUENCY: 779.5 MHz, 782.0 MHz, 784.5 MHz
- ▣ MEASURED OUTPUT POWER: 5 MHz QPSK
- ▣ DISTANCE: 3 meters
- ▣ WIDEBAND EMISSION LIMIT: -70 dBW/ MHz (= -40 dBm/ MHz)

| Operating Frequency (MHz) | Measured Frequency (MHz) | EMISSION TYPE | Measured Level (dBm) | Ant. Gain (dBd) | Substitute Level (dBm) | C.L | Pol | ERP (dBm) | MARGIN (dB) |
|---------------------------|--------------------------|---------------|----------------------|-----------------|------------------------|------|-----|-----------|-------------|
| 779.5 | 1,580.0 | WIDEBAND | -54.57 | 8.90 | -64.74 | 1.18 | H | -57.02 | 17.02 |
| 782.0 | 1,559.7 | | -50.55 | 8.82 | -60.64 | 1.18 | H | -53.00 | 13.00 |
| 784.5 | 1,564.6 | | -50.51 | 8.84 | -60.60 | 1.18 | H | -52.94 | 12.94 |

8.3.6.2 RADIATED SPURIOUS EMISSIONS (1559 ~ 1610 MHz Band)

- ▣ OPERATING FREQUENCY: 782.00 MHz
- ▣ MEASURED OUTPUT POWER: 10 MHz QPSK
- ▣ DISTANCE: 3 meters
- ▣ WIDEBAND EMISSION LIMIT: -70 dBW/ MHz (= -40 dBm/ MHz)

| Operating Frequency (MHz) | Measured Frequency (MHz) | EMISSION TYPE | Measured Level (dBm) | Ant. Gain (dBd) | Substitute Level (dBm) | C.L | Pol | ERP (dBm) | MARGIN (dB) |
|---------------------------|--------------------------|---------------|----------------------|-----------------|------------------------|------|-----|-----------|-------------|
| 782.0 | 1,603.0 | WIDEBAND | -54.43 | 8.99 | -64.87 | 1.18 | V | -57.06 | 17.06 |

8.4 PEAK-TO-AVERAGE RATIO

| Band | Band Width | Frequency (MHz) | Modulation | Resource Block Size | Resource Block Offset | Data (dB) |
|------|------------|-----------------|------------|---------------------|-----------------------|------------|
| 4 | 5 MHz | 1732.5 | QPSK | 25 | 0 | 5.45 |
| | | | 16-QAM | 25 | | 6.14 |
| | 10 MHz | | QPSK | 50 | | 5.39 |
| | | | 16-QAM | 50 | | 6.06 |
| | 15 MHz | | QPSK | 75 | | 5.33 |
| | | | 16-QAM | 75 | | 6.03 |
| | 20 MHz | | QPSK | 100 | | 5.37 |
| | | | 16-QAM | 100 | | 6.05 |

- Plots of the EUT's Peak- to- Average Ratio are shown Page 47~ 50.

8.5 OCCUPIED BANDWIDTH

| Band | Band Width | Frequency (MHz) | Modulation | Resource Block Size | Resource Block Offset | Data (MHz) |
|------|------------|-----------------|------------|---------------------|-----------------------|--------------|
| 4 | 5 MHz | 1732.5 | QPSK | 25 | 0 | 4.5591 |
| | | | 16-QAM | 25 | | 4.5618 |
| | 10 MHz | | QPSK | 50 | | 9.0575 |
| | | | 16-QAM | 50 | | 9.0180 |
| | 15 MHz | | QPSK | 75 | | 13.554 |
| | | | 16-QAM | 75 | | 13.558 |
| | 20 MHz | | QPSK | 100 | | 18.042 |
| | | | 16-QAM | 100 | | 18.115 |

| Band | Band Width | Frequency (MHz) | Modulation | Resource Block Size | Resource Block Offset | Data (MHz) |
|------|------------|-----------------|------------|---------------------|-----------------------|--------------|
| 13 | 5 MHz | 782.0 | QPSK | 25 | 0 | 4.5424 |
| | | | 16-QAM | 25 | 0 | 4.5814 |
| | 10 MHz | | QPSK | 50 | 0 | 9.0575 |
| | | | 16-QAM | 50 | 0 | 9.0537 |

- Plots of the EUT's Occupied Bandwidth are shown Page 41 ~ 46.

8.6 CONDUCTED SPURIOUS EMISSIONS

■FACTORS FOR FREQUENCY

| Frequency Range (GHz) | Factor [dB] |
|-----------------------|-------------|
| 0.03 – 1 | 27.145 |
| 1 – 5 | 26.960 |
| 5 – 10 | 27.542 |
| 10 – 15 | 28.439 |
| 15 – 20 | 29.144 |
| Above 20 | 30.148 |

NOTES:

Factor(dB) = Cable Loss + Attenuator +Power Splitter

| Band | Band Width (MHz) | Frequency (MHz) | Frequency of Maximum Harmonic (GHz) | Factor (dB) | Measurement Maximum Data (dBm) | Result (dBm) | Limit (dBm) |
|------|------------------|-----------------|-------------------------------------|-------------|--------------------------------|--------------|-------------|
| 4 | 5 | 1712.5 | 18.9615 | 29.144 | -62.28 | -33.136 | -13.00 |
| | | 1732.5 | 18.9085 | 29.144 | -62.58 | -33.436 | |
| | | 1752.5 | 18.9285 | 29.144 | -62.64 | -33.496 | |
| | 10 | 1715.0 | 18.9090 | 29.144 | -62.49 | -33.346 | |
| | | 1732.5 | 18.9075 | 29.144 | -62.38 | -33.236 | |
| | | 1750.0 | 18.9790 | 29.144 | -62.75 | -33.606 | |
| | 15 | 1717.5 | 18.9240 | 29.144 | -62.31 | -33.166 | |
| | | 1732.5 | 18.9095 | 29.144 | -62.39 | -33.246 | |
| | | 1747.5 | 18.9200 | 29.144 | -62.81 | -33.666 | |
| | 20 | 1720.0 | 18.9220 | 29.144 | -62.64 | -33.496 | |
| | | 1732.5 | 18.9010 | 29.144 | -62.11 | -32.966 | |
| | | 1745.0 | 18.9500 | 29.144 | -62.00 | -32.856 | |

| Band | Band Width (MHz) | Frequency (MHz) | Frequency of Maximum Harmonic (GHz) | Factor (dB) | Measurement Maximum Data (dBm) | Result (dBm) | Limit (dBm) |
|------|------------------|-----------------|-------------------------------------|-------------|--------------------------------|--------------|-------------|
| 13 | 5 | 779.5 | 3.70879 | 26.960 | -67.334 | -40.374 | -13.00 |
| | | 782.0 | 3.71128 | 26.960 | -67.170 | -40.210 | |
| | | 784.5 | 3.69811 | 26.960 | -67.350 | -40.390 | |
| | 10 | 782.0 | 3.69761 | 26.960 | -67.260 | -40.300 | |

NOTES:

1. Conducted Spurious Emissions was Tested QPSK Modulation, Resource Block Size 1 and Resource Block Offset 0
2. Result (dBm) = Measurement Maximum Data (dBm) + Factor (dB)

- Plots of the EUT's Conducted Spurious Emissions are shown Page 68 ~ 84.

8.6.1 BAND EDGE

- Plots of the EUT's Band Edge are shown Page 51 ~ 68.

8.7 FREQUENCY STABILITY / VARIATION OF AMBIENT TEMPERATURE

8.7.1 FREQUENCY STABILITY (5 MHz Band 4 LTE)

- OPERATING FREQUENCY: 1732,500,000 Hz
- CHANNEL: 20175 (5 MHz)
- REFERENCE VOLTAGE: 3.8 VDC
- DEVIATION LIMIT: Emission must remain in band

| Voltage (%) | Power (VDC) | Temp. (°C) | Frequency (Hz) | Frequency Error (Hz) | Deviation (%) | ppm |
|----------------|-------------|------------|----------------|----------------------|---------------|--------|
| 100% | 3.8 | +20(Ref) | 1732 500 006 | 0.0 | 0.000 000 | 0.000 |
| 100% | | -30 | 1732 500 000 | -5.7 | 0.000 000 | -0.003 |
| 100% | | -20 | 1732 499 994 | -12.2 | -0.000 001 | -0.007 |
| 100% | | -10 | 1732 500 017 | 11.0 | 0.000 001 | 0.006 |
| 100% | | 0 | 1732 499 998 | -7.7 | 0.000 000 | -0.004 |
| 100% | | +10 | 1732 499 998 | -8.0 | 0.000 000 | -0.005 |
| 100% | | +30 | 1732 499 997 | -8.9 | -0.000 001 | -0.005 |
| 100% | | +40 | 1732 499 995 | -10.5 | -0.000 001 | -0.006 |
| 100% | | +50 | 1732 499 998 | -8.4 | 0.000 000 | -0.005 |
| Batt. Endpoint | 3.5 | +20 | 1732 500 016 | 9.8 | 0.000 001 | 0.006 |

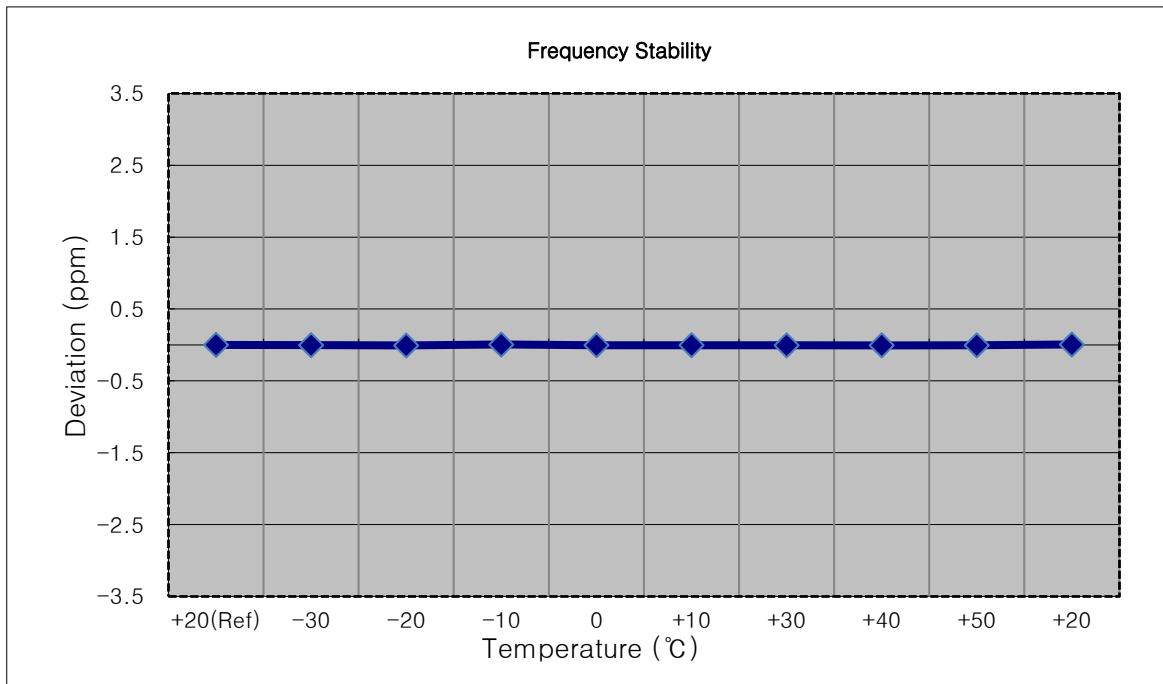

8.7.1 FREQUENCY STABILITY (10 MHz Band 4 LTE)

- OPERATING FREQUENCY: 1732,500,000 Hz
- CHANNEL: 20175 (10 MHz)
- REFERENCE VOLTAGE: 3.8 VDC
- DEVIATION LIMIT: Emission must remain in band

| Voltage (%) | Power (VDC) | Temp. (°C) | Frequency (Hz) | Frequency Error (Hz) | Deviation (%) | ppm |
|----------------|-------------|------------|----------------|----------------------|---------------|--------|
| 100% | 3.8 | +20(Ref) | 1732 500 007 | 0.0 | 0.000 000 | 0.000 |
| 100% | | -30 | 1732 500 021 | 14.3 | 0.000 001 | 0.008 |
| 100% | | -20 | 1732 500 016 | 9.3 | 0.000 001 | 0.005 |
| 100% | | -10 | 1732 500 011 | 3.6 | 0.000 000 | 0.002 |
| 100% | | 0 | 1732 500 014 | 6.5 | 0.000 000 | 0.004 |
| 100% | | +10 | 1732 500 000 | -7.2 | 0.000 000 | -0.004 |
| 100% | | +30 | 1732 500 016 | 9.0 | 0.000 001 | 0.005 |
| 100% | | +40 | 1732 500 000 | -6.6 | 0.000 000 | -0.004 |
| 100% | | +50 | 1732 500 019 | 12.3 | 0.000 001 | 0.007 |
| Batt. Endpoint | 3.5 | +20 | 1732 500 016 | 8.7 | 0.000 001 | 0.005 |

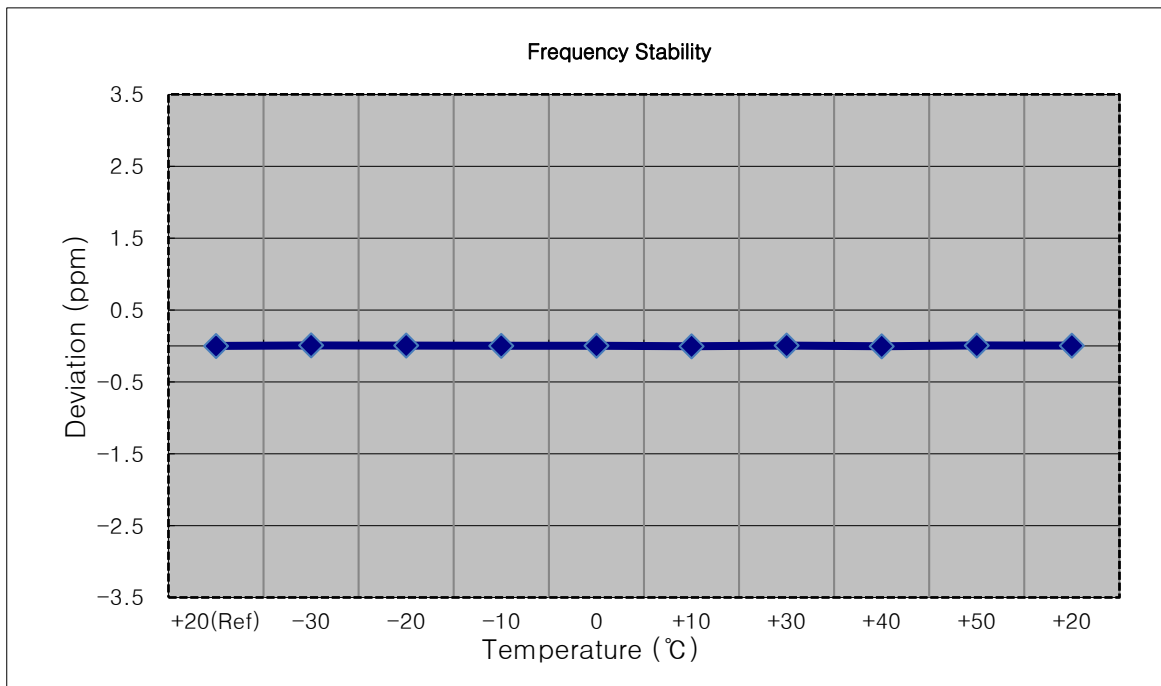

8.7.2 FREQUENCY STABILITY (15 MHz Band 4 LTE)

- OPERATING FREQUENCY: 1732,500,000 Hz
- CHANNEL: 20175 (15 MHz)
- REFERENCE VOLTAGE: 3.8 VDC
- DEVIATION LIMIT: Emission must remain in band

| Voltage (%) | Power (VDC) | Temp. (°C) | Frequency (Hz) | Frequency Error (Hz) | Deviation (%) | ppm |
|----------------|-------------|------------|----------------|----------------------|---------------|--------|
| 100% | 3.8 | +20(Ref) | 1732 499 994 | 0.0 | 0.000 000 | 0.000 |
| 100% | | -30 | 1732 500 005 | 11.5 | 0.000 001 | 0.007 |
| 100% | | -20 | 1732 500 000 | 6.4 | 0.000 000 | 0.004 |
| 100% | | -10 | 1732 500 001 | 7.0 | 0.000 000 | 0.004 |
| 100% | | 0 | 1732 500 002 | 7.9 | 0.000 000 | 0.005 |
| 100% | | +10 | 1732 499 984 | -10.1 | -0.000 001 | -0.006 |
| 100% | | +30 | 1732 500 008 | 13.6 | 0.000 001 | 0.008 |
| 100% | | +40 | 1732 500 003 | 8.8 | 0.000 001 | 0.005 |
| 100% | | +50 | 1732 500 008 | 14.0 | 0.000 001 | 0.008 |
| Batt. Endpoint | 3.5 | +20 | 1732 499 989 | -4.6 | 0.000 000 | -0.003 |

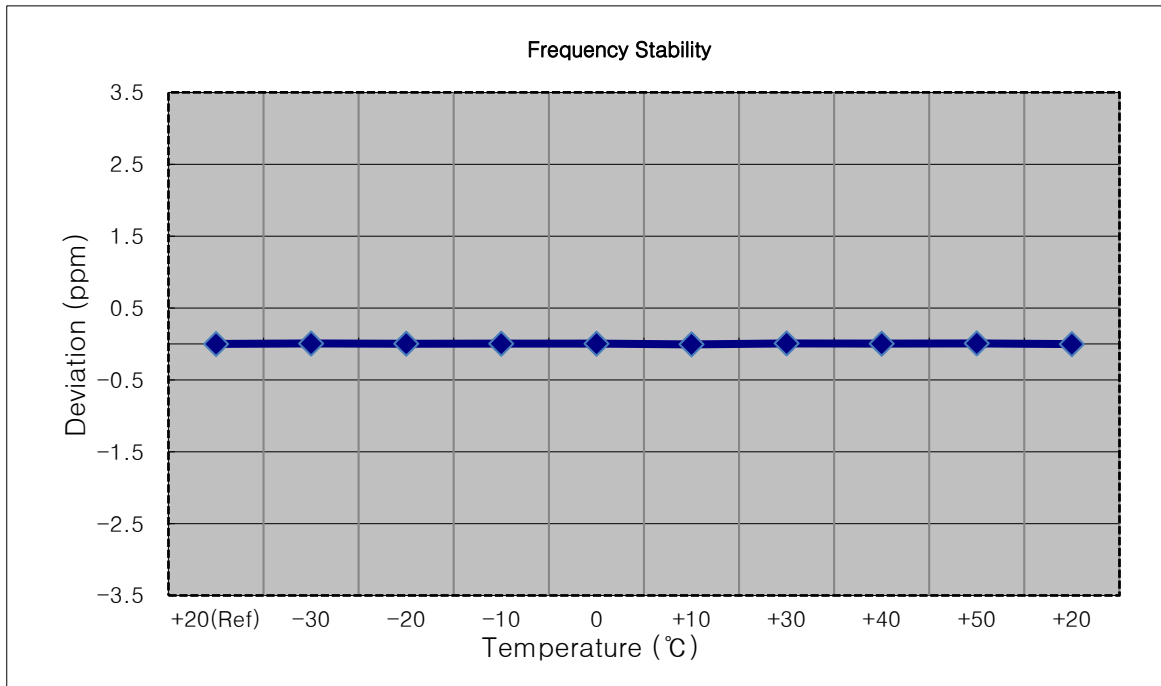

8.7.3 FREQUENCY STABILITY (20 MHz Band 4 LTE)

- OPERATING FREQUENCY: 1732,500,000 Hz
- CHANNEL: 20175 (20 MHz)
- REFERENCE VOLTAGE: 3.8 VDC
- DEVIATION LIMIT: Emission must remain in band

| Voltage (%) | Power (VDC) | Temp. (°C) | Frequency (Hz) | Frequency Error (Hz) | Deviation (%) | ppm |
|----------------|-------------|------------|----------------|----------------------|---------------|-----------|
| 100% | 3.8 | +20(Ref) | 1732 499 990 | 0.0 | 0.000 000 | 0.000 |
| 100% | | -30 | 1732 499 999 | 8.7 | 0.000 001 | 0.005 |
| 100% | | -20 | 1732 499 997 | 6.4 | 0.000 000 | 0.004 |
| 100% | | -10 | 1732 500 001 | 11.2 | 0.000 001 | 0.006 |
| 100% | | 0 | 1732 499 999 | 8.7 | 0.000 001 | 0.005 |
| 100% | | +10 | 1732 500 001 | 11.0 | 0.000 001 | 0.006 |
| 100% | | +30 | 1732 500 003 | 13.3 | 0.000 001 | 0.008 |
| 100% | | +40 | 1732 499 997 | 7.1 | 0.000 000 | 0.004 |
| 100% | | +50 | 1732 500 000 | 10.3 | 0.000 001 | 0.006 |
| Batt. Endpoint | | 3.5 | +20 | 1732 500 002 | 11.8 | 0.000 001 |

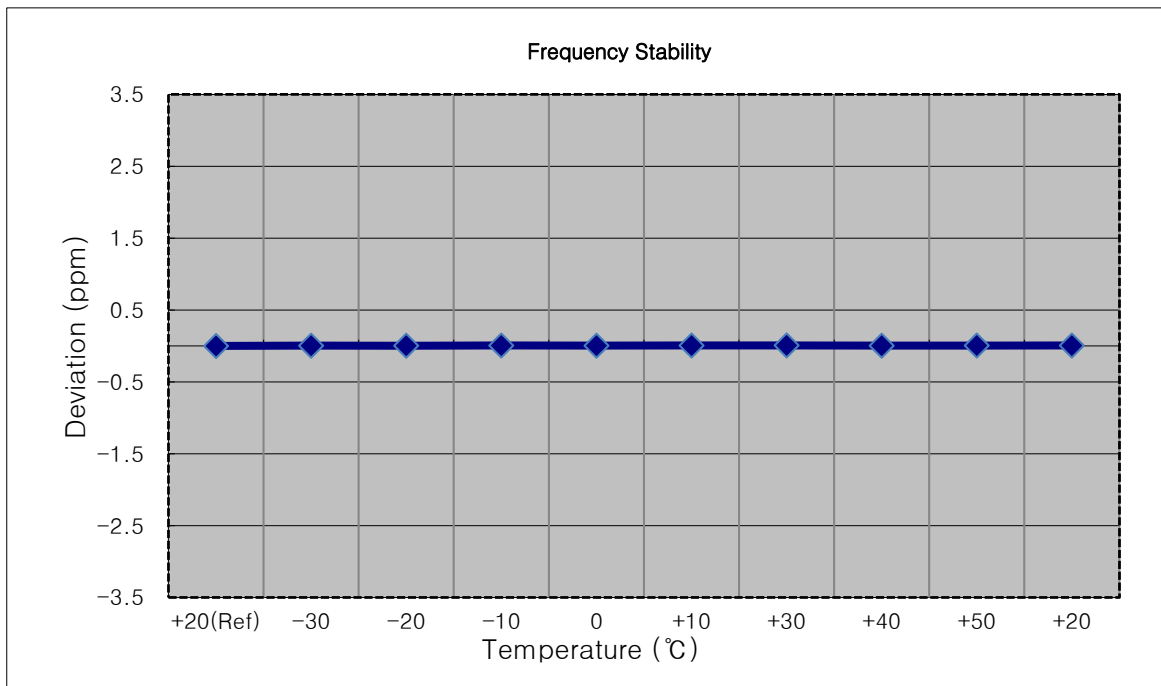

8.7.4 FREQUENCY STABILITY (5 MHz Band 13 LTE)

- ▣ OPERATING FREQUENCY: 782,000,000 Hz
- ▣ CHANNEL: 23230 (5 MHz)
- ▣ REFERENCE VOLTAGE: 3.8 VDC
- ▣ DEVIATION LIMIT: Emission must remain in band

| Voltage (%) | Power (VDC) | Temp. (°C) | Frequency (Hz) | Frequency Error (Hz) | Deviation (%) | ppm |
|----------------|-------------|------------|----------------|----------------------|---------------|--------|
| 100% | 3.8 | +20(Ref) | 782 000 008 | 0.00 | 0.000 000 | 0.0000 |
| 100% | | -30 | 782 000 018 | 9.90 | 0.000 001 | 0.0127 |
| 100% | | -20 | 782 000 016 | 7.90 | 0.000 001 | 0.0101 |
| 100% | | -10 | 782 000 015 | 7.00 | 0.000 001 | 0.0090 |
| 100% | | 0 | 782 000 019 | 11.20 | 0.000 001 | 0.0143 |
| 100% | | +10 | 782 000 017 | 8.80 | 0.000 001 | 0.0113 |
| 100% | | +30 | 782 000 016 | 8.10 | 0.000 001 | 0.0104 |
| 100% | | +40 | 782 000 015 | 7.50 | 0.000 001 | 0.0096 |
| 100% | | +50 | 782 000 019 | 11.30 | 0.000 001 | 0.0145 |
| Batt. Endpoint | 3.5 | +20 | 782 000 017 | 8.60 | 0.000 001 | 0.0110 |

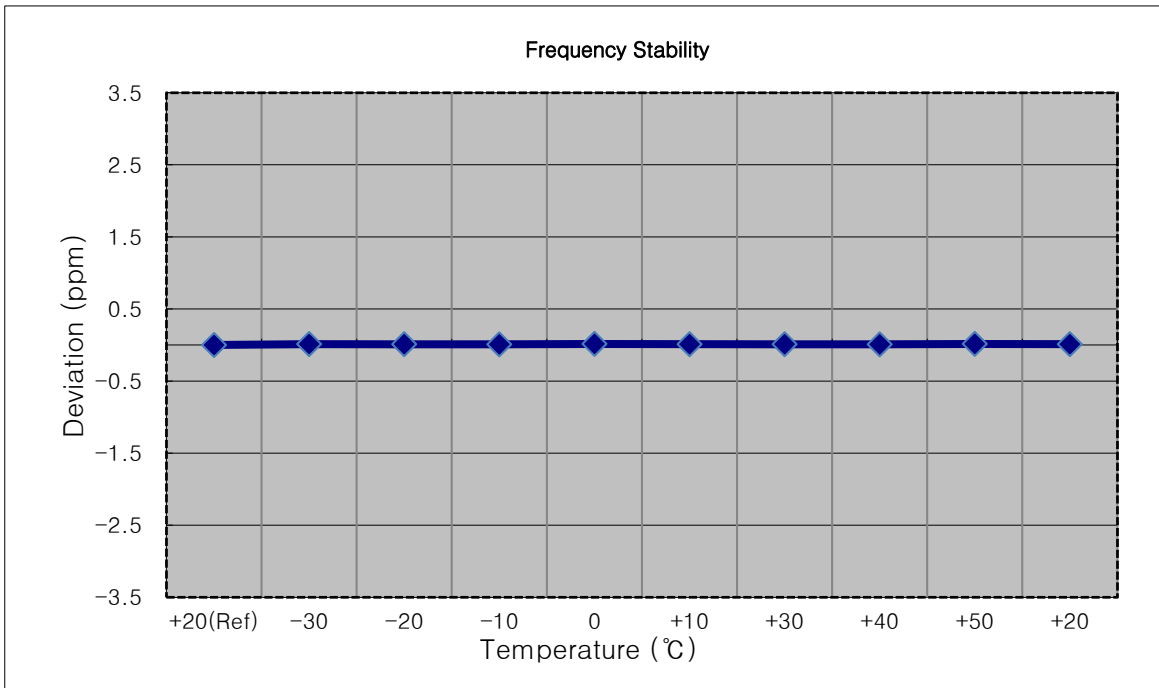

8.7.5 FREQUENCY STABILITY (10 MHz Band 13 LTE)

- ▣ OPERATING FREQUENCY: 782,000,000 Hz
- ▣ CHANNEL: 23230 (10 MHz)
- ▣ REFERENCE VOLTAGE: 3.8 VDC
- ▣ DEVIATION LIMIT: Emission must remain in band

| Voltage (%) | Power (VDC) | Temp. (°C) | Frequency (Hz) | Frequency Error (Hz) | Deviation (%) | ppm |
|----------------|-------------|------------|----------------|----------------------|---------------|-----------|
| 100% | 3.8 | +20(Ref) | 782 000 037 | 0.00 | 0.000 000 | 0.0000 |
| 100% | | -30 | 782 000 067 | 30.30 | 0.000 004 | 0.0387 |
| 100% | | -20 | 782 000 066 | 28.80 | 0.000 004 | 0.0368 |
| 100% | | -10 | 782 000 062 | 25.00 | 0.000 003 | 0.0320 |
| 100% | | 0 | 782 000 069 | 32.40 | 0.000 004 | 0.0414 |
| 100% | | +10 | 782 000 068 | 30.90 | 0.000 004 | 0.0395 |
| 100% | | +30 | 782 000 067 | 30.40 | 0.000 004 | 0.0389 |
| 100% | | +40 | 782 000 065 | 28.20 | 0.000 004 | 0.0361 |
| 100% | | +50 | 782 000 069 | 32.50 | 0.000 004 | 0.0416 |
| Batt. Endpoint | | 3.5 | +20 | 782 000 067 | 30.70 | 0.000 004 |

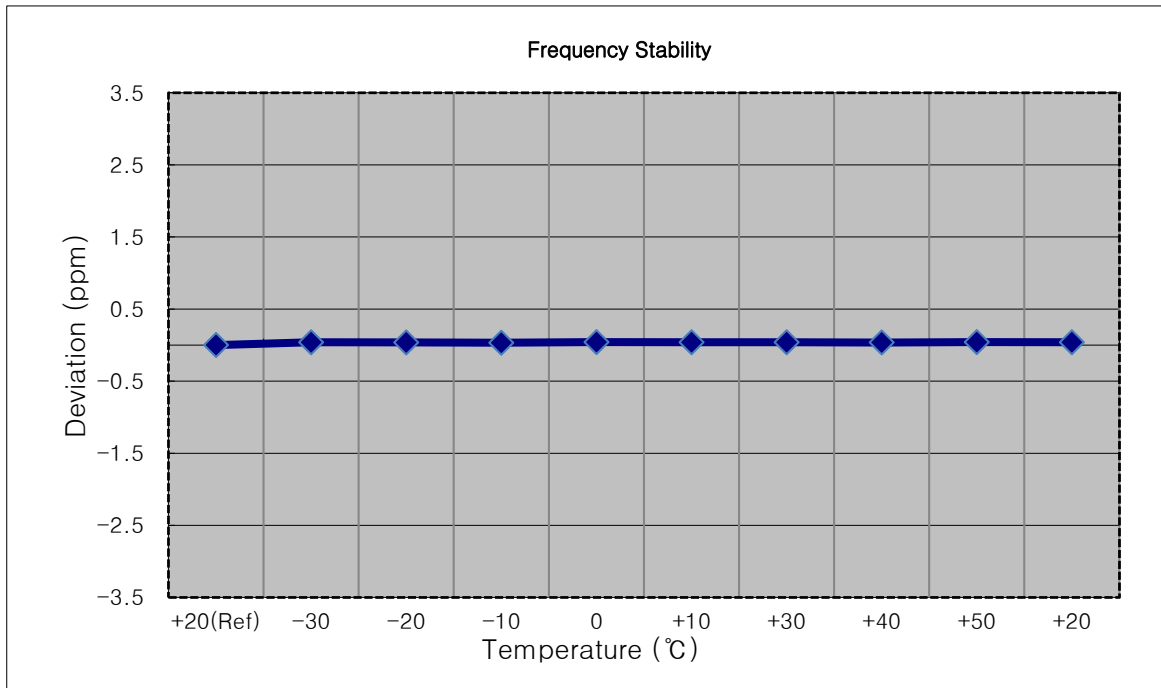

9. TEST PLOTS

BAND 4. Occupied Bandwidth Plot (5M BW Ch.20175 QPSK RB 25)

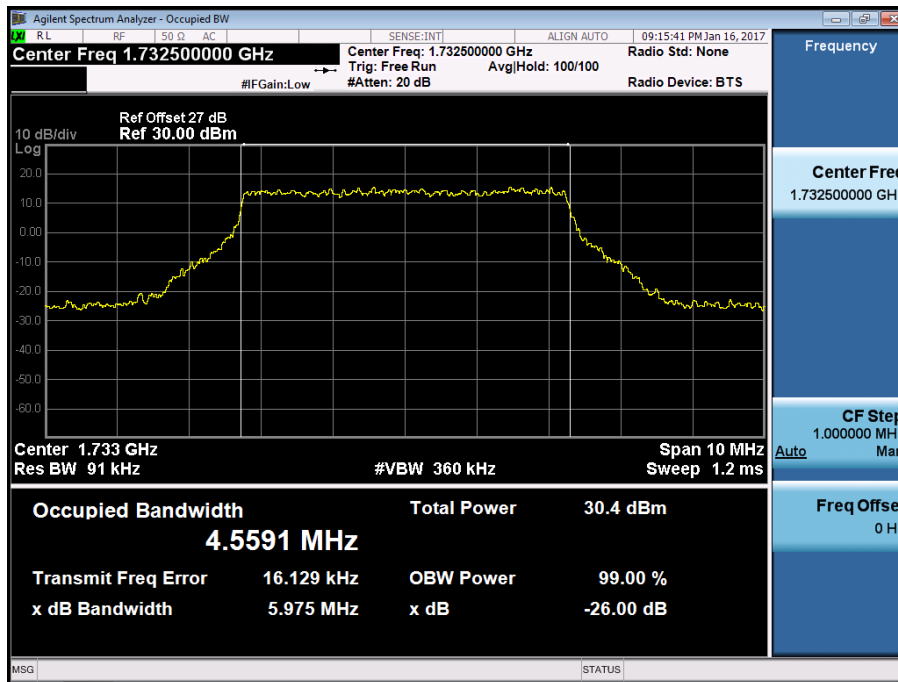

BAND 4. Occupied Bandwidth Plot (5M BW Ch.20175 16QAM RB 25)

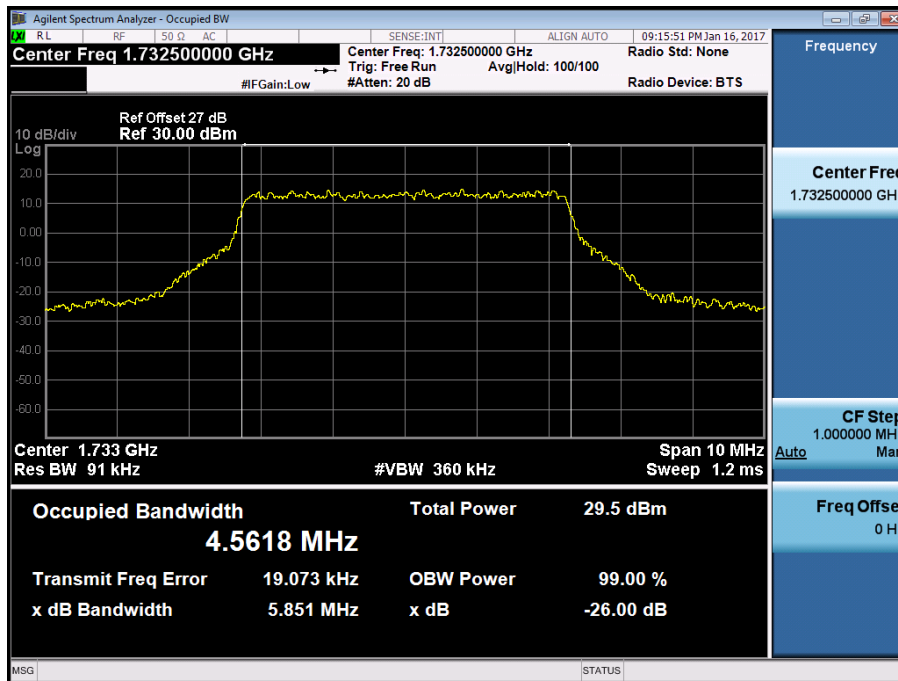

BAND 4. Occupied Bandwidth Plot (10M BW Ch.20175 QPSK RB 50)

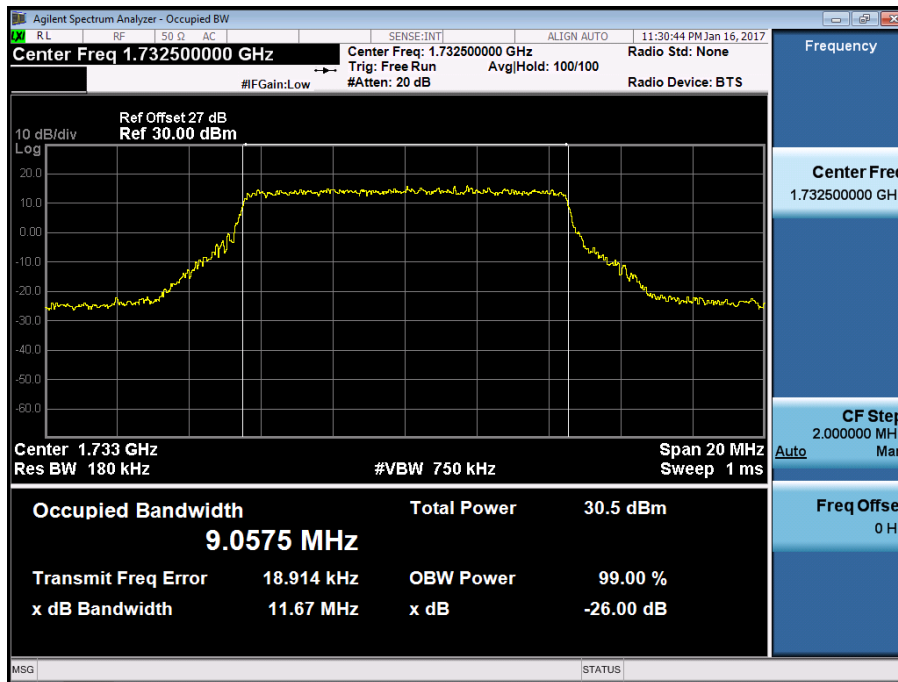

BAND 4. Occupied Bandwidth Plot (10M BW Ch.20175 16QAM RB 50)

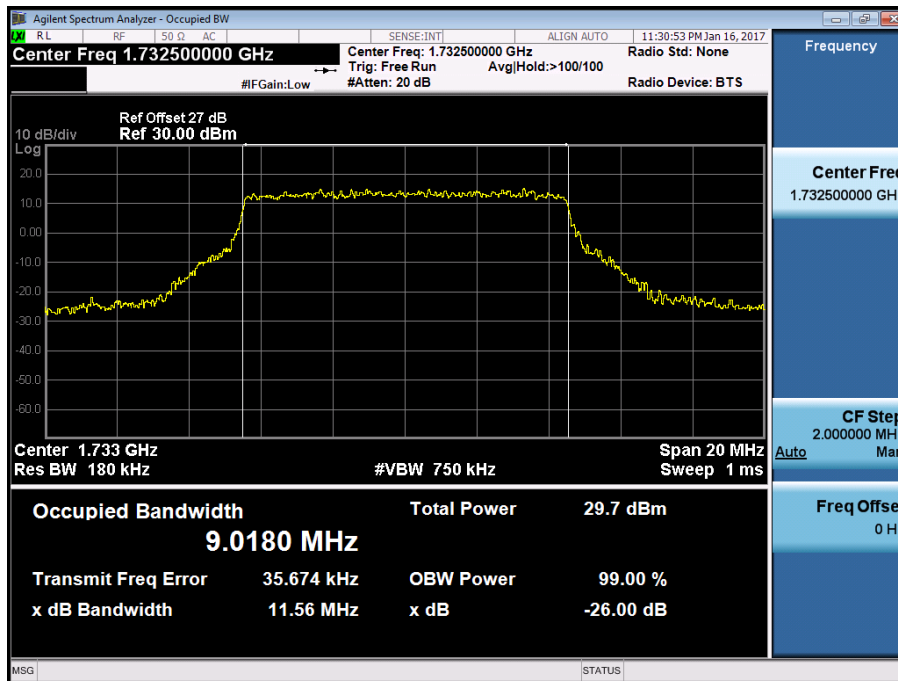

BAND 4. Occupied Bandwidth Plot (15M BW Ch.20175 QPSK RB 75)

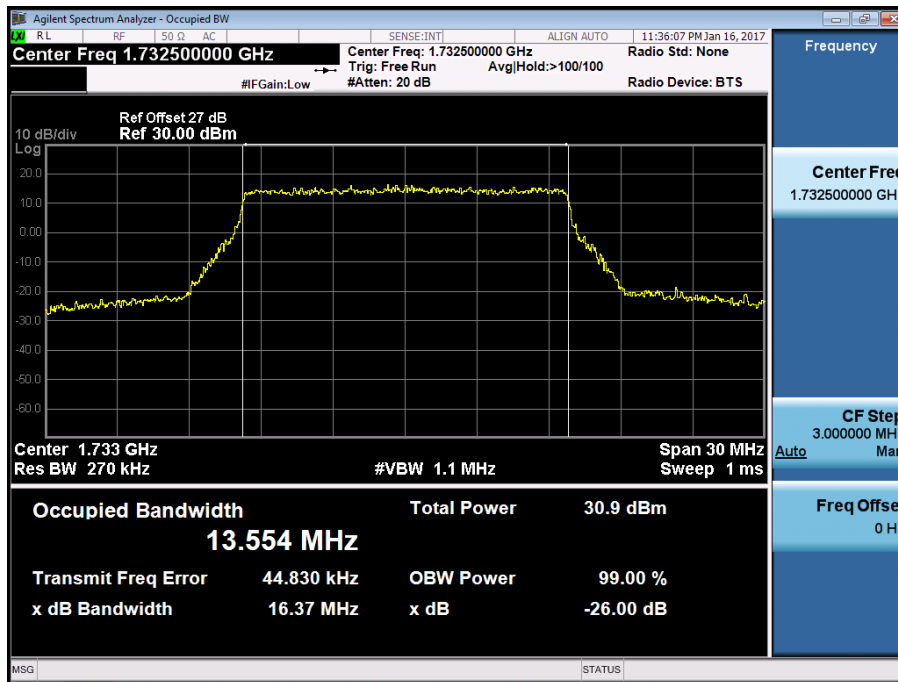

BAND 4. Occupied Bandwidth Plot (15M BW Ch.20175 16QAM RB 75)

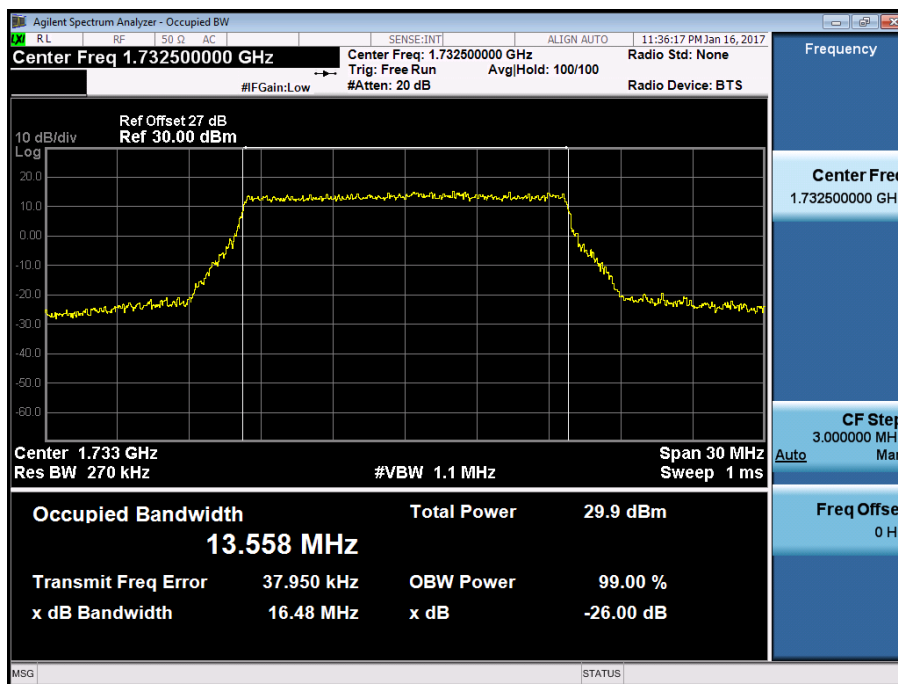

BAND 4. Occupied Bandwidth Plot (20M BW Ch.20175 QPSK RB 100)

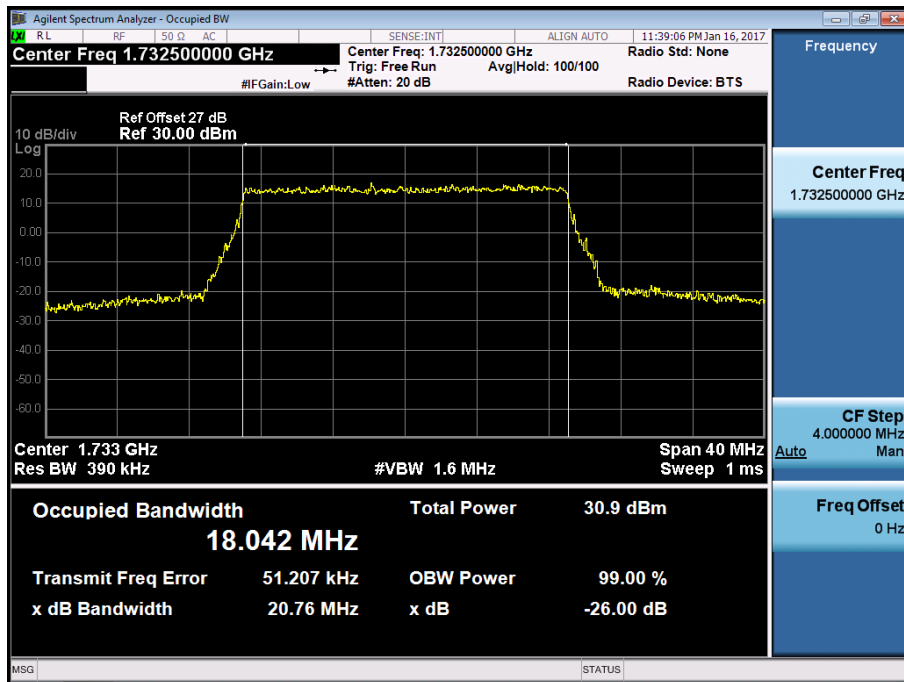

BAND 4. Occupied Bandwidth Plot (20M BW Ch.20175 16QAM RB 100)

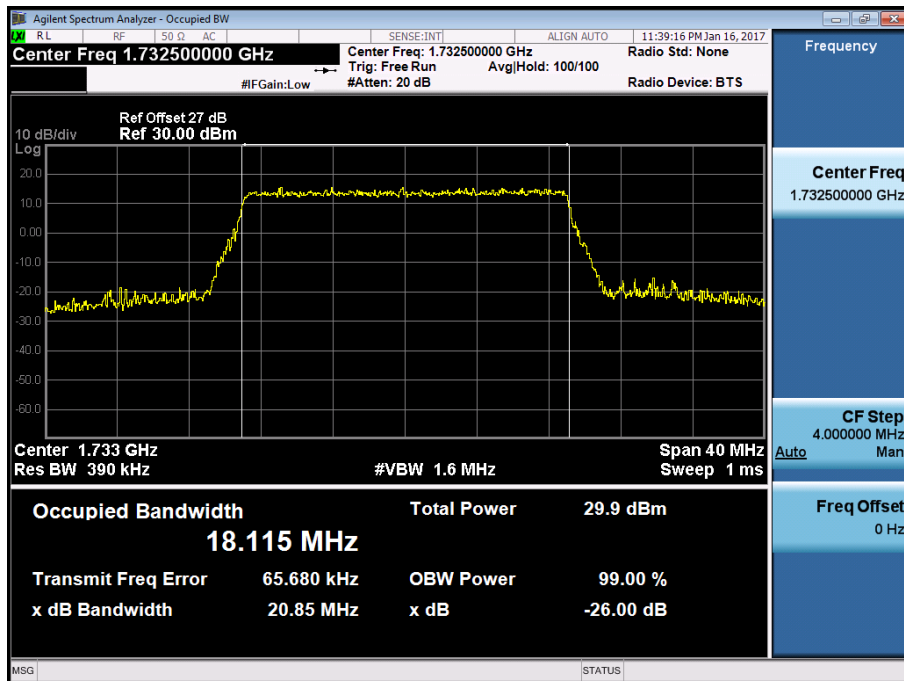

BAND 13. Occupied Bandwidth Plot (Ch.23230 QPSK RB 25) 5 MHz

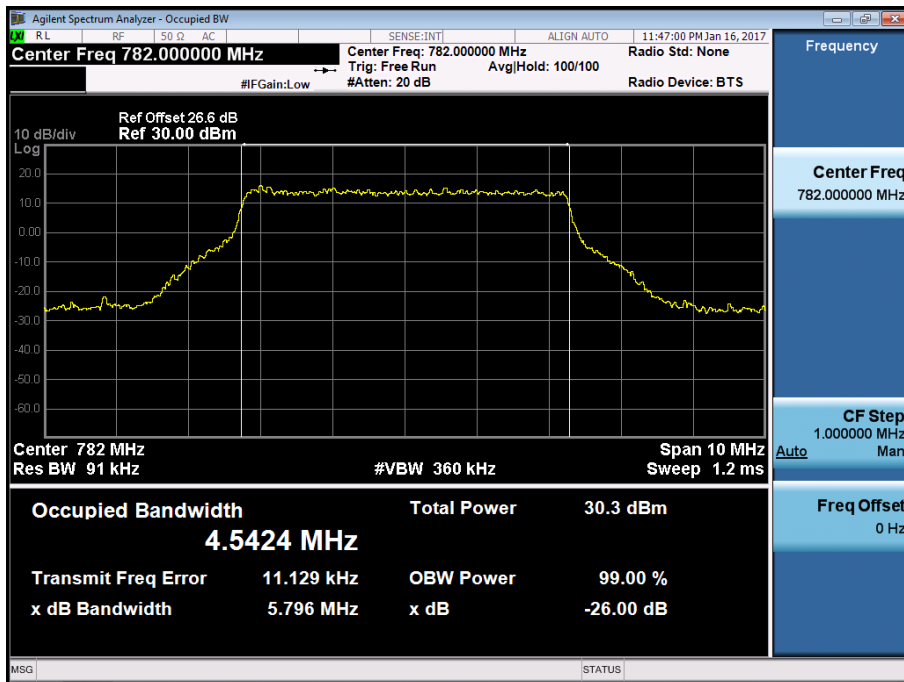

BAND 13. Occupied Bandwidth Plot (Ch.23230 16-QAM RB 25) 5 MHz

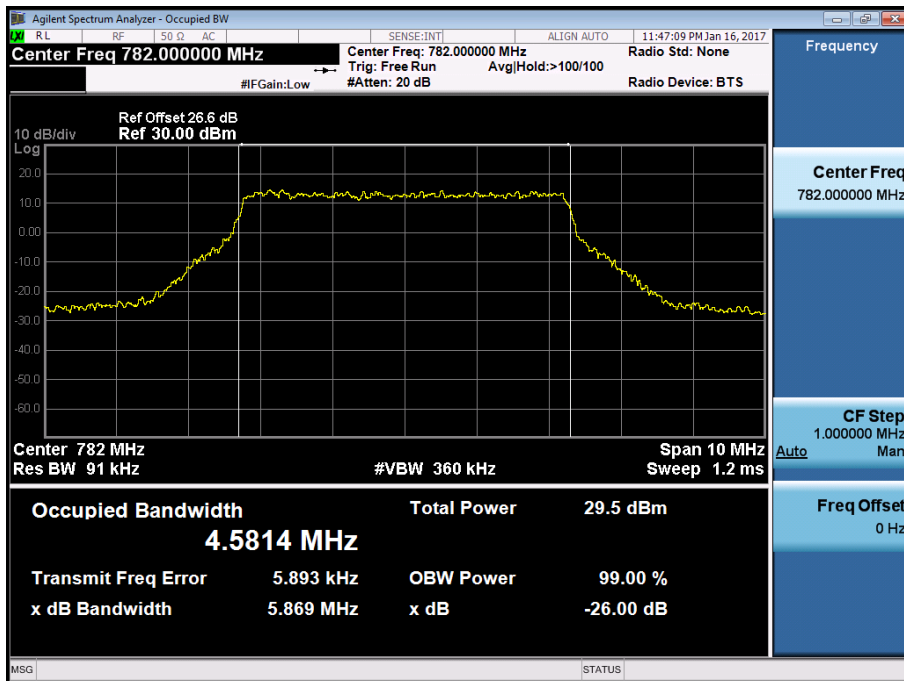

BAND 13. Occupied Bandwidth Plot (Ch.23230 QPSK RB 50) 10 MHz

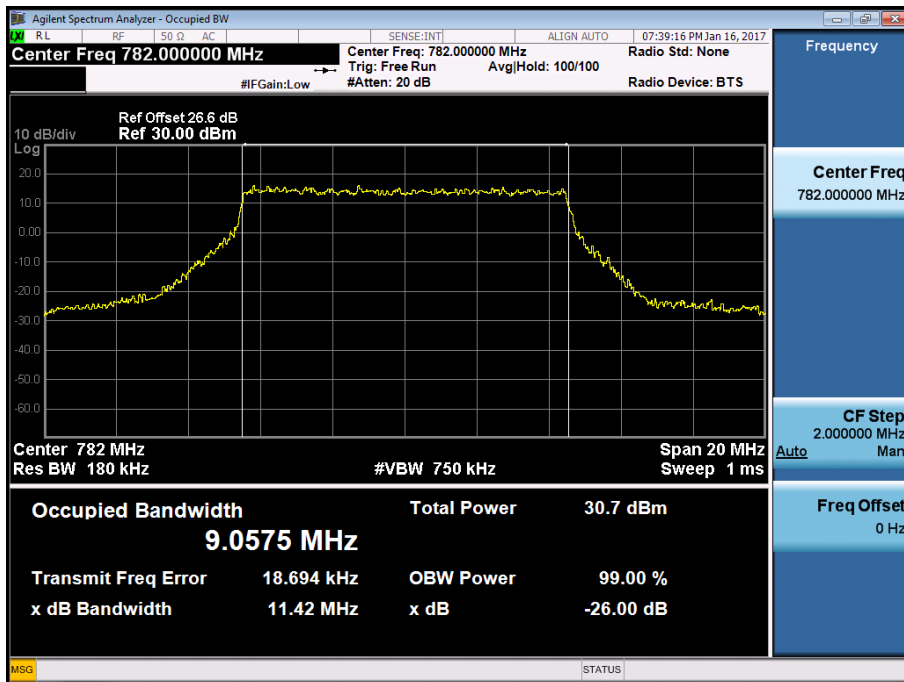

BAND 13. Occupied Bandwidth Plot (Ch.23230 16-QAM RB 50) 10 MHz

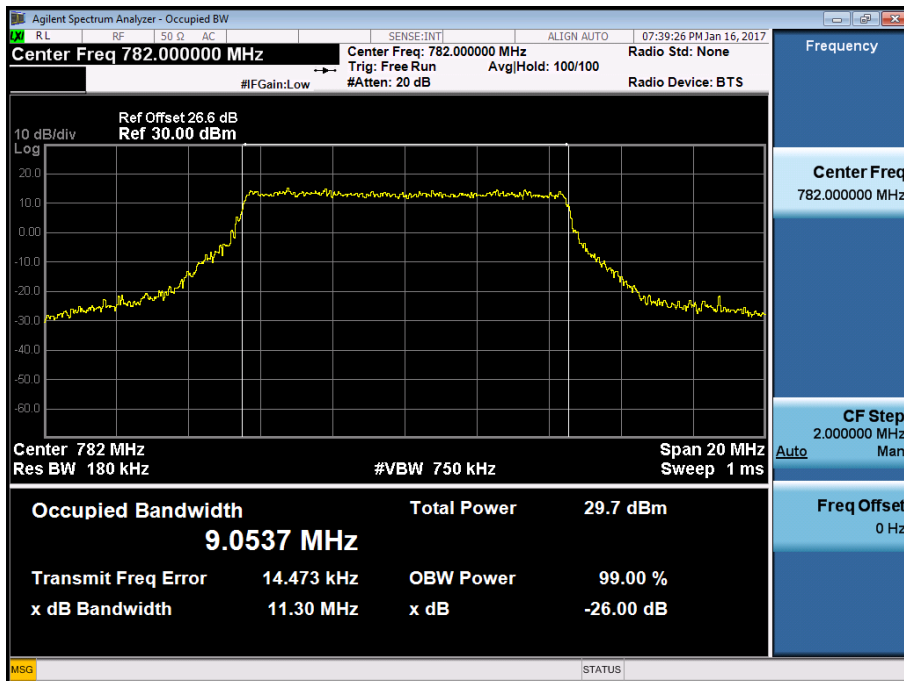

BAND 4. PAR Plot (5M BW_Ch.20175_QPSK_RB25_0)

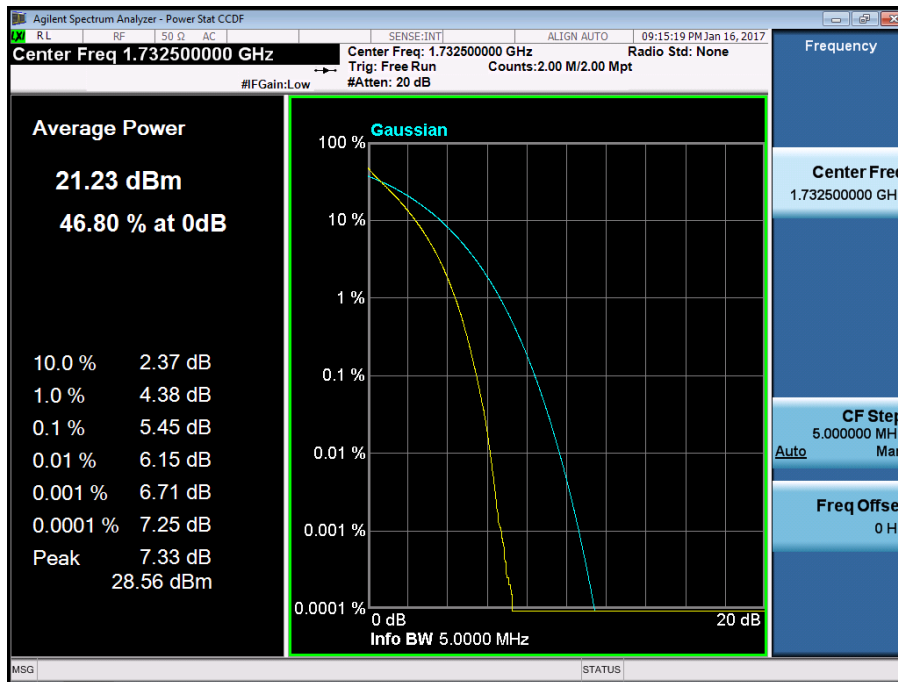

BAND 4. PAR Plot (5M BW_Ch.20175_16QAM_RB25_0)

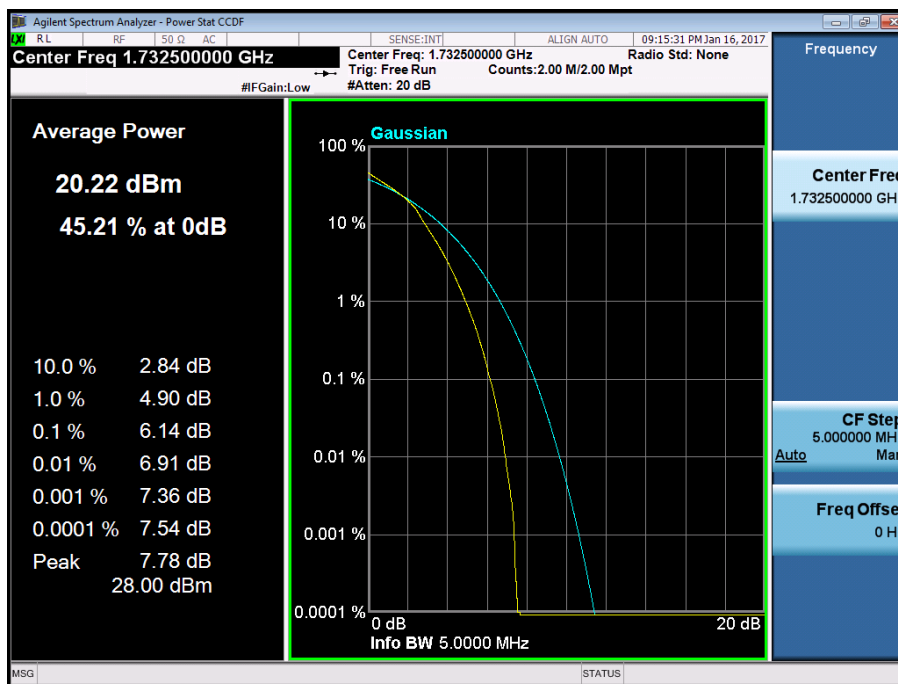

BAND 4. PAR Plot (10M BW_Ch.20175_QPSK_RB50_0)

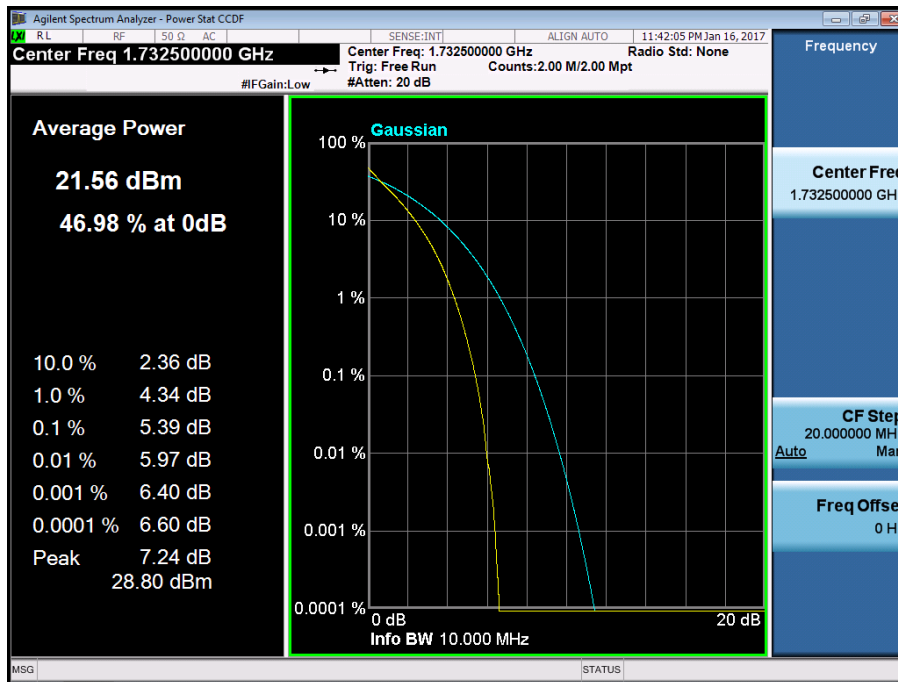

BAND 4. PAR Plot (10M BW_Ch.20175_16QAM_RB50_0)

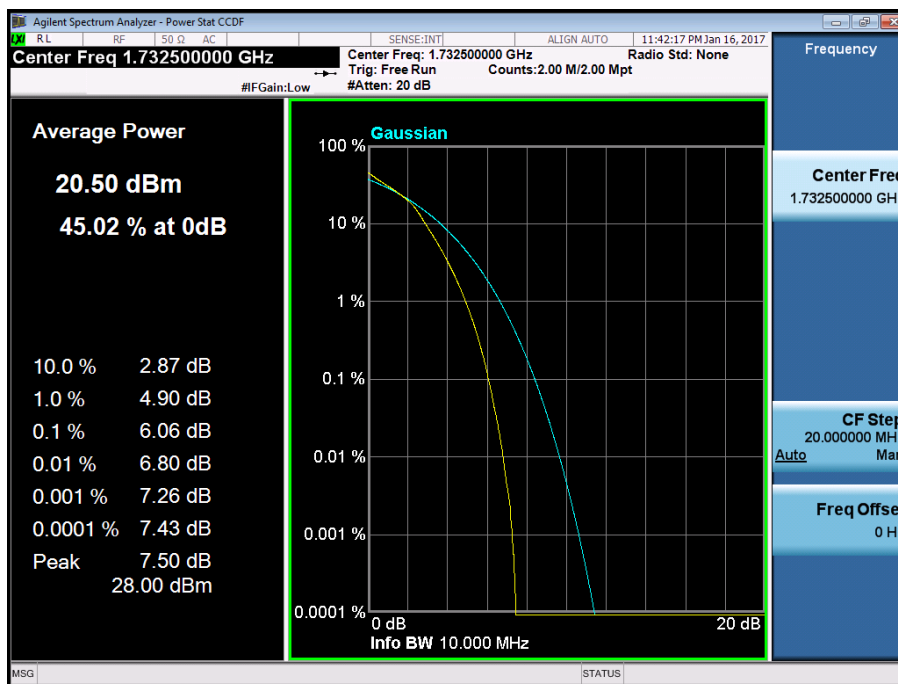

BAND 4. PAR Plot (15M BW_Ch.20175_QPSK_RB75_0)

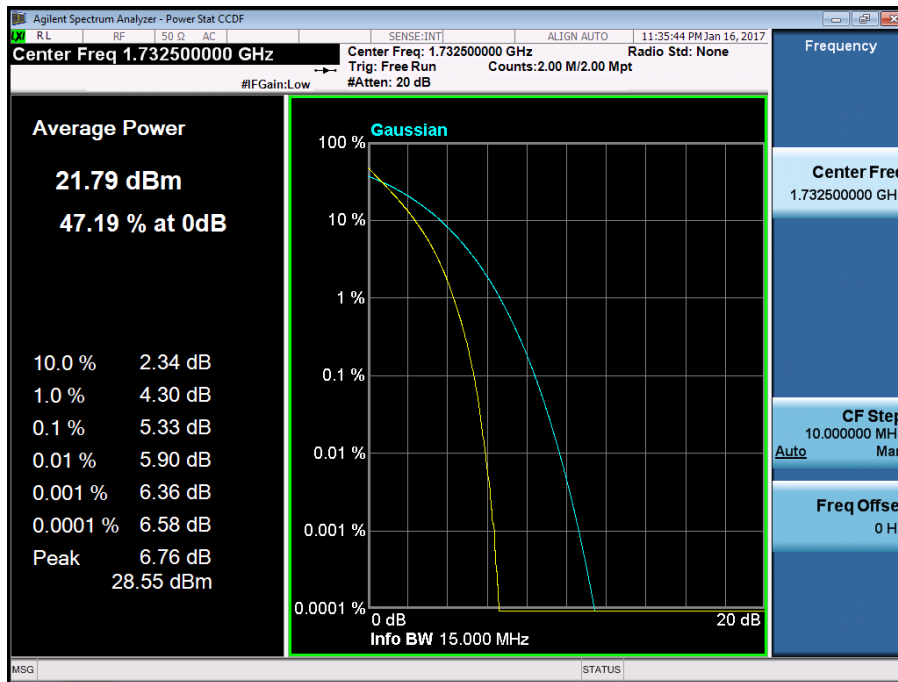

BAND 4. PAR Plot (15M BW_Ch.20175_16QAM_RB75_0)

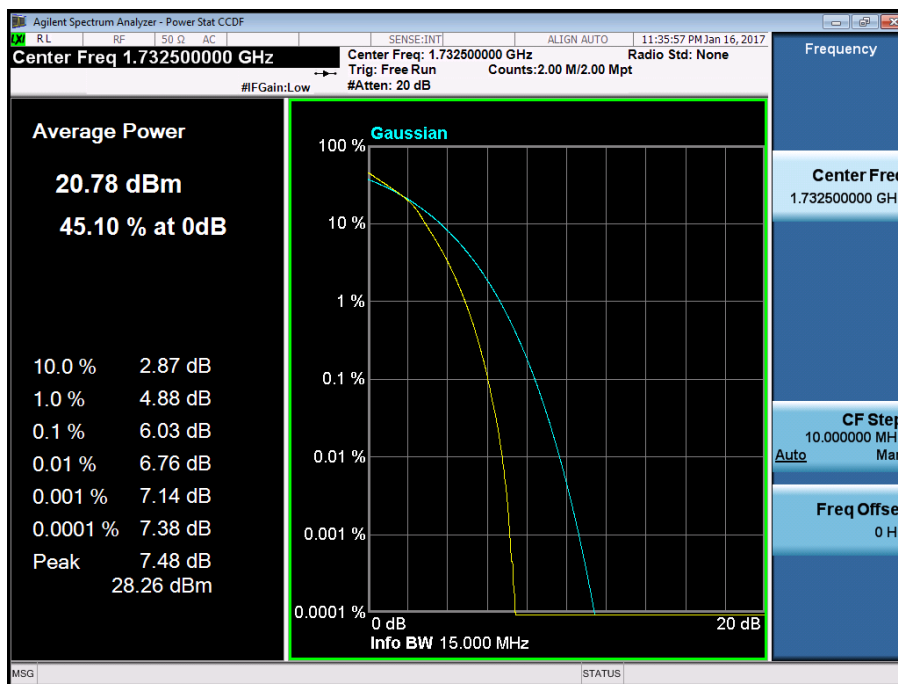

BAND 4. PAR Plot (20M BW_Ch.20175_QPSK_RB100_0)

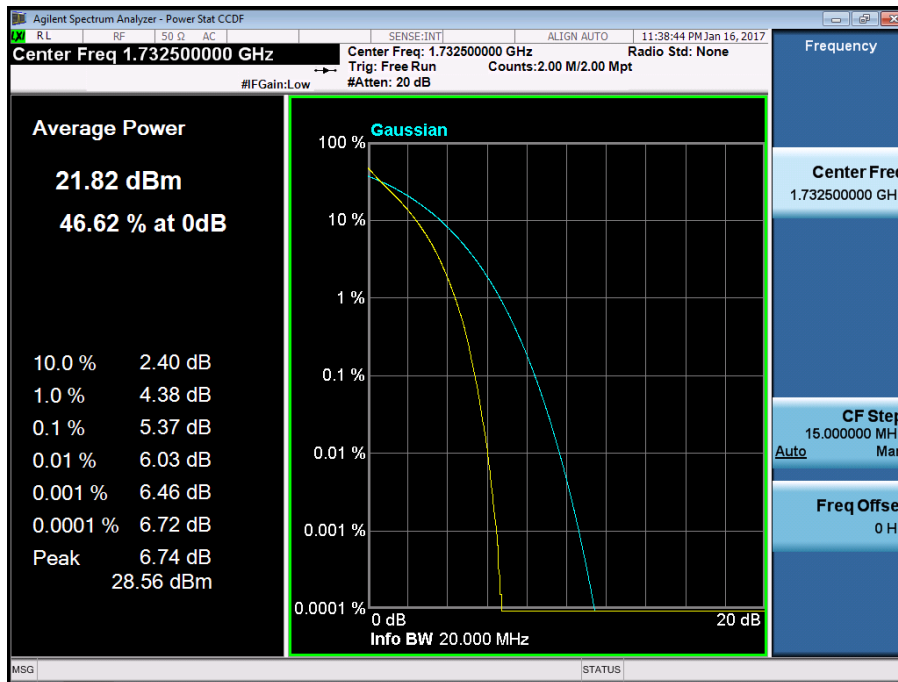

BAND 4. PAR Plot (20M BW_Ch.20175_16QAM_RB100_0)

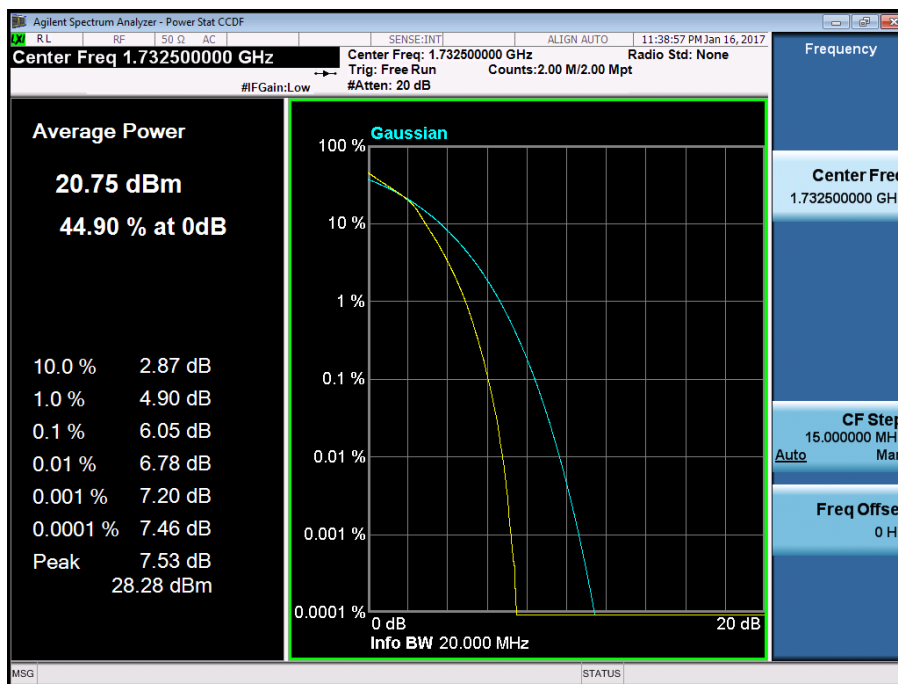

BAND 4. Lower Band Edge Plot (5M BW Ch.19975 QPSK RB 1, Offset 0) -1

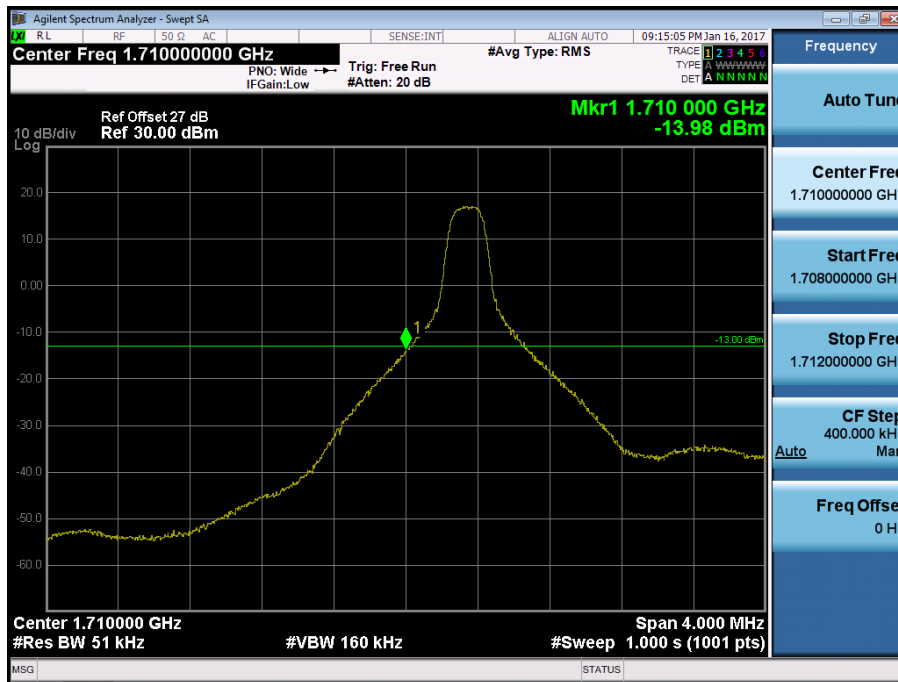

BAND 4. Lower Band Edge Plot (5M BW Ch.19975 QPSK RB 25) -2

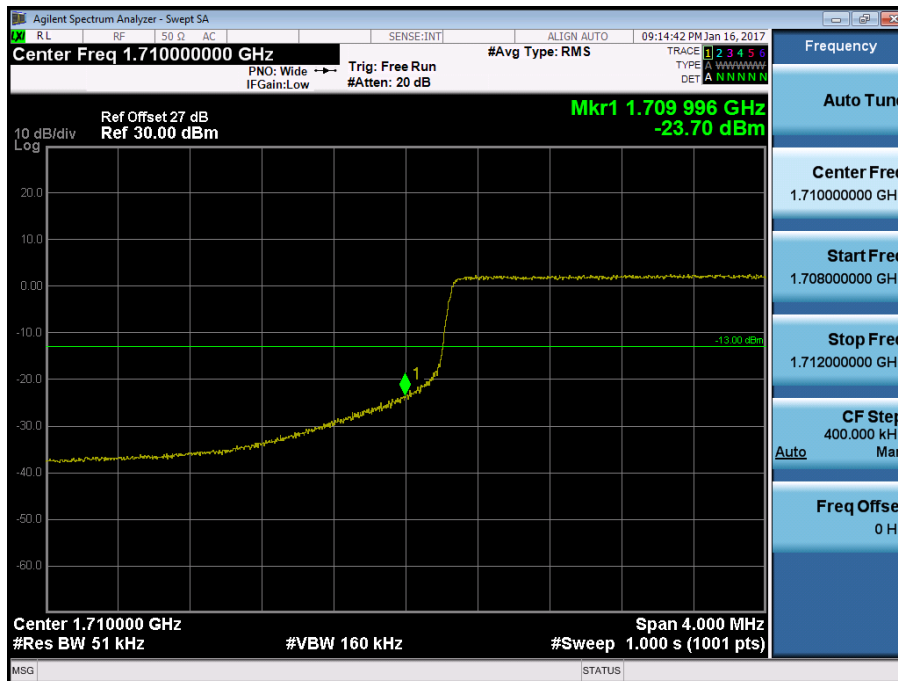

BAND 4. Lower Extended Band Edge Plot (5M BW Ch.19975 QPSK_RB25_0) -3



BAND 4. Lower Band Edge Plot (10M BW Ch.20000 QPSK RB 1, Offset 0) -1

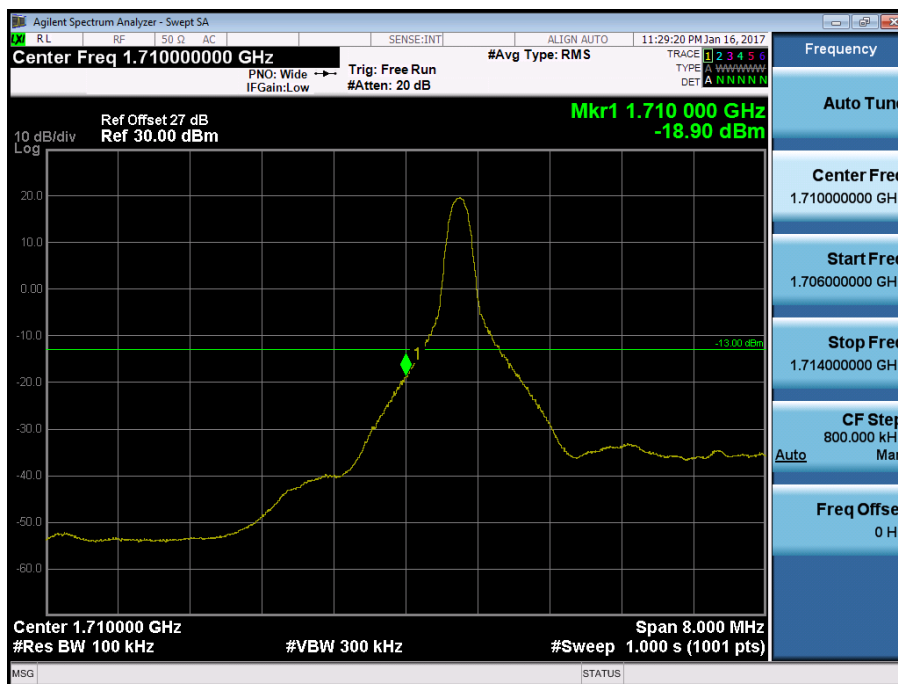

BAND 4. Lower Band Edge Plot (10M BW Ch.20000 QPSK RB 50) -2

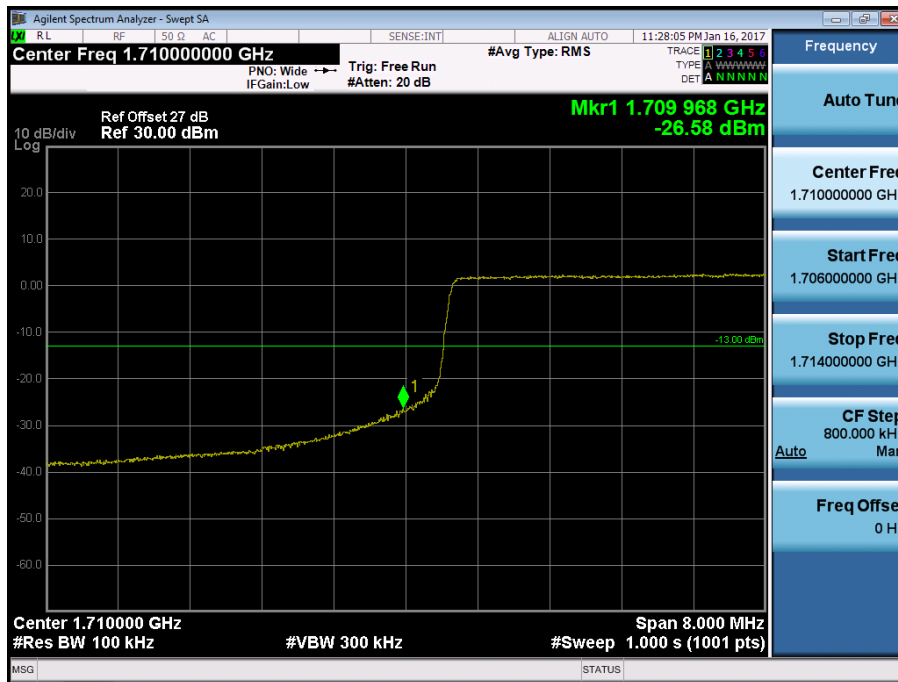

BAND 4. Lower Extended Band Edge Plot (10M BW Ch.20000 QPSK_RB50_0) -3



BAND 4. Lower Band Edge Plot (15M BW Ch.20025 QPSK RB 1, Offset 0) -1

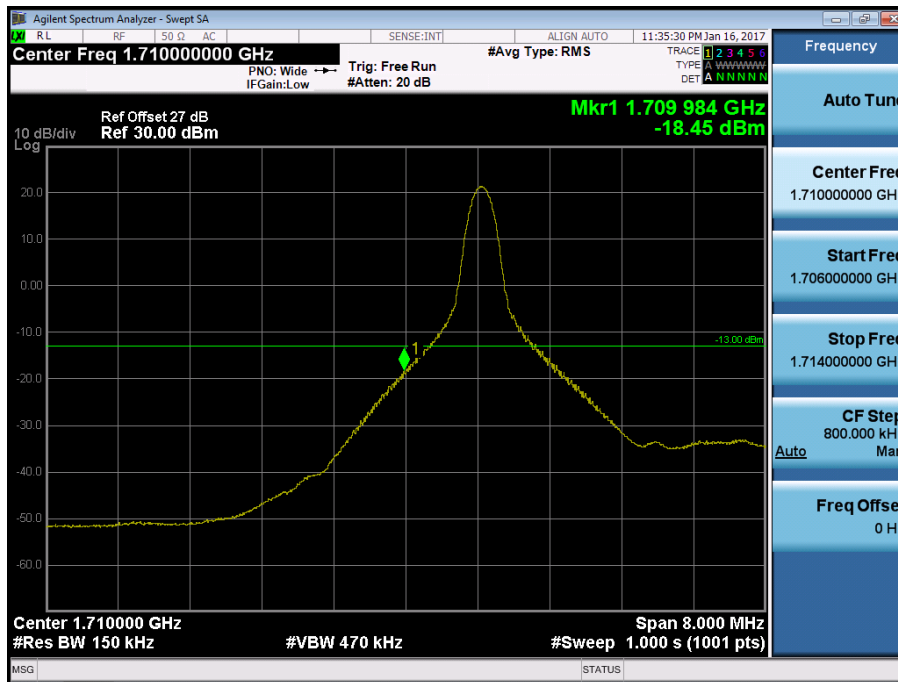

BAND 4. Lower Band Edge Plot (15M BW Ch.20025 QPSK RB 75) -2

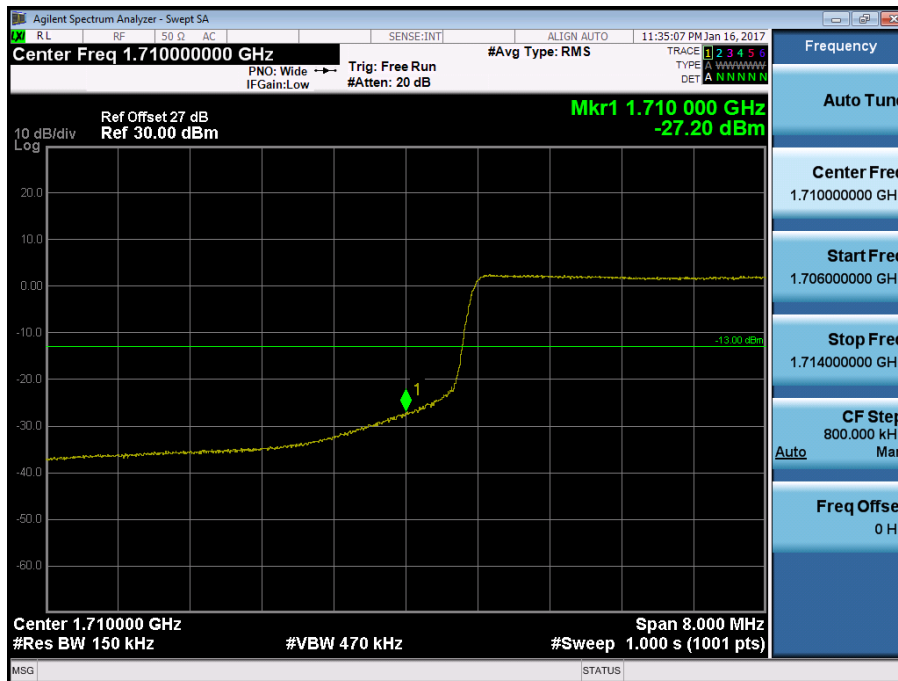

BAND 4. Lower Extended Band Edge Plot (15M BW Ch.20025 QPSK_RB75_0) -3

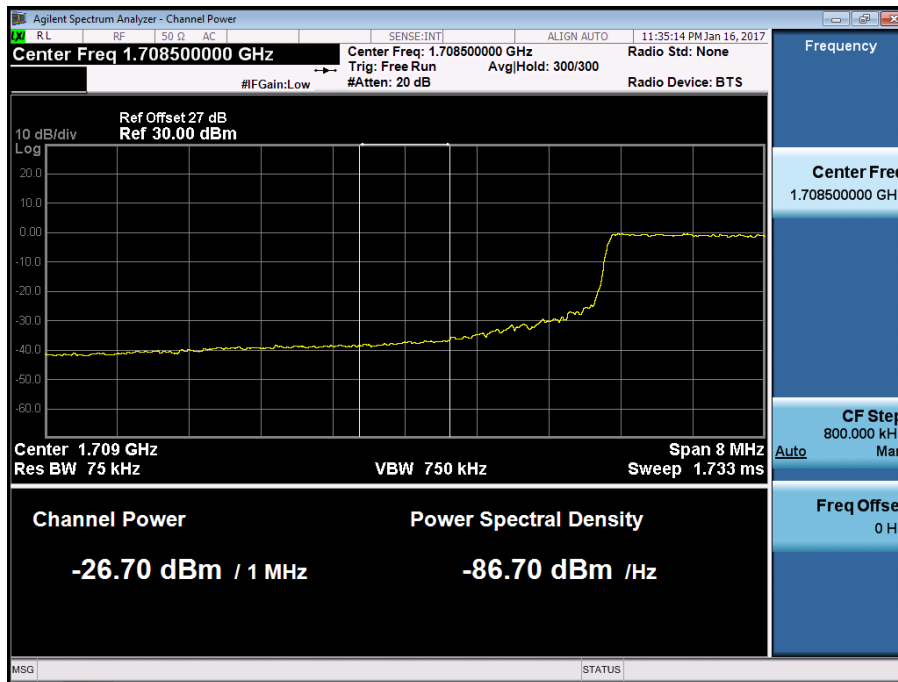

BAND 4. Lower Band Edge Plot (20M BW Ch.20050 QPSK RB 1, Offset 0) -1

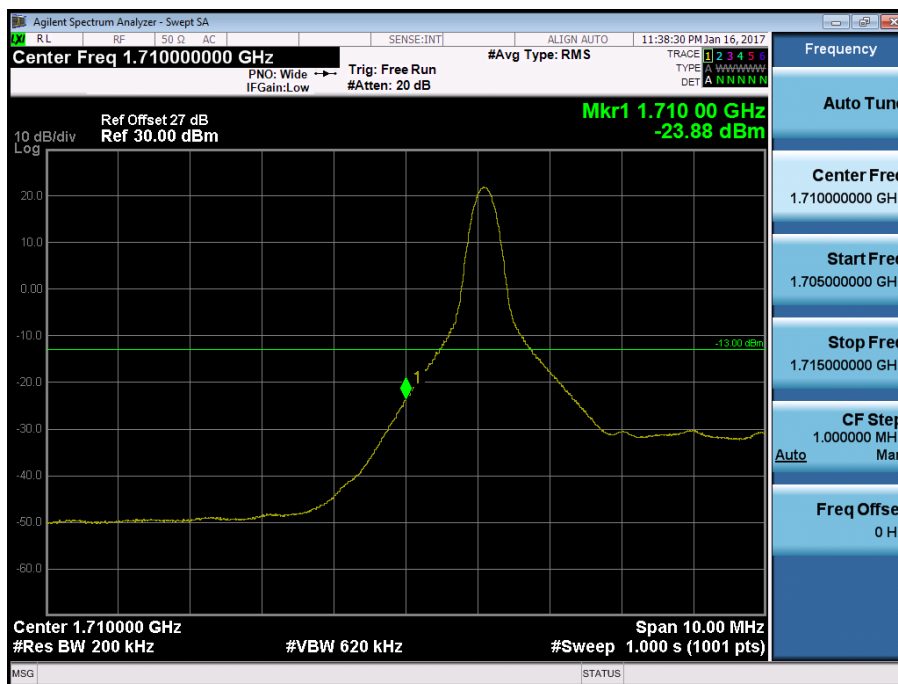

BAND 4. Lower Band Edge Plot (20M BW Ch.20050 QPSK RB 100) -2

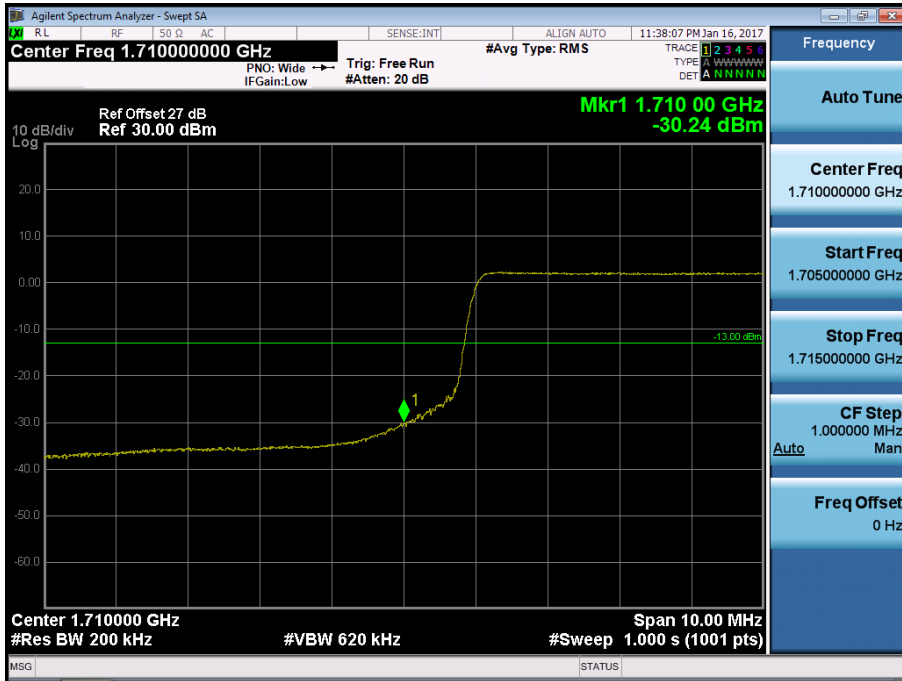

BAND 4. Lower Extended Band Edge Plot (20M BW Ch.20050 QPSK_RB100_0) -3

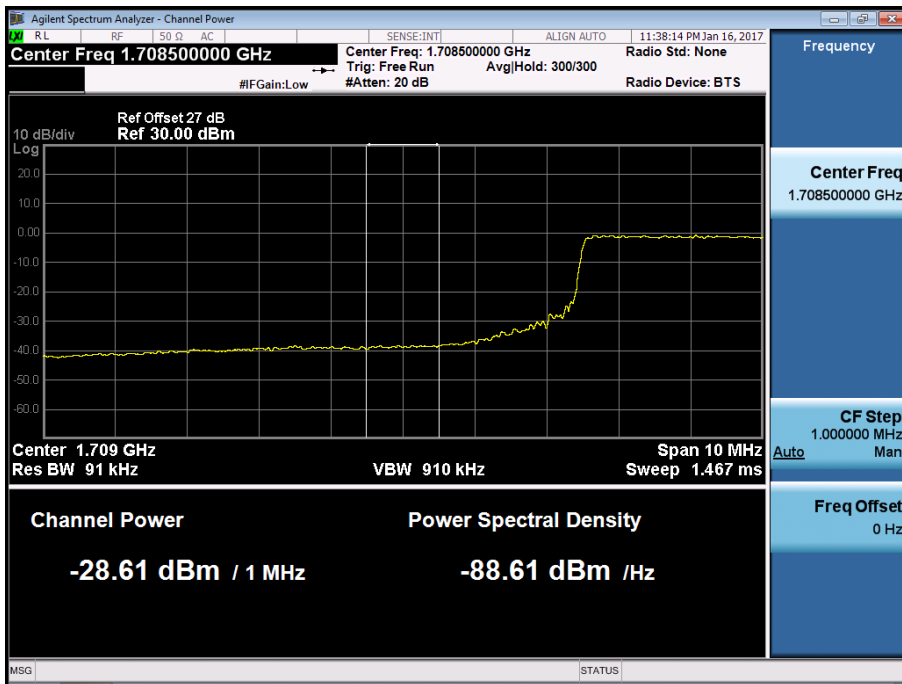

BAND 4. Upper Band Edge Plot (5M BW Ch.20375 QPSK_RB1_Offset 24) -1

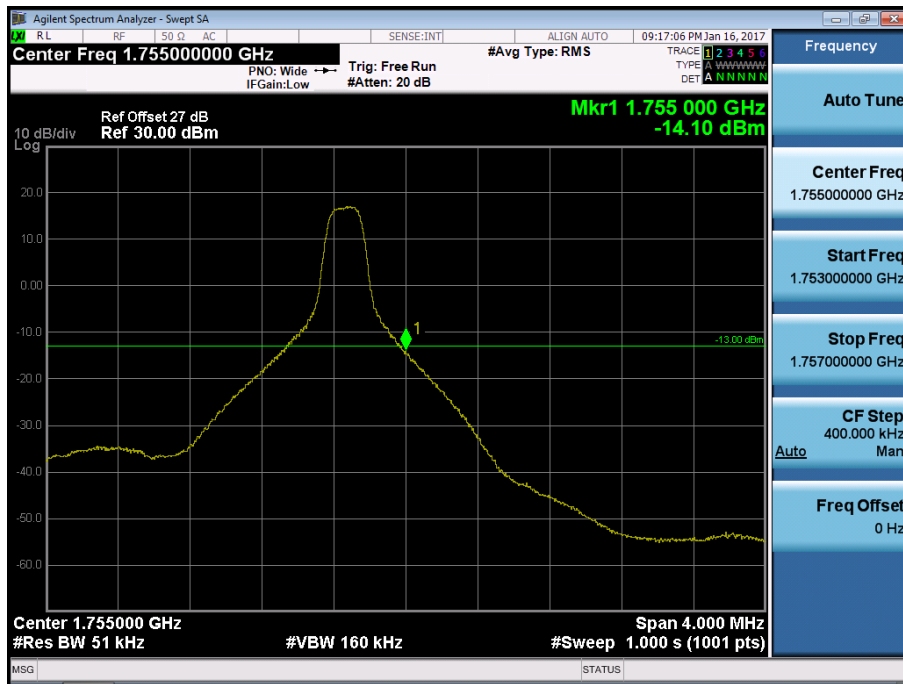

BAND 4. Upper Band Edge Plot (5M BW Ch.20375 QPSK_RB25) -2



BAND 4. Upper Extended Band Edge Plot (5M BW Ch.20375 QPSK_RB25) -3



BAND 4. Upper Band Edge Plot (10M BW Ch.20350 QPSK_RB1_Offset 49) -1

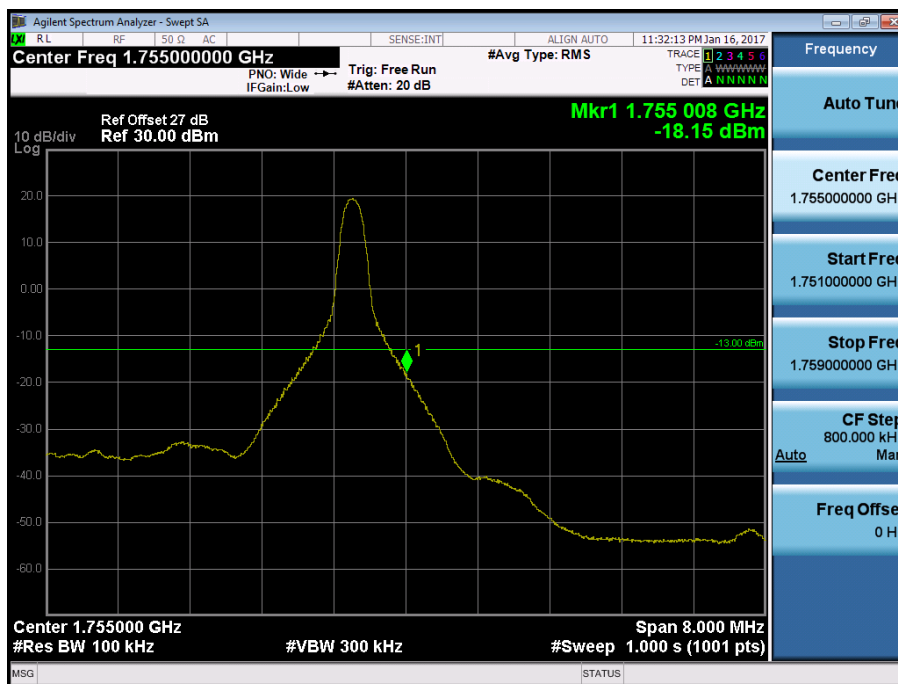

BAND 4. Upper Band Edge Plot (10M BW Ch.20350 QPSK_RB50) -2



BAND 4. Upper Extended Band Edge Plot (10M BW Ch.20350 QPSK_RB50) -3

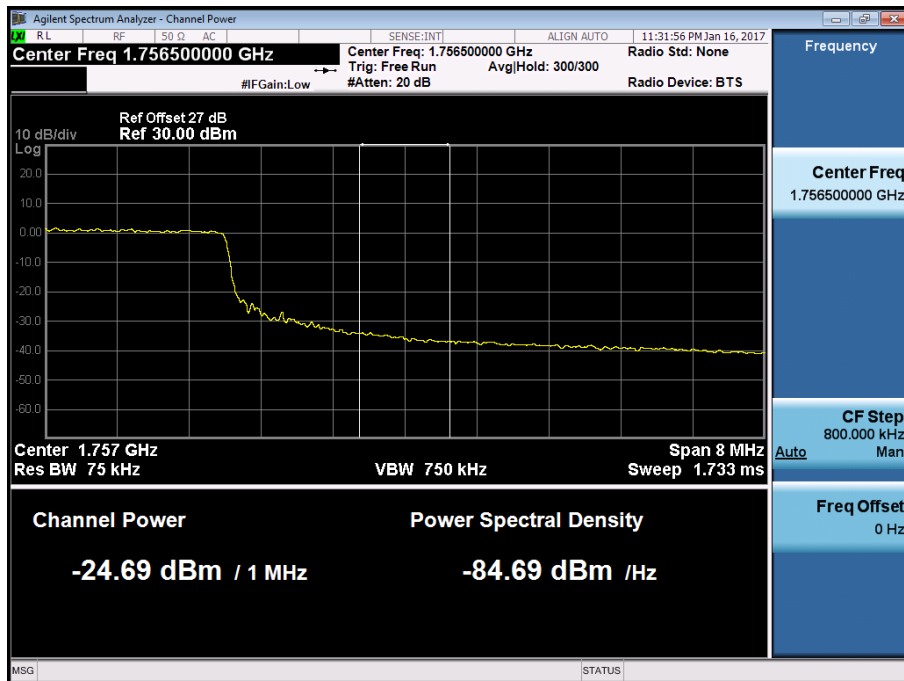

BAND 4. Upper Band Edge Plot (15M BW Ch.20325 QPSK_RB1_Offset 74) -1

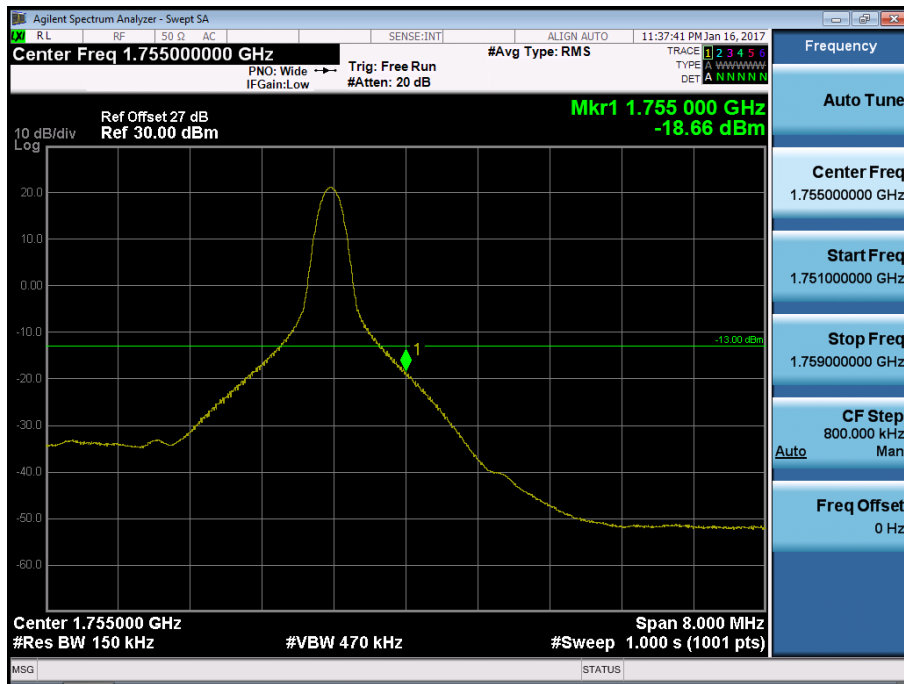

BAND 4. Upper Band Edge Plot (15M BW Ch.20325 QPSK_RB75) -2

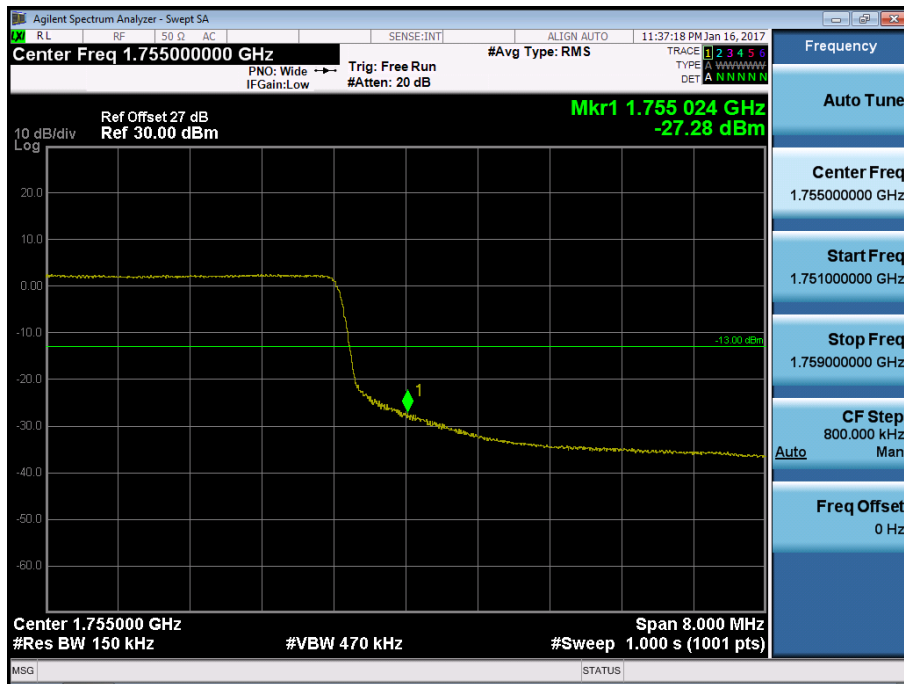

BAND 4. Upper Extended Band Edge Plot (15M BW Ch.20325 QPSK_RB75) -3

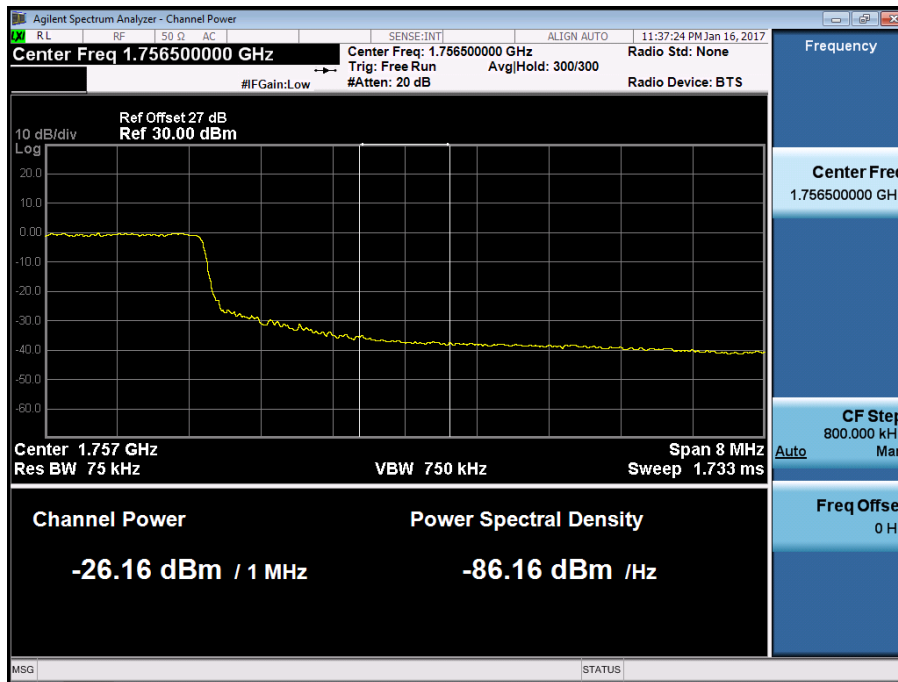

BAND 4. Upper Band Edge Plot (20M BW Ch.20300 QPSK_RB1_Offset 99) -1

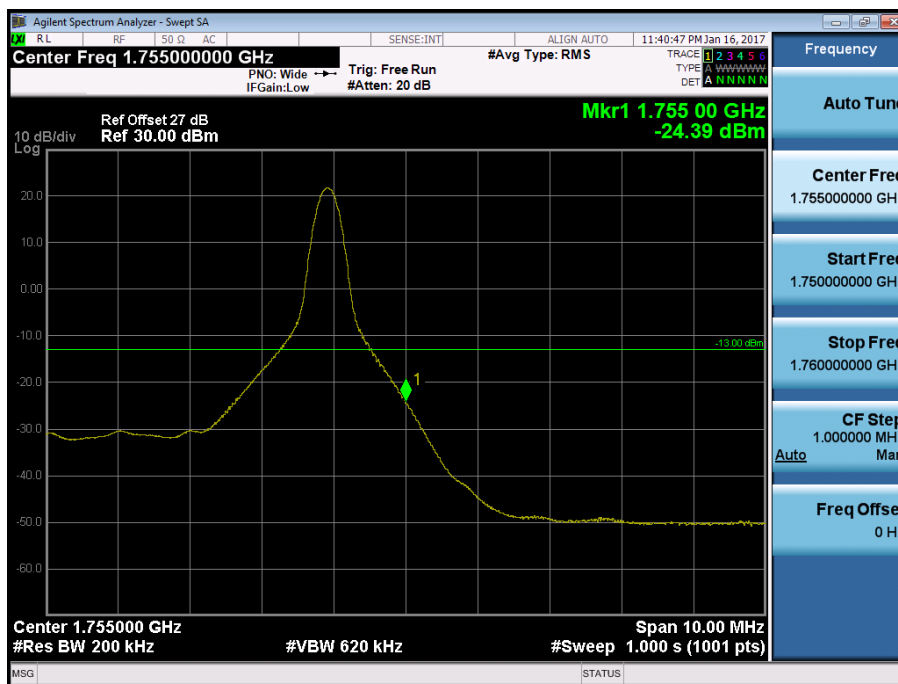

BAND 4. Upper Band Edge Plot (20M BW Ch.20300 QPSK_RB100) -2



BAND 4. Upper Extended Band Edge Plot (20M BW Ch.20300 QPSK_RB100) -3

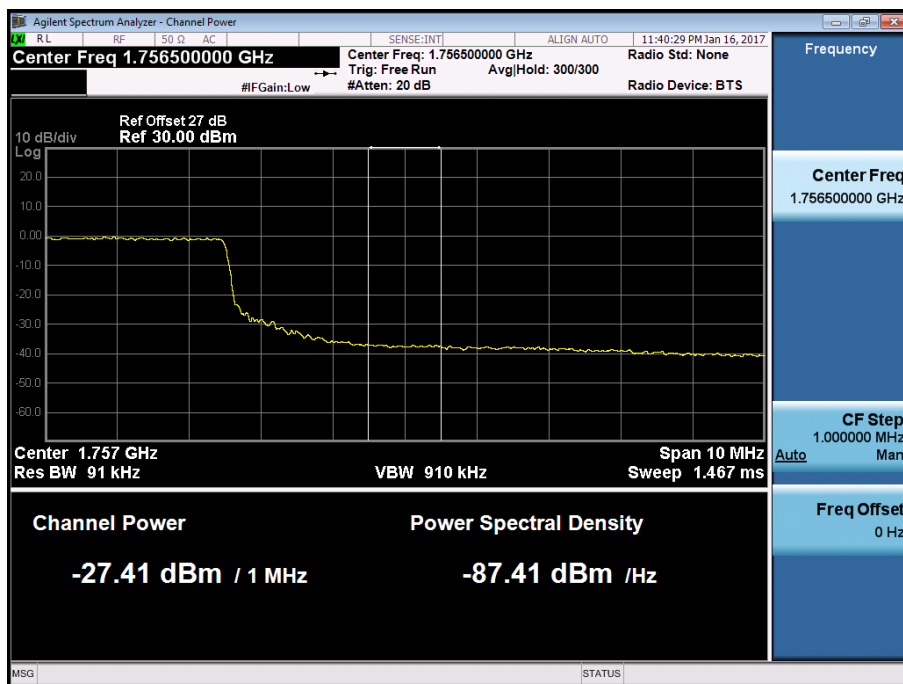

Band 13 Lower Band Edge Plot (5M BW Ch.23205 QPSK_RB1 OFFSET0)

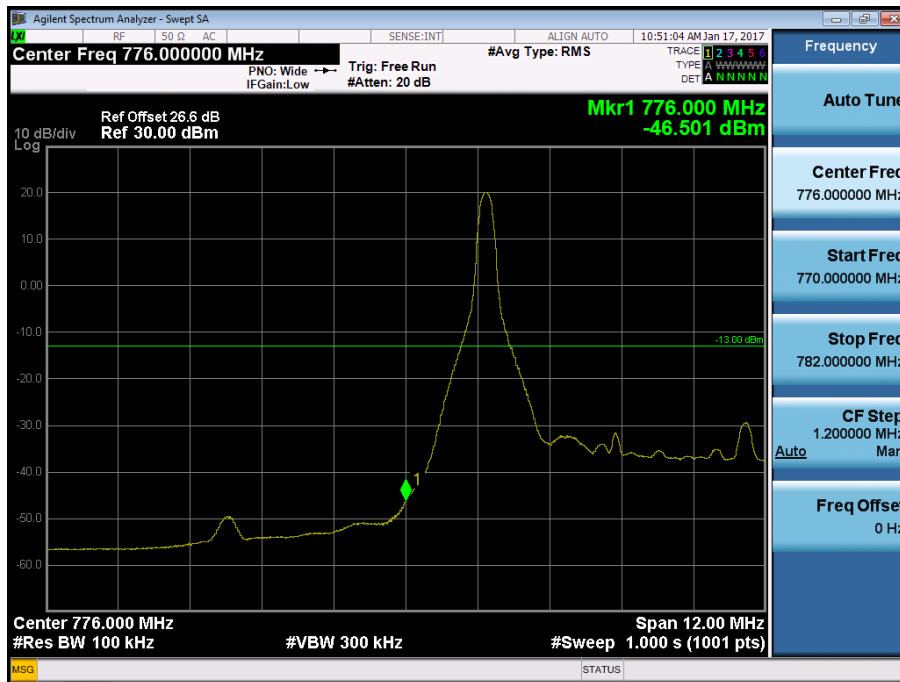

Band 13 Lower Band Edge Plot (5M BW Ch.23205 QPSK_RB25)



Band 13 Lower Emission Mask (763 MHz ~ 775 MHz) Plot (5M BW Ch.23205 QPSK_RB25_0)

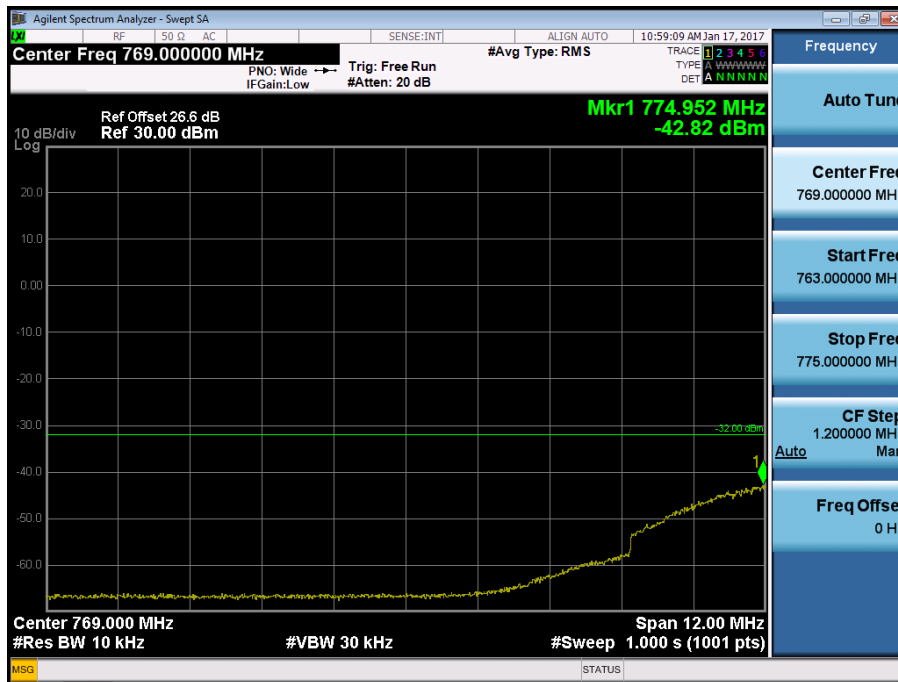

Band 13 Lower Band Edge Plot (10M BW Ch.23230 QPSK_RB1 OFFSET0)



BAND 13. Lower & Upper Band Edge Plot (10M BW Ch.23230 QPSK RB 50)



Band 13 Lower Emission Mask (763 MHz ~ 775 MHz) Plot (10M BW Ch.23230 QPSK_RB50_0)

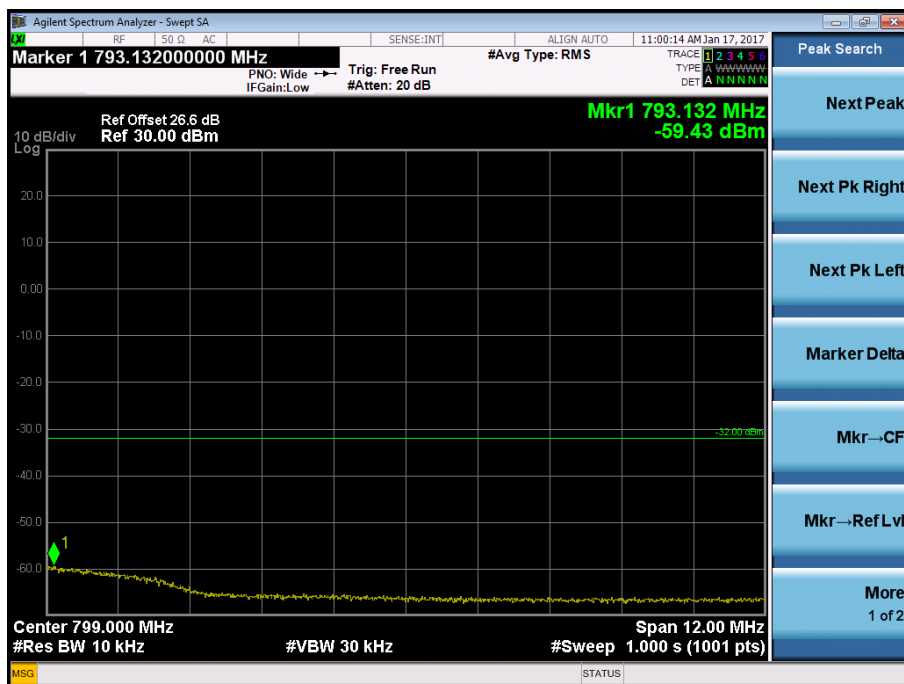

Band 13 Upper Band Edge Plot (5M BW Ch.23255 QPSK_RB1_Offset 24)

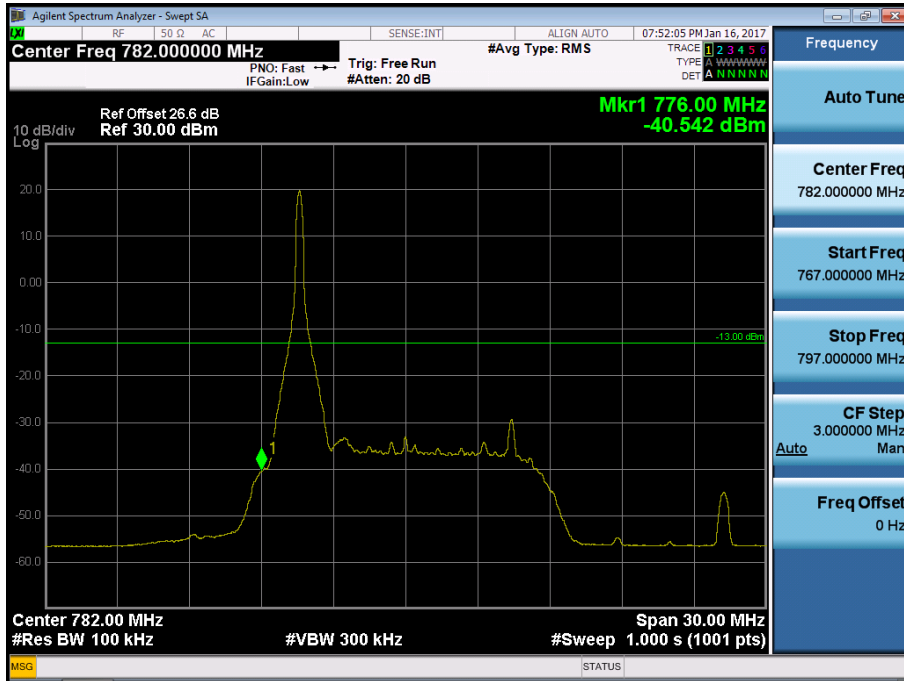

Band 13 Upper Band Edge Plot (5M BW Ch.23255 QPSK_RB25)

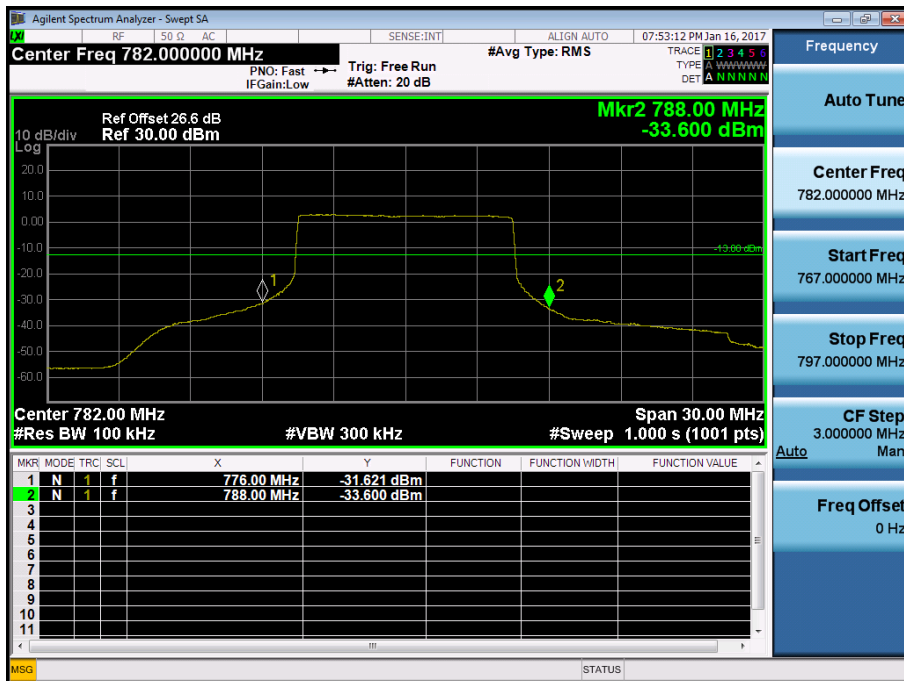

Band 13 Upper Emission Mask (793 MHz ~805 MHz) Plot (5M BW Ch.23255 QPSK_RB25_0)

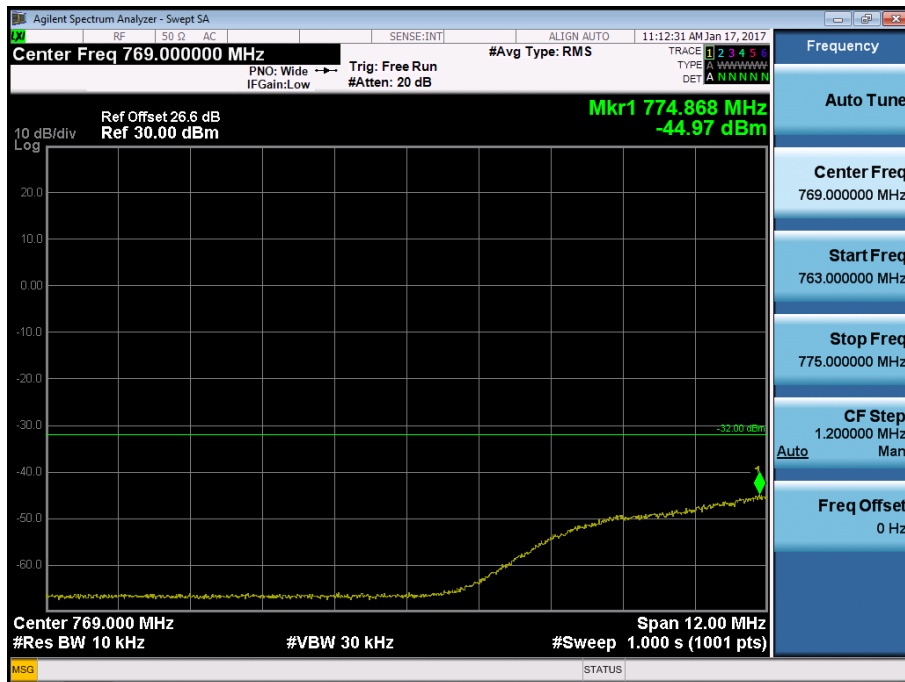

Band 13 Upper Band Edge Plot (10M BW Ch.23230 QPSK_RB1_Offset 24)

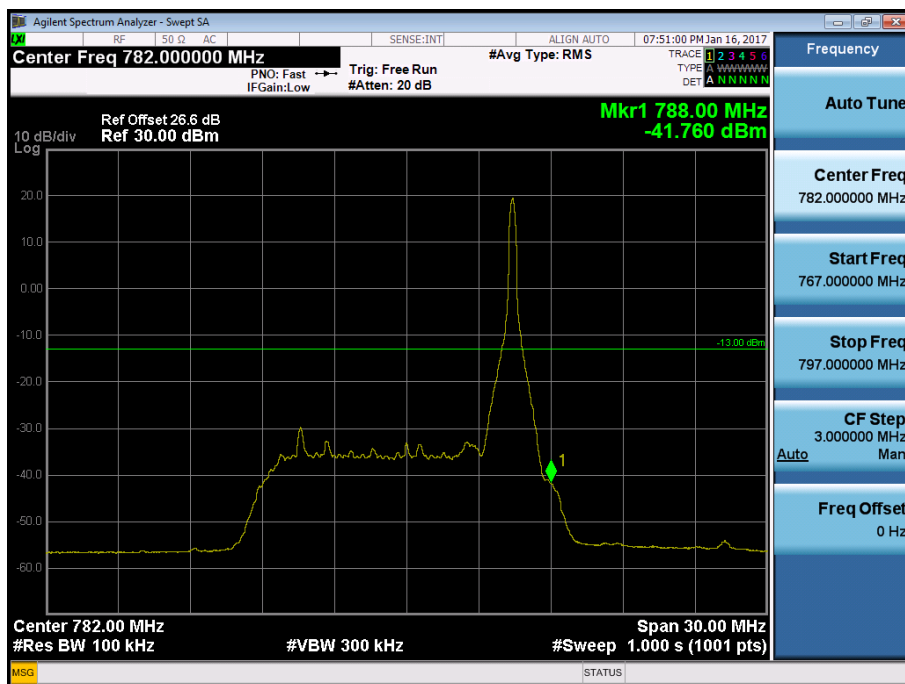

Band 13 Upper Emission Mask (793 MHz ~805 MHz) Plot (10M BW Ch.23230 QPSK_RB50_0)



BAND 4. Conducted Spurious Plot_1 (19975ch_5MHz_QPSK_RB 1_0)

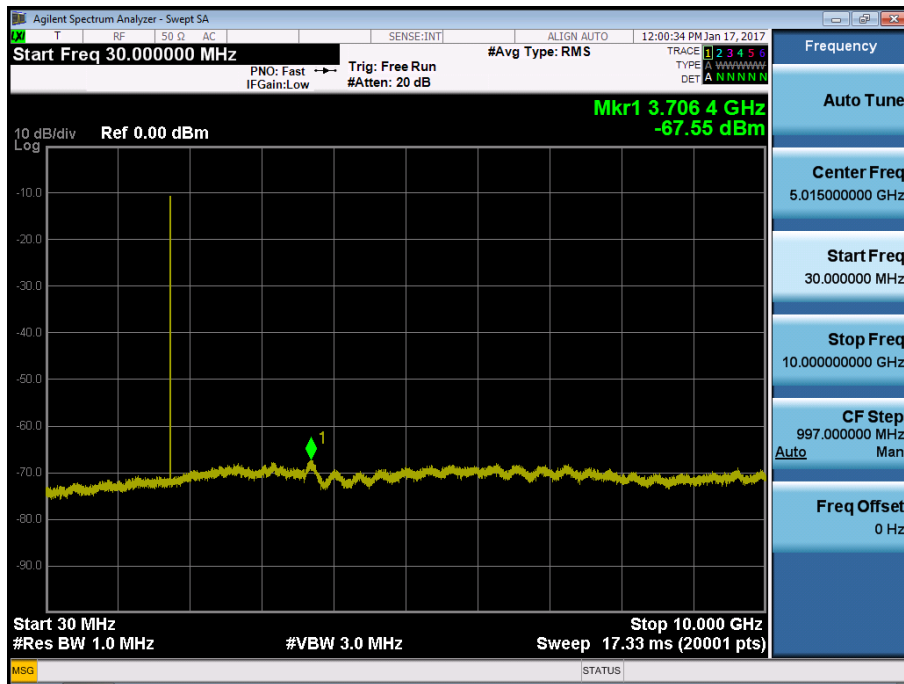

BAND 4. Conducted Spurious Plot_2 (19975ch_5MHz_QPSK_RB 1_0)

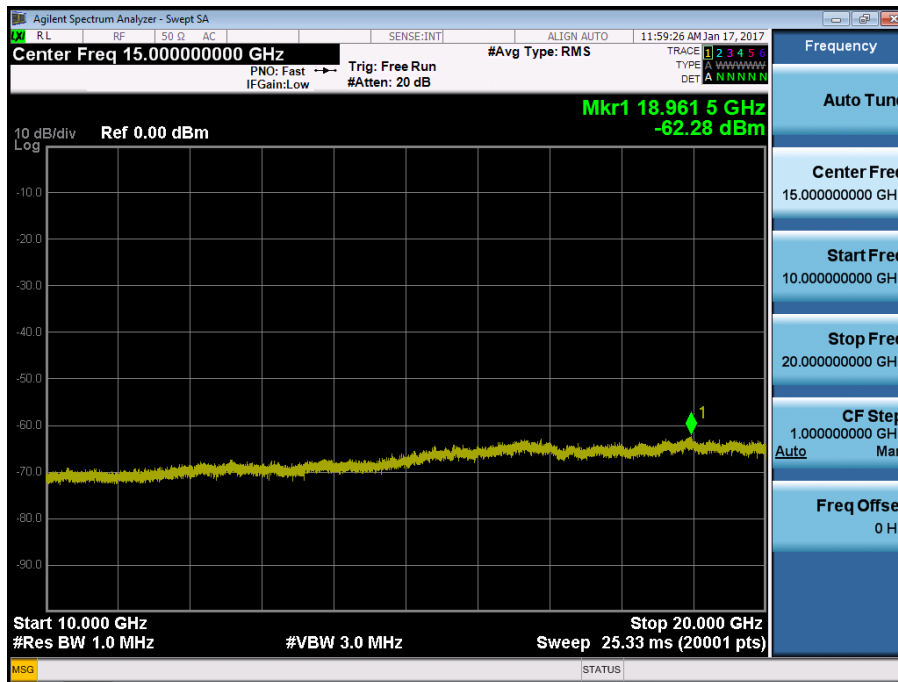

BAND 4. Conducted Spurious Plot_1 (20175ch_5MHz_QPSK_RB 1_0)

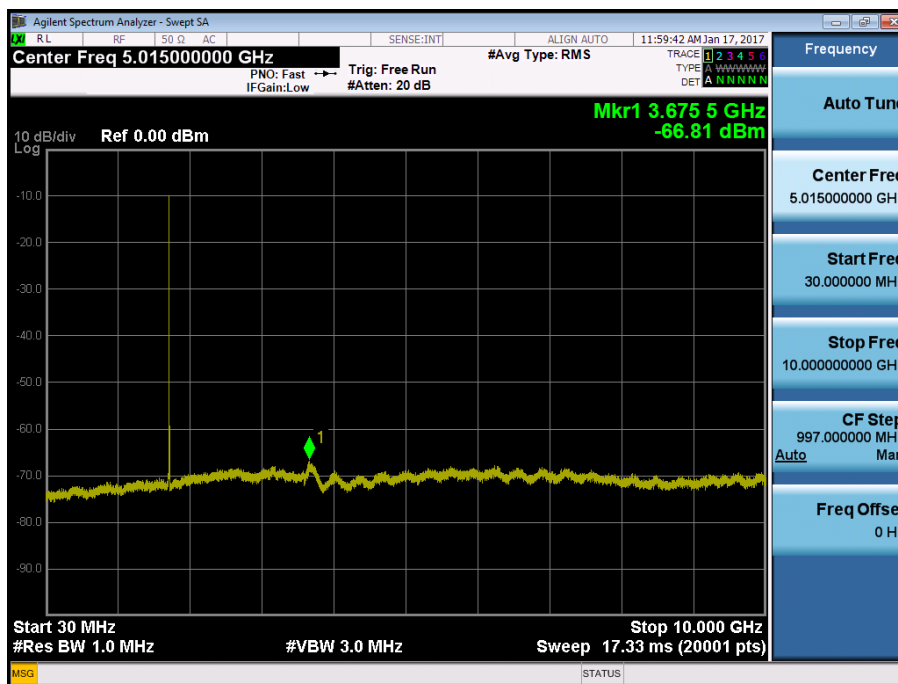

BAND 4. Conducted Spurious Plot_2 (20175ch_5MHz_QPSK_RB 1_0)



BAND 4. Conducted Spurious Plot_1 (20375ch_5MHz_QPSK_RB 1_0)

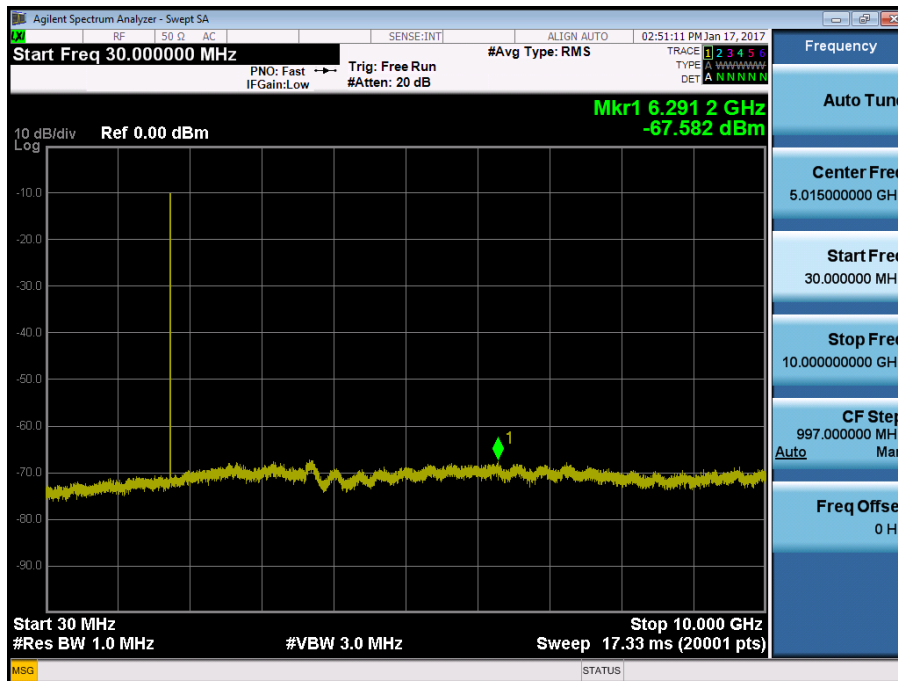

BAND 4. Conducted Spurious Plot_2 (20375ch_5MHz_QPSK_RB 1_0)

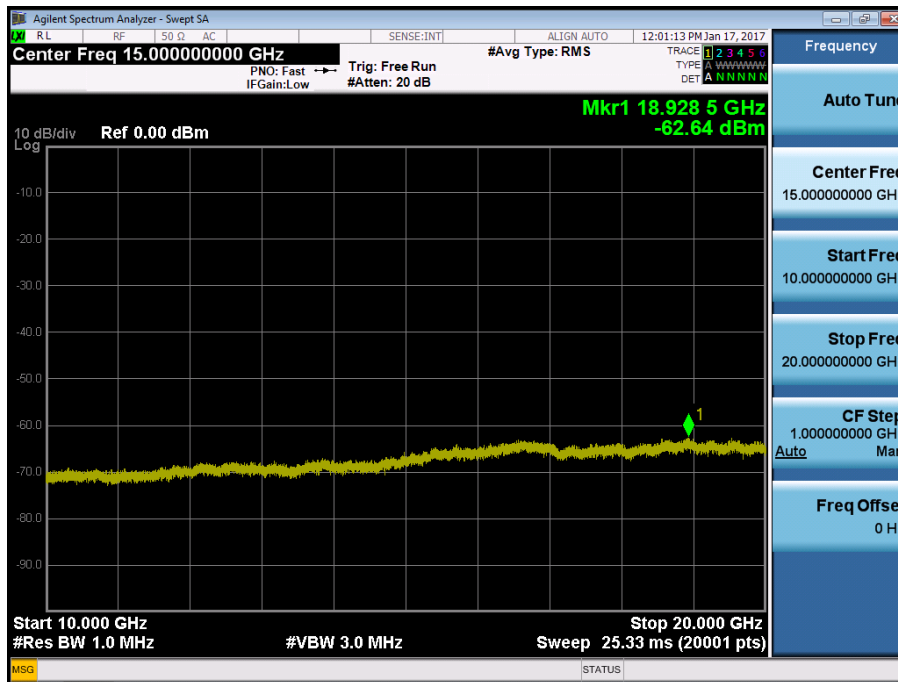

BAND 4. Conducted Spurious Plot_1 (20000ch_10MHz_QPSK_RB 1_0)

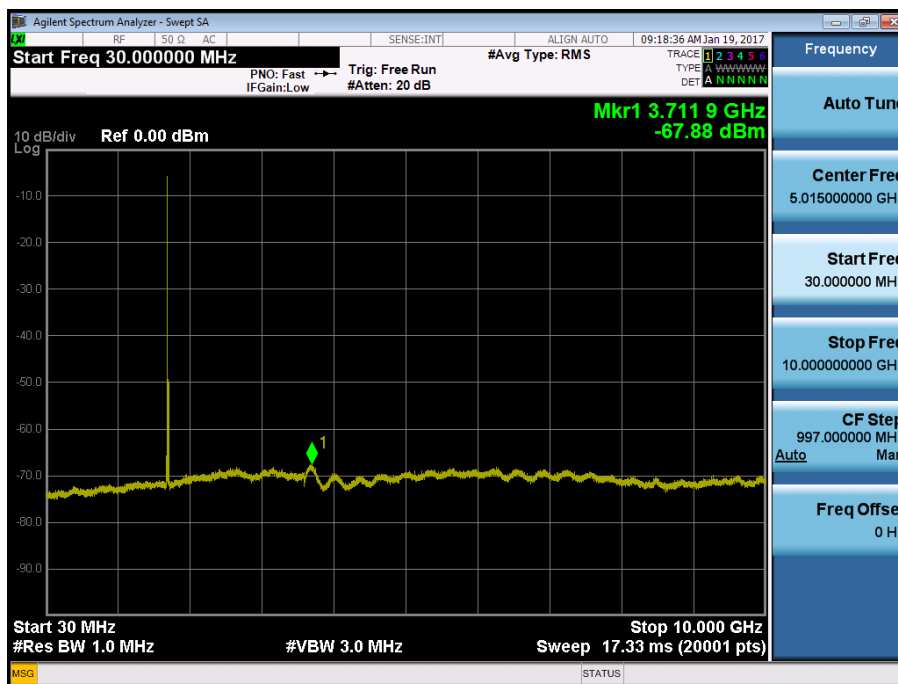

BAND 4. Conducted Spurious Plot_2 (20000ch_10MHz_QPSK_RB 1_0)

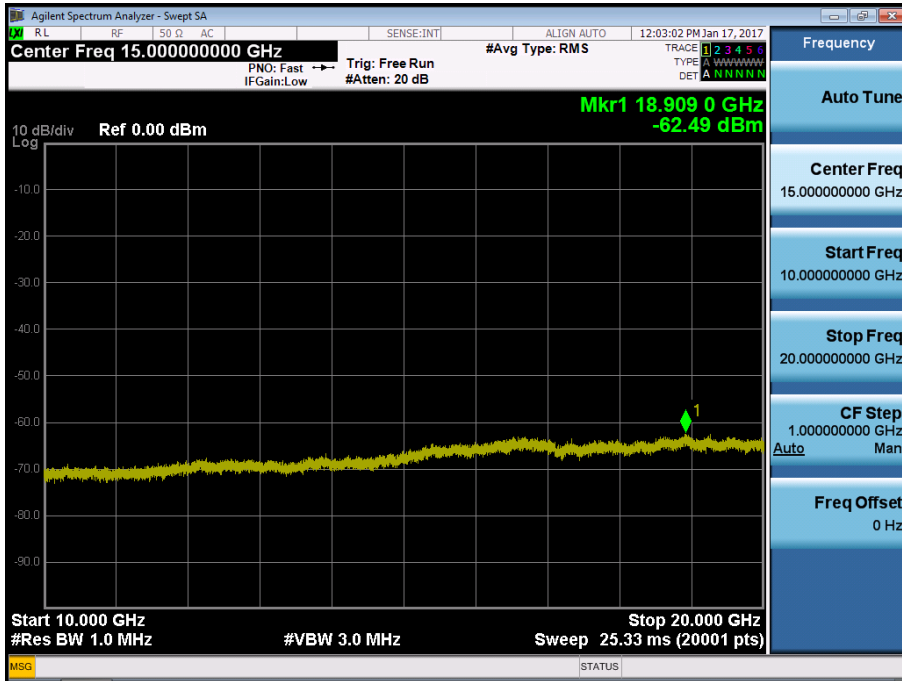

BAND 4. Conducted Spurious Plot_1 (20175ch_10MHz_QPSK_RB 1_0)

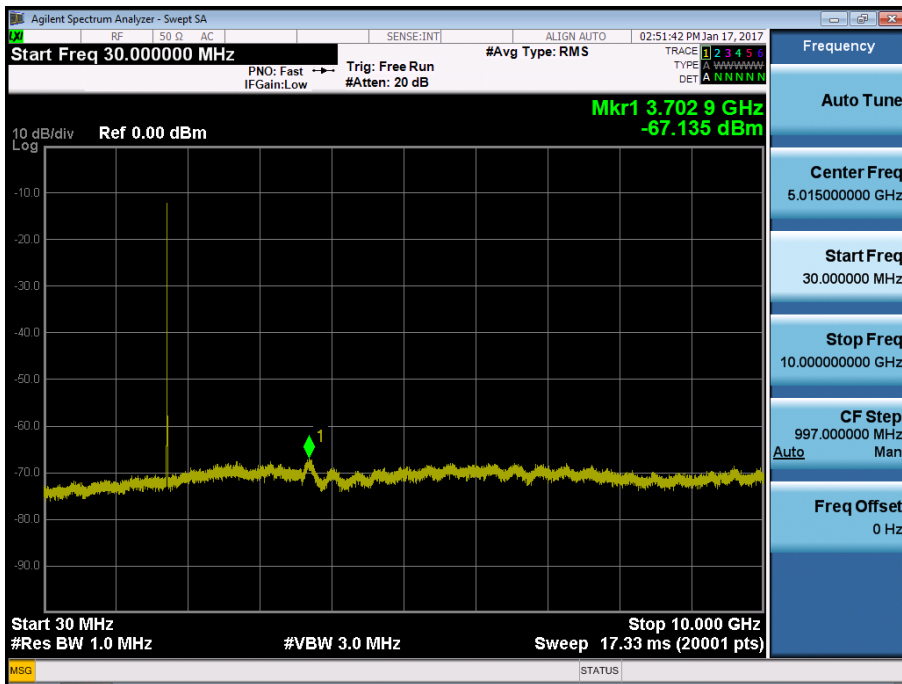

BAND 4. Conducted Spurious Plot_2 (20175ch_10MHz_QPSK_RB 1_0)

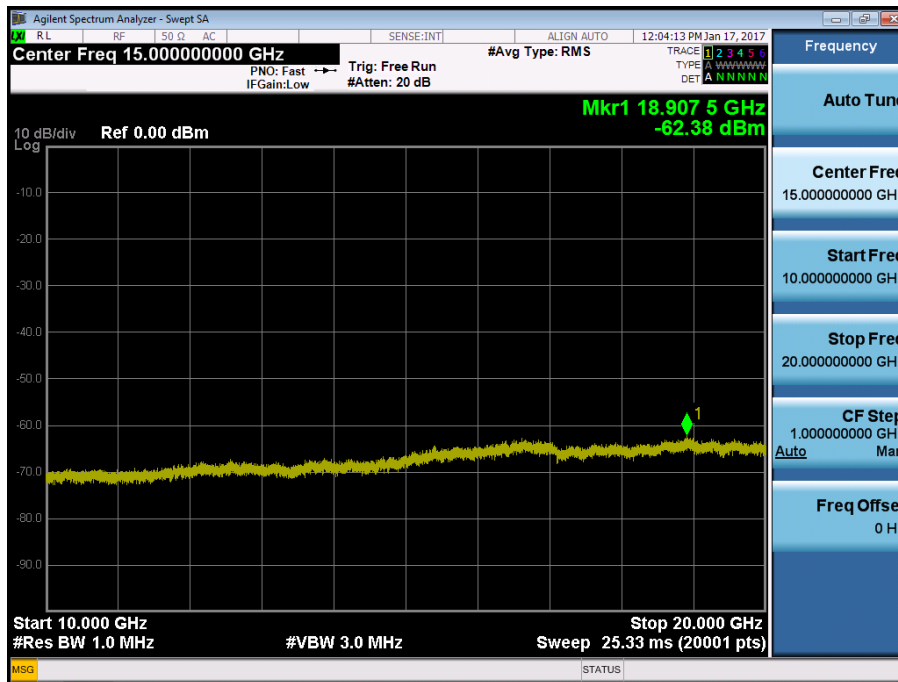

BAND 4. Conducted Spurious Plot_1 (20350ch_10MHz_QPSK_RB 1_0)

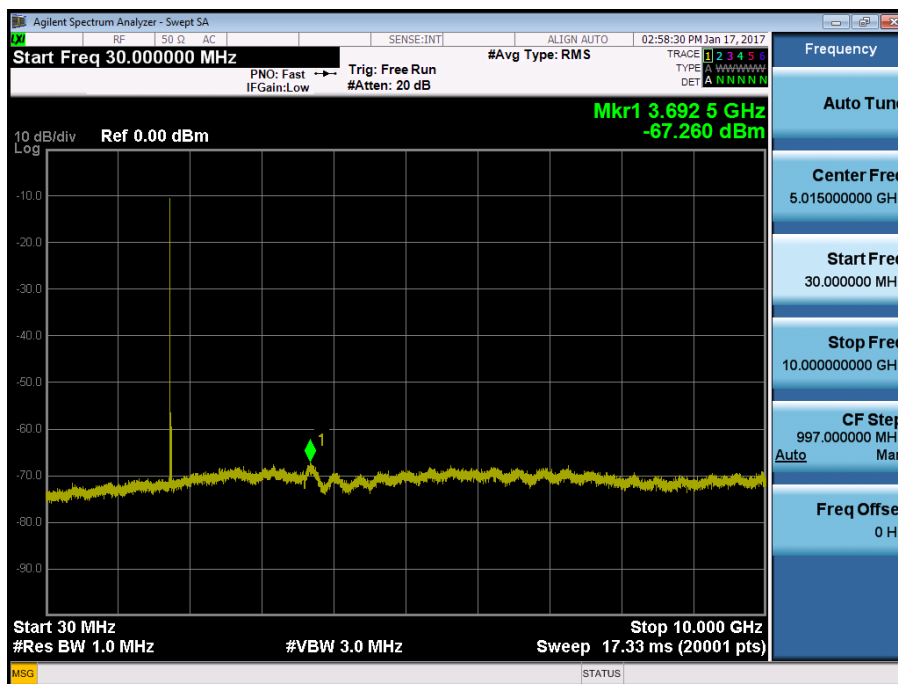

BAND 4. Conducted Spurious Plot_2 (20350ch_10MHz_QPSK_RB 1_0)

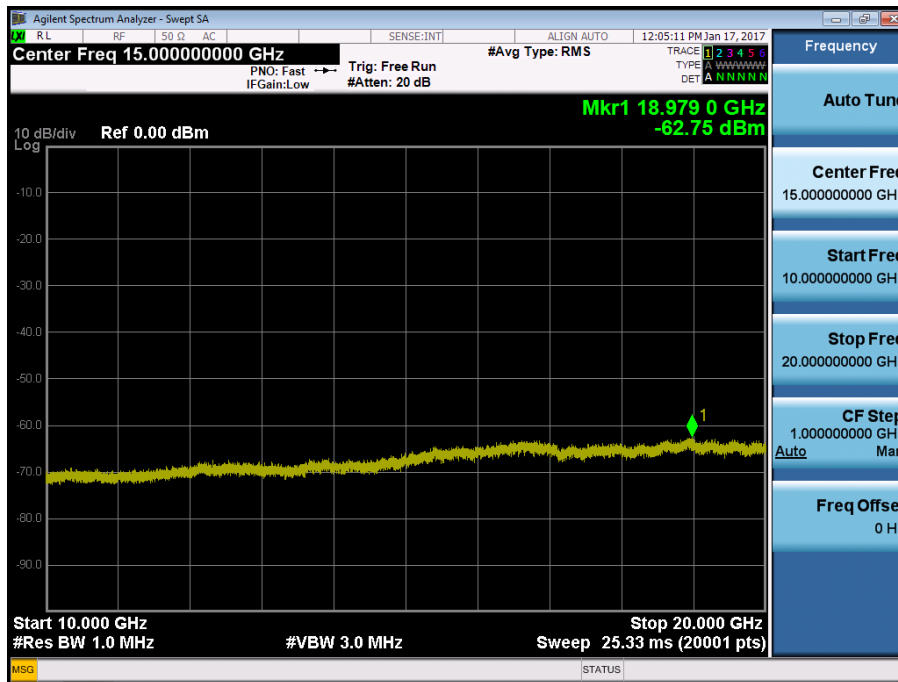

BAND 4. Conducted Spurious Plot_1 (20025ch_15MHz_QPSK_RB 1_0)

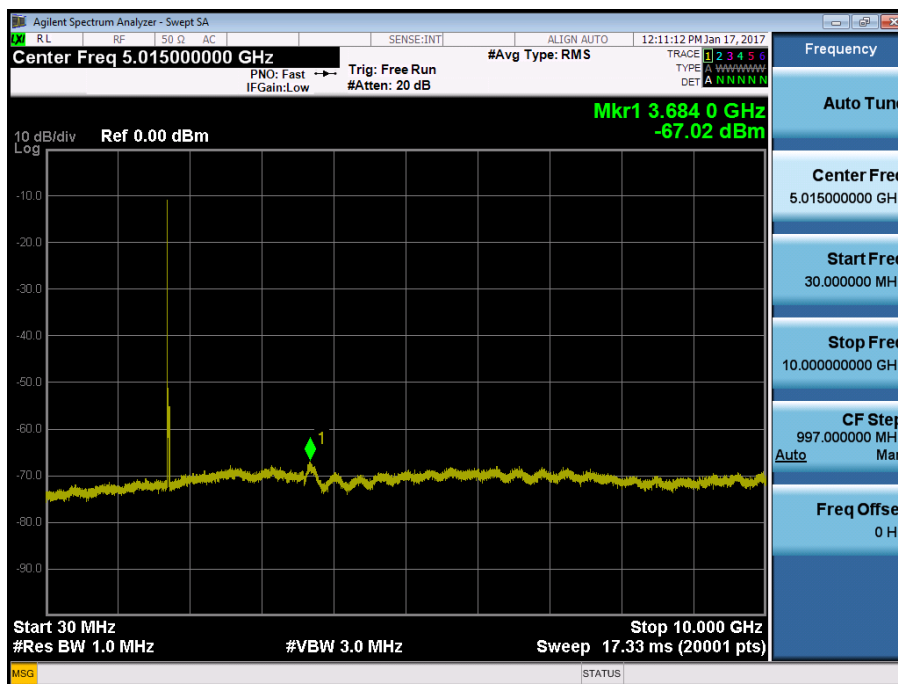

BAND 4. Conducted Spurious Plot_2 (20025ch_15MHz_QPSK_RB 1_0)

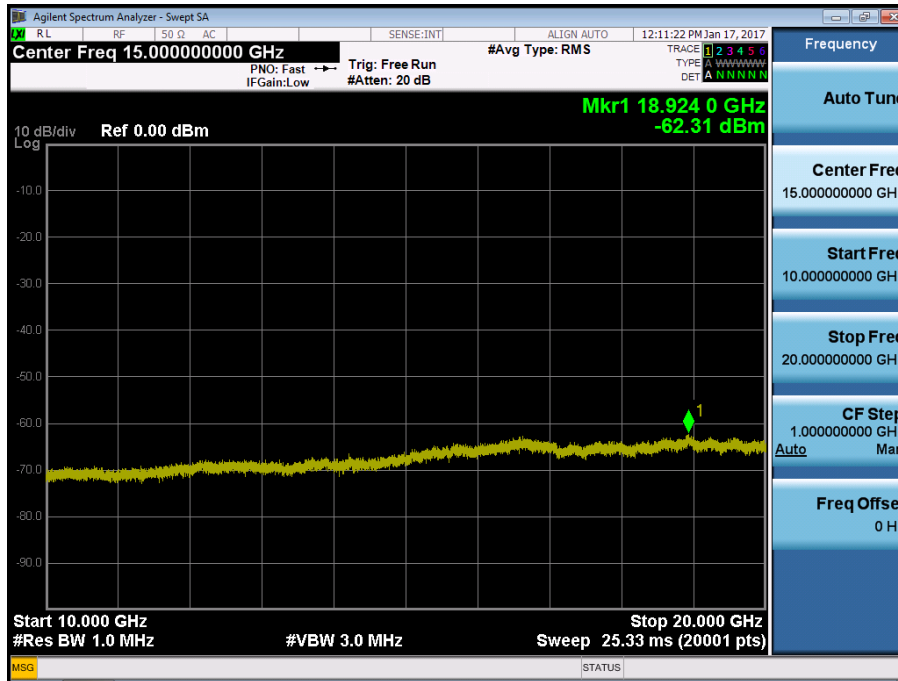

BAND 4. Conducted Spurious Plot_1 (20175ch_15MHz_QPSK_RB 1_0)

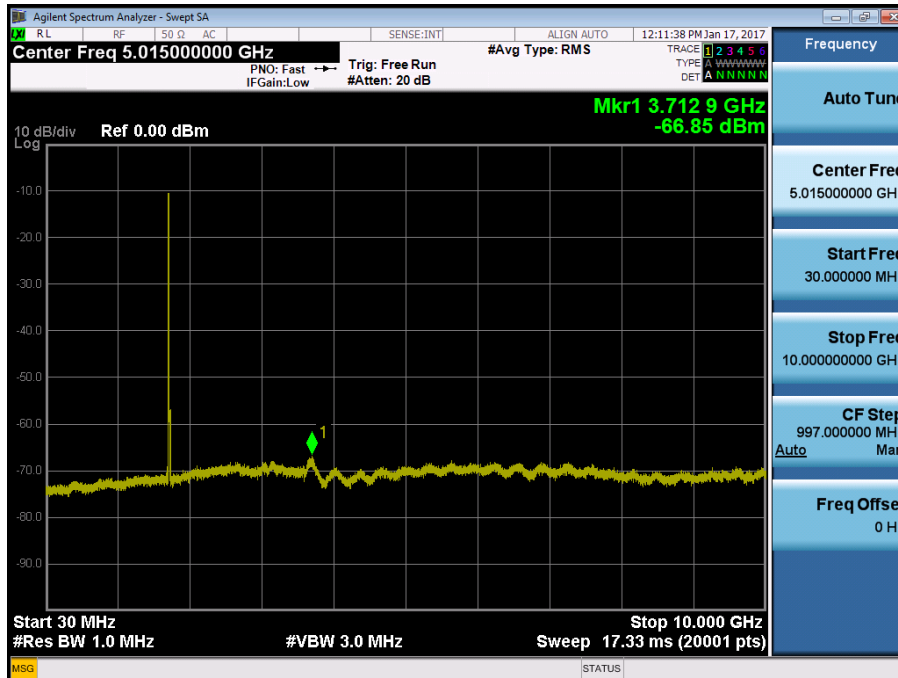

BAND 4. Conducted Spurious Plot_2 (20175ch_15MHz_QPSK_RB 1_0)

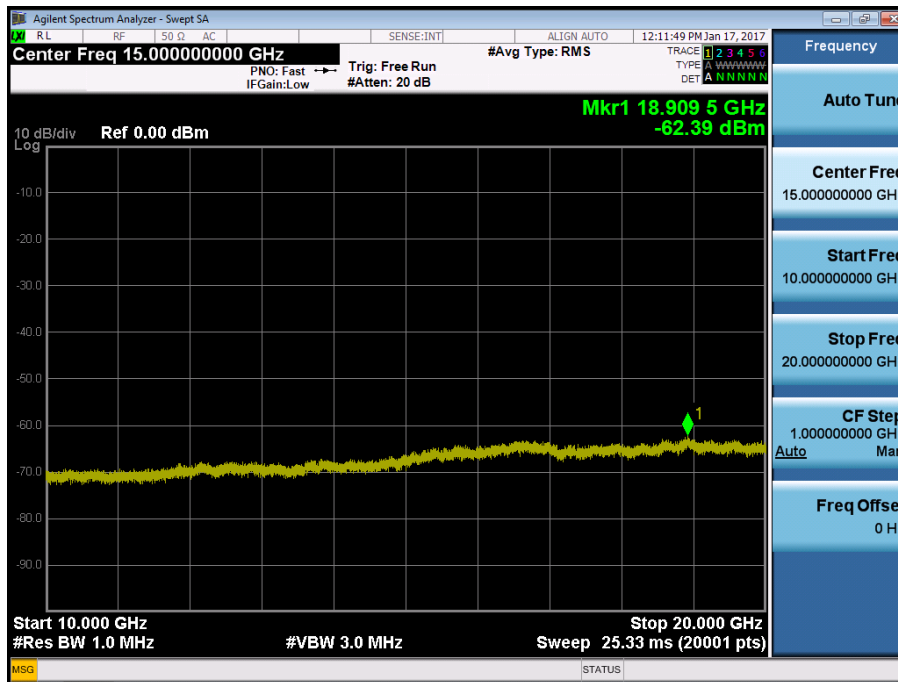

BAND 4. Conducted Spurious Plot_1 (20325ch_15MHz_QPSK_RB 1_0)

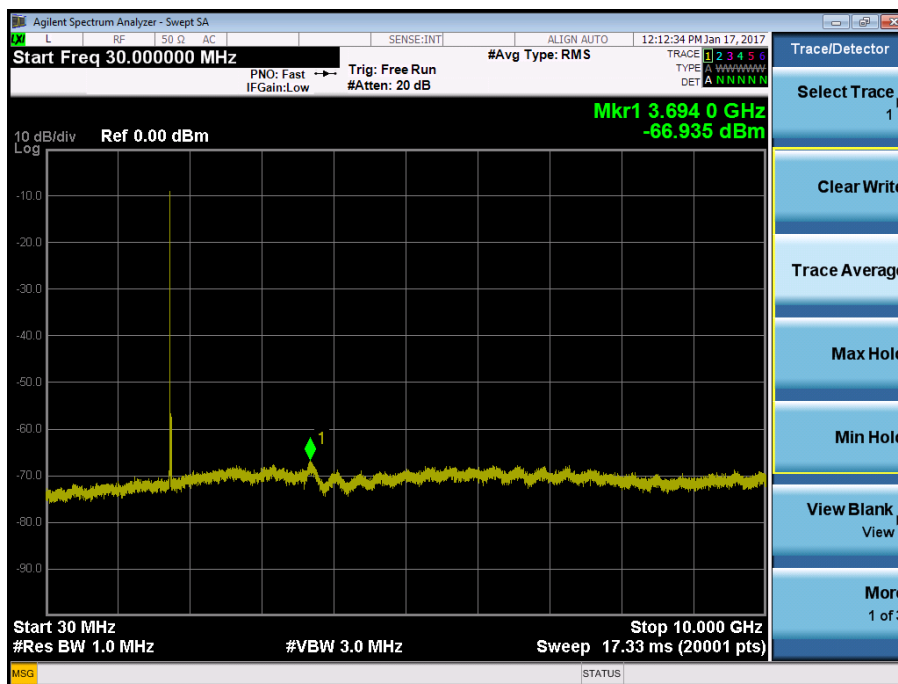

BAND 4. Conducted Spurious Plot_2 (20325ch_15MHz_QPSK_RB 1_0)

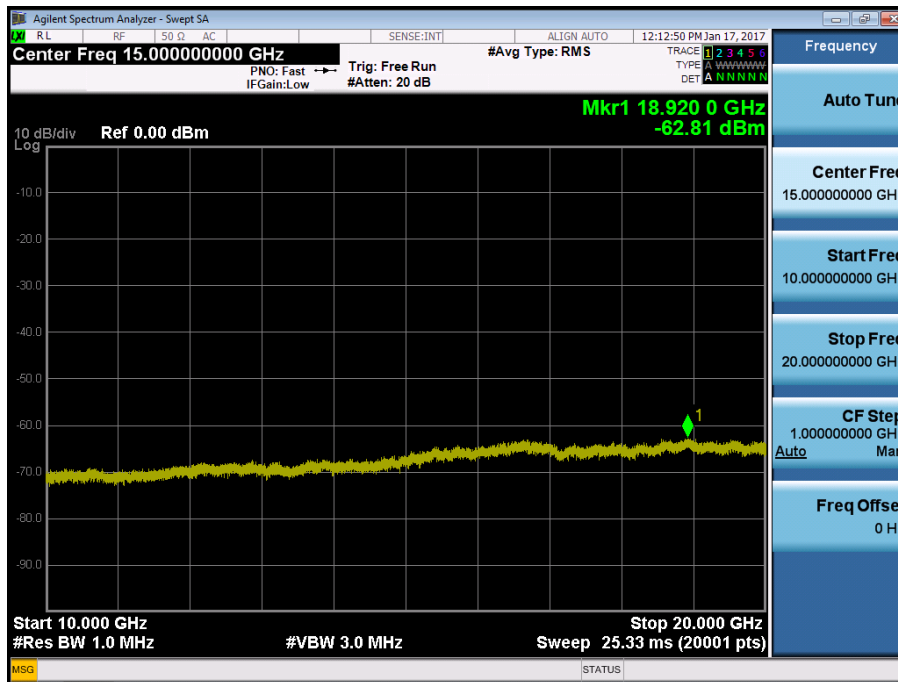

BAND 4. Conducted Spurious Plot_1 (20050ch_20MHz_QPSK_RB 1_0)

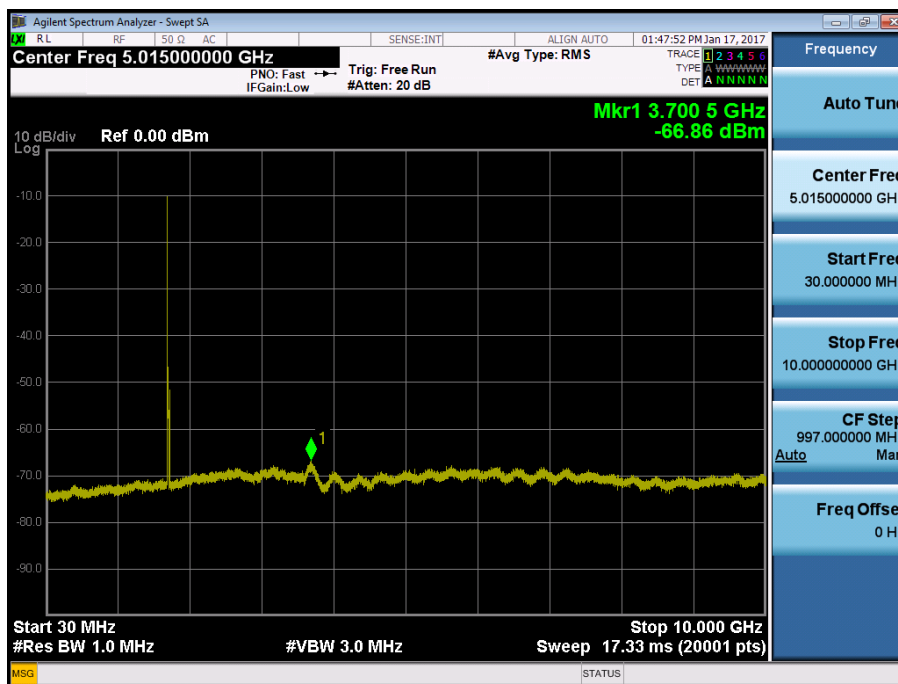

BAND 4. Conducted Spurious Plot_2 (20050ch_20MHz_QPSK_RB 1_0)

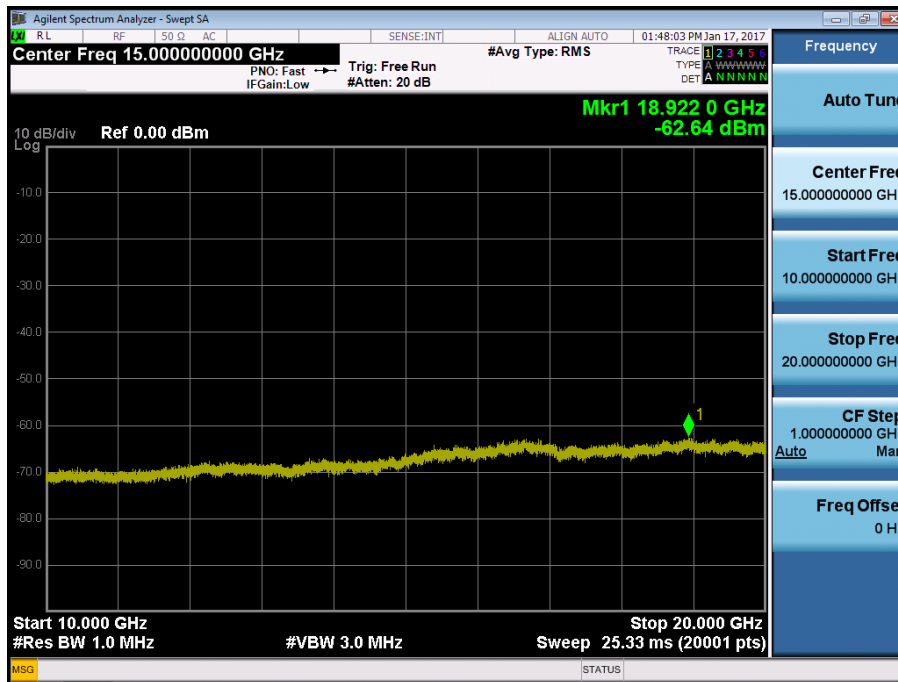

BAND 4. Conducted Spurious Plot_1 (20175ch_20MHz_QPSK_RB 1_0)

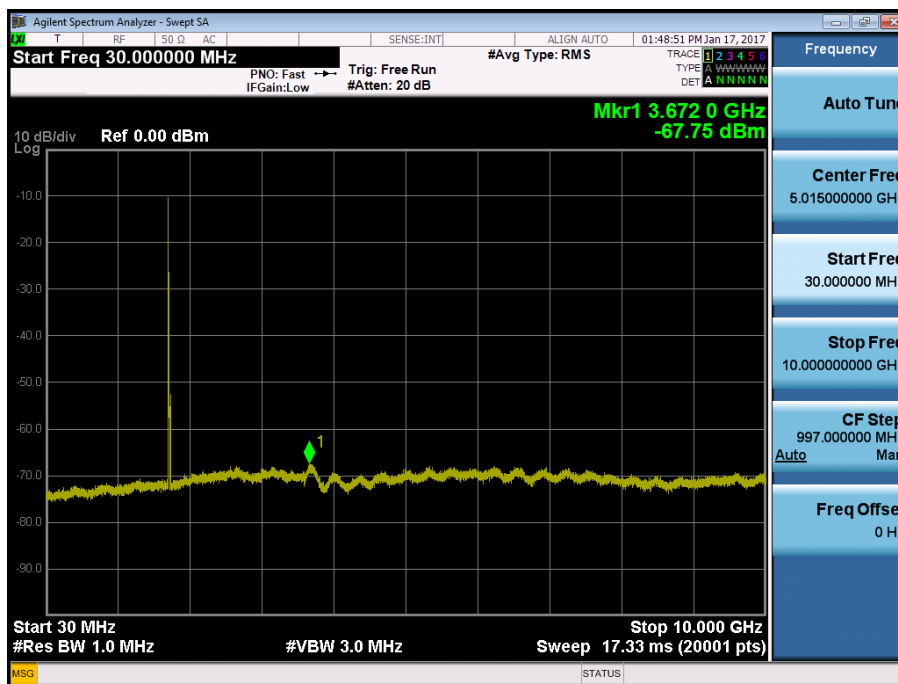

BAND 4. Conducted Spurious Plot_2 (20175ch_20MHz_QPSK_RB 1_0)

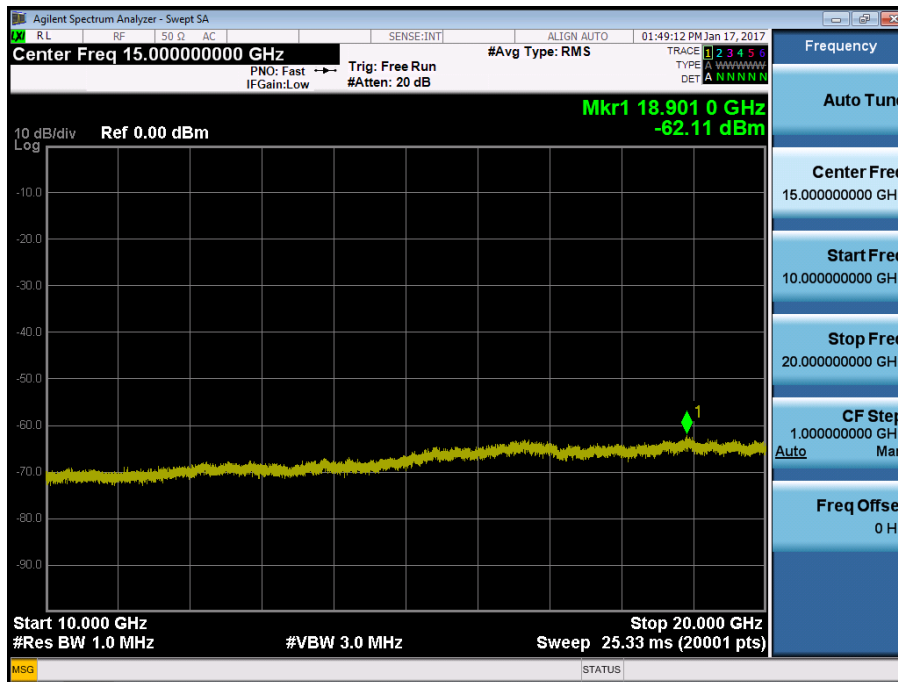

BAND 4. Conducted Spurious Plot_1 (20300ch_20MHz_QPSK_RB 1_0)

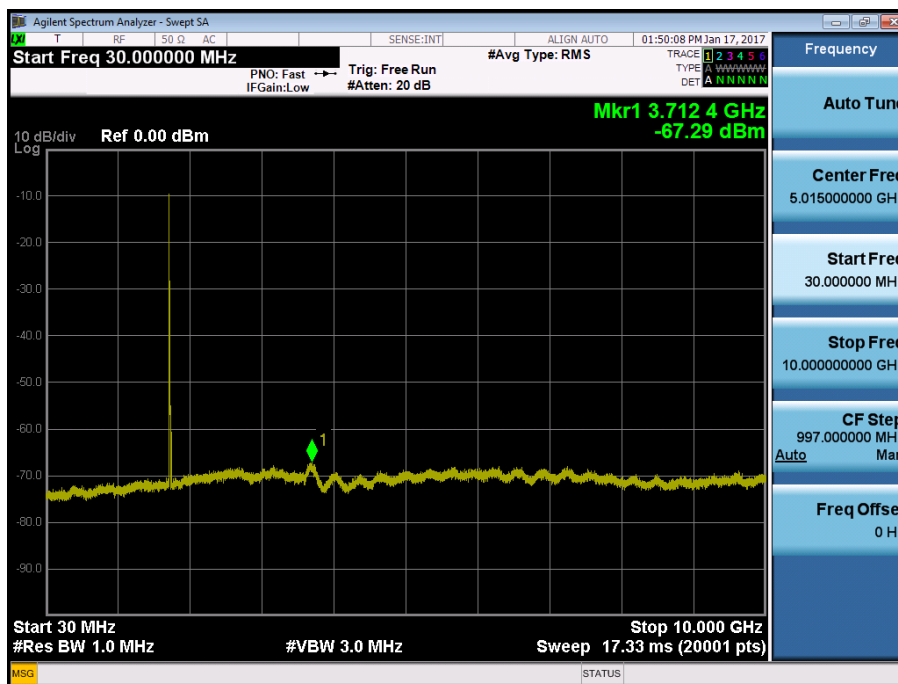

BAND 4. Conducted Spurious Plot_2 (20300ch_20MHz_QPSK_RB 1_0)

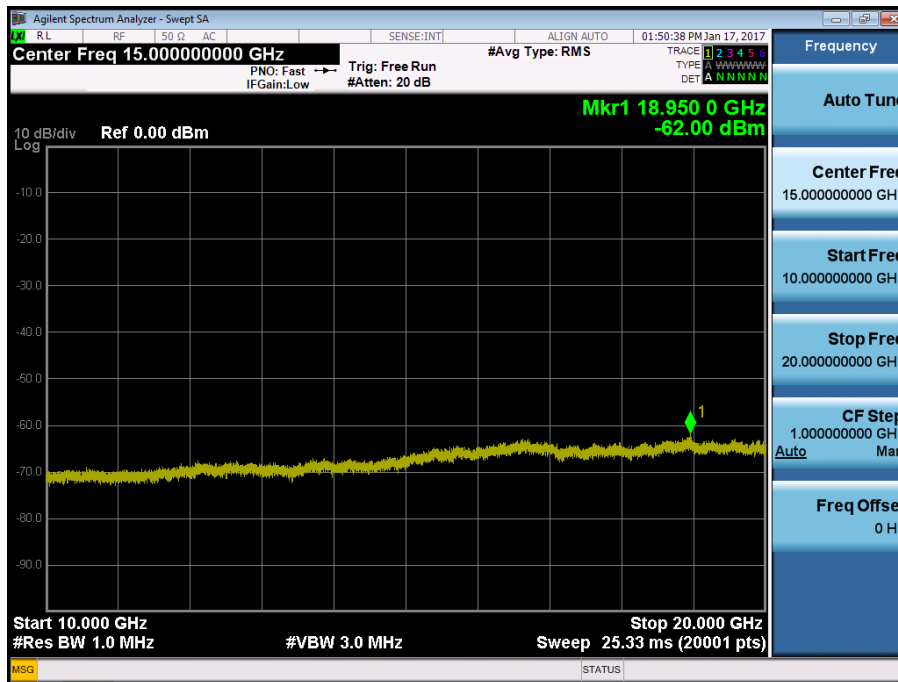

BAND 13. Conducted Spurious Plot_1 (23205ch_5MHz_QPSK_RB 1_0)

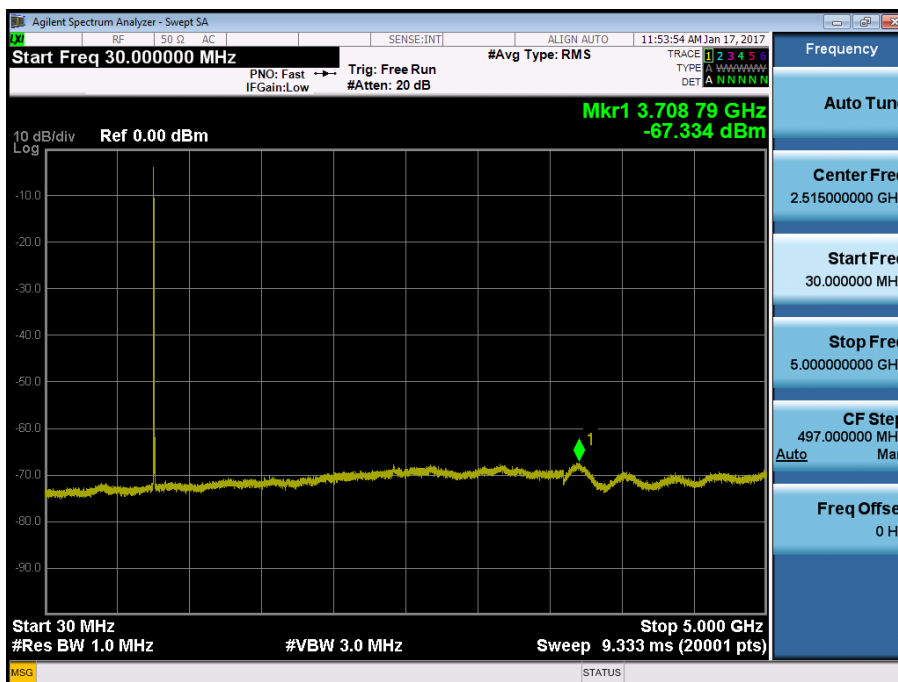

BAND 13. Conducted Spurious Plot_2 (23205ch_5MHz_QPSK_RB 1_0)

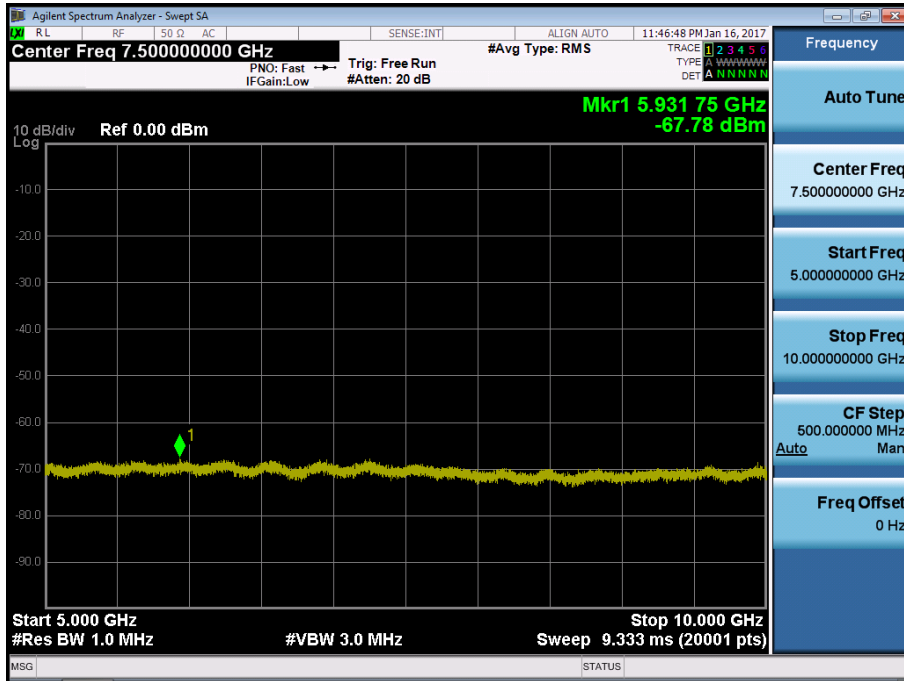

BAND 13. Conducted Spurious Plot_1 (23230ch_5MHz_QPSK_RB 1_0)

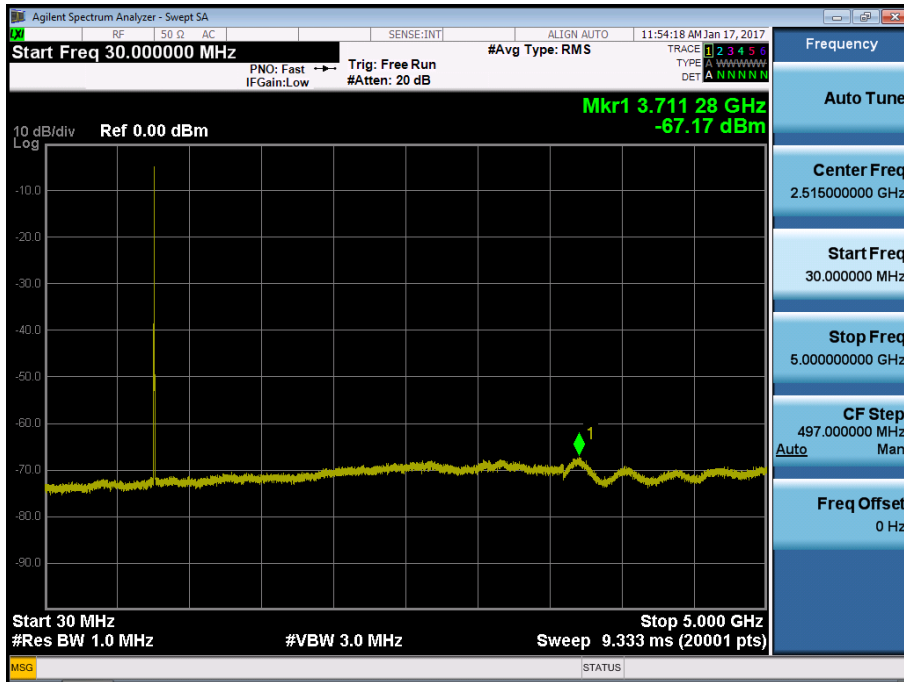

BAND 13. Conducted Spurious Plot_2 (23230ch_5MHz_QPSK_RB 1_0)

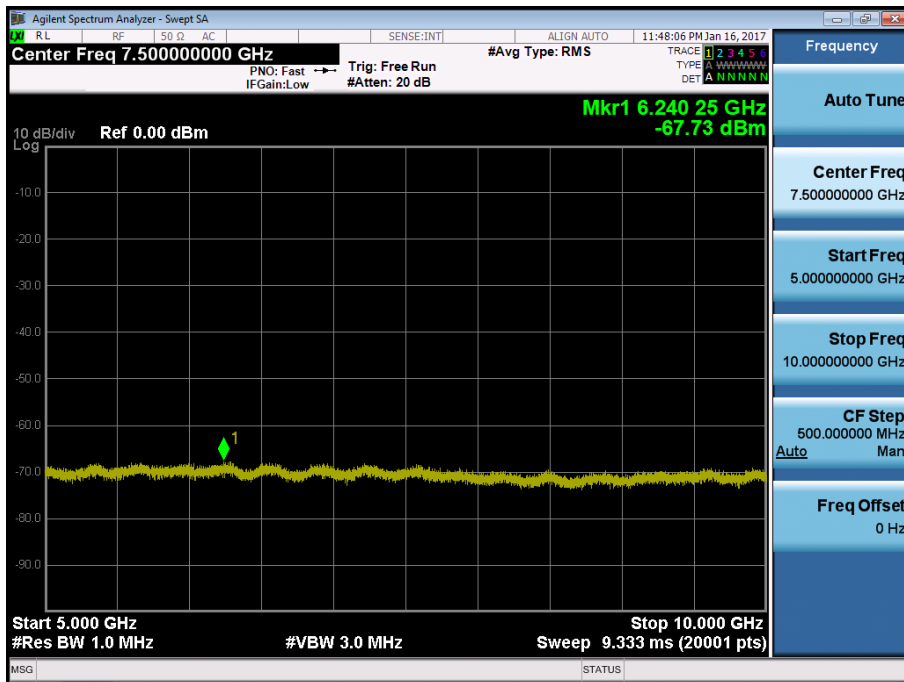

BAND 13. Conducted Spurious Plot_1 (23255ch_5MHz_QPSK_RB 1_0)



BAND 13. Conducted Spurious Plot_2 (23255ch_5MHz_QPSK_RB 1_0)

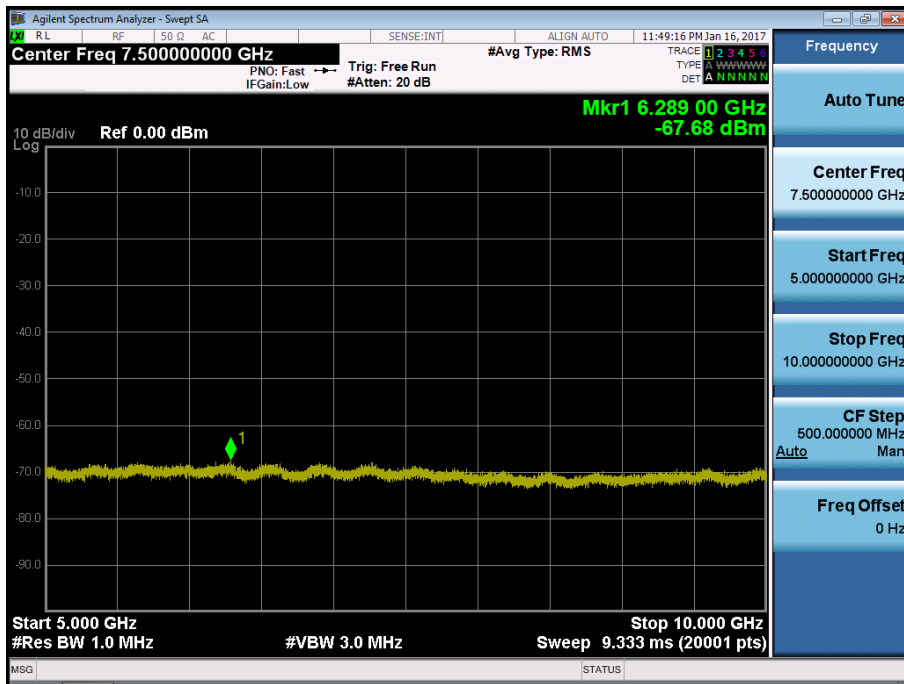

BAND 13. Conducted Spurious Plot 1 (Ch.23230 10 MHz QPSK RB 1, Offset 0)

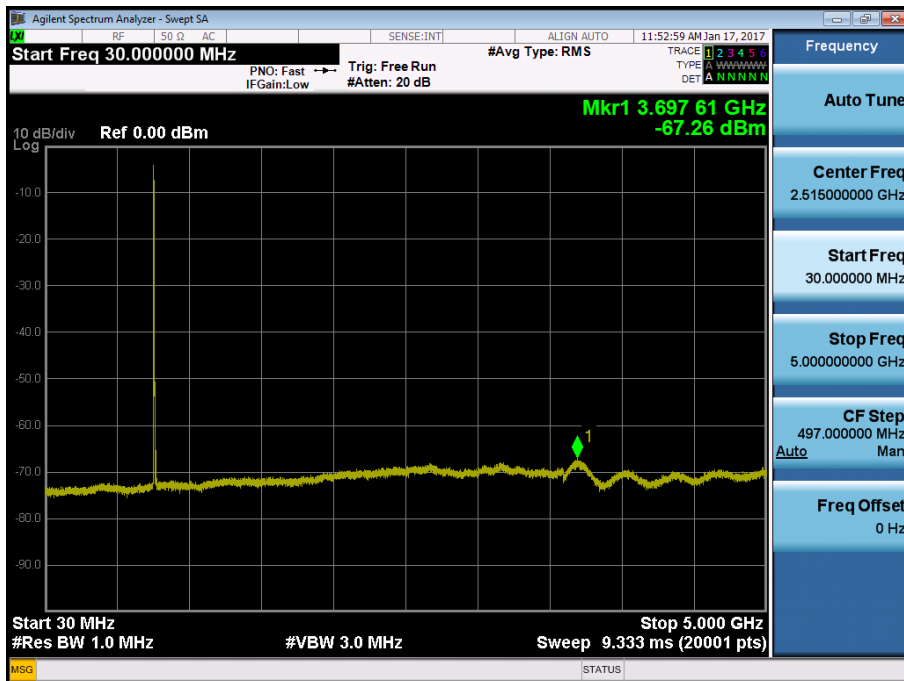

BAND 13. Conducted Spurious Plot 2 (Ch.23230 10 MHz QPSK RB 1, Offset 0)

