

# FCC Test Report

## (PART 24)

**Report No.:** RF161117C09-2

**FCC ID:** XHG-R872

**Test Model:** R872

**Received Date:** Nov. 17, 2016

**Test Date:** Jan. 06, 2017 ~ Jan. 18, 2017

**Issued Date:** Jan. 24, 2017

**Applicant:** Franklin Technology Inc.

**Address:** 906 JEI Platz, 186, Gasan digital 1-ro, Geumcheon-gu, Seoul, Korea,  
(08502)

**Issued By:** Bureau Veritas Consumer Products Services (H.K.) Ltd., Taoyuan Branch

**Lab Address:** No. 47-2, 14th Ling, Chia Pau Vil., Lin Kou Dist., New Taipei City, Taiwan  
( R.O.C )

**Test Location:** No.19, Hwa Ya 2nd Rd., Wen Hwa Vil., Kwei Shan Dist., Taoyuan City  
33383, TAIWAN (R.O.C.)



This report is for your exclusive use. Any copying or replication of this report to or for any other person or entity, or use of our name or trademark, is permitted only with our prior written permission. This report sets forth our findings solely with respect to the test samples identified herein. The results set forth in this report are not indicative or representative of the quality or characteristics of the lot from which a test sample was taken or any similar or identical product unless specifically and expressly noted. Our report includes all of the tests requested by you and the results thereof based upon the information that you provided to us. You have 60 days from date of issuance of this report to notify us of any material error or omission caused by our negligence, provided, however, that such notice shall be in writing and shall specifically address the issue you wish to raise. A failure to raise such issue within the prescribed time shall constitute your unqualified acceptance of the completeness of this report, the tests conducted and the correctness of the report contents. Unless specific mention, the uncertainty of measurement has been explicitly taken into account to declare the compliance or non-compliance to the specification. The report must not be used by the client to claim product certification, approval, or endorsement by TAF or any government agencies.

## Table of Contents

<b>Release Control Record</b> .....	<b>3</b>
<b>1 Certificate of Conformity</b> .....	<b>4</b>
<b>2 Summary of Test Results</b> .....	<b>5</b>
2.1 Measurement Uncertainty .....	5
2.2 Test Site And Instruments .....	6
<b>3 General Information</b> .....	<b>8</b>
3.1 General Description of EUT .....	8
3.2 Configuration of System under Test.....	9
3.2.1 Description of Support Units .....	9
3.3 Test Mode Applicability and Tested Channel Detail .....	10
3.4 EUT Operating Conditions .....	10
3.5 General Description of Applied Standards.....	11
<b>4 Test Types and Results</b> .....	<b>12</b>
4.1 Output Power Measurement .....	12
4.1.1 Limits of Output Power Measurement .....	12
4.1.2 Test Procedures.....	12
4.1.3 Test Setup .....	13
4.1.4 Test Results .....	14
4.2 Frequency Stability Measurement .....	15
4.2.1 Limits of Frequency Stability Measurement.....	15
4.2.2 Test Procedure .....	15
4.2.3 Test Setup .....	15
4.2.4 Test Results .....	16
4.3 Occupied Bandwidth Measurement.....	17
4.3.1 Test Procedure .....	17
4.3.2 Test Setup.....	17
4.3.3 Test Result .....	17
4.4 Band Edge Measurement .....	18
4.4.1 Limits of Band Edge Measurement .....	18
4.4.2 Test Setup.....	18
4.4.3 Test Procedures.....	18
4.4.4 Test Results .....	18
4.5 Peak to Average Ratio .....	19
4.5.1 Limits of Peak to Average Ratio Measurement .....	19
4.5.2 Test Setup.....	19
4.5.3 Test Procedures.....	19
4.5.4 Test Results .....	19
4.6 Conducted Spurious Emissions.....	20
4.6.1 Limits of Conducted Spurious Emissions Measurement.....	20
4.6.2 Test Setup.....	20
4.6.3 Test Procedure .....	20
4.6.4 Test Results .....	21
4.7 Radiated Emission Measurement.....	22
4.7.1 Limits of Radiated Emission Measurement .....	22
4.7.2 Test Procedure .....	22
4.7.3 Deviation from Test Standard .....	22
4.7.4 Test Setup.....	22
4.7.5 Test Results .....	23
<b>5 Pictures of Test Arrangements</b> .....	<b>29</b>
<b>Appendix – Information on the Testing Laboratories</b> .....	<b>30</b>

### Release Control Record

Issue No.	Description	Date Issued
RF161117C09-2	Original Release	Jan. 24, 2017

## 1 Certificate of Conformity

**Product:** Mobile Hotspot

**Brand:** Franklin

**Test Model:** R872

**Sample Status:** Production Unit

**Applicant:** Franklin Technology Inc.

**Test Date:** Jan. 06, 2017 ~ Jan. 18, 2017

**Standards:** FCC Part 24, Subpart E

The above equipment has been tested by **Bureau Veritas Consumer Products Services (H.K.) Ltd., Taoyuan Branch**, and found compliance with the requirement of the above standards. The test record, data evaluation & Equipment Under Test (EUT) configurations represented herein are true and accurate accounts of the measurements of the sample's EMC characteristics under the conditions specified in this report.

**Prepared by :** Rona Chen, **Date:** Jan. 24, 2017  
Rona Chen / Specialist

**Approved by :** Stanley Wu, **Date:** Jan. 24, 2017  
Stanley Wu / Assistant Manager

## 2 Summary of Test Results

Applied Standard: FCC Part 24 & Part 2			
FCC Clause	Test Item	Result	Remarks
2.1046 24.232	Effective Isotropic Radiated Power	Pass	Meet the requirement of limit.
2.1046 24.232(d)	Peak to Average Ratio	Pass	Meet the requirement of limit.
2.1055 24.235	Frequency Stability	Pass	Meet the requirement of limit.
2.1049 24.238(b)	Occupied Bandwidth	Pass	Meet the requirement of limit.
24.238(b)	Band Edge Measurements	Pass	Meet the requirement of limit.
2.1051 24.238	Conducted Spurious Emissions	Pass	Meet the requirement of limit.
2.1053 24.238	Radiated Spurious Emissions	Pass	Meet the requirement of limit. Minimum passing margin is -15.18 dB at 5553.75 MHz.

### 2.1 Measurement Uncertainty

Where relevant, the following measurement uncertainty levels have been estimated for tests performed on the EUT as specified in CISPR 16-4-2:

Measurement	Frequency	Expanded Uncertainty (k=2) (±)
Conducted Emissions at mains ports	150 kHz ~ 30 MHz	2.44 dB
Radiated Emissions up to 1 GHz	30 MHz ~ 200 MHz	2.93 dB
	200 MHz ~ 1000 MHz	2.95 dB
Radiated Emissions above 1 GHz	1 GHz ~ 18 GHz	2.26 dB
	18 GHz ~ 40 GHz	1.94 dB

## 2.2 Test Site And Instruments

Description & Manufacturer	Model No.	Serial No.	Date of Calibration	Due Date of Calibration
Test Receiver Agilent	N9038A	MY51210203	Jan. 21, 2016	Jan. 20, 2017
Spectrum Analyzer Agilent	N9010A	MY52220314	Dec. 16, 2016	Dec. 15, 2017
Spectrum Analyzer ROHDE & SCHWARZ	FSU43	101261	Dec. 13, 2016	Dec. 12, 2017
BILOG Antenna SCHWARZBECK	VULB9168	9168-472	Dec. 26, 2016	Dec. 27, 2017
HORN Antenna SCHWARZBECK	BBHA 9120 D	9120D-969	Dec. 12, 2016	Dec. 13, 2017
Double Ridge Guide Horn Antenna EMCO	3115	5619	Dec. 26, 2016	Dec. 27, 2017
BILOG Antenna SCHWARZBECK	VULB 9168	9168-153	Dec. 12, 2016	Dec. 13, 2017
Fixed Attenuator Mini-Circuits	BW-N10W5+	NA	Jul. 08, 2016	Jul. 07, 2017
MXG Vector signal generator Agilent	N5182B	MY53050430	Oct. 19, 2016	Oct. 18, 2017
Preamplifier EMCI	EMC 012645	980115	Oct. 21, 2016	Oct. 20, 2017
Preamplifier EMCI	EMC 184045	980116	Oct. 21, 2016	Oct. 20, 2017
Preamplifier EMCI	EMC 330H	980112	Oct. 21, 2016	Oct. 20, 2017
Power Meter Anritsu	ML2495A	1232002	Sep. 08, 2016	Sep. 07, 2017
Power Sensor Anritsu	MA2411B	1207325	Sep. 08, 2016	Sep. 07, 2017
RF signal cable HUBER+SUHNNER	SUCOFLEX 104	309219/4 2950114	Oct. 21, 2016	Oct. 20, 2017
RF signal cable HUBER+SUHNNER	SUCOFLEX 104	250130/4	Oct. 21, 2016	Oct. 20, 2017
RF Coaxial Cable Worken	8D-FB	Cable-Ch10-01	Oct. 21, 2016	Oct. 20, 2017
Software BV ADT	E3 6.120103	NA	NA	NA
Antenna Tower MF	MFA-440H	NA	NA	NA
Turn Table MF	MFT-201SS	NA	NA	NA
Antenna Tower & Turn Table Controller MF	MF-7802	NA	NA	NA
Fixed Attenuator Mini-Circuits	BW-N10W5+	NA	Jul. 08, 2016	Jul. 07, 2017
Radio Communication Analyzer	MT8820C	6201300640	Aug. 10, 2015	Aug. 09, 2017
Communications Tester-Wireless	8960 Series 10	MY53201073	Jul. 03, 2015	Jul. 02, 2017

- Note:
1. The calibration interval of the above test instruments is 12 / 24 months and the calibrations are traceable to NML/ROC and NIST/USA.
  2. The test was performed in HwaYa Chamber 10.
  3. The horn antenna and preamplifier (model: EMC 184045) are used only for the measurement of emission frequency above 1 GHz if tested.
  4. The FCC Site Registration No. is 690701.
  5. The IC Site Registration No. is IC7450F-10.

### 3 General Information

#### 3.1 General Description of EUT

<b>Product</b>	Mobile Hotspot	
<b>Brand</b>	Franklin	
<b>Test Model</b>	R872	
<b>Status of EUT</b>	Production Unit	
<b>Power Supply Rating</b>	5.0 Vdc (adapter or host equipment) 3.8 Vdc (Li-ion battery)	
<b>Modulation Type</b>	CDMA	QPSK, OQPSK, HPSK
<b>Frequency Range</b>	CDMA	1851.3 ~ 1908.8 MHz
<b>Max. EIRP Power</b>	CDMA	51.80 mW
<b>Emission Designator</b>	CDMA	1M27F9W
<b>Antenna Type</b>	Fixed Internal Antenna	
<b>Accessory Device</b>	Refer to Note as below	
<b>Data Cable Supplied</b>	Refer to Note as below	

Note:

- The EUT contains following accessory devices.

Product	Brand	Model	Description
Adapter	Franklin Wireless	FWCR900TVL	I/P: 100-240 Vac, 0.3 A O/P: 5 Vdc, 1 A 1.5 m cable non-shielded cable w/o core
Battery	Franklin Wireless	R871	3.8 Vdc, 2450 mAh

- The above EUT information is declared by manufacturer and for more detailed features description, please refer to the manufacturer's specifications or user's manual.



### 3.2 Configuration of System under Test

#### <Radiated Emission Test>

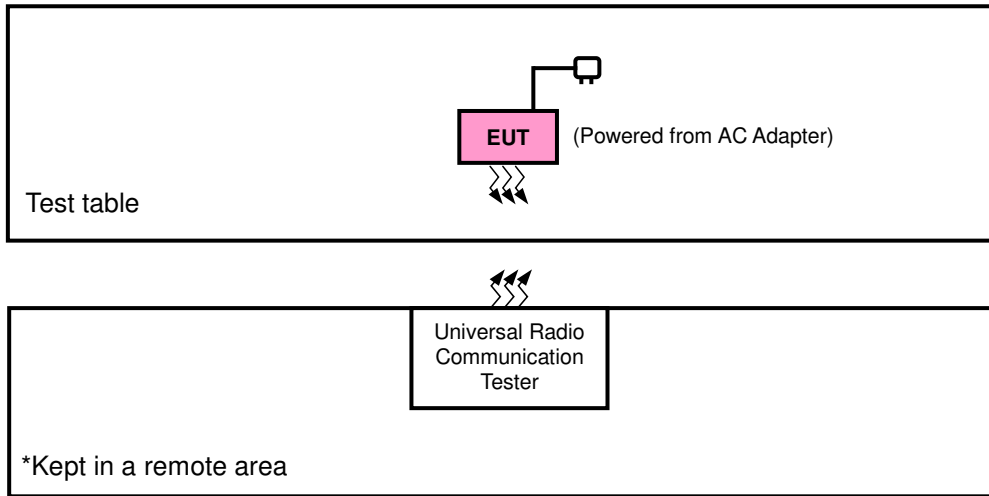

#### <E.I.R.P. Test>

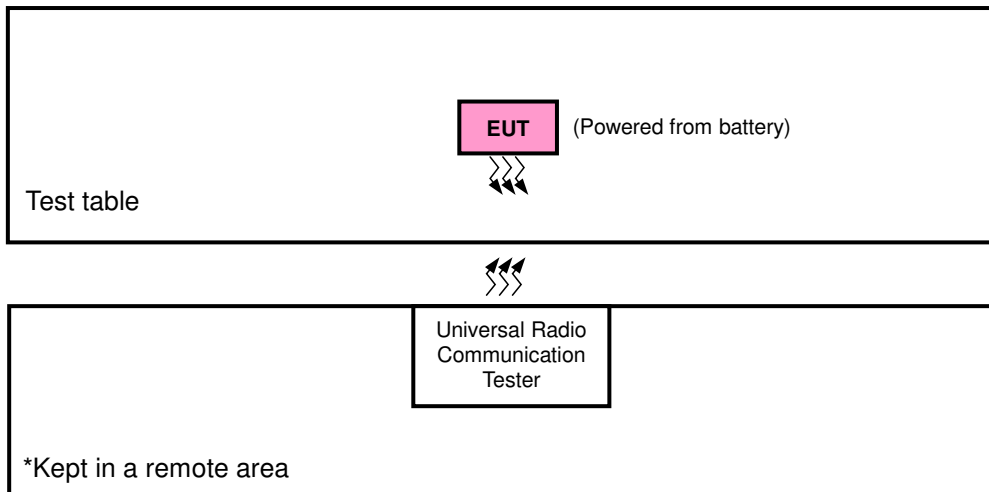

#### 3.2.1 Description of Support Units

The EUT has been tested as an independent unit together with other necessary accessories or support units.

### 3.3 Test Mode Applicability and Tested Channel Detail

Pre-Scan has been conducted to determine the worst-case mode from all possible combinations between available modulations, data rates, XYZ axis, and antenna ports.

The worst case was found when positioned as the table below. Following channel(s) was (were) selected for the final test as listed below:

Band	EIRP	Radiated Emission
CDMA	Y-plane	Z-axis

#### CDMA

EUT Configure Mode	Test Item	Available Channel	Tested Channel	Mode
-	ERP	25 to 1175	25, 600, 1175	1xEVDO
-	Frequency Stability	25 to 1175	25, 1175	1xEVDO
-	Occupied Bandwidth	25 to 1175	25, 600, 1175	1xEVDO
-	Band Edge	25 to 1175	25, 600, 1175	1xEVDO
-	Peak to Average Ratio	25 to 1175	25, 1175	1xEVDO
-	Conducuted Emission	25 to 1175	25, 600, 1175	1xEVDO
-	Radiated Emission	25 to 1175	25, 600, 1175	1xEVDO

#### Test Condition:

Test Item	Environmental Conditions	Input Power	Tested By
EIRP	26 deg. C, 58 % RH	3.8 Vdc	Gavin Wu
Frequency Stability	26 deg. C, 58 % RH	3.8 Vdc	Carlos Chen
Occupied Bandwidth	26 deg. C, 58 % RH	3.8 Vdc	Carlos Chen
Band Edge	26 deg. C, 58 % RH	3.8 Vdc	Carlos Chen
Peak to Average Ratio	26 deg. C, 58 % RH	3.8 Vdc	Carlos Chen
Conducuted Emission	26 deg. C, 58 % RH	3.8 Vdc	Carlos Chen
Radiated Emission	25 deg. C, 65 % RH	120 Vac, 60 Hz	Gavin Wu

### 3.4 EUT Operating Conditions

The EUT makes a call to the communication simulator. The communication simulator station system controlled a EUT to export maximum output power under transmission mode and specific channel frequency

### **3.5 General Description of Applied Standards**

The EUT is a RF Product. According to the specifications of the manufacturer, it must comply with the requirements of the following standards:

**FCC 47 CFR Part 2**

**FCC 47 CFR Part 24**

**KDB 971168 D01 Power Meas License Digital Systems v02r02**

**ANSI/TIA/EIA-603-D 2010**

**NOTE:** All test items have been performed and recorded as per the above standards.

## 4 Test Types and Results

### 4.1 Output Power Measurement

#### 4.1.1 Limits of Output Power Measurement

Mobile / Portable station are limited to 2 watts e.i.r.p.

#### 4.1.2 Test Procedures

##### **EIRP / ERP Measurement:**

- a. All measurements were done at low, middle and high operational frequency range. RBW and VBW is 5 MHz for CDMA and 10 MHz for LTE mode.
- b. Substitution method is used for E.I.R.P measurement. In the semi-anechoic chamber, EUT placed on the 0.8 m height of Turn Table, rotated the table around 360 degrees to search the maximum radiation power and receiver antenna shall be rotated vertical and horizontal polarization and moved height from 1m to 4m to find the maximum polar radiated power. The "Read Value" is the spectrum reading the maximum power value.
- c. The substitution horn antenna is substituted for EUT at the same position and signals generator export the CW signal to the substitution antenna via a tx cable. Rotated the Turn Table and moved receiving antenna to find the maximum radiation power. Adjust output power level of S.G to get a Value of spectrum reading equal to "Read Value" of step b. Record the power level of S.G.
- d.  $EIRP = \text{Output power level of S.G} - \text{TX cable loss} + \text{Antenna gain of substitution horn}$ . E.R.P power can be calculated form E.I.R.P power by subtracting the gain of dipole,  $E.R.P \text{ power} = E.I.P.R \text{ power} - 2.15 \text{ dBi}$ .

##### **Conducted Power Measurement:**

The EUT was set up for the maximum power with CDMA and LTE link data modulation and link up with simulator. Set the EUT to transmit under low, middle and high channel and record the power level shown on simulator.

### 4.1.3 Test Setup

#### EIRP / ERP Measurement:

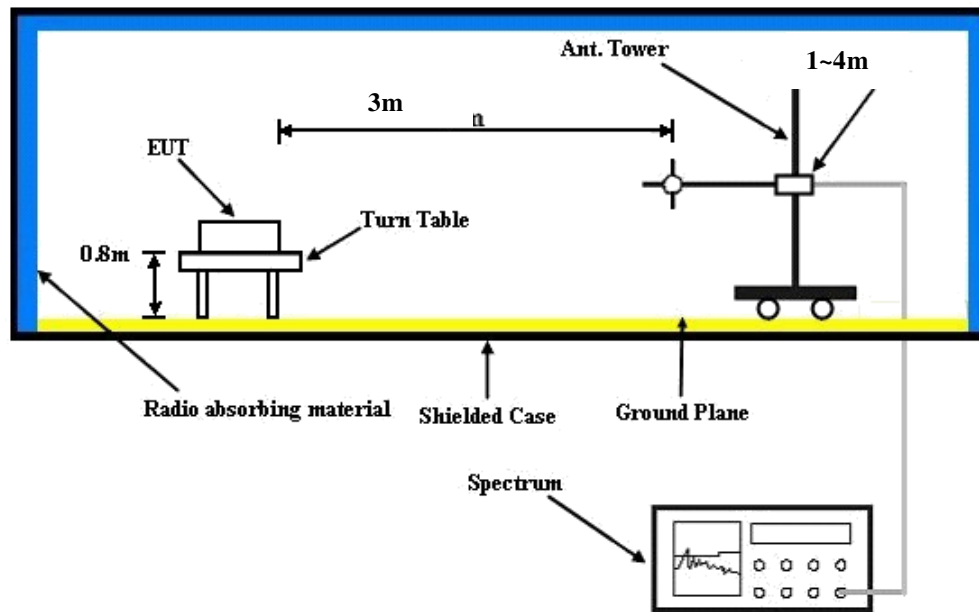

For the actual test configuration, please refer to the attached file (Test Setup Photo).

#### Conducted Power Measurement:



## 4.1.4 Test Results

**Conducted Output Power (dBm)**

Band	CDMA		
	25	600	1175
Channel	1851.25	1880	1908.75
Frequency (MHz)	1851.25	1880	1908.75
RC1+SO55	20.71	20.97	20.38
RC3+SO55	20.55	20.82	20.38
RC3+SO32 (+F-SCH)	20.58	20.83	20.35
RC3+SO32 (+SCH)	20.51	20.87	20.43
RTAP 153.6	20.75	20.83	20.61
RETAP 4096	20.74	20.99	20.65

**EIRP Power (dBm)**

CDMA							
Plane	Channel	Frequency (MHz)	LVL (dBm)	Correction Factor (dB)	EIRP (dBm)	EIRP (mW)	Polarization (H/V)
Y	25	1851.3	-29.42	36.57	7.15	5.19	H
	600	1880.0	-29.98	37.22	7.24	5.30	
	1175	1908.8	-29.95	37.18	7.23	5.29	
	25	1851.3	-20.55	37.65	17.10	51.30	V
	600	1880.0	-20.44	37.58	17.14	51.80	
	1175	1908.8	-20.39	37.48	17.09	51.17	

## 4.2 Frequency Stability Measurement

### 4.2.1 Limits of Frequency Stability Measurement

The frequency stability shall be sufficient to ensure that the fundamental emission stays within the authorized frequency block.

### 4.2.2 Test Procedure

- Device is placed at the oven room. The oven room could control the temperatures and humidity. Power warm up is at least 15 min and power applied should perform before recording frequency error.
- EUT is connected the external power supply to control the DC input power. The test voltage range is from minimum to maximum working voltage. Each step shall be record the frequency error rate.
- The temperature range step is 10 degrees in this test items. All temperature levels shall be hold the  $\pm 0.5$  °C during the measurement testing. The each temperature step shall be at least 0.5 hours, consider the EUT could be test under the stability condition.

**NOTE:** The frequency error was recorded frequency error from the communication simulator.

### 4.2.3 Test Setup

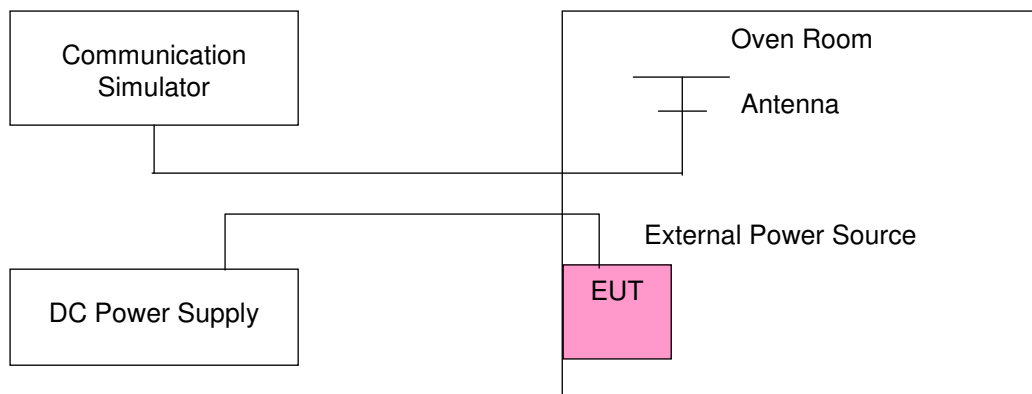

#### 4.2.4 Test Results

##### Frequency Error vs. Voltage

Voltage (Volts)	CDMA				Limit (ppm)
	Low Channel		High Channel		
	Frequency (MHz)	Frequency Error (ppm)	Frequency (MHz)	Frequency Error (ppm)	
3.8	1851.250002	0.001	1908.750002	0.001	2.5
3.5	1851.250001	0.001	1908.750001	0.001	2.5
4.35	1851.250003	0.002	1908.750002	0.001	2.5

**Note:** The applicant defined the normal working voltage of the battery is from 3.5 Vdc to 4.35 Vdc.

##### Frequency Error vs. Temperature

Temp. (°C)	CDMA				Limit (ppm)
	Low Channel		High Channel		
	Frequency (MHz)	Frequency Error (ppm)	Frequency (MHz)	Frequency Error (ppm)	
-30	1851.250002	0.001	1908.750003	0.001	2.5
-20	1851.250003	0.002	1908.750003	0.001	2.5
-10	1851.250002	0.001	1908.750002	0.001	2.5
0	1851.250001	0.001	1908.750002	0.001	2.5
10	1851.250001	0.001	1908.750002	0.001	2.5
20	1851.249997	-0.002	1908.749998	-0.001	2.5
30	1851.249999	-0.001	1908.749998	-0.001	2.5
40	1851.249998	-0.001	1908.749999	-0.001	2.5
50	1851.249999	-0.001	1908.749999	-0.001	2.5
55	1851.249998	-0.001	1908.749997	-0.001	2.5

**Note:**

1. The applicant declared that the normal operating temperature of the EUT is from -30°C to 55°C.
2. The EUT would shut down automatically as below -30°C.



### 4.3 Occupied Bandwidth Measurement

#### 4.3.1 Test Procedure

The EUT makes a call to the communication simulator. All measurements were done at low, middle and high operational frequency range. The communication simulator station system controlled a EUT to export maximum output power under transmission mode and specific channel frequency. Use OBW measurement function of Spectrum analyzer to measure 99 % occupied bandwidth.

#### 4.3.2 Test Setup

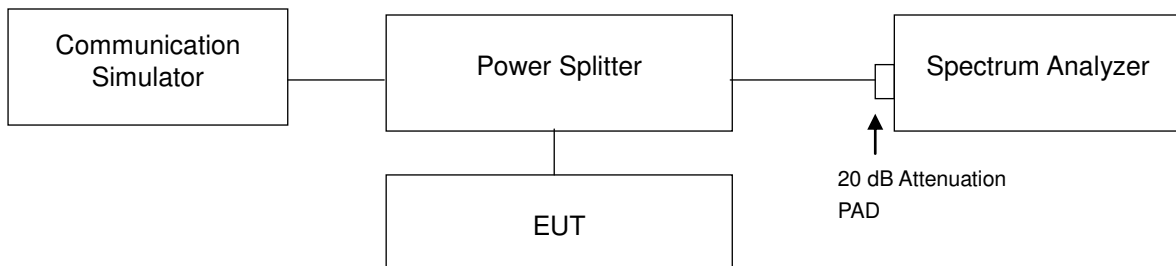

#### 4.3.3 Test Result

Channel	Frequency (MHz)	99 % Occupied Bandwidth (kHz)
		CDMA
25	1851.25	1.2724
600	1880.00	1.2736
1175	1908.75	1.2716

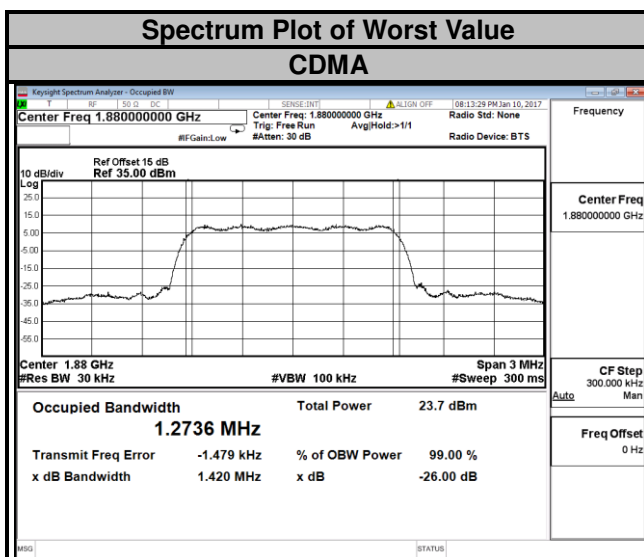

## 4.4 Band Edge Measurement

### 4.4.1 Limits of Band Edge Measurement

Power of any emission outside of the authorized operating frequency ranges must be attenuated below the transmitting power (P) by a factor of at least  $43 + 10 \log(P)$  dB. In the 1 MHz bands immediately outside and adjacent to the frequency block a resolution bandwidth of at least one percent of the emission bandwidth of the fundamental emission of the transmitter may be employed.

### 4.4.2 Test Setup

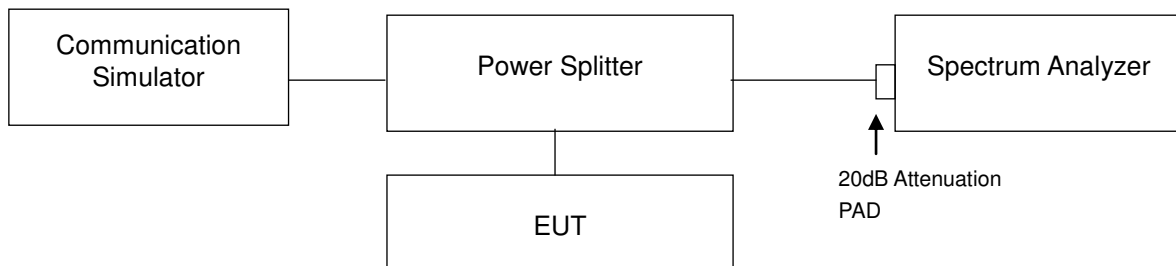

### 4.4.3 Test Procedures

- All measurements were done at low and high operational frequency range.
- The center frequency of spectrum is the band edge frequency and span is 1 MHz. RB of the spectrum is 13 kHz and VB of the spectrum is 51 kHz (CDMA).
- Record the max trace plot into the test report.

### 4.4.4 Test Results

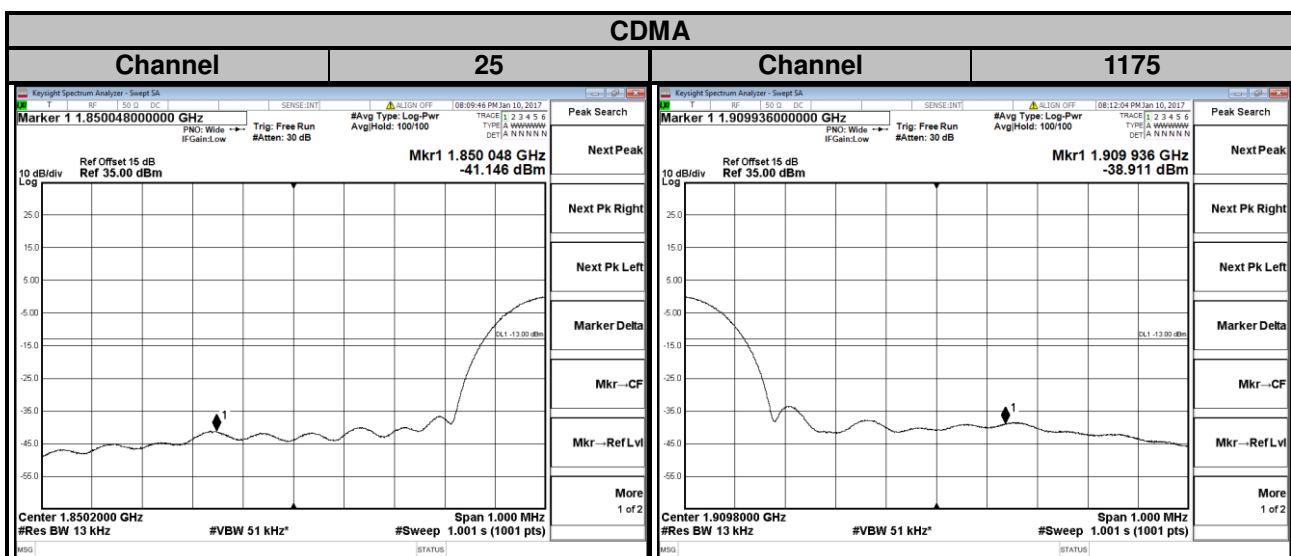

## 4.5 Peak to Average Ratio

### 4.5.1 Limits of Peak to Average Ratio Measurement

In measuring transmissions in this band using an average power technique, the peak to-average ratio (PAR) of the transmission may not exceed 13 dB.

### 4.5.2 Test Setup

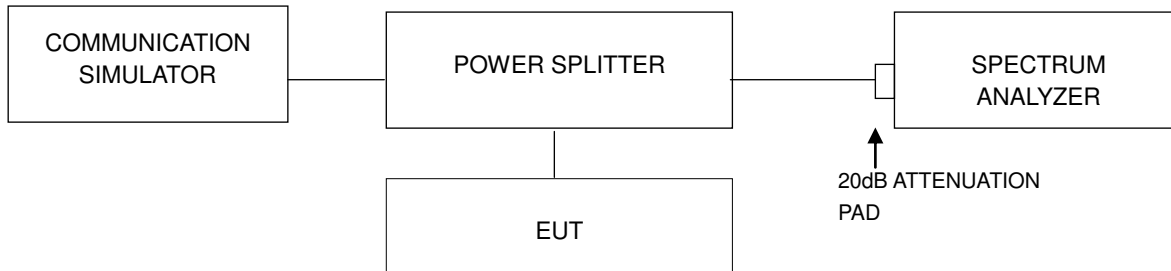

### 4.5.3 Test Procedures

1. Set resolution/measurement bandwidth  $\geq$  signal's occupied bandwidth;
2. Set the number of counts to a value that stabilizes the measured CCDF curve;
3. Record the maximum PAPR level associated with a probability of 0.1 %.

### 4.5.4 Test Results

Channel	Frequency (MHz)	Peak to Average Ratio (dB)
		CDMA
25	1851.25	3.81
600	1880.00	4.13
1175	1908.75	4.08

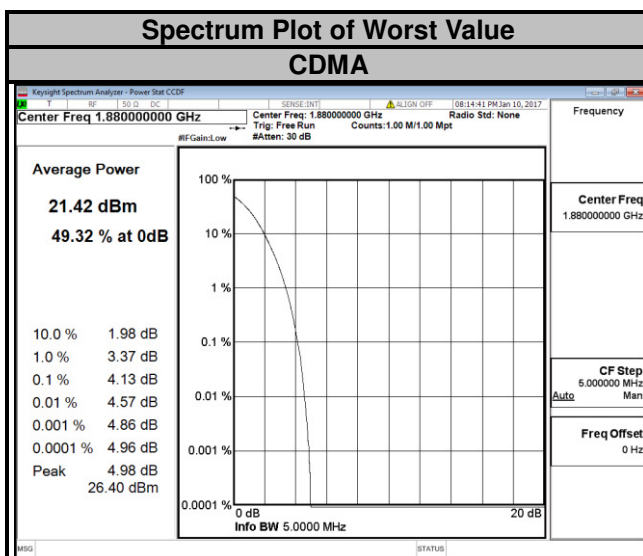

## 4.6 Conducted Spurious Emissions

### 4.6.1 Limits of Conducted Spurious Emissions Measurement

The power of any emission outside of the authorized operating frequency ranges must be attenuated below the transmitting power (P) by a factor of at least  $43 + 10 \log(P)$  dB. The emission limit equal to  $-13$  dBm.

### 4.6.2 Test Setup

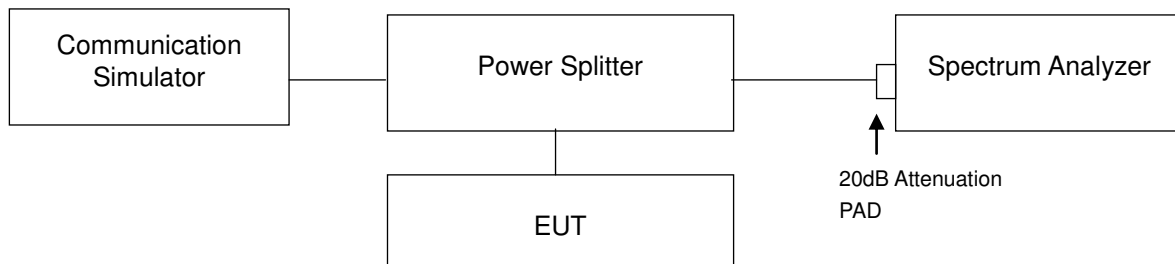

### 4.6.3 Test Procedure

- The EUT makes a phone call to the communication simulator. All measurements were done at low, middle and high operational frequency range.
- Measuring frequency range is from 9 kHz to 9 GHz. 20 dB attenuation pad is connected with spectrum. RBW=1 MHz and VBW=3 MHz is used for conducted emission measurement.

### 4.6.4 Test Results

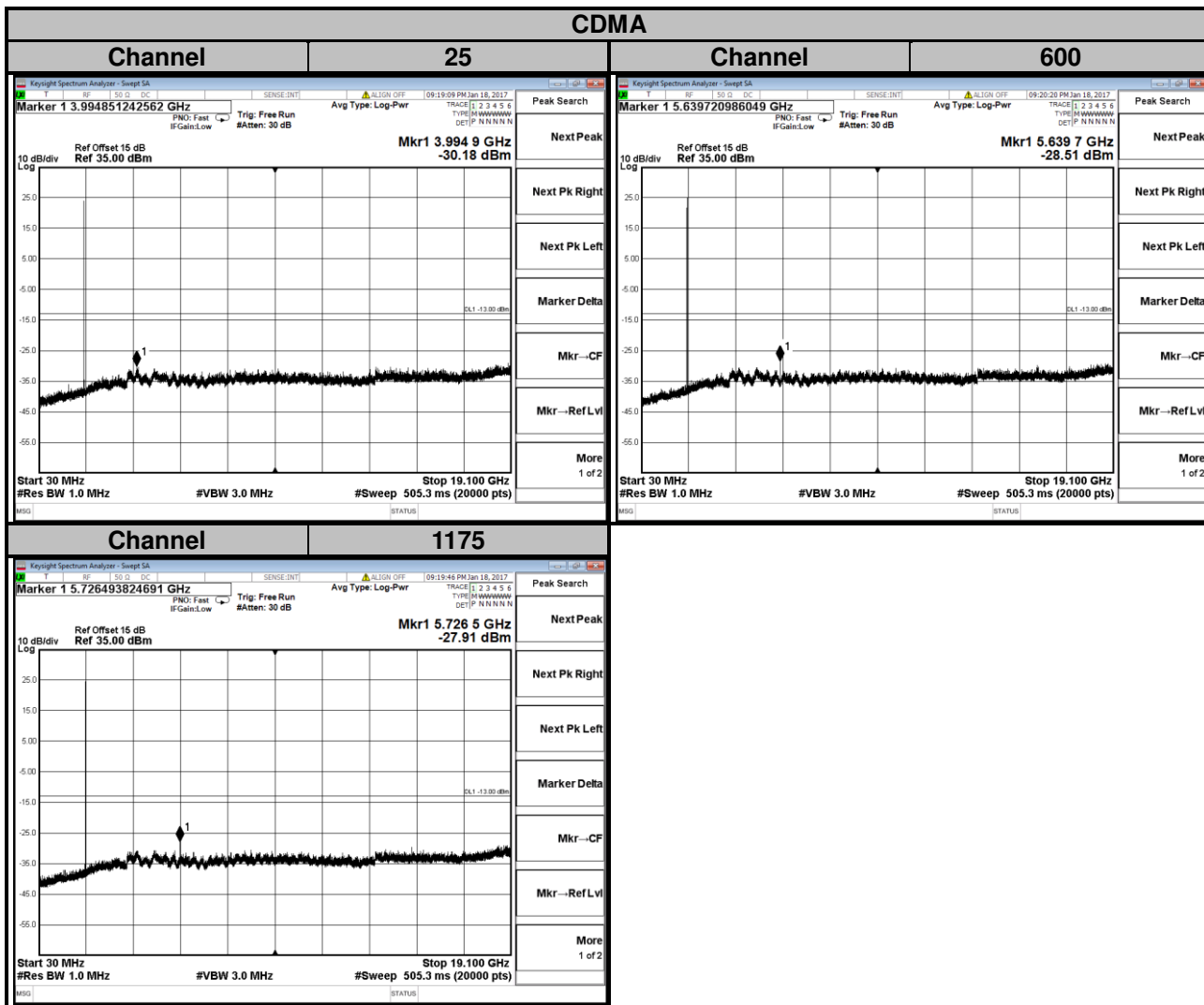

## 4.7 Radiated Emission Measurement

### 4.7.1 Limits of Radiated Emission Measurement

The power of any emission outside of the authorized operating frequency ranges must be attenuated below the transmitting power (P) by a factor of at least  $43 + 10 \log(P)$  dB. The emission limit is equal to  $-13$  dBm.

### 4.7.2 Test Procedure

- Substitution method is used for E.I.R.P measurement. In the semi-anechoic chamber, EUT placed on the 0.8 m height of Turn Table, rotated the table around 360 degrees to search the maximum radiation power and receiver antenna shall be rotated vertical and horizontal polarization and moved height from 1 m to 4 m to find the maximum polar radiated power. The "Read Value" is the spectrum reading the maximum power value.
- The substitution horn antenna is substituted for EUT at the same position and signals generator export the CW signal to the substitution antenna via a TX cable. Rotated the Turn Table and moved receiving antenna to find the maximum radiation power. Adjust output power level of S.G to get a Value of spectrum reading equal to "Read Value" of step a. Record the power level of S.G.
- $EIRP = \text{Output power level of S.G} - \text{TX cable loss} + \text{Antenna gain of substitution horn}$ .
- E.R.P power can be calculated form E.I.R.P power by subtracting the gain of dipole,  $E.R.P \text{ power} = E.I.P.R \text{ power} - 2.15 \text{ dBi}$ .

**NOTE:** The resolution bandwidth and video bandwidth of test receiver/spectrum analyzer is 1 MHz/3 MHz.

### 4.7.3 Deviation from Test Standard

No deviation.

### 4.7.4 Test Setup

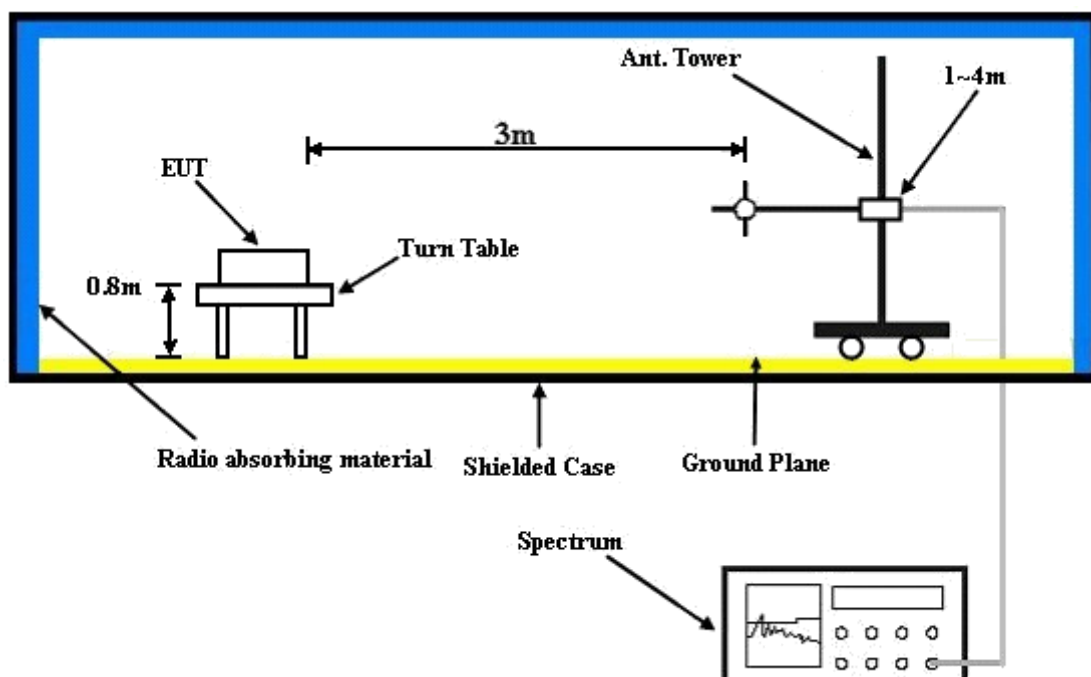

For the actual test configuration, please refer to the attached file (Test Setup Photo).

4.7.5 Test Results

CDMA:

Low Channel



Bureau Veritas Consumer Products Services Ltd., Taoyuan Branch

A D T

Data: 5

Date: 2017-01-17

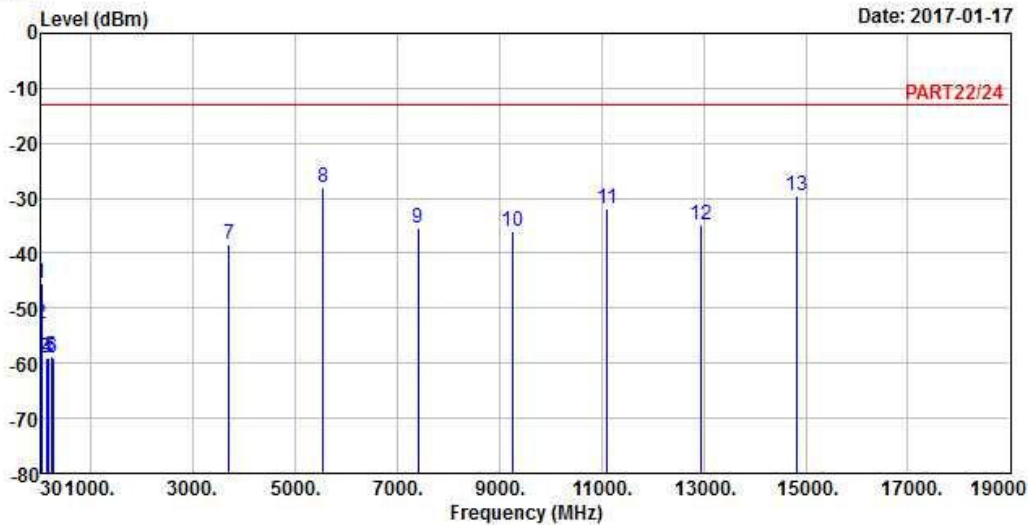

Site : 966 Chamber 5  
 Condition: PART22/24 HORIZONTAL  
 Remak : CDMA BC1\_L-CH  
 Tested by: Gavin Wu

	Freq	Level	Read Level	Limit Line	Over Limit	Factor	Remark
	MHz	dBm	dBm	dBm	dB	dB	
1	31.94	-45.51	-44.91	-13.00	-32.51	-0.60	Peak
2	39.70	-52.70	-53.34	-13.00	-39.70	0.64	Peak
3	135.73	-59.10	-50.43	-13.00	-46.10	-8.67	Peak
4	165.80	-59.05	-53.80	-13.00	-46.05	-5.25	Peak
5	223.03	-58.69	-51.61	-13.00	-45.69	-7.08	Peak
6	253.10	-59.14	-53.09	-13.00	-46.14	-6.05	Peak
7	3702.50	-38.32	-30.15	-13.00	-25.32	-8.17	Peak
8 pp	5553.75	-28.18	-26.73	-13.00	-15.18	-1.45	Peak
9	7405.00	-35.38	-40.88	-13.00	-22.38	5.50	Peak
10	9256.65	-36.09	-43.79	-13.00	-23.09	7.70	Peak
11	11107.50	-31.82	-39.87	-13.00	-18.82	8.05	Peak
12	12958.75	-34.85	-46.43	-13.00	-21.85	11.58	Peak
13	14810.00	-29.56	-41.22	-13.00	-16.56	11.66	Peak



Bureau Veritas Consumer Products Services Ltd., Taoyuan Branch

A D T

Data: 6

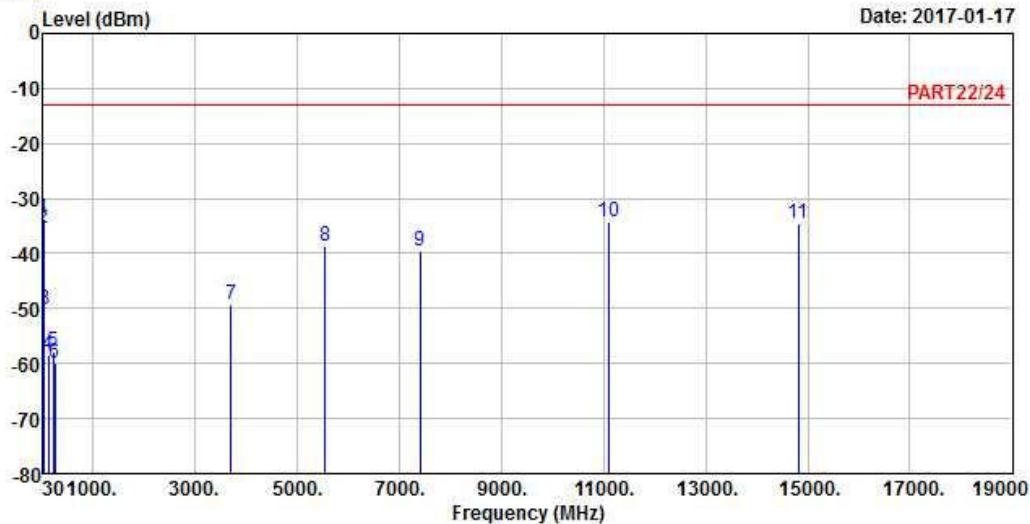

Site : 966 Chamber 5  
 Condition: PART22/24 VERTICAL  
 Remak : CDMA BC1\_L-CH  
 Tested by: Gavin Wu

	Freq	Level	Read Level	Limit Line	Over Limit	Factor	Remark
	MHz	dBm	dBm	dBm	dB	dB	
1 pp	32.91	-33.72	-32.63	-13.00	-20.72	-1.09	Peak
2	39.70	-35.55	-36.19	-13.00	-22.55	0.64	Peak
3	57.16	-50.28	-43.41	-13.00	-37.28	-6.87	Peak
4	136.70	-58.41	-49.75	-13.00	-45.41	-8.66	Peak
5	218.18	-57.85	-50.57	-13.00	-44.85	-7.28	Peak
6	256.01	-59.87	-53.76	-13.00	-46.87	-6.11	Peak
7	3702.50	-49.18	-41.01	-13.00	-36.18	-8.17	Peak
8	5553.75	-38.78	-37.33	-13.00	-25.78	-1.45	Peak
9	7405.00	-39.66	-45.16	-13.00	-26.66	5.50	Peak
10	11107.50	-34.10	-42.15	-13.00	-21.10	8.05	Peak
11	14810.00	-34.63	-46.29	-13.00	-21.63	11.66	Peak



Middle Channel



Bureau Veritas Consumer Products Services Ltd., Taoyuan Branch

A D T

Data: 5

Date: 2017-01-06

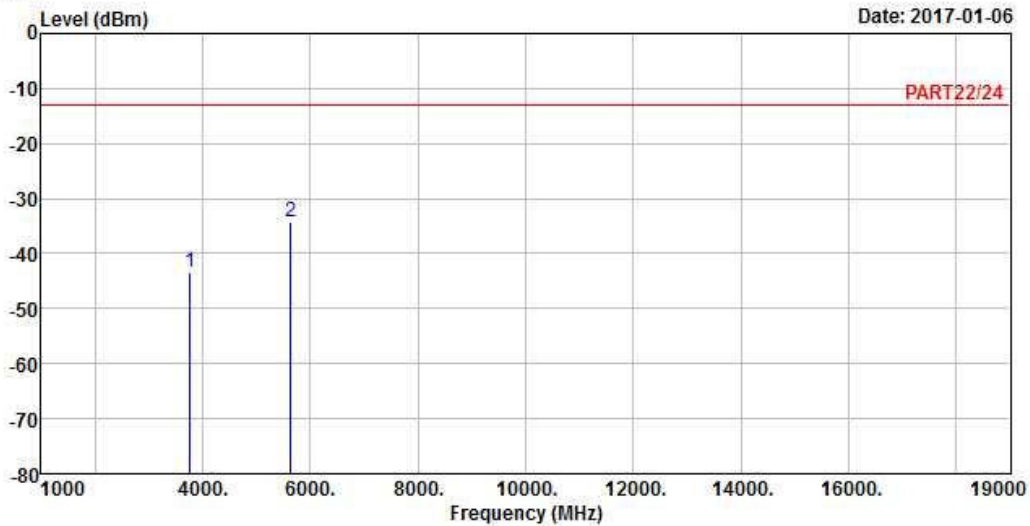

Site : 966 Chamber 5  
 Condition: PART22/24 HORIZONTAL  
 Remak : CDMA BC1 Link  
 Tested by: Gavin Wu

	Freq	Level	Read Level	Limit Line	Over Limit	Factor	Remark
	MHz	dBm	dBm	dBm	dB	dB	
1	3760.00	-43.34	-35.28	-13.00	-30.34	-8.06	Peak
2 pp	5640.00	-34.22	-32.28	-13.00	-21.22	-1.94	Peak



Bureau Veritas Consumer Products Services Ltd., Taoyuan Branch

A D T

Data: 6

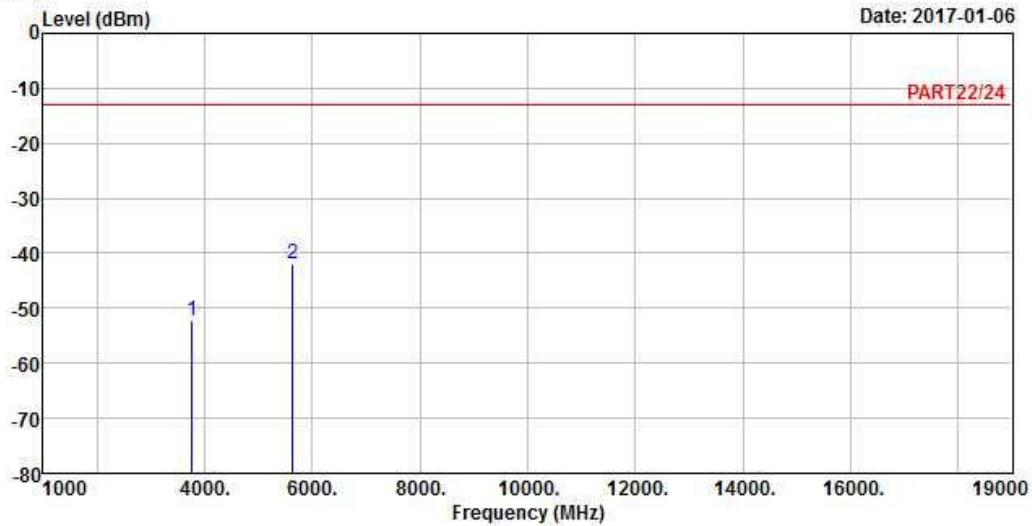

Site : 966 Chamber 5  
 Condition: PART22/24 VERTICAL  
 Remak : CDMA BC1 Link  
 Tested by: Gavin Wu

	Freq	Level	Read Level	Limit Line	Over Limit	Factor	Remark
	MHz	dBm	dBm	dBm	dB	dB	
1	3760.00	-52.16	-44.10	-13.00	-39.16	-8.06	Peak
2 pp	5640.00	-41.85	-39.91	-13.00	-28.85	-1.94	Peak

# High Channel



Bureau Veritas Consumer Products Services Ltd., Taoyuan Branch

A D T

Data: 3

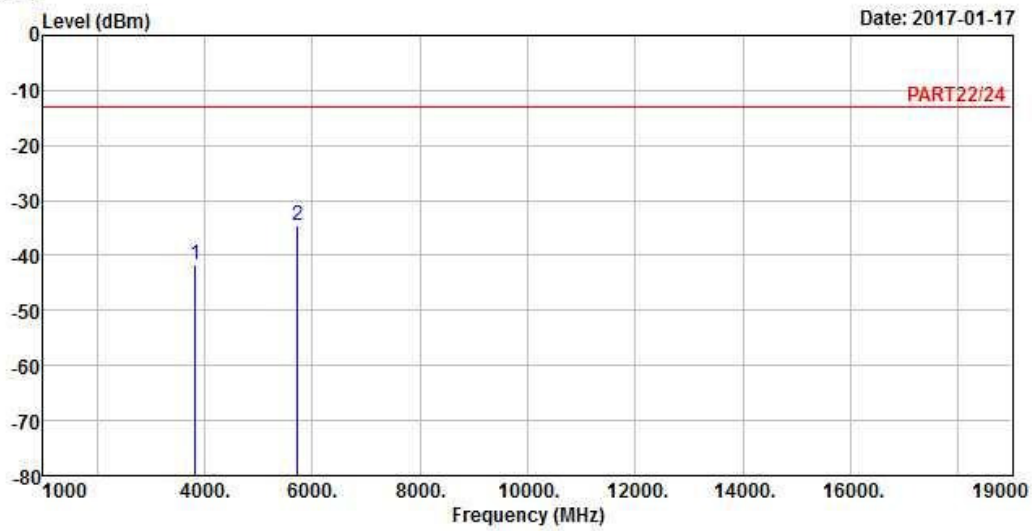

Site : 966 Chamber 5  
 Condition: PART22/24 HORIZONTAL  
 Remak : CDMA BC1\_H-CH  
 Tested by: Gavin Wu

	Freq	Level	Read Level	Limit Line	Over Limit	Factor	Remark
	MHz	dBm	dBm	dBm	dB	dB	
1	3817.50	-41.63	-33.95	-13.00	-28.63	-7.68	Peak
2 pp	5726.25	-34.63	-33.05	-13.00	-21.63	-1.58	Peak



Bureau Veritas Consumer Products Services Ltd., Taoyuan Branch

A D T

Data: 4

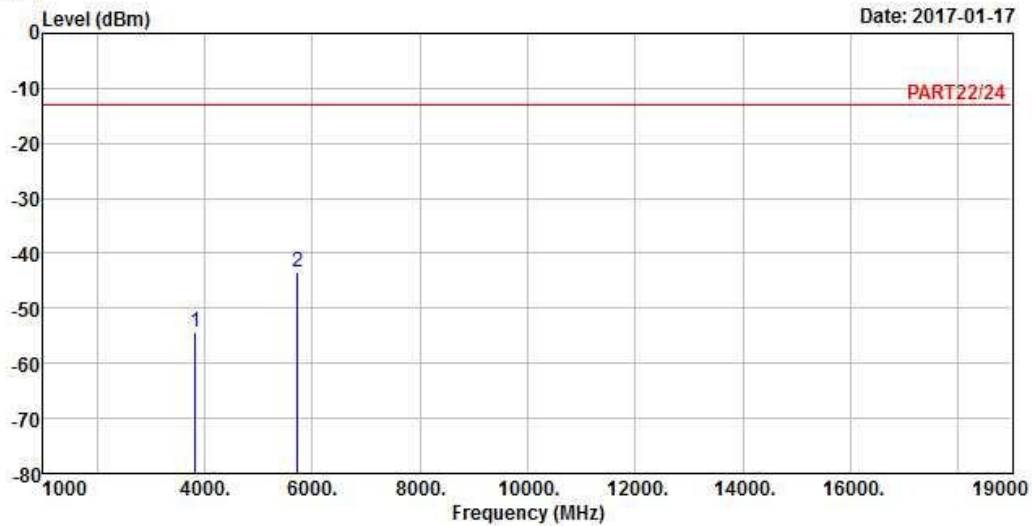

Site : 966 Chamber 5  
 Condition: PART22/24 VERTICAL  
 Remak : CDMA BC1\_H-CH  
 Tested by: Gavin Wu

	Freq	Level	Read Level	Limit Line	Over Limit	Factor	Remark
	MHz	dBm	dBm	dBm	dB	dB	
1	3817.50	-54.18	-46.50	-13.00	-41.18	-7.68	Peak
2 pp	5726.25	-43.48	-41.90	-13.00	-30.48	-1.58	Peak

## 5 Pictures of Test Arrangements

Please refer to the attached file (Test Setup Photo).

## Appendix – Information on the Testing Laboratories

We, Bureau Veritas Consumer Products Services (H.K.) Ltd., Taoyuan Branch, were founded in 1988 to provide our best service in EMC, Radio, Telecom and Safety consultation. Our laboratories are accredited and approved according to ISO/IEC 17025.

If you have any comments, please feel free to contact us at the following:

**Linko EMC/RF Lab**

Tel: 886-2-26052180

Fax: 886-2-26051924

**Hsin Chu EMC/RF/Telecom Lab**

Tel: 886-3-6668565

Fax: 886-3-6668323

**Hwa Ya EMC/RF/Safety**

Tel: 886-3-3183232

Fax: 886-3-3270892

**Email:** [service.adt@tw.bureauveritas.com](mailto:service.adt@tw.bureauveritas.com)

**Web Site:** [www.bureauveritas-adt.com](http://www.bureauveritas-adt.com)

The address and road map of all our labs can be found in our web site also.

--- END ---