

FCC SAR Test Report

Report No. : SA171023K006R1
Applicant : Franklin Technology Inc.
Address : 906 JEI Platz, 186, Gasan digital 1-ro, Geumcheon-gu, Seoul, Korea, (08502)
Product : Mobile Hotspot
FCC ID : XHG-R871A
Brand : Franklin
Model No. : R871
Standards : FCC 47 CFR Part 2 (2.1093) / IEEE C95.1:1992 / IEEE 1528:2013
 KDB 865664 D01 v01r04 / KDB 865664 D02 v01r02
 KDB 248227 D01 v02r02 / KDB 447498 D01 v06 / KDB 941225 D01 v03r01
 KDB 941225 D05 v02r05 / KDB 941225 D06 v02r01
Sample Received Date : Oct. 23, 2017
Date of Testing : Oct. 28, 2017 ~ Dec. 02, 2017

CERTIFICATION: The above equipment have been tested by **Bureau Veritas Consumer Products Services ADT Korea Ltd. Mobile Communications Laboratory**, and found compliance with the requirement of the above standards. The test record, data evaluation & Equipment Under Test (EUT) configurations represented herein are true and accurate accounts of the measurements of the sample's SAR characteristics under the conditions specified in this report. It should not be reproduced except in full, without the written approval of our laboratory. The client should not use it to claim product certification, approval, or endorsement by TAF or any government agencies.

Prepared By : 

 David Seo / Test Engineer

Approved By : 

 Andrew Choi / Technical Manager



This report is for your exclusive use. Any copying or replication of this report to or for any other person or entity, or use of our name or trademark, is permitted only with our prior written permission. This report sets forth our findings solely with respect to the test samples identified herein. The results set forth in this report are not indicative or representative of the quality or characteristics of the lot from which a test sample was taken or any similar or identical product unless specifically and expressly noted. Our report includes all of the tests requested by you and the results thereof based upon the information that you provided to us. You have 60 days from date of issuance of this report to notify us of any material error or omission caused by our negligence, provided, however, that such notice shall be in writing and shall specifically address the issue you wish to raise. A failure to raise such issue within the prescribed time shall constitute your unqualified acceptance of the completeness of this report, the tests conducted and the correctness of the report contents. Unless specific mention, the uncertainty of measurement has been explicitly taken into account to declare the compliance or non-compliance to the specification.

Table of Contents

Release Control Record	3
1. Summary of Maximum SAR Value	4
2. Description of Equipment Under Test	5
3. SAR Measurement System	6
3.1 Definition of Specific Absorption Rate (SAR)	6
3.2 SPEAG DASY System	6
3.2.1 Robot	7
3.2.2 Probes	8
3.2.3 Data Acquisition Electronics (DAE)	8
3.2.4 Phantoms	8
3.2.5 Device Holder	9
3.2.6 System Validation Dipoles	9
3.2.7 Tissue Simulating Liquids	10
3.3 SAR System Verification	13
3.4 SAR Measurement Procedure	14
3.4.1 Area & Zoom Scan Procedure	14
3.4.2 Volume Scan Procedure	14
3.4.3 Power Drift Monitoring	15
3.4.4 Spatial Peak SAR Evaluation	15
3.4.5 SAR Averaged Methods	15
4. SAR Measurement Evaluation	16
4.1 EUT Configuration and Setting	16
4.2 EUT Testing Position	19
4.2.1 Hotspot Mode Exposure conditions	19
4.2.2 Simultaneous Transmission Possibilities	20
4.3 Tissue Verification	21
4.4 System Verification	21
4.5 Maximum Output Power	22
4.5.1 Maximum Conducted Power	22
4.5.2 Measured Conducted Power Result	23
4.6 SAR Testing Results	30
4.6.1 SAR Test Reduction Considerations	30
4.6.2 SAR Results for Hotspot (Separation Distance is 1.0 cm Gap)	32
4.6.3 SAR Measurement Variability	35
4.6.4 Simultaneous Multi-band Transmission Evaluation	36
5. Calibration of Test Equipment	38
6. Measurement Uncertainty	39
7. Information on the Testing Laboratories	40
Appendix A. SAR Plots of System Verification	
Appendix B. SAR Plots of SAR Measurement	
Appendix C. Calibration Certificate for Probe and Dipole	
Appendix D. Photographs of EUT and Setup	

Release Control Record

Report No.	Reason for Change	Date Issued
SA171023K006	Initial release	Nov. 21, 2017
SA171023K006R1	To revise mismatched information	Nov. 28, 2017
SA171023K006R2	Retest CDMA BC0, LTE band 2, 4, 5, 12, 25	Dec. 04, 2017
SA171023K006R3	To revise indicate WLAN antenna	Dec. 11, 2017

1. Summary of Maximum SAR Value

Equipment Class	Mode	Highest Reported Hotspot SAR _{1g} (1.0 cm Gap) (W/kg)
PCB	CDMA BC0	0.84
	CDMA BC1	1.49
	LTE 2	1.38
	LTE 4	0.70
	LTE 5	0.78
	LTE 12	0.96
	LTE 25	1.31
DTS	2.4G WLAN	0.06
Highest Simultaneous Transmission SAR		Hotspot (W/kg)
PCB+DTS		1.50

Note:

- The SAR limit (**Head & Body: SAR_{1g} 1.6 W/kg, Extremity: SAR_{10g} 4.0 W/kg**) for general population / uncontrolled exposure is specified in FCC 47 CFR part 2 (2.1093) and ANSI/IEEE C95.1-1992.

2. Description of Equipment Under Test

EUT Type	Mobile Hotspot
FCC ID	XHG-R871A
Brand Name	Franklin
Model Name	R871
HW Version	MP
SW Version	R871AF10.FR.810
Tx Frequency Bands (Unit: MHz)	CDMA BC0 : 824.7 ~ 848.31 CDMA BC1 : 1851.25 ~ 1908.75 LTE Band 2 : 1850.7 ~ 1909.3 (1.4M), 1851.5 ~ 1908.5 (3M), 1852.5 ~ 1907.5 (5M), 1855 ~ 1905 (10M), 1857.5 ~ 1902.5 (15M), 1860 ~ 1900 (20M) LTE Band 4 : 1710.7 ~ 1754.3 (1.4M), 1711.5 ~ 1753.5 (3M), 1712.5 ~ 1752.5 (5M), 1715 ~ 1750 (10M), 1717.5 ~ 1747.5 (15M), 1720 ~ 1745 (20M) LTE Band 5 : 824.7 ~ 848.3 (1.4M), 825.5 ~ 847.5 (3M), 826.5 ~ 846.5 (5M), 829 ~ 844 (10M) LTE Band 12 : 699.7 ~ 715.3 (1.4M), 700.5 ~ 714.5 (3M), 701.5 ~ 713.5 (5M), 704 ~ 711 (10M) LTE Band 25 : 1850.7 ~ 1914.3 (1.4M), 1851.5 ~ 1913.5 (3M), 1852.5 ~ 1912.5 (5M), 1855 ~ 1910 (10M), 1857.5 ~ 1907.5 (15M), 1860 ~ 1905 (20M) WLAN : 2412 ~ 2462
Uplink Modulations	CDMA : QPSK LTE : QPSK, 16QAM 802.11b : DSSS
Maximum Tune-up Conducted Power (Unit: dBm)	CDMA BC0 : 24.0 CDMA BC1 : 21.0 LTE Band 2 : 21.0 LTE Band 4 : 23.0 LTE Band 5 : 24.0 LTE Band 12 : 25.0 LTE Band 25 : 21.0 WLAN 2.4G : 11.0
Antenna Type	Fixed Internal Antenna
EUT Stage	Identical Prototype

Note:

1. The above EUT information is declared by manufacturer and for more detailed features description please refers to the manufacturer's specifications or User's Manual.

3. SAR Measurement System

3.1 Definition of Specific Absorption Rate (SAR)

SAR is related to the rate at which energy is absorbed per unit mass in an object exposed to a radio field. The SAR distribution in a biological body is complicated and is usually carried out by experimental techniques or numerical modeling. The standard recommends limits for two tiers of groups, occupational/controlled and general population/uncontrolled, based on a person's awareness and ability to exercise control over his or her exposure. In general, occupational/controlled exposure limits are higher than the limits for general population/uncontrolled.

The SAR definition is the time derivative (rate) of the incremental energy (dW) absorbed by (dissipated in) an incremental mass (dm) contained in a volume element (dv) of a given density (ρ). The equation description is as below:

$$SAR = \frac{d}{dt} \left(\frac{dW}{dm} \right) = \frac{d}{dt} \left(\frac{dW}{\rho dv} \right)$$

SAR is expressed in units of Watts per kilogram (W/kg)

SAR measurement can be related to the electrical field in the tissue by

$$SAR = \frac{\sigma |E|^2}{\rho}$$

Where: σ is the conductivity of the tissue, ρ is the mass density of the tissue and E is the RMS electrical field strength.

3.2 SPEAG DASY System

DASY system consists of high precision robot, probe alignment sensor, phantom, robot controller, controlled measurement server and near-field probe. The robot includes six axes that can move to the precision position of the DASY5 software defined. The DASY software can define the area that is detected by the probe. The robot is connected to controlled box. Controlled measurement server is connected to the controlled robot box. The DAE includes amplifier, signal multiplexing, AD converter, offset measurement and surface detection. It is connected to the Electro-optical coupler (ECO). The ECO performs the conversion from the optical into digital electric signal of the DAE and transfers data to the PC.

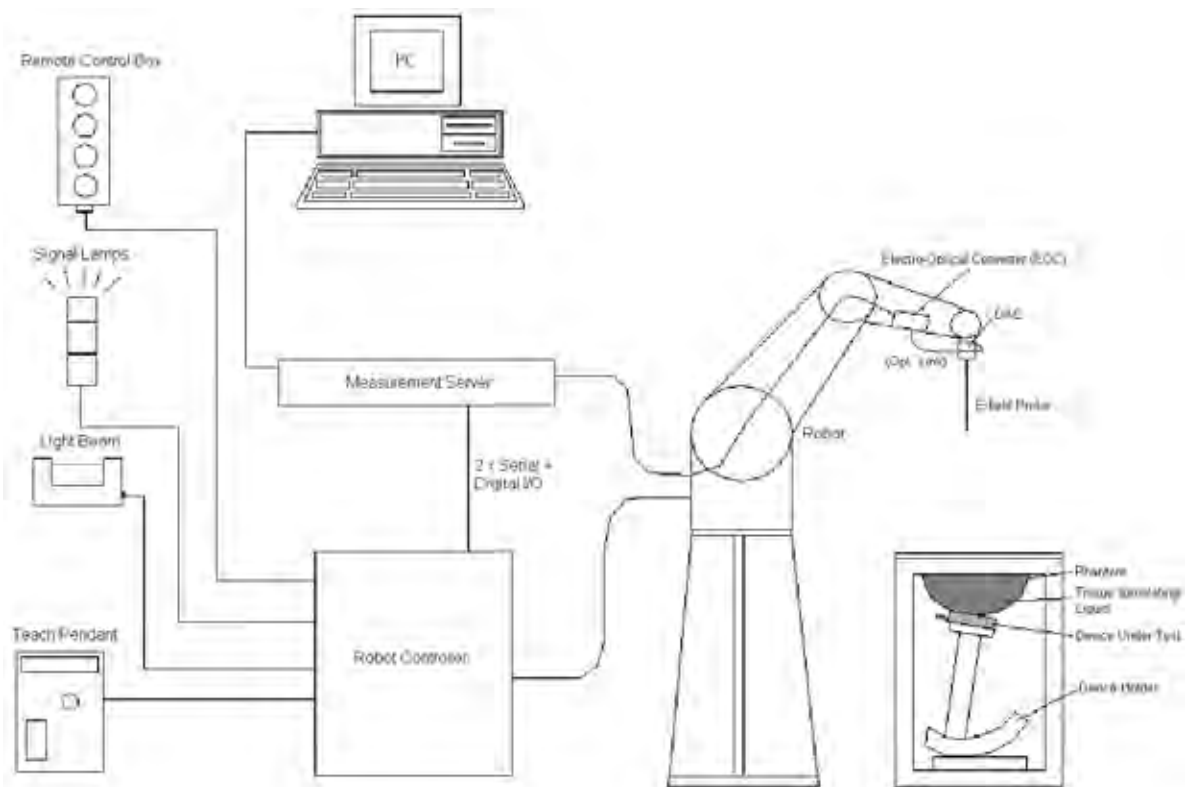

Fig-3.1 DASY System Setup

3.2.1 Robot

The DASY system uses the high precision robots from Stäubli SA (France). For the 6-axis controller system, the robot controller version (DASY5: CS8c) from Stäubli is used. The Stäubli robot series have many features that are important for our application:

- High precision (repeatability ± 0.035 mm)
- High reliability (industrial design)
- Jerk-free straight movements
- Low ELF interference (the closed metallic construction shields against motor control fields)



Fig-3.2 DASY5

FCC SAR Test Report

3.2.2 Probes

The SAR measurement is conducted with the dosimetric probe. The probe is specially designed and calibrated for use in liquid with high permittivity. The dosimetric probe has special calibration in liquid at different frequency.

Model	EX3DV4	
Construction	Symmetrical design with triangular core. Built-in shielding against static charges. PEEK enclosure material (resistant to organic solvents, e.g., DGBE).	
Frequency	10 MHz to 6 GHz Linearity: ± 0.2 dB	
Directivity	± 0.3 dB in HSL (rotation around probe axis) ± 0.5 dB in tissue material (rotation normal to probe axis)	
Dynamic Range	10 μ W/g to 100 mW/g Linearity: ± 0.2 dB (noise: typically < 1 μ W/g)	
Dimensions	Overall length: 337 mm (Tip: 20 mm) Tip diameter: 2.5 mm (Body: 12 mm) Typical distance from probe tip to dipole centers: 1 mm	

3.2.3 Data Acquisition Electronics (DAE)

Model	DAE3, DAE4	
Construction	Signal amplifier, multiplexer, A/D converter and control logic. Serial optical link for communication with DASY embedded system (fully remote controlled). Two step probe touch detector for mechanical surface detection and emergency robot stop.	
Measurement Range	-100 to +300 mV (16 bit resolution and two range settings: 4mV, 400mV)	
Input Offset Voltage	< 5 μ V (with auto zero)	
Input Bias Current	< 50 fA	
Dimensions	60 x 60 x 68 mm	

3.2.4 Phantoms

Model	Twin SAM	
Construction	The shell corresponds to the specifications of the Specific Anthropomorphic Mannequin (SAM) phantom defined in IEEE 1528 and IEC 62209-1. It enables the dosimetric evaluation of left and right hand phone usage as well as body mounted usage at the flat phantom region. A cover prevents evaporation of the liquid. Reference markings on the phantom allow the complete setup of all predefined phantom positions and measurement grids by teaching three points with the robot.	
Material	Vinylester, glass fiber reinforced (VE-GF)	
Shell Thickness	2 \pm 0.2 mm (6 \pm 0.2 mm at ear point)	
Dimensions	Length: 1000 mm Width: 500 mm Height: adjustable feet	
Filling Volume	approx. 25 liters	

FCC SAR Test Report

Model	ELI	
Construction	Phantom for compliance testing of handheld and body-mounted wireless devices in the frequency range of 30 MHz to 6 GHz. ELI is fully compatible with the IEC 62209-2 standard and all known tissue simulating liquids. ELI has been optimized regarding its performance and can be integrated into our standard phantom tables. A cover prevents evaporation of the liquid. Reference markings on the phantom allow installation of the complete setup, including all predefined phantom positions and measurement grids, by teaching three points. The phantom is compatible with all SPEAG dosimetric probes and dipoles.	
Material	Vinylester, glass fiber reinforced (VE-GF)	
Shell Thickness	2.0 ± 0.2 mm (bottom plate)	
Dimensions	Major axis: 600 mm Minor axis: 400 mm	
Filling Volume	approx. 30 liters	

3.2.5 Device Holder

Model	Mounting Device	
Construction	In combination with the Twin SAM Phantom or ELI4, the Mounting Device enables the rotation of the mounted transmitter device in spherical coordinates. Rotation point is the ear opening point. Transmitter devices can be easily and accurately positioned according to IEC, IEEE, FCC or other specifications. The device holder can be locked for positioning at different phantom sections (left head, right head, flat).	
Material	POM	

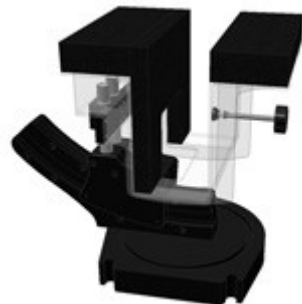
Model	Laptop Extensions Kit	
Construction	Simple but effective and easy-to-use extension for Mounting Device that facilitates the testing of larger devices according to IEC 62209-2 (e.g., laptops, cameras, etc.). It is lightweight and fits easily on the upper part of the Mounting Device in place of the phone positioner.	
Material	POM, Acrylic glass, Foam	

3.2.6 System Validation Dipoles

Model	D-Serial	
Construction	Symmetrical dipole with 1/4 balun. Enables measurement of feed point impedance with NWA. Matched for use near flat phantoms filled with tissue simulating solutions.	
Frequency	750 MHz to 5800 MHz	
Return Loss	> 20 dB	
Power Capability	> 100 W (f < 1GHz), > 40 W (f > 1GHz)	

3.2.7 Tissue Simulating Liquids

For SAR measurement of the field distribution inside the phantom, the phantom must be filled with homogeneous tissue simulating liquid to a depth of at least 15 cm. For head SAR testing, the liquid height from the ear reference point (ERP) of the phantom to the liquid top surface is larger than 15 cm. For body SAR testing, the liquid height from the center of the flat phantom to the liquid top surface is larger than 15 cm. The nominal dielectric values of the tissue simulating liquids in the phantom and the tolerance of 5 % are listed in Table-3.1.

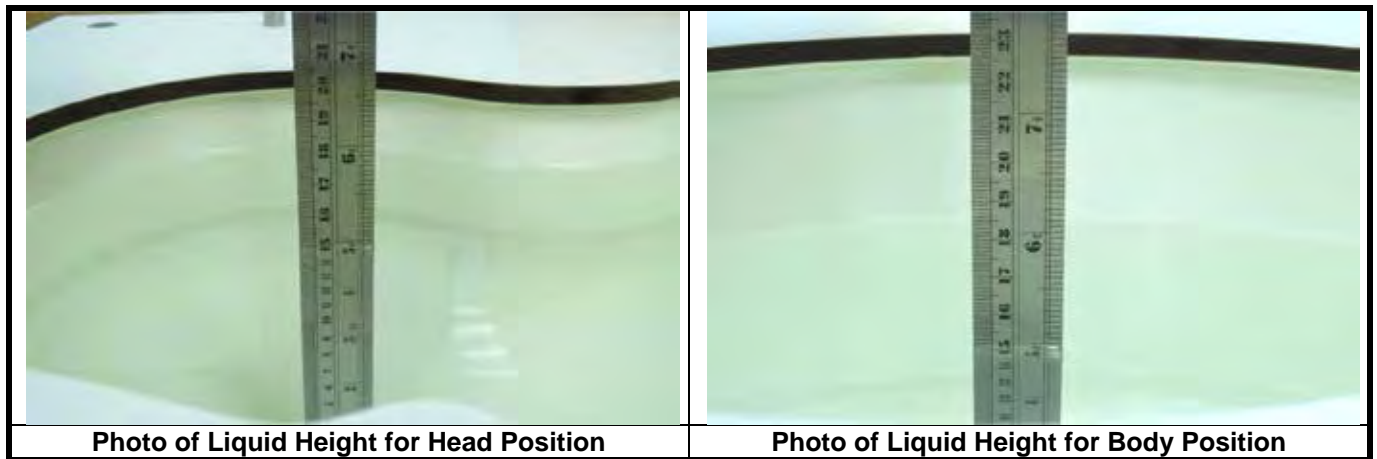

The dielectric properties of the head tissue simulating liquids are defined in IEEE 1528, and KDB 865664 D01 Appendix A. For the body tissue simulating liquids, the dielectric properties are defined in KDB 865664 D01 Appendix A. The dielectric properties of the tissue simulating liquids were verified prior to the SAR evaluation using a dielectric assessment kit and a network analyzer.

Table-3.1 Targets of Tissue Simulating Liquid

Frequency (MHz)	Target Permittivity	Range of $\pm 5\%$	Target Conductivity	Range of $\pm 5\%$
For Head				
750	41.9	39.8 ~ 44.0	0.89	0.85 ~ 0.93
835	41.5	39.4 ~ 43.6	0.90	0.86 ~ 0.95
900	41.5	39.4 ~ 43.6	0.97	0.92 ~ 1.02
1450	40.5	38.5 ~ 42.5	1.20	1.14 ~ 1.26
1640	40.3	38.3 ~ 42.3	1.29	1.23 ~ 1.35
1750	40.1	38.1 ~ 42.1	1.37	1.30 ~ 1.44
1800	40.0	38.0 ~ 42.0	1.40	1.33 ~ 1.47
1900	40.0	38.0 ~ 42.0	1.40	1.33 ~ 1.47
2000	40.0	38.0 ~ 42.0	1.40	1.33 ~ 1.47
2300	39.5	37.5 ~ 41.5	1.67	1.59 ~ 1.75
2450	39.2	37.2 ~ 41.2	1.80	1.71 ~ 1.89
2600	39.0	37.1 ~ 41.0	1.96	1.86 ~ 2.06
3500	37.9	36.0 ~ 39.8	2.91	2.76 ~ 3.06
5200	36.0	34.2 ~ 37.8	4.66	4.43 ~ 4.89
5300	35.9	34.1 ~ 37.7	4.76	4.52 ~ 5.00
5500	35.6	33.8 ~ 37.4	4.96	4.71 ~ 5.21
5600	35.5	33.7 ~ 37.3	5.07	4.82 ~ 5.32
5800	35.3	33.5 ~ 37.1	5.27	5.01 ~ 5.53
For Body				
750	55.5	52.7 ~ 58.3	0.96	0.91 ~ 1.01
835	55.2	52.4 ~ 58.0	0.97	0.92 ~ 1.02
900	55.0	52.3 ~ 57.8	1.05	1.00 ~ 1.10
1450	54.0	51.3 ~ 56.7	1.30	1.24 ~ 1.37
1640	53.8	51.1 ~ 56.5	1.40	1.33 ~ 1.47
1750	53.4	50.7 ~ 56.1	1.49	1.42 ~ 1.56
1800	53.3	50.6 ~ 56.0	1.52	1.44 ~ 1.60
1900	53.3	50.6 ~ 56.0	1.52	1.44 ~ 1.60
2000	53.3	50.6 ~ 56.0	1.52	1.44 ~ 1.60
2300	52.9	50.3 ~ 55.5	1.81	1.72 ~ 1.90
2450	52.7	50.1 ~ 55.3	1.95	1.85 ~ 2.05
2600	52.5	49.9 ~ 55.1	2.16	2.05 ~ 2.27
3500	51.3	48.7 ~ 53.9	3.31	3.14 ~ 3.48
5200	49.0	46.6 ~ 51.5	5.30	5.04 ~ 5.57
5300	48.9	46.5 ~ 51.3	5.42	5.15 ~ 5.69
5500	48.6	46.2 ~ 51.0	5.65	5.37 ~ 5.93
5600	48.5	46.1 ~ 50.9	5.77	5.48 ~ 6.06
5800	48.2	45.8 ~ 50.6	6.00	5.70 ~ 6.30

The following table gives the recipes for tissue simulating liquids.

Table-3.2 Recipes of Tissue Simulating Liquid

Tissue Type	Bactericide	DGBE	HEC	NaCl	Sucrose	Triton X-100	Water	Diethylene Glycol Mono-hexylether
H750	0.2	-	0.2	1.5	56.0	-	42.1	-
H835	0.2	-	0.2	1.5	57.0	-	41.1	-
H900	0.2	-	0.2	1.4	58.0	-	40.2	-
H1450	-	43.3	-	0.6	-	-	56.1	-
H1640	-	45.8	-	0.5	-	-	53.7	-
H1750	-	47.0	-	0.4	-	-	52.6	-
H1800	-	44.5	-	0.3	-	-	55.2	-
H1900	-	44.5	-	0.2	-	-	55.3	-
H2000	-	44.5	-	0.1	-	-	55.4	-
H2300	-	44.9	-	0.1	-	-	55.0	-
H2450	-	45.0	-	0.1	-	-	54.9	-
H2600	-	45.1	-	0.1	-	-	54.8	-
H3500	-	8.0	-	0.2	-	20.0	71.8	-
H5G	-	-	-	-	-	17.2	65.5	17.3
B750	0.2	-	0.2	0.8	48.8	-	50.0	-
B835	0.2	-	0.2	0.9	48.5	-	50.2	-
B900	0.2	-	0.2	0.9	48.2	-	50.5	-
B1450	-	34.0	-	0.3	-	-	65.7	-
B1640	-	32.5	-	0.3	-	-	67.2	-
B1750	-	31.0	-	0.2	-	-	68.8	-
B1800	-	29.5	-	0.4	-	-	70.1	-
B1900	-	29.5	-	0.3	-	-	70.2	-
B2000	-	30.0	-	0.2	-	-	69.8	-
B2300	-	31.0	-	0.1	-	-	68.9	-
B2450	-	31.4	-	0.1	-	-	68.5	-
B2600	-	31.8	-	0.1	-	-	68.1	-
B3500	-	28.8	-	0.1	-	-	71.1	-
B5G	-	-	-	-	-	10.7	78.6	10.7

3.3 SAR System Verification

The system check verifies that the system operates within its specifications. It is performed daily or before every SAR measurement. The system check uses normal SAR measurements in the flat section of the phantom with a matched dipole at a specified distance. The system verification setup is shown as below.

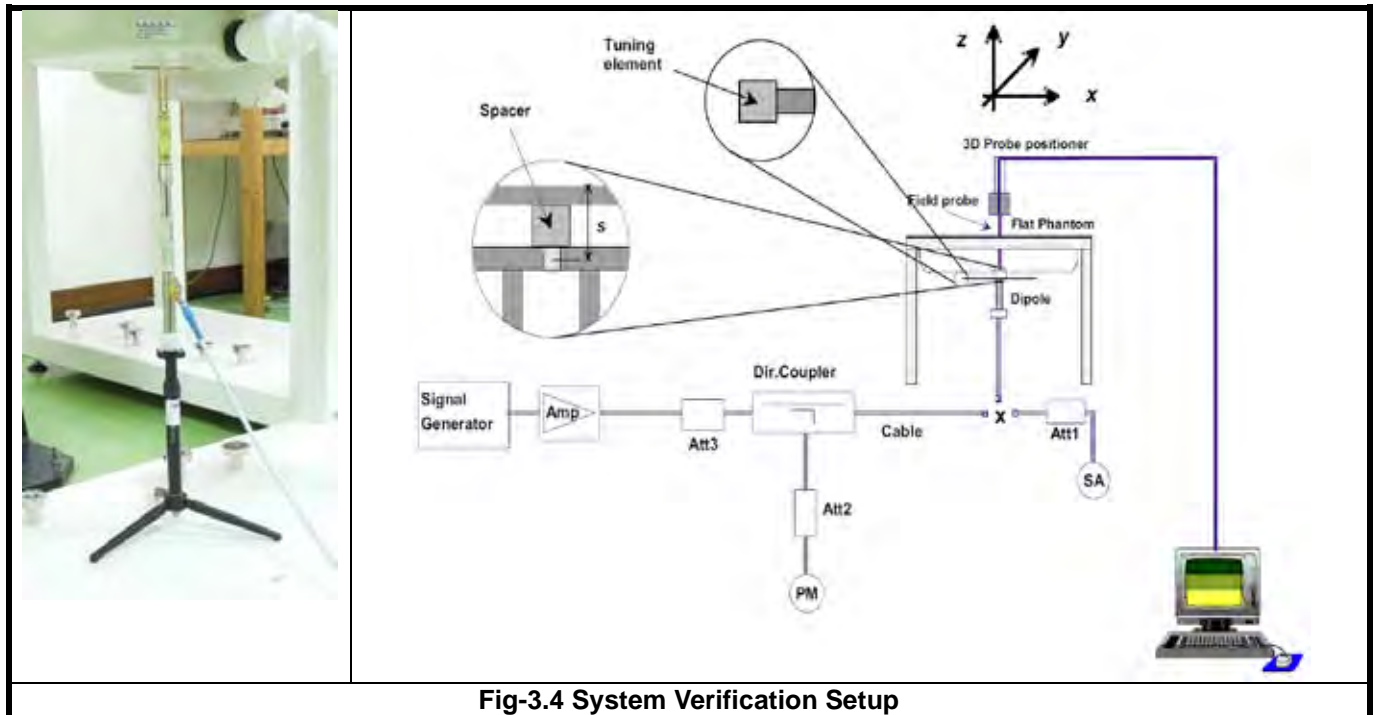

Fig-3.4 System Verification Setup

The validation dipole is placed beneath the flat phantom with the specific spacer in place. The distance spacer is touch the phantom surface with a light pressure at the reference marking and be oriented parallel to the long side of the phantom. The spectrum analyzer measures the forward power at the location of the system check dipole connector. The signal generator is adjusted for the desired forward power (250 mW is used for 700 MHz to 3 GHz, 100 mW is used for 3.5 GHz to 6 GHz) at the dipole connector and the power meter is read at that level. After connecting the cable to the dipole, the signal generator is readjusted for the same reading at power meter.

After system check testing, the SAR result will be normalized to 1W forward input power and compared with the reference SAR value derived from validation dipole certificate report. The deviation of system check should be within 10 %.

3.4 SAR Measurement Procedure

According to the SAR test standard, the recommended procedure for assessing the peak spatial-average SAR value consists of the following steps:

- (a) Power reference measurement
- (b) Area scan
- (c) Zoom scan
- (d) Power drift measurement

The SAR measurement procedures for each of test conditions are as follows:

- (a) Make EUT to transmit maximum output power
- (b) Measure conducted output power through RF cable
- (c) Place the EUT in the specific position of phantom
- (d) Perform SAR testing steps on the DASY system
- (e) Record the SAR value

3.4.1 Area & Zoom Scan Procedure

First Area Scan is used to locate the approximate location(s) of the local peak SAR value(s). The measurement grid within an Area Scan is defined by the grid extent, grid step size and grid offset. Next, in order to determine the EM field distribution in a three-dimensional spatial extension, Zoom Scan is required. The Zoom Scan is performed around the highest E-field value to determine the averaged SAR-distribution over 10 g. According to KDB 865664 D01, the resolution for Area and Zoom scan is specified in the table below.

Items	<= 2 GHz	2-3 GHz	3-4 GHz	4-5 GHz	5-6 GHz
Area Scan ($\Delta x, \Delta y$)	<= 15 mm	<= 12 mm	<= 12 mm	<= 10 mm	<= 10 mm
Zoom Scan ($\Delta x, \Delta y$)	<= 8 mm	<= 5 mm	<= 5 mm	<= 4 mm	<= 4 mm
Zoom Scan (Δz)	<= 5 mm	<= 5 mm	<= 4 mm	<= 3 mm	<= 2 mm
Zoom Scan Volume	>= 30 mm	>= 30 mm	>= 28 mm	>= 25 mm	>= 22 mm

Note:

When zoom scan is required and report SAR is <= 1.4 W/kg, the zoom scan resolution of $\Delta x / \Delta y$ (2-3GHz: <= 8 mm, 3-4GHz: <= 7 mm, 4-6GHz: <= 5 mm) may be applied.

3.4.2 Volume Scan Procedure

The volume scan is used for assess overlapping SAR distributions for antennas transmitting in different frequency bands. It is equivalent to an oversized zoom scan used in standalone measurements. The measurement volume will be used to enclose all the simultaneous transmitting antennas. For antennas transmitting simultaneously in different frequency bands, the volume scan is measured separately in each frequency band. In order to sum correctly to compute the 1g aggregate SAR, the EUT remain in the same test position for all measurements and all volume scan use the same spatial resolution and grid spacing. When all volume scan were completed, the software, SEMCAD postprocessor can combine and subsequently superpose these measurement data to calculating the multiband SAR.

3.4.3 Power Drift Monitoring

All SAR testing is under the EUT install full charged battery and transmit maximum output power. In DASY measurement software, the power reference measurement and power drift measurement procedures are used for monitoring the power drift of EUT during SAR test. Both these procedures measure the field at a specified reference position before and after the SAR testing. The software will calculate the field difference in dB. If the power drift more than 5%, the SAR will be retested.

3.4.4 Spatial Peak SAR Evaluation

The procedure for spatial peak SAR evaluation has been implemented according to the test standard. It can be conducted for 1g and 10g, as well as for user-specific masses. The DASY software includes all numerical procedures necessary to evaluate the spatial peak SAR value.

The base for the evaluation is a "cube" measurement. The measured volume must include the 1g and 10g cubes with the highest averaged SAR values. For that purpose, the center of the measured volume is aligned to the interpolated peak SAR value of a previously performed area scan.

The entire evaluation of the spatial peak values is performed within the post-processing engine (SEMCAD). The system always gives the maximum values for the 1g and 10g cubes. The algorithm to find the cube with highest averaged SAR is divided into the following stages:

- (a) Extraction of the measured data (grid and values) from the Zoom Scan
- (b) Calculation of the SAR value at every measurement point based on all stored data (A/D values and measurement parameters)
- (c) Generation of a high-resolution mesh within the measured volume
- (d) Interpolation of all measured values from the measurement grid to the high-resolution grid
- (e) Extrapolation of the entire 3-D field distribution to the phantom surface over the distance from sensor to surface
- (f) Calculation of the averaged SAR within masses of 1 g and 10 g

3.4.5 SAR Averaged Methods

In DASY, the interpolation and extrapolation are both based on the modified Quadratic Shepard's method. The interpolation scheme combines a least-square fitted function method and a weighted average method which are the two basic types of computational interpolation and approximation.

Extrapolation routines are used to obtain SAR values between the lowest measurement points and the inner phantom surface. The extrapolation distance is determined by the surface detection distance and the probe sensor offset. The uncertainty increases with the extrapolation distance. To keep the uncertainty within 1% for the 1 g and 10 g cubes, the extrapolation distance should not be larger than 5 mm.

4. SAR Measurement Evaluation

4.1 EUT Configuration and Setting

<Connections between EUT and System Simulator>

For WWAN SAR testing, the EUT was linked and controlled by base station emulator (Agilent E5515C is used for GSM/WCDMA/CDMA, and Anritsu MT8820C is used for LTE). Communication between the EUT and the emulator was established by air link. The distance between the EUT and the communicating antenna of the emulator is larger than 50 cm and the output power radiated from the emulator antenna is at least 30 dB smaller than the output power of EUT. The EUT was set from the emulator to radiate maximum output power during SAR testing.

<Considerations Related to CDMA for Setup and Testing>

EV-DO Data Devices

SAR is measured using the F/R TAP configurations required for Rev. 0, Rev. A and Rev. B. The AT is tested with a Reverse Data Channel rate of 153.6 kbps in Subtype 0/1 Physical Layer configurations. A Reverse Data Channel payload size of 4096 bits and Termination Target of 16 slots are used for Subtype 2 and 3. FTAP, FETAP and FMCTAP are all configured with a Forward Traffic Channel data rate corresponding to the 2-slot version of 307.2 kbps with ACK Channel transmitting in all slots. AT power control is in “All Bits Up” conditions for the TAP / ETAP / MCTAP. Body-worn and other body SAR are measured using Subtype 0/1 Physical Layer configurations for Rev. 0. The 3G SAR test reduction procedure is applied to Rev. A, Subtype 2 Physical layer configuration, with Rev. 0 as the primary mode. Otherwise, SAR is measured for Rev. A using the highest reported SAR configuration for body-worn exposure in Rev. 0. SAR is required for Rev. B, Subtype 3; it is measured by applying both the “test 2” and “test 3” configurations used for power measurement.

EV-DO Data Devices Support 1xRTT

The 3G SAR test reduction procedure is applied to 1xRTT RC3 and RC1 with EV-DO Rev. 0, Rev. A and Rev. B as the respective primary modes. Otherwise, the “CDMA 1xRTT Handsets Body-worn SAR” procedures are applied.

<Considerations Related to LTE for Setup and Testing>

This device contains LTE transmitter which follows 3GPP standards, is category 3, supports both QPSK and 16QAM modulations, and supported LTE band and channel bandwidth is listed in below. The output power was tested per 3GPP TS 36.521-1 maximum transmit procedures for both QPSK and 16QAM modulation. The results please refer to section 4.6 of this report.

EUT Supported LTE Band and Channel Bandwidth						
LTE Band	BW 1.4 MHz	BW 3 MHz	BW 5 MHz	BW 10 MHz	BW 15 MHz	BW 20 MHz
2	V	V	V	V	V	V
4	V	V	V	V	V	V
5	V	V	V	V	-	-
12	V	V	V	V	-	-
25	V	V	V	V	V	V

The LTE maximum power reduction (MPR) in accordance with 3GPP TS 36.101 is active all times during LTE operation. The allowed MPR for the maximum output power is specified in below.

FCC SAR Test Report

Modulation	Channel Bandwidth / RB Configurations						LTE MPR Setting (dB)
	BW 1.4 MHz	BW 3 MHz	BW 5 MHz	BW 10 MHz	BW 15 MHz	BW 20 MHz	
QPSK	> 5	> 4	> 8	> 12	> 16	> 18	1
16QAM	<= 5	<= 4	<= 8	<= 12	<= 16	<= 18	1
16QAM	> 5	> 4	> 8	> 12	> 16	> 18	2

Note: MPR is according to the standard and implemented in the circuit (mandatory).

In addition, the device is compliant with A-MPR requirements defined in 36.101 section 6.2.4 that may be required to meet 3GPP Adjacent Channel Leakage Ratio ("ACLR") requirements. A-MPR was disabled for all FCC compliance testing.

The normal network operating configurations of 802.11 transmitters are not suitable for SAR measurements. Unpredictable fluctuations in network traffic and antenna diversity conditions can introduce undesirable variations in SAR results. The SAR for these devices should be measured using chipset based test mode software to ensure the results are consistent and reliable. See KDB Publication 248227 D01v02r02 for more details.

<Considerations Related to WLAN for Setup and Testing>

In general, various vendor specific external test software and chipset based internal test modes are typically used for SAR measurement. These chipset based test mode utilities are generally hardware and manufacturer dependent, and often include substantial flexibility to reconfigure or reprogram a device. A Wi-Fi device must be configured to transmit continuously at the required data rate, channel bandwidth and signal modulation, using the highest transmission duty factor supported by the test mode tools for SAR measurement. The test frequencies established using test mode must correspond to the actual channel frequencies. When 802.11 frame gaps are accounted for in the transmission, a maximum transmission duty factor of 92 - 96% is typically achievable in most test mode configurations. A minimum transmission duty factor of 85% is required to avoid certain hardware and device implementation issues related to wide range SAR scaling. In addition, a periodic transmission duty factor is required for current generation SAR systems to measure SAR correctly. The reported SAR must be scaled to 100% transmission duty factor to determine compliance at the maximum tune-up tolerance limit.

According to KDB 248227 D01, this device has installed WLAN engineering testing software which can provide continuous transmitting RF signal. During WLAN SAR testing, this device was operated to transmit continuously at the maximum transmission duty with specified transmission mode, operating frequency, lowest data rate, and maximum output power.

Initial Test Configuration

An initial test configuration is determined for OFDM transmission modes in 2.4 GHz and 5 GHz bands according to the channel bandwidth, modulation and data rate combination(s) with the highest maximum output power specified for production units in each standalone and aggregated frequency band. When the same maximum power is specified for multiple transmission modes in a frequency band, the largest channel bandwidth, lowest order modulation, lowest data rate and lowest order 802.11a/g/n/ac mode is used for SAR measurement, on the highest measured output power channel in the initial test configuration, for each frequency band.

Subsequent Test Configuration

SAR measurement requirements for the remaining 802.11 transmission mode configurations that have not been tested in the initial test configuration are determined separately for each standalone and aggregated frequency band, in each exposure condition, according to the maximum output power specified for production units. Additional power measurements may be required to determine if SAR measurements are required for subsequent highest output power channels in a subsequent test configuration. When the highest reported SAR for the initial test configuration according to the initial test position or fixed exposure position requirements, is adjusted by the ratio of the subsequent test configuration to initial test configuration specified maximum output power and the adjusted SAR is ≤ 1.2 W/kg, SAR is not required for that subsequent test configuration.

SAR Test Configuration and Channel Selection

When multiple channel bandwidth configurations in a frequency band have the same specified maximum output power, the initial test configuration is using largest channel bandwidth, lowest order modulation, lowest data rate, and lowest order 802.11 mode (i.e., 802.11a is chosen over 802.11n then 802.11ac or 802.11g is chosen over 802.11n). After an initial test configuration is determined, if multiple test channels have the same measured maximum output power, the channel chosen for SAR measurement is determined according to the following.

- 1) The channel closest to mid-band frequency is selected for SAR measurement.
- 2) For channels with equal separation from mid-band frequency; for example, high and low channels or two mid-band channels, the higher frequency (number) channel is selected for SAR measurement.

4.2 EUT Testing Position

4.2.1 Hotspot Mode Exposure conditions

For handsets that support hotspot mode operations, with wireless router capabilities and various web browsing functions, the relevant hand and body exposure conditions are tested according to the hotspot SAR procedures in KDB 941225 D06. A test separation distance of 10 mm is required between the phantom and all surfaces and edges with a transmitting antenna located within 25 mm from that surface or edge. When the form factor of a handset is smaller than 9 cm x 5 cm, a test separation distance of 5 mm (instead of 10 mm) is required for testing hotspot mode. When the separation distance required for body-worn accessory testing is larger than or equal to that tested for hotspot mode, in the same wireless mode and for the same surface of the phone, the hotspot mode SAR data may be used to support body-worn accessory SAR compliance for that particular configuration (surface).

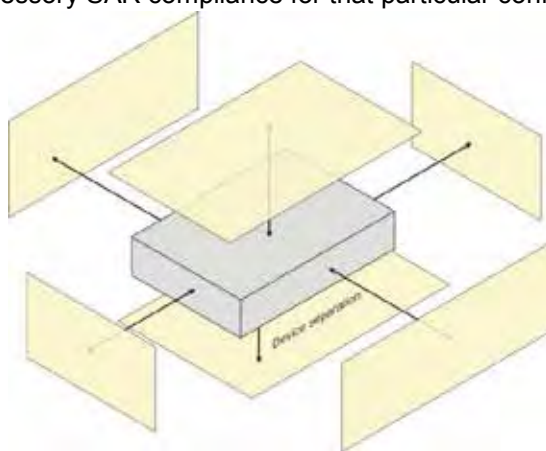

<Antenna Location>

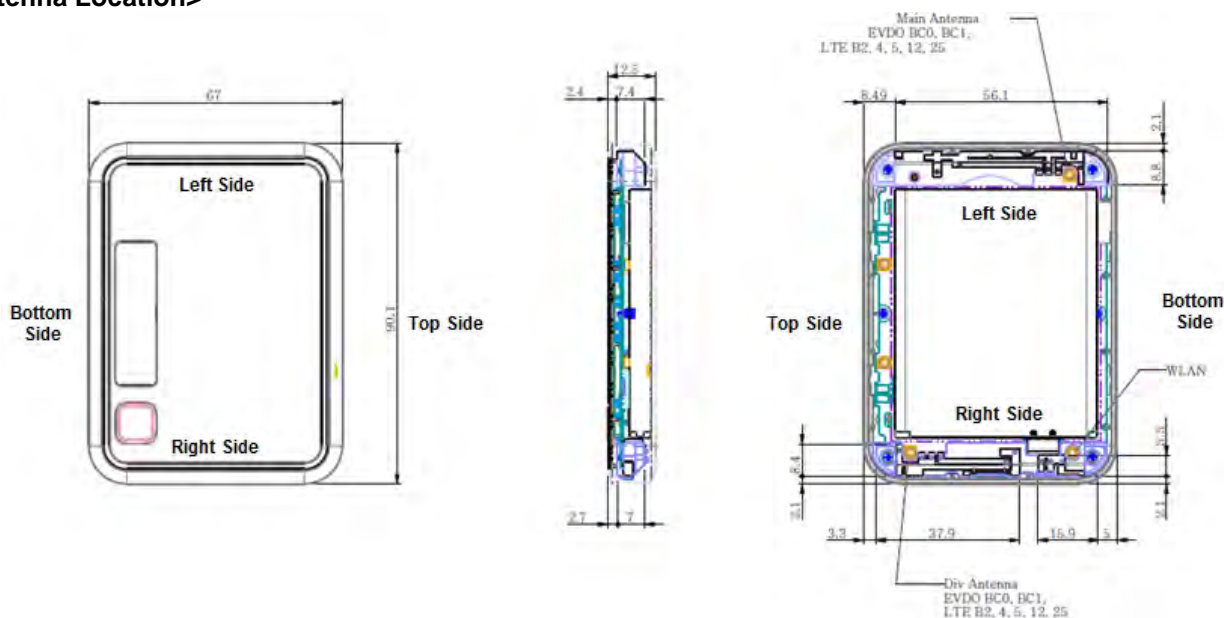

Based on the antenna location, the SAR testing required for hotspot mode is listed as below.

Antenna	Front Face	Rear Face	Left Side	Right Side	Top Side	Bottom Side
WWAN	V	V	V	-	V	V
WLAN	V	V	-	V	-	V

FCC SAR Test Report

4.2.2 Simultaneous Transmission Possibilities

The simultaneous transmission possibilities are listed as below.

Simultaneous TX Combination	Configuration	Hotspot (Data)
1	CDMA2000 BC0 (Data) + WLAN (Data)	Yes
2	CDMA2000 BC1 (Data) + WLAN (Data)	Yes
3	LTE 2 (Data) + WLAN (Data)	Yes
4	LTE 4 (Data) + WLAN (Data)	Yes
5	LTE 5 (Data) + WLAN (Data)	Yes
6	LTE 12 (Data) + WLAN (Data)	Yes
7	LTE 25 (Data) + WLAN (Data)	Yes

Note:

1. The WWAN transmitter can only use either CDMA or LTE at a time.
2. Only WLAN 2.4G (802.11b/g/n) supports wireless hotspot capability.

FCC SAR Test Report

4.3 Tissue Verification

The measuring results for tissue simulating liquid are shown as below.

Test Date	Tissue Type	Frequency (MHz)	Liquid Temp. (°C)	Measured Conductivity (σ)	Measured Permittivity (ϵ_r)	Target Conductivity (σ)	Target Permittivity (ϵ_r)	Conductivity Deviation (%)	Permittivity Deviation (%)
Nov. 30, 2017	B750	750	21.6	0.964	56.476	0.96	55.5	0.42	1.76
Nov. 30, 2017	B835	835	21.6	0.988	55.922	0.97	55.2	1.86	1.31
Dec. 02, 2017	B1750	1750	21.4	1.439	54.005	1.49	53.4	-3.42	1.13
Oct. 31, 2017	B1900	1900	22.1	1.553	53.104	1.52	53.3	2.17	-0.37
Dec. 01, 2017	B1900	1900	21.5	1.550	53.404	1.52	53.3	1.97	0.20
Oct. 28, 2017	B2450	2450	22.0	2.005	51.692	1.95	52.7	2.82	-1.91

Note:

The dielectric properties of the tissue simulating liquid must be measured within 24 hours before the SAR testing and within $\pm 5\%$ of the target values. Liquid temperature during the SAR testing must be within ± 2 °C.

4.4 System Verification

The measuring result for system verification is tabulated as below.

Test Date	Frequency (MHz)	1W Target SAR-1g (W/kg)	Measured SAR-1g (W/kg)	Normalized to 1W SAR-1g (W/kg)	Deviation (%)	Dipole S/N	Probe S/N	DAE S/N
Nov. 30, 2017	750	8.56	2.06	8.24	-3.74	1096	7419	1397
Nov. 30, 2017	835	9.57	2.52	10.08	5.33	4d021	7419	1397
Dec. 02, 2017	1750	36.50	9.29	37.16	1.81	1102	7419	1397
Oct. 31, 2017	1900	40.30	10.30	41.20	2.23	5d022	7419	1397
Dec. 01, 2017	1900	40.30	10.20	40.80	1.24	5d022	7419	1397
Oct. 28, 2017	2450	50.80	13.20	52.80	3.94	716	7419	1397

Note:

Comparing to the reference SAR value provided by SPEAG, the validation data should be within its specification of 10 %. The result indicates the system check can meet the variation criterion and the plots can be referred to Appendix A of this report.

FCC SAR Test Report

4.5 Maximum Output Power

4.5.1 Maximum Conducted Power

The maximum conducted average power (Unit: dBm) including tune-up tolerance is shown as below.

Mode	CDMA BC0	CDMA BC1
1xRTT	24.0	21.0
1xEVDO Rev.0	24.0	21.0
1xEVDO Rev.A	24.0	21.0

Mode	LTE 2	LTE 4
QPSK / 16QAM	21.0	23.0

Mode	LTE 5	LTE 12	LTE 25
QPSK / 16QAM	24.0	25.0	21.0

Mode	2.4G WLAN
802.11b	11.0
802.11g	11.0
802.11n HT20	11.0

FCC SAR Test Report

4.5.2 Measured Conducted Power Result

The measuring conducted average power (Unit: dBm) is shown as below.

Band Channel	CDMA BC0			CDMA BC1		
	1013	384	777	25	600	1175
Frequency (MHz)	824.70	836.52	848.31	1851.25	1880.00	1908.75
1xRTT RC1+SO55	23.49	23.47	23.39	20.35	20.41	20.27
1xRTT RC3+SO55	23.39	23.41	23.30	20.34	20.38	20.28
1xRTT RC3+SO32 (FCH)	23.53	23.43	23.37	20.40	20.39	20.31
1xRTT RC3+SO32 (SCH)	23.50	23.39	23.28	20.37	20.41	20.33
1xEVDO Rev.0 RTAP 153.6	23.55	23.51	23.47	20.28	20.44	20.31
1xEVDO Rev.A RETAP 4096	23.54	23.43	23.49	20.07	20.34	20.11

LTE Band / BW	RB Size	RB Offset	QPSK			3GPP MPR (dB)	16QAM			3GPP MPR (dB)
			Low CH 18607	Mid CH 18900	High CH 19193		Low CH 18607	Mid CH 18900	High CH 19193	
			1850.7 MHz	1880.0 MHz	1909.3 MHz		1850.7 MHz	1880.0 MHz	1909.3 MHz	
2 / 1.4M	1	0	20.28	20.26	20.09	0	19.05	19.09	19.05	1
	1	2	20.26	20.33	20.20	0	19.00	19.07	19.02	1
	1	5	20.23	20.21	20.22	0	19.07	19.09	19.01	1
	3	0	20.33	20.32	20.41	0	19.16	19.01	19.09	1
	3	1	20.37	20.47	20.50	0	19.29	19.18	19.17	1
	3	3	20.43	20.39	20.28	0	19.43	19.15	19.19	1
	6	0	19.22	19.26	19.07	1	18.20	18.22	18.19	2

LTE Band / BW	RB Size	RB Offset	QPSK			3GPP MPR (dB)	16QAM			3GPP MPR (dB)
			Low CH 18615	Mid CH 18900	High CH 19185		Low CH 18615	Mid CH 18900	High CH 19185	
			1851.5 MHz	1880.0 MHz	1908.5 MHz		1851.5 MHz	1880.0 MHz	1908.5 MHz	
2 / 3M	1	0	20.32	20.37	20.33	0	18.99	19.08	18.99	1
	1	7	20.37	20.51	20.52	0	18.99	19.01	19.02	1
	1	14	20.25	20.43	20.28	0	19.01	19.04	19.07	1
	8	0	19.30	19.22	19.10	1	18.17	18.04	18.08	2
	8	3	19.25	19.26	19.21	1	18.26	18.08	18.01	2
	8	7	19.27	19.27	19.19	1	18.34	18.1	18.28	2
	15	0	19.22	19.26	19.08	1	18.28	18.04	18	2

LTE Band / BW	RB Size	RB Offset	QPSK			3GPP MPR (dB)	16QAM			3GPP MPR (dB)
			Low CH 18625	Mid CH 18900	High CH 19175		Low CH 18625	Mid CH 18900	High CH 19175	
			1852.5 MHz	1880.0 MHz	1907.5 MHz		1852.5 MHz	1880.0 MHz	1907.5 MHz	
2 / 5M	1	0	20.35	20.34	20.26	0	19.07	19.05	19.04	1
	1	12	20.48	20.56	20.59	0	19.01	18.97	19.02	1
	1	24	20.21	20.38	20.44	0	19.03	19.05	19.07	1
	12	0	19.24	19.31	19.12	1	18.02	18.30	18.26	2
	12	6	19.27	19.26	19.20	1	18.01	18.29	18.30	2
	12	13	19.11	19.18	19.20	1	18.08	18.19	18.11	2
	25	0	19.22	19.26	19.18	1	18.29	18.28	18.17	2



FCC SAR Test Report

LTE Band / BW	RB Size	RB Offset	QPSK			3GPP MPR (dB)	16QAM			3GPP MPR (dB)
			Low CH 18650	Mid CH 18900	High CH 19150		Low CH 18650	Mid CH 18900	High CH 19150	
			1855.0 MHz	1880.0 MHz	1905.0 MHz		1855.0 MHz	1880.0 MHz	1905.0 MHz	
2 / 10M	1	0	20.49	20.41	20.35	0	19.00	18.87	18.97	1
	1	24	20.59	20.59	20.50	0	19.14	19.07	19.08	1
	1	49	20.14	20.30	20.36	0	19.03	19.04	19.08	1
	25	0	19.28	19.25	19.22	1	18.29	18.38	18.28	2
	25	12	19.10	19.27	19.23	1	18.01	18.51	18.30	2
	25	25	19.01	19.23	19.14	1	18.32	18.35	18.20	2
	50	0	19.21	19.31	19.15	1	18.23	18.36	18.23	2

LTE Band / BW	RB Size	RB Offset	QPSK			3GPP MPR (dB)	16QAM			3GPP MPR (dB)
			Low CH 18675	Mid CH 18900	High CH 19125		Low CH 18675	Mid CH 18900	High CH 19125	
			1857.5 MHz	1880.0 MHz	1902.5 MHz		1857.5 MHz	1880.0 MHz	1902.5 MHz	
2 / 15M	1	0	20.45	20.49	20.38	0	19.00	18.90	18.97	1
	1	37	20.60	20.64	20.41	0	18.88	19.09	18.79	1
	1	74	20.21	20.38	20.33	0	18.81	18.91	18.88	1
	36	0	19.22	19.25	19.21	1	18.24	18.16	18.20	2
	36	19	19.05	19.33	19.18	1	18.06	18.32	18.37	2
	36	39	19.03	19.23	19.12	1	17.95	18.20	18.13	2
	75	0	19.20	19.28	19.22	1	18.30	18.25	18.22	2

LTE Band / BW	RB Size	RB Offset	QPSK			3GPP MPR (dB)	16QAM			3GPP MPR (dB)
			Low CH 18700	Mid CH 18900	High CH 19100		Low CH 18700	Mid CH 18900	High CH 19100	
			1860.0 MHz	1880.0 MHz	1900.0 MHz		1860.0 MHz	1880.0 MHz	1900.0 MHz	
2 / 20M	1	0	20.47	20.42	20.30	0	19.38	18.87	18.87	1
	1	50	20.44	20.67	20.54	0	19.60	19.13	19.29	1
	1	99	20.19	20.28	20.27	0	18.81	18.86	18.83	1
	50	0	19.29	19.35	19.26	1	18.33	18.18	18.29	2
	50	25	19.13	19.26	19.13	1	18.27	18.30	18.27	2
	50	50	18.92	19.21	19.06	1	18.09	18.32	18.18	2
	100	0	19.18	19.28	19.16	1	18.21	18.17	18.20	2

LTE Band / BW	RB Size	RB Offset	QPSK			3GPP MPR (dB)	16QAM			3GPP MPR (dB)
			Low CH 19957	Mid CH 20175	High CH 20393		Low CH 19957	Mid CH 20175	High CH 20393	
			1710.7 MHz	1732.5 MHz	1754.3 MHz		1710.7 MHz	1732.5 MHz	1754.3 MHz	
4 / 1.4M	1	0	22.21	21.96	21.87	0	20.91	20.68	20.69	1
	1	2	22.26	22.06	22.12	0	20.86	20.72	20.69	1
	1	5	22.11	22.12	22.19	0	20.92	20.71	20.77	1
	3	0	22.15	21.93	22.00	0	21.03	20.67	20.78	1
	3	1	22.17	21.95	22.11	0	21.09	20.73	20.89	1
	3	3	22.10	22.05	21.99	0	20.96	20.72	20.87	1
	6	0	20.91	20.83	20.84	1	20.04	19.71	19.87	2



FCC SAR Test Report

LTE Band / BW	RB Size	RB Offset	QPSK			3GPP MPR (dB)	16QAM			3GPP MPR (dB)
			Low CH 19965	Mid CH 20175	High CH 20385		Low CH 19965	Mid CH 20175	High CH 20385	
			1711.5 MHz	1732.5 MHz	1753.5 MHz		1711.5 MHz	1732.5 MHz	1753.5 MHz	
4 / 3M	1	0	22.21	22.00	21.91	0	20.7	20.69	20.72	1
	1	7	22.19	22.07	22.06	0	20.69	20.75	20.73	1
	1	14	22.07	22.00	22.15	0	20.72	20.75	20.7	1
	8	0	20.93	20.95	20.92	1	20.06	19.94	19.71	2
	8	3	21.03	20.85	20.89	1	20.07	19.96	20.22	2
	8	7	20.98	20.97	20.83	1	20.29	19.92	20.15	2
	15	0	21.00	20.91	20.88	1	20.02	19.77	20.03	2

LTE Band / BW	RB Size	RB Offset	QPSK			3GPP MPR (dB)	16QAM			3GPP MPR (dB)
			Low CH 19975	Mid CH 20175	High CH 20375		Low CH 19975	Mid CH 20175	High CH 20375	
			1712.5 MHz	1732.5 MHz	1752.5 MHz		1712.5 MHz	1732.5 MHz	1752.5 MHz	
4 / 5M	1	0	22.18	21.97	22.04	0	20.84	20.69	20.70	1
	1	12	22.08	22.06	22.12	0	20.33	20.75	20.84	1
	1	24	21.96	21.99	22.14	0	20.22	20.73	20.79	1
	12	0	20.86	20.85	20.97	1	19.85	19.78	19.98	2
	12	6	20.98	20.93	21.08	1	19.86	19.88	20.05	2
	12	13	20.8	20.9	21.03	1	19.78	19.75	20.09	2
	25	0	20.84	20.87	20.96	1	19.82	19.81	20.12	2

LTE Band / BW	RB Size	RB Offset	QPSK			3GPP MPR (dB)	16QAM			3GPP MPR (dB)
			Low CH 20000	Mid CH 20175	High CH 20350		Low CH 20000	Mid CH 20175	High CH 20350	
			1715.0 MHz	1732.5 MHz	1750.0 MHz		1715.0 MHz	1732.5 MHz	1750.0 MHz	
4 / 10M	1	0	22.31	21.98	22.21	0	20.82	20.69	20.80	1
	1	24	22.40	22.13	22.53	0	20.71	20.72	20.79	1
	1	49	22.06	21.77	22.08	0	20.70	20.69	20.72	1
	25	0	21.02	20.82	21.09	1	19.99	19.91	20.19	2
	25	12	21.00	20.89	21.11	1	20.15	20.18	20.35	2
	25	25	20.85	20.76	20.97	1	20.00	20.11	20.16	2
	50	0	20.94	20.80	20.98	1	20.08	19.90	20.25	2

LTE Band / BW	RB Size	RB Offset	QPSK			3GPP MPR (dB)	16QAM			3GPP MPR (dB)
			Low CH 20025	Mid CH 20175	High CH 20325		Low CH 20025	Mid CH 20175	High CH 20325	
			1717.5 MHz	1732.5 MHz	1747.5 MHz		1717.5 MHz	1732.5 MHz	1747.5 MHz	
4 / 15M	1	0	22.21	22.19	22.4	0	20.69	20.73	20.93	1
	1	37	22.54	22.21	22.49	0	20.87	21.02	20.97	1
	1	74	22.11	22.09	22.02	0	20.73	20.72	20.68	1
	36	0	20.94	20.94	21.03	1	20.07	19.94	20.04	2
	36	19	20.96	20.96	20.98	1	20.11	19.99	19.86	2
	36	39	20.94	20.82	20.94	1	19.92	19.88	20.02	2
	75	0	20.94	20.85	21	1	19.91	19.91	20.08	2

FCC SAR Test Report

LTE Band / BW	RB Size	RB Offset	QPSK			3GPP MPR (dB)	16QAM			3GPP MPR (dB)
			Low CH 20050	Mid CH 20175	High CH 20300		Low CH 20050	Mid CH 20175	High CH 20300	
			1720.0 MHz	1732.5 MHz	1745.0 MHz		1720.0 MHz	1732.5 MHz	1745.0 MHz	
4 / 20M	1	0	22.26	22.01	22.28	0	20.82	20.66	21.04	1
	1	50	22.56	22.29	22.61	0	20.94	20.52	20.68	1
	1	99	22.13	22.02	22.04	0	20.66	20.67	20.60	1
	50	0	20.9	20.88	21.14	1	20.09	20.13	19.89	2
	50	25	20.94	20.84	21.03	1	20.06	20.05	19.97	2
	50	50	20.84	20.79	21	1	19.86	19.86	20.06	2
	100	0	20.9	20.87	21.01	1	20.04	20.07	20.08	2

LTE Band / BW	RB Size	RB Offset	QPSK			3GPP MPR (dB)	16QAM			3GPP MPR (dB)
			Low CH 20407	Mid CH 20525	High CH 20643		Low CH 20407	Mid CH 20525	High CH 20643	
			824.7 MHz	836.5 MHz	848.3 MHz		824.7 MHz	836.5 MHz	848.3 MHz	
5 / 1.4M	1	0	23.49	23.56	23.49	0	22.31	22.4	22.2	1
	1	2	23.60	23.77	23.71	0	22.37	22.25	22.22	1
	1	5	23.62	23.68	23.68	0	22.38	22.38	22.24	1
	3	0	23.43	23.71	23.49	0	22.27	22.55	22.39	1
	3	1	23.48	23.74	23.48	0	22.33	22.57	22.31	1
	3	3	23.45	23.68	23.39	0	22.32	22.61	22.33	1
	6	0	22.48	22.61	22.45	1	21.46	21.52	21.44	2

LTE Band / BW	RB Size	RB Offset	QPSK			3GPP MPR (dB)	16QAM			3GPP MPR (dB)
			Low CH 20415	Mid CH 20525	High CH 20635		Low CH 20415	Mid CH 20525	High CH 20635	
			825.5 MHz	836.5 MHz	847.5 MHz		825.5 MHz	836.5 MHz	847.5 MHz	
5 / 3M	1	0	23.45	23.63	23.46	0	22.26	22.26	22.09	1
	1	7	23.53	23.76	23.67	0	22.17	22.39	22.29	1
	1	14	23.59	23.55	23.51	0	22.36	22.27	21.96	1
	8	0	22.35	22.56	22.48	1	21.38	21.34	21.56	2
	8	3	22.43	22.67	22.50	1	21.6	21.56	21.45	2
	8	7	22.42	22.69	22.57	1	21.61	21.68	21.53	2
	15	0	22.40	22.53	22.46	1	21.27	21.59	21.21	2

LTE Band / BW	RB Size	RB Offset	QPSK			3GPP MPR (dB)	16QAM			3GPP MPR (dB)
			Low CH 20425	Mid CH 20525	High CH 20625		Low CH 20425	Mid CH 20525	High CH 20625	
			826.5 MHz	836.5 MHz	846.5 MHz		826.5 MHz	836.5 MHz	846.5 MHz	
5 / 5M	1	0	23.38	23.50	23.50	0	22.17	22.03	22.19	1
	1	12	23.57	23.72	23.81	0	22.35	22.05	21.99	1
	1	24	23.54	23.51	23.49	0	22.16	21.99	21.84	1
	12	0	22.37	22.49	22.47	1	21.50	21.32	21.40	2
	12	6	22.48	22.47	22.48	1	21.42	21.51	21.42	2
	12	13	22.42	22.49	22.38	1	21.32	21.53	21.41	2
	25	0	22.33	22.45	22.42	1	21.55	21.50	21.48	2



FCC SAR Test Report

LTE Band / BW	RB Size	RB Offset	QPSK			3GPP MPR (dB)	16QAM			3GPP MPR (dB)
			Low CH 20450	Mid CH 20525	High CH 20600		Low CH 20450	Mid CH 20525	High CH 20600	
			829.0 MHz	836.5 MHz	844.0 MHz		829.0 MHz	836.5 MHz	844.0 MHz	
5 / 10M	1	0	23.43	23.59	23.62	0	22.06	22.31	22.20	1
	1	24	23.72	23.77	23.85	0	22.24	22.46	22.27	1
	1	49	23.54	23.53	23.51	0	22.10	22.15	22.09	1
	25	0	22.54	22.56	22.70	1	21.42	21.59	21.63	2
	25	12	22.45	22.55	22.46	1	21.55	21.42	21.51	2
	25	25	22.45	22.43	22.47	1	21.34	21.46	21.48	2
	50	0	22.50	22.49	22.51	1	21.44	21.54	21.46	2

LTE Band / BW	RB Size	RB Offset	QPSK			3GPP MPR (dB)	16QAM			3GPP MPR (dB)
			Low CH 23017	Mid CH 23095	High CH 23173		Low CH 23017	Mid CH 23095	High CH 23173	
			699.7 MHz	707.5 MHz	715.3 MHz		699.7 MHz	707.5 MHz	715.3 MHz	
12 / 1.4M	1	0	24.27	24.35	24.1	0	22.93	23.16	22.99	1
	1	2	24.15	24.57	24.26	0	23.00	23.11	22.97	1
	1	5	24.21	24.19	24.40	0	23.11	23.04	22.96	1
	3	0	24.04	24.18	24.16	0	22.95	23.08	22.95	1
	3	1	24.26	24.32	24.26	0	23.14	23.20	23.12	1
	3	3	24.29	24.20	24.31	0	23.19	23.16	23.09	1
	6	0	23.17	23.07	23.17	1	22.24	22.08	22.23	2

LTE Band / BW	RB Size	RB Offset	QPSK			3GPP MPR (dB)	16QAM			3GPP MPR (dB)
			Low CH 23025	Mid CH 23095	High CH 23165		Low CH 23025	Mid CH 23095	High CH 23165	
			700.5 MHz	707.5 MHz	714.5 MHz		700.5 MHz	707.5 MHz	714.5 MHz	
12 / 3M	1	0	24.20	24.32	24.39	0	22.93	23.00	23.14	1
	1	7	24.35	24.30	24.45	0	23.06	23.03	23.04	1
	1	14	24.23	24.21	24.39	0	22.92	22.94	23.03	1
	8	0	23.26	23.23	23.40	1	22.04	22.27	22.35	2
	8	3	23.35	23.17	23.36	1	22.07	22.22	22.13	2
	8	7	23.20	23.24	23.23	1	22.13	22.16	22.21	2
	15	0	23.14	23.13	23.25	1	22.07	22.12	22.01	2

LTE Band / BW	RB Size	RB Offset	QPSK			3GPP MPR (dB)	16QAM			3GPP MPR (dB)
			Low CH 23035	Mid CH 23095	High CH 23155		Low CH 23035	Mid CH 23095	High CH 23155	
			701.5 MHz	707.5 MHz	713.5 MHz		701.5 MHz	707.5 MHz	713.5 MHz	
12 / 5M	1	0	24.22	24.07	24.23	0	22.97	22.95	22.93	1
	1	12	24.37	24.27	24.63	0	23.03	23.00	22.96	1
	1	24	24.17	24.18	24.35	0	22.94	22.99	22.94	1
	12	0	23.20	23.18	23.08	1	22.24	22.13	22.04	2
	12	6	23.24	23.22	23.14	1	21.94	22.08	22.22	2
	12	13	23.19	23.13	23.19	1	22.05	22.19	21.94	2
	25	0	23.14	23.12	23.21	1	22.28	22.18	22.06	2

FCC SAR Test Report

LTE Band / BW	RB Size	RB Offset	QPSK			3GPP MPR (dB)	16QAM			3GPP MPR (dB)
			Low CH 23060	Mid CH 23095	High CH 23130		Low CH 23060	Mid CH 23095	High CH 23130	
			704.0 MHz	707.5 MHz	711.0 MHz		704.0 MHz	707.5 MHz	711.0 MHz	
12 / 10M	1	0	24.14	24.18	24.27	0	22.97	23.03	23.06	1
	1	24	24.74	24.65	24.52	0	23.03	23.07	22.99	1
	1	49	24.24	24.23	24.21	0	22.98	22.93	22.97	1
	25	0	23.18	23.23	23.19	1	22.19	22.27	22.24	2
	25	12	23.23	23.14	23.15	1	22.10	22.19	22.14	2
	25	25	23.28	23.23	23.17	1	22.13	22.11	22.23	2
	50	0	23.22	23.24	23.19	1	22.18	22.08	22.09	2

LTE Band / BW	RB Size	RB Offset	QPSK			3GPP MPR (dB)	16QAM			3GPP MPR (dB)
			Low CH 26047	Mid CH 26365	High CH 26683		Low CH 26047	Mid CH 26365	High CH 26683	
			1850.7 MHz	1882.5 MHz	1914.3 MHz		1850.7 MHz	1882.5 MHz	1914.3 MHz	
25 / 1.4M	1	0	20.35	20.48	20.17	0	19.05	19.22	19.02	1
	1	2	20.51	20.60	20.30	0	19.01	19.11	18.92	1
	1	5	20.29	20.55	20.12	0	18.98	19.10	18.97	1
	3	0	20.28	20.52	20.35	0	19.24	19.31	19.09	1
	3	1	20.31	20.51	20.43	0	19.22	19.54	19.23	1
	3	3	20.25	20.63	20.23	0	19.16	19.58	19.42	1
	6	0	19.24	19.40	19.13	1	18.06	18.64	18.01	2

LTE Band / BW	RB Size	RB Offset	QPSK			3GPP MPR (dB)	16QAM			3GPP MPR (dB)
			Low CH 26055	Mid CH 26365	High CH 26675		Low CH 26055	Mid CH 26365	High CH 26675	
			1851.5 MHz	1882.5 MHz	1913.5 MHz		1851.5 MHz	1882.5 MHz	1913.5 MHz	
25 / 3M	1	0	20.37	20.75	20.36	0	18.98	19.01	19.12	1
	1	7	20.53	20.59	20.70	0	18.93	18.92	19.24	1
	1	14	20.42	20.48	20.28	0	18.94	18.49	19.13	1
	8	0	19.39	19.55	19.33	1	18.01	18.43	18.31	2
	8	3	19.37	19.49	19.36	1	18.1	18.67	18.46	2
	8	7	19.26	19.40	19.28	1	18.51	18.65	18.31	2
	15	0	19.34	19.37	19.27	1	18.14	18.51	18.52	2

LTE Band / BW	RB Size	RB Offset	QPSK			3GPP MPR (dB)	16QAM			3GPP MPR (dB)
			Low CH 26065	Mid CH 26365	High CH 26665		Low CH 26065	Mid CH 26365	High CH 26665	
			1852.5 MHz	1882.5 MHz	1912.5 MHz		1852.5 MHz	1882.5 MHz	1912.5 MHz	
25 / 5M	1	0	20.37	20.71	20.47	0	19.01	19.13	19.00	1
	1	12	20.52	20.72	20.81	0	18.92	18.94	19.52	1
	1	24	20.32	20.47	20.48	0	18.90	18.98	19.34	1
	12	0	19.32	19.55	19.12	1	18.15	18.39	17.94	2
	12	6	19.29	19.41	19.32	1	18.14	18.24	18.44	2
	12	13	19.23	19.29	19.33	1	18.13	18.20	18.39	2
	25	0	19.32	19.42	19.23	1	18.20	18.48	18.25	2

FCC SAR Test Report

LTE Band / BW	RB Size	RB Offset	QPSK			3GPP MPR (dB)	16QAM			3GPP MPR (dB)
			Low CH 26090	Mid CH 26365	High CH 26640		Low CH 26090	Mid CH 26365	High CH 26640	
			1855.0 MHz	1882.5 MHz	1910.0 MHz		1855.0 MHz	1882.5 MHz	1910.0 MHz	
25 / 10M	1	0	20.44	20.76	20.64	0	19.14	19.35	19.29	1
	1	24	20.81	20.82	20.79	0	19.12	19.24	19.1	1
	1	49	20.53	20.52	20.48	0	19.01	18.98	18.98	1
	25	0	19.42	19.6	19.43	1	18.46	18.58	18.47	2
	25	12	19.43	19.47	19.37	1	18.38	18.55	18.48	2
	25	25	19.24	19.26	19.26	1	18.29	18.34	18.35	2
	50	0	19.38	19.51	19.35	1	18.44	18.35	18.37	2

LTE Band / BW	RB Size	RB Offset	QPSK			3GPP MPR (dB)	16QAM			3GPP MPR (dB)
			Low CH 26115	Mid CH 26365	High CH 26615		Low CH 26115	Mid CH 26365	High CH 26615	
			1857.5 MHz	1882.5 MHz	1907.5 MHz		1857.5 MHz	1882.5 MHz	1907.5 MHz	
25 / 15M	1	0	20.54	20.73	20.61	0	19.32	19.45	19.33	1
	1	37	20.81	20.8	20.5	0	19.13	19.32	19.14	1
	1	74	20.74	20.67	20.63	0	19.01	19.19	19.25	1
	36	0	19.55	19.63	19.53	1	18.5	18.67	18.33	2
	36	19	19.66	19.47	19.39	1	18.41	18.53	18.47	2
	36	39	19.42	19.25	19.25	1	18.39	18.29	18.3	2
	75	0	19.58	19.45	19.31	1	18.59	18.44	18.33	2

LTE Band / BW	RB Size	RB Offset	QPSK			3GPP MPR (dB)	16QAM			3GPP MPR (dB)
			Low CH 26140	Mid CH 26365	High CH 26590		Low CH 26140	Mid CH 26365	High CH 26590	
			1860.0 MHz	1882.5 MHz	1905.0 MHz		1860.0 MHz	1882.5 MHz	1905.0 MHz	
25 / 20M	1	0	20.41	20.74	20.62	0	19.13	19.15	19.11	1
	1	50	20.83	20.85	20.64	0	19.44	19.52	19.39	1
	1	99	20.62	20.52	20.43	0	19.24	19.14	19.04	1
	50	0	19.48	19.69	19.43	1	18.36	18.46	18.52	2
	50	25	19.42	19.52	19.33	1	18.51	18.47	18.42	2
	50	50	19.49	19.39	19.31	1	18.4	18.52	18.19	2
	100	0	19.41	19.58	19.46	1	18.34	18.51	18.34	2

<WLAN 2.4G>

Mode	802.11b		
Channel / Frequency (MHz)	1 (2412)	6 (2437)	11 (2462)
Average Power	10.76	10.81	10.95
Mode	802.11g		
Channel / Frequency (MHz)	1 (2412)	6 (2437)	11 (2462)
Average Power	10.22	10.63	10.88
Mode	802.11n (HT20)		
Channel / Frequency (MHz)	1 (2412)	6 (2437)	11 (2462)
Average Power	10.59	10.79	10.45

4.6 SAR Testing Results

4.6.1 SAR Test Reduction Considerations

<KDB 447498 D01, General RF Exposure Guidance>

Testing of other required channels within the operating mode of a frequency band is not required when the reported SAR for the mid-band or highest output power channel is:

- (1) ≤ 0.8 W/kg or 2.0 W/kg, for 1-g or 10-g respectively, when the transmission band is ≤ 100 MHz
- (2) ≤ 0.6 W/kg or 1.5 W/kg, for 1-g or 10-g respectively, when the transmission band is between 100 MHz and 200 MHz
- (3) ≤ 0.4 W/kg or 1.0 W/kg, for 1-g or 10-g respectively, when the transmission band is ≥ 200 MHz

<KDB 941225 D01, 3G SAR Measurement Procedures>

The mode tested for SAR is referred to as the primary mode. The equivalent modes considered for SAR test reduction are denoted as secondary modes. Both primary and secondary modes must be in the same frequency band. When the maximum output power and tune-up tolerance specified for production units in a secondary mode is $\leq 1/4$ dB higher than the primary mode or when the highest reported SAR of the primary mode is scaled by the ratio of specified maximum output power and tune-up tolerance of secondary to primary mode and the adjusted SAR is ≤ 1.2 W/kg, SAR measurement is not required for the secondary mode.

<KDB 941225 D05, SAR Evaluation Considerations for LTE Devices>

- (1) QPSK with 1 RB and 50% RB allocation

Start with the largest channel bandwidth and measure SAR, using the RB offset and required test channel combination with the highest maximum output power among RB offsets at the upper edge, middle and lower edge of each required test channel. When the reported SAR is ≤ 0.8 W/kg, testing of the remaining RB offset configurations and required test channels is not required; otherwise, SAR is required for the remaining required test channels and only for the RB offset configuration with the highest output power for that channel. When the reported SAR of a required test channel is > 1.45 W/kg, SAR is required for all three RB offset configurations for that required test channel.

- (2) QPSK with 100% RB allocation

SAR is not required when the highest maximum output power for 100% RB allocation is less than the highest maximum output power in 50% and 1 RB allocations and the highest reported SAR for 1 RB and 50% RB allocation are ≤ 0.8 W/kg. Otherwise, SAR is measured for the highest output power channel; and if the reported SAR is > 1.45 W/kg, the remaining required test channels must also be tested.

- (3) Higher order modulations

SAR is required only when the highest maximum output power for the configuration in the higher order modulation is $> 1/2$ dB higher than the same configuration in QPSK or when the reported SAR for the QPSK configuration is > 1.45 W/kg.

- (4) Other channel bandwidth

SAR is required when the highest maximum output power of the smaller channel bandwidth is $> 1/2$ dB higher than the equivalent channel configurations in the largest channel bandwidth configuration or the reported SAR of a configuration for the largest channel bandwidth is > 1.45 W/kg.

FCC SAR Test Report

<KDB 248227 D01, SAR Guidance for Wi-Fi Transmitters>

- (1) For handsets operating next to ear, hotspot mode or mini-tablet configurations, the initial test position procedures were applied. The test position with the highest extrapolated peak SAR will be used as the initial test position. When the reported SAR of initial test position is ≤ 0.4 W/kg, SAR testing for remaining test positions is not required. Otherwise, SAR is evaluated at the subsequent highest peak SAR positions until the reported SAR result is ≤ 0.8 W/kg or all test positions are measured.
- (2) For WLAN 2.4 GHz, the highest measured maximum output power channel for DSSS was selected for SAR measurement. When the reported SAR is ≤ 0.8 W/kg, no further SAR testing is required. Otherwise, SAR is evaluated at the next highest measured output power channel. When any reported SAR is > 1.2 W/kg, SAR is required for the third channel. For OFDM modes (802.11g/n), SAR is not required when the highest reported SAR for DSSS is adjusted by the ratio of OFDM to DSSS specified maximum output power and it is ≤ 1.2 W/kg.

FCC SAR Test Report

4.6.2 SAR Results for Hotspot (Separation Distance is 1.0 cm Gap)

Plot No.	Band	Mode	Test Position	Ch.	Max. Tune-up Power (dBm)	Measured Conducted Power (dBm)	Scaling Factor	Power Drift (dB)	Measured SAR-1g (W/kg)	Scaled SAR-1g (W/kg)
1	CDMA BC0	RTAP 153.6	Front Face	1013	24.0	23.62	1.09	-0.02	0.773	0.84
	CDMA BC0	RTAP 153.6	Rear Face	1013	24.0	23.62	1.09	-0.02	0.691	0.75
	CDMA BC0	RTAP 153.6	Left Side	1013	24.0	23.62	1.09	-0.07	0.142	0.15
	CDMA BC0	RTAP 153.6	Top Side	1013	24.0	23.62	1.09	-0.05	0.199	0.22
	CDMA BC0	RTAP 153.6	Bottom Side	1013	24.0	23.62	1.09	-0.03	0.323	0.35
	CDMA BC1	RTAP 153.6	Front Face	600	21.0	20.44	1.14	0	0.506	0.58
	CDMA BC1	RTAP 153.6	Rear Face	600	21.0	20.44	1.14	0.13	0.873	0.99
	CDMA BC1	RTAP 153.6	Rear Face	25	21.0	20.28	1.18	0.2	0.920	1.09
	CDMA BC1	RTAP 153.6	Rear Face	1175	21.0	20.31	1.17	0.17	0.730	0.86
	CDMA BC1	RTAP 153.6	Left Side	600	21.0	20.44	1.14	0.08	1.310	1.49
2	CDMA BC1	RTAP 153.6	Left Side	600	21.0	20.44	1.14	0.07	1.310	1.49
	CDMA BC1	RTAP 153.6	Left Side	25	21.0	20.28	1.18	0.06	1.240	1.46
	CDMA BC1	RETAP 4096	Left Side	1175	21.0	20.31	1.17	0.07	1.180	1.38
	CDMA BC1	RETAP 4096	Left Side	600	21.0	20.34	1.16	0.16	1.270	1.48
	CDMA BC1	RETAP 4096	Left Side	25	21.0	20.07	1.24	0.09	1.110	1.38
	CDMA BC1	RETAP 4096	Left Side	1175	21.0	20.11	1.23	0.1	1.030	1.26
	CDMA BC1	RTAP 153.6	Top Side	600	21.0	20.44	1.14	0.19	0.026	0.03
	CDMA BC1	RTAP 153.6	Bottom Side	600	21.0	20.44	1.14	0.04	0.343	0.39

Plot No.	Band	Mode	Test Position	Ch.	RB#	RB Offset	Max. Tune-up Power (dBm)	Measured Conducted Power (dBm)	Scaling Factor	Power Drift (dB)	Measured SAR-1g (W/kg)	Scaled SAR-1g (W/kg)
	LTE 2	QPSK20M	Front Face	18900	1	50	21.0	20.67	1.08	0.14	0.586	0.63
	LTE 2	QPSK20M	Front Face	18900	50	0	20.0	19.35	1.16	0.17	0.455	0.53
	LTE 2	QPSK20M	Rear Face	18900	1	50	21.0	20.67	1.08	0.12	0.916	0.99
	LTE 2	QPSK20M	Rear Face	18700	1	50	21.0	20.44	1.14	0.14	0.923	1.05
	LTE 2	QPSK20M	Rear Face	19100	1	50	21.0	20.54	1.11	-0.07	0.832	0.92
	LTE 2	QPSK20M	Rear Face	18900	50	0	20.0	19.35	1.16	0.17	0.773	0.90
	LTE 2	QPSK20M	Rear Face	18700	50	0	20.0	19.29	1.18	0.14	0.710	0.84
	LTE 2	QPSK20M	Rear Face	19100	50	0	20.0	19.26	1.19	0.1	0.629	0.75
	LTE 2	QPSK20M	Rear Face	18900	100	0	20.0	19.28	1.18	0.27	0.738	0.87
	LTE 2	QPSK20M	Left Side	18900	1	50	21.0	20.67	1.08	0.18	1.250	1.35
3	LTE 2	QPSK20M	Left Side	18900	1	50	21.0	20.67	1.14	0.13	1.200	1.29
	LTE 2	QPSK20M	Left Side	18700	1	50	21.0	20.44	1.14	0.09	1.210	1.38
	LTE 2	QPSK20M	Left Side	19100	1	50	21.0	20.54	1.11	0.05	1.150	1.28
	LTE 2	QPSK20M	Left Side	18900	50	0	20.0	19.35	1.16	0.1	1.070	1.24
	LTE 2	QPSK20M	Left Side	18700	50	0	20.0	19.29	1.18	0.16	0.981	1.16
	LTE 2	QPSK20M	Left Side	19100	50	0	20.0	19.26	1.19	0.2	0.952	1.13
	LTE 2	QPSK20M	Left Side	18900	100	0	20.0	19.28	1.18	0.06	1.050	1.24
	LTE 2	QPSK20M	Top Side	18900	1	50	21.0	20.67	1.08	0	0.032	0.03
	LTE 2	QPSK20M	Top Side	18900	50	0	20.0	19.35	1.16	0	0.025	0.03
	LTE 2	QPSK20M	Bottom Side	18900	1	50	21.0	20.67	1.08	0.04	0.339	0.37
LTE 2	QPSK20M	Bottom Side	18900	50	0	20.0	19.35	1.16	-0.02	0.262	0.30	

FCC SAR Test Report

Plot No.	Band	Mode	Test Position	Ch.	RB#	RB Offset	Max. Tune-up Power (dBm)	Measured Conducted Power (dBm)	Scaling Factor	Power Drift (dB)	Measured SAR-1g (W/kg)	Scaled SAR-1g (W/kg)
4	LTE 4	QPSK20M	Front Face	20300	1	50	23.0	22.86	1.03	-0.09	0.439	0.45
	LTE 4	QPSK20M	Front Face	20300	50	0	22.0	21.39	1.15	0.14	0.365	0.42
	LTE 4	QPSK20M	Rear Face	20300	1	50	23.0	22.86	1.03	-0.14	0.678	0.70
	LTE 4	QPSK20M	Rear Face	20300	50	0	22.0	21.39	1.15	0.01	0.573	0.66
	LTE 4	QPSK20M	Left Side	20300	1	50	23.0	22.86	1.03	0.14	0.348	0.36
	LTE 4	QPSK20M	Left Side	20300	50	0	22.0	21.39	1.15	0.07	0.268	0.31
	LTE 4	QPSK20M	Top Side	20300	1	50	23.0	22.86	1.03	0	0.191	0.20
	LTE 4	QPSK20M	Top Side	20300	50	0	22.0	21.39	1.15	0.04	0.154	0.18
	LTE 4	QPSK20M	Bottom Side	20300	1	50	23.0	22.86	1.03	-0.04	0.305	0.31
	LTE 4	QPSK20M	Bottom Side	20300	50	0	22.0	21.39	1.15	-0.02	0.253	0.29
5	LTE 5	QPSK10M	Front Face	20600	1	24	24.0	23.87	1.03	-0.05	0.756	0.78
	LTE 5	QPSK10M	Front Face	20600	25	0	23.0	22.74	1.06	-0.03	0.621	0.66
	LTE 5	QPSK10M	Rear Face	20600	1	24	24.0	23.87	1.03	-0.02	0.658	0.68
	LTE 5	QPSK10M	Rear Face	20600	25	0	23.0	22.74	1.06	-0.06	0.553	0.59
	LTE 5	QPSK10M	Left Side	20600	1	24	24.0	23.87	1.03	-0.01	0.182	0.19
	LTE 5	QPSK10M	Left Side	20600	25	0	23.0	22.74	1.06	0.04	0.144	0.15
	LTE 5	QPSK10M	Top Side	20600	1	24	24.0	23.87	1.03	0	0.224	0.23
	LTE 5	QPSK10M	Top Side	20600	25	0	23.0	22.74	1.06	-0.02	0.18	0.19
	LTE 5	QPSK10M	Bottom Side	20600	1	24	24.0	23.87	1.03	-0.07	0.303	0.31
	LTE 5	QPSK10M	Bottom Side	20600	25	0	23.0	22.74	1.06	-0.06	0.252	0.27
6	LTE 12	QPSK10M	Front Face	23060	1	24	25	24.83	1.04	0.02	0.926	0.96
	LTE 12	QPSK10M	Front Face	23060	1	24	25	24.83	1.04	0.01	0.882	0.92
	LTE 12	QPSK10M	Front Face	23095	1	24	25	24.74	1.06	-0.02	0.864	0.92
	LTE 12	QPSK10M	Front Face	23130	1	24	25	24.61	1.09	-0.13	0.874	0.96
	LTE 12	QPSK10M	Front Face	23060	25	0	24	23.41	1.15	-0.04	0.725	0.83
	LTE 12	QPSK10M	Front Face	23095	25	0	24	23.32	1.17	0.05	0.751	0.88
	LTE 12	QPSK10M	Front Face	23130	25	0	24	23.28	1.18	0.02	0.784	0.93
	LTE 12	QPSK10M	Front Face	23060	50	0	24	23.33	1.17	-0.03	0.744	0.87
	LTE 12	QPSK10M	Front Face	23095	50	0	24	23.31	1.17	-0.07	0.764	0.90
	LTE 12	QPSK10M	Front Face	23130	50	0	24	23.28	1.18	-0.04	0.778	0.92
	LTE 12	QPSK10M	Rear Face	23060	1	24	25	24.83	1.04	-0.03	0.875	0.91
	LTE 12	QPSK10M	Rear Face	23095	1	24	25	24.74	1.06	-0.03	0.809	0.86
	LTE 12	QPSK10M	Rear Face	23130	1	24	25	24.61	1.09	-0.06	0.796	0.87
	LTE 12	QPSK10M	Rear Face	23060	25	0	24	23.41	1.15	-0.05	0.691	0.79
	LTE 12	QPSK10M	Left Side	23060	1	24	25	24.83	1.04	-0.09	0.220	0.23
	LTE 12	QPSK10M	Left Side	23060	25	0	24	23.41	1.15	-0.11	0.206	0.24
	LTE 12	QPSK10M	Top Side	23060	1	24	25	24.83	1.04	0	0.217	0.23
	LTE 12	QPSK10M	Top Side	23060	25	0	24	23.41	1.15	-0.07	0.176	0.20
LTE 12	QPSK10M	Bottom Side	23060	1	24	25	24.83	1.04	-0.01	0.340	0.35	
LTE 12	QPSK10M	Bottom Side	23060	25	0	24	23.41	1.15	-0.05	0.261	0.30	

FCC SAR Test Report

Plot No.	Band	Mode	Test Position	Ch.	RB#	RB Offset	Max. Tune-up Power (dBm)	Measured Conducted Power (dBm)	Scaling Factor	Power Drift (dB)	Measured SAR-1g (W/kg)	Scaled SAR-1g (W/kg)
	LTE 25	QPSK20M	Front Face	26365	1	50	21.0	20.85	1.04	0.07	0.586	0.61
	LTE 25	QPSK20M	Front Face	26365	50	0	20.0	19.69	1.07	0.13	0.463	0.50
	LTE 25	QPSK20M	Rear Face	26365	1	50	21.0	20.85	1.04	0.45	0.900	0.93
	LTE 25	QPSK20M	Rear Face	26140	1	50	21.0	20.83	1.04	0.05	0.938	0.98
	LTE 25	QPSK20M	Rear Face	26590	1	50	21.0	20.64	1.09	-0.03	0.791	0.86
	LTE 25	QPSK20M	Rear Face	26365	50	0	20.0	19.69	1.07	0.17	0.759	0.82
	LTE 25	QPSK20M	Rear Face	26140	50	0	20.0	19.48	1.13	0.2	0.689	0.78
	LTE 25	QPSK20M	Rear Face	26590	50	0	20.0	19.43	1.14	-0.03	0.611	0.70
	LTE 25	QPSK20M	Rear Face	26365	100	0	20.0	19.58	1.10	0.19	0.697	0.77
	LTE 25	QPSK20M	Left Side	26365	1	50	21.0	20.85	1.04	0.14	1.250	1.29
7	LTE 25	QPSK20M	Left Side	26140	1	50	21.0	20.83	1.04	-0.13	1.260	1.31
	LTE 25	QPSK20M	Left Side	26140	1	50	21.0	20.83	1.04	-0.13	1.220	1.27
	LTE 25	QPSK20M	Left Side	26590	1	50	21.0	20.64	1.09	0.03	1.200	1.30
	LTE 25	QPSK20M	Left Side	26365	50	0	20.0	19.69	1.07	0	1.050	1.13
	LTE 25	QPSK20M	Left Side	26140	50	0	20.0	19.48	1.13	0.14	0.935	1.05
	LTE 25	QPSK20M	Left Side	26590	50	0	20.0	19.43	1.14	0.08	0.917	1.05
	LTE 25	QPSK20M	Left Side	26365	100	0	20.0	19.58	1.10	0	0.881	0.97
	LTE 25	QPSK20M	Left Side	26140	100	0	20.0	19.41	1.15	0.01	0.863	0.99
	LTE 25	QPSK20M	Left Side	26590	100	0	20.0	19.46	1.13	0.06	0.799	0.90
	LTE 25	QPSK20M	Top Side	26365	1	50	21.0	20.85	1.04	0.11	0.032	0.03
	LTE 25	QPSK20M	Top Side	26365	50	0	20.0	19.69	1.07	0.13	0.027	0.03
	LTE 25	QPSK20M	Bottom Side	26365	1	50	21.0	20.85	1.04	0.09	0.371	0.38
	LTE 25	QPSK20M	Bottom Side	26365	50	0	20.0	19.69	1.07	-0.11	0.290	0.31

Plot No.	Band	Mode	Test Position	Ch.	Max. Tune-up Power (dBm)	Measured Conducted Power (dBm)	Scaling Factor	Power Drift (dB)	Measured SAR-1g (W/kg)	Scaled SAR-1g (W/kg)
	2.4G WLAN	802.11b	Front Face	11	11	10.95	1.01	0.15	0.046	0.05
8	2.4G WLAN	802.11b	Rear Face	11	11	10.95	1.01	0.05	0.060	0.06
	2.4G WLAN	802.11b	Right Side	11	11	10.95	1.01	0.19	0.015	0.02
	2.4G WLAN	802.11b	Left Side	11	11	10.95	1.01	0.15	0.00948	0.01
	2.4G WLAN	802.11b	Top Side	11	11	10.95	1.01	0.14	0.00728	0.01
	2.4G WLAN	802.11b	Bottom Side	11	11	10.95	1.01	0.15	0.027	0.03

Note:

SAR is performed on the highest power channel. When the reported SAR value of highest power channel is ≤ 0.8 W/kg, SAR testing for optional channel is not required.

FCC SAR Test Report

4.6.3 SAR Measurement Variability

According to KDB 865664 D01, SAR measurement variability was assessed for each frequency band, which is determined by the SAR probe calibration point and tissue-equivalent medium used for the device measurements. When both head and body tissue-equivalent media are required for SAR measurements in a frequency band, the variability measurement procedures should be applied to the tissue medium with the highest measured SAR, using the highest measured SAR configuration for that tissue-equivalent medium. Alternatively, if the highest measured SAR for both head and body tissue-equivalent media are ≤ 1.45 W/kg and the ratio of these highest SAR values, i.e., largest divided by smallest value, is ≤ 1.10 , the highest SAR configuration for either head or body tissue-equivalent medium may be used to perform the repeated measurement. These additional measurements are repeated after the completion of all measurements requiring the same head or body tissue-equivalent medium in a frequency band. The test device should be returned to ambient conditions (normal room temperature) with the battery fully charged before it is re-mounted on the device holder for the repeated measurement(s) to minimize any unexpected variations in the repeated results.

SAR repeated measurement procedure:

1. When the highest measured SAR is < 0.80 W/kg, repeated measurement is not required.
2. When the highest measured SAR is ≥ 0.80 W/kg, repeat that measurement once.
3. If the ratio of largest to smallest SAR for the original and first repeated measurements is > 1.20 , or when the original or repeated measurement is ≥ 1.45 W/kg, perform a second repeated measurement.
4. If the ratio of largest to smallest SAR for the original, first and second repeated measurements is > 1.20 , and the original, first or second repeated measurement is ≥ 1.5 W/kg, perform a third repeated measurement.

Band	Test Position	Ch.	Original Measured SAR-1g (W/kg)	1st Repeated SAR-1g (W/kg)	L/S Ratio	2nd Repeated SAR-1g (W/kg)	L/S Ratio	3rd Repeated SAR-1g (W/kg)	L/S Ratio
CDMA BC1	Left Side	600	1.310	1.310	1.00	N/A	N/A	N/A	N/A
LTE 2	Left Side	18900	1.250	1.200	1.04	N/A	N/A	N/A	N/A
LTE 4	Rear Face	20300	0.842	0.844	1.00	N/A	N/A	N/A	N/A
LTE 12	Front Face	23060	0.926	0.882	1.05	N/A	N/A	N/A	N/A
LTE 25	Left Side	26140	1.260	1.220	1.03	N/A	N/A	N/A	N/A

FCC SAR Test Report

4.6.4 Simultaneous Multi-band Transmission Evaluation

<SAR Summation Analysis>

Simultaneous transmission SAR test exclusion is determined for each operating configuration and exposure condition according to the reported standalone SAR of each applicable simultaneous transmitting antenna. When the sum of SAR_{1g} of all simultaneously transmitting antennas in an operating mode and exposure condition combination is within the SAR limit (SAR_{1g} 1.6 W/kg), the simultaneous transmission SAR is not required. When the sum of SAR_{1g} is greater than the SAR limit (SAR_{1g} 1.6 W/kg), SAR test exclusion is determined by the SPLSR.

No.	Conditions (SAR1 + SAR2)	Exposure Condition	Test Position	Max. SAR1	Max. SAR2	SAR Summation	SPLSR Analysis
01	CDMA BC0 + WLAN (DTS)	Hotspot	Front Face	0.84	0.05	0.89	ΣSAR < 1.6, Not required
			Rear Face	0.75	0.06	0.81	ΣSAR < 1.6, Not required
			Left Side	0.15	0.01	0.16	ΣSAR < 1.6, Not required
			Right Side	0.00	0.02	0.02	ΣSAR < 1.6, Not required
			Top Side	0.22	0.01	0.23	ΣSAR < 1.6, Not required
			Bottom Side	0.35	0.03	0.38	ΣSAR < 1.6, Not required
02	CDMA BC1 + WLAN (DTS)	Hotspot	Front Face	0.58	0.05	0.63	ΣSAR < 1.6, Not required
			Rear Face	1.09	0.06	1.15	ΣSAR < 1.6, Not required
			Left Side	1.49	0.01	1.50	ΣSAR < 1.6, Not required
			Right Side	0.00	0.02	0.02	ΣSAR < 1.6, Not required
			Top Side	0.03	0.01	0.04	ΣSAR < 1.6, Not required
			Bottom Side	0.39	0.03	0.42	ΣSAR < 1.6, Not required
03	LTE 2 + WLAN (DTS)	Hotspot	Front Face	0.63	0.05	0.68	ΣSAR < 1.6, Not required
			Rear Face	1.05	0.06	1.11	ΣSAR < 1.6, Not required
			Left Side	1.35	0.01	1.36	ΣSAR < 1.6, Not required
			Right Side	0.00	0.02	0.02	ΣSAR < 1.6, Not required
			Top Side	0.03	0.01	0.04	ΣSAR < 1.6, Not required
			Bottom Side	0.37	0.03	0.40	ΣSAR < 1.6, Not required
04	LTE 4 + WLAN (DTS)	Hotspot	Front Face	0.45	0.05	0.54	ΣSAR < 1.6, Not required
			Rear Face	0.70	0.06	0.76	ΣSAR < 1.6, Not required
			Left Side	0.36	0.01	0.37	ΣSAR < 1.6, Not required
			Right Side	0.00	0.02	0.02	ΣSAR < 1.6, Not required
			Top Side	0.20	0.01	0.21	ΣSAR < 1.6, Not required
			Bottom Side	0.31	0.03	0.34	ΣSAR < 1.6, Not required

FCC SAR Test Report

No.	Conditions (SAR1 + SAR2)	Exposure Condition	Test Position	Max. SAR1	Max. SAR2	SAR Summation	SPLSR Analysis
05	LTE 5 + WLAN (DTS)	Hotspot	Front Face	0.78	0.05	0.83	Σ SAR < 1.6, Not required
			Rear Face	0.68	0.06	0.74	Σ SAR < 1.6, Not required
			Left Side	0.19	0.01	0.20	Σ SAR < 1.6, Not required
			Right Side	0.00	0.02	0.02	Σ SAR < 1.6, Not required
			Top Side	0.23	0.01	0.24	Σ SAR < 1.6, Not required
			Bottom Side	0.31	0.03	0.34	Σ SAR < 1.6, Not required
05	LTE 12 + WLAN (DTS)	Hotspot	Front Face	0.96	0.05	1.01	Σ SAR < 1.6, Not required
			Rear Face	0.91	0.06	0.97	Σ SAR < 1.6, Not required
			Left Side	0.24	0.01	0.25	Σ SAR < 1.6, Not required
			Right Side	0.00	0.02	0.02	Σ SAR < 1.6, Not required
			Top Side	0.23	0.01	0.24	Σ SAR < 1.6, Not required
			Bottom Side	0.35	0.03	0.38	Σ SAR < 1.6, Not required
06	LTE 25 + WLAN (DTS)	Hotspot	Front Face	0.61	0.05	0.66	Σ SAR < 1.6, Not required
			Rear Face	0.95	0.06	1.01	Σ SAR < 1.6, Not required
			Left Side	1.31	0.01	1.32	Σ SAR < 1.6, Not required
			Right Side	0.00	0.02	0.02	Σ SAR < 1.6, Not required
			Top Side	0.03	0.01	0.04	Σ SAR < 1.6, Not required
			Bottom Side	0.38	0.03	0.41	Σ SAR < 1.6, Not required

Test Engineer : Eddie Yang

5. Calibration of Test Equipment

Equipment	Manufacturer	Model	SN	Cal. Date	Cal. Interval
SAR Chamber	Willtec	N/A	N/A	N/A	N/A
Thermo-Hygrostat	Airtec	SM-3303T (SKS-AUD-05)	11341	N/A	N/A
DASY5 Robot	SPEAG	RX90	F13/5RR2B1/A/01	N/A	N/A
DASY5 Server	SPEAG	Server	1393	N/A	N/A
SAM Twin Phantom	SPEAG	QD000P40CD	TP-1789	N/A	N/A
SAM Twin Phantom	SPEAG	QD000P40CD	TP-1787	N/A	N/A
Mounting Device for Hand-Held Transmitters	SPEAG	SD 000 H01 KA	N/A	N/A	N/A
System Validation Dipole	SPEAG	D750V3	1096	Sep. 21, 2017	1 Year
System Validation Dipole	SPEAG	D835V2	4d021	Aug. 24, 2017	1 Year
System Validation Dipole	SPEAG	D1750V2	1102	Sep. 20, 2017	1 Year
System Validation Dipole	SPEAG	D1900V2	5d022	Aug. 21, 2017	1 Year
System Validation Dipole	SPEAG	D2450V2	716	Aug. 17, 2017	1 Year
Dosimetric E-Field Probe	SPEAG	EX3DV4	7419	Aug. 22, 2017	1 Year
Data Acquisition Electronics	SPEAG	DAE4	1397	Aug. 17, 2017	1 Year
Wireless Communication Test Set	Agilent	E5515C	MY53201107	Jul. 27, 2017	1 Year
Radio Communication Analyzer	Anritsu	MT8820C	6201300614	Jun. 28, 2017	1 Year
MXG Analog Signal Generator	Agilent	N5181B	MY51350099	Jun. 27, 2017	1 Year
Power Amplifier	R & K	A801M422-3737R	B40120	Jun. 28, 2017	1 Year
Power Amplifier	EXODUS ADVANCED COMMUNICATIONS	AMP2027	10005	Oct. 31, 2017	1 Year
Power Meter	Anritsu	ML2496A	1430004	Aug. 16, 2017	1 Year
Power Meter	Anritsu	ML2495A	1337003	Jul. 27, 2017	1 Year
Power Sensor	Anritsu	MA2411B	1339168	Aug. 14, 2017	1 Year
Power Sensor	Anritsu	MA2411B	1339169	Aug. 14, 2017	1 Year
Power Sensor	Anritsu	MA2411B	1306054	Jul. 27, 2017	1 Year
Dual Direction Coupler	Keysight	772D	MY52180195	Jul. 27, 2017	1 Year
Low Pass Filter(1.5 GHz)	MICROLAB	LA-15N	03943	Jun. 28, 2017	1 Year
Low Pass Filter(3 GHz)	DYMSTEC(FILTRON)	L14012FL	1410004S	Jun. 28, 2017	1 Year
Attenuator(3 dB)	WOKEN	WATT-518FS-03	WATT-518FS-03-1	Jun. 28, 2017	1 Year
Attenuator(10 dB)	Weinshel	3M-10	25699	Jun. 28, 2017	1 Year
ENA Network Analyzer	Agilent	E5071C	MY46212858	Oct. 18, 2017	1 Year
Dielectric Assessment Kit	SPEAG	DAK3.5	1133	Jan. 24, 2017	1 Year

6. Measurement Uncertainty

Error Description	Uncertainty Value (±%)	Probability Distribution	Divisor	Ci (1g)	Standard Uncertainty (±%, 1g)	Vi
Measurement System						
Probe Calibration	6.0	Normal	1	1	6.0	∞
Axial Isotropy	4.7	Rectangular	√3	0.71	2.0	∞
Hemispherical Isotropy	9.6	Rectangular	√3	0.71	4.0	∞
Boundary Effects	1.0	Rectangular	√3	1	0.6	∞
Linearity	4.7	Rectangular	√3	1	2.8	∞
System Detection Limits	0.25	Rectangular	√3	1	0.2	∞
Readout Electronics	0.3	Normal	1	1	0.3	∞
Response Time	0.0	Rectangular	√3	1	0.0	∞
Integration Time	2.6	Rectangular	√3	1	1.6	∞
RF Ambient Noise	3.0	Rectangular	√3	1	1.8	∞
RF Ambient Reflections	3.0	Rectangular	√3	1	1.8	∞
Probe Positioner	0.4	Rectangular	√3	1	0.3	∞
Probe Positioning	2.9	Rectangular	√3	1	1.7	∞
Max. SAR Eval.	2.0	Rectangular	√3	1	1.2	∞
Test Sample Related						
Device Positioning	2.1 / 1.2	Normal	1	1	2.1	76
Device Holder	3.2 / 2.2	Normal	1	1	3.2	43
Power Drift	5.0	Rectangular	√3	1	2.9	∞
Phantom and Setup						
Phantom Uncertainty	7.5	Rectangular	√3	1	4.4	∞
Liquid Conductivity (Target)	5.0	Rectangular	√3	0.64	1.9	∞
Liquid Conductivity (Meas.)	2.25	Normal	1	0.64	1.5	25
Liquid Permittivity (Target)	5.0	Rectangular	√3	0.6	1.8	∞
Liquid Permittivity (Meas.)	2.04	Normal	1	0.6	1.3	25
Combined Standard Uncertainty					± 11.5 %	
Expanded Uncertainty (K=2)					± 23.0 %	

Uncertainty budget for frequency range 300 MHz to 3 GHz

7. Information on the Testing Laboratories

We, Bureau Veritas Consumer Products Services ADT Korea Ltd. Mobile Communications Laboratory were founded in 1988 to provide our best service in EMC, Radio, Telecom and Safety consultation. Our laboratories are accredited and approved according to ISO/IEC 17025.

If you have any comments, please feel free to contact us at the following:

Address: 306 Shinwon-ro, Yeontong-gu, Suwon-si, Gyeonggi-do, Korea (Woncheon-dong, Yeongtong Innoplex – 1st Complex, No. 2B303, No. 2B304)

Designation No. : KR0158

Tel: 82-31-8002-3060

Fax: 82-31-8002-3061

Email: service.adt@tw.bureauveritas.com

Web Site: www.bureauveritas.co.kr

The road map of all our labs can be found in our web site also.

---END---

Appendix A. SAR Plots of System Verification

The plots for system verification with largest deviation for each SAR system combination are shown as follows.

System Check_B835_171130

DUT: Dipole 835 MHz; Type: D835V2; SN: 4d021

Communication System: CW; Frequency: 835 MHz; Duty Cycle: 1:1
Medium: B835_171130 Medium parameters used: $f = 835$ MHz; $\sigma = 0.988$ S/m; $\epsilon_r = 55.922$; $\rho = 1000$ kg/m³
Ambient Temperature : 22.0 °C; Liquid Temperature : 21.6 °C

DASY5 Configuration:

- Probe: EX3DV4 - SN7419; ConvF(9.66, 9.66, 9.66); Calibrated: 2017/08/22;
- Sensor-Surface: 1.4mm (Mechanical Surface Detection)
- Electronics: DAE4 Sn1397; Calibrated: 2017/08/17
- Phantom: SAM with CRP v5.0 Back; Type: QD000P40CD; Serial: TP:1789
- Measurement SW: DASY52, Version 52.8 (8); SEMCAD X Version 14.6.10 (7331)

Pin=250mW/Area Scan (41x121x1): Interpolated grid: dx=1.500 mm, dy=1.500 mm
Maximum value of SAR (interpolated) = 3.30 W/kg

Pin=250mW/Zoom Scan (5x5x7)/Cube 0: Measurement grid: dx=8mm, dy=8mm, dz=5mm
Reference Value = 57.27 V/m; Power Drift = 0.03 dB
Peak SAR (extrapolated) = 3.75 W/kg
SAR(1 g) = 2.52 W/kg; SAR(10 g) = 1.66 W/kg
Maximum value of SAR (measured) = 3.35 W/kg

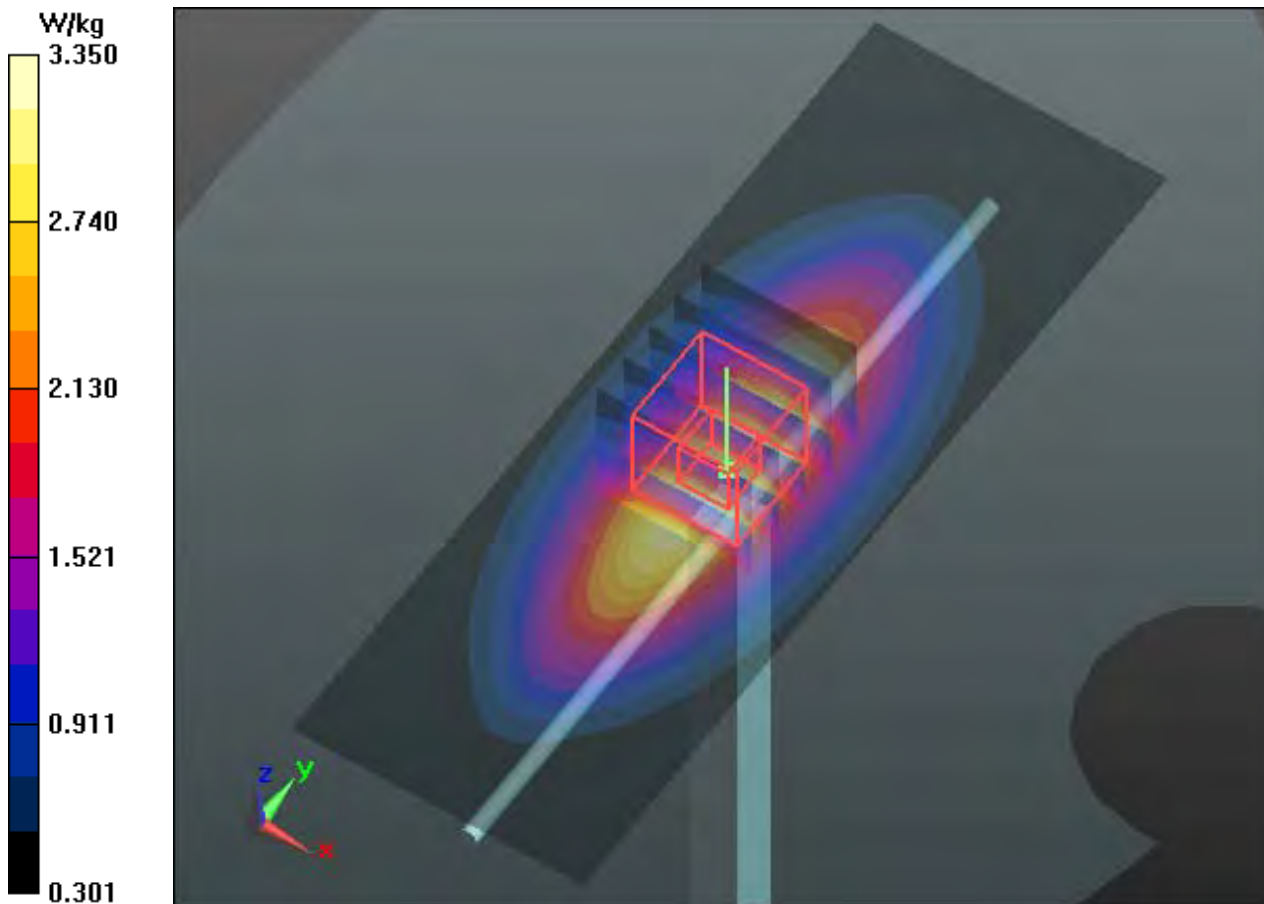

System Check_B1750_1701202

DUT: Dipole 1750 MHz; Type: D1750V2; SN: 1102

Communication System: CW; Frequency: 1750 MHz; Duty Cycle: 1:1

Medium: B1750_171202 Medium parameters used: $f = 1750$ MHz; $\sigma = 1.439$ S/m; $\epsilon_r = 54.005$; $\rho = 1000$ kg/m³

Ambient Temperature : 22.1 °C; Liquid Temperature : 21.4 °C

DASY5 Configuration:

- Probe: EX3DV4 - SN7419; ConvF(8.1, 8.1, 8.1); Calibrated: 2017/08/22;
- Sensor-Surface: 1.4mm (Mechanical Surface Detection)
- Electronics: DAE4 Sn1397; Calibrated: 2017/08/17
- Phantom: SAM with CRP v5.0 Front; Type: QD000P40CD; Serial: TP:1787
- Measurement SW: DASY52, Version 52.8 (8); SEMCAD X Version 14.6.10 (7331)

Pin=250mW/Area Scan (61x61x1): Interpolated grid: dx=1.500 mm, dy=1.500 mm

Maximum value of SAR (interpolated) = 14.0 W/kg

Pin=250mW/Zoom Scan (5x5x7)/Cube 0: Measurement grid: dx=8mm, dy=8mm, dz=5mm

Reference Value = 102.4 V/m; Power Drift = 0.01 dB

Peak SAR (extrapolated) = 16.6 W/kg

SAR(1 g) = 9.29 W/kg; SAR(10 g) = 4.93 W/kg

Maximum value of SAR (measured) = 14.1 W/kg

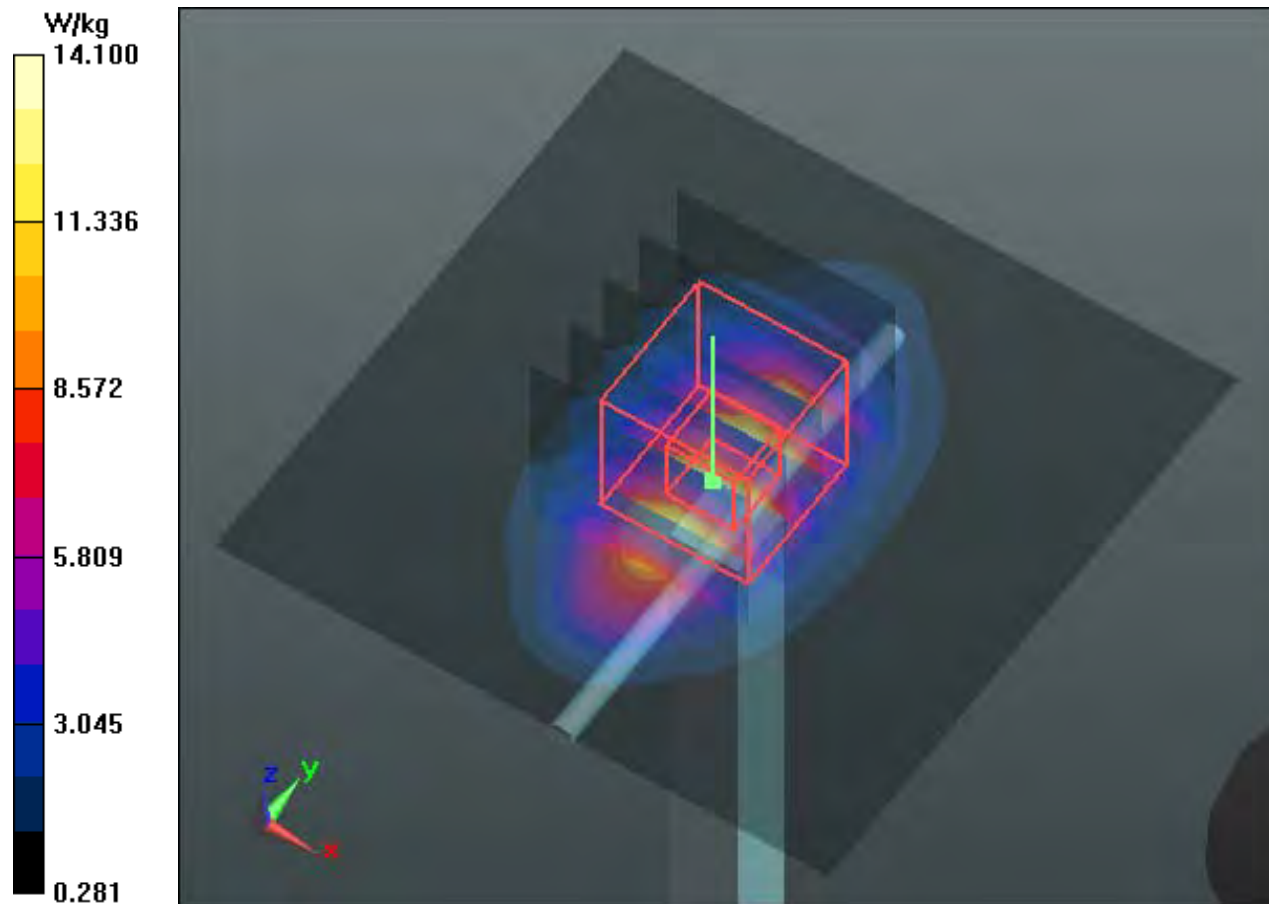

System Check_B1900_171031

DUT: Dipole 1900 MHz; Type: D1900V2; SN: 5d022

Communication System: CW; Frequency: 1900 MHz; Duty Cycle: 1:1

Medium: B1900_171031 Medium parameters used: $f = 1900$ MHz; $\sigma = 1.553$ S/m; $\epsilon_r = 53.104$; $\rho = 1000$ kg/m³

Ambient Temperature : 22.5 °C; Liquid Temperature : 22.1 °C

DASY5 Configuration:

- Probe: EX3DV4 - SN7419; ConvF(7.79, 7.79, 7.79); Calibrated: 2017/08/22;
- Sensor-Surface: 1.4mm (Mechanical Surface Detection)
- Electronics: DAE4 Sn1397; Calibrated: 2017/08/17
- Phantom: SAM with CRP v5.0 Front; Type: QD000P40CD; Serial: TP:1787
- Measurement SW: DASY52, Version 52.8 (8); SEMCAD X Version 14.6.10 (7331)

Pin=250mW/Area Scan (61x61x1): Interpolated grid: dx=1.500 mm, dy=1.500 mm

Maximum value of SAR (interpolated) = 15.5 W/kg

Pin=250mW/Zoom Scan (5x5x7)/Cube 0: Measurement grid: dx=8mm, dy=8mm, dz=5mm

Reference Value = 104.7 V/m; Power Drift = 0.04 dB

Peak SAR (extrapolated) = 18.6 W/kg

SAR(1 g) = 10.3 W/kg; SAR(10 g) = 5.39 W/kg

Maximum value of SAR (measured) = 15.9 W/kg

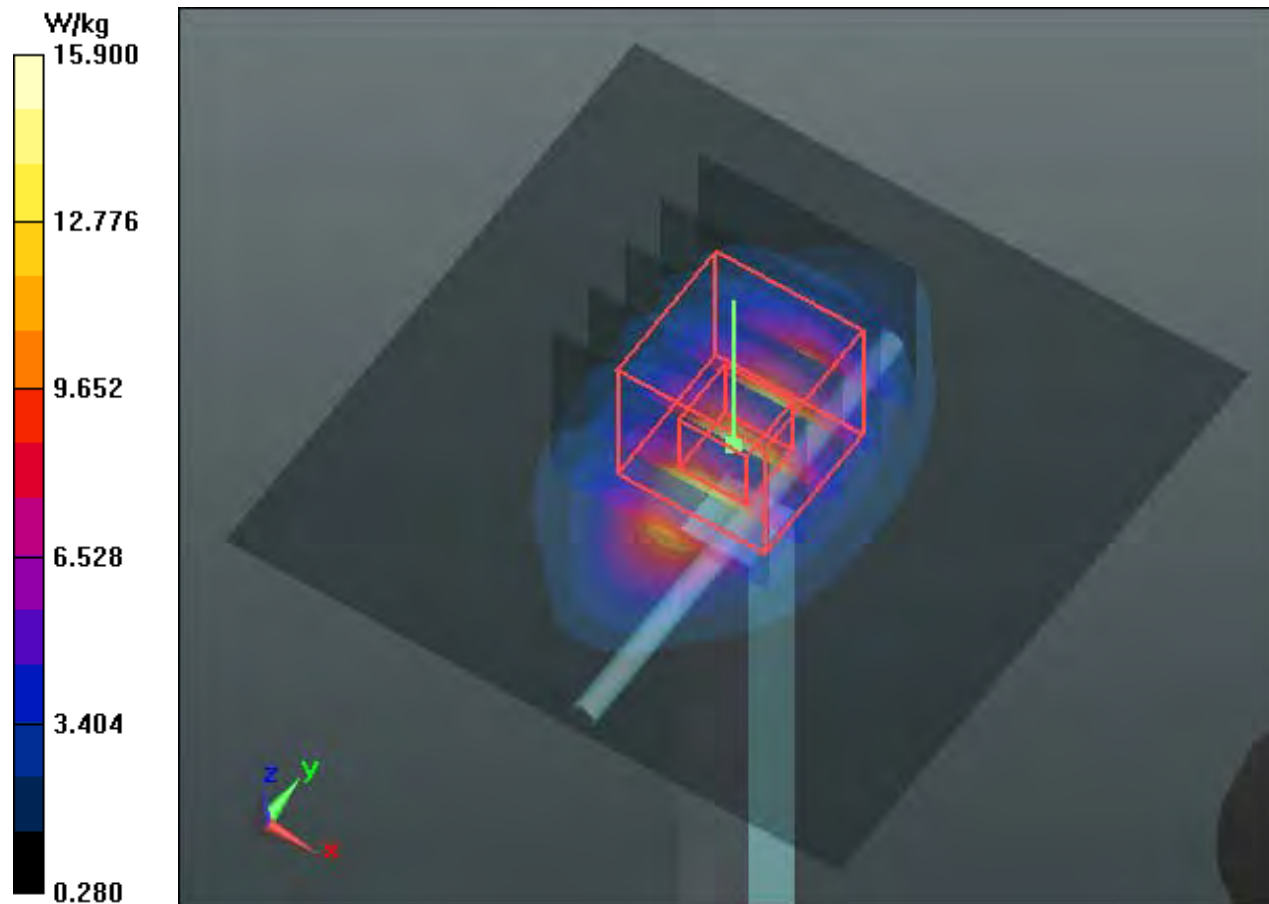

System Check_B1900_171201

DUT: Dipole 1900 MHz; Type: D1900V2; SN: 5d022

Communication System: CW; Frequency: 1900 MHz; Duty Cycle: 1:1

Medium: B1900_171201 Medium parameters used: $f = 1900$ MHz; $\sigma = 1.55$ S/m; $\epsilon_r = 53.404$; $\rho = 1000$ kg/m³

Ambient Temperature : 22.0 °C; Liquid Temperature : 21.5 °C

DASY5 Configuration:

- Probe: EX3DV4 - SN7419; ConvF(7.79, 7.79, 7.79); Calibrated: 2017/08/22;
- Sensor-Surface: 1.4mm (Mechanical Surface Detection)
- Electronics: DAE4 Sn1397; Calibrated: 2017/08/17
- Phantom: SAM with CRP v5.0 Front; Type: QD000P40CD; Serial: TP:1787
- Measurement SW: DASY52, Version 52.8 (8); SEMCAD X Version 14.6.10 (7331)

Pin=250mW/Area Scan (61x61x1): Interpolated grid: dx=1.500 mm, dy=1.500 mm
Maximum value of SAR (interpolated) = 15.3 W/kg

Pin=250mW/Zoom Scan (5x5x7)/Cube 0: Measurement grid: dx=8mm, dy=8mm, dz=5mm
Reference Value = 100.5 V/m; Power Drift = 0.14 dB
Peak SAR (extrapolated) = 18.4 W/kg
SAR(1 g) = 10.2 W/kg; SAR(10 g) = 5.31 W/kg
Maximum value of SAR (measured) = 15.7 W/kg

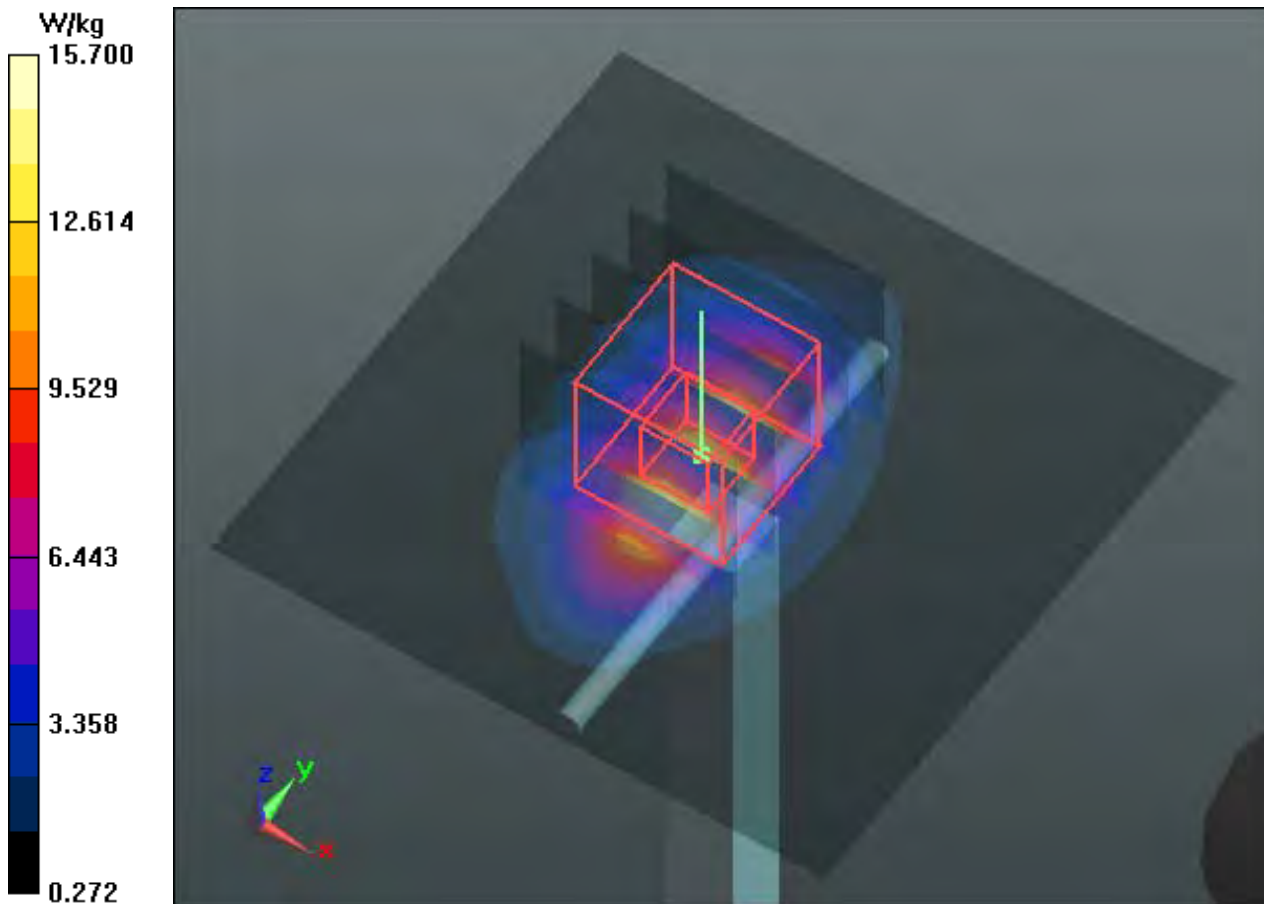

System Check_B2450_171028

DUT: Dipole 2450 MHz; Type: D2450V2; SN: 716

Communication System: CW; Frequency: 2450 MHz; Duty Cycle: 1:1

Medium: B2450_171028 Medium parameters used: $f = 2450$ MHz; $\sigma = 2.005$ S/m; $\epsilon_r = 51.692$; $\rho = 1000$ kg/m³

Ambient Temperature : 22.6 °C; Liquid Temperature : 22.0 °C

DASY5 Configuration:

- Probe: EX3DV4 - SN7419; ConvF(7.54, 7.54, 7.54); Calibrated: 2017/08/22;
- Sensor-Surface: 1.4mm (Mechanical Surface Detection)
- Electronics: DAE4 Sn1397; Calibrated: 2017/08/17
- Phantom: SAM with CRP v5.0 Front; Type: QD000P40CD; Serial: TP:1787
- Measurement SW: DASY52, Version 52.8 (8); SEMCAD X Version 14.6.10 (7331)

Pin=250mW/Area Scan (81x81x1): Interpolated grid: dx=1.200 mm, dy=1.200 mm

Maximum value of SAR (interpolated) = 19.9 W/kg

Pin=250mW/Zoom Scan (7x7x7)/Cube 0: Measurement grid: dx=5mm, dy=5mm, dz=5mm

Reference Value = 100.8 V/m; Power Drift = 0.06 dB

Peak SAR (extrapolated) = 26.7 W/kg

SAR(1 g) = 13.2 W/kg; SAR(10 g) = 6.14 W/kg

Maximum value of SAR (measured) = 20.1 W/kg

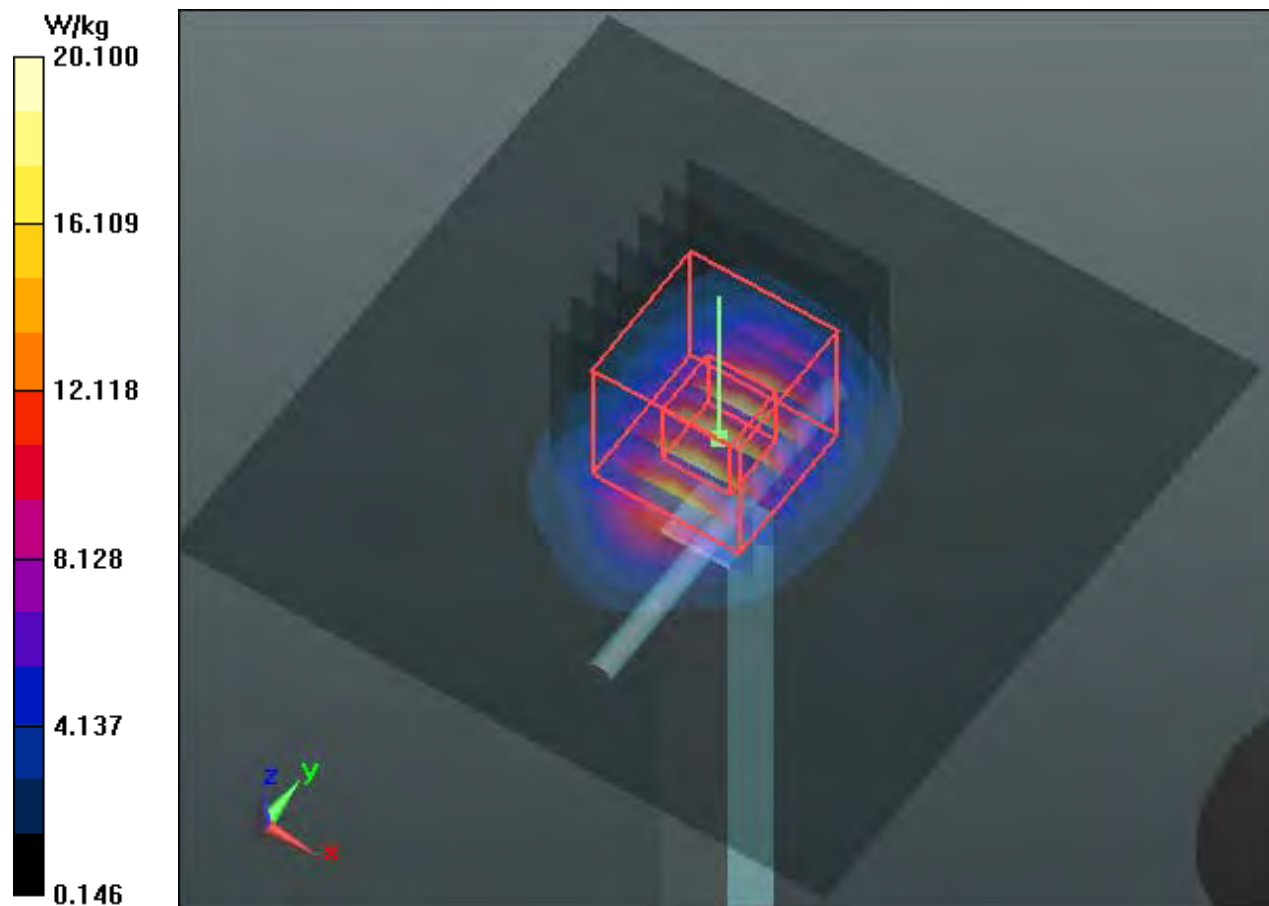

System Check_H750_171130

DUT: Dipole 750 MHz; Type: D750V3; SN: 1096

Communication System: CW; Frequency: 750 MHz; Duty Cycle: 1:1

Medium: B750_171130 Medium parameters used: $f = 750$ MHz; $\sigma = 0.964$ S/m; $\epsilon_r = 56.476$; $\rho = 1000$ kg/m³

Ambient Temperature : 22.0 °C; Liquid Temperature : 21.6 °C

DASY5 Configuration:

- Probe: EX3DV4 - SN7419; ConvF(9.91, 9.91, 9.91); Calibrated: 2017/08/22;
- Sensor-Surface: 1.4mm (Mechanical Surface Detection)
- Electronics: DAE4 Sn1397; Calibrated: 2017/08/17
- Phantom: SAM with CRP v5.0 Back; Type: QD000P40CD; Serial: TP:1789
- Measurement SW: DASY52, Version 52.8 (8); SEMCAD X Version 14.6.10 (7331)

Pin=250mW/Area Scan (41x121x1): Interpolated grid: dx=1.500 mm, dy=1.500 mm

Maximum value of SAR (interpolated) = 2.70 W/kg

Pin=250mW/Zoom Scan (5x5x7)/Cube 0: Measurement grid: dx=8mm, dy=8mm, dz=5mm

Reference Value = 55.77 V/m; Power Drift = 0.09 dB

Peak SAR (extrapolated) = 3.03 W/kg

SAR(1 g) = 2.06 W/kg; SAR(10 g) = 1.39 W/kg

Maximum value of SAR (measured) = 2.72 W/kg

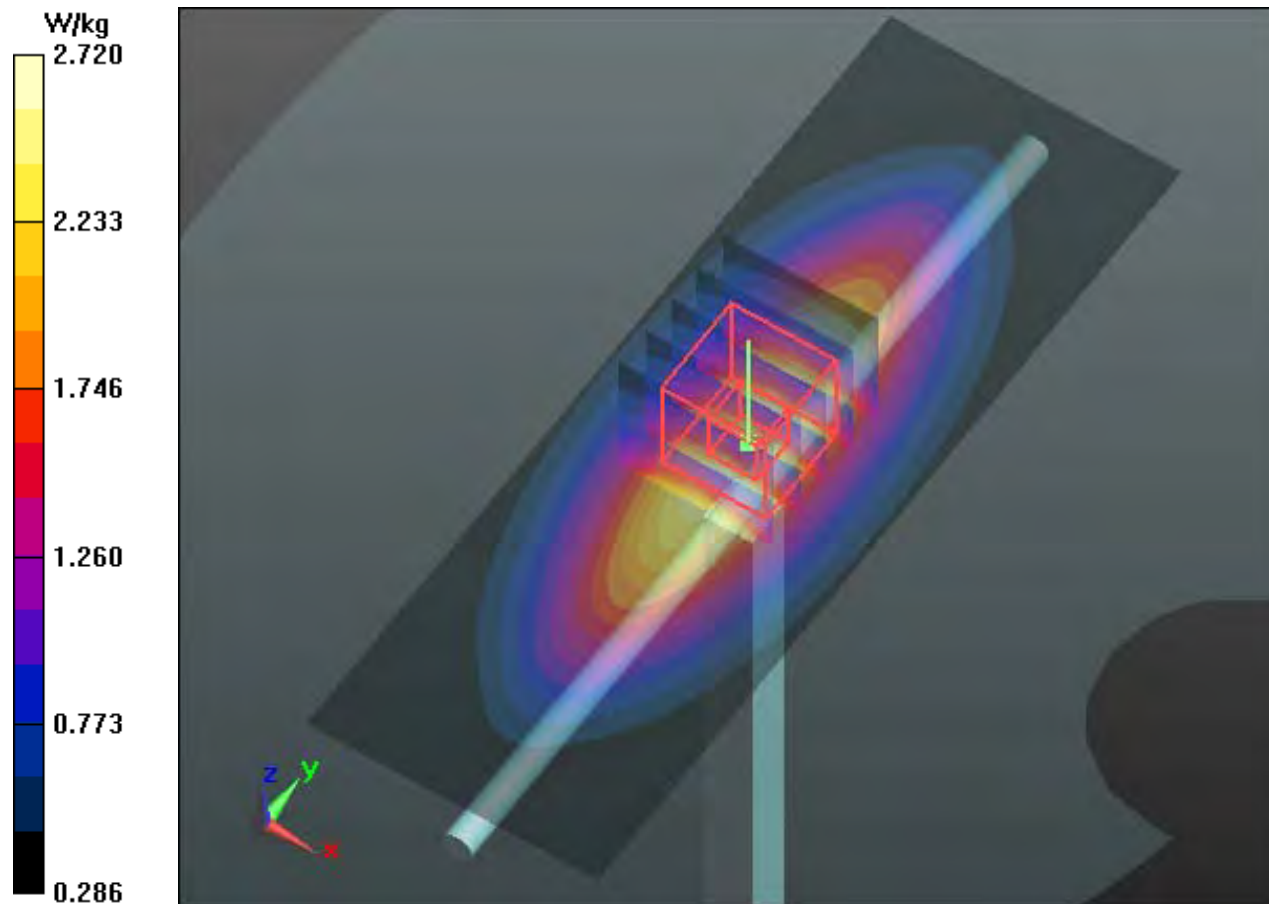

Appendix B. SAR Plots of SAR Measurement

The SAR plots for highest measured SAR in each exposure configuration, wireless mode and frequency band combination, and measured SAR > 1.5 W/kg are shown as follows.

P01 CDMA BC0_RTAP 153.6_Front Face_1cm_Ch1013

DUT: 171023K006

Communication System: CDMA2000; Frequency: 824.7 MHz; Duty Cycle: 1:1
Medium: B835_171130 Medium parameters used: $f = 825$ MHz; $\sigma = 0.981$ S/m; $\epsilon_r = 56.136$; $\rho = 1000$ kg/m³
Ambient Temperature : 22.0 °C; Liquid Temperature : 21.6 °C

DASY5 Configuration:

- Probe: EX3DV4 - SN7419; ConvF(9.66, 9.66, 9.66); Calibrated: 2017/08/22;
- Sensor-Surface: 1.4mm (Mechanical Surface Detection)
- Electronics: DAE4 Sn1397; Calibrated: 2017/08/17
- Phantom: SAM with CRP v5.0 Back; Type: QD000P40CD; Serial: TP:1789
- Measurement SW: DASY52, Version 52.8 (8); SEMCAD X Version 14.6.10 (7331)

- **Area Scan (61x81x1):** Interpolated grid: dx=1.500 mm, dy=1.500 mm
Maximum value of SAR (interpolated) = 1.04 W/kg

- **Zoom Scan (5x5x7)/Cube 0:** Measurement grid: dx=8mm, dy=8mm, dz=5mm
Reference Value = 23.61 V/m; Power Drift = -0.02 dB
Peak SAR (extrapolated) = 1.20 W/kg
SAR(1 g) = 0.773 W/kg; SAR(10 g) = 0.509 W/kg
Maximum value of SAR (measured) = 1.04 W/kg

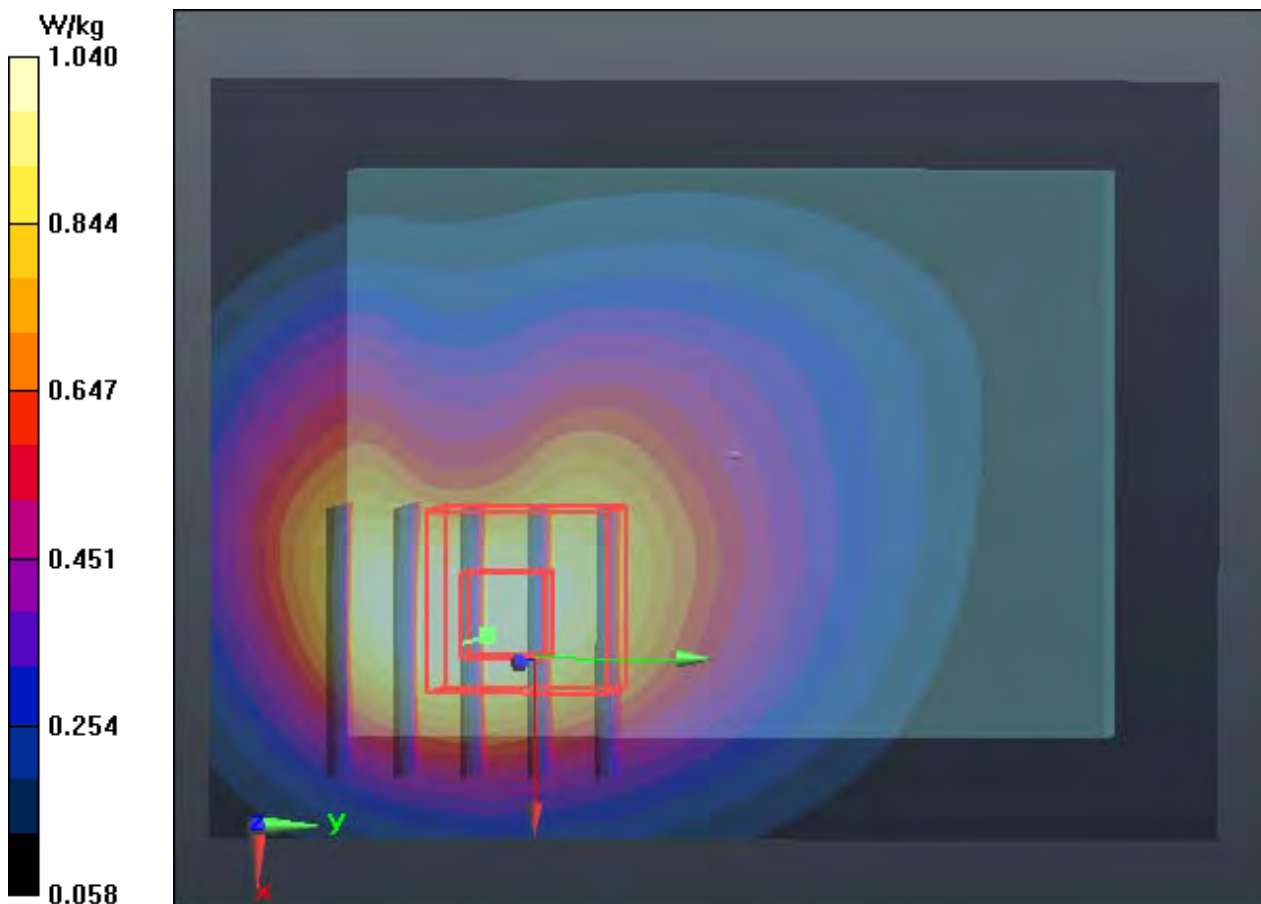

P02 CDMA BC1_RTAP 153.6_Left Side_1cm_Ch600

DUT: 171023K006

Communication System: CDMA2000; Frequency: 1880 MHz; Duty Cycle: 1:1
Medium: B1900_171031 Medium parameters used: $f = 1880$ MHz; $\sigma = 1.534$ S/m; $\epsilon_r = 53.186$; $\rho = 1000$ kg/m³
Ambient Temperature : 22.5 °C; Liquid Temperature : 22.1 °C

DASY5 Configuration:

- Probe: EX3DV4 - SN7419; ConvF(7.79, 7.79, 7.79); Calibrated: 2017/08/22;
- Sensor-Surface: 1.4mm (Mechanical Surface Detection)
- Electronics: DAE4 Sn1397; Calibrated: 2017/08/17
- Phantom: SAM with CRP v5.0 Front; Type: QD000P40CD; Serial: TP:1787
- Measurement SW: DASY52, Version 52.8 (8); SEMCAD X Version 14.6.10 (7331)

- **Area Scan (41x51x1):** Interpolated grid: $dx=1.500$ mm, $dy=1.500$ mm
Maximum value of SAR (interpolated) = 2.05 W/kg

- **Zoom Scan (5x5x7)/Cube 0:** Measurement grid: $dx=8$ mm, $dy=8$ mm, $dz=5$ mm
Reference Value = 31.80 V/m; Power Drift = 0.07 dB
Peak SAR (extrapolated) = 2.32 W/kg
SAR(1 g) = 1.31 W/kg; SAR(10 g) = 0.663 W/kg
Maximum value of SAR (measured) = 1.97 W/kg

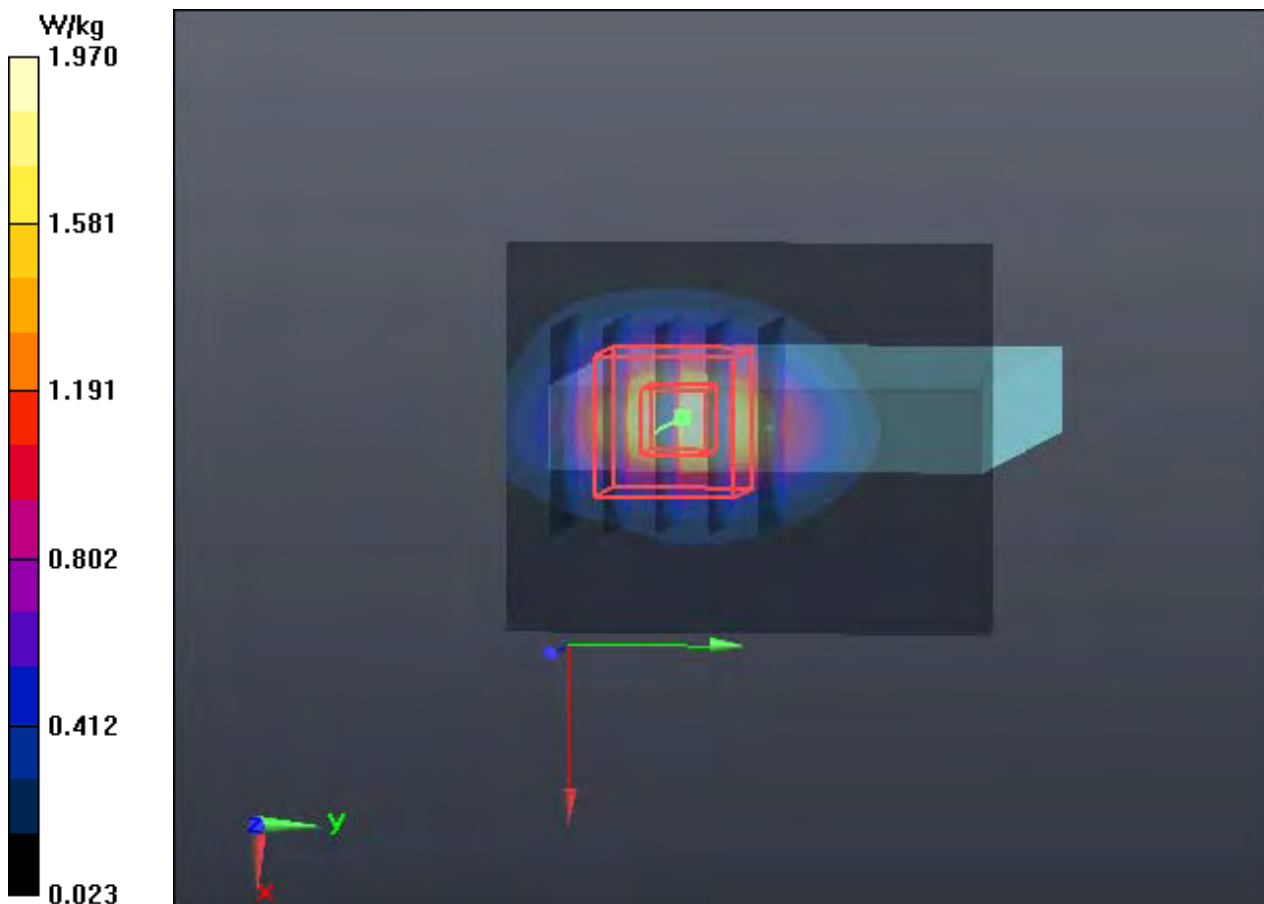

P03 LTE 2_QPSK20M_Left Side_1cm_Ch18700_1 RB_OS 50

DUT: 171023K006

Communication System: LTE; Frequency: 1860 MHz; Duty Cycle: 1:1
Medium: B1900_171201 Medium parameters used: $f = 1860$ MHz; $\sigma = 1.509$ S/m; $\epsilon_r = 53.492$; $\rho = 1000$ kg/m³
Ambient Temperature : 22.0 °C; Liquid Temperature : 21.5 °C

DASY5 Configuration:

- Probe: EX3DV4 - SN7419; ConvF(7.79, 7.79, 7.79); Calibrated: 2017/08/22;
- Sensor-Surface: 1.4mm (Mechanical Surface Detection)
- Electronics: DAE4 Sn1397; Calibrated: 2017/08/17
- Phantom: SAM with CRP v5.0 Front; Type: QD000P40CD; Serial: TP:1787
- Measurement SW: DASY52, Version 52.8 (8); SEMCAD X Version 14.6.10 (7331)

- **Area Scan (41x51x1):** Interpolated grid: dx=1.500 mm, dy=1.500 mm
Maximum value of SAR (interpolated) = 1.84 W/kg

- **Zoom Scan (5x5x7)/Cube 0:** Measurement grid: dx=8mm, dy=8mm, dz=5mm
Reference Value = 32.57 V/m; Power Drift = 0.09 dB
Peak SAR (extrapolated) = 2.14 W/kg
SAR(1 g) = 1.21 W/kg; SAR(10 g) = 0.622 W/kg
Maximum value of SAR (measured) = 1.79 W/kg

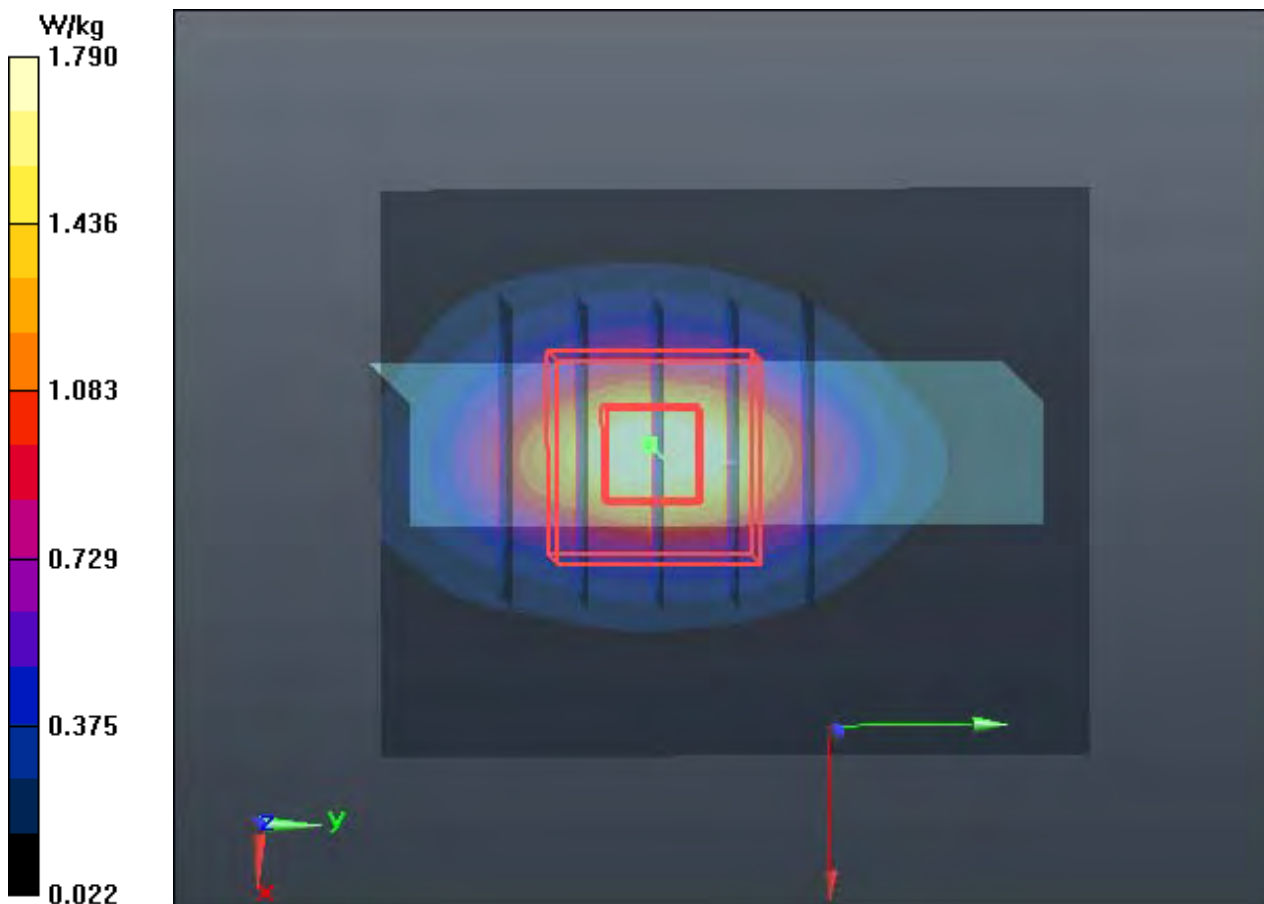

P04 LTE 4_QPSK20M_Rear Face_1cm_Ch20300_1 RB_OS 50

DUT: 171023K006

Communication System: LTE; Frequency: 1745 MHz; Duty Cycle: 1:1

Medium: B1750_171202 Medium parameters used: $f = 1745$ MHz; $\sigma = 1.435$ S/m; $\epsilon_r = 54.019$; $\rho = 1000$ kg/m³

Ambient Temperature : 22.1 °C; Liquid Temperature : 21.4 °C

DASY5 Configuration:

- Probe: EX3DV4 - SN7419; ConvF(8.1, 8.1, 8.1); Calibrated: 2017/08/22;
- Sensor-Surface: 1.4mm (Mechanical Surface Detection)
- Electronics: DAE4 Sn1397; Calibrated: 2017/08/17
- Phantom: SAM with CRP v5.0 Front; Type: QD000P40CD; Serial: TP:1787
- Measurement SW: DASY52, Version 52.8 (8); SEMCAD X Version 14.6.10 (7331)

- **Area Scan (71x101x1):** Interpolated grid: dx=1.500 mm, dy=1.500 mm

Maximum value of SAR (interpolated) = 0.880 W/kg

- **Zoom Scan (5x5x7)/Cube 0:** Measurement grid: dx=8mm, dy=8mm, dz=5mm

Reference Value = 14.62 V/m; Power Drift = -0.14 dB

Peak SAR (extrapolated) = 1.14 W/kg

SAR(1 g) = 0.678 W/kg; SAR(10 g) = 0.386 W/kg

Maximum value of SAR (measured) = 0.938 W/kg

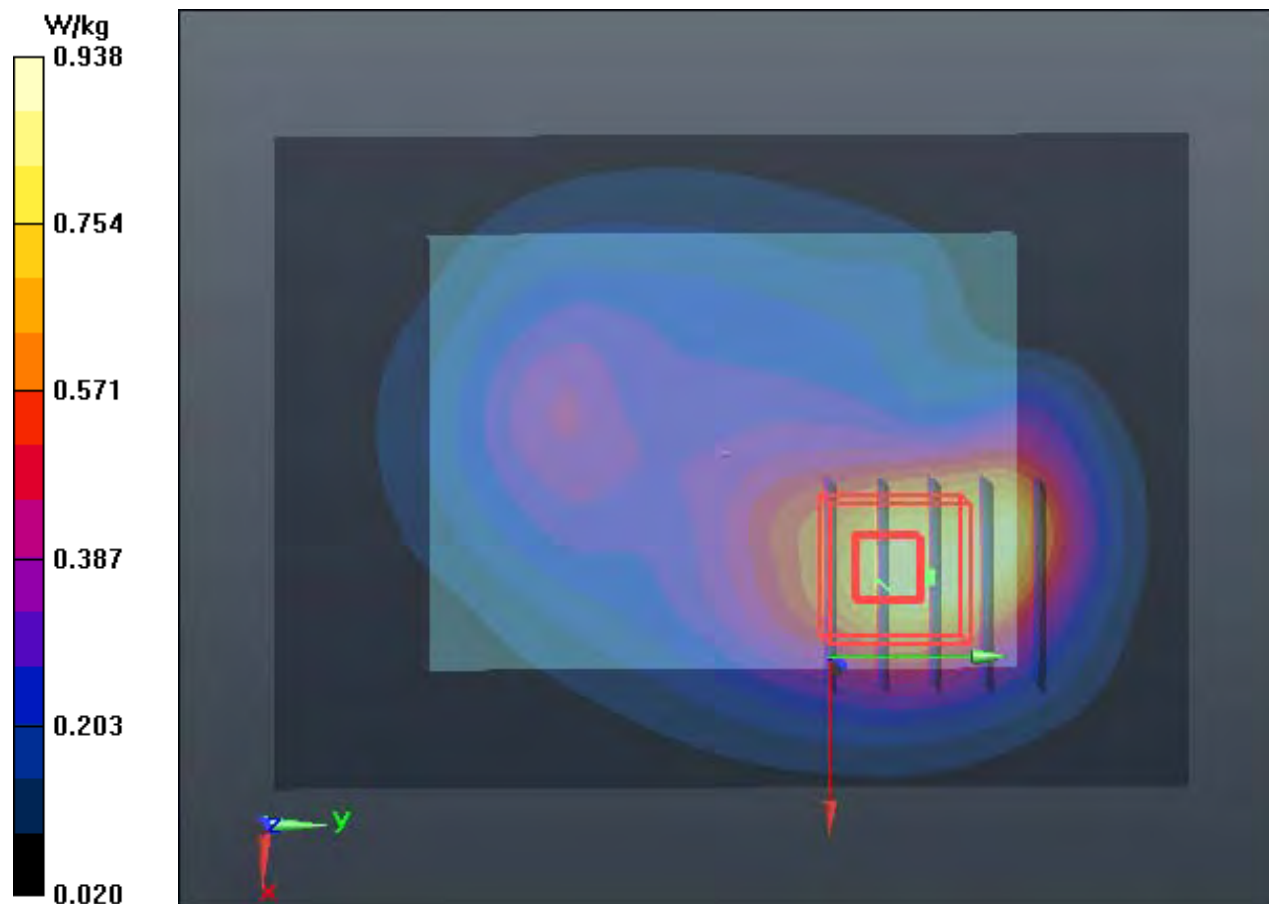

P05 LTE 5_QPSK10M_Front Face_1cm_Ch20600_1 RB_OS 24

DUT: 171023K006

Communication System: LTE; Frequency: 844 MHz; Duty Cycle: 1:1
Medium: B835_171130 Medium parameters used: $f = 844$ MHz; $\sigma = 1.003$ S/m; $\epsilon_r = 55.774$; $\rho = 1000$ kg/m³
Ambient Temperature : 22.0 °C; Liquid Temperature : 21.6 °C

DASY5 Configuration:

- Probe: EX3DV4 - SN7419; ConvF(9.66, 9.66, 9.66); Calibrated: 2017/08/22;
- Sensor-Surface: 1.4mm (Mechanical Surface Detection)
- Electronics: DAE4 Sn1397; Calibrated: 2017/08/17
- Phantom: SAM with CRP v5.0 Back; Type: QD000P40CD; Serial: TP:1789
- Measurement SW: DASY52, Version 52.8 (8); SEMCAD X Version 14.6.10 (7331)

- **Area Scan (61x81x1):** Interpolated grid: dx=1.500 mm, dy=1.500 mm
Maximum value of SAR (interpolated) = 1.00 W/kg

- **Zoom Scan (5x5x7)/Cube 0:** Measurement grid: dx=8mm, dy=8mm, dz=5mm
Reference Value = 24.26 V/m; Power Drift = -0.05 dB
Peak SAR (extrapolated) = 1.19 W/kg
SAR(1 g) = 0.756 W/kg; SAR(10 g) = 0.493 W/kg
Maximum value of SAR (measured) = 1.02 W/kg

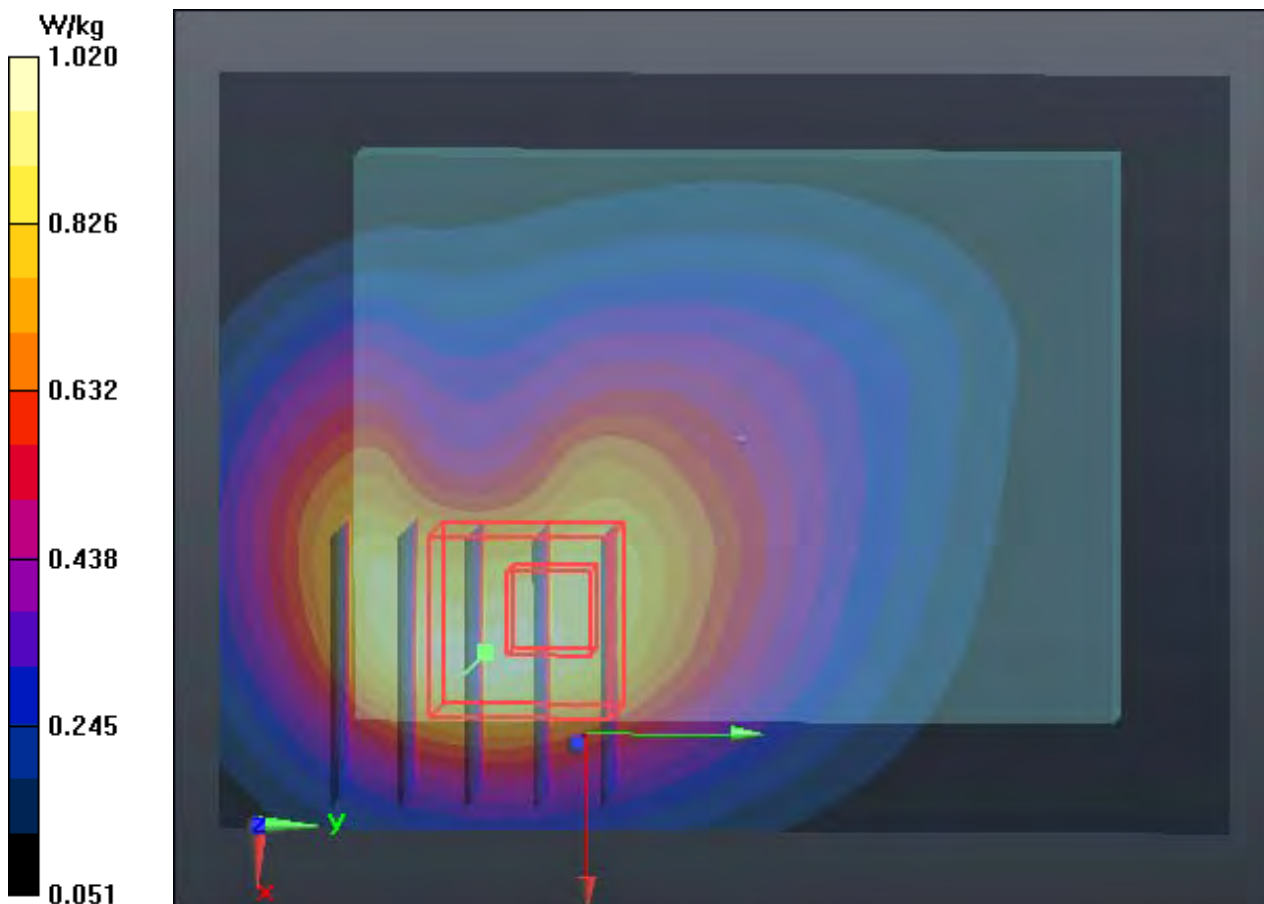

P06 LTE 12_QPSK10M_Front Face_1cm_Ch23060_1 RB_OS 24

DUT: 171023K006

Communication System: LTE; Frequency: 704 MHz; Duty Cycle: 1:1
Medium: B750_171130 Medium parameters used: $f = 704$ MHz; $\sigma = 0.925$ S/m; $\epsilon_r = 56.865$; $\rho = 1000$ kg/m³
Ambient Temperature : 22.0 °C; Liquid Temperature : 21.6 °C

DASY5 Configuration:

- Probe: EX3DV4 - SN7419; ConvF(9.91, 9.91, 9.91); Calibrated: 2017/08/22;
- Sensor-Surface: 1.4mm (Mechanical Surface Detection)
- Electronics: DAE4 Sn1397; Calibrated: 2017/08/17
- Phantom: SAM with CRP v5.0 Back; Type: QD000P40CD; Serial: TP:1789
- Measurement SW: DASY52, Version 52.8 (8); SEMCAD X Version 14.6.10 (7331)

- **Area Scan (61x81x1):** Interpolated grid: dx=1.500 mm, dy=1.500 mm
Maximum value of SAR (interpolated) = 1.19 W/kg

- **Zoom Scan (5x5x7)/Cube 0:** Measurement grid: dx=8mm, dy=8mm, dz=5mm
Reference Value = 28.11 V/m; Power Drift = 0.02 dB
Peak SAR (extrapolated) = 1.41 W/kg
SAR(1 g) = 0.926 W/kg; SAR(10 g) = 0.619 W/kg
Maximum value of SAR (measured) = 1.22 W/kg

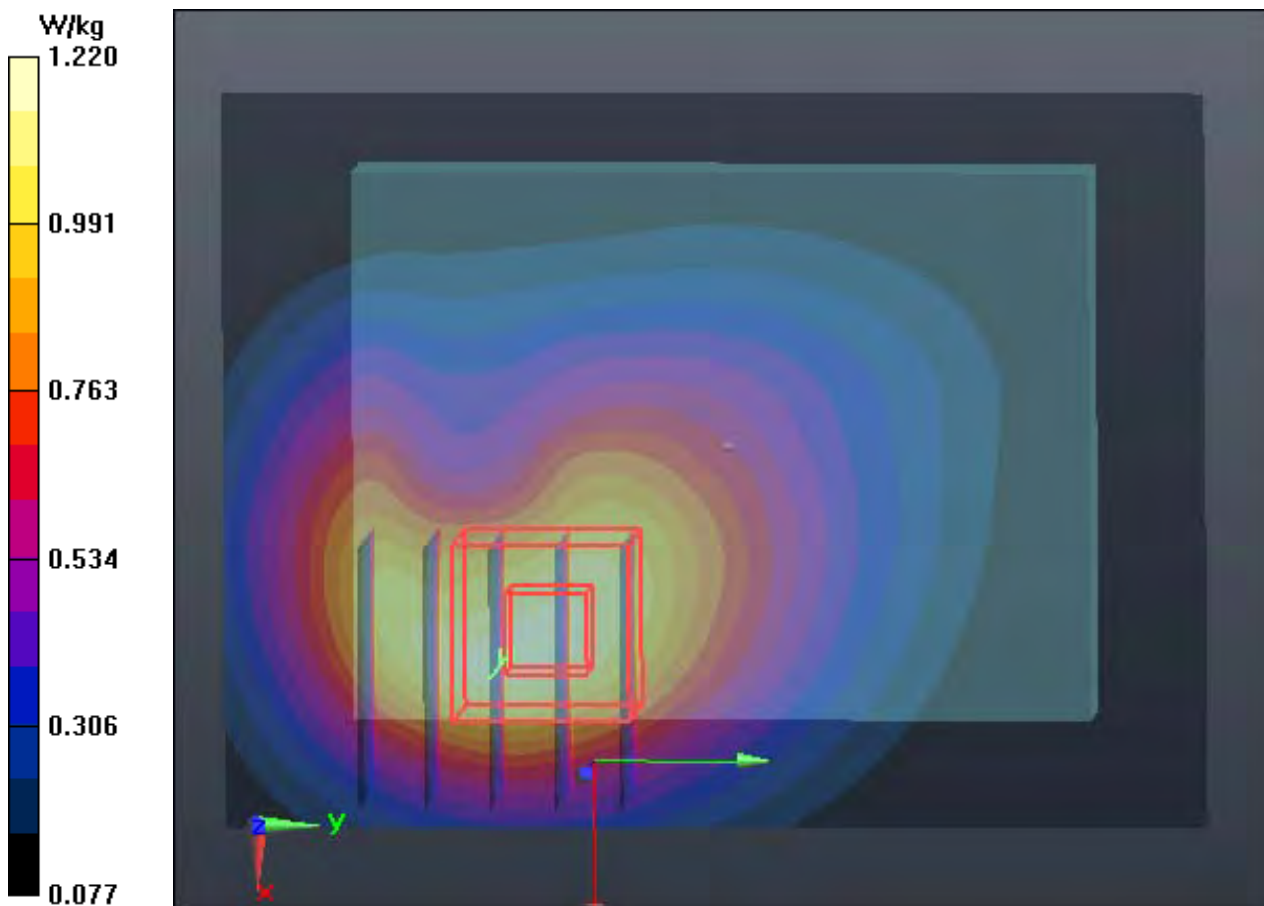

P07 LTE 25_QPSK20M_Left Side_1cm_Ch26140_1 RB_OS 50

DUT: 171023K006

Communication System: LTE; Frequency: 1860 MHz; Duty Cycle: 1:1
Medium: B1900_171201 Medium parameters used: $f = 1860$ MHz; $\sigma = 1.509$ S/m; $\epsilon_r = 53.492$; $\rho = 1000$ kg/m³
Ambient Temperature : 22.0 °C; Liquid Temperature : 21.5 °C

DASY5 Configuration:

- Probe: EX3DV4 - SN7419; ConvF(7.79, 7.79, 7.79); Calibrated: 2017/08/22;
- Sensor-Surface: 1.4mm (Mechanical Surface Detection)
- Electronics: DAE4 Sn1397; Calibrated: 2017/08/17
- Phantom: SAM with CRP v5.0 Front; Type: QD000P40CD; Serial: TP:1787
- Measurement SW: DASY52, Version 52.8 (8); SEMCAD X Version 14.6.10 (7331)

- **Area Scan (41x61x1):** Interpolated grid: dx=1.500 mm, dy=1.500 mm
Maximum value of SAR (interpolated) = 2.19 W/kg

- **Zoom Scan (5x5x7)/Cube 0:** Measurement grid: dx=8mm, dy=8mm, dz=5mm
Reference Value = 32.85 V/m; Power Drift = -0.13 dB
Peak SAR (extrapolated) = 2.20 W/kg
SAR(1 g) = 1.26 W/kg; SAR(10 g) = 0.648 W/kg
Maximum value of SAR (measured) = 1.85 W/kg

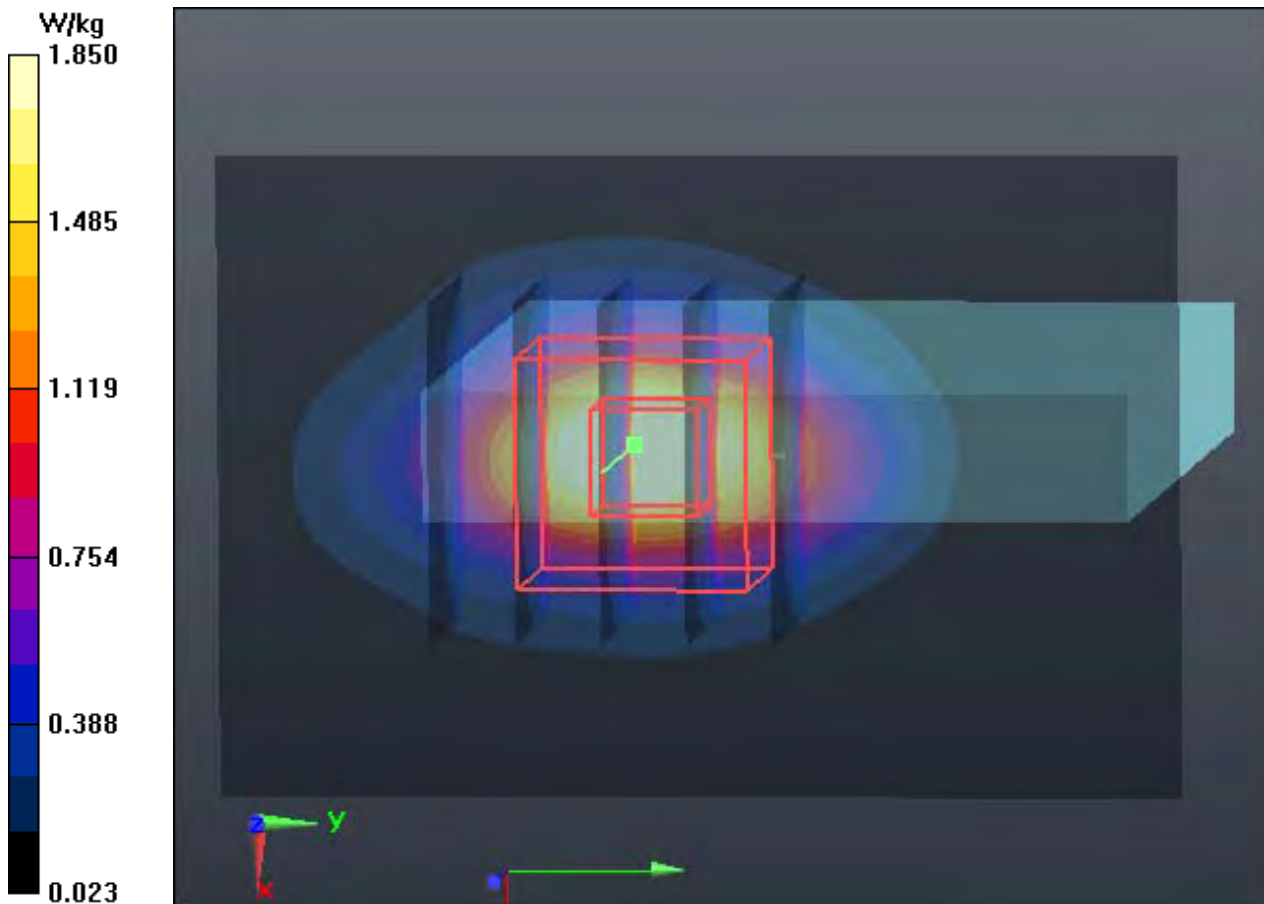

P08 802.11b_Rear Face_1cm_Ch11

DUT: 171023K006

Communication System: WLAN_2.4G; Frequency: 2462 MHz; Duty Cycle: 1:1
Medium: B2450_171028 Medium parameters used: $f = 2462$ MHz; $\sigma = 2.009$ S/m; $\epsilon_r = 51.737$; $\rho = 1000$ kg/m³
Ambient Temperature : 22.6 °C; Liquid Temperature : 22.0 °C

DASY5 Configuration:

- Probe: EX3DV4 - SN7419; ConvF(7.54, 7.54, 7.54); Calibrated: 2017/08/22;
- Sensor-Surface: 1.4mm (Mechanical Surface Detection)
- Electronics: DAE4 Sn1397; Calibrated: 2017/08/17
- Phantom: SAM with CRP v5.0 Front; Type: QD000P40CD; Serial: TP:1787
- Measurement SW: DASY52, Version 52.8 (8); SEMCAD X Version 14.6.10 (7331)

- **Area Scan (81x111x1):** Interpolated grid: dx=1.200 mm, dy=1.200 mm
Maximum value of SAR (interpolated) = 0.101 W/kg

- **Zoom Scan (7x7x7)/Cube 0:** Measurement grid: dx=5mm, dy=5mm, dz=5mm
Reference Value = 3.328 V/m; Power Drift = 0.05 dB
Peak SAR (extrapolated) = 0.118 W/kg
SAR(1 g) = 0.060 W/kg; SAR(10 g) = 0.031 W/kg
Maximum value of SAR (measured) = 0.0938 W/kg

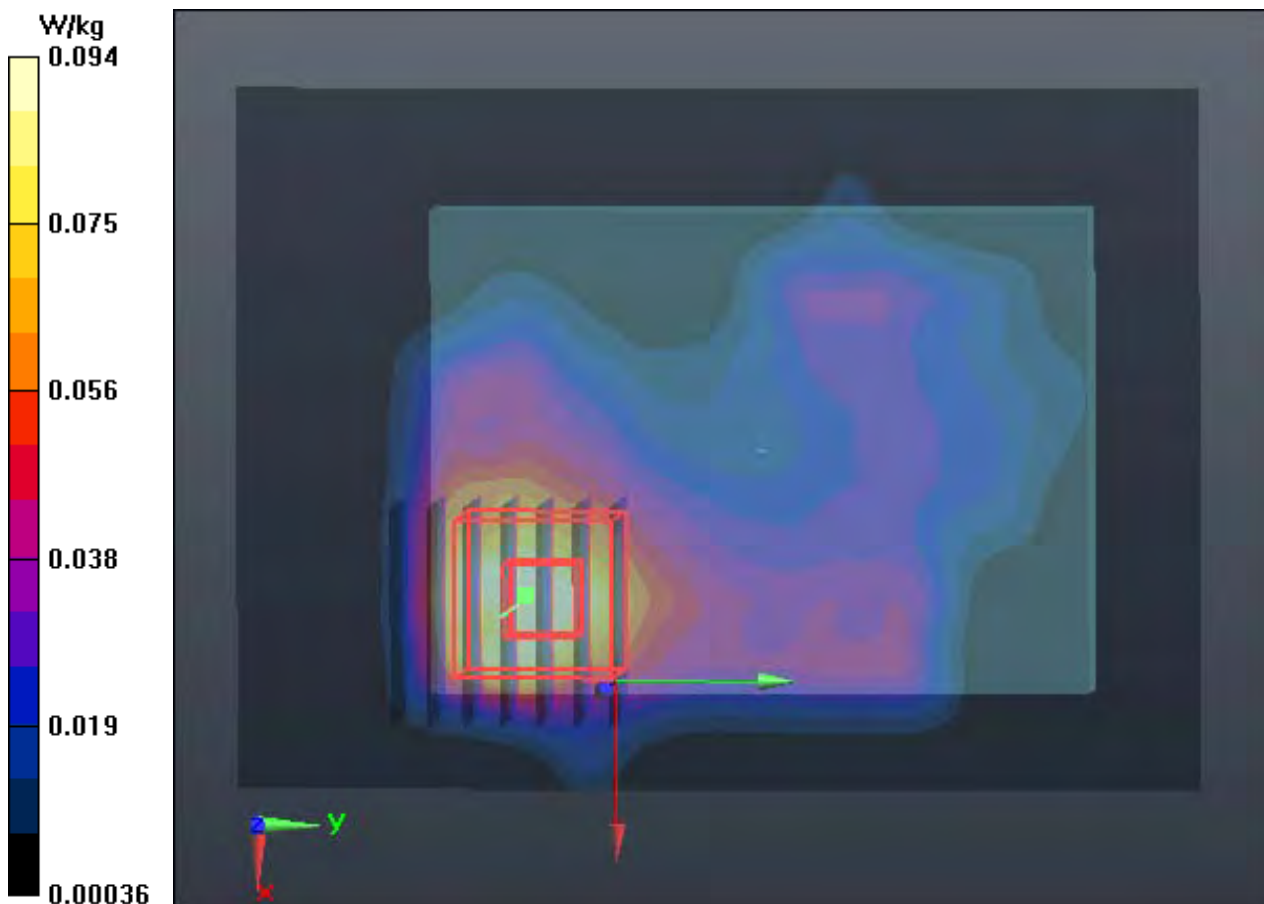



Appendix C. Calibration Certificate for Probe and Dipole

The SPEAG calibration certificates are shown as follows.



Accredited by the Swiss Accreditation Service (SAS)
The Swiss Accreditation Service is one of the signatories to the EA
Multilateral Agreement for the recognition of calibration certificates

Accreditation No.: **SCS 0108**

Client **B.V. ADT (Dymstec)**

Certificate No: **D750V3-1096_Sep17**

CALIBRATION CERTIFICATE

Object **D750V3 - SN:1096**

Calibration procedure(s) **QA CAL-05.v9
Calibration procedure for dipole validation kits above 700 MHz**

Calibration date: **September 21, 2017**

This calibration certificate documents the traceability to national standards, which realize the physical units of measurements (SI).
The measurements and the uncertainties with confidence probability are given on the following pages and are part of the certificate.

All calibrations have been conducted in the closed laboratory facility: environment temperature (22 ± 3)°C and humidity < 70%.

Calibration Equipment used (M&TE critical for calibration)

Primary Standards	ID #	Cal Date (Certificate No.)	Scheduled Calibration
Power meter NRP	SN: 104778	04-Apr-17 (No. 217-02521/02522)	Apr-18
Power sensor NRP-Z91	SN: 103244	04-Apr-17 (No. 217-02521)	Apr-18
Power sensor NRP-Z91	SN: 103245	04-Apr-17 (No. 217-02522)	Apr-18
Reference 20 dB Attenuator	SN: 5058 (20k)	07-Apr-17 (No. 217-02528)	Apr-18
Type-N mismatch combination	SN: 5047.2 / 06327	07-Apr-17 (No. 217-02529)	Apr-18
Reference Probe EX3DV4	SN: 7349	31-May-17 (No. EX3-7349_May17)	May-18
DAE4	SN: 601	28-Mar-17 (No. DAE4-601_Mar17)	Mar-18

Secondary Standards	ID #	Check Date (in house)	Scheduled Check
Power meter EPM-442A	SN: GB37480704	07-Oct-15 (in house check Oct-16)	In house check: Oct-18
Power sensor HP 8481A	SN: US37292783	07-Oct-15 (in house check Oct-16)	In house check: Oct-18
Power sensor HP 8481A	SN: MY41092317	07-Oct-15 (in house check Oct-16)	In house check: Oct-18
RF generator R&S SMT-06	SN: 100972	15-Jun-15 (in house check Oct-16)	In house check: Oct-18
Network Analyzer HP 8753E	SN: US37390585	18-Oct-01 (in house check Oct-16)	In house check: Oct-17

Calibrated by: **Michael Weber** Name: Michael Weber Function: Laboratory Technician Signature: *M. Weber*

Approved by: **Katja Pokovic** Name: Katja Pokovic Function: Technical Manager Signature: *K. Pokovic*

Issued: September 21, 2017

This calibration certificate shall not be reproduced except in full without written approval of the laboratory.



Accredited by the Swiss Accreditation Service (SAS)

The Swiss Accreditation Service is one of the signatories to the EA
Multilateral Agreement for the recognition of calibration certificates

Accreditation No.: **SCS 0108**

Glossary:

TSL	tissue simulating liquid
ConvF	sensitivity in TSL / NORM x,y,z
N/A	not applicable or not measured

Calibration is Performed According to the Following Standards:

- IEEE Std 1528-2013, "IEEE Recommended Practice for Determining the Peak Spatial-Averaged Specific Absorption Rate (SAR) in the Human Head from Wireless Communications Devices: Measurement Techniques", June 2013
- IEC 62209-1, "Measurement procedure for the assessment of Specific Absorption Rate (SAR) from hand-held and body-mounted devices used next to the ear (frequency range of 300 MHz to 6 GHz)", July 2016
- IEC 62209-2, "Procedure to determine the Specific Absorption Rate (SAR) for wireless communication devices used in close proximity to the human body (frequency range of 30 MHz to 6 GHz)", March 2010
- KDB 865664, "SAR Measurement Requirements for 100 MHz to 6 GHz"

Additional Documentation:

- DASY4/5 System Handbook

Methods Applied and Interpretation of Parameters:

- Measurement Conditions:** Further details are available from the Validation Report at the end of the certificate. All figures stated in the certificate are valid at the frequency indicated.
- Antenna Parameters with TSL:** The dipole is mounted with the spacer to position its feed point exactly below the center marking of the flat phantom section, with the arms oriented parallel to the body axis.
- Feed Point Impedance and Return Loss:** These parameters are measured with the dipole positioned under the liquid filled phantom. The impedance stated is transformed from the measurement at the SMA connector to the feed point. The Return Loss ensures low reflected power. No uncertainty required.
- Electrical Delay:** One-way delay between the SMA connector and the antenna feed point. No uncertainty required.
- SAR measured:** SAR measured at the stated antenna input power.
- SAR normalized:** SAR as measured, normalized to an input power of 1 W at the antenna connector.
- SAR for nominal TSL parameters:** The measured TSL parameters are used to calculate the nominal SAR result.

The reported uncertainty of measurement is stated as the standard uncertainty of measurement multiplied by the coverage factor $k=2$, which for a normal distribution corresponds to a coverage probability of approximately 95%.

Measurement Conditions

DASY system configuration, as far as not given on page 1.

DASY Version	DASY5	V52.10.0
Extrapolation	Advanced Extrapolation	
Phantom	Modular Flat Phantom	
Distance Dipole Center - TSL	15 mm	with Spacer
Zoom Scan Resolution	dx, dy, dz = 5 mm	
Frequency	750 MHz \pm 1 MHz	

Head TSL parameters

The following parameters and calculations were applied.

	Temperature	Permittivity	Conductivity
Nominal Head TSL parameters	22.0 °C	41.9	0.89 mho/m
Measured Head TSL parameters	(22.0 \pm 0.2) °C	41.2 \pm 6 %	0.90 mho/m \pm 6 %
Head TSL temperature change during test	< 0.5 °C	----	----

SAR result with Head TSL

SAR averaged over 1 cm³ (1 g) of Head TSL	Condition	
SAR measured	250 mW input power	2.08 W/kg
SAR for nominal Head TSL parameters	normalized to 1W	8.22 W/kg \pm 17.0 % (k=2)

SAR averaged over 10 cm³ (10 g) of Head TSL	condition	
SAR measured	250 mW input power	1.35 W/kg
SAR for nominal Head TSL parameters	normalized to 1W	5.35 W/kg \pm 16.5 % (k=2)

Body TSL parameters

The following parameters and calculations were applied.

	Temperature	Permittivity	Conductivity
Nominal Body TSL parameters	22.0 °C	55.5	0.96 mho/m
Measured Body TSL parameters	(22.0 \pm 0.2) °C	55.5 \pm 6 %	0.96 mho/m \pm 6 %
Body TSL temperature change during test	< 0.5 °C	----	----

SAR result with Body TSL

SAR averaged over 1 cm³ (1 g) of Body TSL	Condition	
SAR measured	250 mW input power	2.14 W/kg
SAR for nominal Body TSL parameters	normalized to 1W	8.56 W/kg \pm 17.0 % (k=2)

SAR averaged over 10 cm³ (10 g) of Body TSL	condition	
SAR measured	250 mW input power	1.41 W/kg
SAR for nominal Body TSL parameters	normalized to 1W	5.64 W/kg \pm 16.5 % (k=2)

Appendix (Additional assessments outside the scope of SCS 0108)

Antenna Parameters with Head TSL

Impedance, transformed to feed point	55.3 Ω - 0.1 j Ω
Return Loss	- 25.9 dB

Antenna Parameters with Body TSL

Impedance, transformed to feed point	49.9 Ω - 4.4 j Ω
Return Loss	- 27.1 dB

General Antenna Parameters and Design

Electrical Delay (one direction)	1.031 ns
----------------------------------	----------

After long term use with 100W radiated power, only a slight warming of the dipole near the feedpoint can be measured.

The dipole is made of standard semirigid coaxial cable. The center conductor of the feeding line is directly connected to the second arm of the dipole. The antenna is therefore short-circuited for DC-signals. On some of the dipoles, small end caps are added to the dipole arms in order to improve matching when loaded according to the position as explained in the "Measurement Conditions" paragraph. The SAR data are not affected by this change. The overall dipole length is still according to the Standard.

No excessive force must be applied to the dipole arms, because they might bend or the soldered connections near the feedpoint may be damaged.

Additional EUT Data

Manufactured by	SPEAG
Manufactured on	May 15, 2013

DASY5 Validation Report for Head TSL

Date: 21.09.2017

Test Laboratory: SPEAG, Zurich, Switzerland

DUT: Dipole 750 MHz; Type: D750V3; Serial: D750V3 - SN:1096

Communication System: UID 0 - CW; Frequency: 750 MHz

Medium parameters used: $f = 750 \text{ MHz}$; $\sigma = 0.9 \text{ S/m}$; $\epsilon_r = 41.2$; $\rho = 1000 \text{ kg/m}^3$

Phantom section: Flat Section

Measurement Standard: DASY5 (IEEE/IEC/ANSI C63.19-2011)

DASY52 Configuration:

- Probe: EX3DV4 - SN7349; ConvF(10.49, 10.49, 10.49); Calibrated: 31.05.2017;
- Sensor-Surface: 1.4mm (Mechanical Surface Detection)
- Electronics: DAE4 Sn601; Calibrated: 28.03.2017
- Phantom: Flat Phantom 4.9 (front); Type: QD 00L P49 AA; Serial: 1001
- DASY52 52.10.0(1446); SEMCAD X 14.6.10(7417)

Dipole Calibration for Head Tissue/Pin=250 mW, d=15mm/Zoom Scan (7x7x7)/Cube 0:

Measurement grid: $dx=5\text{mm}$, $dy=5\text{mm}$, $dz=5\text{mm}$

Reference Value = 58.42 V/m; Power Drift = 0.02 dB

Peak SAR (extrapolated) = 3.21 W/kg

SAR(1 g) = 2.08 W/kg; SAR(10 g) = 1.35 W/kg

Maximum value of SAR (measured) = 2.81 W/kg

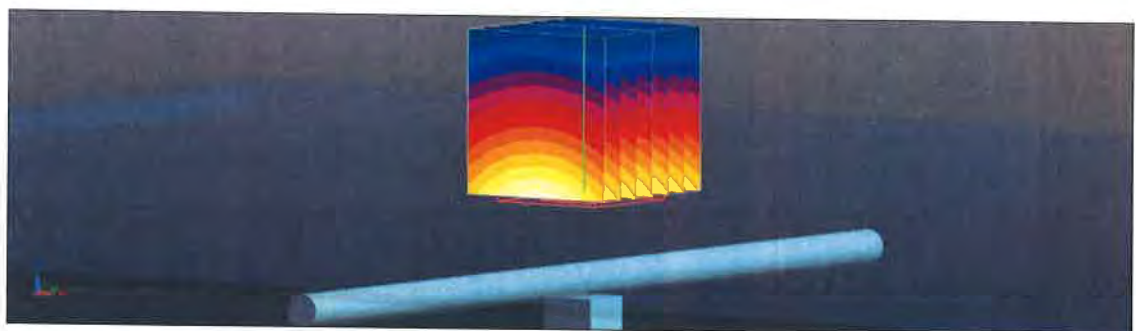
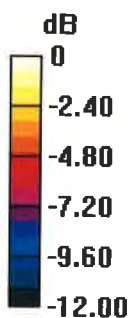

0 dB = 2.81 W/kg = 4.49 dBW/kg

Impedance Measurement Plot for Head TSL

21 Sep 2017 11:58:05
CH1 S11 1 U FS 1: 55.311 Ω -113.28 m Ω 1.8733 nF 750.000 000 MHz

*
De1
CA

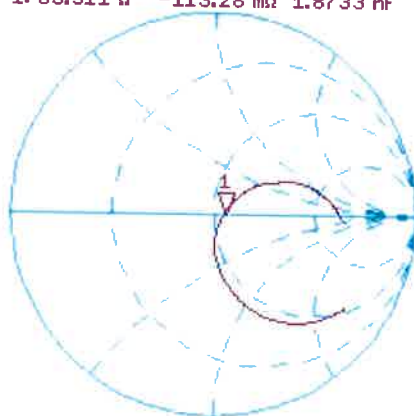

Avg
16

H1 d

CH2 S11 LOG 5 dB/REF -20 dB 1:-25.943 dB 750.000 000 MHz

CA

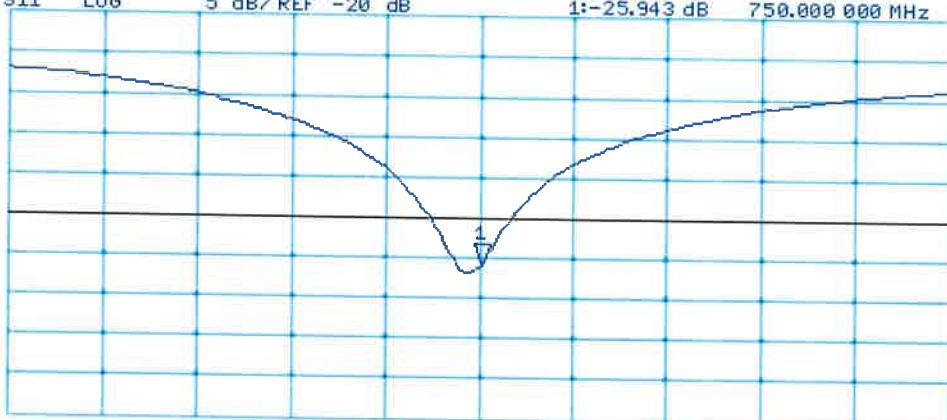

Avg
16

H1 d

START 550.000 000 MHz

STOP 950.000 000 MHz

DASY5 Validation Report for Body TSL

Date: 21.09.2017

Test Laboratory: SPEAG, Zurich, Switzerland

DUT: Dipole 750 MHz; Type: D750V3; Serial: D750V3 - SN:1096

Communication System: UID 0 - CW; Frequency: 750 MHz

Medium parameters used: $f = 750$ MHz; $\sigma = 0.96$ S/m; $\epsilon_r = 55.5$; $\rho = 1000$ kg/m³

Phantom section: Flat Section

Measurement Standard: DASY5 (IEEE/IEC/ANSI C63.19-2011)

DASY52 Configuration:

- Probe: EX3DV4 - SN7349; ConvF(10.35, 10.35, 10.35); Calibrated: 31.05.2017;
- Sensor-Surface: 1.4mm (Mechanical Surface Detection)
- Electronics: DAE4 Sn601; Calibrated: 28.03.2017
- Phantom: Flat Phantom 4.9 (Back); Type: QD 00R P49 AA; Serial: 1005
- DASY52 52.10.0(1446); SEMCAD X 14.6.10(7417)

Dipole Calibration for Body Tissue/Pin=250 mW, d=15mm/Zoom Scan (7x7x7)/Cube 0:

Measurement grid: dx=5mm, dy=5mm, dz=5mm

Reference Value = 57.32 V/m; Power Drift = -0.00 dB

Peak SAR (extrapolated) = 3.20 W/kg

SAR(1 g) = 2.14 W/kg; SAR(10 g) = 1.41 W/kg

Maximum value of SAR (measured) = 2.82 W/kg

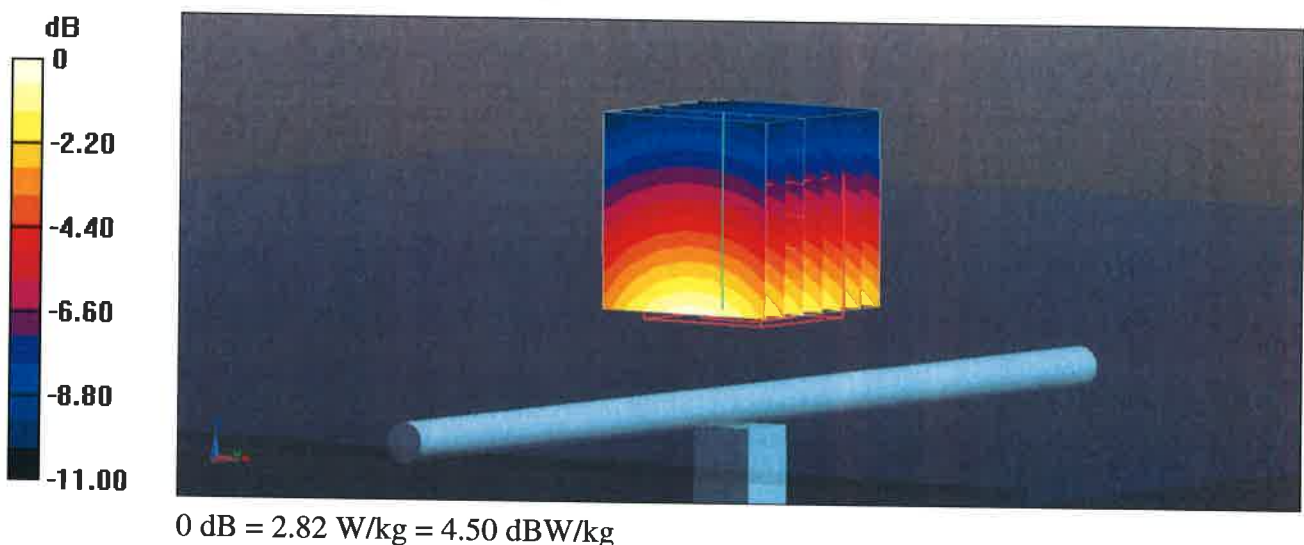

Impedance Measurement Plot for Body TSL

21 Sep 2017 11:57:28
[CH1] S11 1 U FS 1: 49.920 Ω -4.4219 Ω 47.990 pF 750.000 000 MHz

*
De1
CA

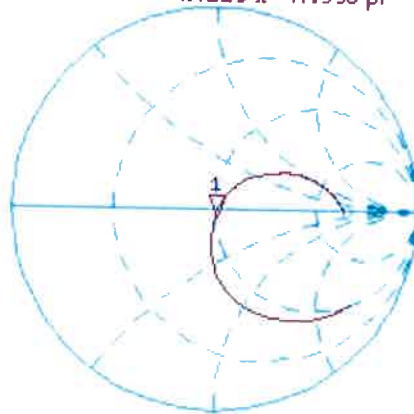

Avg
16

H1 d

CH2 S11 LOG 5 dB/REF -20 dB 1:-27.080 dB 750.000 000 MHz

CA

Avg
16

H1 d

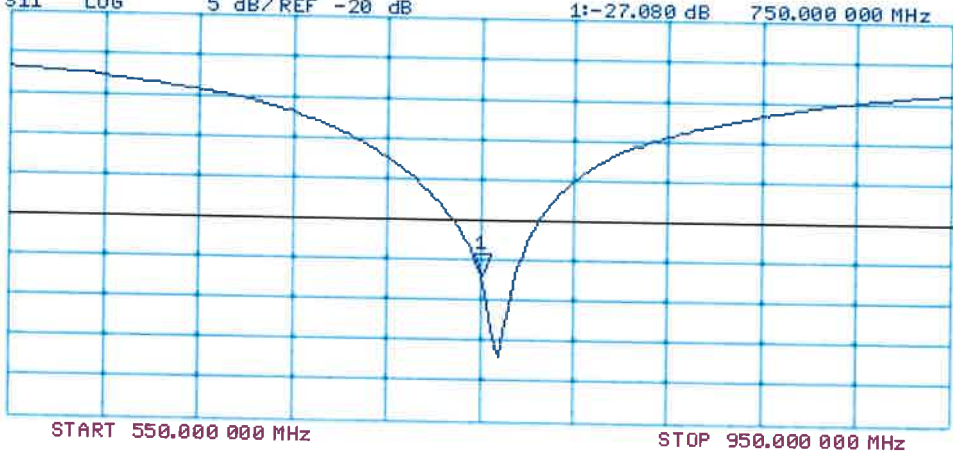



Accredited by the Swiss Accreditation Service (SAS)
The Swiss Accreditation Service is one of the signatories to the EA
Multilateral Agreement for the recognition of calibration certificates

Accreditation No.: **SCS 0108**

Client **B.V. ADT (Dymstec)**

Certificate No: **D835V2-4d021_Aug17**

CALIBRATION CERTIFICATE

Object **D835V2 - SN:4d021**

Calibration procedure(s) **QA CAL-05.v9
Calibration procedure for dipole validation kits above 700 MHz**

Calibration date: **August 24, 2017**

This calibration certificate documents the traceability to national standards, which realize the physical units of measurements (SI).
The measurements and the uncertainties with confidence probability are given on the following pages and are part of the certificate.

All calibrations have been conducted in the closed laboratory facility: environment temperature (22 ± 3)°C and humidity < 70%.

Calibration Equipment used (M&TE critical for calibration)

Primary Standards	ID #	Cal Date (Certificate No.)	Scheduled Calibration
Power meter NRP	SN: 104778	04-Apr-17 (No. 217-02521/02522)	Apr-18
Power sensor NRP-Z91	SN: 103244	04-Apr-17 (No. 217-02521)	Apr-18
Power sensor NRP-Z91	SN: 103245	04-Apr-17 (No. 217-02522)	Apr-18
Reference 20 dB Attenuator	SN: 5058 (20k)	07-Apr-17 (No. 217-02528)	Apr-18
Type-N mismatch combination	SN: 5047.2 / 06327	07-Apr-17 (No. 217-02529)	Apr-18
Reference Probe EX3DV4	SN: 7349	31-May-17 (No. EX3-7349_May17)	May-18
DAE4	SN: 601	28-Mar-17 (No. DAE4-601_Mar17)	Mar-18

Secondary Standards	ID #	Check Date (in house)	Scheduled Check
Power meter EPM-442A	SN: GB37480704	07-Oct-15 (in house check Oct-16)	In house check: Oct-18
Power sensor HP 8481A	SN: US37292783	07-Oct-15 (in house check Oct-16)	In house check: Oct-18
Power sensor HP 8481A	SN: MY41092317	07-Oct-15 (in house check Oct-16)	In house check: Oct-18
RF generator R&S SMT-06	SN: 100972	15-Jun-15 (in house check Oct-16)	In house check: Oct-18
Network Analyzer HP 8753E	SN: US37390585	18-Oct-01 (in house check Oct-16)	In house check: Oct-17

Calibrated by: **Johannes Kurikka** (Name) **Laboratory Technician** (Function)  (Signature)

Approved by: **Katja Pokovic** (Name) **Technical Manager** (Function)  (Signature)

Issued: August 24, 2017

This calibration certificate shall not be reproduced except in full without written approval of the laboratory.



Accredited by the Swiss Accreditation Service (SAS)

The Swiss Accreditation Service is one of the signatories to the EA
Multilateral Agreement for the recognition of calibration certificates

Accreditation No.: **SCS 0108**

Glossary:

TSL	tissue simulating liquid
ConvF	sensitivity in TSL / NORM x,y,z
N/A	not applicable or not measured

Calibration is Performed According to the Following Standards:

- IEEE Std 1528-2013, "IEEE Recommended Practice for Determining the Peak Spatial-Averaged Specific Absorption Rate (SAR) in the Human Head from Wireless Communications Devices: Measurement Techniques", June 2013
- IEC 62209-1, "Measurement procedure for the assessment of Specific Absorption Rate (SAR) from hand-held and body-mounted devices used next to the ear (frequency range of 300 MHz to 6 GHz)", July 2016
- IEC 62209-2, "Procedure to determine the Specific Absorption Rate (SAR) for wireless communication devices used in close proximity to the human body (frequency range of 30 MHz to 6 GHz)", March 2010
- KDB 865664, "SAR Measurement Requirements for 100 MHz to 6 GHz"

Additional Documentation:

- DASY4/5 System Handbook

Methods Applied and Interpretation of Parameters:

- Measurement Conditions:** Further details are available from the Validation Report at the end of the certificate. All figures stated in the certificate are valid at the frequency indicated.
- Antenna Parameters with TSL:** The dipole is mounted with the spacer to position its feed point exactly below the center marking of the flat phantom section, with the arms oriented parallel to the body axis.
- Feed Point Impedance and Return Loss:** These parameters are measured with the dipole positioned under the liquid filled phantom. The impedance stated is transformed from the measurement at the SMA connector to the feed point. The Return Loss ensures low reflected power. No uncertainty required.
- Electrical Delay:** One-way delay between the SMA connector and the antenna feed point. No uncertainty required.
- SAR measured:** SAR measured at the stated antenna input power.
- SAR normalized:** SAR as measured, normalized to an input power of 1 W at the antenna connector.
- SAR for nominal TSL parameters:** The measured TSL parameters are used to calculate the nominal SAR result.

The reported uncertainty of measurement is stated as the standard uncertainty of measurement multiplied by the coverage factor $k=2$, which for a normal distribution corresponds to a coverage probability of approximately 95%.

Measurement Conditions

DASY system configuration, as far as not given on page 1.

DASY Version	DASY5	V52.10.0
Extrapolation	Advanced Extrapolation	
Phantom	Modular Flat Phantom	
Distance Dipole Center - TSL	15 mm	with Spacer
Zoom Scan Resolution	dx, dy, dz = 5 mm	
Frequency	835 MHz \pm 1 MHz	

Head TSL parameters

The following parameters and calculations were applied.

	Temperature	Permittivity	Conductivity
Nominal Head TSL parameters	22.0 °C	41.5	0.90 mho/m
Measured Head TSL parameters	(22.0 \pm 0.2) °C	40.9 \pm 6 %	0.93 mho/m \pm 6 %
Head TSL temperature change during test	< 0.5 °C	----	----

SAR result with Head TSL

SAR averaged over 1 cm³ (1 g) of Head TSL	Condition	
SAR measured	250 mW input power	2.40 W/kg
SAR for nominal Head TSL parameters	normalized to 1W	9.34 W/kg \pm 17.0 % (k=2)

SAR averaged over 10 cm³ (10 g) of Head TSL	condition	
SAR measured	250 mW input power	1.54 W/kg
SAR for nominal Head TSL parameters	normalized to 1W	6.03 W/kg \pm 16.5 % (k=2)

Body TSL parameters

The following parameters and calculations were applied.

	Temperature	Permittivity	Conductivity
Nominal Body TSL parameters	22.0 °C	55.2	0.97 mho/m
Measured Body TSL parameters	(22.0 \pm 0.2) °C	55.3 \pm 6 %	0.98 mho/m \pm 6 %
Body TSL temperature change during test	< 0.5 °C	----	----

SAR result with Body TSL

SAR averaged over 1 cm³ (1 g) of Body TSL	Condition	
SAR measured	250 mW input power	2.44 W/kg
SAR for nominal Body TSL parameters	normalized to 1W	9.69 W/kg \pm 17.0 % (k=2)

SAR averaged over 10 cm³ (10 g) of Body TSL	condition	
SAR measured	250 mW input power	1.60 W/kg
SAR for nominal Body TSL parameters	normalized to 1W	6.36 W/kg \pm 16.5 % (k=2)

Appendix (Additional assessments outside the scope of SCS 0108)

Antenna Parameters with Head TSL

Impedance, transformed to feed point	51.1 Ω - 2.4 j Ω
Return Loss	- 31.7 dB

Antenna Parameters with Body TSL

Impedance, transformed to feed point	47.2 Ω - 5.9 j Ω
Return Loss	- 23.5 dB

General Antenna Parameters and Design

Electrical Delay (one direction)	1.390 ns
----------------------------------	----------

After long term use with 100W radiated power, only a slight warming of the dipole near the feedpoint can be measured.

The dipole is made of standard semirigid coaxial cable. The center conductor of the feeding line is directly connected to the second arm of the dipole. The antenna is therefore short-circuited for DC-signals. On some of the dipoles, small end caps are added to the dipole arms in order to improve matching when loaded according to the position as explained in the "Measurement Conditions" paragraph. The SAR data are not affected by this change. The overall dipole length is still according to the Standard.

No excessive force must be applied to the dipole arms, because they might bend or the soldered connections near the feedpoint may be damaged.

Additional EUT Data

Manufactured by	SPEAG
Manufactured on	April 22, 2004

DASY5 Validation Report for Head TSL

Date: 24.08.2017

Test Laboratory: SPEAG, Zurich, Switzerland

DUT: Dipole 835 MHz; Type: D835V2; Serial: D835V2 - SN:4d021

Communication System: UID 0 - CW; Frequency: 835 MHz

Medium parameters used: $f = 835$ MHz; $\sigma = 0.93$ S/m; $\epsilon_r = 40.9$; $\rho = 1000$ kg/m³

Phantom section: Flat Section

Measurement Standard: DASY5 (IEEE/IEC/ANSI C63.19-2011)

DASY52 Configuration:

- Probe: EX3DV4 - SN7349; ConvF(10.07, 10.07, 10.07); Calibrated: 31.05.2017;
- Sensor-Surface: 1.4mm (Mechanical Surface Detection)
- Electronics: DAE4 Sn601; Calibrated: 28.03.2017
- Phantom: Flat Phantom 4.9 (front); Type: QD 00L P49 AA; Serial: 1001
- DASY52 52.10.0(1446); SEMCAD X 14.6.10(7417)

Dipole Calibration for Head Tissue/Pin=250 mW, d=15mm/Zoom Scan (7x7x7)/Cube 0:

Measurement grid: dx=5mm, dy=5mm, dz=5mm

Reference Value = 62.42 V/m; Power Drift = -0.04 dB

Peak SAR (extrapolated) = 3.67 W/kg

SAR(1 g) = 2.4 W/kg; SAR(10 g) = 1.54 W/kg

Maximum value of SAR (measured) = 3.25 W/kg

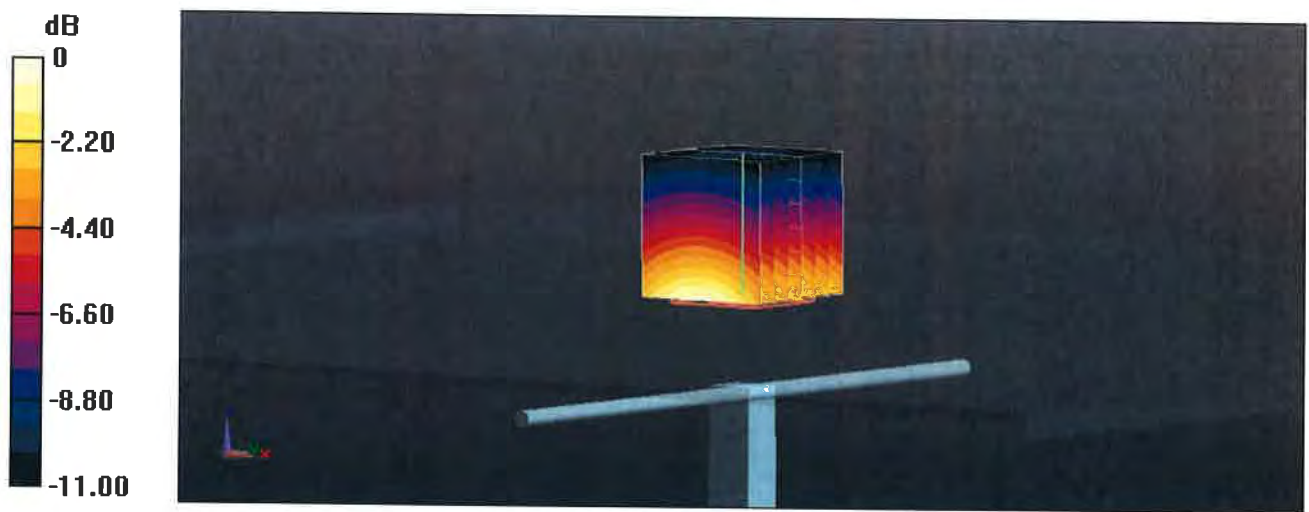

0 dB = 3.25 W/kg = 5.12 dBW/kg

Impedance Measurement Plot for Head TSL

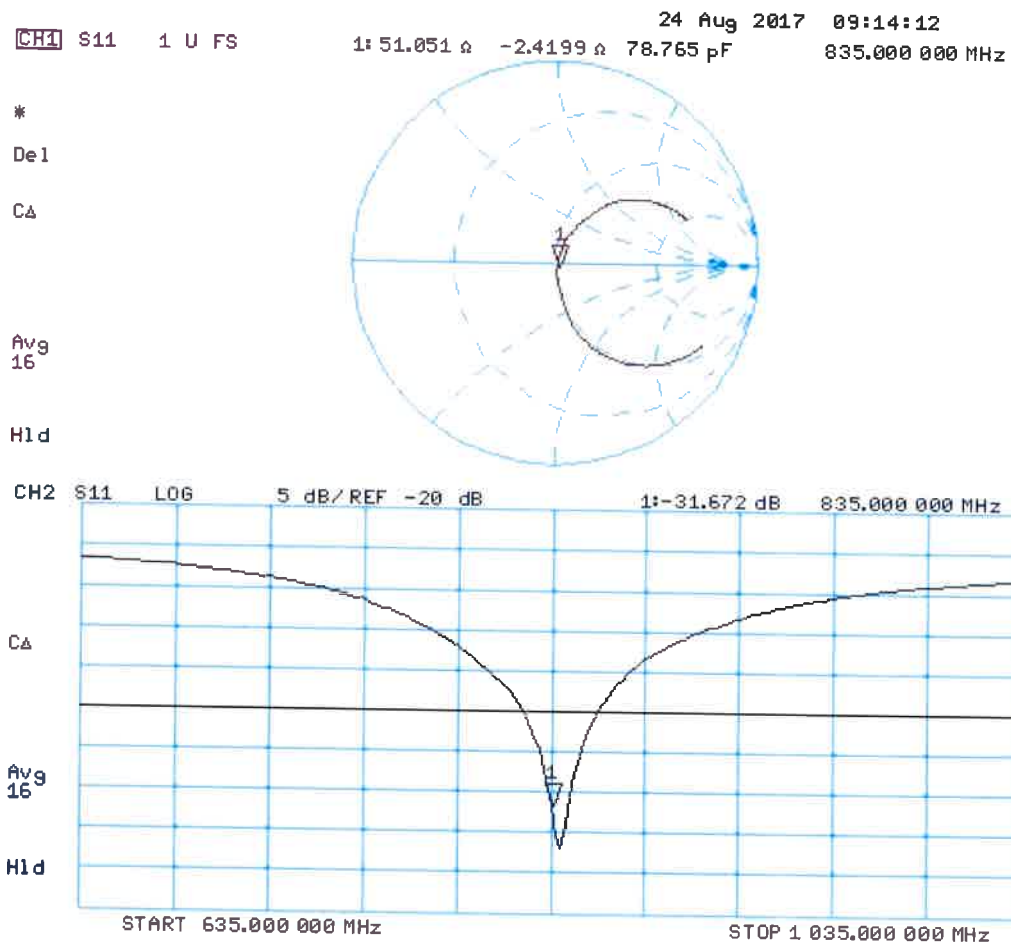

DASY5 Validation Report for Body TSL

Date: 24.08.2017

Test Laboratory: SPEAG, Zurich, Switzerland

DUT: Dipole 835 MHz; Type: D835V2; Serial: D835V2 - SN:4d021

Communication System: UID 0 - CW; Frequency: 835 MHz

Medium parameters used: $f = 835$ MHz; $\sigma = 0.98$ S/m; $\epsilon_r = 55.3$; $\rho = 1000$ kg/m³

Phantom section: Flat Section

Measurement Standard: DASY5 (IEEE/IEC/ANSI C63.19-2011)

DASY52 Configuration:

- Probe: EX3DV4 - SN7349; ConvF(10.2, 10.2, 10.2); Calibrated: 31.05.2017;
- Sensor-Surface: 1.4mm (Mechanical Surface Detection)
- Electronics: DAE4 Sn601; Calibrated: 28.03.2017
- Phantom: Flat Phantom 4.9 (Back); Type: QD 00R P49 AA; Serial: 1005
- DASY52 52.10.0(1446); SEMCAD X 14.6.10(7417)

Dipole Calibration for Body Tissue/Pin=250 mW, d=15mm/Zoom Scan (7x7x7)/Cube 0:

Measurement grid: dx=5mm, dy=5mm, dz=5mm

Reference Value = 60.24 V/m; Power Drift = -0.04 dB

Peak SAR (extrapolated) = 3.64 W/kg

SAR(1 g) = 2.44 W/kg; SAR(10 g) = 1.6 W/kg

Maximum value of SAR (measured) = 3.21 W/kg

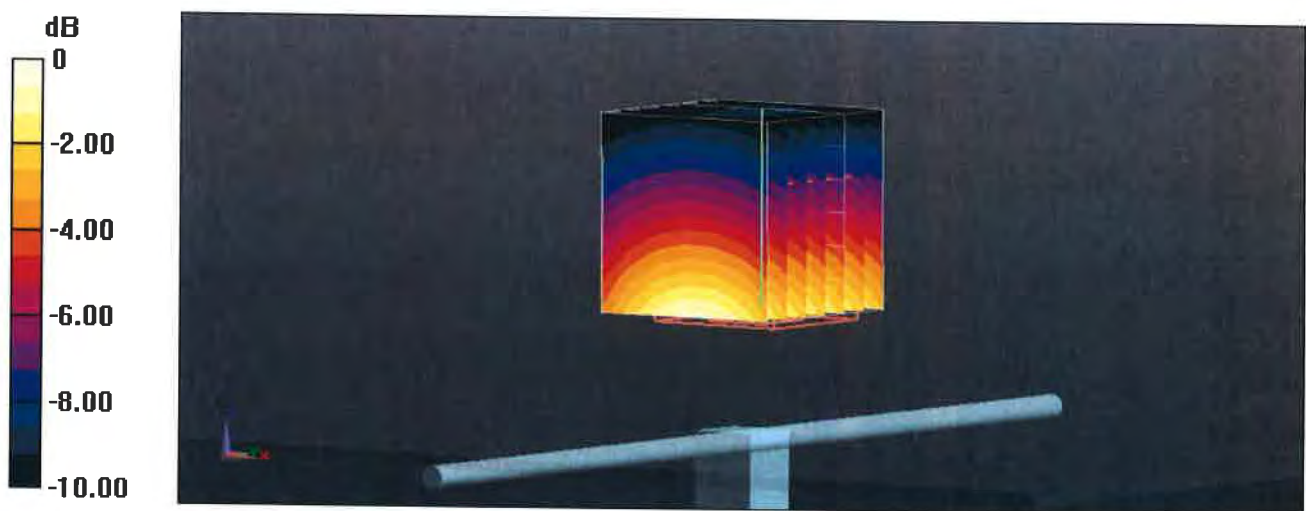

0 dB = 3.21 W/kg = 5.07 dBW/kg

Impedance Measurement Plot for Body TSL

24 Aug 2017 11:20:38
[CH1] S11 1 U FS 1: 47.178 Ω -5.8984 Ω 32.314 pF 835.000 000 MHz

*
De1

CA

Avg
16

H1d

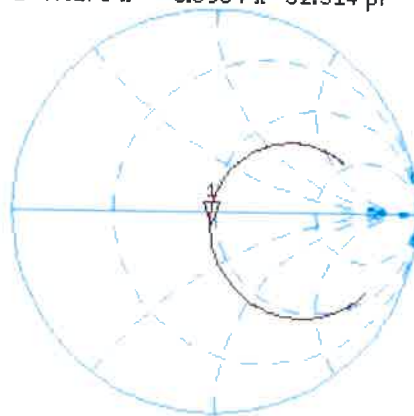

CH2 S11 LOG 5 dB/REF -20 dB 1: -23.457 dB 835.000 000 MHz

CA

Avg
16

H1d

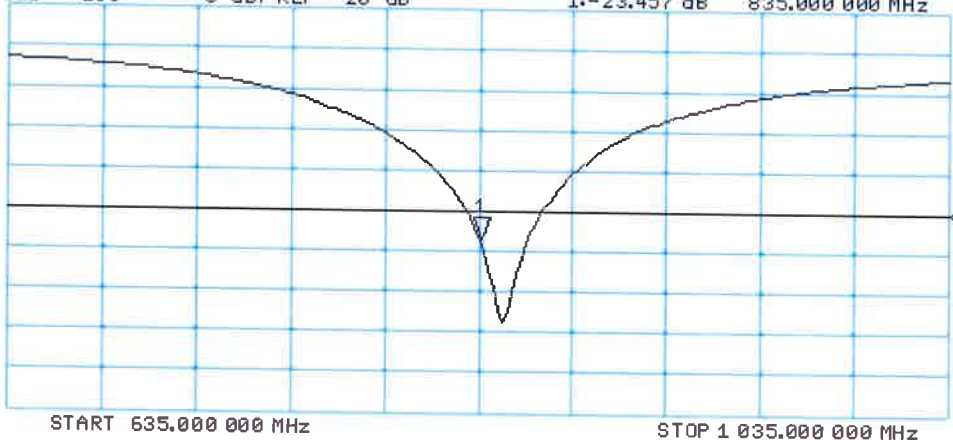



Accredited by the Swiss Accreditation Service (SAS)

Accreditation No.: **SCS 0108**

The Swiss Accreditation Service is one of the signatories to the EA
Multilateral Agreement for the recognition of calibration certificates

Client **B.V. ADT (Dymstec)**

Certificate No: **D1750V2-1102_Sep17**

CALIBRATION CERTIFICATE

Object **D1750V2 - SN:1102**

Calibration procedure(s) **QA CAL-05.v9
Calibration procedure for dipole validation kits above 700 MHz**

Calibration date: **September 20, 2017**

This calibration certificate documents the traceability to national standards, which realize the physical units of measurements (SI).
The measurements and the uncertainties with confidence probability are given on the following pages and are part of the certificate.

All calibrations have been conducted in the closed laboratory facility: environment temperature (22 ± 3)°C and humidity < 70%.

Calibration Equipment used (M&TE critical for calibration)

Primary Standards	ID #	Cal Date (Certificate No.)	Scheduled Calibration
Power meter NRP	SN: 104778	04-Apr-17 (No. 217-02521/02522)	Apr-18
Power sensor NRP-Z91	SN: 103244	04-Apr-17 (No. 217-02521)	Apr-18
Power sensor NRP-Z91	SN: 103245	04-Apr-17 (No. 217-02522)	Apr-18
Reference 20 dB Attenuator	SN: 5058 (20k)	07-Apr-17 (No. 217-02528)	Apr-18
Type-N mismatch combination	SN: 5047.2 / 06327	07-Apr-17 (No. 217-02529)	Apr-18
Reference Probe EX3DV4	SN: 7349	31-May-17 (No. EX3-7349_May17)	May-18
DAE4	SN: 601	28-Mar-17 (No. DAE4-601_Mar17)	Mar-18
Secondary Standards	ID #	Check Date (in house)	Scheduled Check
Power meter EPM-442A	SN: GB37480704	07-Oct-15 (in house check Oct-16)	In house check: Oct-18
Power sensor HP 8481A	SN: US37292783	07-Oct-15 (in house check Oct-16)	In house check: Oct-18
Power sensor HP 8481A	SN: MY41092317	07-Oct-15 (in house check Oct-16)	In house check: Oct-18
RF generator R&S SMT-06	SN: 100972	15-Jun-15 (in house check Oct-16)	In house check: Oct-18
Network Analyzer HP 8753E	SN: US37390585	18-Oct-01 (in house check Oct-16)	In house check: Oct-17

Calibrated by: **Jeton Kastrati** **Function: Laboratory Technician** **Signature:**

Approved by: **Katja Pokovic** **Technical Manager**

Issued: September 20, 2017

This calibration certificate shall not be reproduced except in full without written approval of the laboratory.



Accredited by the Swiss Accreditation Service (SAS)

Accreditation No.: **SCS 0108**

The Swiss Accreditation Service is one of the signatories to the EA
Multilateral Agreement for the recognition of calibration certificates

Glossary:

TSL	tissue simulating liquid
ConvF	sensitivity in TSL / NORM x,y,z
N/A	not applicable or not measured

Calibration is Performed According to the Following Standards:

- IEEE Std 1528-2013, "IEEE Recommended Practice for Determining the Peak Spatial-Averaged Specific Absorption Rate (SAR) in the Human Head from Wireless Communications Devices: Measurement Techniques", June 2013
- IEC 62209-1, "Measurement procedure for the assessment of Specific Absorption Rate (SAR) from hand-held and body-mounted devices used next to the ear (frequency range of 300 MHz to 6 GHz)", July 2016
- IEC 62209-2, "Procedure to determine the Specific Absorption Rate (SAR) for wireless communication devices used in close proximity to the human body (frequency range of 30 MHz to 6 GHz)", March 2010
- KDB 865664, "SAR Measurement Requirements for 100 MHz to 6 GHz"

Additional Documentation:

- DASY4/5 System Handbook

Methods Applied and Interpretation of Parameters:

- Measurement Conditions:** Further details are available from the Validation Report at the end of the certificate. All figures stated in the certificate are valid at the frequency indicated.
- Antenna Parameters with TSL:** The dipole is mounted with the spacer to position its feed point exactly below the center marking of the flat phantom section, with the arms oriented parallel to the body axis.
- Feed Point Impedance and Return Loss:** These parameters are measured with the dipole positioned under the liquid filled phantom. The impedance stated is transformed from the measurement at the SMA connector to the feed point. The Return Loss ensures low reflected power. No uncertainty required.
- Electrical Delay:** One-way delay between the SMA connector and the antenna feed point. No uncertainty required.
- SAR measured:** SAR measured at the stated antenna input power.
- SAR normalized:** SAR as measured, normalized to an input power of 1 W at the antenna connector.
- SAR for nominal TSL parameters:** The measured TSL parameters are used to calculate the nominal SAR result.

The reported uncertainty of measurement is stated as the standard uncertainty of measurement multiplied by the coverage factor $k=2$, which for a normal distribution corresponds to a coverage probability of approximately 95%.

Measurement Conditions

DASY system configuration, as far as not given on page 1.

DASY Version	DASY5	V52.10.0
Extrapolation	Advanced Extrapolation	
Phantom	Modular Flat Phantom	
Distance Dipole Center - TSL	10 mm	with Spacer
Zoom Scan Resolution	dx, dy, dz = 5 mm	
Frequency	1750 MHz ± 1 MHz	

Head TSL parameters

The following parameters and calculations were applied.

	Temperature	Permittivity	Conductivity
Nominal Head TSL parameters	22.0 °C	40.1	1.37 mho/m
Measured Head TSL parameters	(22.0 ± 0.2) °C	39.1 ± 6 %	1.36 mho/m ± 6 %
Head TSL temperature change during test	< 0.5 °C	----	----

SAR result with Head TSL

SAR averaged over 1 cm³ (1 g) of Head TSL	Condition	
SAR measured	250 mW input power	9.19 W/kg
SAR for nominal Head TSL parameters	normalized to 1W	36.7 W/kg ± 17.0 % (k=2)

SAR averaged over 10 cm³ (10 g) of Head TSL	condition	
SAR measured	250 mW input power	4.83 W/kg
SAR for nominal Head TSL parameters	normalized to 1W	19.3 W/kg ± 16.5 % (k=2)

Body TSL parameters

The following parameters and calculations were applied.

	Temperature	Permittivity	Conductivity
Nominal Body TSL parameters	22.0 °C	53.4	1.49 mho/m
Measured Body TSL parameters	(22.0 ± 0.2) °C	53.8 ± 6 %	1.46 mho/m ± 6 %
Body TSL temperature change during test	< 0.5 °C	----	----

SAR result with Body TSL

SAR averaged over 1 cm³ (1 g) of Body TSL	Condition	
SAR measured	250 mW input power	9.00 W/kg
SAR for nominal Body TSL parameters	normalized to 1W	36.5 W/kg ± 17.0 % (k=2)

SAR averaged over 10 cm³ (10 g) of Body TSL	condition	
SAR measured	250 mW input power	4.79 W/kg
SAR for nominal Body TSL parameters	normalized to 1W	19.3 W/kg ± 16.5 % (k=2)

Appendix (Additional assessments outside the scope of SCS 0108)

Antenna Parameters with Head TSL

Impedance, transformed to feed point	$50.5 \Omega + 0.5 j\Omega$
Return Loss	- 42.8 dB

Antenna Parameters with Body TSL

Impedance, transformed to feed point	$46.2 \Omega - 0.5 j\Omega$
Return Loss	- 28.0 dB

General Antenna Parameters and Design

Electrical Delay (one direction)	1.220 ns
----------------------------------	----------

After long term use with 100W radiated power, only a slight warming of the dipole near the feedpoint can be measured.

The dipole is made of standard semirigid coaxial cable. The center conductor of the feeding line is directly connected to the second arm of the dipole. The antenna is therefore short-circuited for DC-signals. On some of the dipoles, small end caps are added to the dipole arms in order to improve matching when loaded according to the position as explained in the "Measurement Conditions" paragraph. The SAR data are not affected by this change. The overall dipole length is still according to the Standard.

No excessive force must be applied to the dipole arms, because they might bend or the soldered connections near the feedpoint may be damaged.

Additional EUT Data

Manufactured by	SPEAG
Manufactured on	May 16, 2013

DASY5 Validation Report for Head TSL

Date: 20.09.2017

Test Laboratory: SPEAG, Zurich, Switzerland

DUT: Dipole 1750 MHz; Type: D1750V2; Serial: D1750V2 - SN:1102

Communication System: UID 0 - CW; Frequency: 1750 MHz

Medium parameters used: $f = 1750$ MHz; $\sigma = 1.36$ S/m; $\epsilon_r = 39.1$; $\rho = 1000$ kg/m³

Phantom section: Flat Section

Measurement Standard: DASY5 (IEEE/IEC/ANSI C63.19-2011)

DASY52 Configuration:

- Probe: EX3DV4 - SN7349; ConvF(8.73, 8.73, 8.73); Calibrated: 31.05.2017;
- Sensor-Surface: 1.4mm (Mechanical Surface Detection)
- Electronics: DAE4 Sn601; Calibrated: 28.03.2017
- Phantom: Flat Phantom 5.0 (front); Type: QD 000 P50 AA; Serial: 1001
- DASY52 52.10.0(1446); SEMCAD X 14.6.10(7417)

Dipole Calibration for Head Tissue/Pin=250 mW, d=10mm/Zoom Scan (7x7x7)/Cube 0:

Measurement grid: dx=5mm, dy=5mm, dz=5mm

Reference Value = 104.5 V/m; Power Drift = -0.08 dB

Peak SAR (extrapolated) = 17.4 W/kg

SAR(1 g) = 9.19 W/kg; SAR(10 g) = 4.83 W/kg

Maximum value of SAR (measured) = 13.8 W/kg

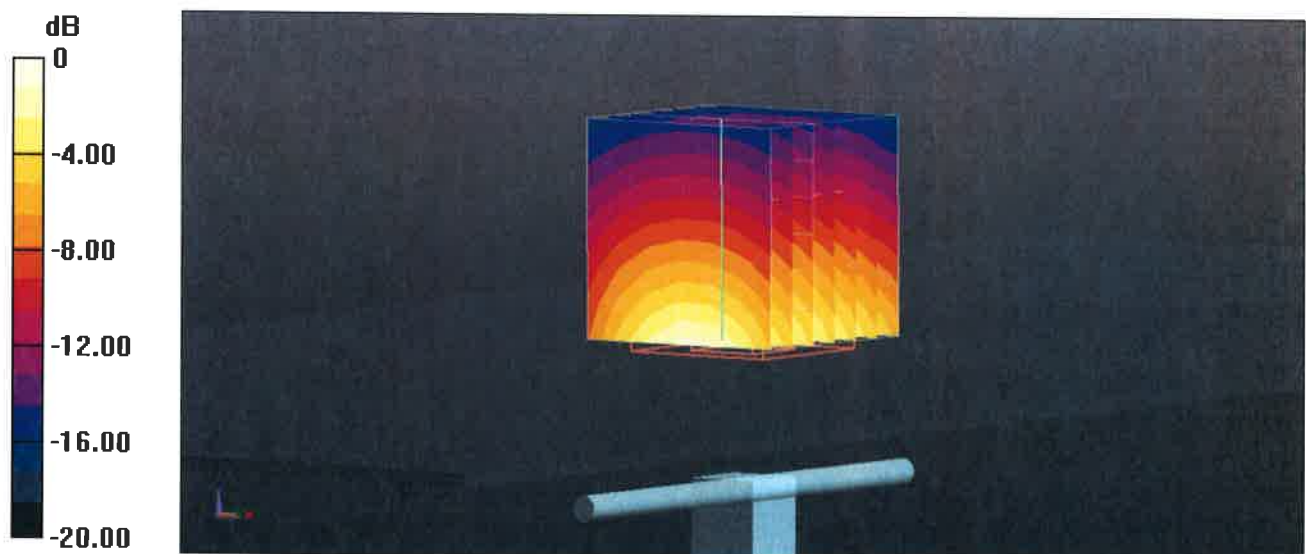

0 dB = 13.8 W/kg = 11.40 dBW/kg

Impedance Measurement Plot for Head TSL

20 Sep 2017 09:59:48

CHI S11 1 U FS 1: 50.520 Ω 0.5197 Ω 46.716 pF 1 750.000 000 MHz

*
De1

CA

Avg
16

H1 d

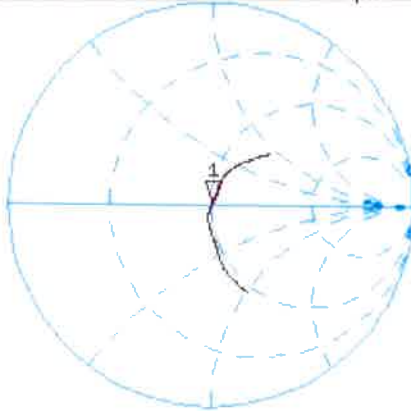

CH2 S11 LOG 5 dB/REF -20 dB 1:-42.767 dB 1 750.000 000 MHz

CA

Avg
16

H1 d

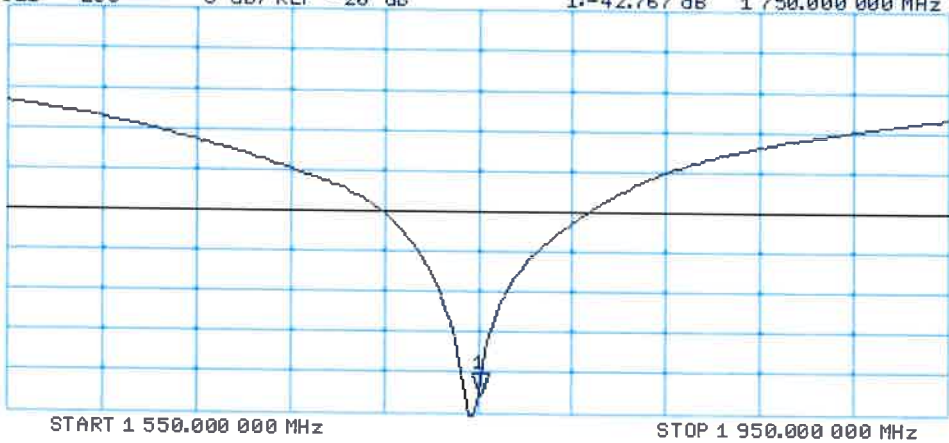

DASY5 Validation Report for Body TSL

Date: 20.09.2017

Test Laboratory: SPEAG, Zurich, Switzerland

DUT: Dipole 1750 MHz; Type: D1750V2; Serial: D1750V2 - SN:1102

Communication System: UID 0 - CW; Frequency: 1750 MHz

Medium parameters used: $f = 1750$ MHz; $\sigma = 1.46$ S/m; $\epsilon_r = 53.8$; $\rho = 1000$ kg/m³

Phantom section: Flat Section

Measurement Standard: DASY5 (IEEE/IEC/ANSI C63.19-2011)

DASY52 Configuration:

- Probe: EX3DV4 - SN7349; ConvF(8.46, 8.46, 8.46); Calibrated: 31.05.2017;
- Sensor-Surface: 1.4mm (Mechanical Surface Detection)
- Electronics: DAE4 Sn601; Calibrated: 28.03.2017
- Phantom: Flat Phantom 5.0 (back); Type: QD 000 P50 AA; Serial: 1002
- DASY52 52.10.0(1446); SEMCAD X 14.6.10(7417)

Dipole Calibration for Body Tissue/Pin=250 mW, d=10mm/Zoom Scan (7x7x7)/Cube 0:

Measurement grid: dx=5mm, dy=5mm, dz=5mm

Reference Value = 98.67 V/m; Power Drift = -0.08 dB

Peak SAR (extrapolated) = 15.8 W/kg

SAR(1 g) = 9 W/kg; SAR(10 g) = 4.79 W/kg

Maximum value of SAR (measured) = 13.0 W/kg

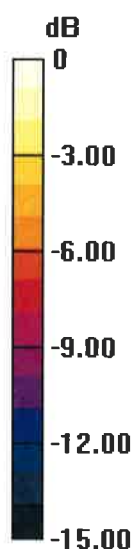

0 dB = 13.0 W/kg = 11.14 dBW/kg

Impedance Measurement Plot for Body TSL

20 Sep 2017 09:59:05

CH1 S11 1 U FS 1: 46.211 Ω -515.63 m Ω 176.38 pF 1 750.000 000 MHz

*
De1

CA

AVG
16

H1d

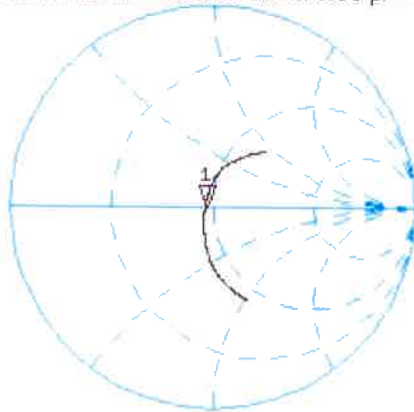

CH2 S11 LOG 5 dB/ REF -20 dB 1:-28.015 dB 1 750.000 000 MHz

CA

AVG
16

H1d

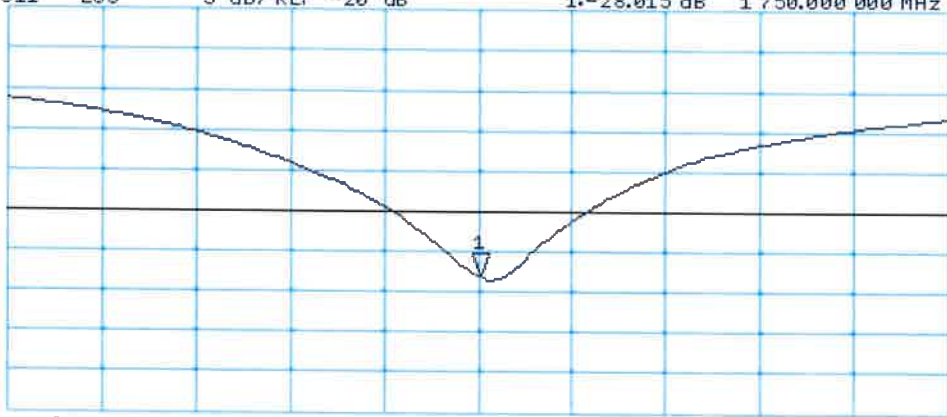

START 1 550.000 000 MHz

STOP 1 950.000 000 MHz



Accredited by the Swiss Accreditation Service (SAS)
The Swiss Accreditation Service is one of the signatories to the EA
Multilateral Agreement for the recognition of calibration certificates

Accreditation No.: **SCS 0108**

Client **B.V. ADT (Dymstec)**

Certificate No: **D1900V2-5d022_Aug17**

CALIBRATION CERTIFICATE

Object **D1900V2 - SN:5d022**

Calibration procedure(s) **QA CAL-05.v9
Calibration procedure for dipole validation kits above 700 MHz**

Calibration date: **August 21, 2017**

This calibration certificate documents the traceability to national standards, which realize the physical units of measurements (SI).
The measurements and the uncertainties with confidence probability are given on the following pages and are part of the certificate.

All calibrations have been conducted in the closed laboratory facility: environment temperature (22 ± 3)°C and humidity < 70%.

Calibration Equipment used (M&TE critical for calibration)

Primary Standards	ID #	Cal Date (Certificate No.)	Scheduled Calibration
Power meter NRP	SN: 104778	04-Apr-17 (No. 217-02521/02522)	Apr-18
Power sensor NRP-Z91	SN: 103244	04-Apr-17 (No. 217-02521)	Apr-18
Power sensor NRP-Z91	SN: 103245	04-Apr-17 (No. 217-02522)	Apr-18
Reference 20 dB Attenuator	SN: 5058 (20k)	07-Apr-17 (No. 217-02528)	Apr-18
Type-N mismatch combination	SN: 5047.2 / 06327	07-Apr-17 (No. 217-02529)	Apr-18
Reference Probe EX3DV4	SN: 7349	31-May-17 (No. EX3-7349_May17)	May-18
DAE4	SN: 601	28-Mar-17 (No. DAE4-601_Mar17)	Mar-18

Secondary Standards	ID #	Check Date (in house)	Scheduled Check
Power meter EPM-442A	SN: GB37480704	07-Oct-15 (in house check Oct-16)	In house check: Oct-18
Power sensor HP 8481A	SN: US37292783	07-Oct-15 (in house check Oct-16)	In house check: Oct-18
Power sensor HP 8481A	SN: MY41092317	07-Oct-15 (in house check Oct-16)	In house check: Oct-18
RF generator R&S SMT-06	SN: 100972	15-Jun-15 (in house check Oct-16)	In house check: Oct-18
Network Analyzer HP 8753E	SN: US37390585	18-Oct-01 (in house check Oct-16)	In house check: Oct-17

Calibrated by: **Claudio Leubler** **Laboratory Technician**

Approved by: **Katja Pokovic** **Technical Manager**

Issued: August 21, 2017

This calibration certificate shall not be reproduced except in full without written approval of the laboratory.



Accredited by the Swiss Accreditation Service (SAS)

The Swiss Accreditation Service is one of the signatories to the EA
Multilateral Agreement for the recognition of calibration certificates

Accreditation No.: **SCS 0108**

Glossary:

TSL	tissue simulating liquid
ConvF	sensitivity in TSL / NORM x,y,z
N/A	not applicable or not measured

Calibration is Performed According to the Following Standards:

- IEEE Std 1528-2013, "IEEE Recommended Practice for Determining the Peak Spatial-Averaged Specific Absorption Rate (SAR) in the Human Head from Wireless Communications Devices: Measurement Techniques", June 2013
- IEC 62209-1, "Measurement procedure for the assessment of Specific Absorption Rate (SAR) from hand-held and body-mounted devices used next to the ear (frequency range of 300 MHz to 6 GHz)", July 2016
- IEC 62209-2, "Procedure to determine the Specific Absorption Rate (SAR) for wireless communication devices used in close proximity to the human body (frequency range of 30 MHz to 6 GHz)", March 2010
- KDB 865664, "SAR Measurement Requirements for 100 MHz to 6 GHz"

Additional Documentation:

- DASY4/5 System Handbook

Methods Applied and Interpretation of Parameters:

- Measurement Conditions:** Further details are available from the Validation Report at the end of the certificate. All figures stated in the certificate are valid at the frequency indicated.
- Antenna Parameters with TSL:** The dipole is mounted with the spacer to position its feed point exactly below the center marking of the flat phantom section, with the arms oriented parallel to the body axis.
- Feed Point Impedance and Return Loss:** These parameters are measured with the dipole positioned under the liquid filled phantom. The impedance stated is transformed from the measurement at the SMA connector to the feed point. The Return Loss ensures low reflected power. No uncertainty required.
- Electrical Delay:** One-way delay between the SMA connector and the antenna feed point. No uncertainty required.
- SAR measured:** SAR measured at the stated antenna input power.
- SAR normalized:** SAR as measured, normalized to an input power of 1 W at the antenna connector.
- SAR for nominal TSL parameters:** The measured TSL parameters are used to calculate the nominal SAR result.

The reported uncertainty of measurement is stated as the standard uncertainty of measurement multiplied by the coverage factor $k=2$, which for a normal distribution corresponds to a coverage probability of approximately 95%.

Measurement Conditions

DASY system configuration, as far as not given on page 1.

DASY Version	DASY5	V52.10.0
Extrapolation	Advanced Extrapolation	
Phantom	Modular Flat Phantom	
Distance Dipole Center - TSL	10 mm	with Spacer
Zoom Scan Resolution	dx, dy, dz = 5 mm	
Frequency	1900 MHz ± 1 MHz	

Head TSL parameters

The following parameters and calculations were applied.

	Temperature	Permittivity	Conductivity
Nominal Head TSL parameters	22.0 °C	40.0	1.40 mho/m
Measured Head TSL parameters	(22.0 ± 0.2) °C	40.6 ± 6 %	1.36 mho/m ± 6 %
Head TSL temperature change during test	< 0.5 °C	----	----

SAR result with Head TSL

SAR averaged over 1 cm³ (1 g) of Head TSL	Condition	
SAR measured	250 mW input power	9.82 W/kg
SAR for nominal Head TSL parameters	normalized to 1W	40.1 W/kg ± 17.0 % (k=2)

SAR averaged over 10 cm³ (10 g) of Head TSL	condition	
SAR measured	250 mW input power	5.19 W/kg
SAR for nominal Head TSL parameters	normalized to 1W	21.0 W/kg ± 16.5 % (k=2)

Body TSL parameters

The following parameters and calculations were applied.

	Temperature	Permittivity	Conductivity
Nominal Body TSL parameters	22.0 °C	53.3	1.52 mho/m
Measured Body TSL parameters	(22.0 ± 0.2) °C	54.1 ± 6 %	1.48 mho/m ± 6 %
Body TSL temperature change during test	< 0.5 °C	----	----

SAR result with Body TSL

SAR averaged over 1 cm³ (1 g) of Body TSL	Condition	
SAR measured	250 mW input power	9.89 W/kg
SAR for nominal Body TSL parameters	normalized to 1W	40.3 W/kg ± 17.0 % (k=2)

SAR averaged over 10 cm³ (10 g) of Body TSL	condition	
SAR measured	250 mW input power	5.28 W/kg
SAR for nominal Body TSL parameters	normalized to 1W	21.4 W/kg ± 16.5 % (k=2)

Appendix (Additional assessments outside the scope of SCS 0108)

Antenna Parameters with Head TSL

Impedance, transformed to feed point	$51.2 \Omega + 3.0 j\Omega$
Return Loss	- 29.8 dB

Antenna Parameters with Body TSL

Impedance, transformed to feed point	$47.5 \Omega + 4.5 j\Omega$
Return Loss	- 25.6 dB

General Antenna Parameters and Design

Electrical Delay (one direction)	1.193 ns
----------------------------------	----------

After long term use with 100W radiated power, only a slight warming of the dipole near the feedpoint can be measured.

The dipole is made of standard semirigid coaxial cable. The center conductor of the feeding line is directly connected to the second arm of the dipole. The antenna is therefore short-circuited for DC-signals. On some of the dipoles, small end caps are added to the dipole arms in order to improve matching when loaded according to the position as explained in the "Measurement Conditions" paragraph. The SAR data are not affected by this change. The overall dipole length is still according to the Standard.

No excessive force must be applied to the dipole arms, because they might bend or the soldered connections near the feedpoint may be damaged.

Additional EUT Data

Manufactured by	SPEAG
Manufactured on	August 29, 2002

DASY5 Validation Report for Head TSL

Date: 18.08.2017

Test Laboratory: SPEAG, Zurich, Switzerland

DUT: Dipole 1900 MHz; Type: D1900V2; Serial: D1900V2 - SN:5d022

Communication System: UID 0 - CW; Frequency: 1900 MHz

Medium parameters used: $f = 1900$ MHz; $\sigma = 1.36$ S/m; $\epsilon_r = 40.6$; $\rho = 1000$ kg/m³

Phantom section: Flat Section

Measurement Standard: DASY5 (IEEE/IEC/ANSI C63.19-2011)

DASY52 Configuration:

- Probe: EX3DV4 - SN7349; ConvF(8.43, 8.43, 8.43); Calibrated: 31.05.2017;
- Sensor-Surface: 1.4mm (Mechanical Surface Detection)
- Electronics: DAE4 Sn601; Calibrated: 28.03.2017
- Phantom: Flat Phantom 5.0 (front); Type: QD 000 P50 AA; Serial: 1001
- DASY52 52.10.0(1446); SEMCAD X 14.6.10(7417)

Dipole Calibration for Head Tissue/Pin=250 mW, d=10mm/Zoom Scan (7x7x7)/Cube 0:

Measurement grid: dx=5mm, dy=5mm, dz=5mm

Reference Value = 108.3 V/m; Power Drift = 0.01 dB

Peak SAR (extrapolated) = 18.1 W/kg

SAR(1 g) = 9.82 W/kg; SAR(10 g) = 5.19 W/kg

Maximum value of SAR (measured) = 15.0 W/kg

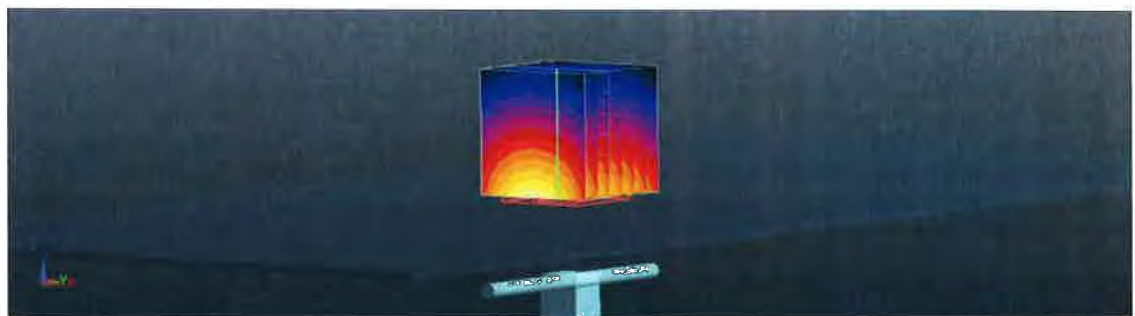
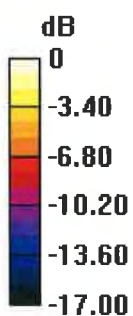

0 dB = 15.0 W/kg = 11.76 dBW/kg

Impedance Measurement Plot for Head TSL

18 Aug 2017 13:30:01

CH1 S11 1 U FS

1: 51.227 Ω 3.0215 Ω 253.10 pF

1 900.000 000 MHz

*
Del

CA

Avg
16

H1d

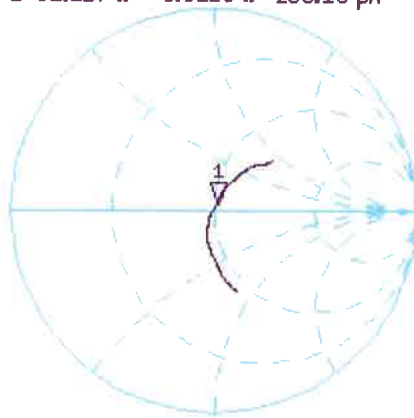

CH2 S11 LOG

5 dB/REF -20 dB

1: -29.828 dB

1 900.000 000 MHz

CA

Avg
16

H1d

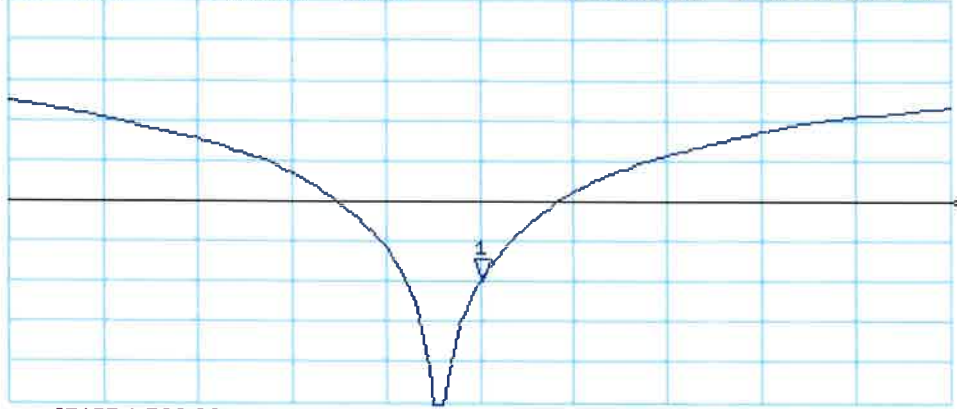

START 1 700.000 000 MHz

STOP 2 1000.000 000 MHz

DASY5 Validation Report for Body TSL

Date: 21.08.2017

Test Laboratory: SPEAG, Zurich, Switzerland

DUT: Dipole 1900 MHz; Type: D1900V2; Serial: D1900V2 - SN:5d022

Communication System: UID 0 - CW; Frequency: 1900 MHz

Medium parameters used: $f = 1900$ MHz; $\sigma = 1.48$ S/m; $\epsilon_r = 54.1$; $\rho = 1000$ kg/m³

Phantom section: Flat Section

Measurement Standard: DASY5 (IEEE/IEC/ANSI C63.19-2011)

DASY52 Configuration:

- Probe: EX3DV4 - SN7349; ConvF(8.2, 8.2, 8.2); Calibrated: 31.05.2017;
- Sensor-Surface: 1.4mm (Mechanical Surface Detection)
- Electronics: DAE4 Sn601; Calibrated: 28.03.2017
- Phantom: Flat Phantom 5.0 (back); Type: QD 000 P50 AA; Serial: 1002
- DASY52 52.10.0(1446); SEMCAD X 14.6.10(7417)

Dipole Calibration for Body Tissue/Pin=250 mW, d=10mm/Zoom Scan (7x7x7)/Cube 0:

Measurement grid: dx=5mm, dy=5mm, dz=5mm

Reference Value = 101.5 V/m; Power Drift = -0.07 dB

Peak SAR (extrapolated) = 17.2 W/kg

SAR(1 g) = 9.89 W/kg; SAR(10 g) = 5.28 W/kg

Maximum value of SAR (measured) = 14.1 W/kg

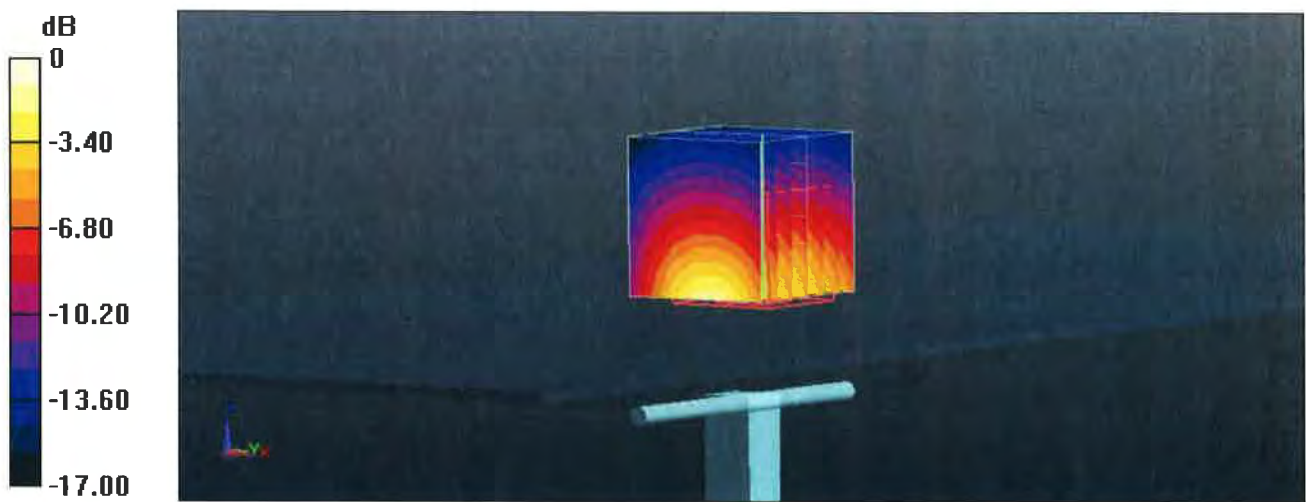

0 dB = 14.1 W/kg = 11.49 dBW/kg

Impedance Measurement Plot for Body TSL

21 Aug 2017 13:52:36

CH1 S11 1 U FS

1: 47.549 Ω 4.4961 Ω 376.62 pF

1 900.000 000 MHz

*
De1
CA

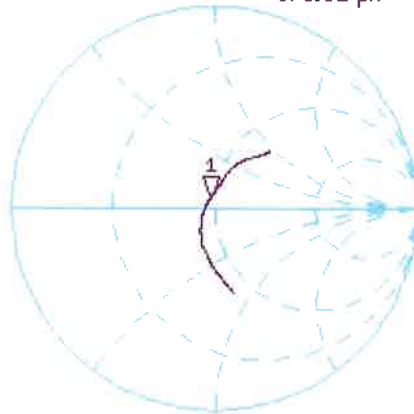

Avg
16

H1d

CH2 S11 LOG 5 dB/REF -20 dB 1:-25.612 dB 1 900.000 000 MHz

CA

Avg
16

H1d

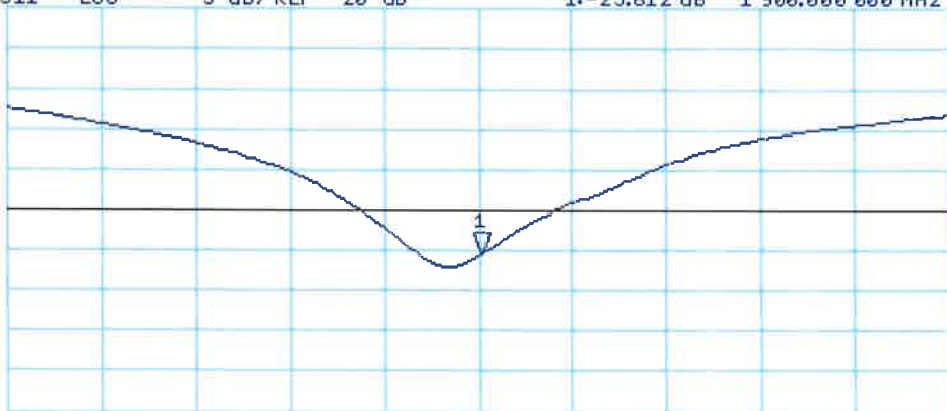

START 1 700.000 000 MHz

STOP 2 100.000 000 MHz



Accredited by the Swiss Accreditation Service (SAS)
The Swiss Accreditation Service is one of the signatories to the EA
Multilateral Agreement for the recognition of calibration certificates

Accreditation No.: **SCS 0108**

Client **B.V. ADT (Dymstec)**

Certificate No: **D2450V2-716_Aug17**

CALIBRATION CERTIFICATE

Object **D2450V2 - SN:716**

Calibration procedure(s) **QA CAL-05.v9
Calibration procedure for dipole validation kits above 700 MHz**

Calibration date: **August 17, 2017**

This calibration certificate documents the traceability to national standards, which realize the physical units of measurements (SI).
The measurements and the uncertainties with confidence probability are given on the following pages and are part of the certificate.

All calibrations have been conducted in the closed laboratory facility: environment temperature (22 ± 3)°C and humidity < 70%.

Calibration Equipment used (M&TE critical for calibration)

Primary Standards	ID #	Cal Date (Certificate No.)	Scheduled Calibration
Power meter NRP	SN: 104778	04-Apr-17 (No. 217-02521/02522)	Apr-18
Power sensor NRP-Z91	SN: 103244	04-Apr-17 (No. 217-02521)	Apr-18
Power sensor NRP-Z91	SN: 103245	04-Apr-17 (No. 217-02522)	Apr-18
Reference 20 dB Attenuator	SN: 5058 (20k)	07-Apr-17 (No. 217-02528)	Apr-18
Type-N mismatch combination	SN: 5047.2 / 06327	07-Apr-17 (No. 217-02529)	Apr-18
Reference Probe EX3DV4	SN: 7349	31-May-17 (No. EX3-7349_May17)	May-18
DAE4	SN: 601	28-Mar-17 (No. DAE4-601_Mar17)	Mar-18
Secondary Standards	ID #	Check Date (in house)	Scheduled Check
Power meter EPM-442A	SN: GB37480704	07-Oct-15 (in house check Oct-16)	In house check: Oct-18
Power sensor HP 8481A	SN: US37292783	07-Oct-15 (in house check Oct-16)	In house check: Oct-18
Power sensor HP 8481A	SN: MY41092317	07-Oct-15 (in house check Oct-16)	In house check: Oct-18
RF generator R&S SMT-06	SN: 100972	15-Jun-15 (in house check Oct-16)	In house check: Oct-18
Network Analyzer HP 8753E	SN: US37390585	18-Oct-01 (in house check Oct-16)	In house check: Oct-17

Calibrated by: **Michael Weber** **Michael Weber** **Laboratory Technician**

Approved by: **Katja Pokovic** **Katja Pokovic** **Technical Manager**

Signature

Issued: August 17, 2017

This calibration certificate shall not be reproduced except in full without written approval of the laboratory.



Accredited by the Swiss Accreditation Service (SAS)

Accreditation No.: **SCS 0108**

The Swiss Accreditation Service is one of the signatories to the EA Multilateral Agreement for the recognition of calibration certificates

Glossary:

TSL	tissue simulating liquid
ConvF	sensitivity in TSL / NORM x,y,z
N/A	not applicable or not measured

Calibration is Performed According to the Following Standards:

- IEEE Std 1528-2013, "IEEE Recommended Practice for Determining the Peak Spatial-Averaged Specific Absorption Rate (SAR) in the Human Head from Wireless Communications Devices: Measurement Techniques", June 2013
- IEC 62209-1, "Measurement procedure for the assessment of Specific Absorption Rate (SAR) from hand-held and body-mounted devices used next to the ear (frequency range of 300 MHz to 6 GHz)", July 2016
- IEC 62209-2, "Procedure to determine the Specific Absorption Rate (SAR) for wireless communication devices used in close proximity to the human body (frequency range of 30 MHz to 6 GHz)", March 2010
- KDB 865664, "SAR Measurement Requirements for 100 MHz to 6 GHz"

Additional Documentation:

- DASY4/5 System Handbook

Methods Applied and Interpretation of Parameters:

- Measurement Conditions:** Further details are available from the Validation Report at the end of the certificate. All figures stated in the certificate are valid at the frequency indicated.
- Antenna Parameters with TSL:** The dipole is mounted with the spacer to position its feed point exactly below the center marking of the flat phantom section, with the arms oriented parallel to the body axis.
- Feed Point Impedance and Return Loss:** These parameters are measured with the dipole positioned under the liquid filled phantom. The impedance stated is transformed from the measurement at the SMA connector to the feed point. The Return Loss ensures low reflected power. No uncertainty required.
- Electrical Delay:** One-way delay between the SMA connector and the antenna feed point. No uncertainty required.
- SAR measured:** SAR measured at the stated antenna input power.
- SAR normalized:** SAR as measured, normalized to an input power of 1 W at the antenna connector.
- SAR for nominal TSL parameters:** The measured TSL parameters are used to calculate the nominal SAR result.

The reported uncertainty of measurement is stated as the standard uncertainty of measurement multiplied by the coverage factor $k=2$, which for a normal distribution corresponds to a coverage probability of approximately 95%.

Measurement Conditions

DASY system configuration, as far as not given on page 1.

DASY Version	DASY5	V52.10.0
Extrapolation	Advanced Extrapolation	
Phantom	Modular Flat Phantom	
Distance Dipole Center - TSL	10 mm	with Spacer
Zoom Scan Resolution	dx, dy, dz = 5 mm	
Frequency	2450 MHz \pm 1 MHz	

Head TSL parameters

The following parameters and calculations were applied.

	Temperature	Permittivity	Conductivity
Nominal Head TSL parameters	22.0 °C	39.2	1.80 mho/m
Measured Head TSL parameters	(22.0 \pm 0.2) °C	37.8 \pm 6 %	1.86 mho/m \pm 6 %
Head TSL temperature change during test	< 0.5 °C	----	----

SAR result with Head TSL

SAR averaged over 1 cm³ (1 g) of Head TSL	Condition	
SAR measured	250 mW input power	13.3 W/kg
SAR for nominal Head TSL parameters	normalized to 1W	51.9 W/kg \pm 17.0 % (k=2)

SAR averaged over 10 cm³ (10 g) of Head TSL	condition	
SAR measured	250 mW input power	6.17 W/kg
SAR for nominal Head TSL parameters	normalized to 1W	24.3 W/kg \pm 16.5 % (k=2)

Body TSL parameters

The following parameters and calculations were applied.

	Temperature	Permittivity	Conductivity
Nominal Body TSL parameters	22.0 °C	52.7	1.95 mho/m
Measured Body TSL parameters	(22.0 \pm 0.2) °C	51.9 \pm 6 %	2.03 mho/m \pm 6 %
Body TSL temperature change during test	< 0.5 °C	----	----

SAR result with Body TSL

SAR averaged over 1 cm³ (1 g) of Body TSL	Condition	
SAR measured	250 mW input power	13.0 W/kg
SAR for nominal Body TSL parameters	normalized to 1W	50.8 W/kg \pm 17.0 % (k=2)

SAR averaged over 10 cm³ (10 g) of Body TSL	condition	
SAR measured	250 mW input power	6.05 W/kg
SAR for nominal Body TSL parameters	normalized to 1W	23.9 W/kg \pm 16.5 % (k=2)

Appendix (Additional assessments outside the scope of SCS 0108)

Antenna Parameters with Head TSL

Impedance, transformed to feed point	55.3 Ω + 3.3 j Ω
Return Loss	- 24.6 dB

Antenna Parameters with Body TSL

Impedance, transformed to feed point	51.4 Ω + 5.3 j Ω
Return Loss	- 25.4 dB

General Antenna Parameters and Design

Electrical Delay (one direction)	1.143 ns
----------------------------------	----------

After long term use with 100W radiated power, only a slight warming of the dipole near the feedpoint can be measured.

The dipole is made of standard semirigid coaxial cable. The center conductor of the feeding line is directly connected to the second arm of the dipole. The antenna is therefore short-circuited for DC-signals. On some of the dipoles, small end caps are added to the dipole arms in order to improve matching when loaded according to the position as explained in the "Measurement Conditions" paragraph. The SAR data are not affected by this change. The overall dipole length is still according to the Standard.

No excessive force must be applied to the dipole arms, because they might bend or the soldered connections near the feedpoint may be damaged.

Additional EUT Data

Manufactured by	SPEAG
Manufactured on	September 10, 2002

DASY5 Validation Report for Head TSL

Date: 17.08.2017

Test Laboratory: SPEAG, Zurich, Switzerland

DUT: Dipole 2450 MHz; Type: D2450V2; Serial: D2450V2 - SN: 716

Communication System: UID 0 - CW; Frequency: 2450 MHz

Medium parameters used: $f = 2450$ MHz; $\sigma = 1.86$ S/m; $\epsilon_r = 37.8$; $\rho = 1000$ kg/m³

Phantom section: Flat Section

Measurement Standard: DASY5 (IEEE/IEC/ANSI C63.19-2011)

DASY52 Configuration:

- Probe: EX3DV4 - SN7349; ConvF(8.12, 8.12, 8.12); Calibrated: 31.05.2017;
- Sensor-Surface: 1.4mm (Mechanical Surface Detection)
- Electronics: DAE4 Sn601; Calibrated: 28.03.2017
- Phantom: Flat Phantom 5.0 (front); Type: QD 000 P50 AA; Serial: 1001
- DASY52 52.10.0(1446); SEMCAD X 14.6.10(7417)

Dipole Calibration for Head Tissue/Pin=250 mW, d=10mm/Zoom Scan (7x7x7)/Cube 0:

Measurement grid: dx=5mm, dy=5mm, dz=5mm

Reference Value = 112.8 V/m; Power Drift = -0.06 dB

Peak SAR (extrapolated) = 26.7 W/kg

SAR(1 g) = 13.3 W/kg; SAR(10 g) = 6.17 W/kg

Maximum value of SAR (measured) = 21.1 W/kg

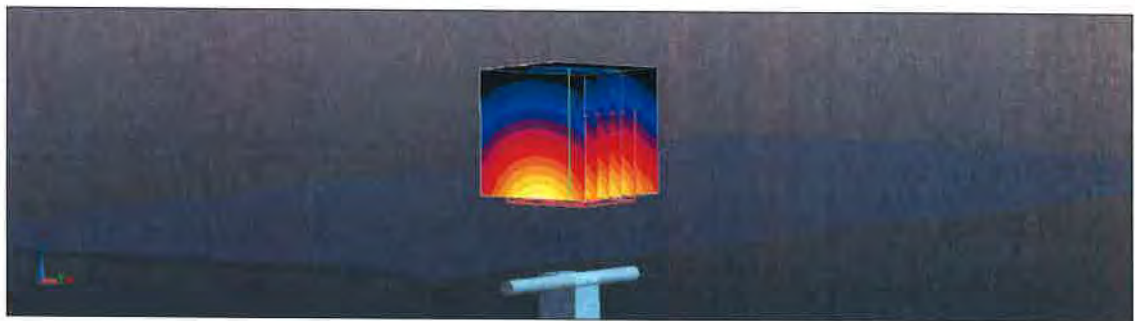
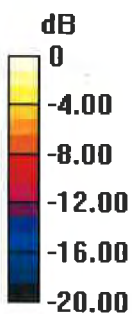

0 dB = 21.1 W/kg = 13.24 dBW/kg

Impedance Measurement Plot for Head TSL

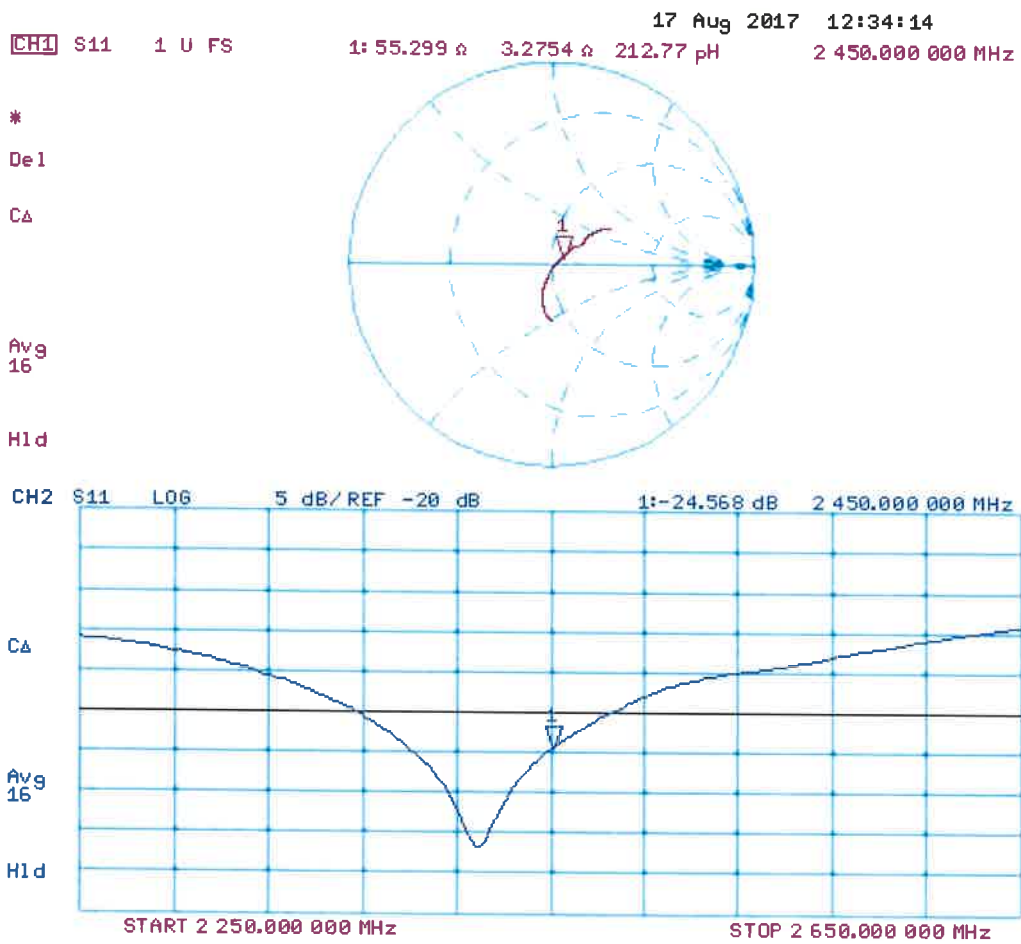

DASY5 Validation Report for Body TSL

Date: 17.08.2017

Test Laboratory: SPEAG, Zurich, Switzerland

DUT: Dipole 2450 MHz; Type: D2450V2; Serial: D2450V2 - SN: 716

Communication System: UID 0 - CW; Frequency: 2450 MHz

Medium parameters used: $f = 2450$ MHz; $\sigma = 2.03$ S/m; $\epsilon_r = 51.9$; $\rho = 1000$ kg/m³

Phantom section: Flat Section

Measurement Standard: DASY5 (IEEE/IEC/ANSI C63.19-2011)

DASY52 Configuration:

- Probe: EX3DV4 - SN7349; ConvF(8.1, 8.1, 8.1); Calibrated: 31.05.2017;
- Sensor-Surface: 1.4mm (Mechanical Surface Detection)
- Electronics: DAE4 Sn601; Calibrated: 28.03.2017
- Phantom: Flat Phantom 5.0 (back); Type: QD 000 P50 AA; Serial: 1002
- DASY52 52.10.0(1446); SEMCAD X 14.6.10(7417)

Dipole Calibration for Body Tissue/Pin=250 mW, d=10mm/Zoom Scan (7x7x7)/Cube 0:

Measurement grid: dx=5mm, dy=5mm, dz=5mm

Reference Value = 105.8 V/m; Power Drift = -0.06 dB

Peak SAR (extrapolated) = 25.4 W/kg

SAR(1 g) = 13 W/kg; SAR(10 g) = 6.05 W/kg

Maximum value of SAR (measured) = 20.3 W/kg

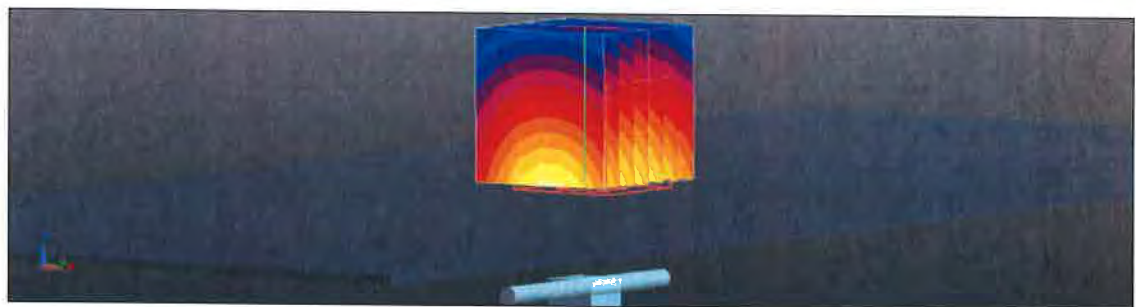
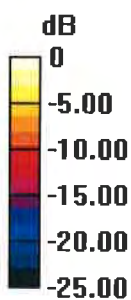

0 dB = 20.3 W/kg = 13.07 dBW/kg

Impedance Measurement Plot for Body TSL

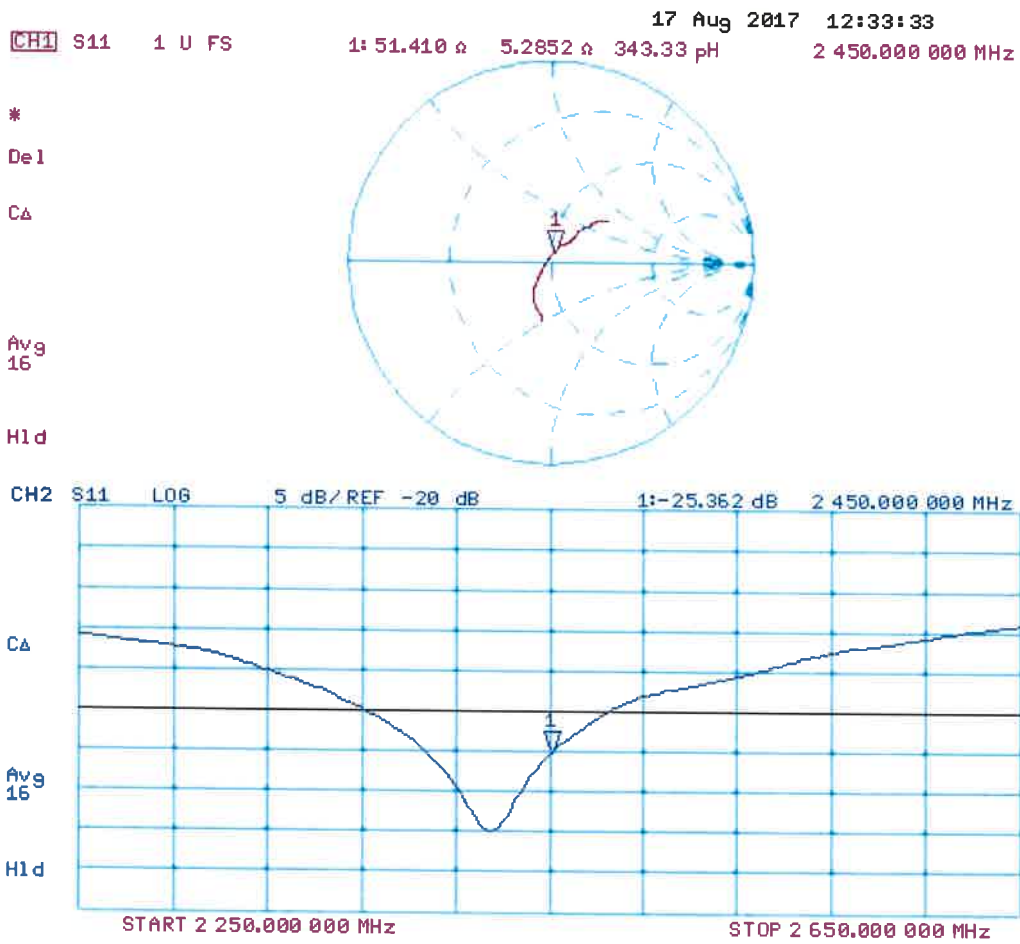

**Calibration Laboratory of
Schmid & Partner
Engineering AG**
Zeughausstrasse 43, 8004 Zurich, Switzerland



S Schweizerischer Kalibrierdienst
C Service suisse d'étalonnage
S Servizio svizzero di taratura
Swiss Calibration Service

Accredited by the Swiss Accreditation Service (SAS)
The Swiss Accreditation Service is one of the signatories to the EA
Multilateral Agreement for the recognition of calibration certificates

Accreditation No.: **SCS 0108**

Client **B.V. ADT (Dymstec)**

Certificate No: **EX3-7419_Aug17**

CALIBRATION CERTIFICATE

Object **EX3DV4 - SN:7419**

Calibration procedure(s) **QA CAL-01.v9, QA CAL-14.v4, QA CAL-23.v5, QA CAL-25.v6
Calibration procedure for dosimetric E-field probes**

Calibration date: **August 22, 2017**

This calibration certificate documents the traceability to national standards, which realize the physical units of measurements (SI).
The measurements and the uncertainties with confidence probability are given on the following pages and are part of the certificate.

All calibrations have been conducted in the closed laboratory facility: environment temperature (22 ± 3)°C and humidity < 70%.

Calibration Equipment used (M&TE critical for calibration)

Primary Standards	ID	Cal Date (Certificate No.)	Scheduled Calibration
Power meter NRP	SN: 104778	04-Apr-17 (No. 217-02521/02522)	Apr-18
Power sensor NRP-Z91	SN: 103244	04-Apr-17 (No. 217-02521)	Apr-18
Power sensor NRP-Z91	SN: 103245	04-Apr-17 (No. 217-02525)	Apr-18
Reference 20 dB Attenuator	SN: S5277 (20x)	07-Apr-17 (No. 217-02528)	Apr-18
Reference Probe ES3DV2	SN: 3013	31-Dec-16 (No. ES3-3013_Dec16)	Dec-17
DAE4	SN: 660	7-Dec-16 (No. DAE4-660_Dec16)	Dec-17
Secondary Standards	ID	Check Date (in house)	Scheduled Check
Power meter E4419B	SN: GB41293874	06-Apr-16 (in house check Jun-16)	In house check: Jun-18
Power sensor E4412A	SN: MY41498087	06-Apr-16 (in house check Jun-16)	In house check: Jun-18
Power sensor E4412A	SN: 000110210	06-Apr-16 (in house check Jun-16)	In house check: Jun-18
RF generator HP 8648C	SN: US3642U01700	04-Aug-99 (in house check Jun-16)	In house check: Jun-18
Network Analyzer HP 8753E	SN: US37390585	18-Oct-01 (in house check Oct-16)	In house check: Oct-17

Calibrated by:	Name Jeton Kastrati	Function Laboratory Technician	Signature
Approved by:	Name Katja Pokovic	Function Technical Manager	Signature

Issued: August 22, 2017

This calibration certificate shall not be reproduced except in full without written approval of the laboratory.



Accredited by the Swiss Accreditation Service (SAS)

Accreditation No.: **SCS 0108**

The Swiss Accreditation Service is one of the signatories to the EA Multilateral Agreement for the recognition of calibration certificates

Glossary:

TSL	tissue simulating liquid
NORM _{x,y,z}	sensitivity in free space
ConvF	sensitivity in TSL / NORM _{x,y,z}
DCP	diode compression point
CF	crest factor (1/duty_cycle) of the RF signal
A, B, C, D	modulation dependent linearization parameters
Polarization ϕ	ϕ rotation around probe axis
Polarization ϑ	ϑ rotation around an axis that is in the plane normal to probe axis (at measurement center), i.e., $\vartheta = 0$ is normal to probe axis
Connector Angle	information used in DASY system to align probe sensor X to the robot coordinate system

Calibration is Performed According to the Following Standards:

- IEEE Std 1528-2013, "IEEE Recommended Practice for Determining the Peak Spatial-Averaged Specific Absorption Rate (SAR) in the Human Head from Wireless Communications Devices: Measurement Techniques", June 2013
- IEC 62209-1, "Measurement procedure for the assessment of Specific Absorption Rate (SAR) from hand-held and body-mounted devices used next to the ear (frequency range of 300 MHz to 6 GHz)", July 2016
- IEC 62209-2, "Procedure to determine the Specific Absorption Rate (SAR) for wireless communication devices used in close proximity to the human body (frequency range of 30 MHz to 6 GHz)", March 2010
- KDB 865664, "SAR Measurement Requirements for 100 MHz to 6 GHz"

Methods Applied and Interpretation of Parameters:

- NORM_{x,y,z}**: Assessed for E-field polarization $\vartheta = 0$ ($f \leq 900$ MHz in TEM-cell; $f > 1800$ MHz: R22 waveguide). NORM_{x,y,z} are only intermediate values, i.e., the uncertainties of NORM_{x,y,z} does not affect the E²-field uncertainty inside TSL (see below ConvF).
- NORM(f)_{x,y,z}** = NORM_{x,y,z} * *frequency_response* (see Frequency Response Chart). This linearization is implemented in DASY4 software versions later than 4.2. The uncertainty of the frequency response is included in the stated uncertainty of ConvF.
- DCP_{x,y,z}**: DCP are numerical linearization parameters assessed based on the data of power sweep with CW signal (no uncertainty required). DCP does not depend on frequency nor media.
- PAR**: PAR is the Peak to Average Ratio that is not calibrated but determined based on the signal characteristics
- A_{x,y,z}; B_{x,y,z}; C_{x,y,z}; D_{x,y,z}; VR_{x,y,z}**: A, B, C, D are numerical linearization parameters assessed based on the data of power sweep for specific modulation signal. The parameters do not depend on frequency nor media. VR is the maximum calibration range expressed in RMS voltage across the diode.
- ConvF and Boundary Effect Parameters**: Assessed in flat phantom using E-field (or Temperature Transfer Standard for $f \leq 800$ MHz) and inside waveguide using analytical field distributions based on power measurements for $f > 800$ MHz. The same setups are used for assessment of the parameters applied for boundary compensation (alpha, depth) of which typical uncertainty values are given. These parameters are used in DASY4 software to improve probe accuracy close to the boundary. The sensitivity in TSL corresponds to NORM_{x,y,z} * ConvF whereby the uncertainty corresponds to that given for ConvF. A frequency dependent ConvF is used in DASY version 4.4 and higher which allows extending the validity from ± 50 MHz to ± 100 MHz.
- Spherical isotropy (3D deviation from isotropy)**: in a field of low gradients realized using a flat phantom exposed by a patch antenna.
- Sensor Offset**: The sensor offset corresponds to the offset of virtual measurement center from the probe tip (on probe axis). No tolerance required.
- Connector Angle**: The angle is assessed using the information gained by determining the NORM_x (no uncertainty required).

Probe EX3DV4

SN:7419

Manufactured: March 10, 2016
Calibrated: August 22, 2017

Calibrated for DASY/EASY Systems
(Note: non-compatible with DASY2 system!)

DASY/EASY - Parameters of Probe: EX3DV4 - SN:7419

Basic Calibration Parameters

	Sensor X	Sensor Y	Sensor Z	Unc (k=2)
Norm ($\mu\text{V}/(\text{V}/\text{m})^2$) ^A	0.47	0.54	0.50	± 10.1 %
DCP (mV) ^B	94.8	99.4	95.9	

Modulation Calibration Parameters

UID	Communication System Name		A dB	B dB $\sqrt{\mu\text{V}}$	C	D dB	VR mV	Unc ^E (k=2)
0	CW	X	0.0	0.0	1.0	0.00	134.9	±3.5 %
		Y	0.0	0.0	1.0		144.4	
		Z	0.0	0.0	1.0		145.7	

The reported uncertainty of measurement is stated as the standard uncertainty of measurement multiplied by the coverage factor k=2, which for a normal distribution corresponds to a coverage probability of approximately 95%.

^A The uncertainties of Norm X,Y,Z do not affect the E²-field uncertainty inside TSL (see Pages 5 and 6).

^B Numerical linearization parameter: uncertainty not required.

^E Uncertainty is determined using the max. deviation from linear response applying rectangular distribution and is expressed for the square of the field value.

DASY/EASY - Parameters of Probe: EX3DV4 - SN:7419

Calibration Parameter Determined in Head Tissue Simulating Media

f (MHz) ^C	Relative Permittivity ^F	Conductivity (S/m) ^F	ConvF X	ConvF Y	ConvF Z	Alpha ^G	Depth ^G (mm)	Unc (k=2)
750	41.9	0.89	10.05	10.05	10.05	0.52	0.80	± 12.0 %
835	41.5	0.90	9.72	9.72	9.72	0.54	0.80	± 12.0 %
900	41.5	0.97	9.49	9.49	9.49	0.34	1.05	± 12.0 %
1750	40.1	1.37	8.34	8.34	8.34	0.35	0.86	± 12.0 %
1900	40.0	1.40	8.09	8.09	8.09	0.32	0.80	± 12.0 %
1950	40.0	1.40	7.85	7.85	7.85	0.40	0.82	± 12.0 %
2000	40.0	1.40	7.86	7.86	7.86	0.36	0.80	± 12.0 %
2300	39.5	1.67	7.83	7.83	7.83	0.34	0.84	± 12.0 %
2450	39.2	1.80	7.45	7.45	7.45	0.41	0.80	± 12.0 %
2600	39.0	1.96	7.25	7.25	7.25	0.40	0.84	± 12.0 %
5200	36.0	4.66	5.37	5.37	5.37	0.35	1.80	± 13.1 %
5300	35.9	4.76	5.15	5.15	5.15	0.35	1.80	± 13.1 %
5500	35.6	4.96	4.77	4.77	4.77	0.40	1.80	± 13.1 %
5600	35.5	5.07	4.65	4.65	4.65	0.40	1.80	± 13.1 %
5800	35.3	5.27	4.78	4.78	4.78	0.40	1.80	± 13.1 %

^C Frequency validity above 300 MHz of ± 100 MHz only applies for DASY v4.4 and higher (see Page 2), else it is restricted to ± 50 MHz. The uncertainty is the RSS of the ConvF uncertainty at calibration frequency and the uncertainty for the indicated frequency band. Frequency validity below 300 MHz is ± 10, 25, 40, 50 and 70 MHz for ConvF assessments at 30, 64, 128, 150 and 220 MHz respectively. Above 5 GHz frequency validity can be extended to ± 110 MHz.

^F At frequencies below 3 GHz, the validity of tissue parameters (ϵ and σ) can be relaxed to ± 10% if liquid compensation formula is applied to measured SAR values. At frequencies above 3 GHz, the validity of tissue parameters (ϵ and σ) is restricted to ± 5%. The uncertainty is the RSS of the ConvF uncertainty for indicated target tissue parameters.

^G Alpha/Depth are determined during calibration. SPEAG warrants that the remaining deviation due to the boundary effect after compensation is always less than ± 1% for frequencies below 3 GHz and below ± 2% for frequencies between 3-6 GHz at any distance larger than half the probe tip diameter from the boundary.

DASY/EASY - Parameters of Probe: EX3DV4 - SN:7419

Calibration Parameter Determined in Body Tissue Simulating Media

f (MHz) ^C	Relative Permittivity ^F	Conductivity (S/m) ^F	ConvF X	ConvF Y	ConvF Z	Alpha ^G	Depth ^G (mm)	Unc (k=2)
750	55.5	0.96	9.91	9.91	9.91	0.53	0.81	± 12.0 %
835	55.2	0.97	9.66	9.66	9.66	0.43	0.89	± 12.0 %
900	55.0	1.05	9.61	9.61	9.61	0.46	0.80	± 12.0 %
1750	53.4	1.49	8.10	8.10	8.10	0.40	0.84	± 12.0 %
1900	53.3	1.52	7.79	7.79	7.79	0.38	0.86	± 12.0 %
1950	53.3	1.52	8.04	8.04	8.04	0.37	0.84	± 12.0 %
2000	53.3	1.52	7.98	7.98	7.98	0.36	0.80	± 12.0 %
2300	52.9	1.81	7.65	7.65	7.65	0.43	0.80	± 12.0 %
2450	52.7	1.95	7.54	7.54	7.54	0.31	0.88	± 12.0 %
2600	52.5	2.16	7.22	7.22	7.22	0.23	1.05	± 12.0 %
5200	49.0	5.30	5.04	5.04	5.04	0.40	1.90	± 13.1 %
5300	48.9	5.42	4.80	4.80	4.80	0.40	1.90	± 13.1 %
5500	48.6	5.65	4.40	4.40	4.40	0.40	1.90	± 13.1 %
5600	48.5	5.77	4.19	4.19	4.19	0.40	1.90	± 13.1 %
5800	48.2	6.00	4.46	4.46	4.46	0.40	1.90	± 13.1 %

^C Frequency validity above 300 MHz of ± 100 MHz only applies for DASY v4.4 and higher (see Page 2), else it is restricted to ± 50 MHz. The uncertainty is the RSS of the ConvF uncertainty at calibration frequency and the uncertainty for the indicated frequency band. Frequency validity below 300 MHz is ± 10, 25, 40, 50 and 70 MHz for ConvF assessments at 30, 64, 128, 150 and 220 MHz respectively. Above 5 GHz frequency validity can be extended to ± 110 MHz.

^F At frequencies below 3 GHz, the validity of tissue parameters (ϵ and σ) can be relaxed to ± 10% if liquid compensation formula is applied to measured SAR values. At frequencies above 3 GHz, the validity of tissue parameters (ϵ and σ) is restricted to ± 5%. The uncertainty is the RSS of the ConvF uncertainty for indicated target tissue parameters.

^G Alpha/Depth are determined during calibration. SPEAG warrants that the remaining deviation due to the boundary effect after compensation is always less than ± 1% for frequencies below 3 GHz and below ± 2% for frequencies between 3-6 GHz at any distance larger than half the probe tip diameter from the boundary.

Frequency Response of E-Field (TEM-Cell:ifi110 EXX, Waveguide: R22)

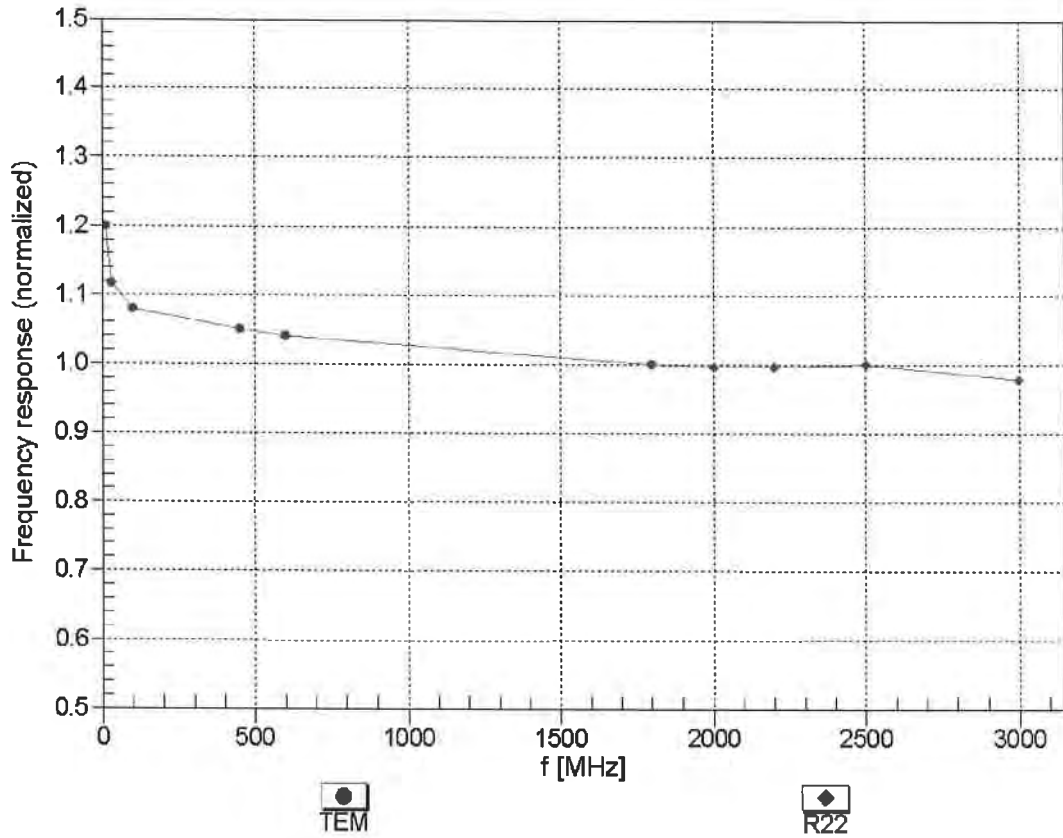

Uncertainty of Frequency Response of E-field: $\pm 6.3\%$ (k=2)

Receiving Pattern (ϕ), $\theta = 0^\circ$

f=600 MHz,TEM

f=1800 MHz,R22

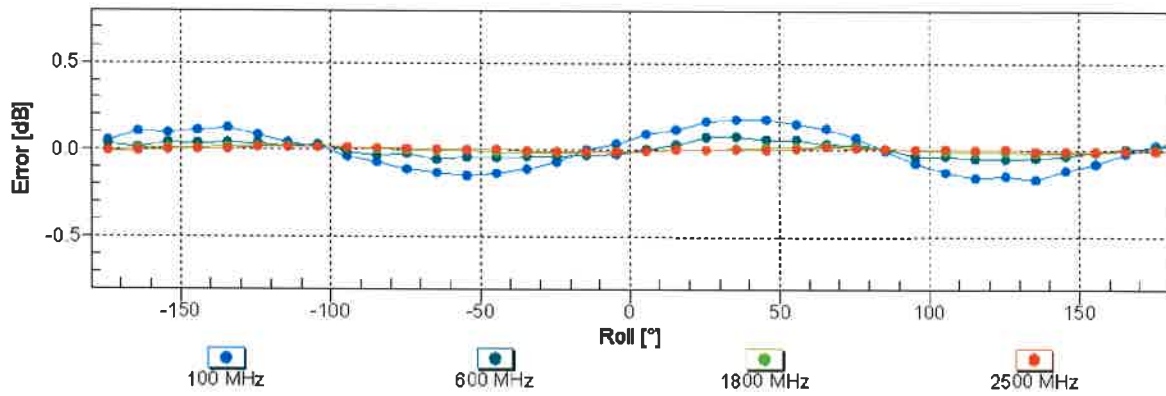
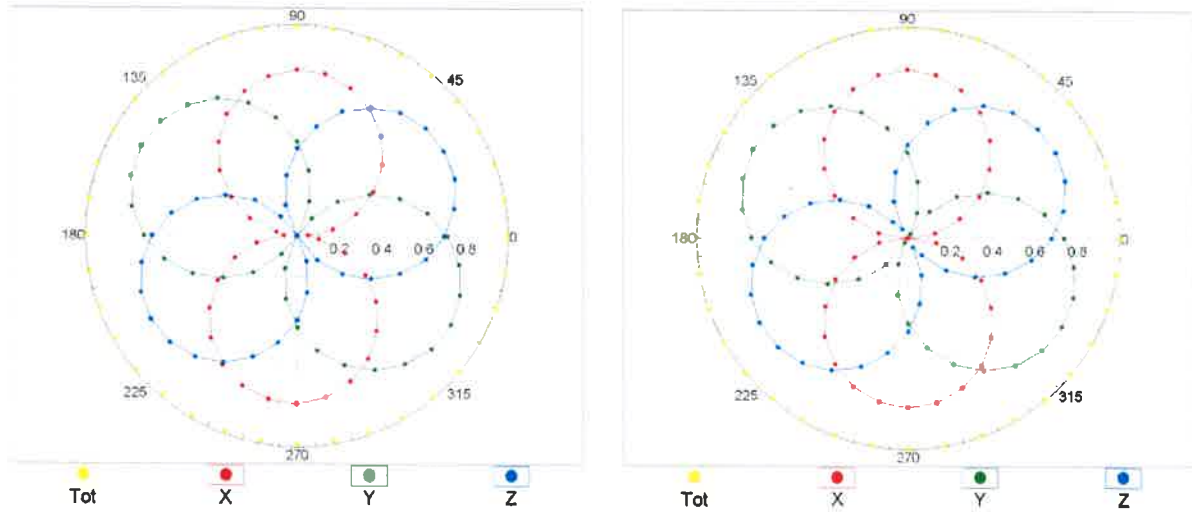

Uncertainty of Axial Isotropy Assessment: $\pm 0.5\%$ (k=2)

Dynamic Range $f(SAR_{head})$ (TEM cell , $f_{eval} = 1900$ MHz)

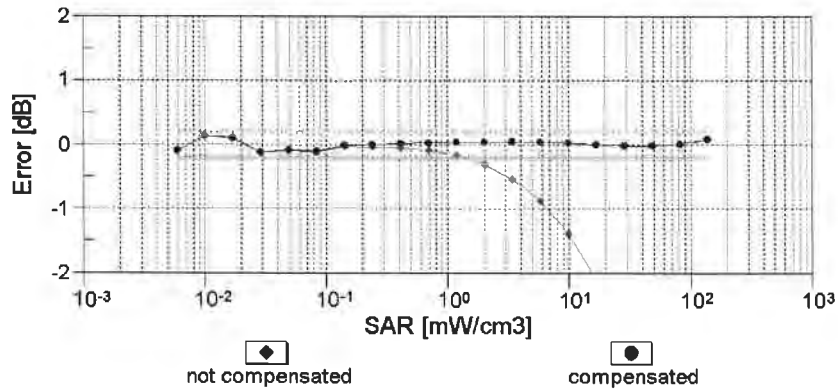
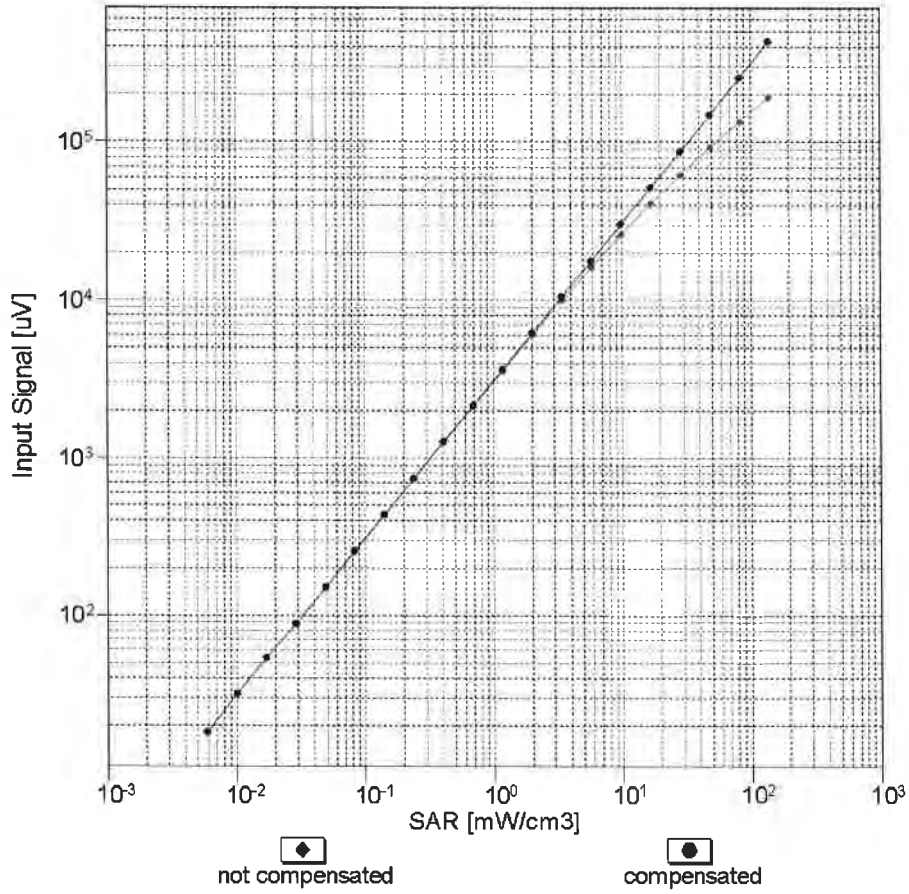

Uncertainty of Linearity Assessment: $\pm 0.6\%$ (k=2)

Conversion Factor Assessment

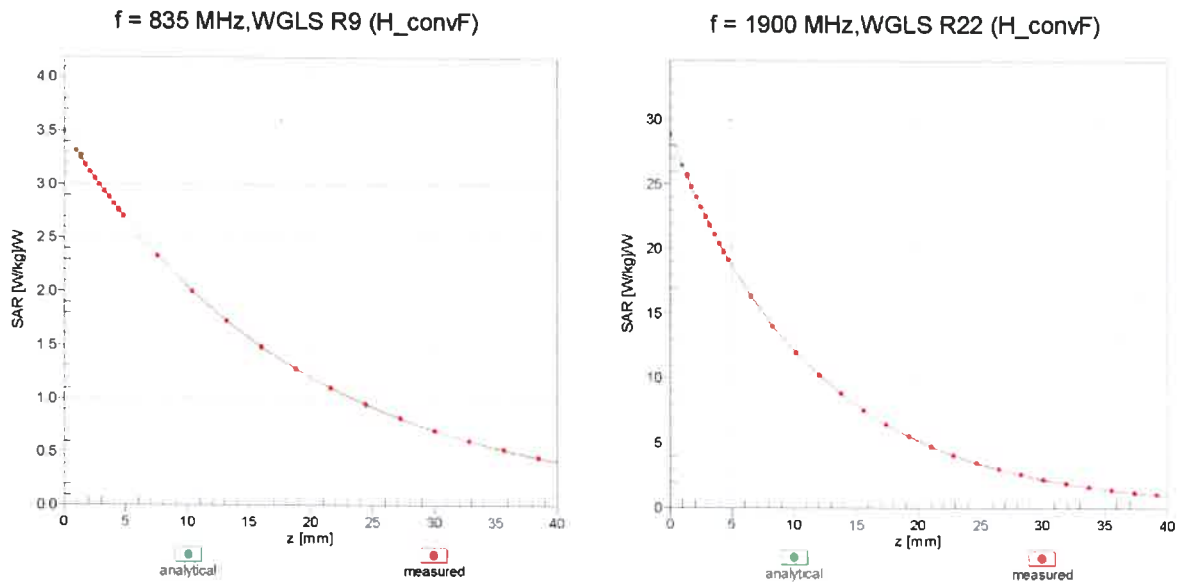

Deviation from Isotropy in Liquid Error (ϕ, θ), f = 900 MHz

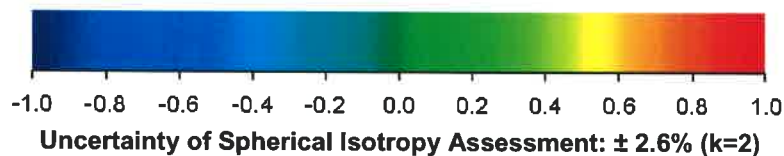
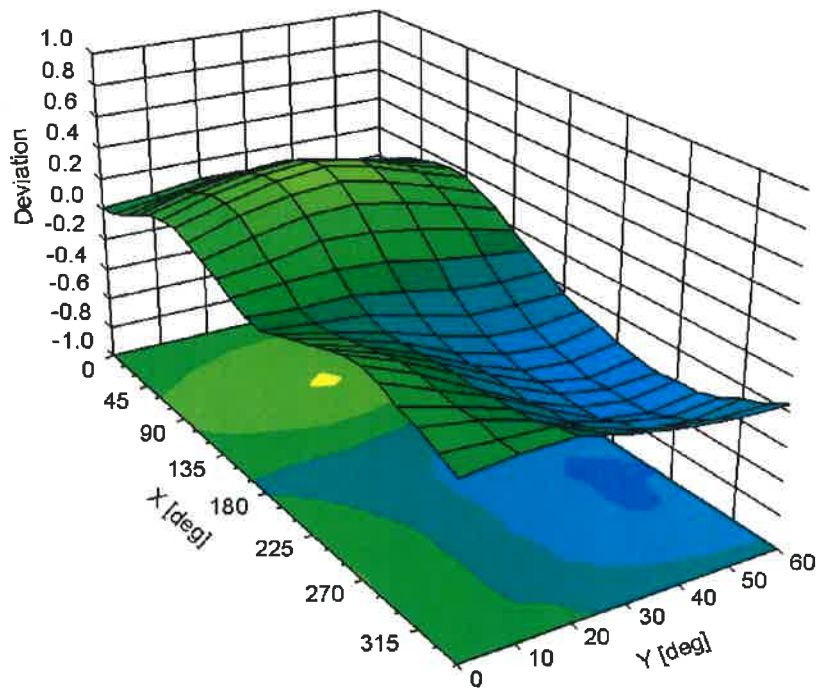

DASY/EASY - Parameters of Probe: EX3DV4 - SN:7419

Other Probe Parameters

Sensor Arrangement	Triangular
Connector Angle (°)	65.6
Mechanical Surface Detection Mode	enabled
Optical Surface Detection Mode	disabled
Probe Overall Length	337 mm
Probe Body Diameter	10 mm
Tip Length	9 mm
Tip Diameter	2.5 mm
Probe Tip to Sensor X Calibration Point	1 mm
Probe Tip to Sensor Y Calibration Point	1 mm
Probe Tip to Sensor Z Calibration Point	1 mm
Recommended Measurement Distance from Surface	1.4 mm