

## FCC Test Report

**Report No.:** RF171027C05

**FCC ID:** XHG-R871A

**Test Model:** R871

**Received Date:** Oct. 27, 2017

**Test Date:** Nov. 08, 2017 ~ Nov. 13, 2017

**Issued Date:** Nov. 20, 2017

**Applicant:** Franklin Technology Inc.

**Address:** 906 JEI Platz, 186, Gasan digital 1-ro, Geumcheon-gu, Seoul, Korea,  
(08502)

**Issued By:** Bureau Veritas Consumer Products Services (H.K.) Ltd., Taoyuan Branch

**Lab Address:** No. 47-2, 14th Ling, Chia Pau Vil., Lin Kou Dist., New Taipei City, Taiwan  
( R.O.C )

**Test Location:** No. 19, Hwa Ya 2nd Rd, Wen Hwa Tsuen, Kwei Shan Hsiang, Taoyuan  
Hsien 333, Taiwan, R.O.C.

**FCC Registration /  
Designation Number:** 788550 / TW0003



This report is for your exclusive use. Any copying or replication of this report to or for any other person or entity, or use of our name or trademark, is permitted only with our prior written permission. This report sets forth our findings solely with respect to the test samples identified herein. The results set forth in this report are not indicative or representative of the quality or characteristics of the lot from which a test sample was taken or any similar or identical product unless specifically and expressly noted. Our report includes all of the tests requested by you and the results thereof based upon the information that you provided to us. You have 60 days from date of issuance of this report to notify us of any material error or omission caused by our negligence, provided, however, that such notice shall be in writing and shall specifically address the issue you wish to raise. A failure to raise such issue within the prescribed time shall constitute your unqualified acceptance of the completeness of this report, the tests conducted and the correctness of the report contents. Unless specific mention, the uncertainty of measurement has been explicitly taken into account to declare the compliance or non-compliance to the specification.

## Table of Contents

<b>Release Control Record</b> .....	<b>4</b>
<b>1 Certificate of Conformity</b> .....	<b>5</b>
<b>2 Summary of Test Results</b> .....	<b>6</b>
2.1 Measurement Uncertainty .....	6
2.2 Modification Record .....	6
<b>3 General Information</b> .....	<b>7</b>
3.1 General Description of EUT .....	7
3.2 Description of Test Modes .....	8
3.2.1 Test Mode Applicability and Tested Channel Detail .....	9
3.3 Duty Cycle of Test Signal .....	11
3.4 Description of Support Units .....	12
3.4.1 Configuration of System under Test .....	12
3.5 General Description of Applied Standards .....	13
<b>4 Test Types and Results</b> .....	<b>14</b>
4.1 Radiated Emission and Bandedge Measurement .....	14
4.1.1 Limits of Radiated Emission and Bandedge Measurement .....	14
4.1.2 Test Instruments .....	15
4.1.3 Test Procedures .....	16
4.1.4 Deviation from Test Standard .....	16
4.1.5 Test Set Up .....	17
4.1.6 EUT Operating Conditions .....	18
4.1.7 Test Results .....	19
4.2 Conducted Emission Measurement .....	30
4.2.1 Limits of Conducted Emission Measurement .....	30
4.2.2 Test Instruments .....	30
4.2.3 Test Procedures .....	31
4.2.4 Deviation from Test Standard .....	31
4.2.5 Test Setup .....	31
4.2.6 EUT Operating Conditions .....	31
4.2.7 Test Results .....	32
4.3 6 dB Bandwidth Measurement .....	35
4.3.1 Limits of 6 dB Bandwidth Measurement .....	35
4.3.2 Test Setup .....	35
4.3.3 Test Instruments .....	36
4.3.4 Test Procedure .....	36
4.3.5 Deviation from Test Standard .....	36
4.3.6 EUT Operating Conditions .....	36
4.3.7 Test Result .....	37
4.4 Occupied Bandwidth Measurement .....	39
4.4.1 Test Setup .....	39
4.4.2 Test Instruments .....	39
4.4.3 Test Procedure .....	39
4.4.4 Deviation from Test Standard .....	39
4.4.5 EUT Operating Conditions .....	39
4.4.6 Test Results .....	40
4.5 Conducted Output Power Measurement .....	42
4.5.1 Limits of Conducted Output Power Measurement .....	42
4.5.2 Test Setup .....	42
4.5.3 Test Instruments .....	42
4.5.4 Test Procedures .....	42
4.5.5 Deviation from Test Standard .....	42
4.5.6 EUT Operating Conditions .....	42
4.5.7 Test Results .....	43

4.6	Power Spectral Density Measurement .....	44
4.6.1	Limits of Power Spectral Density Measurement.....	44
4.6.2	Test Setup.....	44
4.6.3	Test Instruments .....	44
4.6.4	Test Procedure .....	44
4.6.5	Deviation from Test Standard .....	44
4.6.6	EUT Operating Condition .....	44
4.6.7	Test Results .....	45
4.7	Conducted Out of Band Emission Measurement .....	47
4.7.1	Limits of Conducted Out of Band Emission Measurement.....	47
4.7.2	Test Setup.....	47
4.7.3	Test Instruments .....	47
4.7.4	Test Procedure .....	47
4.7.5	Deviation from Test Standard .....	47
4.7.6	EUT Operating Condition .....	47
4.7.7	Test Results .....	48
<b>5</b>	<b>Pictures of Test Arrangements.....</b>	<b>54</b>
	<b>Appendix – Information on the Testing Laboratories .....</b>	<b>55</b>

### Release Control Record

Issue No.	Description	Date Issued
RF171027C05	Original Release	Nov. 20, 2017

## 1 Certificate of Conformity

**Product:** Mobile Hotspot

**Brand:** Franklin

**Test Model:** R871

**Sample Status:** Production Unit

**Applicant:** Franklin Technology Inc.

**Test Date:** Nov. 08, 2017 ~ Nov. 13, 2017

**Standards:** 47 CFR FCC Part 15, Subpart C (Section 15.247)  
ANSI C63.10:2013

The above equipment has been tested by **Bureau Veritas Consumer Products Services (H.K.) Ltd., Taoyuan Branch**, and found compliance with the requirement of the above standards. The test record, data evaluation & Equipment Under Test (EUT) configurations represented herein are true and accurate accounts of the measurements of the sample's EMC characteristics under the conditions specified in this report.

**Prepared by :** Gina Liu, **Date:** Nov. 20, 2017  
Gina Liu / Specialist

**Approved by :** Dylan Chiou, **Date:** Nov. 20, 2017  
Dylan Chiou / Project Engineer

## 2 Summary of Test Results

47 CFR FCC Part 15, Subpart C (Section 15.247)			
FCC Clause	Test Item	Result	Remarks
15.207	AC Power Conducted Emission	Pass	Meet the requirement of limit. Minimum passing margin is -4.32 dB at 0.16953 MHz.
15.205 / 15.209 / 15.247(d)	Radiated Emissions and Band Edge Measurement	Pass	Meet the requirement of limit. Minimum passing margin is -4.0 dB at 35.82 MHz.
15.247(d)	Antenna Port Emission	Pass	Meet the requirement of limit.
15.247(a)(2)	6 dB Bandwidth	Pass	Meet the requirement of limit.
---	Occupied Bandwidth Measurement	Pass	Reference only
15.247(b)	Conducted power	Pass	Meet the requirement of limit.
15.247(e)	Power Spectral Density	Pass	Meet the requirement of limit.
15.203	Antenna Requirement	Pass	No antenna connector is used.

### 2.1 Measurement Uncertainty

Where relevant, the following measurement uncertainty levels have been estimated for tests performed on the EUT:

The listed uncertainties are the worst case uncertainty for the entire range of measurement. Please note that the uncertainty values are provided for informational purposes only and are not used in determining the PASS/FAIL results.

Measurement	Frequency	Expanded Uncertainty (k=2) (±)
Conducted Emissions at mains ports	150 kHz ~ 30 MHz	2.44 dB
Radiated Emissions up to 1 GHz	30 MHz ~ 200 MHz	2.93 dB
	200 MHz ~ 1000 MHz	2.95 dB
Radiated Emissions above 1 GHz	1 GHz ~ 18 GHz	2.26 dB
	18 GHz ~ 40 GHz	1.94 dB

### 2.2 Modification Record

There were no modifications required for compliance.

### 3 General Information

#### 3.1 General Description of EUT

<b>Product</b>	Mobile Hotspot
<b>Brand</b>	Franklin
<b>Test Model</b>	R871
<b>Status of EUT</b>	Production Unit
<b>Power Supply Rating</b>	5.0 Vdc (adapter) 3.8 Vdc (Li-ion battery)
<b>Modulation Type</b>	CCK, DQPSK, DBPSK for DSSS 64QAM, 16QAM, QPSK, BPSK for OFDM
<b>Modulation Technology</b>	DSSS, OFDM
<b>Transfer Rate</b>	802.11b: 11.0 / 5.5 / 2.0 / 1.0 Mbps 802.11g: 54.0 / 48.0 / 36.0 / 24.0 / 18.0 / 12.0 / 9.0 / 6.0 Mbps 802.11n: up to MCS7
<b>Operating Frequency</b>	2412 ~ 2462 MHz
<b>Number of Channel</b>	11 for 802.11b, 802.11g, 802.11n (HT20)
<b>Output Power</b>	97.949 mW
<b>Antenna Type</b>	PCB antenna with 3.74 dBi gain
<b>Antenna Connector</b>	N/A
<b>Accessory Device</b>	Refer to Note as below
<b>Data Cable Supplied</b>	Refer to Note as below
<b>Test Tool</b>	MP-Tool
<b>FW Version</b>	3.3-2015.0610

Note:

- The EUT provide one completed transmitter and one receiver.

Modulation Mode	Tx Function
802.11b	1TX
802.11g	1TX
802.11n (HT20)	1TX

\* The modulation and bandwidth are similar for 802.11n mode for HT20, therefore investigated worst case to representative mode in test report. (Final test mode refer section 3.2.1)

- The EUT contains following accessory devices.

Product	Brand	Model	Description
Adapter	Franklin Wireless	FWCR900TVL	I/P: 100-240 Vac, 50/60 Hz, 0.3 A O/P: 5 Vdc, 1.0 A
Battery	Franklin Wireless	R850	3.8 Vdc, 2450 mAh

- The above EUT information is declared by manufacturer and for more detailed features description, please refer to the manufacturer's specifications or user's manual.

### 3.2 Description of Test Modes

11 channels are provided for 802.11b, 802.11g and 802.11n (HT20):

Channel	Frequency (MHz)	Channel	Frequency (MHz)
1	2412	7	2442
2	2417	8	2447
3	2422	9	2452
4	2427	10	2457
5	2432	11	2462
6	2437		



### 3.2.1 Test Mode Applicability and Tested Channel Detail

EUT Configure Mode	Applicable To				Description
	RE $\geq$ 1G	RE<1G	PLC	APCM	
A	√	√	√	√	Adapter Mode
B	-	√	√	-	USB Mode

Where **RE $\geq$ 1G**: Radiated Emission above 1 GHz      **RE<1G**: Radiated Emission below 1 GHz  
**PLC**: Power Line Conducted Emission      **APCM**: Antenna Port Conducted Measurement

**NOTE:** The EUT had been pre-tested on the positioned of each 3 axis. The worst case was found when positioned on **Z-plane**.  
**NOTE:** “-” means no effect.

#### **Radiated Emission Test (Above 1 GHz):**

- Pre-Scan has been conducted to determine the worst-case mode from all possible combinations between available modulations, data rates and antenna ports (if EUT with antenna diversity architecture).
- Following channel(s) was (were) selected for the final test as listed below.

EUT Configure Mode	Mode	Available Channel	Tested Channel	Modulation Technology	Modulation Type	Data Rate (Mbps)
A	802.11b	1 to 11	1, 6, 11	DSSS	DBPSK	1.0
A	802.11g	1 to 11	1, 6, 11	OFDM	BPSK	6.0
A	802.11n (HT20)	1 to 11	1, 6, 11	OFDM	BPSK	MCS0

#### **Radiated Emission Test (Below 1 GHz):**

- Pre-Scan has been conducted to determine the worst-case mode from all possible combinations between available modulations, data rates and antenna ports (if EUT with antenna diversity architecture).
- Following channel(s) was (were) selected for the final test as listed below.

EUT Configure Mode	Mode	Available Channel	Tested Channel	Modulation Technology	Modulation Type	Data Rate (Mbps)
A	802.11g	1 to 11	11	OFDM	BPSK	6.0
B	802.11g	1 to 11	11	OFDM	BPSK	6.0

#### **Power Line Conducted Emission Test:**

- Pre-Scan has been conducted to determine the worst-case mode from all possible combinations between available modulations, data rates and antenna ports (if EUT with antenna diversity architecture).
- Following channel(s) was (were) selected for the final test as listed below.

EUT Configure Mode	Mode	Available Channel	Tested Channel	Modulation Technology	Modulation Type	Data Rate (Mbps)
A	802.11g	1 to 11	11	OFDM	BPSK	6.0
B	802.11g	1 to 11	11	OFDM	BPSK	6.0

**Bandedge Measurement:**

- Pre-Scan has been conducted to determine the worst-case mode from all possible combinations between available modulations, data rates and antenna ports (if EUT with antenna diversity architecture).
- Following channel(s) was (were) selected for the final test as listed below.

EUT Configure Mode	Mode	Available Channel	Tested Channel	Modulation Technology	Modulation Type	Data Rate (Mbps)
A	802.11b	1 to 11	1, 11	DSSS	DBPSK	1.0
A	802.11g	1 to 11	1, 11	OFDM	BPSK	6.0
A	802.11n (HT20)	1 to 11	1, 11	OFDM	BPSK	MCS0

**Antenna Port Conducted Measurement:**

- This item includes all test value of each mode, but only includes spectrum plot of worst value of each mode.
- Pre-Scan has been conducted to determine the worst-case mode from all possible combinations between available modulations, data rates and antenna ports (if EUT with antenna diversity architecture).
- Following channel(s) was (were) selected for the final test as listed below.

EUT Configure Mode	Mode	Available Channel	Tested Channel	Modulation Technology	Modulation Type	Data Rate (Mbps)
A	802.11b	1 to 11	1, 6, 11	DSSS	DBPSK	1.0
A	802.11g	1 to 11	1, 6, 11	OFDM	BPSK	6.0
A	802.11n (HT20)	1 to 11	1, 6, 11	OFDM	BPSK	MCS0

**Test Condition:**

Applicable To	Environmental Conditions	Input Power	Tested by
RE≥1G	25 deg. C, 65 % RH	120 Vac, 60 Hz	James Yang
RE<1G	25 deg. C, 65 % RH	120 Vac, 60 Hz	James Yang
PLC	25 deg. C, 65 % RH	120 Vac, 60 Hz	James Yang
APCM	25 deg. C, 65 % RH	3.8 Vdc	Gavin Wu

### 3.3 Duty Cycle of Test Signal

**802.11b:** Duty cycle of test signal is 100 %

**802.11g:** Duty cycle =  $1.307/1.389 = 0.941$ , Duty factor =  $10 * \log(1/0.941) = 0.26$

**802.11n (HT20):** Duty cycle =  $1.306/1.397 = 0.935$ , Duty factor =  $10 * \log(1/0.935) = 0.29$

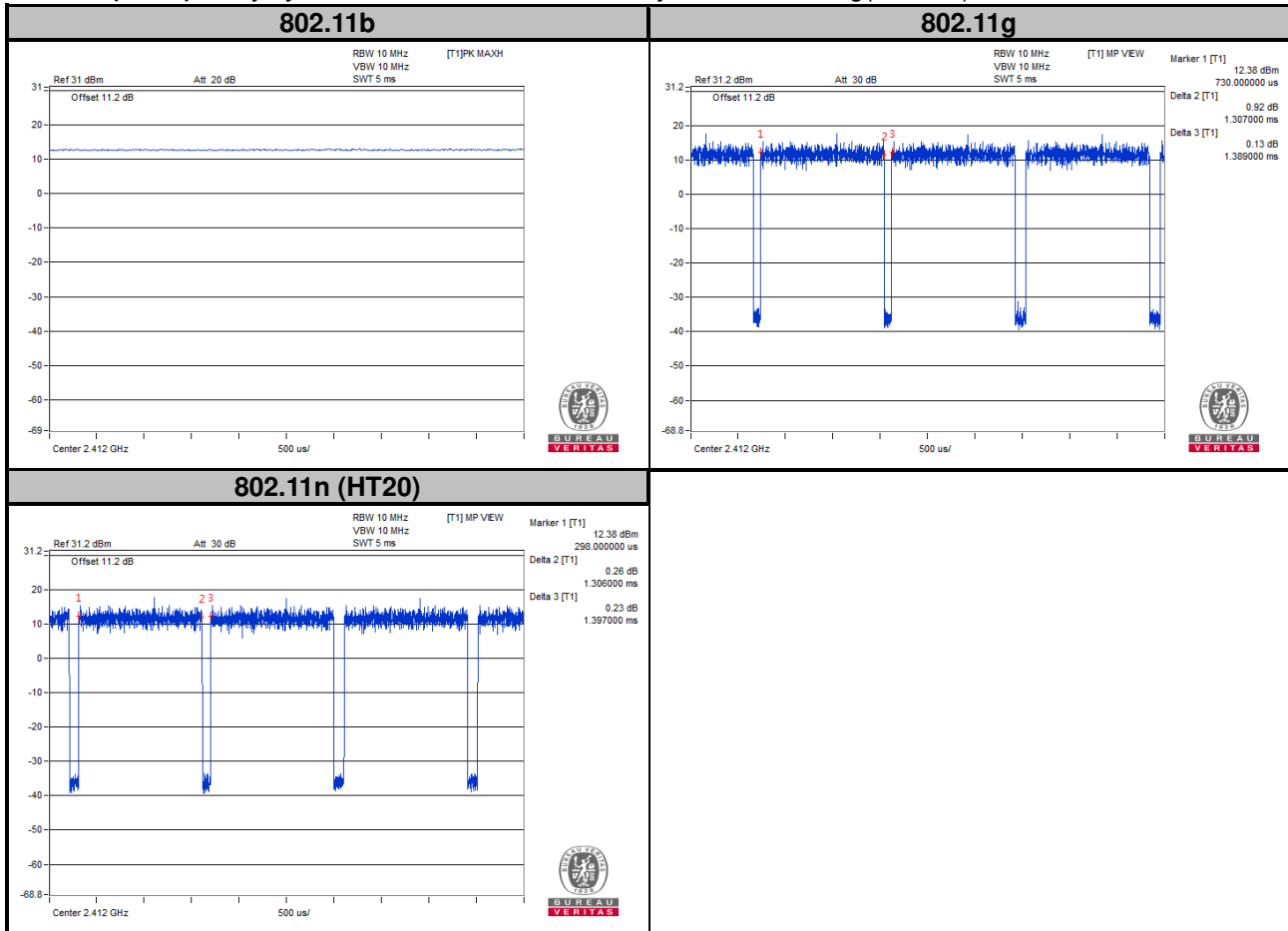

### 3.4 Description of Support Units

The EUT has been tested as an independent unit together with other necessary accessories or support units. The following support units or accessories were used to form a representative test configuration during the tests.

No.	Product	Brand	Model No.	Serial No.	FCC ID
1.	NOTEBOOK	DELL	E6440	6QLNM32	N/A
2.	PRINTER	EPSON	LQ-300+	DCGY054103	FCC DoC Approved

No.	Signal Cable Description Of The Above Support Units
1.	N/A
2.	1.8m shielded cable

Note:

1. All power cords of the above support units are non-shielded (1.8m).
2. Items 1 acted as communication partners to transfer data.

#### 3.4.1 Configuration of System under Test

##### Adapter Mode

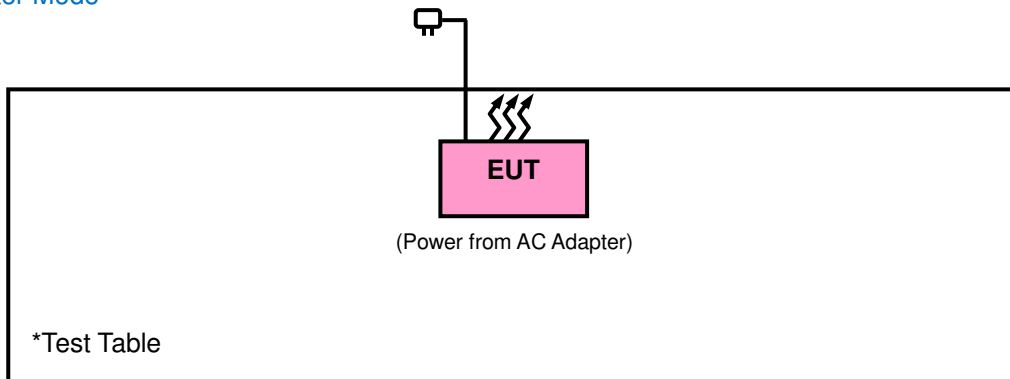

##### USB Mode

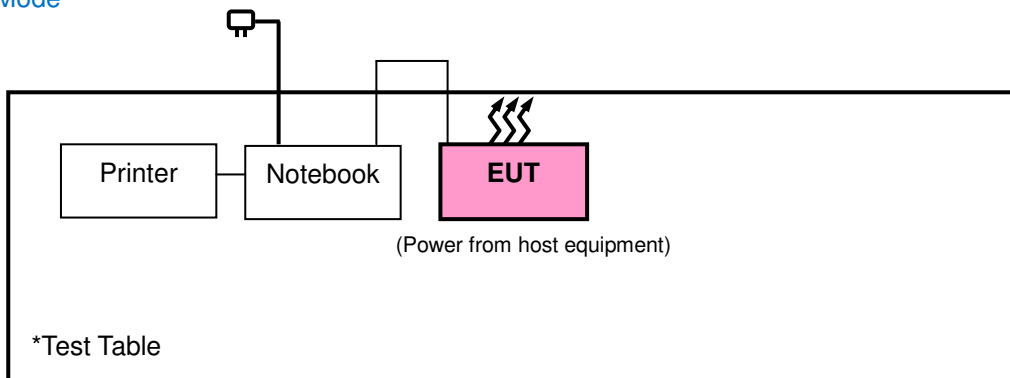

### 3.5 General Description of Applied Standards

The EUT is a RF Product. According to the specifications of the manufacturer, it must comply with the requirements of the following standards:

**FCC Part 15, Subpart C (15.247)**  
**558074 D01 DTS Meas Guidance v04**  
ANSI C63.10-2013

All test items have been performed and recorded as per the above standards.

**NOTE:** The EUT has been verified to comply with the requirements of FCC Part 15, Subpart B, Class B (DoC).  
The test report has been issued separately.

## 4 Test Types and Results

### 4.1 Radiated Emission and Bandedge Measurement

#### 4.1.1 Limits of Radiated Emission and Bandedge Measurement

Radiated emissions which fall in the restricted bands must comply with the radiated emission limits specified as below table. Other emissions shall be at least 20 dB below the highest level of the desired power:

Frequencies (MHz)	Field Strength (microvolts/meter)	Measurement Distance (meters)
0.009 ~ 0.490	2400/F (kHz)	300
0.490 ~ 1.705	24000/F (kHz)	30
1.705 ~ 30.0	30	30
30 ~ 88	100	3
88 ~ 216	150	3
216 ~ 960	200	3
Above 960	500	3

**NOTE:**

1. The lower limit shall apply at the transition frequencies.
2. Emission level (dBuV/m) = 20 log Emission level (uV/m).
3. For frequencies above 1000 MHz, the field strength limits are based on average detector, however, the peak field strength of any emission shall not exceed the maximum permitted average limits, specified above by more than 20 dB under any condition of modulation.

## 4.1.2 Test Instruments

Description & Manufacturer	Model No.	Serial No.	Date of Calibration	Due Date of Calibration
Test Receiver Agilent	N9038A	MY51210203	Feb. 17, 2017	Feb. 16, 2018
Spectrum Analyzer Agilent	N9010A	MY52220314	Dec. 16, 2016	Dec. 15, 2017
Spectrum Analyzer ROHDE & SCHWARZ	FSU43	101261	Dec. 13, 2016	Dec. 12, 2017
BILOG Antenna SCHWARZBECK	VULB9168	9168-472	Dec. 26, 2016	Dec. 27, 2017
HORN Antenna SCHWARZBECK	BBHA 9120 D	9120D-969	Dec. 12, 2016	Dec. 13, 2017
HORN Antenna SCHWARZBECK	BBHA 9170	9170-480	Dec. 14, 2016	Dec. 13, 2017
Fixed Attenuator Mini-Circuits	MDCS18N-10	MDCS18N-10-01	Apr. 17, 2017	Apr. 16, 2018
Loop Antenna	HLA 6121	45745	May 19, 2017	May 18, 2018
Preamplifier EMCI	EMC001340	980201	Nov. 01, 2017	Oct. 31, 2018
Bluetooth Tester	CBT	100946	Jul. 29, 2016	Jul. 28, 2018
Preamplifier EMCI	EMC 012645	980115	Oct. 20, 2017	Oct. 18, 2018
Preamplifier EMCI	EMC 184045	980116	Oct. 20, 2017	Oct. 18, 2018
Preamplifier EMCI	EMC 330H	980112	Oct. 13, 2017	Oct. 12, 2018
Power Meter Anritsu	ML2495A	1012010	Aug. 15, 2017	Aug. 14, 2018
Power Sensor Anritsu	MA2411B	1315050	Aug. 15, 2017	Aug. 14, 2018
RF signal cable HUBER+SUHNNER	SUCOFLEX 104	EMC104-SM-SM-1000(140807)	Oct. 20, 2017	Oct. 19, 2018
RF signal cable HUBER+SUHNNER	SUCOFLEX 104	140811+170717	Oct. 20, 2017	Oct. 19, 2018
RF Coaxial Cable Worken	8D-FB	Cable-Ch10-01	Oct. 20, 2017	Oct. 19, 2018
Software BV ADT	E3 6.120103	NA	NA	NA
Antenna Tower MF	MFA-440H	NA	NA	NA
Turn Table MF	MFT-201SS	NA	NA	NA
Antenna Tower & Turn Table Controller MF	MF-7802	NA	NA	NA

- Note: 1. The calibration interval of the above test instruments is 12 months and the calibrations are traceable to NML/ROC and NIST/USA.
2. The test was performed in HwaYa Chamber 10.
3. The horn antenna and preamplifier (model: EMC 184045) are used only for the measurement of emission frequency above 1 GHz if tested.
5. The FCC Site Registration No. is 690701.
4. The IC Site Registration No. is IC7450F-10.

#### 4.1.3 Test Procedures

- a. The EUT was placed on the top of a rotating table 0.8 meters (for below 1 GHz) / 1.5 meters (for above 1 GHz) above the ground at 3 meter chamber room for test. The table was rotated 360 degrees to determine the position of the highest radiation.
- b. The EUT was set 3 meters away from the interference-receiving antenna, which was mounted on the top of a variable-height antenna tower.
- c. The height of antenna is varied from one meter to four meters above the ground to determine the maximum value of the field strength. Both horizontal and vertical polarizations of the antenna are set to make the measurement.
- d. For each suspected emission, the EUT was arranged to its worst case and then the antenna was tuned to heights from 1 meter to 4 meters and the rotatable table was turned from 0 degrees to 360 degrees to find the maximum reading.
- e. The test-receiver system was set to quasi-peak detect function and specified bandwidth with maximum hold mode when the test frequency is below 1 GHz.
- f. The test-receiver system was set to peak and average detected function and specified bandwidth with maximum hold mode when the test frequency is above 1 GHz. If the peak reading value also meets average limit, measurement with the average detector is unnecessary.

**Note:**

1. The resolution bandwidth and video bandwidth of test receiver/spectrum analyzer is 120 kHz & 360 KHz for Quasi-peak detection (QP) at frequency below 1 GHz.
2. The resolution bandwidth of test receiver/spectrum analyzer is 1 MHz and the video bandwidth is 3 MHz for Peak detection (PK) at frequency above 1 GHz.
3. The resolution bandwidth of test receiver/spectrum analyzer is 1 MHz and the video bandwidth is 1/T for Average (Duty cycle < 98 %) detection at frequency above 1 GHz.
4. The resolution bandwidth of test receiver/spectrum analyzer is 1 MHz and the video bandwidth is 10 Hz (Duty cycle  $\geq$  98 %) for Average detection (AV) at frequency above 1 GHz.
5. All modes of operation were investigated and the worst-case emissions are reported.

#### 4.1.4 Deviation from Test Standard

No deviation.



4.1.5 Test Set Up

<Radiated emission below 30 MHz>

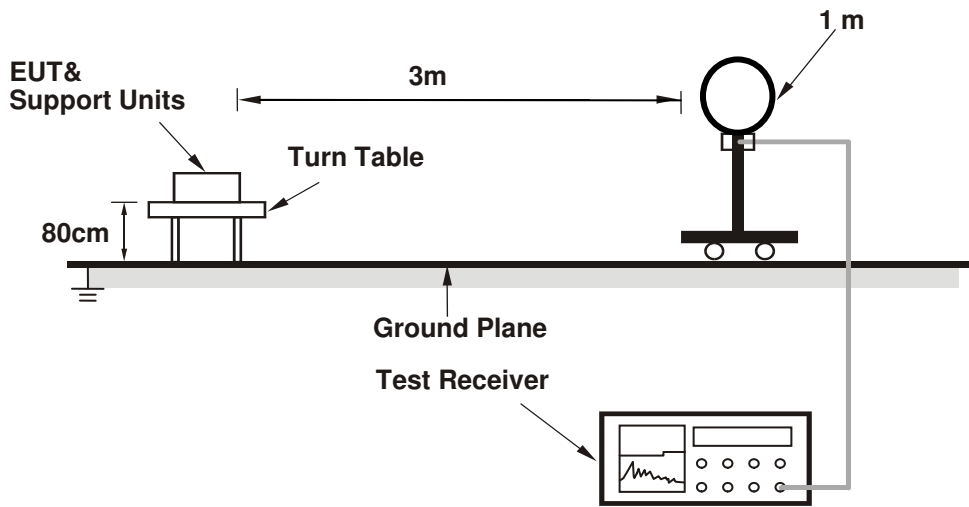

<Frequency Range below 1 GHz>

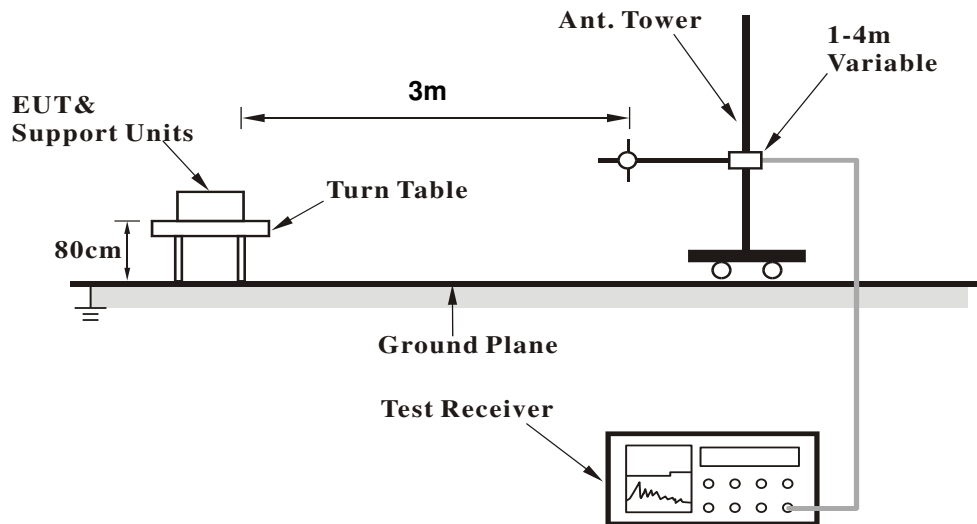

**<Frequency Range above 1 GHz>**

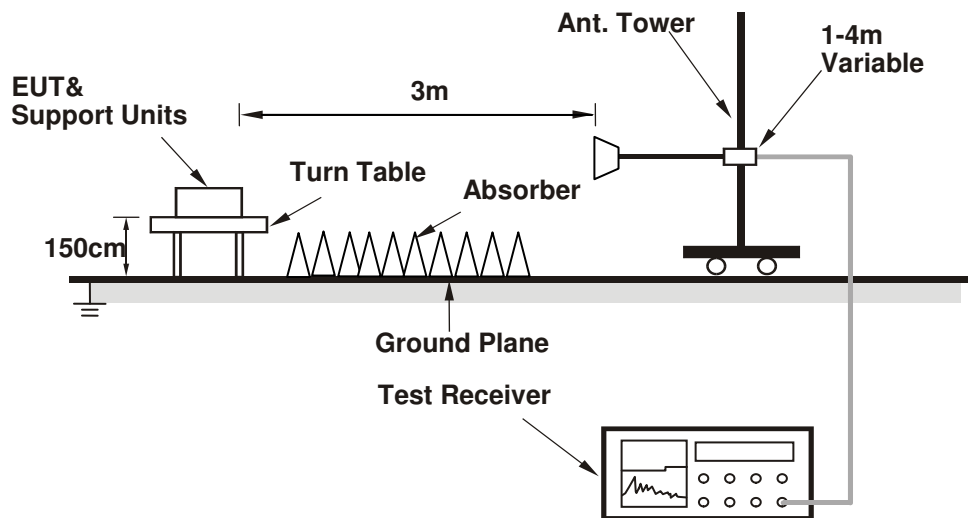

For the actual test configuration, please refer to the attached file (Test Setup Photo).

**4.1.6 EUT Operating Conditions**

- a. Placed the EUT on a testing table.
- b. Use the software to control the EUT under transmission condition continuously at specific channel frequency.

4.1.7 Test Results

**ABOVE 1GHz DATA**

**802.11b**

<b>CHANNEL</b>	TX Channel 1	<b>DETECTOR FUNCTION</b>	Peak (PK)
<b>FREQUENCY RANGE</b>	1GHz ~ 25GHz		Average (AV)

**ANTENNA POLARITY & TEST DISTANCE: HORIZONTAL AT 3 M**

NO.	FREQ. (MHz)	EMISSION LEVEL (dBuV/m)	LIMIT (dBuV/m)	MARGIN (dB)	ANTENNA HEIGHT (m)	TABLE ANGLE (Degree)	RAW VALUE (dBuV)	CORRECTION FACTOR (dB/m)
1	2390.00	56.4 PK	74.0	-17.6	1.00 H	360	23.00	33.40
2	2390.00	45.1 AV	54.0	-8.9	1.00 H	360	11.70	33.40
3	*2412.00	95.3 PK			3.95 H	186	61.80	33.50
4	*2412.00	91.6 AV			3.95 H	186	58.10	33.50
5	4824.00	50.8 PK	74.0	-23.2	2.09 H	188	47.10	3.70
6	4824.00	45.1 AV	54.0	-8.9	2.09 H	188	41.40	3.70

**ANTENNA POLARITY & TEST DISTANCE: VERTICAL AT 3 M**

NO.	FREQ. (MHz)	EMISSION LEVEL (dBuV/m)	LIMIT (dBuV/m)	MARGIN (dB)	ANTENNA HEIGHT (m)	TABLE ANGLE (Degree)	RAW VALUE (dBuV)	CORRECTION FACTOR (dB/m)
1	2390.00	57.2 PK	74.0	-16.8	1.00 V	50	23.80	33.40
2	2390.00	45.0 AV	54.0	-9.0	1.00 V	50	11.60	33.40
3	*2412.00	100.3 PK			2.81 V	271	66.80	33.50
4	*2412.00	96.5 AV			2.81 V	271	63.00	33.50
5	4824.00	50.6 PK	74.0	-23.4	1.59 V	181	46.90	3.70
6	4824.00	44.6 AV	54.0	-9.4	1.59 V	181	40.90	3.70

**REMARKS:**

1. Emission Level(dBuV/m) = Raw Value(dBuV) + Correction Factor(dB/m)
2. Correction Factor(dB/m) = Antenna Factor(dB/m) + Cable Factor(dB) – Pre-Amplifier Factor(dB)
3. The other emission levels were very low against the limit.
4. Margin value = Emission Level – Limit value
5. " \* ": Fundamental frequency.

<b>CHANNEL</b>	TX Channel 6	<b>DETECTOR FUNCTION</b>	Peak (PK)
<b>FREQUENCY RANGE</b>	1GHz ~ 25GHz		Average (AV)

**ANTENNA POLARITY & TEST DISTANCE: HORIZONTAL AT 3 M**

NO.	FREQ. (MHz)	EMISSION LEVEL (dBuV/m)	LIMIT (dBuV/m)	MARGIN (dB)	ANTENNA HEIGHT (m)	TABLE ANGLE (Degree)	RAW VALUE (dBuV)	CORRECTION FACTOR (dB/m)
1	*2437.00	90.7 PK			1.00 H	37	57.10	33.60
2	*2437.00	86.8 AV			1.00 H	37	53.20	33.60
3	4874.00	47.6 PK	74.0	-26.4	1.00 H	192	43.70	3.90
4	4874.00	38.7 AV	54.0	-15.3	1.00 H	192	34.80	3.90

**ANTENNA POLARITY & TEST DISTANCE: VERTICAL AT 3 M**

NO.	FREQ. (MHz)	EMISSION LEVEL (dBuV/m)	LIMIT (dBuV/m)	MARGIN (dB)	ANTENNA HEIGHT (m)	TABLE ANGLE (Degree)	RAW VALUE (dBuV)	CORRECTION FACTOR (dB/m)
1	*2437.00	98.9 PK			3.32 V	268	65.30	33.60
2	*2437.00	95.0 AV			3.32 V	268	61.40	33.60
3	4874.00	50.0 PK	74.0	-24.0	1.97 V	178	46.10	3.90
4	4874.00	43.2 AV	54.0	-10.8	1.97 V	178	39.30	3.90

**REMARKS:**

1. Emission Level(dBuV/m) = Raw Value(dBuV) + Correction Factor(dB/m)
2. Correction Factor(dB/m) = Antenna Factor(dB/m) + Cable Factor(dB) – Pre-Amplifier Factor(dB)
3. The other emission levels were very low against the limit.
4. Margin value = Emission Level – Limit value
5. " \* ": Fundamental frequency.

<b>CHANNEL</b>	TX Channel 11	<b>DETECTOR FUNCTION</b>	Peak (PK)
<b>FREQUENCY RANGE</b>	1GHz ~ 25GHz		Average (AV)

**ANTENNA POLARITY & TEST DISTANCE: HORIZONTAL AT 3 M**

NO.	FREQ. (MHz)	EMISSION LEVEL (dBuV/m)	LIMIT (dBuV/m)	MARGIN (dB)	ANTENNA HEIGHT (m)	TABLE ANGLE (Degree)	RAW VALUE (dBuV)	CORRECTION FACTOR (dB/m)
1	*2462.00	95.7 PK			3.54 H	17	61.90	33.80
2	*2462.00	91.7 AV			3.54 H	17	57.90	33.80
3	2483.50	57.1 PK	74.0	-16.9	1.10 H	25	23.20	33.90
4	2483.50	45.7 AV	54.0	-8.3	1.10 H	25	11.80	33.90
5	4924.00	47.0 PK	74.0	-27.0	1.25 H	190	43.00	4.00
6	4924.00	36.4 AV	54.0	-17.6	1.25 H	190	32.40	4.00

**ANTENNA POLARITY & TEST DISTANCE: VERTICAL AT 3 M**

NO.	FREQ. (MHz)	EMISSION LEVEL (dBuV/m)	LIMIT (dBuV/m)	MARGIN (dB)	ANTENNA HEIGHT (m)	TABLE ANGLE (Degree)	RAW VALUE (dBuV)	CORRECTION FACTOR (dB/m)
1	*2462.00	98.2 PK			2.98 V	268	64.40	33.80
2	*2462.00	94.4 AV			2.98 V	268	60.60	33.80
3	2483.50	58.2 PK	74.0	-15.8	1.00 V	10	24.30	33.90
4	2483.50	45.7 AV	54.0	-8.3	1.00 V	10	11.80	33.90
5	4924.00	46.8 PK	74.0	-27.2	1.00 V	213	42.80	4.00
6	4924.00	35.7 AV	54.0	-18.3	1.00 V	213	31.70	4.00

**REMARKS:**

1. Emission Level(dBuV/m) = Raw Value(dBuV) + Correction Factor(dB/m)
2. Correction Factor(dB/m) = Antenna Factor(dB/m) + Cable Factor(dB) – Pre-Amplifier Factor(dB)
3. The other emission levels were very low against the limit.
4. Margin value = Emission Level – Limit value
5. " \* ": Fundamental frequency.

802.11g

<b>CHANNEL</b>	TX Channel 1	<b>DETECTOR FUNCTION</b>	Peak (PK)
<b>FREQUENCY RANGE</b>	1GHz ~ 25GHz		Average (AV)

ANTENNA POLARITY & TEST DISTANCE: HORIZONTAL AT 3 M								
NO.	FREQ. (MHz)	EMISSION LEVEL (dBuV/m)	LIMIT (dBuV/m)	MARGIN (dB)	ANTENNA HEIGHT (m)	TABLE ANGLE (Degree)	RAW VALUE (dBuV)	CORRECTION FACTOR (dB/m)
1	2390.00	57.8 PK	74.0	-16.2	3.41 H	150	24.40	33.40
2	2390.00	45.5 AV	54.0	-8.5	3.41 H	150	12.10	33.40
3	*2412.00	95.4 PK			3.47 H	144	61.90	33.50
4	*2412.00	85.4 AV			3.47 H	144	51.90	33.50
5	4824.00	47.5 PK	74.0	-26.5	1.64 H	289	43.80	3.70
6	4824.00	35.8 AV	54.0	-18.2	1.64 H	289	32.10	3.70

ANTENNA POLARITY & TEST DISTANCE: VERTICAL AT 3 M								
NO.	FREQ. (MHz)	EMISSION LEVEL (dBuV/m)	LIMIT (dBuV/m)	MARGIN (dB)	ANTENNA HEIGHT (m)	TABLE ANGLE (Degree)	RAW VALUE (dBuV)	CORRECTION FACTOR (dB/m)
1	2390.00	57.3 PK	74.0	-16.7	3.84 V	265	23.90	33.40
2	2390.00	45.6 AV	54.0	-8.4	3.84 V	265	12.20	33.40
3	*2412.00	101.3 PK			3.82 V	261	67.80	33.50
4	*2412.00	91.7 AV			3.82 V	261	58.20	33.50
5	4824.00	47.0 PK	74.0	-27.0	2.15 V	230	43.30	3.70
6	4824.00	35.5 AV	54.0	-18.5	2.15 V	230	31.80	3.70

**REMARKS:**

1. Emission Level(dBuV/m) = Raw Value(dBuV) + Correction Factor(dB/m)
2. Correction Factor(dB/m) = Antenna Factor(dB/m) + Cable Factor(dB) – Pre-Amplifier Factor(dB)
3. The other emission levels were very low against the limit.
4. Margin value = Emission Level – Limit value
5. " \* ": Fundamental frequency.

<b>CHANNEL</b>	TX Channel 6	<b>DETECTOR FUNCTION</b>	Peak (PK)
<b>FREQUENCY RANGE</b>	1GHz ~ 25GHz		Average (AV)

**ANTENNA POLARITY & TEST DISTANCE: HORIZONTAL AT 3 M**

NO.	FREQ. (MHz)	EMISSION LEVEL (dBuV/m)	LIMIT (dBuV/m)	MARGIN (dB)	ANTENNA HEIGHT (m)	TABLE ANGLE (Degree)	RAW VALUE (dBuV)	CORRECTION FACTOR (dB/m)
1	*2437.00	95.6 PK			3.40 H	141	62.00	33.60
2	*2437.00	86.5 AV			3.40 H	141	52.90	33.60
3	4874.00	46.6 PK	74.0	-27.4	2.68 H	142	42.70	3.90
4	4874.00	33.7 AV	54.0	-20.3	2.68 H	142	29.80	3.90

**ANTENNA POLARITY & TEST DISTANCE: VERTICAL AT 3 M**

NO.	FREQ. (MHz)	EMISSION LEVEL (dBuV/m)	LIMIT (dBuV/m)	MARGIN (dB)	ANTENNA HEIGHT (m)	TABLE ANGLE (Degree)	RAW VALUE (dBuV)	CORRECTION FACTOR (dB/m)
1	*2437.00	100.4 PK			3.68 V	254	66.80	33.60
2	*2437.00	91.2 AV			3.68 V	254	57.60	33.60
3	4874.00	47.0 PK	74.0	-27.0	1.83 V	172	43.10	3.90
4	4874.00	33.5 AV	54.0	-20.5	1.83 V	172	29.60	3.90

**REMARKS:**

1. Emission Level(dBuV/m) = Raw Value(dBuV) + Correction Factor(dB/m)
2. Correction Factor(dB/m) = Antenna Factor(dB/m) + Cable Factor(dB) – Pre-Amplifier Factor(dB)
3. The other emission levels were very low against the limit.
4. Margin value = Emission Level – Limit value
5. " \* ": Fundamental frequency.

<b>CHANNEL</b>	TX Channel 11	<b>DETECTOR FUNCTION</b>	Peak (PK)
<b>FREQUENCY RANGE</b>	1GHz ~ 25GHz		Average (AV)

**ANTENNA POLARITY & TEST DISTANCE: HORIZONTAL AT 3 M**

NO.	FREQ. (MHz)	EMISSION LEVEL (dBuV/m)	LIMIT (dBuV/m)	MARGIN (dB)	ANTENNA HEIGHT (m)	TABLE ANGLE (Degree)	RAW VALUE (dBuV)	CORRECTION FACTOR (dB/m)
1	*2462.00	94.0 PK			3.35 H	141	60.20	33.80
2	*2462.00	85.1 AV			3.35 H	141	51.30	33.80
3	2483.50	57.8 PK	74.0	-16.2	3.37 H	134	23.90	33.90
4	2483.50	45.9 AV	54.0	-8.1	3.37 H	134	12.00	33.90
5	4924.00	46.5 PK	74.0	-27.5	1.54 H	169	42.50	4.00
6	4924.00	34.3 AV	54.0	-19.7	1.54 H	169	30.30	4.00

**ANTENNA POLARITY & TEST DISTANCE: VERTICAL AT 3 M**

NO.	FREQ. (MHz)	EMISSION LEVEL (dBuV/m)	LIMIT (dBuV/m)	MARGIN (dB)	ANTENNA HEIGHT (m)	TABLE ANGLE (Degree)	RAW VALUE (dBuV)	CORRECTION FACTOR (dB/m)
1	*2462.00	99.0 PK			3.66 V	255	65.20	33.80
2	*2462.00	90.0 AV			3.66 V	255	56.20	33.80
3	2483.50	58.6 PK	74.0	-15.4	3.60 V	249	24.70	33.90
4	2483.50	46.2 AV	54.0	-7.8	3.60 V	249	12.30	33.90
5	4924.00	47.8 PK	74.0	-26.2	1.73 V	64	43.80	4.00
6	4924.00	33.5 AV	54.0	-20.5	1.73 V	64	29.50	4.00

**REMARKS:**

1. Emission Level(dBuV/m) = Raw Value(dBuV) + Correction Factor(dB/m)
2. Correction Factor(dB/m) = Antenna Factor(dB/m) + Cable Factor(dB) – Pre-Amplifier Factor(dB)
3. The other emission levels were very low against the limit.
4. Margin value = Emission Level – Limit value
5. " \* ": Fundamental frequency.



802.11n (20MHz)

<b>CHANNEL</b>	TX Channel 1	<b>DETECTOR FUNCTION</b>	Peak (PK)
<b>FREQUENCY RANGE</b>	1GHz ~ 25GHz		Average (AV)

**ANTENNA POLARITY & TEST DISTANCE: HORIZONTAL AT 3 M**

NO.	FREQ. (MHz)	EMISSION LEVEL (dBuV/m)	LIMIT (dBuV/m)	MARGIN (dB)	ANTENNA HEIGHT (m)	TABLE ANGLE (Degree)	RAW VALUE (dBuV)	CORRECTION FACTOR (dB/m)
1	2390.00	57.7 PK	74.0	-16.3	1.12 H	322	24.30	33.40
2	2390.00	45.8 AV	54.0	-8.2	1.12 H	322	12.40	33.40
3	*2412.00	96.9 PK			3.98 H	158	63.40	33.50
4	*2412.00	86.8 AV			3.98 H	158	53.30	33.50
5	4824.00	46.3 PK	74.0	-27.7	1.09 H	124	42.60	3.70
6	4824.00	34.1 AV	54.0	-19.9	1.09 H	124	30.40	3.70

**ANTENNA POLARITY & TEST DISTANCE: VERTICAL AT 3 M**

NO.	FREQ. (MHz)	EMISSION LEVEL (dBuV/m)	LIMIT (dBuV/m)	MARGIN (dB)	ANTENNA HEIGHT (m)	TABLE ANGLE (Degree)	RAW VALUE (dBuV)	CORRECTION FACTOR (dB/m)
1	2390.00	57.0 PK	74.0	-17.0	1.15 V	39	23.60	33.40
2	2390.00	45.6 AV	54.0	-8.4	1.15 V	39	12.20	33.40
3	*2412.00	102.0 PK			2.77 V	272	68.50	33.50
4	*2412.00	91.7 AV			2.77 V	272	58.20	33.50
5	4824.00	47.5 PK	74.0	-26.5	1.12 V	183	43.80	3.70
6	4824.00	34.5 AV	54.0	-19.5	1.12 V	183	30.80	3.70

**REMARKS:**

1. Emission Level(dBuV/m) = Raw Value(dBuV) + Correction Factor(dB/m)
2. Correction Factor(dB/m) = Antenna Factor(dB/m) + Cable Factor(dB) – Pre-Amplifier Factor(dB)
3. The other emission levels were very low against the limit.
4. Margin value = Emission Level – Limit value
5. " \* ": Fundamental frequency.

<b>CHANNEL</b>	TX Channel 6	<b>DETECTOR FUNCTION</b>	Peak (PK)
<b>FREQUENCY RANGE</b>	1GHz ~ 25GHz		Average (AV)

**ANTENNA POLARITY & TEST DISTANCE: HORIZONTAL AT 3 M**

NO.	FREQ. (MHz)	EMISSION LEVEL (dBuV/m)	LIMIT (dBuV/m)	MARGIN (dB)	ANTENNA HEIGHT (m)	TABLE ANGLE (Degree)	RAW VALUE (dBuV)	CORRECTION FACTOR (dB/m)
1	*2437.00	94.5 PK			1.02 H	37	60.90	33.60
2	*2437.00	84.8 AV			1.02 H	37	51.20	33.60
3	4874.00	47.1 PK	74.0	-26.9	1.05 H	312	43.20	3.90
4	4874.00	33.7 AV	54.0	-20.3	1.05 H	312	29.80	3.90

**ANTENNA POLARITY & TEST DISTANCE: VERTICAL AT 3 M**

NO.	FREQ. (MHz)	EMISSION LEVEL (dBuV/m)	LIMIT (dBuV/m)	MARGIN (dB)	ANTENNA HEIGHT (m)	TABLE ANGLE (Degree)	RAW VALUE (dBuV)	CORRECTION FACTOR (dB/m)
1	*2437.00	101.4 PK			3.34 V	267	67.80	33.60
2	*2437.00	91.5 AV			3.34 V	267	57.90	33.60
3	4874.00	46.2 PK	74.0	-27.8	1.24 V	256	42.30	3.90
4	4874.00	33.7 AV	54.0	-20.3	1.24 V	256	29.80	3.90

**REMARKS:**

1. Emission Level(dBuV/m) = Raw Value(dBuV) + Correction Factor(dB/m)
2. Correction Factor(dB/m) = Antenna Factor(dB/m) + Cable Factor(dB) – Pre-Amplifier Factor(dB)
3. The other emission levels were very low against the limit.
4. Margin value = Emission Level – Limit value
5. " \* ": Fundamental frequency.

<b>CHANNEL</b>	TX Channel 11	<b>DETECTOR FUNCTION</b>	Peak (PK)
<b>FREQUENCY RANGE</b>	1GHz ~ 25GHz		Average (AV)

**ANTENNA POLARITY & TEST DISTANCE: HORIZONTAL AT 3 M**

NO.	FREQ. (MHz)	EMISSION LEVEL (dBuV/m)	LIMIT (dBuV/m)	MARGIN (dB)	ANTENNA HEIGHT (m)	TABLE ANGLE (Degree)	RAW VALUE (dBuV)	CORRECTION FACTOR (dB/m)
1	*2462.00	99.1 PK			3.84 H	21	65.30	33.80
2	*2462.00	89.2 AV			3.84 H	21	55.40	33.80
3	2483.50	57.7 PK	74.0	-16.3	1.03 H	99	23.80	33.90
4	2483.50	45.8 AV	54.0	-8.2	1.03 H	99	11.90	33.90
5	4924.00	46.6 PK	74.0	-27.4	1.83 H	246	42.60	4.00
6	4924.00	33.5 AV	54.0	-20.5	1.83 H	246	29.50	4.00

**ANTENNA POLARITY & TEST DISTANCE: VERTICAL AT 3 M**

NO.	FREQ. (MHz)	EMISSION LEVEL (dBuV/m)	LIMIT (dBuV/m)	MARGIN (dB)	ANTENNA HEIGHT (m)	TABLE ANGLE (Degree)	RAW VALUE (dBuV)	CORRECTION FACTOR (dB/m)
1	*2462.00	102.3 PK			2.64 V	269	68.50	33.80
2	*2462.00	92.3 AV			2.64 V	269	58.50	33.80
3	2483.50	57.9 PK	74.0	-16.1	1.51 V	53	24.00	33.90
4	2483.50	46.0 AV	54.0	-8.0	1.51 V	53	12.10	33.90
5	4924.00	47.5 PK	74.0	-26.5	1.56 V	269	43.50	4.00
6	4924.00	33.5 AV	54.0	-20.5	1.56 V	269	29.50	4.00

**REMARKS:**

1. Emission Level(dBuV/m) = Raw Value(dBuV) + Correction Factor(dB/m)
2. Correction Factor(dB/m) = Antenna Factor(dB/m) + Cable Factor(dB) – Pre-Amplifier Factor(dB)
3. The other emission levels were very low against the limit.
4. Margin value = Emission Level – Limit value
5. " \* ": Fundamental frequency.

**9 kHz ~ 30 MHz DATA:**

The amplitude of spurious emissions attenuated more than 20 dB below the permissible value is not required to be report.

**BELOW 1GHz DATA**

**802.11g**

<b>CHANNEL</b>	Channel 6	<b>DETECTOR FUNCTION</b>	Quasi-Peak (QP)
<b>FREQUENCY RANGE</b>	30MHz ~ 1GHz		
<b>TEST MODE</b>	Adapter Mode		

**ANTENNA POLARITY & TEST DISTANCE: HORIZONTAL AT 3 M**

NO.	FREQ. (MHz)	EMISSION LEVEL (dBuV/m)	LIMIT (dBuV/m)	MARGIN (dB)	ANTENNA HEIGHT (m)	TABLE ANGLE (Degree)	RAW VALUE (dBuV)	CORRECTION FACTOR (dB/m)
1	64.92	32.7 QP	40.0	-7.3	1.01 H	226	47.40	-14.70
2	146.40	38.4 QP	43.5	-5.1	1.01 H	59	52.00	-13.60
3	270.56	38.8 QP	46.0	-7.2	1.01 H	108	51.90	-13.10
4	400.54	34.3 QP	46.0	-11.7	1.99 H	125	45.40	-11.10
5	532.46	30.4 QP	46.0	-15.6	1.51 H	130	39.50	-9.10
6	817.64	36.7 QP	46.0	-9.3	1.51 H	68	40.70	-4.00

**ANTENNA POLARITY & TEST DISTANCE: VERTICAL AT 3 M**

NO.	FREQ. (MHz)	EMISSION LEVEL (dBuV/m)	LIMIT (dBuV/m)	MARGIN (dB)	ANTENNA HEIGHT (m)	TABLE ANGLE (Degree)	RAW VALUE (dBuV)	CORRECTION FACTOR (dB/m)
<b>1</b>	<b>35.82</b>	<b>36.0 QP</b>	<b>40.0</b>	<b>-4.0</b>	<b>1.00 V</b>	<b>221</b>	<b>51.20</b>	<b>-15.20</b>
2	152.22	38.2 QP	43.5	-5.3	1.00 V	199	51.60	-13.40
3	264.74	41.8 QP	46.0	-4.2	1.49 V	15	55.30	-13.50
4	466.50	35.5 QP	46.0	-10.5	1.00 V	124	45.30	-9.80
5	685.72	35.4 QP	46.0	-10.6	1.49 V	59	41.70	-6.30
6	802.12	35.3 QP	46.0	-10.7	1.00 V	90	39.60	-4.30

**REMARKS:**

1. Emission Level(dBuV/m) = Raw Value(dBuV) + Correction Factor(dB/m)
2. Correction Factor(dB/m) = Antenna Factor(dB/m) + Cable Factor(dB) – Pre-Amplifier Factor(dB)
3. The other emission levels were very low against the limit.
4. Margin value = Emission Level – Limit value

<b>CHANNEL</b>	Channel 6	<b>DETECTOR FUNCTION</b>	Quasi-Peak (QP)
<b>FREQUENCY RANGE</b>	30MHz ~ 1GHz		
<b>TEST MODE</b>	USB Mode		

**ANTENNA POLARITY & TEST DISTANCE: HORIZONTAL AT 3 M**

NO.	FREQ. (MHz)	EMISSION LEVEL (dBuV/m)	LIMIT (dBuV/m)	MARGIN (dB)	ANTENNA HEIGHT (m)	TABLE ANGLE (Degree)	RAW VALUE (dBuV)	CORRECTION FACTOR (dB/m)
1	30.00	29.4 QP	40.0	-10.6	1.99 H	86	44.90	-15.50
2	68.80	34.9 QP	40.0	-5.1	1.51 H	190	50.10	-15.20
3	168.14	30.8 QP	43.5	-12.7	1.51 H	258	44.50	-13.70
4	223.20	26.7 QP	46.0	-19.3	1.00 H	0	42.70	-16.00
5	293.84	41.0 QP	46.0	-5.0	1.01 H	110	53.60	-12.60
6	480.08	40.0 QP	46.0	-6.0	1.99 H	80	49.60	-9.60

**ANTENNA POLARITY & TEST DISTANCE: VERTICAL AT 3 M**

NO.	FREQ. (MHz)	EMISSION LEVEL (dBuV/m)	LIMIT (dBuV/m)	MARGIN (dB)	ANTENNA HEIGHT (m)	TABLE ANGLE (Degree)	RAW VALUE (dBuV)	CORRECTION FACTOR (dB/m)
1	31.18	30.0 QP	40.0	-10.0	1.00 V	343	45.50	-15.50
2	59.06	28.1 QP	40.0	-11.9	1.49 V	15	42.10	-14.00
3	101.78	34.8 QP	43.5	-8.7	1.49 V	15	52.50	-17.70
4	152.22	38.2 QP	43.5	-5.3	1.00 V	199	51.60	-13.40
5	255.75	31.0 QP	46.0	-15.0	1.99 V	9	44.90	-13.90
6	466.50	35.5 QP	46.0	-10.5	1.00 V	124	45.30	-9.80

**REMARKS:**

1. Emission Level(dBuV/m) = Raw Value(dBuV) + Correction Factor(dB/m)
2. Correction Factor(dB/m) = Antenna Factor(dB/m) + Cable Factor(dB) – Pre-Amplifier Factor(dB)
3. The other emission levels were very low against the limit.
4. Margin value = Emission Level – Limit value

## 4.2 Conducted Emission Measurement

### 4.2.1 Limits of Conducted Emission Measurement

Frequency (MHz)	Conducted Limit (dBuV)	
	Quasi-peak	Average
0.15 - 0.5	66 - 56	56 - 46
0.50 - 5.0	56	46
5.0 - 30.0	60	50

- Note: 1. The lower limit shall apply at the transition frequencies.  
 2. The limit decreases in line with the logarithm of the frequency in the range of 0.15 to 0.50 MHz.

### 4.2.2 Test Instruments

Description & Manufacturer	Model No.	Serial No.	Date of Calibration	Due Date of Calibration
Test Receiver ROHDE & SCHWARZ	ESCI	100613	Nov. 21, 2016	Nov. 20, 2017
RF signal cable (with 10dB PAD) Woken	5D-FB	Cable-cond1-01	Sep. 05, 2017	Sep. 04, 2018
LISN/AMN ROHDE & SCHWARZ (EUT)	ESH3-Z5	835239/001	Mar. 10, 2017	Mar. 09, 2018
LISN/AMN ROHDE & SCHWARZ (Peripheral)	ENV216	101196	Apr. 20, 2017	Apr. 19, 2018
Software ADT	BV ADT_Cond_ V7.3.7.3	NA	NA	NA

- Note: 1. The calibration interval of the above test instruments is 12 months and the calibrations are traceable to NML/ROC and NIST/USA.  
 2. The test was performed in HwaYa Shielded Room 1.  
 3. The VCCI Site Registration No. is C-2040.

#### 4.2.3 Test Procedures

- a. The EUT was placed 0.4 meters from the conducting wall of the shielded room with EUT being connected to the power mains through a line impedance stabilization network (LISN). Other support units were connected to the power mains through another LISN. The two LISNs provide 50 ohm/50 uH of coupling impedance for the measuring instrument.
- b. Both lines of the power mains connected to the EUT were checked for maximum conducted interference.
- c. The frequency range from 150 kHz to 30 MHz was searched. Emission levels under (Limit – 20 dB) was not recorded.

**NOTE:** All modes of operation were investigated and the worst-case emissions are reported.

#### 4.2.4 Deviation from Test Standard

No deviation.

#### 4.2.5 Test Setup

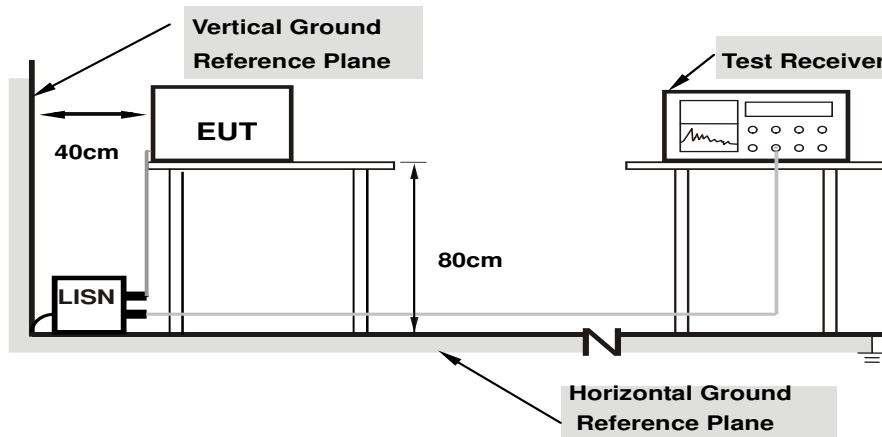

**Note: 1.Support units were connected to second LISN.**

For the actual test configuration, please refer to the attached file (Test Setup Photo).

#### 4.2.6 EUT Operating Conditions

- a. Placed the EUT on a testing table.
- b. Use the software to control the EUT under transmission condition continuously at specific channel frequency.

#### 4.2.7 Test Results

Frequency Range	150kHz ~ 30MHz	Detector Function & Resolution Bandwidth	Quasi-Peak (QP) / Average (AV), 9kHz
Input Power	120Vac, 60Hz	Environmental Conditions	26°C, 69%RH
Tested by	Fox Chang	Test Date	2017/11/9
Test Mode	Adapter Mode		

Phase Of Power : Line (L)										
No	Frequency (MHz)	Correction Factor (dB)	Reading Value (dBuV)		Emission Level (dBuV)		Limit (dBuV)		Margin (dB)	
			Q.P.	AV.	Q.P.	AV.	Q.P.	AV.	Q.P.	AV.
1	0.16953	10.40	46.20	22.18	56.60	32.58	64.98	54.98	-8.38	-22.40
2	0.20078	10.42	44.46	24.71	54.88	35.13	63.58	53.58	-8.70	-18.45
3	0.22812	10.42	42.34	23.50	52.76	33.92	62.52	52.52	-9.76	-18.60
4	0.26719	10.42	37.40	19.10	47.82	29.52	61.20	51.20	-13.38	-21.68
5	0.31406	10.42	34.00	17.41	44.42	27.83	59.86	49.86	-15.44	-22.03
6	0.36094	10.41	31.52	16.18	41.93	26.59	58.71	48.71	-16.78	-22.12
7	0.47813	10.42	28.44	19.03	38.86	29.45	56.37	46.37	-17.51	-16.92

Remarks:

1. Q.P. and AV. are abbreviations of quasi-peak and average individually.
2. The emission levels of other frequencies were very low against the limit.
3. Margin value = Emission level – Limit value
4. Correction factor = Insertion loss + Cable loss
5. Emission Level = Correction Factor + Reading Value

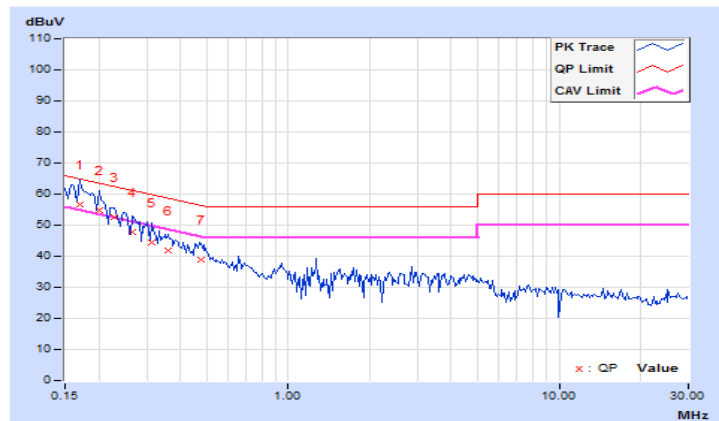



Frequency Range	150kHz ~ 30MHz	Detector Function & Resolution Bandwidth	Quasi-Peak (QP) / Average (AV), 9kHz
Input Power	120Vac, 60Hz	Environmental Conditions	26°C, 69%RH
Tested by	Fox Chang	Test Date	2017/11/9
Test Mode	Adapter Mode		

Phase Of Power : Neutral (N)										
No	Frequency (MHz)	Correction Factor (dB)	Reading Value (dBuV)		Emission Level (dBuV)		Limit (dBuV)		Margin (dB)	
			Q.P.	AV.	Q.P.	AV.	Q.P.	AV.	Q.P.	AV.
1	0.16953	10.40	50.26	30.10	60.66	40.50	64.98	54.98	-4.32	-14.48
2	0.18125	10.38	46.82	24.75	57.20	35.13	64.43	54.43	-7.23	-19.30
3	0.20469	10.35	44.58	23.08	54.93	33.43	63.42	53.42	-8.49	-19.99
4	0.25938	10.36	39.41	20.10	49.77	30.46	61.45	51.45	-11.68	-20.99
5	0.36094	10.37	31.35	13.24	41.72	23.61	58.71	48.71	-16.99	-25.10
6	0.47422	10.39	29.06	20.44	39.45	30.83	56.44	46.44	-16.99	-15.61

Remarks:

1. Q.P. and AV. are abbreviations of quasi-peak and average individually.
2. The emission levels of other frequencies were very low against the limit.
3. Margin value = Emission level – Limit value
4. Correction factor = Insertion loss + Cable loss
5. Emission Level = Correction Factor + Reading Value

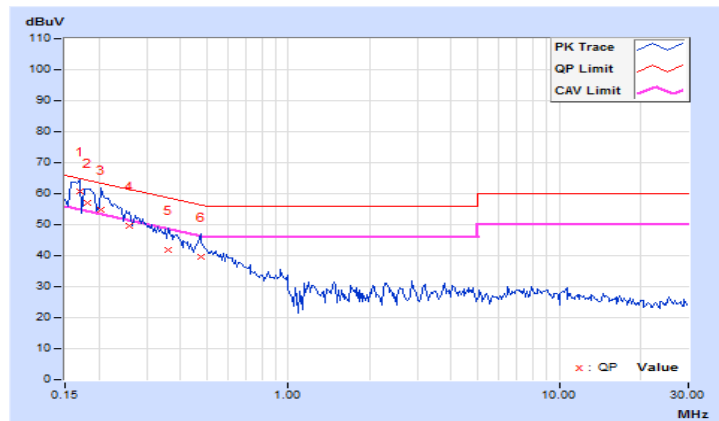

Frequency Range	150kHz ~ 30MHz	Detector Function & Resolution Bandwidth	Quasi-Peak (QP) / Average (AV), 9kHz
Input Power	120Vac, 60Hz	Environmental Conditions	26°C, 69%RH
Tested by	Fox Chang	Test Date	2017/11/9
Test Mode	USB Mode		

Phase Of Power : Line (L)										
No	Frequency (MHz)	Correction Factor (dB)	Reading Value (dBuV)		Emission Level (dBuV)		Limit (dBuV)		Margin (dB)	
			Q.P.	AV.	Q.P.	AV.	Q.P.	AV.	Q.P.	AV.
1	0.16562	10.42	36.42	9.67	46.84	20.09	65.18	55.18	-18.34	-35.09
2	0.22422	10.32	32.30	12.81	42.62	23.13	62.66	52.66	-20.04	-29.53
3	0.34922	10.30	26.04	16.08	36.34	26.38	58.98	48.98	-22.64	-22.60
4	0.47031	10.31	26.66	14.32	36.97	24.63	56.51	46.51	-19.54	-21.88
5	0.61875	10.34	25.27	9.10	35.61	19.44	56.00	46.00	-20.39	-26.56
6	0.71641	10.36	29.59	18.59	39.95	28.95	56.00	46.00	-16.05	-17.05

Remarks:

1. Q.P. and AV. are abbreviations of quasi-peak and average individually.
2. The emission levels of other frequencies were very low against the limit.
3. Margin value = Emission level – Limit value
4. Correction factor = Insertion loss + Cable loss
5. Emission Level = Correction Factor + Reading Value

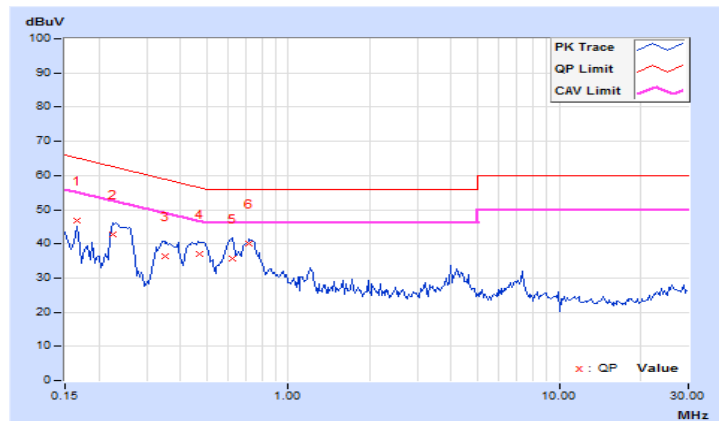

Frequency Range	150kHz ~ 30MHz	Detector Function & Resolution Bandwidth	Quasi-Peak (QP) / Average (AV), 9kHz
Input Power	120Vac, 60Hz	Environmental Conditions	26°C, 69%RH
Tested by	Fox Chang	Test Date	2017/11/9
Test Mode	USB Mode		

Phase Of Power : Neutral (N)										
No	Frequency (MHz)	Correction Factor (dB)	Reading Value (dBuV)		Emission Level (dBuV)		Limit (dBuV)		Margin (dB)	
			Q.P.	AV.	Q.P.	AV.	Q.P.	AV.	Q.P.	AV.
1	0.15391	10.28	27.88	10.89	38.16	21.17	65.79	55.79	-27.63	-34.62
2	0.22812	10.21	31.01	16.04	41.22	26.25	62.52	52.52	-21.30	-26.27
3	0.36484	10.31	21.41	11.32	31.72	21.63	58.62	48.62	-26.90	-26.99
4	0.46641	10.33	19.54	8.59	29.87	18.92	56.58	46.58	-26.71	-27.66
5	0.60703	10.33	23.78	14.54	34.11	24.87	56.00	46.00	-21.89	-21.13
6	4.41016	10.60	21.61	11.53	32.21	22.13	56.00	46.00	-23.79	-23.87

Remarks:

1. Q.P. and AV. are abbreviations of quasi-peak and average individually.
2. The emission levels of other frequencies were very low against the limit.
3. Margin value = Emission level – Limit value
4. Correction factor = Insertion loss + Cable loss
5. Emission Level = Correction Factor + Reading Value

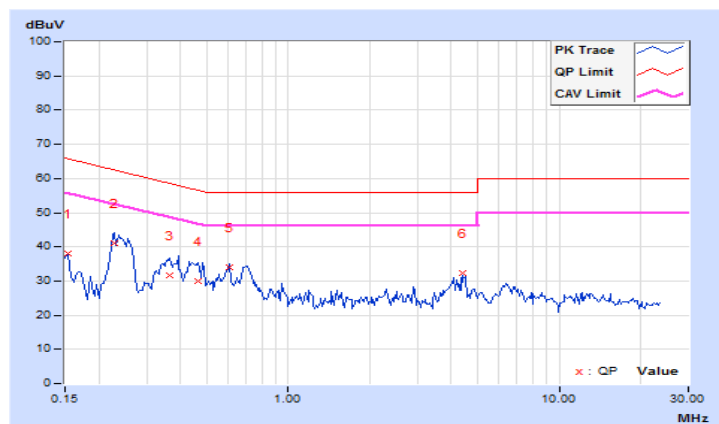

### 4.3 6 dB Bandwidth Measurement

#### 4.3.1 Limits of 6 dB Bandwidth Measurement

The minimum of 6 dB Bandwidth Measurement is 0.5 MHz.

#### 4.3.2 Test Setup

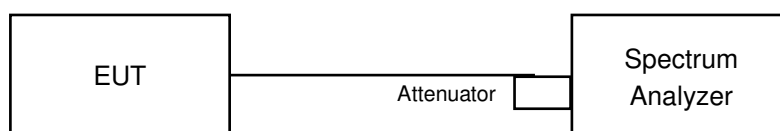

#### 4.3.3 Test Instruments

Refer to section 4.1.2 to get information of above instrument.

#### 4.3.4 Test Procedure

- a. Set resolution bandwidth (RBW) = 100 kHz
- b. Set the video bandwidth (VBW)  $\geq 3 \times$  RBW, Detector = Peak.
- c. Trace mode = max hold.
- d. Sweep = auto couple.
- e. Measure the maximum width of the emission that is constrained by the frequencies associated with the two amplitude points (upper and lower) that are attenuated by 6 dB relative to the maximum level measured in the fundamental emission

#### 4.3.5 Deviation from Test Standard

No deviation.

#### 4.3.6 EUT Operating Conditions

The software provided by client to enable the EUT under transmission condition continuously at lowest, middle and highest channel frequencies individually.

#### 4.3.7 Test Result

##### 802.11b

Channel	Frequency (MHz)	6 dB Bandwidth (MHz)	Minimum Limit (MHz)	Pass / Fail
1	2412	9.60	0.5	Pass
6	2437	9.63	0.5	Pass
11	2462	10.10	0.5	Pass

##### 802.11g

Channel	Frequency (MHz)	6 dB Bandwidth (MHz)	Minimum Limit (MHz)	Pass / Fail
1	2412	15.77	0.5	Pass
6	2437	15.99	0.5	Pass
11	2462	16.40	0.5	Pass

##### 802.11n (HT20)

Channel	Frequency (MHz)	6 dB Bandwidth (MHz)	Minimum Limit (MHz)	Pass / Fail
1	2412	16.38	0.5	Pass
6	2437	16.40	0.5	Pass
11	2462	17.64	0.5	Pass

### Spectrum Plot of Worst Value

#### 802.11b

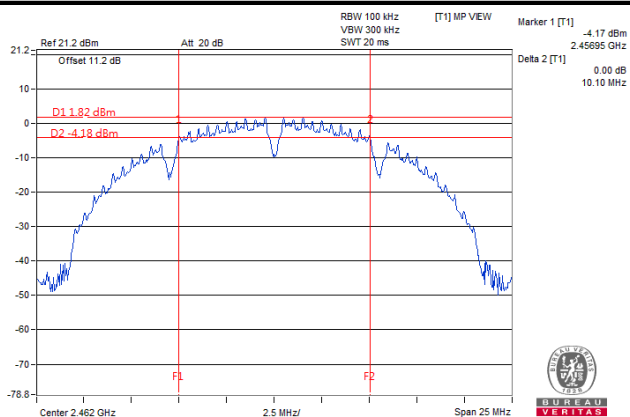

#### 802.11g

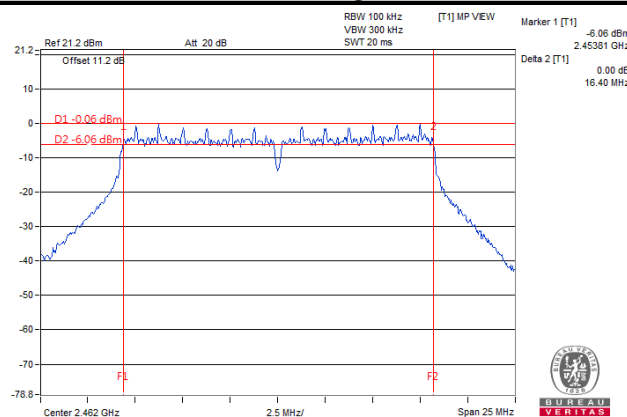

#### 802.11n (HT20)

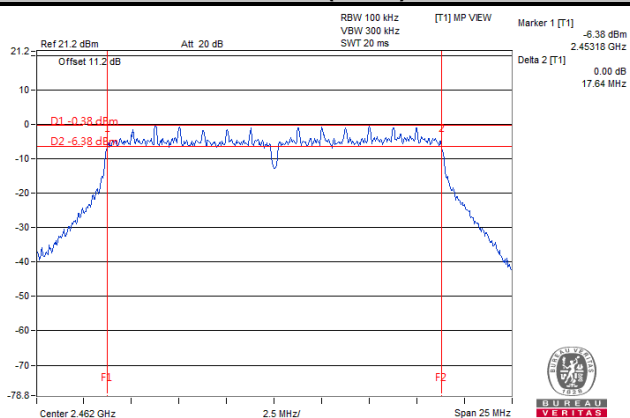

## 4.4 Occupied Bandwidth Measurement

### 4.4.1 Test Setup

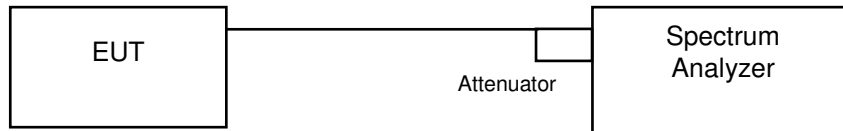

### 4.4.2 Test Instruments

Refer to section 4.1.2 to get information of above instrument.

### 4.4.3 Test Procedure

The transmitter output was connected to the spectrum analyzer through an attenuator. The bandwidth of the fundamental frequency was measured by spectrum analyzer with resolution bandwidth in the range of 1 % to 5 % of the anticipated emission bandwidth, and a video bandwidth at least 3x the resolution bandwidth and set the detector to PEAK. The width of a frequency band such that, below the lower and above the upper frequency limits, the mean powers emitted are each equal to a specified percentage 0.5 % of the total mean power of a given emission.

### 4.4.4 Deviation from Test Standard

No deviation.

### 4.4.5 EUT Operating Conditions

The software provided by client to enable the EUT under transmission condition continuously at lowest, middle and highest channel frequencies individually.

#### 4.4.6 Test Results

##### 802.11b

Channel	Frequency (MHz)	Occupied Bandwidth (MHz)	Pass / Fail
1	2412	15.33	Pass
6	2437	15.65	Pass
11	2462	15.75	Pass

##### 802.11g

Channel	Frequency (MHz)	Occupied Bandwidth (MHz)	Pass / Fail
1	2412	16.82	Pass
6	2437	16.95	Pass
11	2462	17.00	Pass

##### 802.11n (HT20)

Channel	Frequency (MHz)	Occupied Bandwidth (MHz)	Pass / Fail
1	2412	17.88	Pass
6	2437	17.95	Pass
11	2462	18.10	Pass



### Spectrum Plot of Worst Value

#### 802.11b

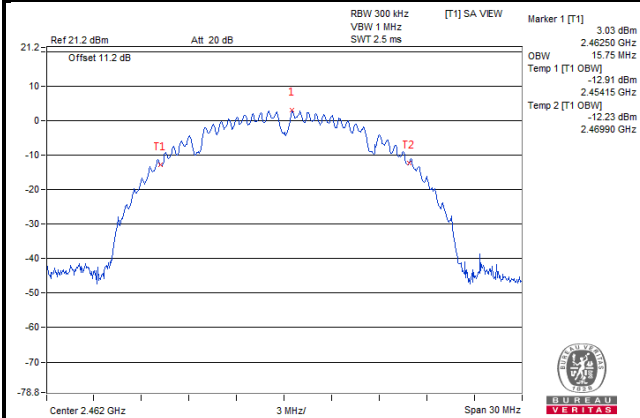

#### 802.11g

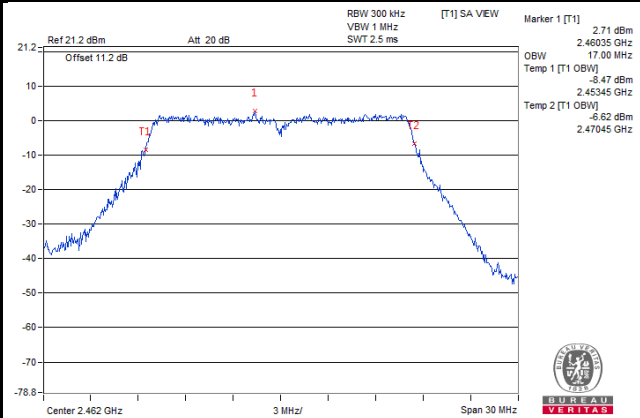

#### 802.11n (HT20)

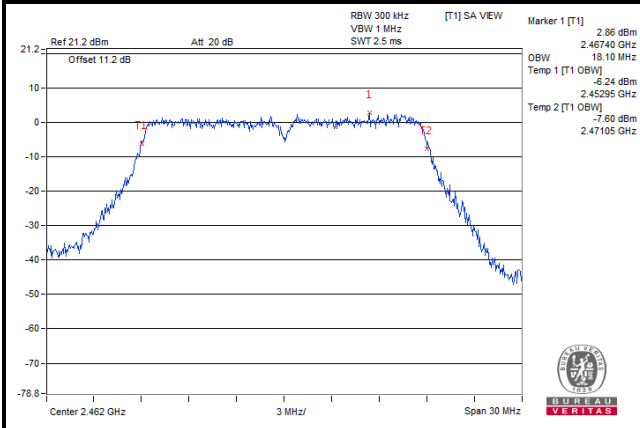

## 4.5 Conducted Output Power Measurement

### 4.5.1 Limits of Conducted Output Power Measurement

For systems using digital modulation in the 2400–2483.5 MHz bands: 1 Watt (30 dBm)

### 4.5.2 Test Setup

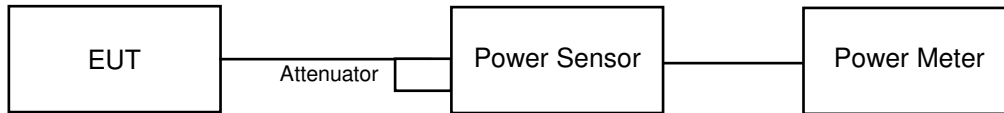

### 4.5.3 Test Instruments

Refer to section 4.1.2 to get information of above instrument.

### 4.5.4 Test Procedures

A peak power sensor was used on the output port of the EUT. A power meter was used to read the response of the peak power sensor. Record the power level.

### 4.5.5 Deviation from Test Standard

No deviation.

### 4.5.6 EUT Operating Conditions

The software provided by client to enable the EUT under transmission condition continuously at lowest, middle and highest channel frequencies individually.

#### 4.5.7 Test Results

##### 802.11b

Channel	Frequency (MHz)	Peak Power (mW)	Peak Power (dBm)	Limit (dBm)	Pass / Fail
1	2412	19.907	12.99	30	Pass
6	2437	18.239	12.61	30	Pass
11	2462	22.909	13.60	30	Pass

##### 802.11g

Channel	Frequency (MHz)	Peak Power (mW)	Peak Power (dBm)	Limit (dBm)	Pass / Fail
1	2412	86.099	19.35	30	Pass
6	2437	65.013	18.13	30	Pass
11	2462	62.23	17.94	30	Pass

##### 802.11n (HT20)

Channel	Frequency (MHz)	Peak Power (mW)	Peak Power (dBm)	Limit (dBm)	Pass / Fail
1	2412	63.387	18.02	30	Pass
6	2437	97.949	19.91	30	Pass
11	2462	93.756	19.72	30	Pass

## 4.6 Power Spectral Density Measurement

### 4.6.1 Limits of Power Spectral Density Measurement

The Maximum of Power Spectral Density Measurement is 8 dBm.

### 4.6.2 Test Setup

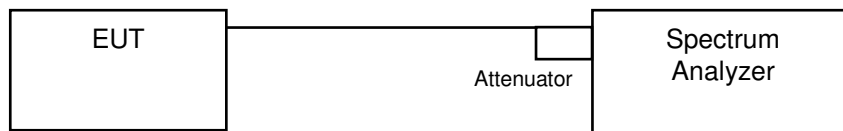

### 4.6.3 Test Instruments

Refer to section 4.1.2 to get information of above instrument.

### 4.6.4 Test Procedure

- a. Set analyzer center frequency to DTS channel center frequency.
- b. Set the span to 1.5 times the DTS bandwidth.
- c. Set the RBW to:  $3 \text{ kHz} \leq \text{RBW} \leq 100 \text{ kHz}$ .
- d. Set the VBW  $\geq 3 \times \text{RBW}$ .
- e. Detector = peak.
- f. Sweep time = auto couple.
- g. Trace mode = max hold.
- h. Allow trace to fully stabilize.
- i. Use the peak marker function to determine the maximum amplitude level within the RBW.

### 4.6.5 Deviation from Test Standard

No deviation.

### 4.6.6 EUT Operating Condition

The software provided by client to enable the EUT under transmission condition continuously at lowest, middle and highest channel frequencies individually.

#### 4.6.7 Test Results

##### 802.11b

Channel	Frequency (MHz)	PSD (dBm/3 kHz)	Limit (dBm/3 kHz)	Pass / Fail
1	2412	-14.98	8	Pass
6	2437	-14.80	8	Pass
11	2462	-14.20	8	Pass

##### 802.11g

Channel	Frequency (MHz)	PSD (dBm/3 kHz)	Limit (dBm/3 kHz)	Pass / Fail
1	2412	-16.54	8	Pass
6	2437	-16.93	8	Pass
11	2462	-16.56	8	Pass

##### 802.11n (HT20)

Channel	Frequency (MHz)	PSD (dBm/3 kHz)	Limit (dBm/3 kHz)	Pass / Fail
1	2412	-15.37	8	Pass
6	2437	-15.99	8	Pass
11	2462	-15.99	8	Pass

### Spectrum Plot of Worst Value

#### 802.11b

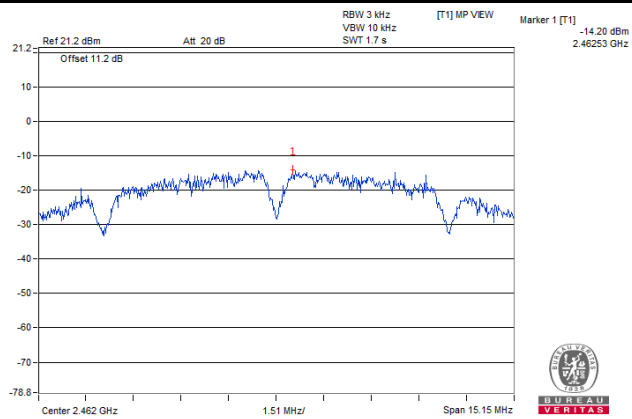

#### 802.11g

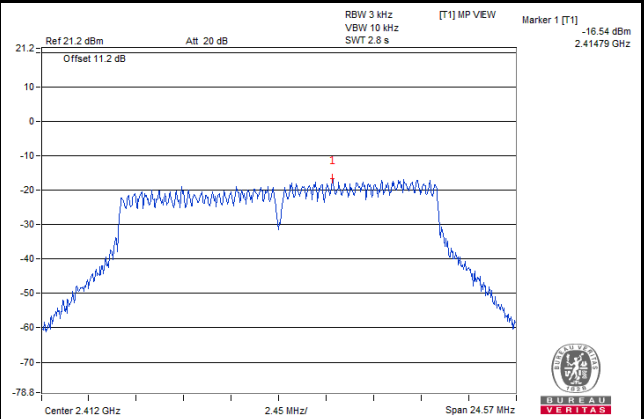

#### 802.11n (HT20)

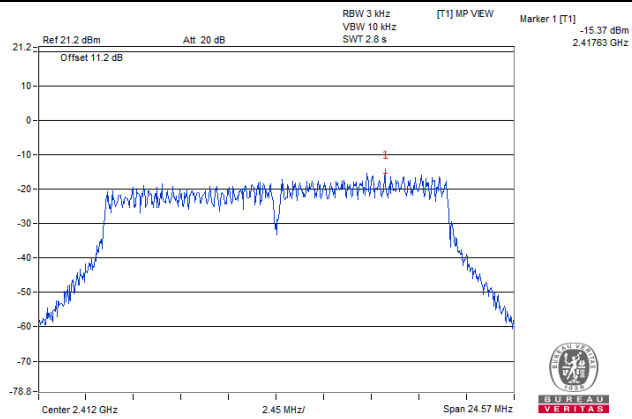

## 4.7 Conducted Out of Band Emission Measurement

### 4.7.1 Limits of Conducted Out of Band Emission Measurement

Below 20 dB of the highest emission level of operating band (in 100 kHz Resolution Bandwidth).

### 4.7.2 Test Setup

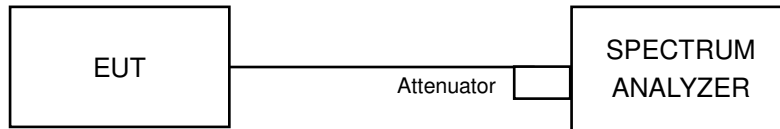

### 4.7.3 Test Instruments

Refer to section 4.1.2 to get information of above instrument.

### 4.7.4 Test Procedure

#### MEASUREMENT PROCEDURE REF

1. Set the RBW = 100 kHz.
2. Set the VBW  $\geq$  300 kHz.
3. Detector = peak.
4. Sweep time = auto couple.
5. Trace mode = max hold.
6. Allow trace to fully stabilize.
7. Use the peak marker function to determine the maximum power level in any 100 kHz band segment within the fundamental EBW.

#### MEASUREMENT PROCEDURE OOB

1. Set RBW = 100 kHz.
2. Set VBW  $\geq$  300 kHz.
3. Detector = peak.
4. Sweep = auto couple.
5. Trace Mode = max hold.
6. Allow trace to fully stabilize.
7. Use the peak marker function to determine the maximum amplitude level.

### 4.7.5 Deviation from Test Standard

No deviation.

### 4.7.6 EUT Operating Condition

The software provided by client to enable the EUT under transmission condition continuously at lowest, middle and highest channel frequencies individually.

### 4.7.7 Test Results

The spectrum plots are attached on the following images. D1 line indicates the highest level, and D2 line indicates the 20 dB offset below D1. It shows compliance with the requirement.

#### 802.11b

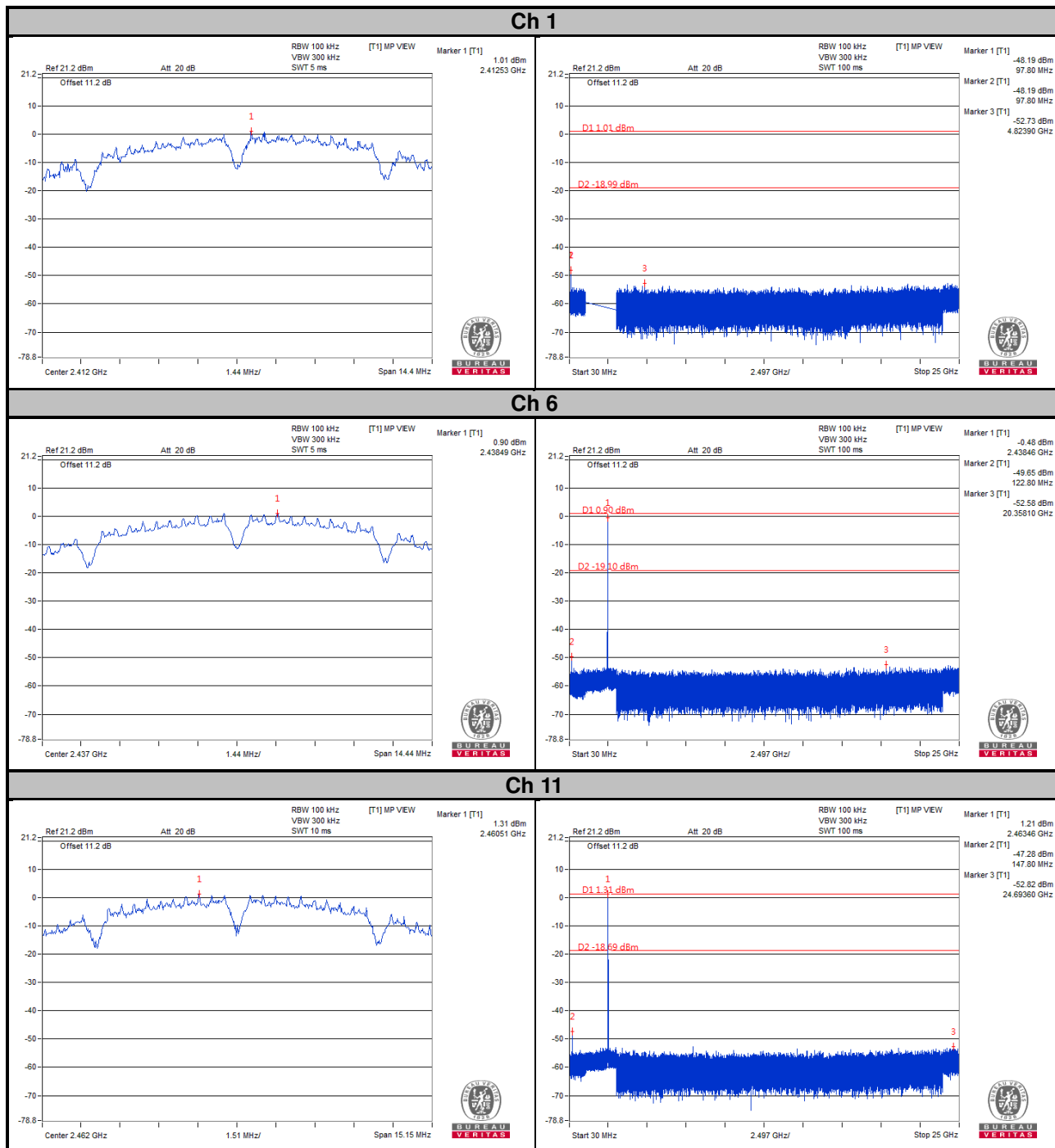



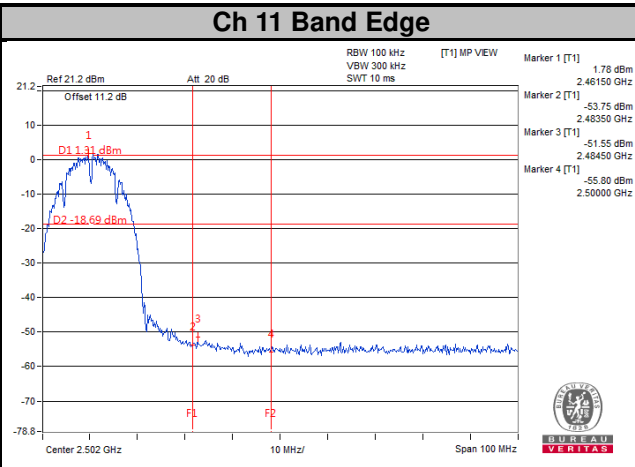
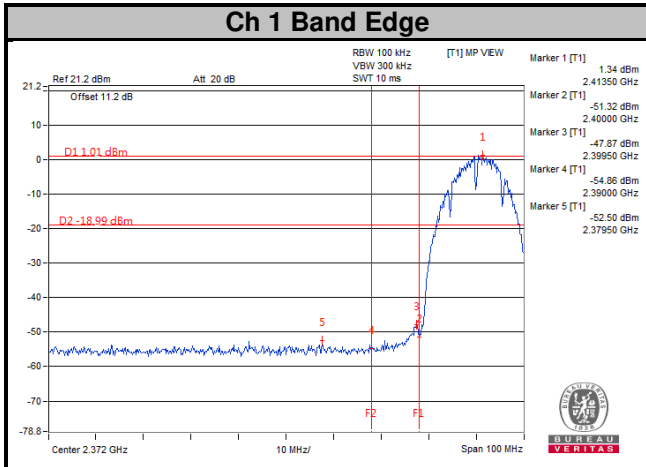

# 802.11g

## Ch 1

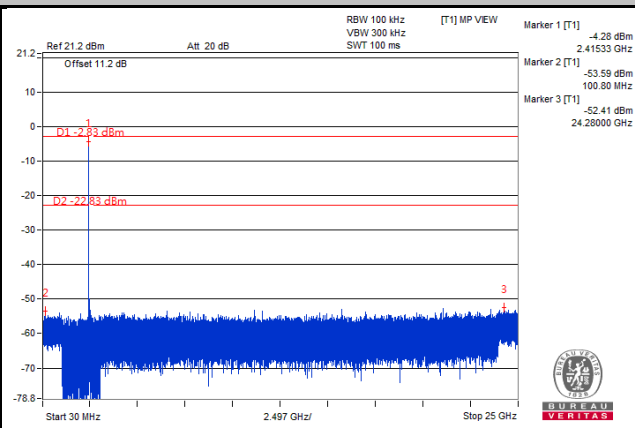
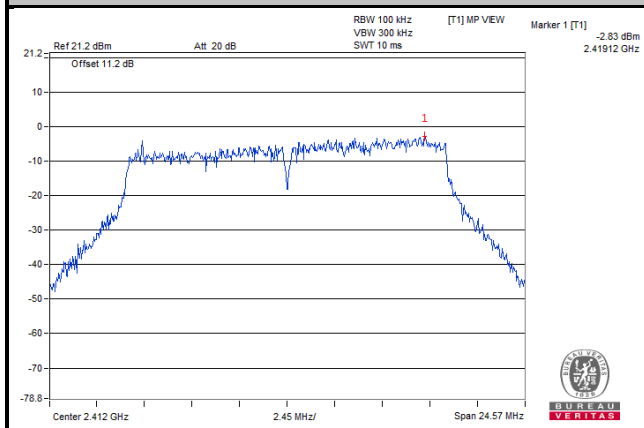

## Ch 6

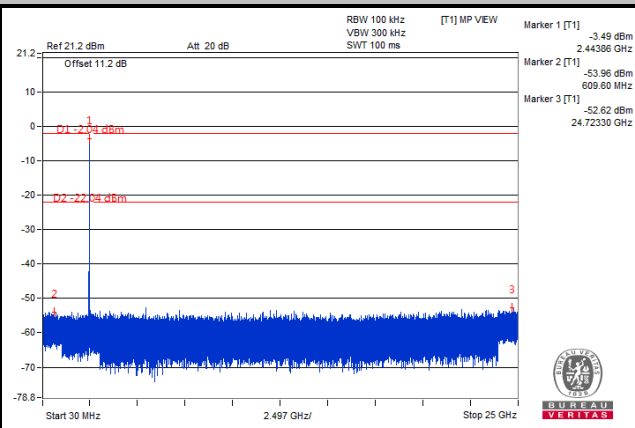
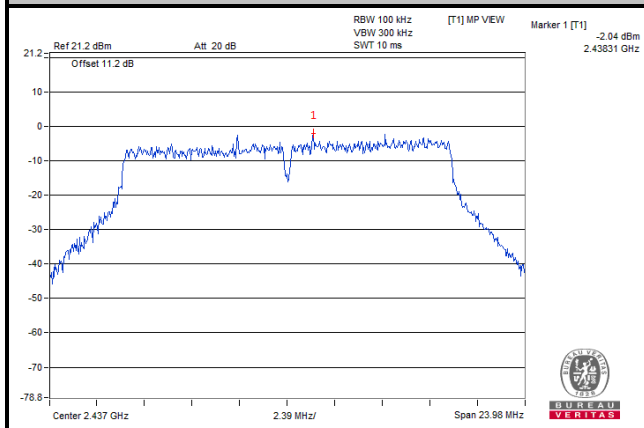

## Ch 11

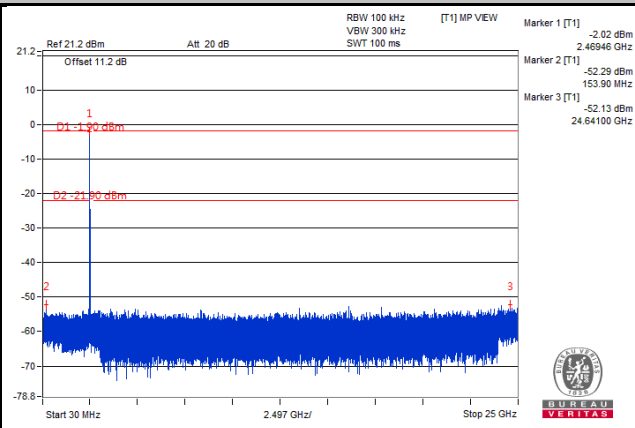
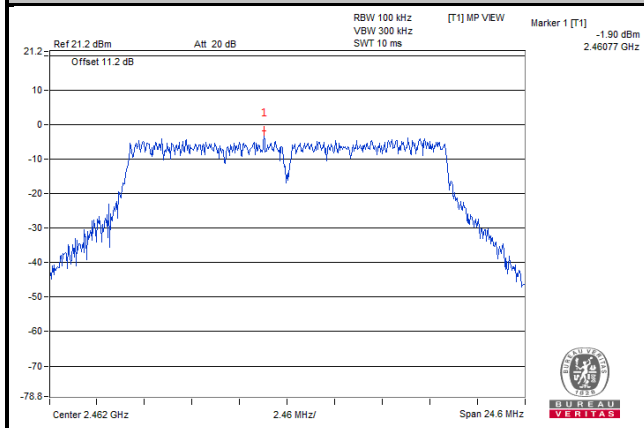

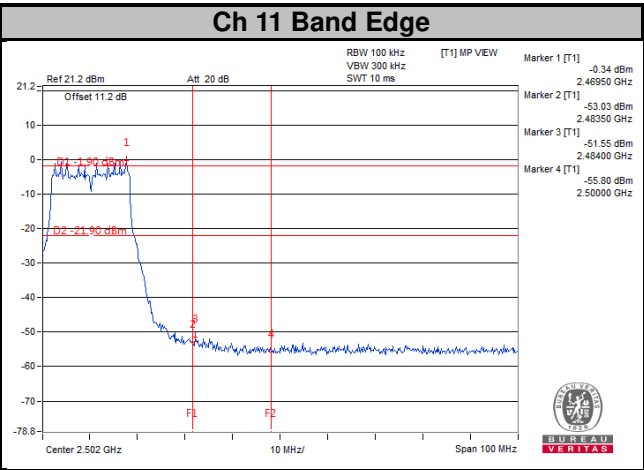
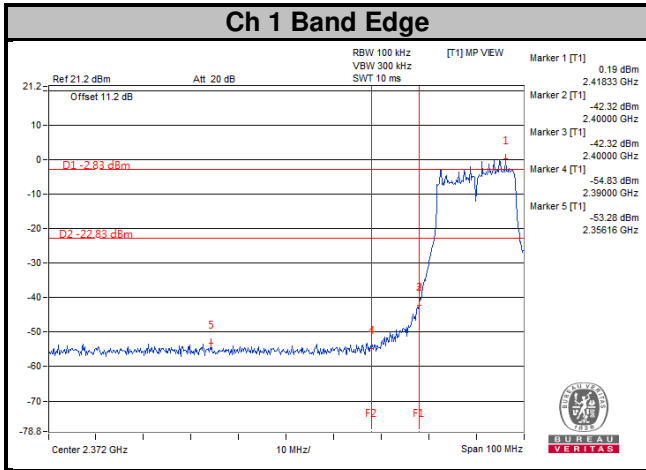

# 802.11n (HT20)

## Ch 1

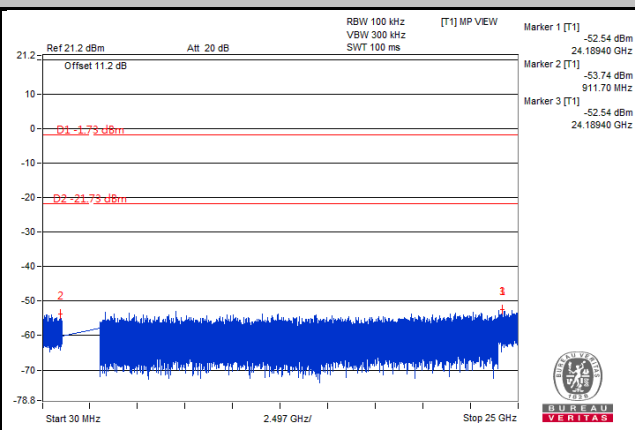
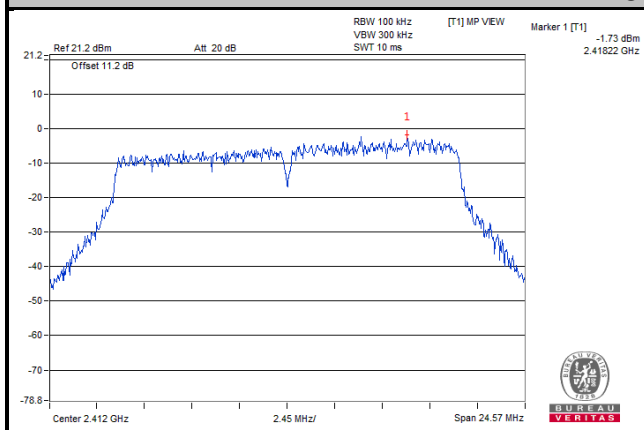

## Ch 6

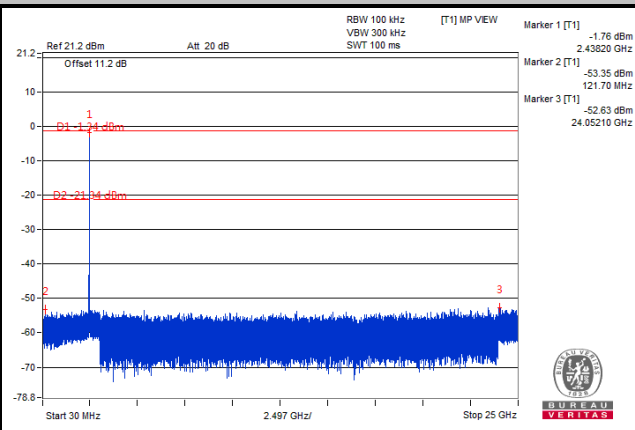
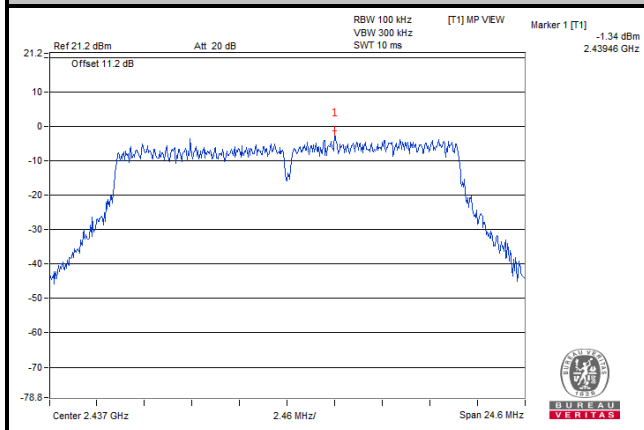

## Ch 11

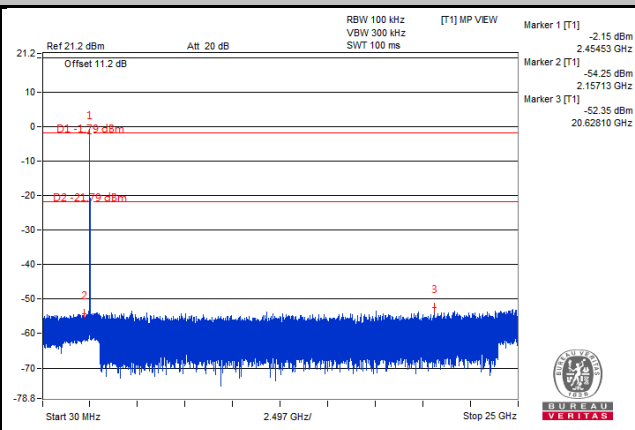
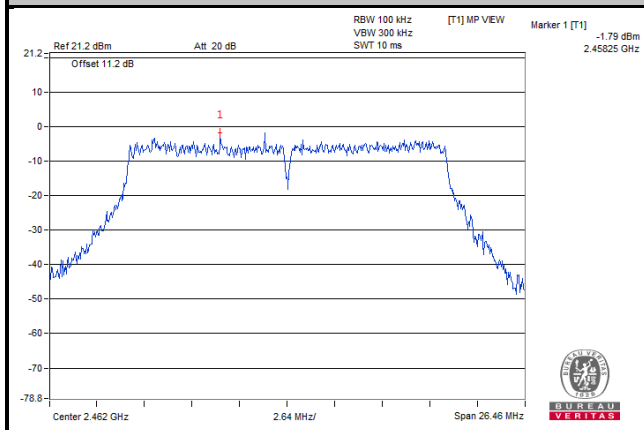

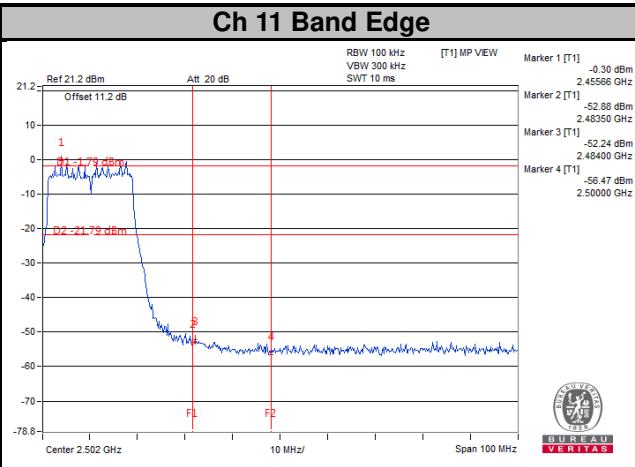
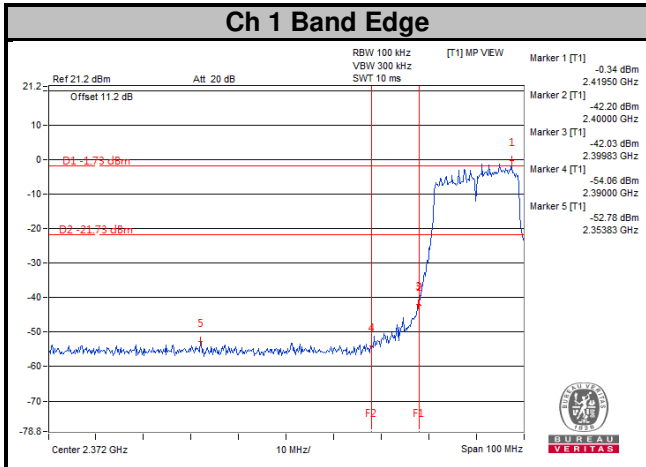

## 5 Pictures of Test Arrangements

Please refer to the attached file (Test Setup Photo).

## Appendix – Information on the Testing Laboratories

We, Bureau Veritas Consumer Products Services (H.K.) Ltd., Taoyuan Branch, were founded in 1988 to provide our best service in EMC, Radio, Telecom and Safety consultation. Our laboratories are FCC recognized accredited test firms and accredited according to ISO/IEC 17025.

If you have any comments, please feel free to contact us at the following:

**Linko EMC/RF Lab**

Tel: 886-2-26052180

Fax: 886-2-26051924

**Hsin Chu EMC/RF/Telecom Lab**

Tel: 886-3-6668565

Fax: 886-3-6668323

**Hwa Ya EMC/RF/Safety Lab**

Tel: 886-3-3183232

Fax: 886-3-3270892

**Email:** [service.adt@tw.bureauveritas.com](mailto:service.adt@tw.bureauveritas.com)

**Web Site:** [www.bureauveritas-adt.com](http://www.bureauveritas-adt.com)

The address and road map of all our labs can be found in our web site also.

--- END ---