

FCC Test Report

(PART 27)

Report No.: RF171027C05-3

FCC ID: XHG-R871A

Test Model: R871

Received Date: Nov. 17, 2016

Test Date: Dec. 17, 2016 ~ Dec. 27, 2016

Issued Date: Nov. 13, 2017

Applicant: Franklin Technology Inc.

Address: 906 JEI Platz, 186, Gasan digital 1-ro, Geumcheon-gu, Seoul, Korea,
(08502)

Issued By: Bureau Veritas Consumer Products Services (H.K.) Ltd., Taoyuan Branch

Lab Address: No. 47-2, 14th Ling, Chia Pau Vil., Lin Kou Dist., New Taipei City, Taiwan
(R.O.C)

Test Location: No. 19, Hwa Ya 2nd Rd, Wen Hwa Tsuen, Kwei Shan Hsiang, Taoyuan
Hsien 333, Taiwan, R.O.C.



This report is for your exclusive use. Any copying or replication of this report to or for any other person or entity, or use of our name or trademark, is permitted only with our prior written permission. This report sets forth our findings solely with respect to the test samples identified herein. The results set forth in this report are not indicative or representative of the quality or characteristics of the lot from which a test sample was taken or any similar or identical product unless specifically and expressly noted. Our report includes all of the tests requested by you and the results thereof based upon the information that you provided to us. You have 60 days from date of issuance of this report to notify us of any material error or omission caused by our negligence, provided, however, that such notice shall be in writing and shall specifically address the issue you wish to raise. A failure to raise such issue within the prescribed time shall constitute your unqualified acceptance of the completeness of this report, the tests conducted and the correctness of the report contents. Unless specific mention, the uncertainty of measurement has been explicitly taken into account to declare the compliance or non-compliance to the specification. The report must not be used by the client to claim product certification, approval, or endorsement by TAF or any government agency

Table of Contents

Release Control Record	3
1 Certificate of Conformity	4
2 Summary of Test Results.....	5
2.1 Measurement Uncertainty.....	6
2.2 Test Site and Instruments	7
3 General Information	8
3.1 General Description of EUT	8
3.2 Configuration of System under Test.....	10
3.2.1 Description of Support Units	10
3.3 Test Mode Applicability and Tested Channel Detail	11
3.4 EUT Operating Conditions	14
3.5 General Description of Applied Standards.....	14
4 Test Types and Results	15
4.1 Output Power Measurement.....	15
4.1.1 Limits of Output Power Measurement	15
4.1.2 Test Procedures.....	15
4.1.3 Test Setup.....	16
4.1.4 Test Results	17
4.2 Frequency Stability Measurement	25
4.2.1 Limits of Frequency Stability Measurement.....	25
4.2.2 Test Procedure	25
4.2.3 Test Setup.....	25
4.2.4 Test Results	26
4.3 Occupied Bandwidth Measurement.....	31
4.3.1 Limits of Occupied Bandwidth Measurement	31
4.3.2 Test Procedure	31
4.3.3 Test Setup.....	31
4.3.4 Test Result	32
4.4 Band Edge Measurement	37
4.4.1 Limits of Band Edge Measurement	37
4.4.2 Test Setup.....	37
4.4.3 Test Procedures.....	37
4.4.4 Test Results	38
4.5 Peak to Average Ratio	48
4.5.1 Limits of Peak to Average Ratio Measurement	48
4.5.2 Test Setup.....	48
4.5.3 Test Procedures.....	48
4.5.4 Test Results	49
4.6 Conducted Spurious Emissions.....	54
4.6.1 Limits of Conducted Spurious Emissions Measurement.....	54
4.6.2 Test Setup.....	54
4.6.3 Test Procedure	54
4.6.4 Test Results	55
4.7 Radiated Emission Measurement.....	65
4.7.1 Limits of Radiated Emission Measurement	65
4.7.2 Test Procedure	65
4.7.3 Deviation from Test Standard	65
4.7.4 Test Setup.....	65
4.7.5 Test Results	66
5 Pictures of Test Arrangements.....	78
Appendix – Information on the Testing Laboratories	79

Release Control Record

Issue No.	Description	Date Issued
RF171027C05-3	Original Release	Nov. 13, 2017

1 Certificate of Conformity

Product: Mobile Hotspot

Brand: Franklin

Test Model: R871

Sample Status: Production Unit

Applicant: Franklin Technology Inc.

Test Date: Dec. 17, 2016 ~ Dec. 27, 2016

Standards: FCC Part 27, Subpart C, L

The above equipment has been tested by **Bureau Veritas Consumer Products Services (H.K.) Ltd., Taoyuan Branch**, and found compliance with the requirement of the above standards. The test record, data evaluation & Equipment Under Test (EUT) configurations represented herein are true and accurate accounts of the measurements of the sample's EMC characteristics under the conditions specified in this report.

Prepared by :  , **Date:** Nov. 13, 2017
Gina Liu / Specialist

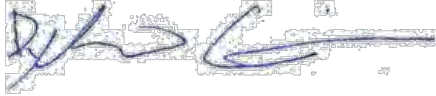
Approved by :  , **Date:** Nov. 13, 2017
Dylan Chiou / Project Engineer

2 Summary of Test Results

Applied Standard: FCC Part 27 & Part 2 (LTE 4)			
FCC Clause	Test Item	Result	Remarks
2.1046 27.50(d)(4)	Maximum Peak Output Power	Pass	Meet the requirement of limit.
2.1055 27.54	Frequency Stability	Pass	Meet the requirement of limit.
2.1049 27.53(h)	Occupied Bandwidth	Pass	Meet the requirement of limit.
27.50(d)(5)	Peak to Average Ratio	Pass	Meet the requirement of limit.
27.53(h)	Band Edge Measurements	Pass	Meet the requirement of limit.
2.1051 27.53(h)	Conducted Spurious Emissions	Pass	Meet the requirement of limit.
2.1053 27.53(h)	Radiated Spurious Emissions	Pass	Meet the requirement of limit. Minimum passing margin is -12.53 dB at 13760.00 MHz.

Applied Standard: FCC Part 27 & Part 2 (LTE 12)			
FCC Clause	Test Item	Result	Remarks
2.1046 27.50(C)(10)	Maximum Peak Output Power	Pass	Meet the requirement of limit.
2.1055 27.54	Frequency Stability	Pass	Meet the requirement of limit.
2.1049 27.53(g)	Occupied Bandwidth	Pass	Meet the requirement of limit.
27.50(d)(5)	Peak to Average Ratio	Pass	Meet the requirement of limit.
27.53(g)	Band Edge Measurements	Pass	Meet the requirement of limit.
2.1051 27.53(g)	Conducted Spurious Emissions	Pass	Meet the requirement of limit.
2.1053 27.53(g)	Radiated Spurious Emissions	Pass	Meet the requirement of limit. Minimum passing margin is -23.77 dB at 6336.00 MHz.

2.1 Measurement Uncertainty

Where relevant, the following measurement uncertainty levels have been estimated for tests performed on the EUT as specified in CISPR 16-4-2:

Measurement	Frequency	Expanded Uncertainty (k=2) (\pm)
Conducted Emissions at mains ports	150 kHz ~ 30 MHz	2.44 dB
Radiated Emissions up to 1 GHz	30 MHz ~ 200 MHz	2.93 dB
	200 MHz ~ 1000 MHz	2.95 dB
Radiated Emissions above 1 GHz	1 GHz ~ 18 GHz	2.26 dB
	18 GHz ~ 40 GHz	1.94 dB

2.2 Test Site and Instruments

Description & Manufacturer	Model No.	Serial No.	Date of Calibration	Due Date of Calibration
Test Receiver Agilent	N9038A	MY51210203	Jan. 21, 2016	Jan. 20, 2017
Spectrum Analyzer Agilent	N9010A	MY52220314	Dec. 16, 2016	Dec. 15, 2017
Spectrum Analyzer ROHDE & SCHWARZ	FSU43	101261	Dec. 13, 2016	Dec. 12, 2017
BILOG Antenna SCHWARZBECK	VULB9168	9168-472	Jan. 07, 2016	Jan. 06, 2017
HORN Antenna SCHWARZBECK	BBHA 9120 D	9120D-969	Jan. 04, 2016	Jan. 03, 2017
Double Ridge Guide Horn Antenna EMCO	3115	5619	Jan. 04, 2016	Jan. 03, 2017
BILOG Antenna SCHWARZBECK	VULB 9168	9168-153	Jan. 07, 2016	Jan. 06, 2017
Fixed Attenuator Mini-Circuits	BW-N10W5+	NA	Jul. 08, 2016	Jul. 07, 2017
MXG Vector signal generator Agilent	N5182B	MY53050430	Oct. 19, 2016	Oct. 18, 2017
Preamplifier EMCI	EMC 012645	980115	Oct. 21, 2016	Oct. 20, 2017
Preamplifier EMCI	EMC 184045	980116	Oct. 21, 2016	Oct. 20, 2017
Preamplifier EMCI	EMC 330H	980112	Oct. 21, 2016	Oct. 20, 2017
Power Meter Anritsu	ML2495A	1232002	Sep. 08, 2016	Sep. 07, 2017
Power Sensor Anritsu	MA2411B	1207325	Sep. 08, 2016	Sep. 07, 2017
RF signal cable HUBER+SUHNNER	SUCOFLEX 104	309219/4 2950114	Oct. 21, 2016	Oct. 20, 2017
RF signal cable HUBER+SUHNNER	SUCOFLEX 104	250130/4	Oct. 21, 2016	Oct. 20, 2017
RF Coaxial Cable Worken	8D-FB	Cable-Ch10-01	Oct. 21, 2016	Oct. 20, 2017
Software BV ADT	E3 6.120103	NA	NA	NA
Antenna Tower MF	MFA-440H	NA	NA	NA
Turn Table MF	MFT-201SS	NA	NA	NA
Antenna Tower & Turn Table Controller MF	MF-7802	NA	NA	NA
Fixed Attenuator Mini-Circuits	BW-N10W5+	NA	Jul. 08, 2016	Jul. 07, 2017
Radio Communication Analyzer	MT8820C	6201300640	Aug. 10, 2015	Aug. 09, 2017
Communications Tester-Wireless	8960 Series 10	MY53201073	Jul. 03, 2015	Jul. 02, 2017

- Note:
1. The calibration interval of the above test instruments is 12 / 24 months and the calibrations are traceable to NML/ROC and NIST/USA.
 2. The test was performed in HwaYa Chamber 10.
 3. The horn antenna and preamplifier (model: EMC 184045) are used only for the measurement of emission frequency above 1 GHz if tested.
 4. The FCC Designation Number is TW0003. The number will be varied with the Lab location and scope as attached.
 5. The IC Site Registration No. is IC7450F-10.

3 General Information

3.1 General Description of EUT

Product	Mobile Hotspot	
Brand	Franklin	
Test Model	R871	
Status of EUT	Production Unit	
Power Supply Rating	5.0 Vdc (adapter or host equipment) 3.8 Vdc (Li-ion battery)	
Modulation Type	LTE	QPSK, 16QAM
Frequency Range	LTE Band 4 (Channel Bandwidth: 1.4 MHz)	1710.7 ~ 1754.3 MHz
	LTE Band 4 (Channel Bandwidth: 3 MHz)	1711.5 ~ 1753.5 MHz
	LTE Band 4 (Channel Bandwidth: 5 MHz)	1712.5 ~ 1752.5 MHz
	LTE Band 4 (Channel Bandwidth: 10 MHz)	1715.0 ~ 1750.0 MHz
	LTE Band 4 (Channel Bandwidth: 15 MHz)	1717.5 ~ 1747.5 MHz
	LTE Band 4 (Channel Bandwidth: 20 MHz)	1720.0 ~ 1745.0 MHz
	LTE Band 12 (Channel Bandwidth: 1.4 MHz)	699.7 ~ 715.3 MHz
	LTE Band 12 (Channel Bandwidth: 3 MHz)	700.5 ~ 714.5 MHz
	LTE Band 12 (Channel Bandwidth: 5 MHz)	701.5 ~ 713.5 MHz
	LTE Band 12 (Channel Bandwidth: 10 MHz)	704.0 ~ 711.0 MHz
Emission Designator	LTE Band 4 (Channel Bandwidth: 1.4 MHz)	1M09G7D
	LTE Band 4 (Channel Bandwidth: 3 MHz)	2M70G7D
	LTE Band 4 (Channel Bandwidth: 5 MHz)	4M50W7D
	LTE Band 4 (Channel Bandwidth: 10 MHz)	8M97W7D
	LTE Band 4 (Channel Bandwidth: 15 MHz)	13M5G7D
	LTE Band 4 (Channel Bandwidth: 20 MHz)	17M9W7D
	LTE Band 12 (Channel Bandwidth: 1.4 MHz)	1M09W7D
	LTE Band 12 (Channel Bandwidth: 3 MHz)	2M70G7D
	LTE Band 12 (Channel Bandwidth: 5 MHz)	4M49W7D
	LTE Band 12 (Channel Bandwidth: 10 MHz)	8M96W7D
Max. ERP Power	LTE Band 12 (Channel Bandwidth: 1.4 MHz)	61.09mW
	LTE Band 12 (Channel Bandwidth: 3 MHz)	61.66mW
	LTE Band 12 (Channel Bandwidth: 5 MHz)	63.24mW
	LTE Band 12 (Channel Bandwidth: 10 MHz)	64.57mW
Max. EIRP Power	LTE Band 4 (Channel Bandwidth: 1.4 MHz)	138.64mW
	LTE Band 4 (Channel Bandwidth: 3 MHz)	140.90mW
	LTE Band 4 (Channel Bandwidth: 5 MHz)	141.55mW
	LTE Band 4 (Channel Bandwidth: 10 MHz)	143.38mW
	LTE Band 4 (Channel Bandwidth: 15 MHz)	146.52mW
	LTE Band 4 (Channel Bandwidth: 20 MHz)	148.90mW
Antenna Type	Fixed Internal Antenna	
Accessory Device	Refer to Note as below	
Data Cable Supplied	Refer to Note as below	

Note:

1. The EUT contains following accessory devices.

Product	Brand	Model	Description
Adapter	Franklin Wireless	FWCR900TVL	I/P: 100-240 Vac, 0.3 A O/P: 5 Vdc, 1.0 A 1.5 m cable non-shielded cable w/o core
Battery	Franklin Wireless	R850	3.8 Vdc, 2450 mAh

2. The above EUT information is declared by manufacturer and for more detailed features description, please refer to the manufacturer's specifications or user's manual.

3.2 Configuration of System under Test

<Radiated Emission Test>

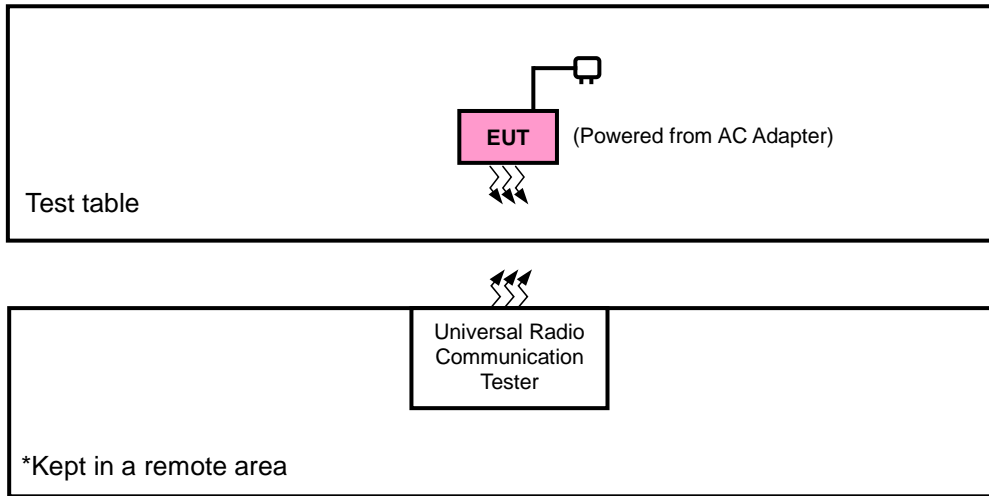

<E.R.P. / E.I.R.P. Test>

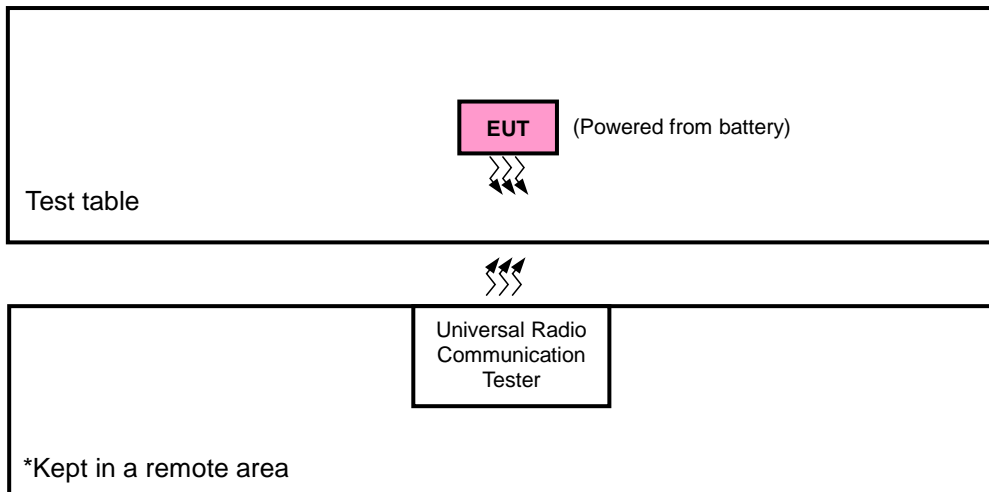

3.2.1 Description of Support Units

The EUT has been tested as an independent unit together with other necessary accessories or support units.

3.3 Test Mode Applicability and Tested Channel Detail

Pre-Scan has been conducted to determine the worst-case mode from all possible combinations between available modulations, data rates, XYZ axis, and antenna ports

The worst case was found when positioned as the table below. Following channel(s) was (were) selected for the final test as listed below:

Band	ERP / EIRP	Radiated Emission
LTE Band 4	X-plane	X-axis
LTE Band 12	Y-plane	Z-axis

LTE Band 4

EUT Configure Mode	Test Item	Available Channel	Tested Channel	Channel Bandwidth	Modulation	Mode
-	EIRP	19957 to 20393	19957, 20175, 20393	1.4 MHz	QPSK	1 RB / 0 RB Offset
					16QAM	3 RB / 1 RB Offset
		19965 to 20385	19965, 20175, 20385	3 MHz	QPSK	1 RB / 0 RB Offset
					16QAM	1 RB / 0 RB Offset
		19975 to 20375	19975, 20175, 20375	5 MHz	QPSK	1 RB / 0 RB Offset
					16QAM	1 RB / 0 RB Offset t
		20000 to 20350	20000, 20175, 20350	10 MHz	QPSK	1 RB / 24 RB Offset
					16QAM	1 RB / 0 RB Offset
		20025 to 20325	20025, 20175, 20325	15 MHz	QPSK	1 RB / 0 RB Offset
					16QAM	1 RB / 37 RB Offset
		20050 to 20300	20050, 20175, 20300	20 MHz	QPSK	1 RB / 0 RB Offset
					16QAM	1 RB / 50 RB Offset
-	Frequency Stability	19957 to 20393	20175	1.4 MHz	QPSK	1 RB / 0 RB Offset
		19965 to 20385	20175	3 MHz	QPSK	1 RB / 0 RB Offset
		19975 to 20375	20175	5 MHz	QPSK	1 RB / 0 RB Offset
		20000 to 20350	20175	10 MHz	QPSK	1 RB / 24 RB Offset
		20025 to 20325	20175	15 MHz	QPSK	1 RB / 0 RB Offset
		20050 to 20300	20175	20 MHz	QPSK	1 RB / 0 RB Offset
-	Occupied Bandwidth	19957 to 20393	19957, 20175, 20393	1.4 MHz	QPSK, 16QAM	6 RB / 0 RB Offset
		19965 to 20385	19965, 20175, 20385	3 MHz	QPSK, 16QAM	15 RB / 0 RB Offset
		19975 to 20375	19975, 20175, 20375	5 MHz	QPSK, 16QAM	25 RB / 0 RB Offset
		20000 to 20350	20000, 20175, 20350	10 MHz	QPSK, 16QAM	50 RB / 0 RB Offset
		20025 to 20325	20025, 20175, 20325	15 MHz	QPSK, 16QAM	75 RB / 0 RB Offset
		20050 to 20300	20050, 20175, 20300	20 MHz	QPSK, 16QAM	100 RB / 0 RB Offset
-	Peak to Average Ratio	19957 to 20393	19957, 20175, 20393	1.4 MHz	QPSK	1 RB / 0 RB Offset
					16QAM	3 RB / 1 RB Offset
		19965 to 20385	19965, 20175, 20385	3 MHz	QPSK	1 RB / 0 RB Offset
					16QAM	1 RB / 0 RB Offset
		19975 to 20375	19975, 20175, 20375	5 MHz	QPSK	1 RB / 0 RB Offset
					16QAM	1 RB / 0 RB Offset t
		20000 to 20350	20000, 20175, 20350	10 MHz	QPSK	1 RB / 24 RB Offset
					16QAM	1 RB / 0 RB Offset
		20025 to 20325	20025, 20175, 20325	15 MHz	QPSK	1 RB / 0 RB Offset
					16QAM	1 RB / 37 RB Offset
		20050 to 20300	20050, 20175, 20300	20 MHz	QPSK	1 RB / 0 RB Offset
					16QAM	1 RB / 50 RB Offset

EUT Configure Mode	Test Item	Available Channel	Tested Channel	Channel Bandwidth	Modulation	Mode		
-	Band Edge	19957 to 20393	19957	1.4 MHz	QPSK	1 RB / 0 RB Offset 6 RB / 0 RB Offset		
			20393	1.4 MHz	QPSK	1 RB / 5 RB Offset 6 RB / 0 RB Offset		
		19965 to 20385	19965	3 MHz	QPSK	1 RB / 0 RB Offset 15 RB / 0 RB Offset		
			20385	3 MHz	QPSK	1 RB / 14 RB Offset 15 RB / 0 RB Offset		
		19975 to 20375	19975	5 MHz	QPSK	1 RB / 0 RB Offset 25 RB / 0 RB Offset		
			20375	5 MHz	QPSK	1 RB / 24 RB Offset 25 RB / 0 RB Offset		
		20000 to 20350	20000	10 MHz	QPSK	1 RB / 0 RB Offset 50 RB / 0 RB Offset		
			20350	10 MHz	QPSK	1 RB / 49 RB Offset 50 RB / 0 RB Offset		
		20025 to 20325	20025	15 MHz	QPSK	1 RB / 0 RB Offset 75 RB / 0 RB Offset		
			20325	15 MHz	QPSK	1 RB / 74 RB Offset 75 RB / 0 RB Offset		
		20050 to 20300	20050	20 MHz	QPSK	1 RB / 0 RB Offset 100 RB / 0 RB Offset		
			20300	20 MHz	QPSK	1 RB / 99 RB Offset 100 RB / 0 RB Offset		
		-	Conducted Emission	19957 to 20393	19957, 20175, 20393	1.4 MHz	QPSK	1 RB / 0 RB Offset
				19965 to 20385	19965, 20175, 20385	3 MHz	QPSK	1 RB / 0 RB Offset
				19975 to 20375	19975, 20175, 20375	5 MHz	QPSK	1 RB / 0 RB Offset
				20000 to 20350	20000, 20175, 20350	10 MHz	QPSK	1 RB / 24 RB Offset
20025 to 20325	20025, 20175, 20325			15 MHz	QPSK	1 RB / 0 RB Offset		
20050 to 20300	20050, 20175, 20300			20 MHz	QPSK	1 RB / 0 RB Offset		
-	Radiated Emission	20050 to 20300	20050, 20175, 20300	20 MHz	QPSK	1 RB / 0 RB Offset		

Note: This device was tested under all bandwidths, RB configurations and modulations. The worst case was found in QPSK modulation.

LTE Band 12

EUT Configure Mode	Test Item	Available Channel	Tested Channel	Channel Bandwidth	Modulation	Mode		
-	ERP	23017 to 23173	23017, 23095, 23173	1.4 MHz	QPSK	1 RB / 0 RB Offset		
					16QAM	3 RB / 0 RB Offset		
		23025 to 23165	23025, 23095, 23165	3 MHz	QPSK	1 RB / 0 RB Offset		
					16QAM	1 RB / 0 RB Offset		
		23035 to 23155	23035, 23095, 23155	5 MHz	QPSK	1 RB / 0 RB Offset		
					16QAM	1 RB / 12 RB Offset		
		23060 to 23130	23060, 23095, 23130	10 MHz	QPSK	1 RB / 0 RB Offset		
					16QAM	1 RB / 49 RB Offset		
-	Frequency Stability	23017 to 23173	23095	1.4 MHz	QPSK	1 RB / 0 RB Offset		
		23025 to 23165	23095	3 MHz	QPSK	1 RB / 0 RB Offset		
		23035 to 23155	23095	5 MHz	QPSK	1 RB / 0 RB Offset		
		23060 to 23130	23095	10 MHz	QPSK	1 RB / 0 RB Offset		
-	Occupied Bandwidth	23017 to 23173	23017, 23095, 23173	1.4 MHz	QPSK, 16QAM	6 RB / 0 RB Offset		
		23025 to 23165	23025, 23095, 23165	3 MHz	QPSK, 16QAM	15 RB / 0 RB Offset		
		23035 to 23155	23035, 23095, 23155	5 MHz	QPSK, 16QAM	25 RB / 0 RB Offset		
		23060 to 23130	23060, 23095, 23130	10 MHz	QPSK, 16QAM	50 RB / 0 RB Offset		
-	Peak to Average Ratio	23017 to 23173	23017, 23095, 23173	1.4 MHz	QPSK	1 RB / 0 RB Offset		
					16QAM	3 RB / 0 RB Offset		
		23025 to 23165	23025, 23095, 23165	3 MHz	QPSK	1 RB / 0 RB Offset		
					16QAM	1 RB / 0 RB Offset		
		23035 to 23155	23035, 23095, 23155	5 MHz	QPSK	1 RB / 0 RB Offset		
					16QAM	1 RB / 12 RB Offset		
		23060 to 23130	23060, 23095, 23130	10 MHz	QPSK	1 RB / 0 RB Offset		
					16QAM	1 RB / 49 RB Offset		
-	Band Edge	23017 to 23173	23017	1.4 MHz	QPSK	1 RB / 0 RB Offset		
			23173	1.4 MHz	QPSK	6 RB / 0 RB Offset		
		23025 to 23165	23025	3 MHz	QPSK	1 RB / 0 RB Offset		
			23165	3 MHz	QPSK	15 RB / 0 RB Offset		
		23035 to 23155	23035	5 MHz	QPSK	1 RB / 0 RB Offset		
			23155	5 MHz	QPSK	25 RB / 0 RB Offset		
		23060 to 23130	23060	10 MHz	QPSK	1 RB / 0 RB Offset		
			23130	10 MHz	QPSK	50 RB / 0 RB Offset		
		-	Conducted Emission	23017 to 23173	23017, 23095, 23173	1.4 MHz	QPSK	1 RB / 0 RB Offset
				23025 to 23165	23025, 23095, 23165	3 MHz	QPSK	1 RB / 0 RB Offset
				23035 to 23155	23035, 23095, 23155	5 MHz	QPSK	1 RB / 0 RB Offset
				23060 to 23130	23060, 23095, 23130	10 MHz	QPSK	1 RB / 0 RB Offset
-	Radiated Emission	23060 to 23130	23060, 23095, 23130	10 MHz	QPSK	1 RB / 0 RB Offset		

Note: This device was tested under all bandwidths, RB configurations and modulations. The worst case was found in QPSK modulation.

Test Condition:

Test Item	Environmental Conditions	Input Power	Tested By
ERP / EIRP	25 deg. C, 65 % RH	3.8 Vdc	Getaz Yang
Frequency Stability	25 deg. C, 65 % RH	3.8 Vdc	Carlos Chen
Occupied Bandwidth	25 deg. C, 65 % RH	3.8 Vdc	Carlos Chen
Band Edge	25 deg. C, 65 % RH	3.8 Vdc	Carlos Chen
Peak to Average Ratio	25 deg. C, 65 % RH	3.8 Vdc	Carlos Chen
Condcudeted Emission	25 deg. C, 65 % RH	3.8 Vdc	Carlos Chen
Radiated Emission	25 deg. C, 65 % RH	120 Vac, 60 Hz	Getaz Yang

3.4 EUT Operating Conditions

The EUT makes a call to the communication simulator. The communication simulator station system controlled a EUT to export maximum output power under transmission mode and specific channel frequency

3.5 General Description of Applied Standards

The EUT is a RF Product. According to the specifications of the manufacturer, it must comply with the requirements of the following standards:

FCC 47 CFR Part 2

FCC 47 CFR Part 27

KDB 971168 D01 Power Meas License Digital Systems v02r02

ANSI/TIA/EIA-603-D 2010

Note: All test items have been performed and recorded as per the above standards.

4 Test Types and Results

4.1 Output Power Measurement

4.1.1 Limits of Output Power Measurement

Fixed, mobile, and portable (hand-held) stations operating in the 1710–1755 MHz band are limited to 1 watt EIRP.

Portable stations (hand-held devices) operating in the 698-716 MHz band are limited to 3 watts ERP

4.1.2 Test Procedures

EIRP / ERP Measurement:

- a. All measurements were done at low, middle and high operational frequency range. RBW and VBW is 5 MHz for WCDMA and 10 MHz for LTE mode.
- b. Substitution method is used for E.I.R.P measurement. In the semi-anechoic chamber, EUT placed on the 0.8 m height of Turn Table, rotated the table around 360 degrees to search the maximum radiation power and receiver antenna shall be rotated vertical and horizontal polarization and moved height from 1 m to 4 m to find the maximum polar radiated power. The “Read Value” is the spectrum reading the maximum power value.
- c. The substitution horn antenna is substituted for EUT at the same position and signals generator export the CW signal to the substitution antenna via a tx cable. Rotated the Turn Table and moved receiving antenna to find the maximum radiation power. Adjust output power level of S.G to get a Value of spectrum reading equal to “Read Value” of step b. Record the power level of S.G.
- d. $EIRP = \text{Output power level of S.G} - \text{TX cable loss} + \text{Antenna gain of substitution horn}$. E.R.P power can be calculated form E.I.R.P power by subtracting the gain of dipole, $E.R.P \text{ power} = E.I.P.R \text{ power} - 2.15 \text{ dBi}$.

Conducted Power Measurement:

- a. The EUT was set up for the maximum power with LTE link data modulation and link up with simulator.
- b. Set the EUT to transmit under low, middle and high channel and record the power level shown on simulator.

4.1.3 Test Setup

EIRP / ERP Measurement:

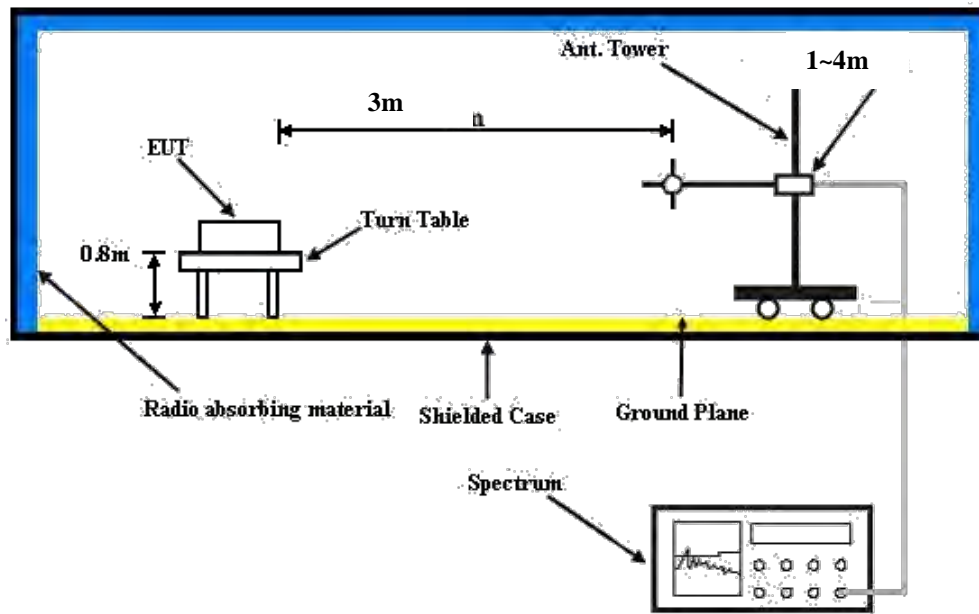

For the actual test configuration, please refer to the attached file (Test Setup Photo).

Conducted Power Measurement:



4.1.4 Test Results

Conducted Output Power (dBm)

Band / BW	RB Size	RB Offset	QPSK			3GPP MPR (dB)	16QAM			3GPP MPR (dB)
			Low Ch 19957	Mid Ch 20175	High Ch 20393		Low Ch 19957	Mid Ch 20175	High Ch 20393	
			1710.7 MHz	1732.5 MHz	1754.3 MHz		1710.7 MHz	1732.5 MHz	1754.3 MHz	
4 / 1.4M	1	0	22.95	22.64	22.94	0	21.63	21.50	21.28	1
	1	2	22.93	22.69	22.91	0	21.62	21.57	21.34	1
	1	5	22.90	22.64	22.69	0	21.47	21.54	21.29	1
	3	0	22.83	22.62	22.54	0	21.69	21.51	21.24	1
	3	1	22.84	22.57	22.60	0	21.70	21.46	21.40	1
	3	3	22.75	22.45	22.67	0	21.46	21.30	21.38	1
	6	0	21.70	21.57	21.56	1	20.59	20.49	20.32	2

Band / BW	RB Size	RB Offset	QPSK			3GPP MPR (dB)	16QAM			3GPP MPR (dB)
			Low Ch 19965	Mid Ch 20175	High Ch 20385		Low Ch 19965	Mid Ch 20175	High Ch 20385	
			1711.5 MHz	1732.5 MHz	1753.5 MHz		1711.5 MHz	1732.5 MHz	1753.5 MHz	
4 / 3M	1	0	22.91	22.75	22.59	0	21.57	21.46	21.22	1
	1	7	22.89	22.68	22.49	0	21.37	21.23	21.05	1
	1	14	22.82	22.63	22.60	0	21.23	21.45	21.22	1
	8	0	21.79	21.48	21.51	1	20.58	20.89	20.49	2
	8	3	21.65	21.62	21.57	1	20.49	20.65	20.72	2
	8	7	21.77	21.51	21.40	1	20.53	20.44	20.55	2
	15	0	21.78	21.50	21.47	1	20.62	20.46	20.36	2

Band / BW	RB Size	RB Offset	QPSK			3GPP MPR (dB)	16QAM			3GPP MPR (dB)
			Low Ch 19975	Mid Ch 20175	High Ch 20375		Low CH 19975	Mid CH 20175	High CH 20375	
			1712.5 MHz	1732.5 MHz	1752.5 MHz		1712.5 MHz	1732.5 MHz	1752.5 MHz	
4 / 5M	1	0	22.94	22.75	22.75	0	21.49	21.37	21.30	1
	1	12	22.81	22.69	22.71	0	21.34	21.34	21.02	1
	1	24	22.62	22.61	22.76	0	21.32	21.38	20.96	1
	12	0	21.68	21.49	21.52	1	20.73	20.51	20.58	2
	12	6	21.62	21.57	21.57	1	20.48	20.60	20.62	2
	12	13	21.56	21.45	21.58	1	20.63	20.60	20.64	2
	25	0	21.56	21.53	21.54	1	20.73	20.67	20.60	2

Band / BW	RB Size	RB Offset	QPSK			3GPP MPR (dB)	16QAM			3GPP MPR (dB)
			Low Ch 20000	Mid Ch 20175	High Ch 20350		Low Ch 20000	Mid Ch 20175	High Ch 20350	
			1715.0 MHz	1732.5 MHz	1750.0 MHz		1715.0 MHz	1732.5 MHz	1750.0 MHz	
4 / 10M	1	0	22.91	22.76	22.79	0	21.61	21.32	21.35	1
	1	24	22.94	22.87	22.81	0	21.51	21.45	21.36	1
	1	49	22.93	22.53	22.84	0	21.40	21.12	21.41	1
	25	0	21.72	21.54	21.69	1	20.78	20.66	20.62	2
	25	12	21.76	21.55	21.64	1	20.80	20.68	20.67	2
	25	25	21.58	21.46	21.50	1	20.79	20.58	20.52	2
	50	0	21.59	21.50	21.55	1	20.64	20.52	20.48	2

Band / BW	RB Size	RB Offset	QPSK			3GPP MPR (dB)	16QAM			3GPP MPR (dB)
			Low Ch 20025	Mid Ch 20175	High Ch 20325		Low Ch 20025	Mid Ch 20175	High Ch 20325	
			1717.5 MHz	1732.5 MHz	1747.5 MHz		1717.5 MHz	1732.5 MHz	1747.5 MHz	
4 / 15M	1	0	22.94	22.91	22.87	0	21.54	21.41	21.55	1
	1	37	22.88	22.89	22.91	0	21.32	21.62	21.46	1
	1	74	22.76	22.72	22.63	0	21.39	21.26	21.28	1
	36	0	21.74	21.56	21.5	1	20.65	20.64	20.46	2
	36	19	21.72	21.57	21.68	1	20.82	20.57	20.72	2
	36	39	21.63	21.52	21.44	1	20.62	20.43	20.49	2
	75	0	21.66	21.54	21.53	1	20.76	20.59	20.58	2

Band / BW	RB Size	RB Offset	QPSK			3GPP MPR (dB)	16QAM			3GPP MPR (dB)
			Low Ch 20050	Mid Ch 20175	High Ch 20300		Low Ch 20050	Mid Ch 20175	High Ch 20300	
			1720.0 MHz	1732.5 MHz	1745.0 MHz		1720.0 MHz	1732.5 MHz	1745.0 MHz	
4 / 20M	1	0	22.96	22.94	22.91	0	21.50	21.49	21.52	1
	1	50	22.81	22.86	22.82	0	21.74	21.59	21.72	1
	1	99	22.74	22.50	22.75	0	21.38	21.29	21.26	1
	50	0	21.78	21.57	21.72	1	20.90	20.72	20.82	2
	50	25	21.77	21.63	21.57	1	20.89	20.52	20.68	2
	50	50	21.53	21.46	21.47	1	20.73	20.47	20.47	2
	100	0	21.67	21.55	21.65	1	20.80	20.60	20.57	2

Band / BW	RB Size	RB Offset	QPSK			3GPP MPR (dB)	16QAM			3GPP MPR (dB)
			Low Ch 23017	Mid Ch 23095	High Ch 23173		Low Ch 23017	Mid Ch 23095	High Ch 23173	
			699.7 MHz	707.5 MHz	715.3 MHz		699.7 MHz	707.5 MHz	715.3 MHz	
12 / 1.4M	1	0	24.63	24.41	24.84	0	23.03	23.15	23.44	1
	1	2	24.25	24.38	24.55	0	23.05	23.05	23.47	1
	1	5	24.21	24.45	24.74	0	23.12	23.35	23.41	1
	3	0	24.14	24.28	24.48	0	23.09	23.17	23.68	1
	3	1	24.53	24.41	24.59	0	23.12	23.28	23.47	1
	3	3	24.14	24.36	24.51	0	22.85	23.28	23.40	1
	6	0	23.05	23.29	23.53	1	21.76	22.13	22.32	2

Band / BW	RB Size	RB Offset	QPSK			3GPP MPR (dB)	16QAM			3GPP MPR (dB)
			Low Ch 23025	Mid Ch 23095	High Ch 23165		Low Ch 23025	Mid Ch 23095	High Ch 23165	
			700.5 MHz	707.5 MHz	714.5 MHz		700.5 MHz	707.5 MHz	714.5 MHz	
12 / 3M	1	0	24.75	24.57	24.95	0	22.91	22.99	23.60	1
	1	7	24.30	24.40	24.63	0	23.20	23.10	23.46	1
	1	14	24.21	24.16	24.53	0	22.86	22.71	23.43	1
	8	0	23.29	23.28	23.64	1	22.20	22.09	22.70	2
	8	3	23.21	23.30	23.54	1	22.14	22.11	22.71	2
	8	7	23.11	23.32	23.60	1	22.42	22.38	22.41	2
	15	0	23.10	23.34	23.45	1	22.27	22.45	22.31	2

Band / BW	RB Size	RB Offset	QPSK			3GPP MPR (dB)	16QAM			3GPP MPR (dB)
			Low Ch 23035	Mid Ch 23095	High Ch 23155		Low Ch 23035	Mid Ch 23095	High Ch 23155	
			701.5 MHz	707.5 MHz	713.5 MHz		701.5 MHz	707.5 MHz	713.5 MHz	
12 / 5M	1	0	24.64	24.96	24.78	0	23.06	23.14	23.46	1
	1	12	24.46	24.46	24.70	0	23.00	23.28	23.62	1
	1	24	24.35	24.39	24.53	0	22.93	23.04	23.46	1
	12	0	23.34	23.57	23.56	1	22.13	22.34	22.50	2
	12	6	23.33	23.54	23.64	1	22.40	22.54	22.71	2
	12	13	23.28	23.52	23.63	1	22.45	22.68	22.73	2
	25	0	23.24	23.58	23.55	1	22.21	22.63	22.71	2

Band / BW	RB Size	RB Offset	QPSK			3GPP MPR (dB)	16QAM			3GPP MPR (dB)
			Low Ch 23060	Mid Ch 23095	High Ch 23130		Low Ch 23060	Mid Ch 23095	High Ch 23130	
			704.0 MHz	707.5 MHz	711.0 MHz		704.0 MHz	707.5 MHz	711.0 MHz	
12 / 10M	1	0	24.82	24.97	24.75	0	23.04	23.03	23.05	1
	1	24	24.55	24.60	24.68	0	23.18	23.15	23.28	1
	1	49	24.47	24.46	24.48	0	23.21	23.01	23.42	1
	25	0	23.19	23.59	23.47	1	22.35	22.23	22.48	2
	25	12	23.27	23.41	23.57	1	22.31	22.34	22.67	2
	25	25	23.35	23.45	23.62	1	22.45	22.45	22.66	2
	50	0	23.33	23.57	23.56	1	22.23	22.40	22.51	2

ERP Power (dBm)

LTE Band 12							
Channel Bandwidth: 1.4 MHz / QPSK							
Plane	Channel	Frequency (MHz)	LVL (dBm)	Correction Factor (dB)	ERP (dBm)	ERP (mW)	Polarization (H/V)
Y	23017	699.7	-10.51	30.36	17.70	58.88	H
	23095	707.5	-10.16	30.17	17.86	61.09	
	23173	715.3	-10.22	30.17	17.80	60.26	
	23017	699.7	-16.87	32.03	13.01	20.00	V
	23095	707.5	-16.74	31.98	13.09	20.37	
	23173	715.3	-16.89	32.06	13.02	20.04	
Channel Bandwidth: 1.4 MHz / 16QAM							
Y	23017	699.7	-11.83	30.36	16.38	43.45	H
	23095	707.5	-11.50	30.17	16.52	44.87	
	23173	715.3	-11.62	30.17	16.40	43.65	
	23017	699.7	-17.13	32.03	12.75	18.84	V
	23095	707.5	-17.03	31.98	12.80	19.05	
	23173	715.3	-17.25	32.06	12.66	18.45	

LTE Band 12							
Channel Bandwidth: 3 MHz / QPSK							
Plane	Channel	Frequency (MHz)	LVL (dBm)	Correction Factor (dB)	ERP (dBm)	ERP (mW)	Polarization (H/V)
Y	23025	700.5	-10.23	30.17	17.79	60.12	H
	23095	707.5	-10.12	30.17	17.90	61.66	
	23165	714.5	-10.15	30.18	17.88	61.38	
	23025	700.5	-16.76	31.96	13.05	20.18	V
	23095	707.5	-16.63	31.98	13.20	20.89	
	23165	714.5	-16.82	32.03	13.06	20.23	
Channel Bandwidth: 3 MHz / 16QAM							
Y	23025	700.5	-11.49	30.17	16.53	44.98	H
	23095	707.5	-11.42	30.17	16.60	45.71	
	23165	714.5	-11.47	30.18	16.56	45.29	
	23025	700.5	-17.01	31.96	12.80	19.05	V
	23095	707.5	-16.95	31.98	12.88	19.41	
	23165	714.5	-17.10	32.03	12.78	18.97	

LTE Band 12							
Channel Bandwidth: 5 MHz / QPSK							
Plane	Channel	Frequency (MHz)	LVL (dBm)	Correction Factor (dB)	ERP (dBm)	ERP (mW)	Polarization (H/V)
Y	23035	701.5	-10.10	30.17	17.92	61.94	H
	23095	707.5	-10.01	30.17	18.01	63.24	
	23155	713.5	-10.08	30.18	17.95	62.37	
	23035	701.5	-16.61	31.96	13.20	20.89	V
	23095	707.5	-16.55	31.98	13.28	21.28	
	23155	713.5	-16.71	32.03	13.17	20.75	
Channel Bandwidth: 5 MHz / 16QAM							
Y	23035	701.5	-11.40	30.17	16.62	45.92	H
	23095	707.5	-11.34	30.17	16.68	46.56	
	23155	713.5	-11.40	30.18	16.63	46.03	
	23035	701.5	-16.88	31.96	12.93	19.63	V
	23095	707.5	-16.87	31.98	12.96	19.77	
	23155	713.5	-17.01	32.03	12.87	19.36	

LTE Band 12							
Channel Bandwidth: 10 MHz / QPSK							
Plane	Channel	Frequency (MHz)	LVL (dBm)	Correction Factor (dB)	ERP (dBm)	ERP (mW)	Polarization (H/V)
Y	23060	704.0	-9.98	30.17	18.04	63.68	H
	23095	707.5	-9.92	30.17	18.10	64.57	
	23130	711.0	-10.01	30.18	18.02	63.39	
	23060	704.0	-16.53	31.96	13.28	21.28	V
	23095	707.5	-16.46	31.98	13.37	21.73	
	23130	711.0	-16.59	32.03	13.29	21.33	
Channel Bandwidth: 10 MHz / 16QAM							
Y	23060	704.0	-11.31	30.17	16.71	46.88	H
	23095	707.5	-11.29	30.17	16.73	47.10	
	23130	711.0	-11.34	30.18	16.69	46.67	
	23060	704.0	-16.81	31.96	13.00	19.95	V
	23095	707.5	-16.82	31.98	13.01	20.00	
	23130	711.0	-16.89	32.03	12.99	19.91	

EIRP Power (dBm)

LTE Band 4							
Channel Bandwidth: 1.4 MHz / QPSK							
Plane	Channel	Frequency (MHz)	LVL (dBm)	Correction Factor (dB)	EIRP (dBm)	EIRP (mW)	Polarization (H/V)
X	19957	1710.7	-15.09	36.45	21.36	136.77	H
	20175	1732.5	-15.38	36.80	21.42	138.64	
	20393	1754.3	-15.62	36.94	21.32	135.61	
	19957	1710.7	-19.53	37.28	17.75	59.53	V
	20175	1732.5	-19.81	37.63	17.82	60.53	
	20393	1754.3	-19.83	37.64	17.81	60.39	
Channel Bandwidth: 1.4 MHz / 16QAM							
X	19957	1710.7	-15.98	36.45	20.47	111.43	H
	20175	1732.5	-16.21	36.80	20.59	114.52	
	20393	1754.3	-16.51	36.94	20.43	110.48	
	19957	1710.7	-21.03	37.28	16.25	42.14	V
	20175	1732.5	-21.32	37.63	16.31	42.76	
	20393	1754.3	-21.34	37.64	16.30	42.66	

LTE Band 4							
Channel Bandwidth: 3 MHz / QPSK							
Plane	Channel	Frequency (MHz)	LVL (dBm)	Correction Factor (dB)	EIRP (dBm)	EIRP (mW)	Polarization (H/V)
X	19965	1711.5	-15.03	36.45	21.42	138.68	H
	20175	1732.5	-15.31	36.80	21.49	140.90	
	20385	1753.5	-15.57	36.94	21.37	137.18	
	19965	1711.5	-19.50	37.28	17.78	59.94	V
	20175	1732.5	-19.75	37.63	17.88	61.38	
	20385	1753.5	-19.79	37.64	17.85	60.95	
Channel Bandwidth: 3 MHz / 16QAM							
X	19965	1711.5	-15.71	36.45	20.74	118.58	H
	20175	1732.5	-15.96	36.80	20.84	121.31	
	20385	1753.5	-16.23	36.94	20.71	117.84	
	19965	1711.5	-20.94	37.28	16.34	43.02	V
	20175	1732.5	-21.18	37.63	16.45	44.16	
	20385	1753.5	-21.20	37.64	16.44	44.06	

LTE Band 4							
Channel Bandwidth: 5 MHz / QPSK							
Plane	Channel	Frequency (MHz)	LVL (dBm)	Correction Factor (dB)	EIRP (dBm)	EIRP (mW)	Polarization (H/V)
X	19975	1712.5	-14.98	36.45	21.47	140.28	H
	20175	1732.5	-15.29	36.80	21.51	141.55	
	20375	1752.5	-15.48	36.94	21.46	140.06	
	19975	1712.5	-19.41	37.28	17.87	61.19	V
	20175	1732.5	-19.69	37.63	17.94	62.23	
	20375	1752.5	-19.73	37.64	17.91	61.80	
Channel Bandwidth: 5 MHz / 16QAM							
X	19975	1712.5	-15.64	36.45	20.81	120.50	H
	20175	1732.5	-15.86	36.80	20.94	124.14	
	20375	1752.5	-16.11	36.94	20.83	121.14	
	19975	1712.5	-20.83	37.28	16.45	44.13	V
	20175	1732.5	-21.11	37.63	16.52	44.87	
	20375	1752.5	-21.13	37.64	16.51	44.77	

LTE Band 4							
Channel Bandwidth: 10 MHz / QPSK							
Plane	Channel	Frequency (MHz)	LVL (dBm)	Correction Factor (dB)	EIRP (dBm)	EIRP (mW)	Polarization (H/V)
X	20000	1715.0	-15.11	36.64	21.53	142.23	H
	20175	1732.5	-15.23	36.80	21.57	143.38	
	20350	1750.0	-15.31	36.80	21.49	140.93	
	20000	1715.0	-19.48	37.44	17.96	62.50	V
	20175	1732.5	-19.64	37.63	17.99	62.94	
	20350	1750.0	-19.70	37.64	17.94	62.16	
Channel Bandwidth: 10 MHz / 16QAM							
X	20000	1715.0	-15.71	36.64	20.93	123.88	H
	20175	1732.5	-15.81	36.80	20.99	125.46	
	20350	1750.0	-15.85	36.80	20.95	124.45	
	20000	1715.0	-20.91	37.44	16.53	44.97	V
	20175	1732.5	-21.09	37.63	16.54	45.07	
	20350	1750.0	-21.12	37.64	16.52	44.82	

LTE Band 4							
Channel Bandwidth: 15 MHz / QPSK							
Plane	Channel	Frequency (MHz)	LVL (dBm)	Correction Factor (dB)	EIRP (dBm)	EIRP (mW)	Polarization (H/V)
X	20025	1717.5	-14.87	36.45	21.58	143.88	H
	20175	1732.5	-15.14	36.80	21.66	146.52	
	20325	1747.5	-15.32	36.94	21.62	145.31	
	20025	1717.5	-19.27	37.28	18.01	63.20	V
	20175	1732.5	-19.57	37.63	18.06	63.97	
	20325	1747.5	-19.61	37.64	18.03	63.53	
Channel Bandwidth: 15 MHz / 16QAM							
X	20025	1717.5	-15.42	36.45	21.03	126.77	H
	20175	1732.5	-15.74	36.80	21.06	127.61	
	20325	1747.5	-15.90	36.94	21.04	127.15	
	20025	1717.5	-20.70	37.28	16.58	45.47	V
	20175	1732.5	-20.99	37.63	16.64	46.13	
	20325	1747.5	-21.05	37.64	16.59	45.60	

LTE Band 4							
Channel Bandwidth: 20 MHz / QPSK							
Plane	Channel	Frequency (MHz)	LVL (dBm)	Correction Factor (dB)	EIRP (dBm)	EIRP (mW)	Polarization (H/V)
X	20050	1720.0	-14.73	36.45	21.72	148.59	H
	20175	1732.5	-15.07	36.80	21.73	148.90	
	20300	1745.0	-15.30	36.94	21.64	145.98	
	20050	1720.0	-19.20	37.28	18.08	64.22	V
	20175	1732.5	-19.49	37.63	18.14	65.16	
	20300	1745.0	-19.53	37.64	18.11	64.71	
Channel Bandwidth: 20 MHz / 16QAM							
X	20050	1720.0	-15.31	36.45	21.14	130.02	H
	20175	1732.5	-15.64	36.80	21.16	130.59	
	20300	1745.0	-15.82	36.94	21.12	129.51	
	20050	1720.0	-20.62	37.28	16.66	46.31	V
	20175	1732.5	-20.91	37.63	16.72	46.99	
	20300	1745.0	-21.01	37.64	16.63	46.03	

4.2 Frequency Stability Measurement

4.2.1 Limits of Frequency Stability Measurement

The frequency stability shall be sufficient to ensure that the fundamental emissions stay within the authorized bands of operation.

4.2.2 Test Procedure

- a. Device is placed at the oven room. The oven room could control the temperatures and humidity. Power warm up is at least 15 min and power applied should perform before recording frequency error.
- b. EUT is connected the external power supply to control the DC input power. The test voltage range is from minimum to maximum working voltage. Each step shall be record the frequency error rate.
- c. The temperature range step is 10 degrees in this test items. All temperature levels shall be hold the ± 0.5 °C during the measurement testing. The each temperature step shall be at least 0.5 hours, consider the EUT could be test under the stability condition.

Note: The frequency error was recorded frequency error from the communication simulator.

4.2.3 Test Setup

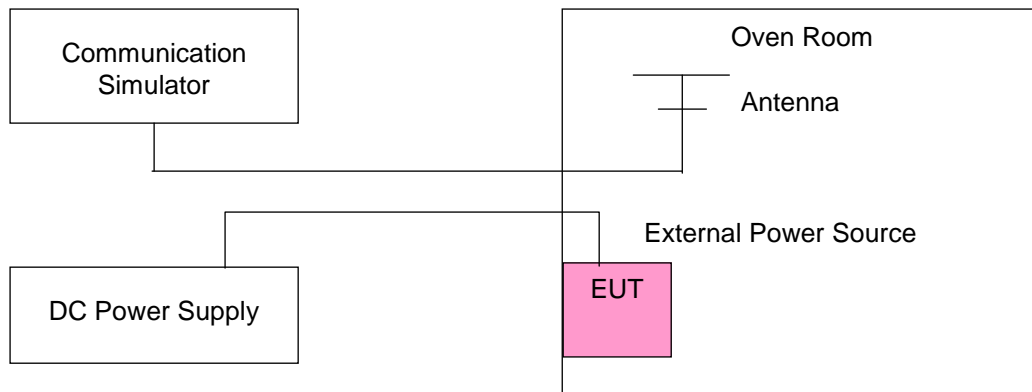

4.2.4 Test Results

Frequency Error vs. Voltage

Voltage (Volts)	LTE Band 4				Limit (ppm)
	1.4 MHz		3 MHz		
	Frequency (MHz)	Frequency Error (ppm)	Frequency (MHz)	Frequency Error (ppm)	
3.8	1732.500002	0.001	1732.500003	0.002	2.5
3.5	1732.500002	0.001	1732.500003	0.002	2.5
4.35	1732.500003	0.002	1732.500001	0.001	2.5

Note: The applicant defined the normal working voltage of the battery is from 3.5 Vdc to 4.35 Vdc.

Frequency Error vs. Temperature

Temp. (°C)	LTE Band 4				Limit (ppm)
	1.4 MHz		3 MHz		
	Frequency (MHz)	Frequency Error (ppm)	Frequency (MHz)	Frequency Error (ppm)	
-30	1732.500002	0.001	1732.500002	0.001	2.5
-20	1732.500002	0.001	1732.500001	0.001	2.5
-10	1732.500004	0.002	1732.500004	0.002	2.5
0	1732.500002	0.001	1732.500004	0.002	2.5
10	1732.500003	0.002	1732.500001	0.001	2.5
20	1732.499998	-0.001	1732.499999	-0.001	2.5
30	1732.499999	-0.001	1732.499999	-0.001	2.5
40	1732.499996	-0.002	1732.499998	-0.001	2.5
50	1732.499999	-0.001	1732.499998	-0.001	2.5
55	1732.499997	-0.002	1732.499998	-0.001	2.5

Frequency Error vs. Voltage

Voltage (Volts)	LTE Band 4				Limit (ppm)
	5 MHz		10 MHz		
	Frequency (MHz)	Frequency Error (ppm)	Frequency (MHz)	Frequency Error (ppm)	
3.8	1732.500001	0.001	1732.500003	0.002	2.5
3.5	1732.500002	0.001	1732.500001	0.001	2.5
4.35	1732.500003	0.002	1732.500002	0.001	2.5

Note: The applicant defined the normal working voltage of the battery is from 3.5 Vdc to 4.35 Vdc.

Frequency Error vs. Temperature

Temp. (°C)	LTE Band 4				Limit (ppm)
	5 MHz		10 MHz		
	Frequency (MHz)	Frequency Error (ppm)	Frequency (MHz)	Frequency Error (ppm)	
-30	1732.500003	0.002	1732.500001	0.001	2.5
-20	1732.500002	0.001	1732.500003	0.002	2.5
-10	1732.500004	0.002	1732.500003	0.002	2.5
0	1732.500002	0.001	1732.500001	0.001	2.5
10	1732.500002	0.001	1732.500004	0.002	2.5
20	1732.499998	-0.001	1732.499997	-0.002	2.5
30	1732.499996	-0.002	1732.499996	-0.002	2.5
40	1732.499997	-0.002	1732.499997	-0.002	2.5
50	1732.499998	-0.001	1732.499997	-0.002	2.5
55	1732.499997	-0.002	1732.499998	-0.001	2.5

Frequency Error vs. Voltage

Voltage (Volts)	LTE Band 4				Limit (ppm)
	15 MHz		20 MHz		
	Frequency (MHz)	Frequency Error (ppm)	Frequency (MHz)	Frequency Error (ppm)	
3.8	1732.500002	0.001	1732.500003	0.002	2.5
3.5	1732.500003	0.002	1732.500001	0.001	2.5
4.35	1732.500001	0.001	1732.500003	0.002	2.5

Note: The applicant defined the normal working voltage of the battery is from 3.5 Vdc to 4.35 Vdc.

Frequency Error vs. Temperature

Temp. (°C)	LTE Band 4				Limit (ppm)
	15 MHz		20 MHz		
	Frequency (MHz)	Frequency Error (ppm)	Frequency (MHz)	Frequency Error (ppm)	
-30	1732.500003	0.002	1732.500003	0.002	2.5
-20	1732.500003	0.002	1732.500004	0.002	2.5
-10	1732.500002	0.001	1732.500002	0.001	2.5
0	1732.500002	0.001	1732.500003	0.002	2.5
10	1732.500003	0.002	1732.500003	0.002	2.5
20	1732.499996	-0.002	1732.499999	-0.001	2.5
30	1732.499997	-0.002	1732.499997	-0.002	2.5
40	1732.499999	-0.001	1732.499998	-0.001	2.5
50	1732.499998	-0.001	1732.499997	-0.002	2.5
55	1732.499996	-0.002	1732.499997	-0.002	2.5

Frequency Error vs. Voltage

Voltage (Volts)	LTE Band 12				Limit (ppm)
	1.4 MHz		3 MHz		
	Frequency (MHz)	Frequency Error (ppm)	Frequency (MHz)	Frequency Error (ppm)	
3.8	707.500004	0.005	707.500004	0.005	2.5
3.5	707.500001	0.001	707.500004	0.005	2.5
4.35	707.500002	0.003	707.500003	0.004	2.5

Note: The applicant defined the normal working voltage of the battery is from 3.5 Vdc to 4.35 Vdc.

Frequency Error vs. Temperature

Temp. (°C)	LTE Band 12				Limit (ppm)
	1.4 MHz		3 MHz		
	Frequency (MHz)	Frequency Error (ppm)	Frequency (MHz)	Frequency Error (ppm)	
-30	707.500003	0.004	707.500003	0.005	2.5
-20	707.500002	0.002	707.500001	0.002	2.5
-10	707.500003	0.004	707.500002	0.002	2.5
0	707.500001	0.002	707.500004	0.005	2.5
10	707.500001	0.002	707.500003	0.004	2.5
20	707.499999	-0.002	707.499996	-0.005	2.5
30	707.499997	-0.005	707.499999	-0.002	2.5
40	707.499997	-0.004	707.499997	-0.005	2.5
50	707.499998	-0.004	707.499996	-0.005	2.5
55	707.499997	-0.004	707.499998	-0.004	2.5

Frequency Error vs. Voltage

Voltage (Volts)	LTE Band 12				Limit (ppm)
	5 MHz		10 MHz		
	Frequency (MHz)	Frequency Error (ppm)	Frequency (MHz)	Frequency Error (ppm)	
3.8	707.500003	0.004	707.500002	0.002	2.5
3.5	707.500003	0.004	707.500002	0.003	2.5
4.35	707.500002	0.002	707.500002	0.003	2.5

Note: The applicant defined the normal working voltage of the battery is from 3.5 Vdc to 4.35 Vdc.

Frequency Error vs. Temperature

Temp. (°C)	LTE Band 12				Limit (ppm)
	5 MHz		10 MHz		
	Frequency (MHz)	Frequency Error (ppm)	Frequency (MHz)	Frequency Error (ppm)	
-30	707.500002	0.002	707.500004	0.005	2.5
-20	707.500003	0.004	707.500003	0.004	2.5
-10	707.500003	0.004	707.500002	0.003	2.5
0	707.500002	0.003	707.500004	0.005	2.5
10	707.500003	0.005	707.500004	0.006	2.5
20	707.499996	-0.005	707.499998	-0.002	2.5
30	707.499997	-0.004	707.499996	-0.006	2.5
40	707.499998	-0.003	707.499998	-0.003	2.5
50	707.499998	-0.003	707.499998	-0.003	2.5
55	707.499999	-0.002	707.499998	-0.004	2.5

4.3 Occupied Bandwidth Measurement

4.3.1 Limits of Occupied Bandwidth Measurement

The width of a frequency band such that, below the lower and above the upper frequency limits, the mean powers emitted are each equal to a specified percentage 0.5 % of the total mean power of a given emission.

4.3.2 Test Procedure

- a. The conducted occupied bandwidth used the power splitter via EUT RF power connector between simulation base station and spectrum analyzer.
- b. Use OBW measurement function of Spectrum analyzer to measure 99 % occupied bandwidth.

4.3.3 Test Setup

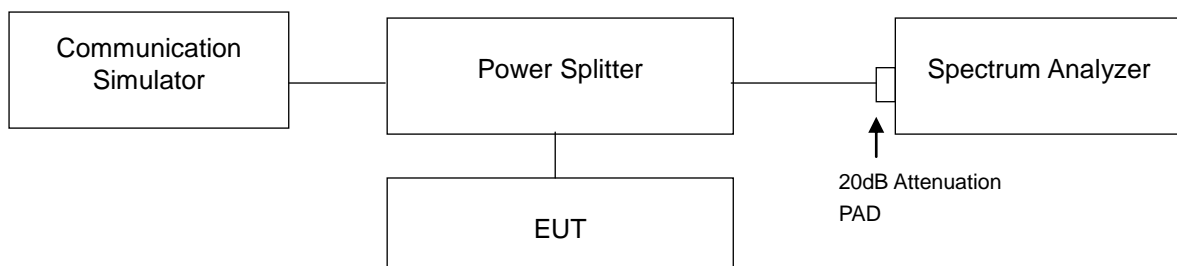

4.3.4 Test Result

LTE Band 4							
Channel Bandwidth: 1.4 MHz				Channel Bandwidth: 3 MHz			
Channel	Frequency (MHz)	99 % Occupied Bandwidth (MHz)		Channel	Frequency (MHz)	99 % Occupied Bandwidth (MHz)	
		QPSK	16QAM			QPSK	16QAM
19957	1710.7	1.0872	1.0878	19965	1711.5	2.6950	2.6981
20175	1732.5	1.0864	1.0891	20175	1732.5	2.7001	2.6982
20393	1754.3	1.0894	1.0892	20385	1753.5	2.7013	2.6985

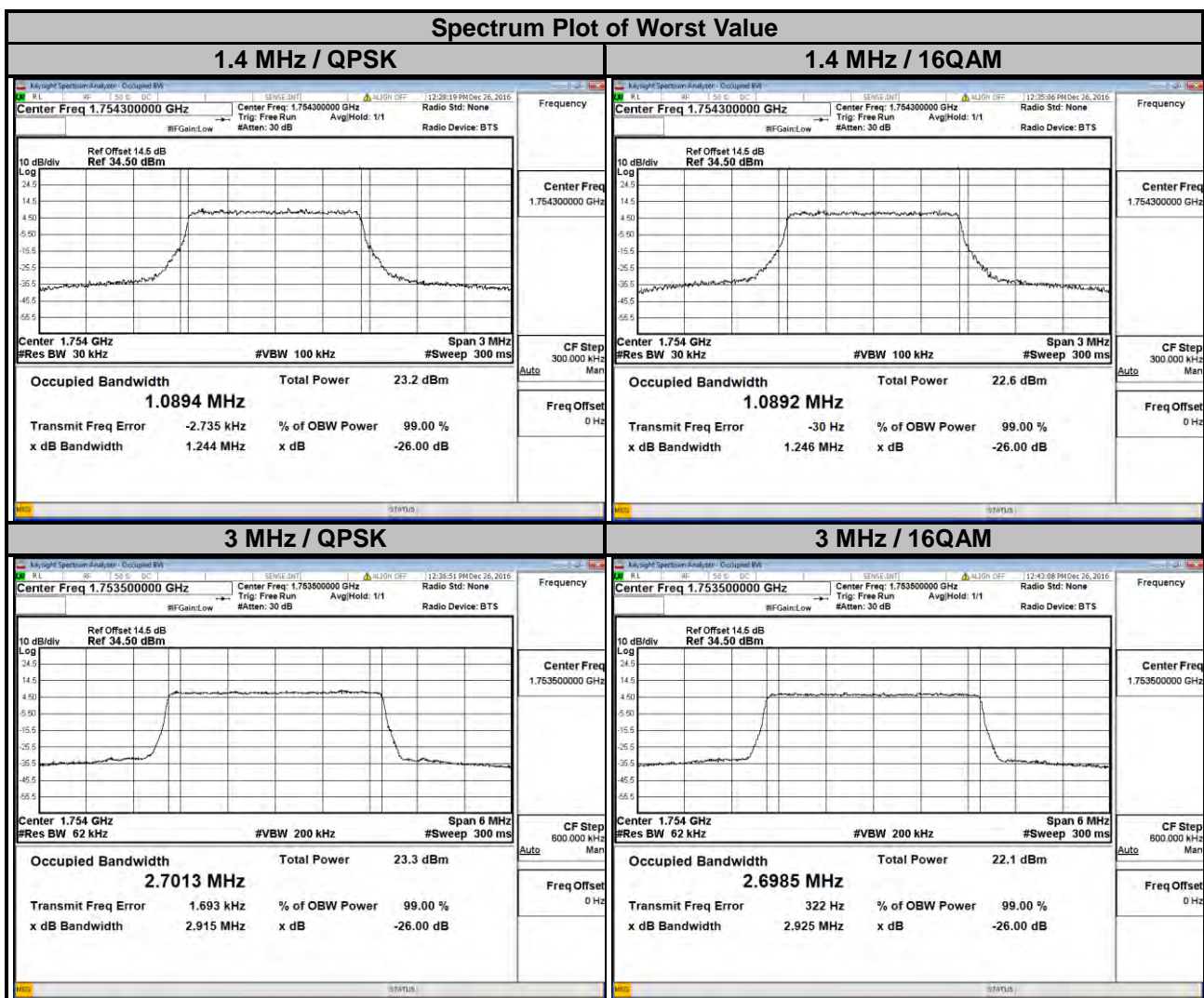

LTE Band 4

Channel Bandwidth: 5 MHz				Channel Bandwidth: 10 MHz			
Channel	Frequency (MHz)	99 % Occupied Bandwidth (MHz)		Channel	Frequency (MHz)	99 % Occupied Bandwidth (MHz)	
		QPSK	16QAM			QPSK	16QAM
19975	1712.5	4.4910	4.4951	20000	1715.0	8.9603	8.9665
20175	1732.5	4.4886	4.4876	20175	1732.5	8.9396	8.9450
20375	1752.5	4.4899	4.4913	20350	1750.0	8.9568	8.9570

Spectrum Plot of Worst Value

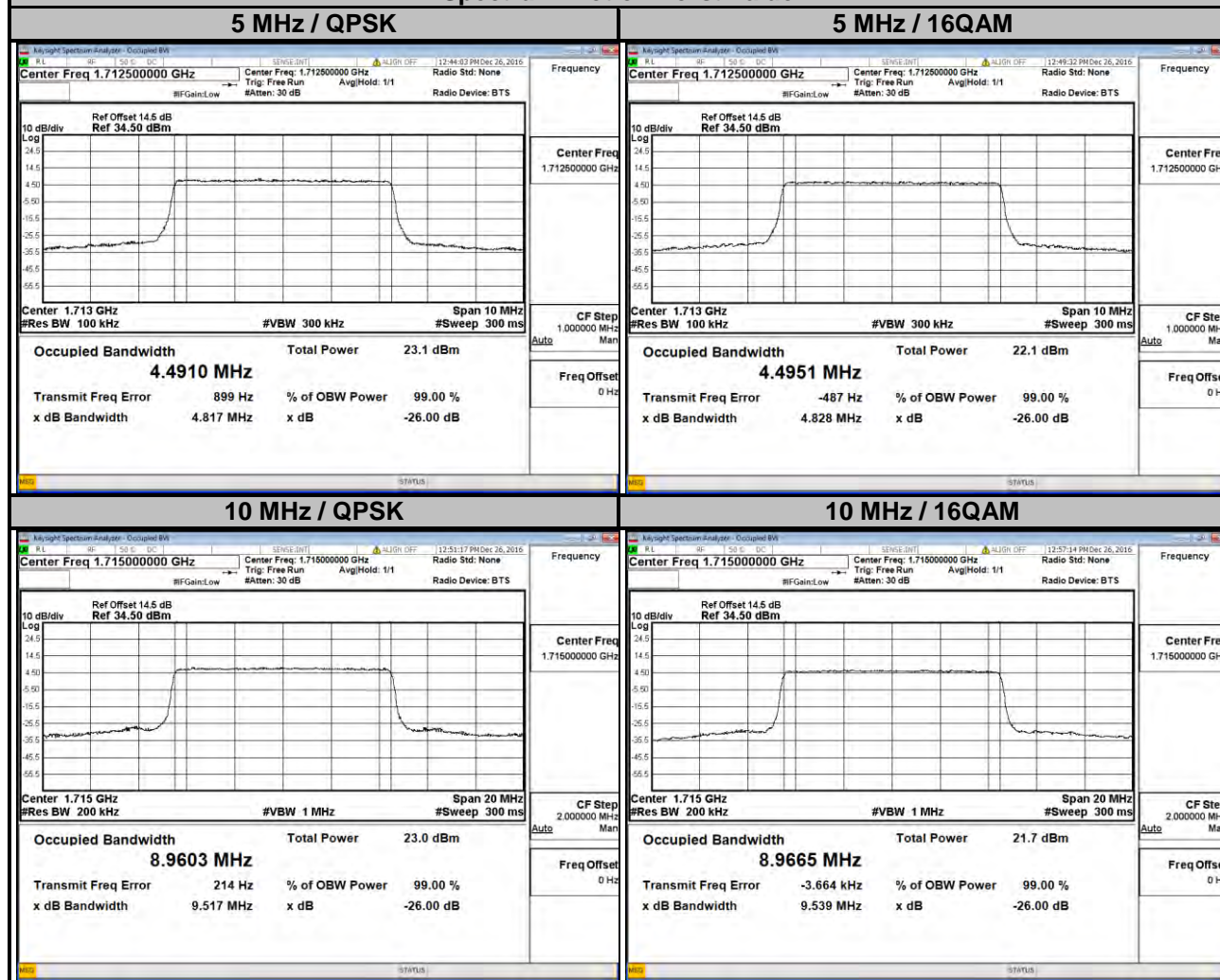

LTE Band 4

Channel Bandwidth: 15 MHz

Channel Bandwidth: 20 MHz

Channel	Frequency (MHz)	99 % Occupied Bandwidth (MHz)		Channel	Frequency (MHz)	99 % Occupied Bandwidth (MHz)	
		QPSK	16QAM			QPSK	16QAM
20025	1717.5	13.459	13.449	20050	1720.0	17.927	17.939
20175	1732.5	13.403	13.392	20175	1732.5	17.825	17.848
20325	1747.5	13.453	13.442	20300	1745.0	17.924	17.945

Spectrum Plot of Worst Value

15 MHz / QPSK

15 MHz / 16QAM

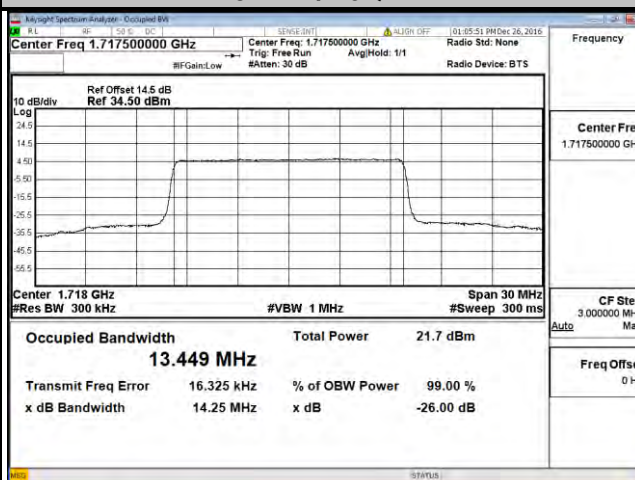
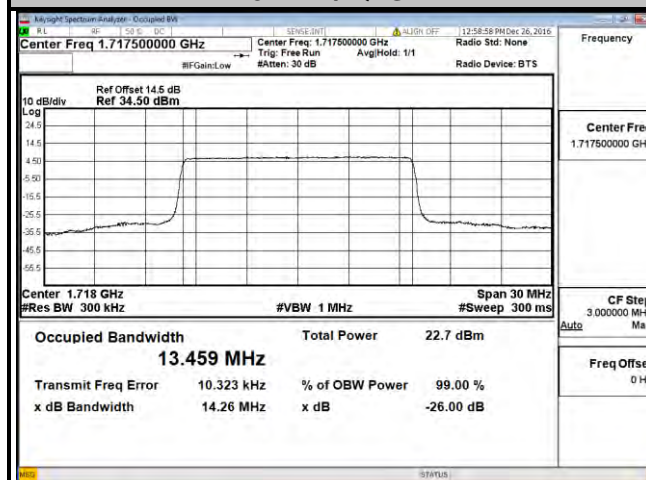

20 MHz / QPSK

20 MHz / 16QAM

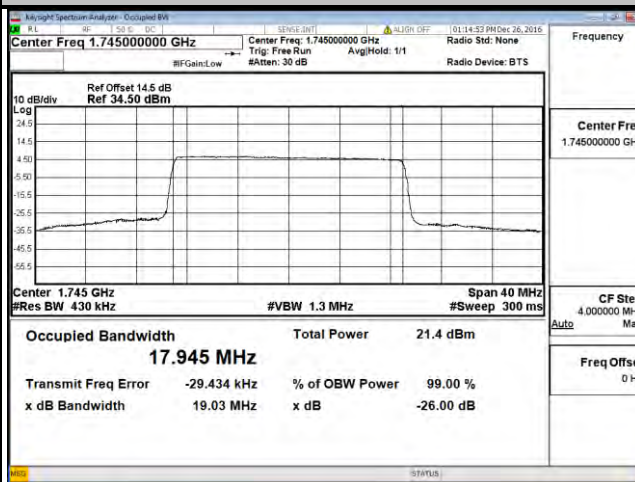
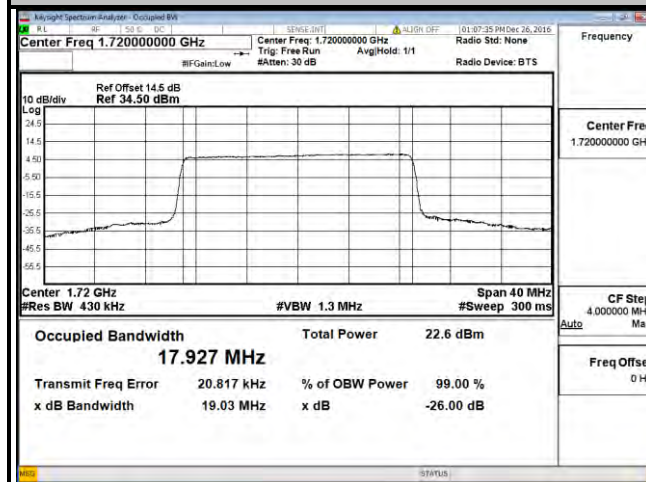

LTE Band 12

Channel Bandwidth: 1.4 MHz				Channel Bandwidth: 3 MHz			
Channel	Frequency (MHz)	99 % Occupied Bandwidth (MHz)		Channel	Frequency (MHz)	99 % Occupied Bandwidth (MHz)	
		QPSK	16QAM			QPSK	16QAM
23017	699.7	1.0885	1.0906	23025	700.5	2.7019	2.6971
23095	707.5	1.0886	1.0913	23095	707.5	2.7029	2.6991
23173	715.3	1.0877	1.0899	23165	714.5	2.7019	2.6981

Spectrum Plot of Worst Value

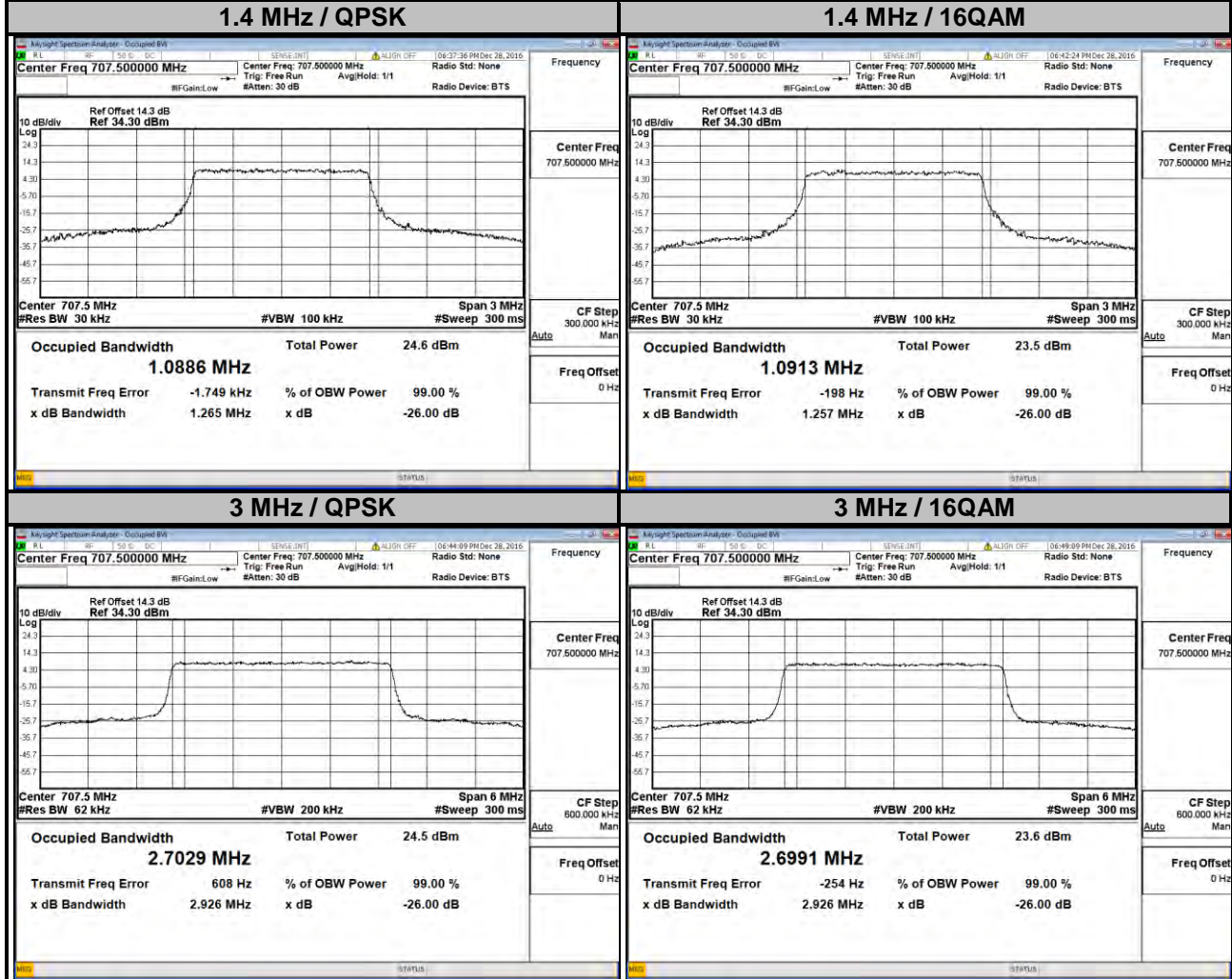

LTE Band 12

Channel Bandwidth: 5 MHz				Channel Bandwidth: 10 MHz			
Channel	Frequency (MHz)	99 % Occupied Bandwidth (MHz)		Channel	Frequency (MHz)	99 % Occupied Bandwidth (MHz)	
		QPSK	16QAM			QPSK	16QAM
23035	701.5	4.4869	4.4885	23060	704.0	8.9468	8.9469
23095	707.5	4.4894	4.4923	23095	707.5	8.9572	8.9588
23155	713.5	4.4885	4.4902	23130	711.0	8.9505	8.9590

Spectrum Plot of Worst Value

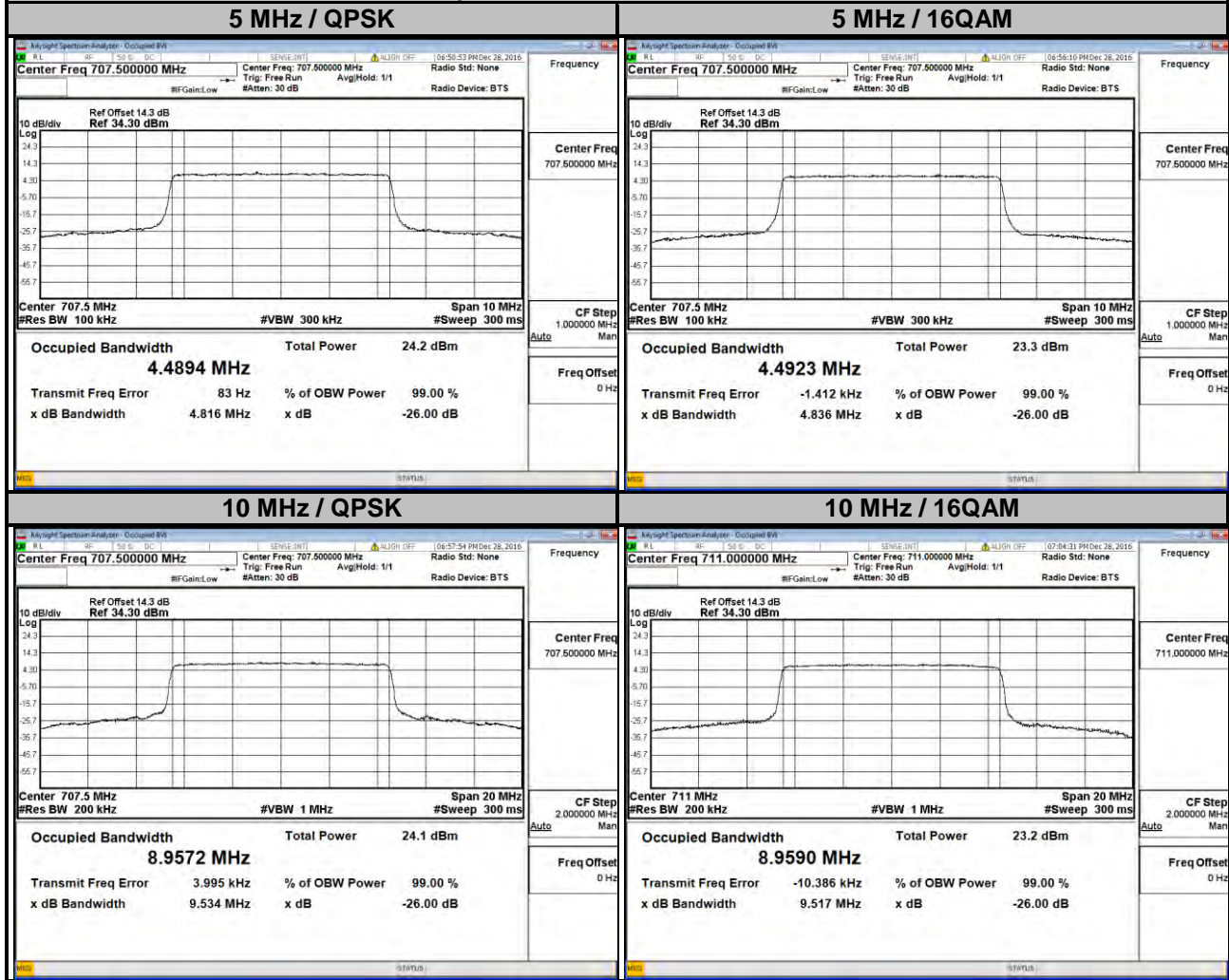

4.4 Band Edge Measurement

4.4.1 Limits of Band Edge Measurement

For operations in the 698-716 MHz band, the power of any emission outside a licensee's frequency band(s) of operation shall be attenuated below the transmitter power (P) within the licensed band(s) of operation, measured in watts, by at least $43 + 10 \log(P)$ dB. Compliance with this provision is based on the use of measurement instrumentation employing a resolution bandwidth of 100 kilohertz or greater.

However, in the 100 kilohertz bands immediately outside and adjacent to a licensee's frequency block, a resolution bandwidth of at least 30 kHz may be employed.

For operations in the 1710–1755 MHz bands, the power of any emission outside a licensee's frequency block shall be attenuated below the transmitter power (P) by at least $43 + 10 \log_{10}(P)$ dB.

4.4.2 Test Setup

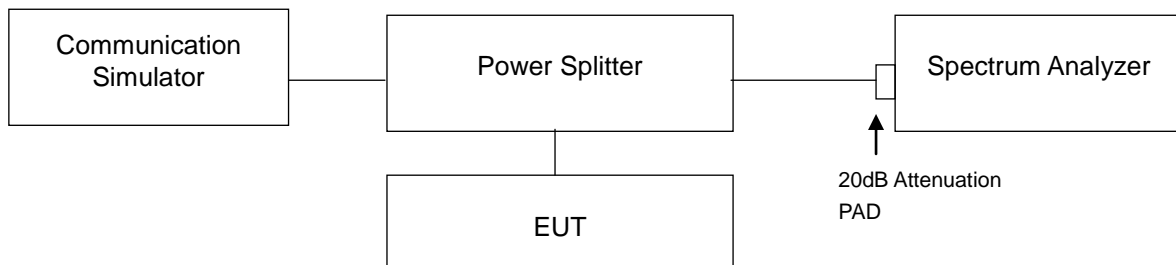

4.4.3 Test Procedures

- a. All measurements were done at low and high operational frequency range.
- b. The center frequency of spectrum is the band edge frequency and span is 1 MHz. RB of the spectrum is 13 kHz and VB of the spectrum is 51 kHz (LTE Bandwidth 1.4 MHz).
- c. The center frequency of spectrum is the band edge frequency and span is 1 MHz. RB of the spectrum is 30 kHz and VB of the spectrum is 100 kHz (LTE Bandwidth 3 MHz).
- d. The center frequency of spectrum is the band edge frequency and span is 1 MHz. RB of the spectrum is 100 kHz and VB of the spectrum is 300 kHz (LTE Bandwidth 5 MHz/10 MHz).
- e. The center frequency of spectrum is the band edge frequency and span is 1 MHz. RB of the spectrum is 150 kHz and VB of the spectrum is 470 kHz (LTE Bandwidth 15 MHz).
- f. The center frequency of spectrum is the band edge frequency and span is 1 MHz. RB of the spectrum is 180 kHz and VB of the spectrum is 560 kHz (LTE Bandwidth 20 MHz).
- g. Record the max trace plot into the test report.

4.4.4 Test Results

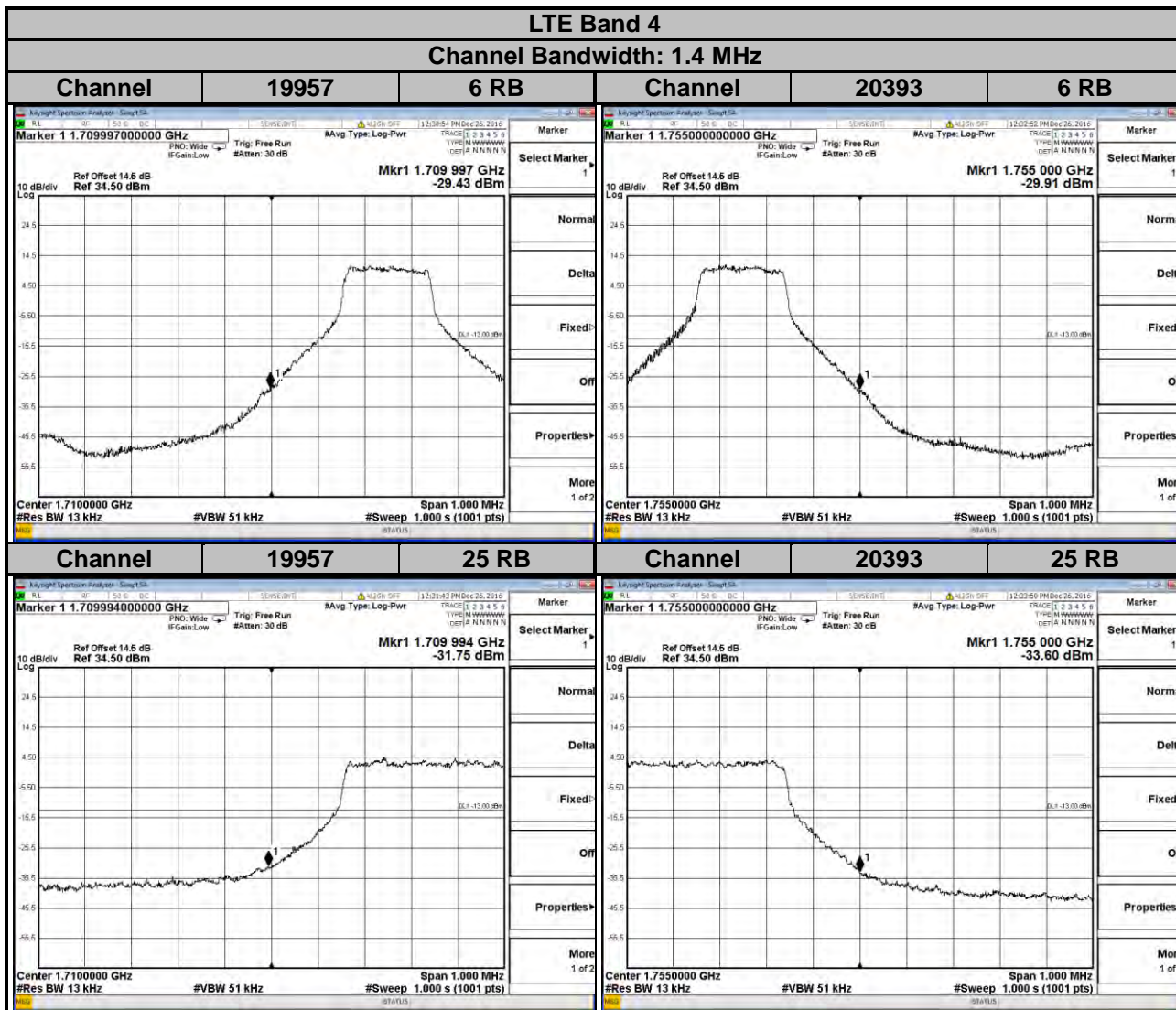

LTE Band 4
Channel Bandwidth: 3 MHz

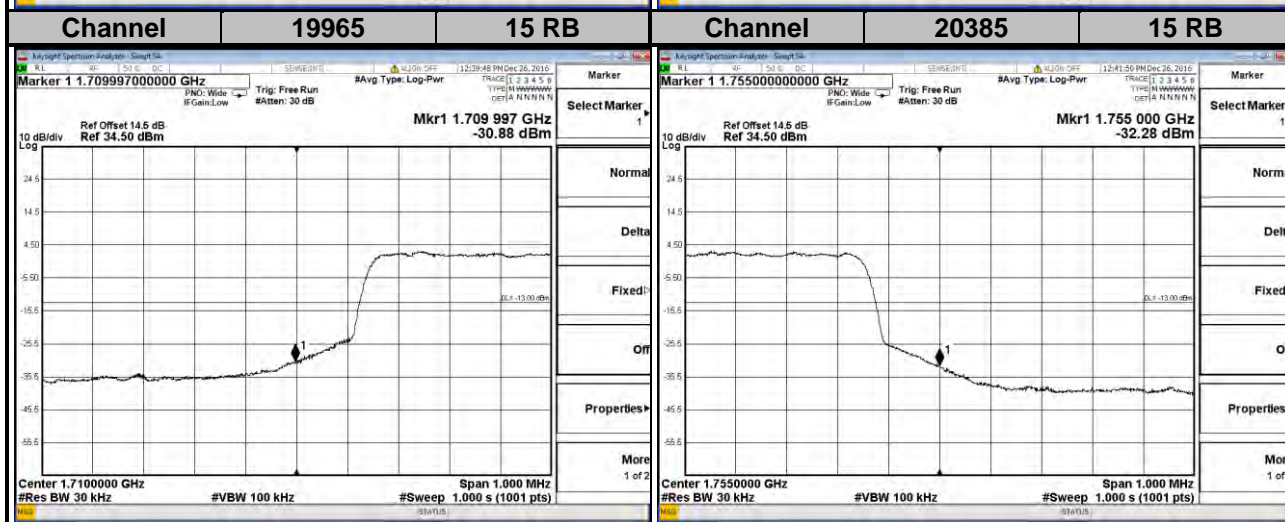
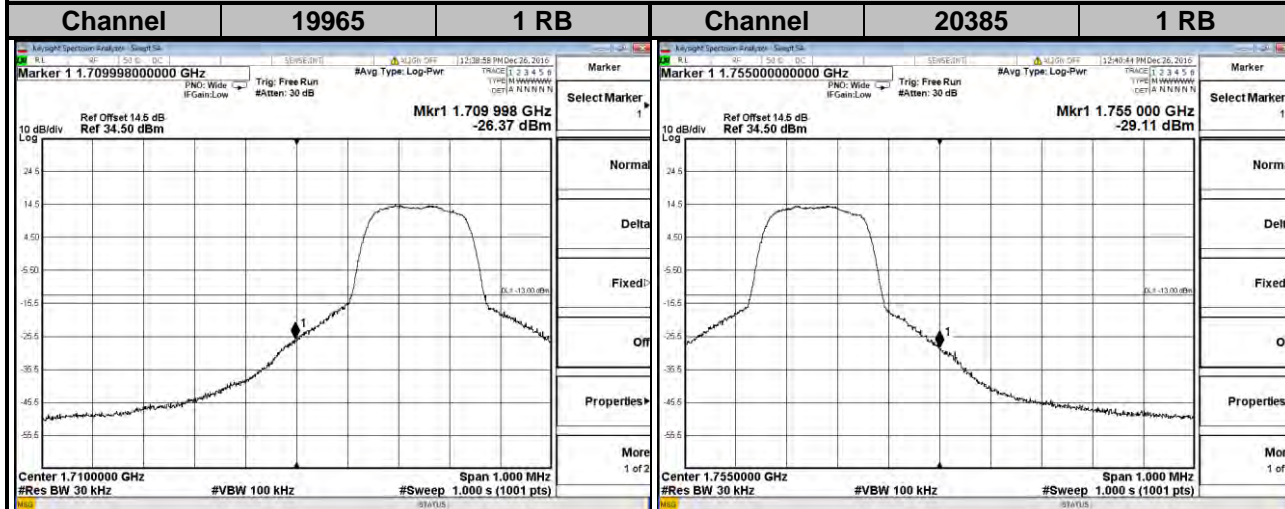

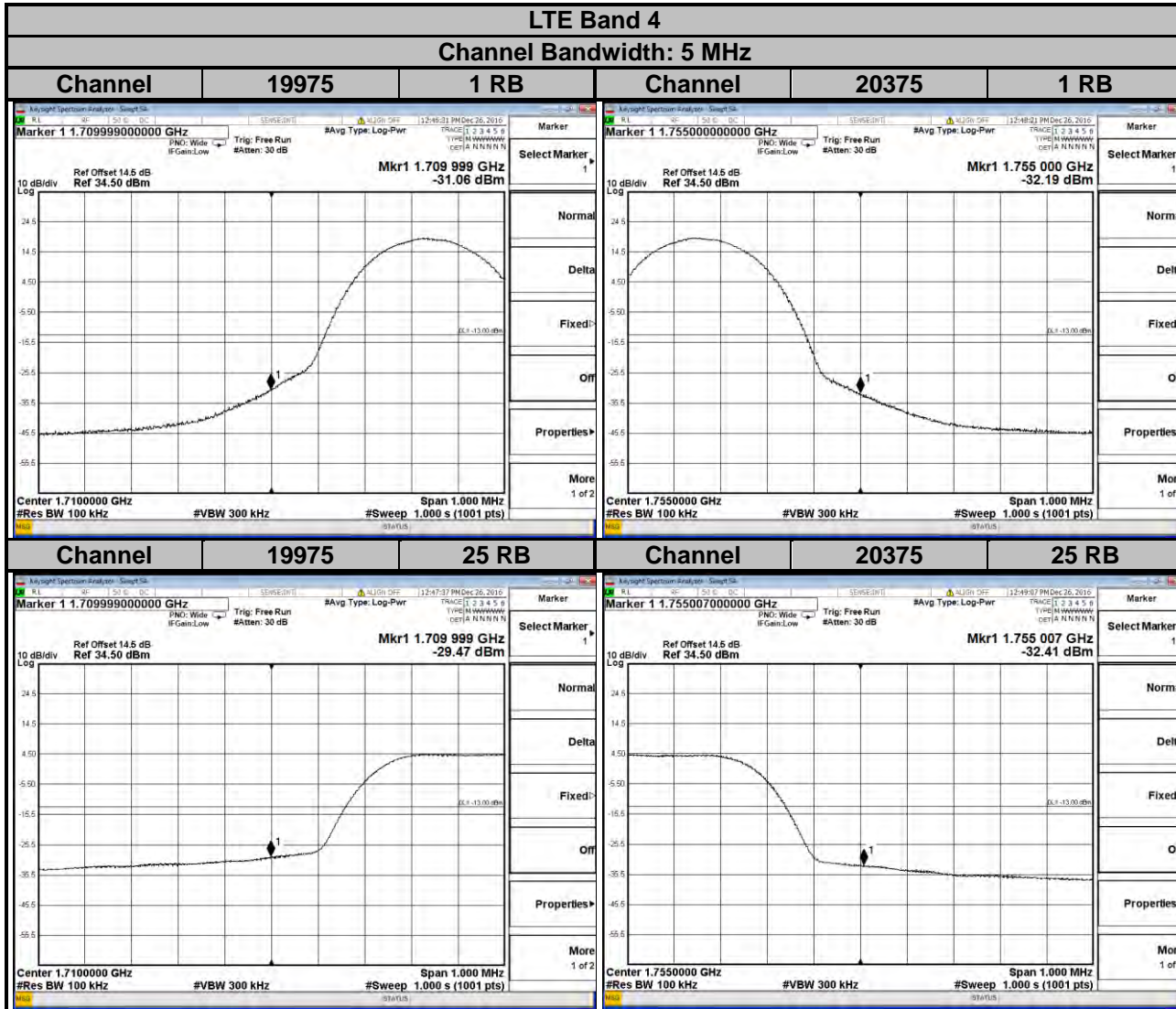

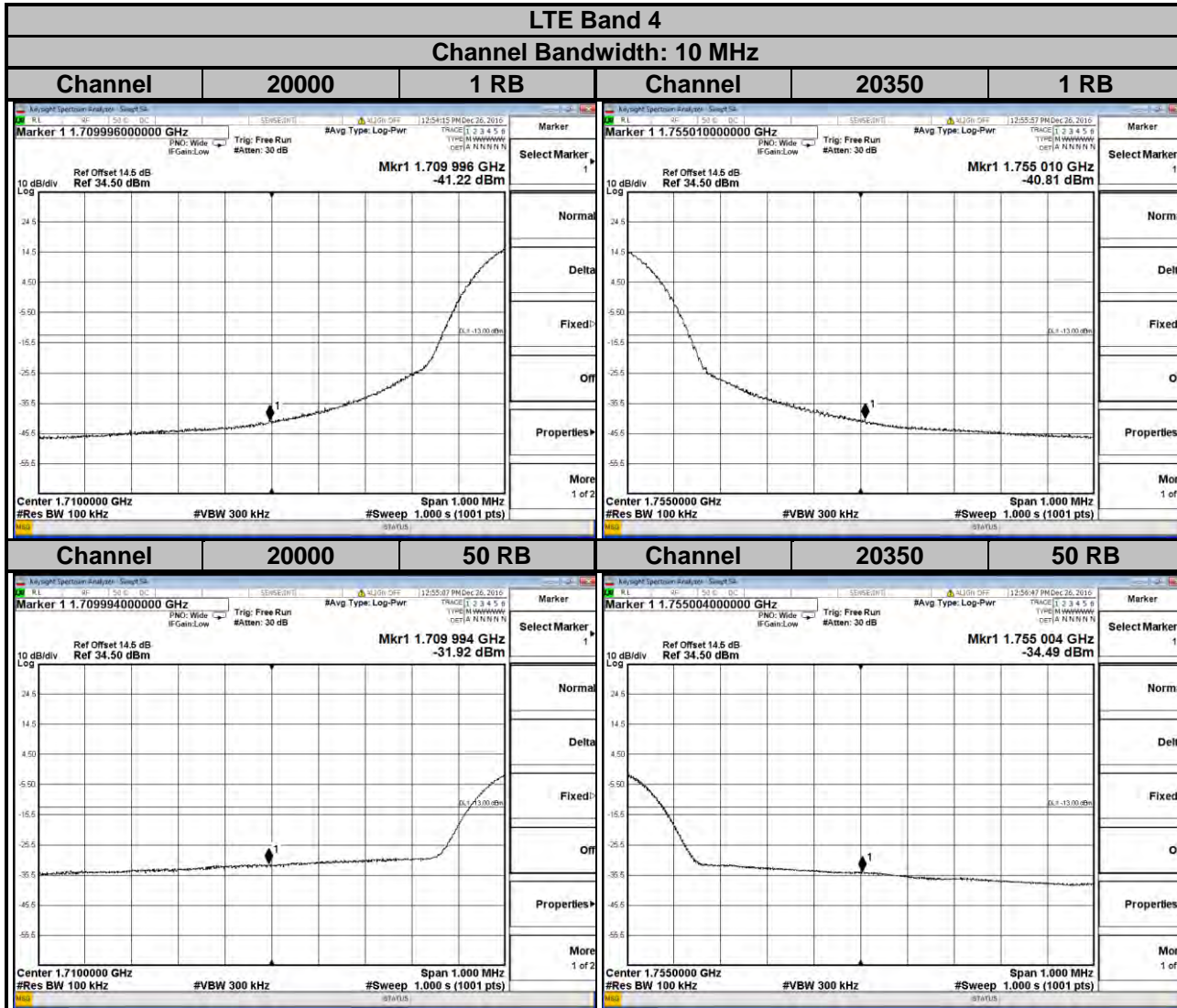

LTE Band 4
Channel Bandwidth: 15 MHz

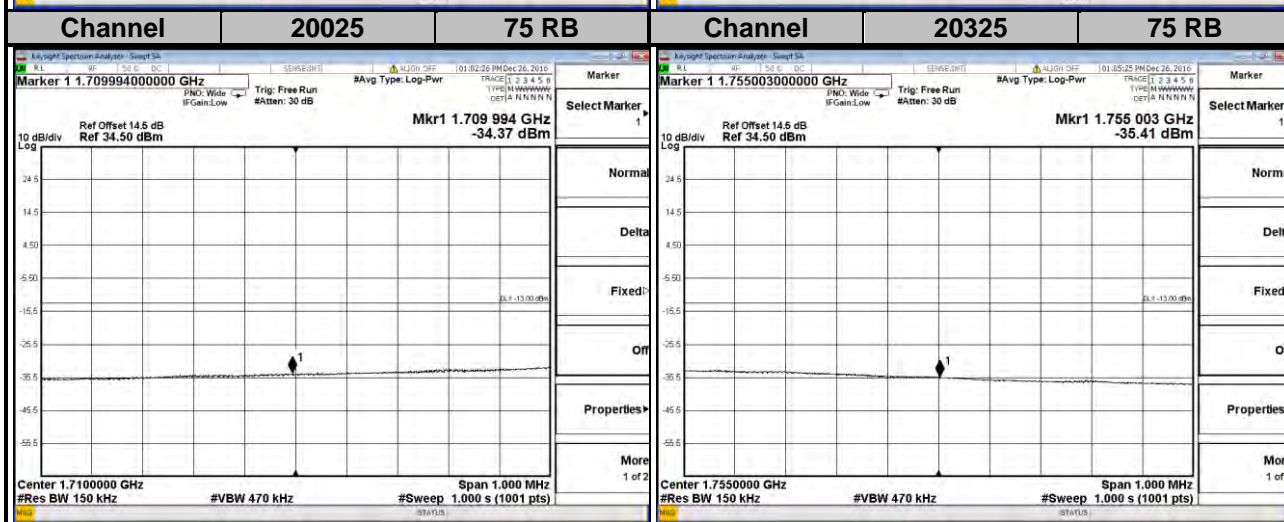
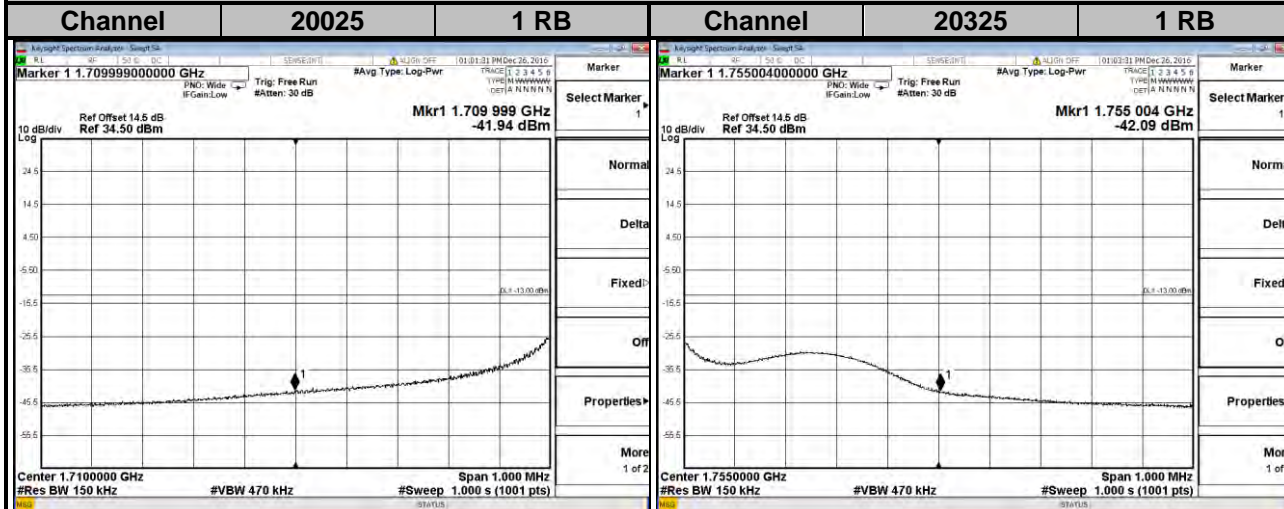

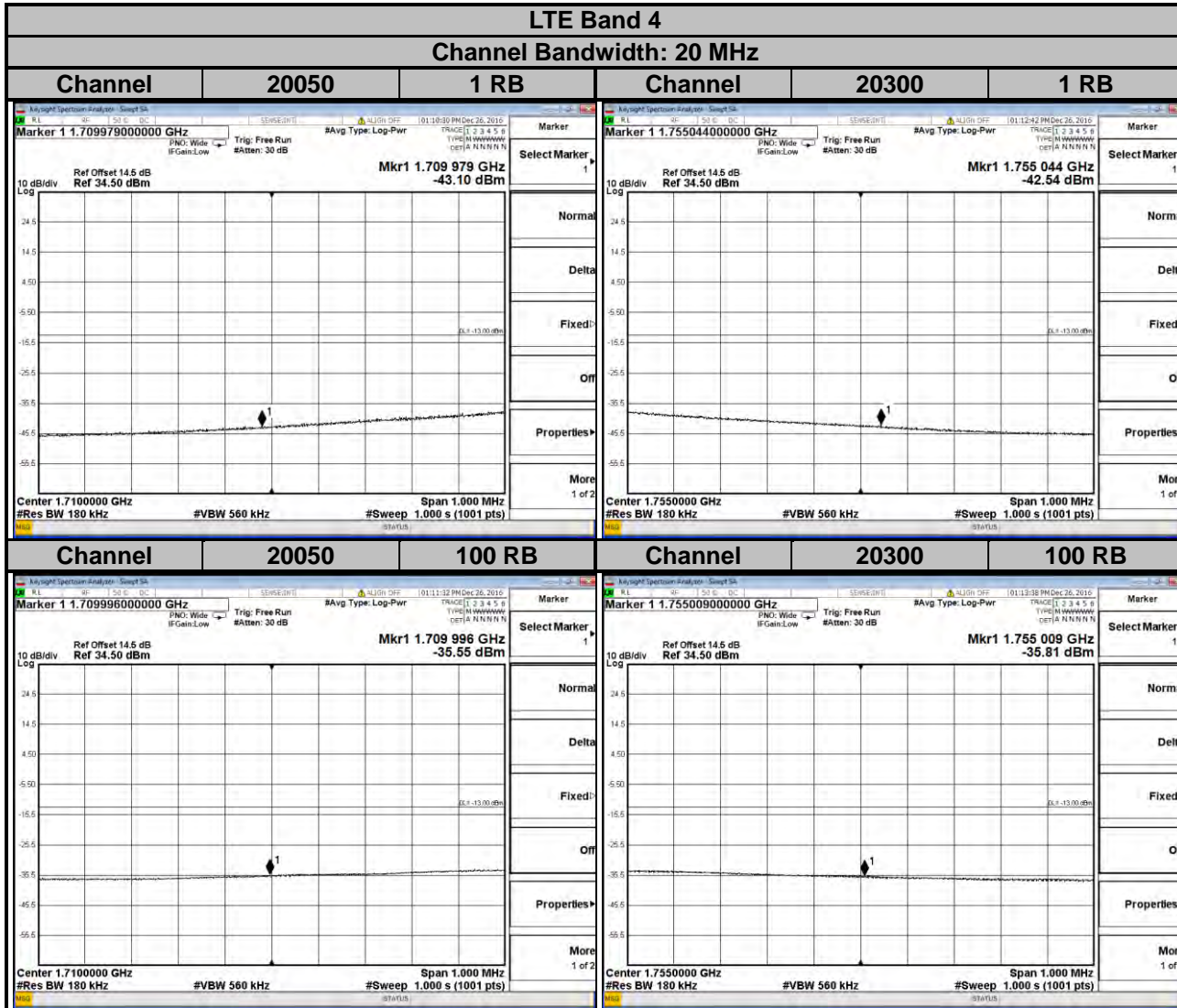

LTE Band 12

Channel Bandwidth: 1.4 MHz

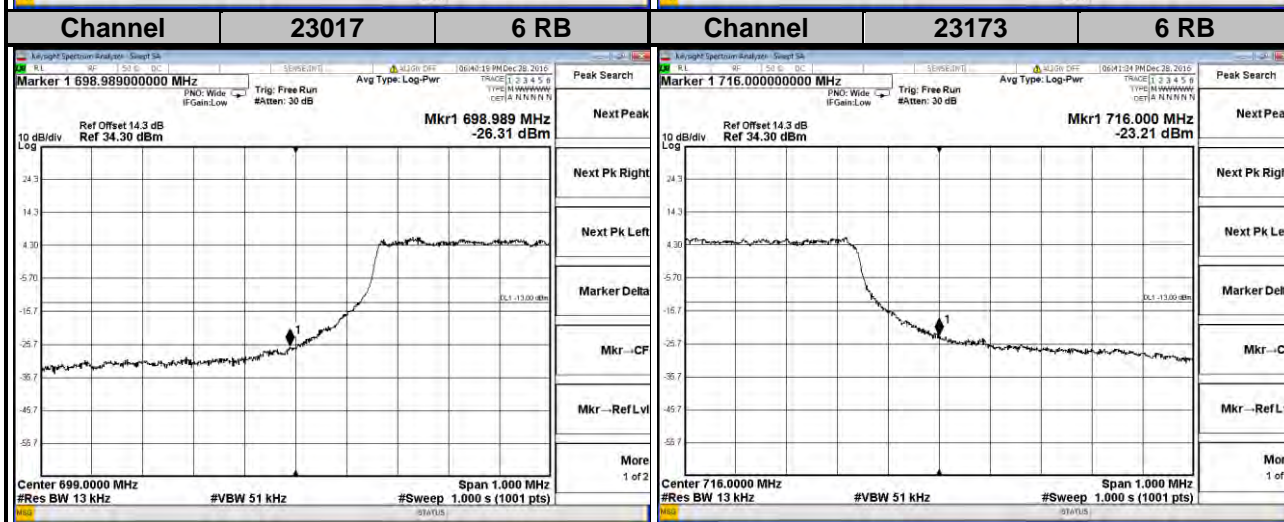
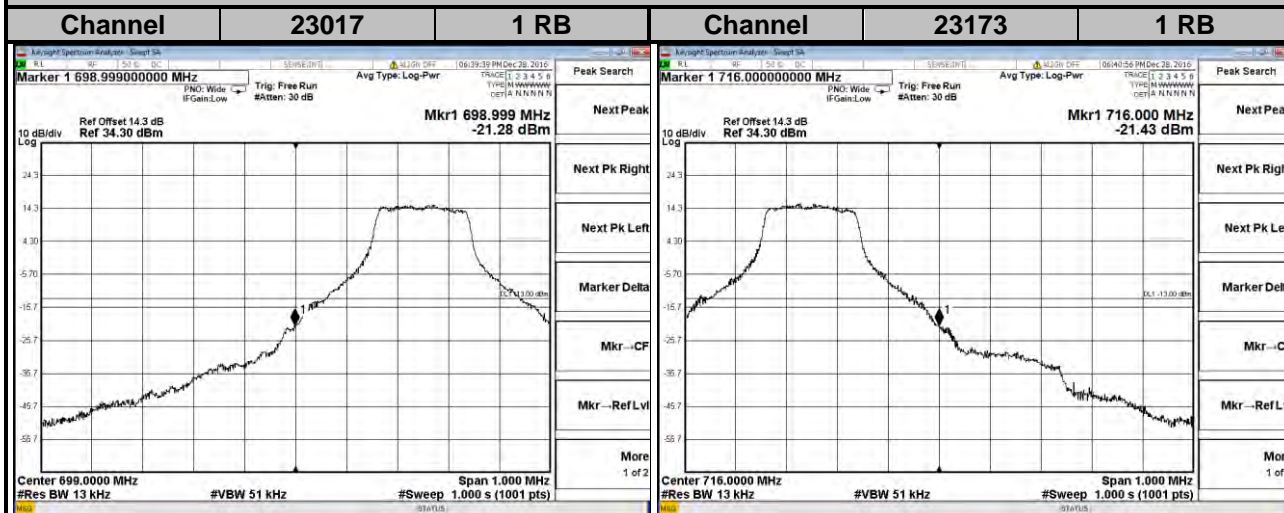

LTE Band 12

Channel Bandwidth: 3 MHz

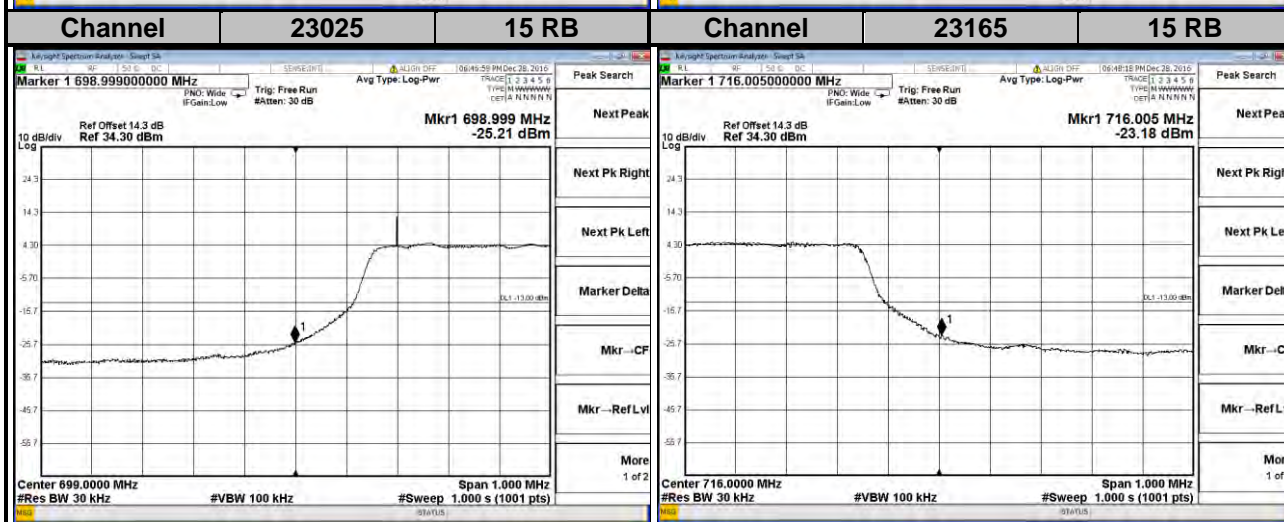
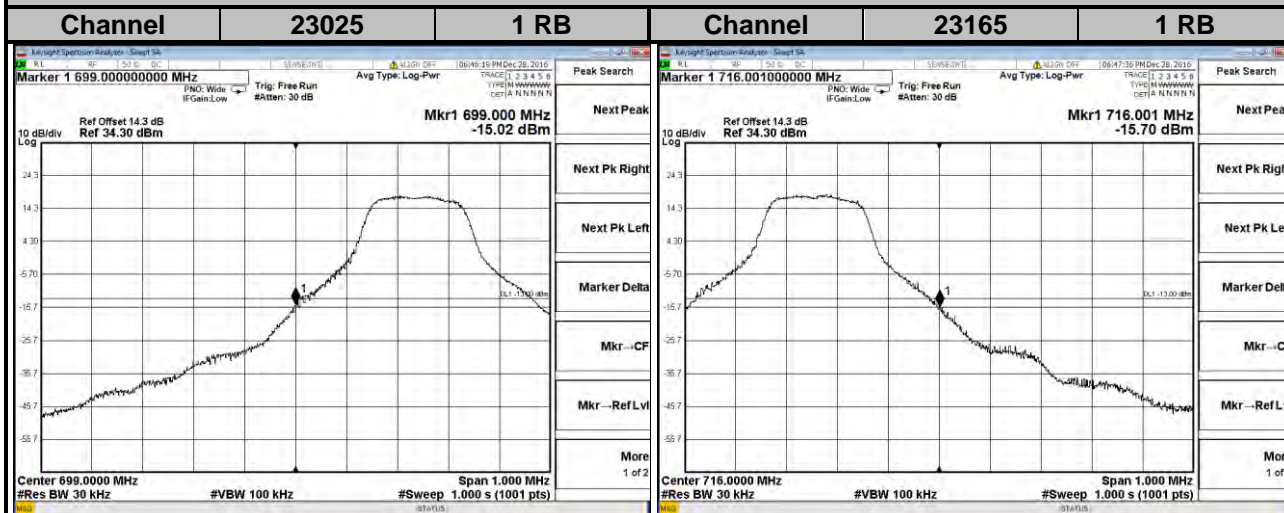

LTE Band 12

Channel Bandwidth: 5 MHz

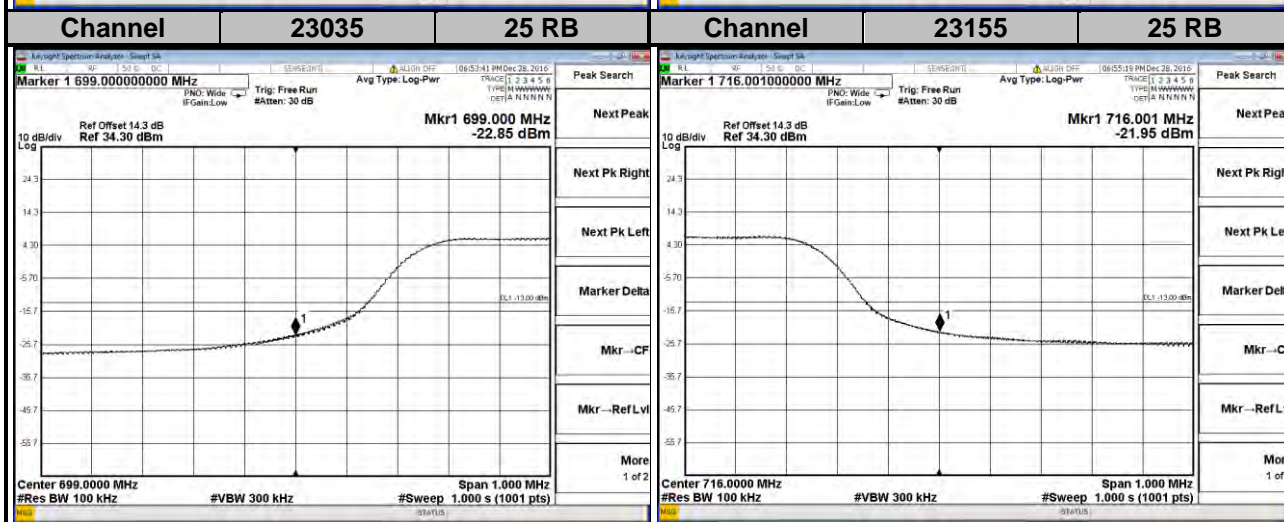
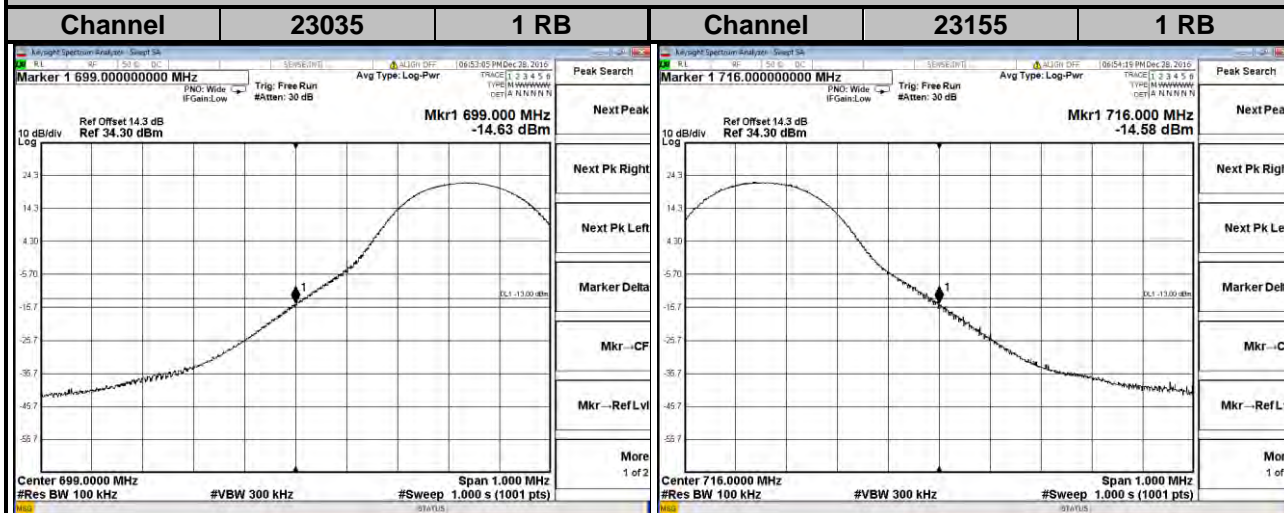

LTE Band 12

Channel Bandwidth: 10 MHz

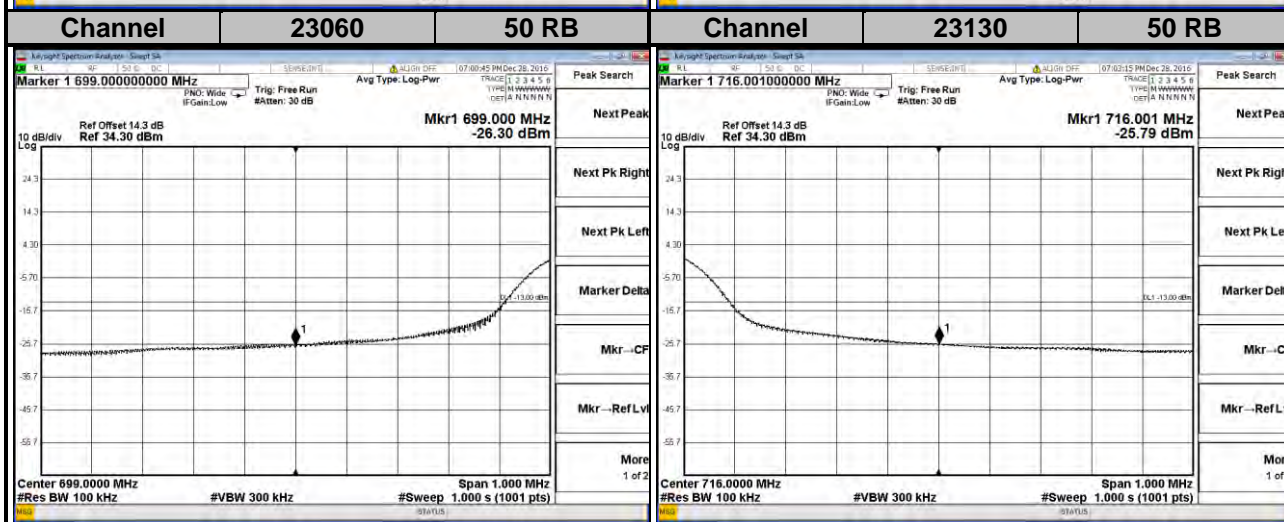
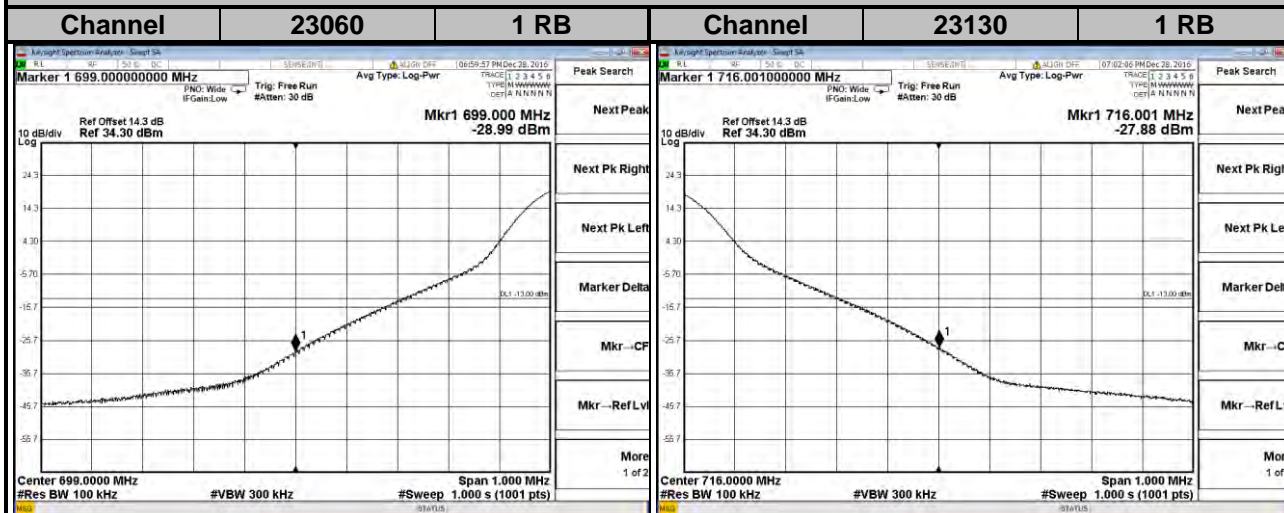

4.5 Peak to Average Ratio

4.5.1 Limits of Peak to Average Ratio Measurement

In measuring transmissions in this band using an average power technique, the peak to-average ratio (PAR) of the transmission may not exceed 13 dB.

4.5.2 Test Setup

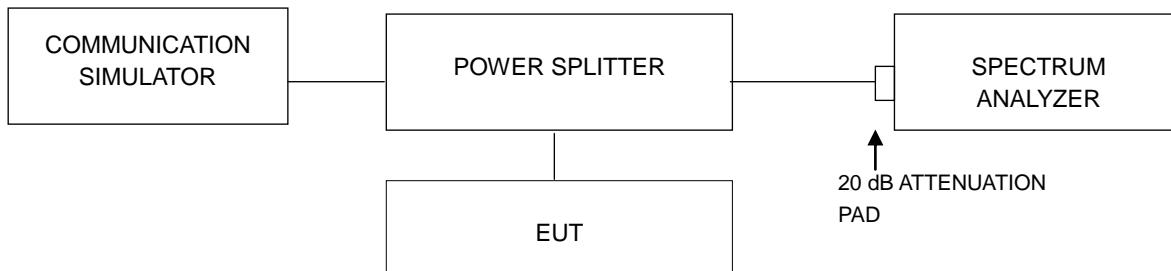

4.5.3 Test Procedures

1. Set resolution/measurement bandwidth \geq signal's occupied bandwidth;
2. Set the number of counts to a value that stabilizes the measured CCDF curve;
3. Record the maximum PAPR level associated with a probability of 0.1 %.

4.5.4 Test Results

LTE Band 4							
Channel Bandwidth: 1.4 MHz				Channel Bandwidth: 3 MHz			
Channel	Frequency (MHz)	Peak to Average Ratio (dB)		Channel	Frequency (MHz)	Peak to Average Ratio (dB)	
		QPSK	16QAM			QPSK	16QAM
19957	1710.7	4.46	4.89	19965	1711.5	4.47	4.93
20175	1732.5	4.37	4.80	20175	1732.5	4.40	4.92
20393	1754.3	4.68	5.39	20385	1753.5	4.72	5.43

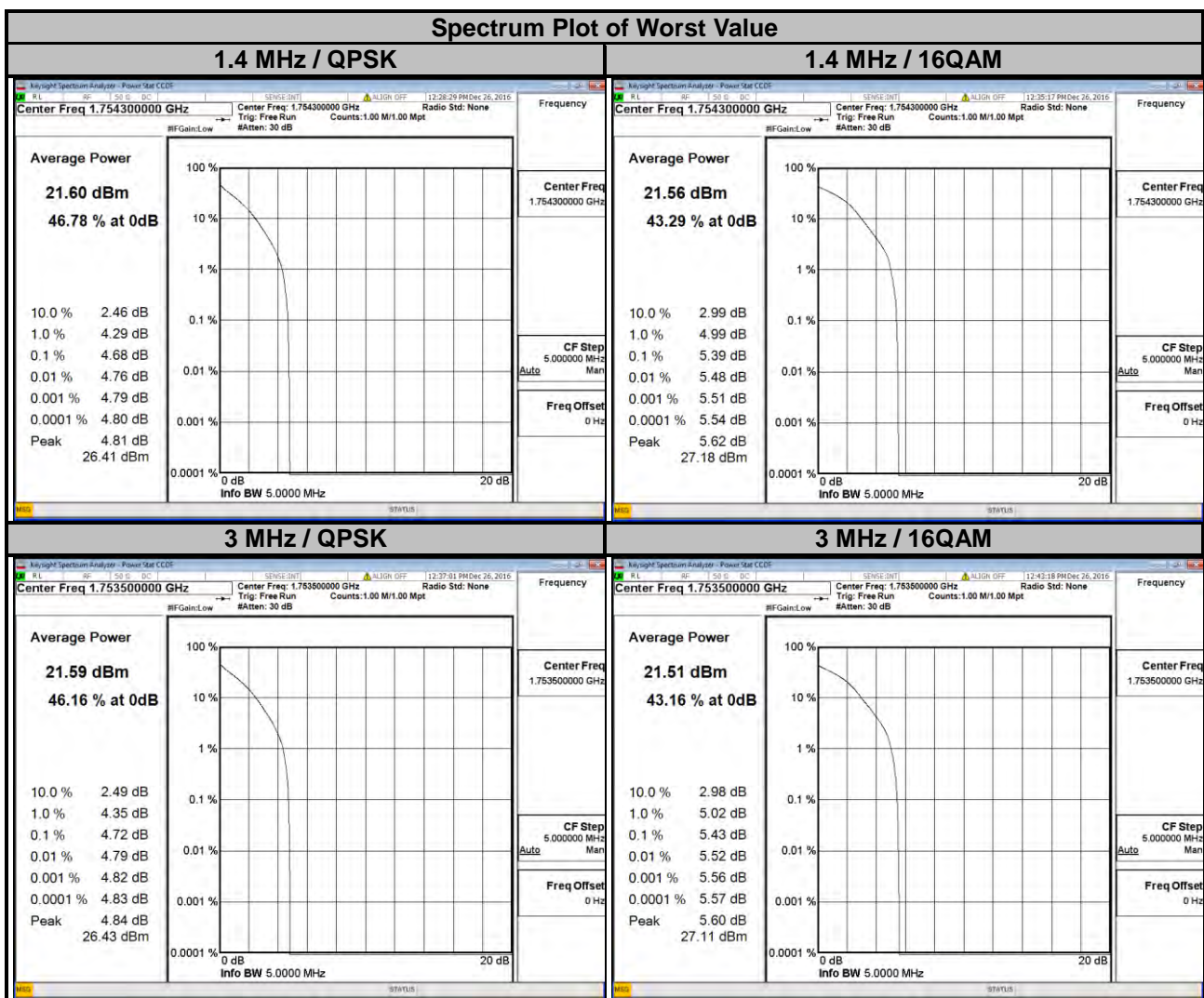

LTE Band 4

Channel Bandwidth: 5 MHz

Channel Bandwidth: 10 MHz

Channel	Frequency (MHz)	Peak to Average Ratio (dB)		Channel	Frequency (MHz)	Peak to Average Ratio (dB)	
		QPSK	16QAM			QPSK	16QAM
19975	1712.5	4.43	4.96	20000	1715.0	4.29	4.97
20175	1732.5	4.42	4.93	20175	1732.5	4.50	5.13
20375	1752.5	4.64	5.33	20350	1750.0	4.32	4.91

Spectrum Plot of Worst Value

5 MHz / QPSK

5 MHz / 16QAM

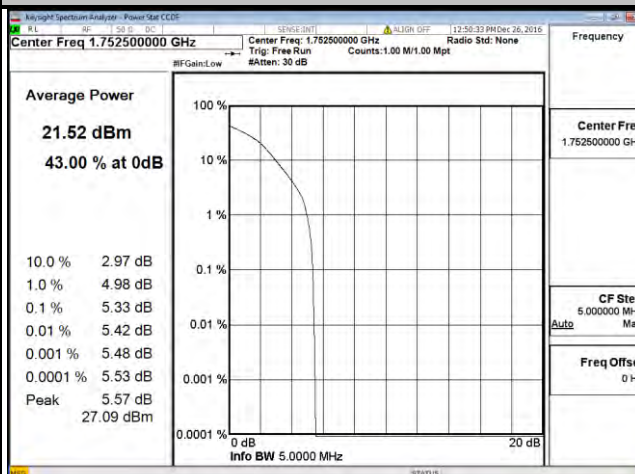
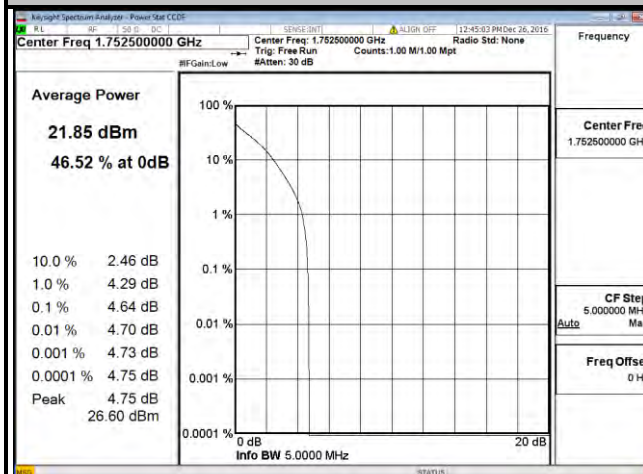

10 MHz / QPSK

10 MHz / 16QAM

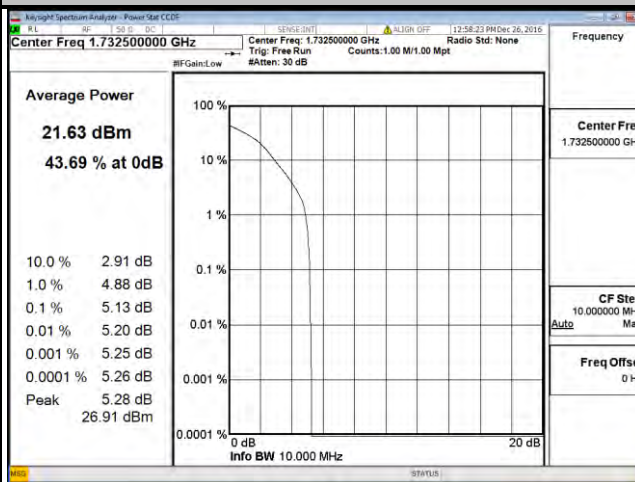
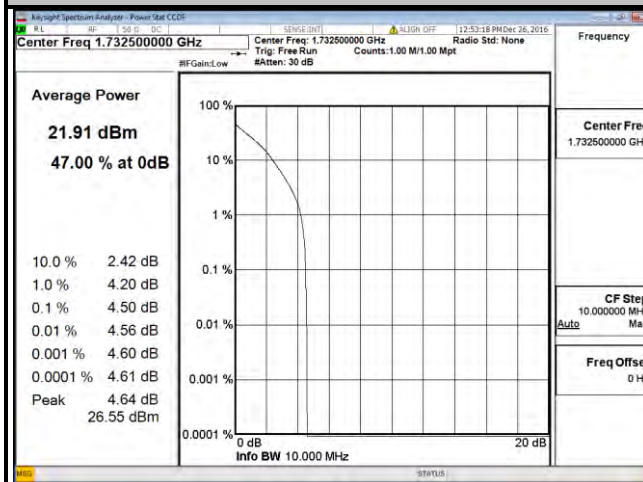

LTE Band 4

Channel Bandwidth: 15 MHz				Channel Bandwidth: 20 MHz			
Channel	Frequency (MHz)	Peak to Average Ratio (dB)		Channel	Frequency (MHz)	Peak to Average Ratio (dB)	
		QPSK	16QAM			QPSK	16QAM
20025	1717.5	4.29	4.84	20050	1720.0	4.34	4.87
20175	1732.5	4.60	5.16	20175	1732.5	4.67	5.15
20325	1747.5	4.27	4.55	20300	1745.0	4.08	4.53

Spectrum Plot of Worst Value

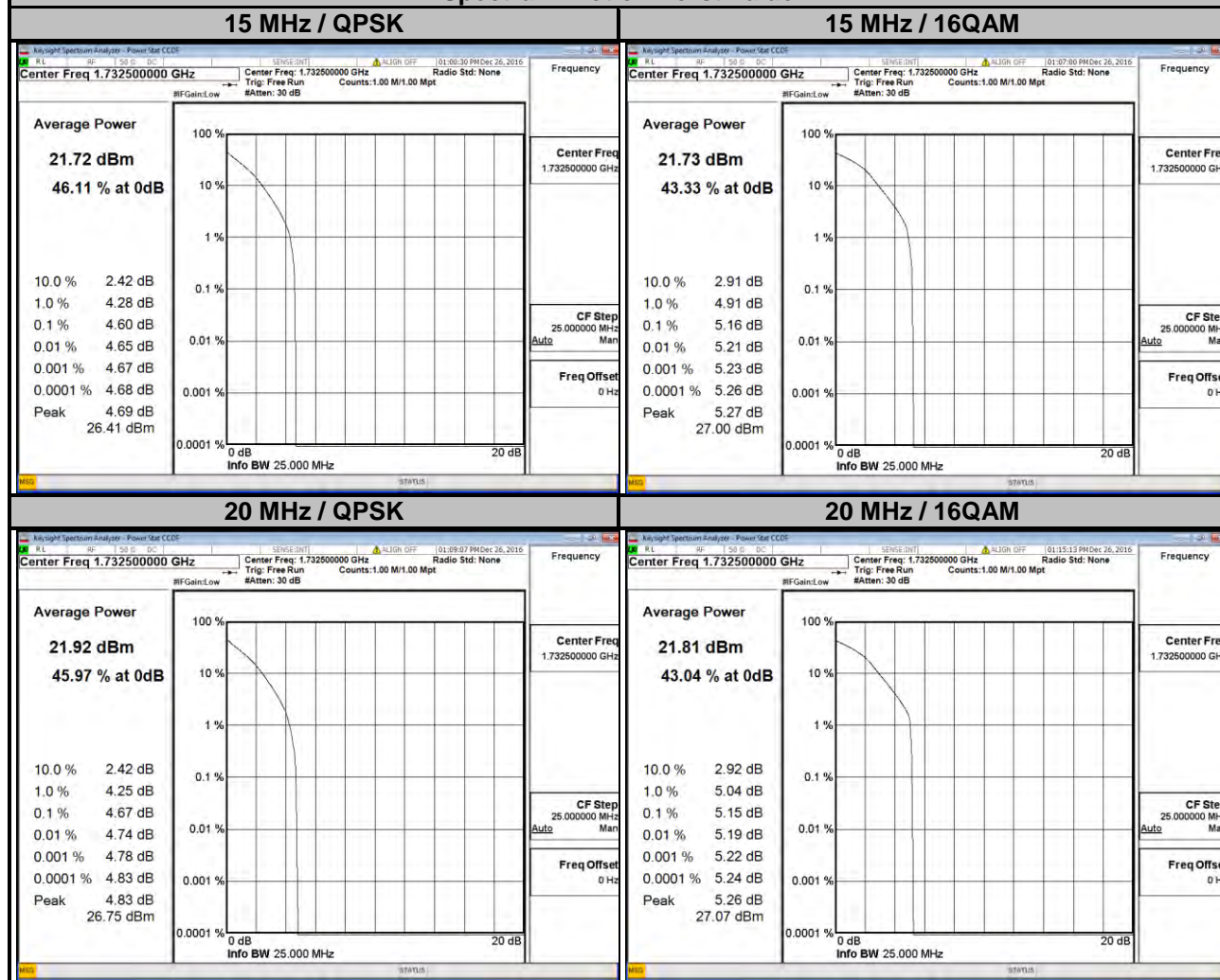

LTE Band 12

Channel Bandwidth: 1.4 MHz				Channel Bandwidth: 3 MHz			
Channel	Frequency (MHz)	Peak to Average Ratio (dB)		Channel	Frequency (MHz)	Peak to Average Ratio (dB)	
		QPSK	16QAM			QPSK	16QAM
23017	699.7	3.27	4.06	23025	700.5	3.12	4.12
23095	707.5	3.23	4.08	23095	707.5	2.96	4.01
23173	715.3	2.93	4.16	23165	714.5	2.99	4.12

Spectrum Plot of Worst Value

1.4 MHz / QPSK

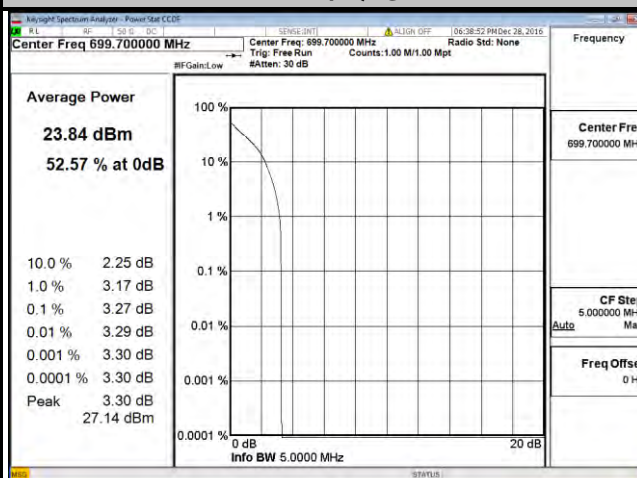

1.4 MHz / 16QAM

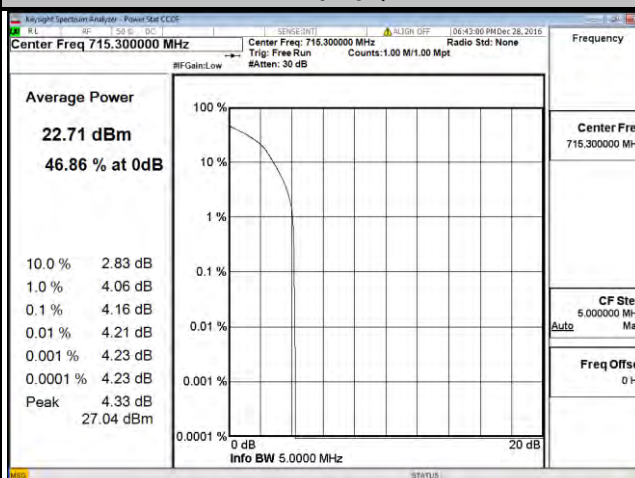

3 MHz / QPSK

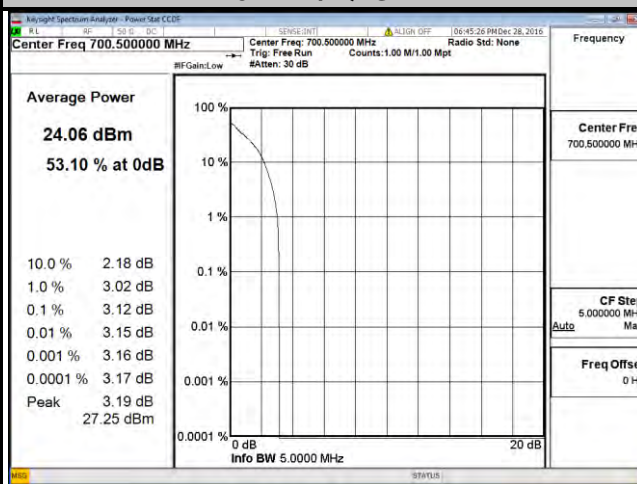

3 MHz / 16QAM

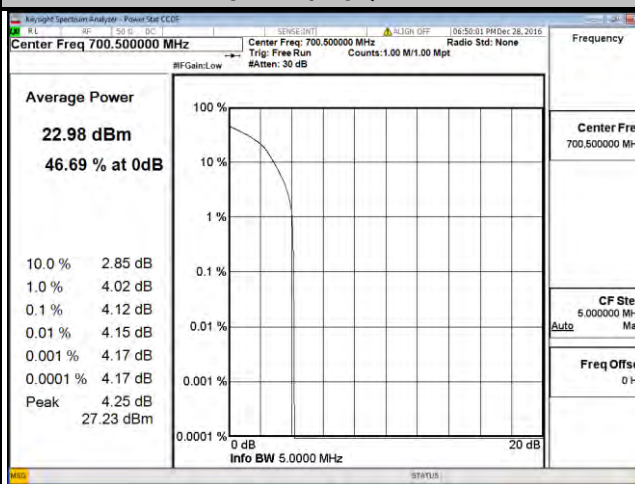

LTE Band 12

Channel Bandwidth: 5 MHz				Channel Bandwidth: 10 MHz			
Channel	Frequency (MHz)	Peak to Average Ratio (dB)		Channel	Frequency (MHz)	Peak to Average Ratio (dB)	
		QPSK	16QAM			QPSK	16QAM
23035	701.5	3.21	4.15	23060	704.0	3.10	4.20
23095	707.5	3.06	4.10	23095	707.5	3.15	4.13
23155	713.5	3.07	3.99	23130	711.0	3.12	4.00

Spectrum Plot of Worst Value

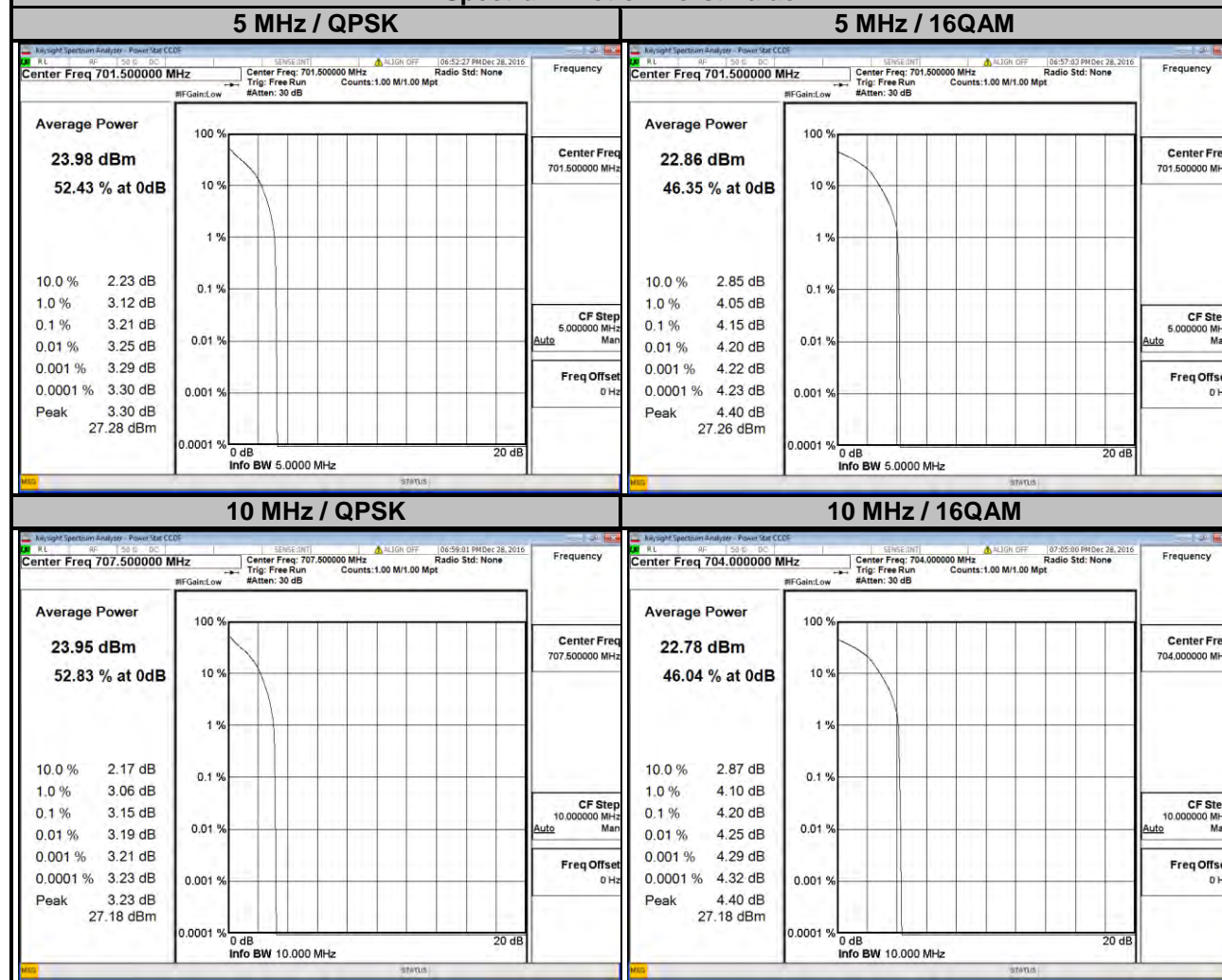

4.6 Conducted Spurious Emissions

4.6.1 Limits of Conducted Spurious Emissions Measurement

The power of any emission outside a licensee's frequency block shall be attenuated below the transmitter power (P) by at least $43 + 10 \log_{10}(P)$ dB. The limit of emission is equal to -13 dBm.

4.6.2 Test Setup

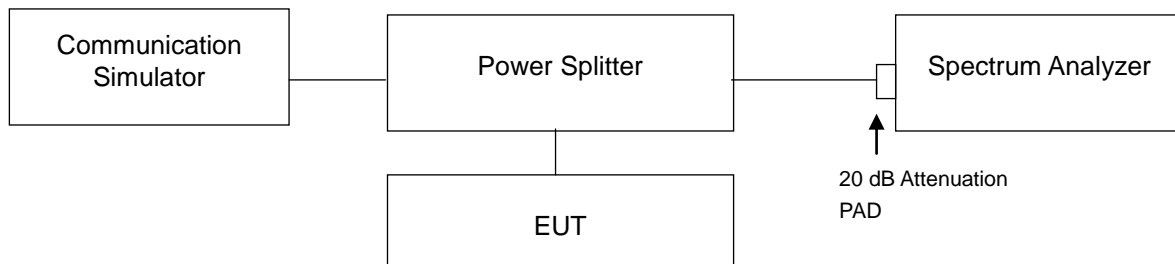

4.6.3 Test Procedure

- The EUT makes a phone call to the communication simulator. All measurements were done at low, middle and high operational frequency range.
- Measuring frequency range is from 30 MHz to 8 GHz for LTE Band 12 and from 30 MHz to 18 GHz for LTE Band 4. 10 dB attenuation pad is connected with spectrum. RBW=1 MHz and VBW=3 MHz are used for conducted emission measurement.

4.6.4 Test Results

Frequency Range: 30 MHz ~ 8 GHz

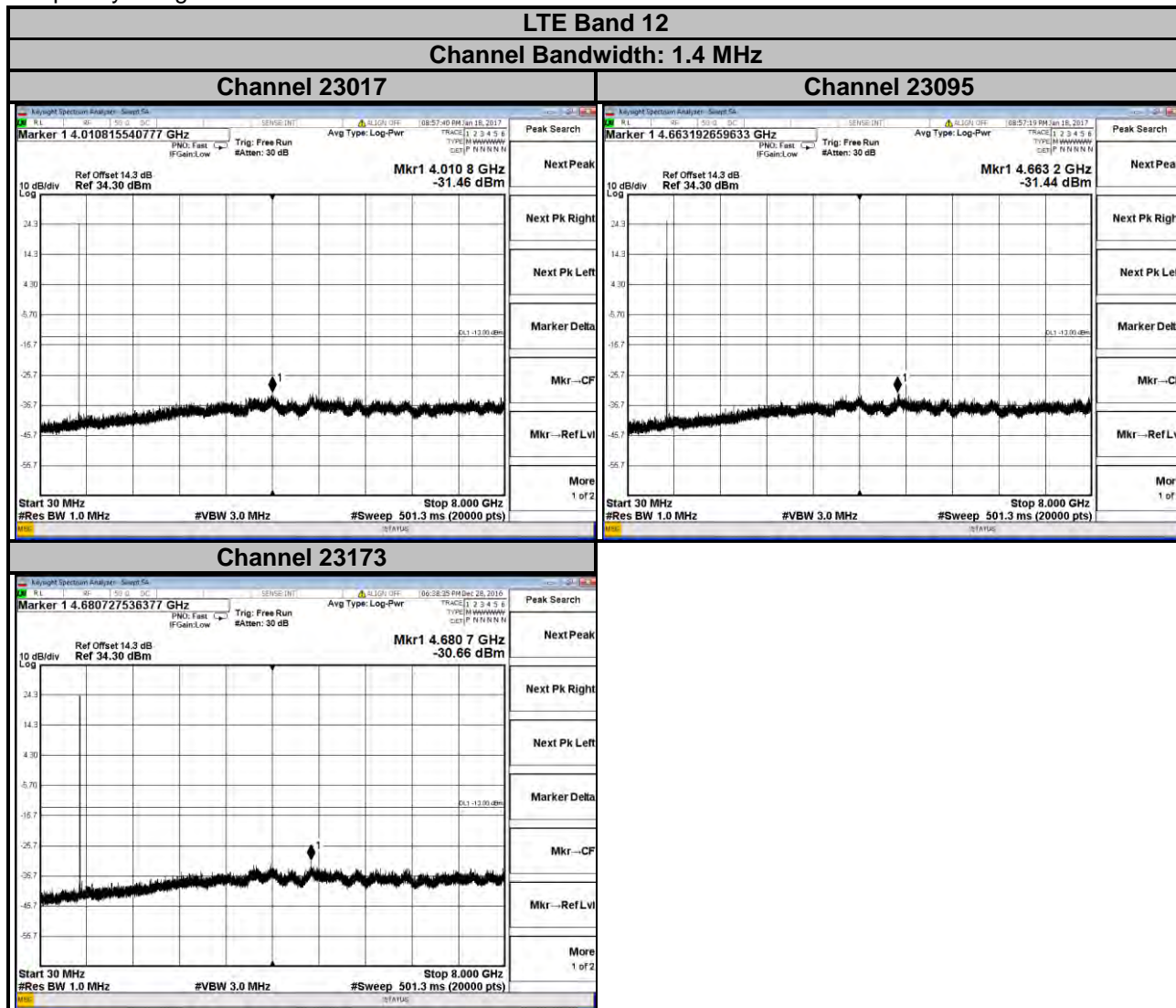

LTE Band 12
Channel Bandwidth: 3 MHz

Channel 23025

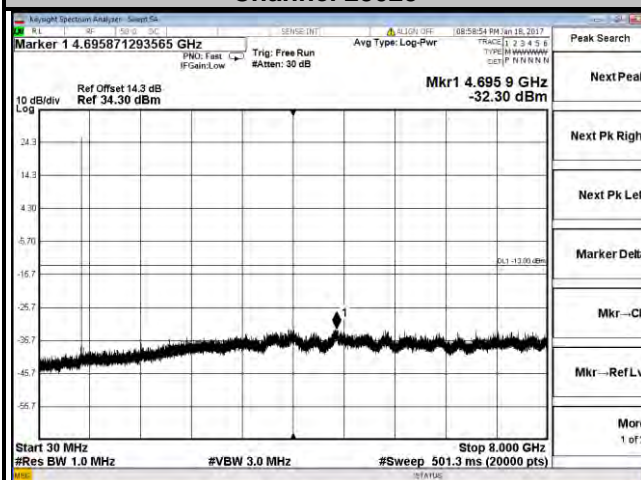

Channel 23095

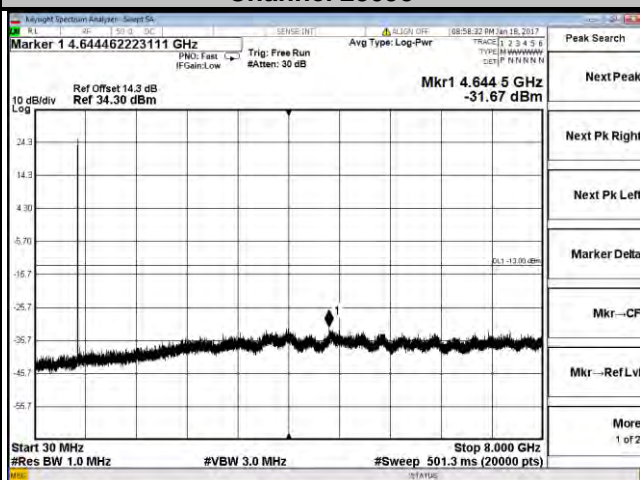

Channel 23165

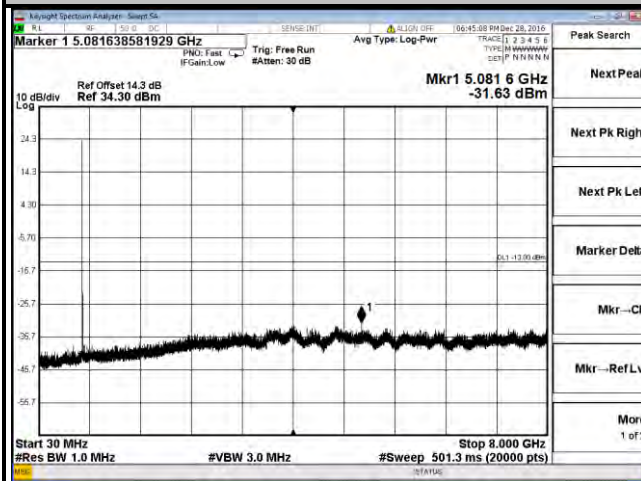

LTE Band 12
Channel Bandwidth: 5 MHz

Channel 23035

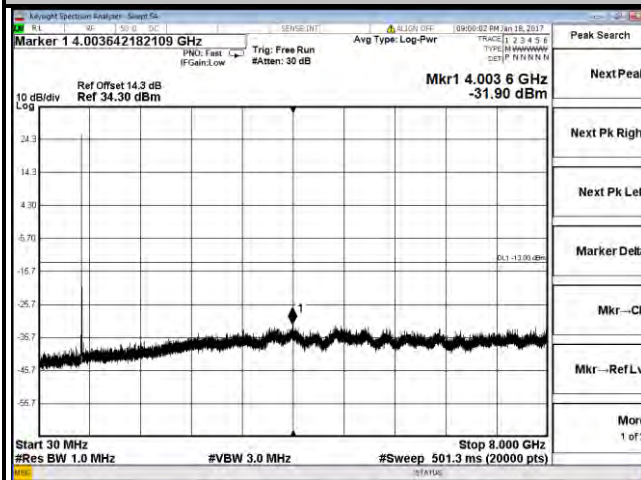

Channel 23095

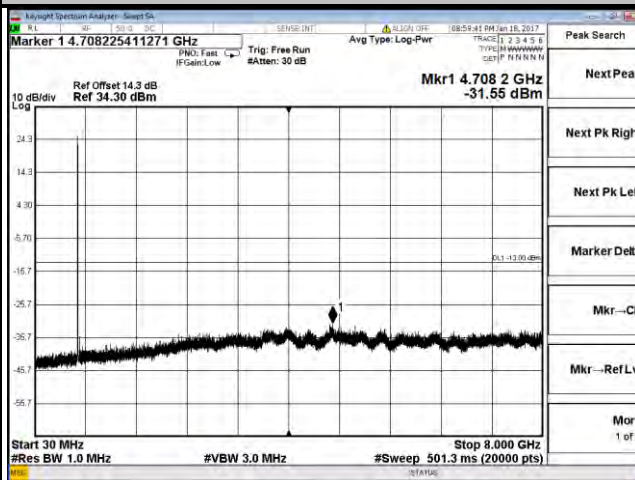

Channel 23155

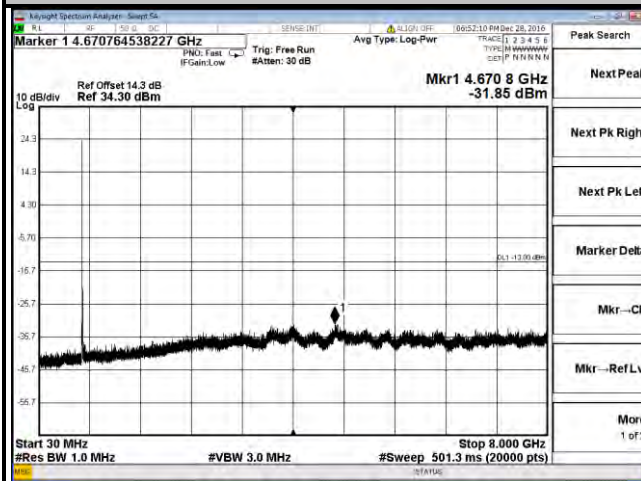

LTE Band 12
Channel Bandwidth: 10 MHz

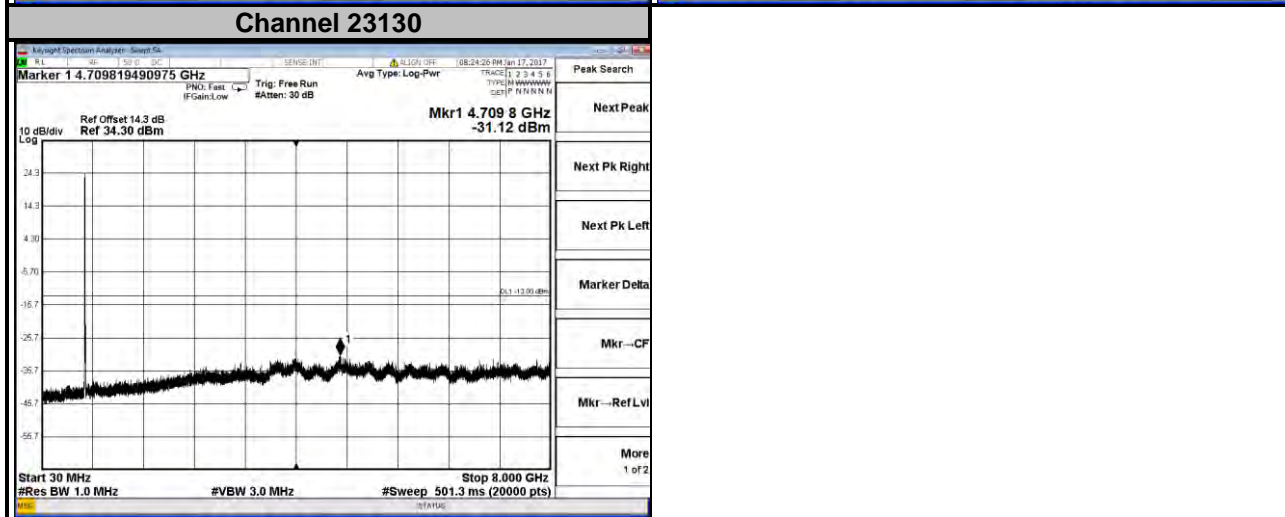
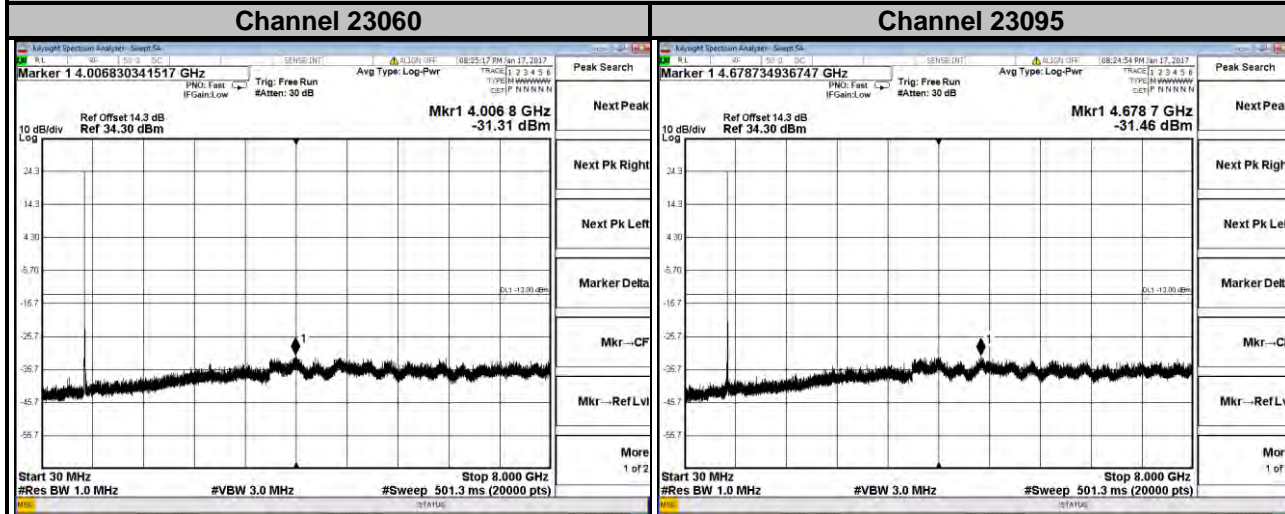

Frequency Range: 30 MHz ~ 18 GHz

LTE Band 4

Channel Bandwidth: 1.4 MHz

Channel 19957

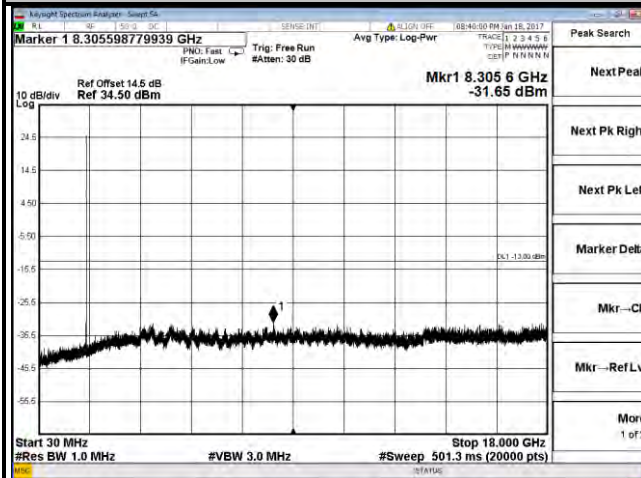

Channel 20175

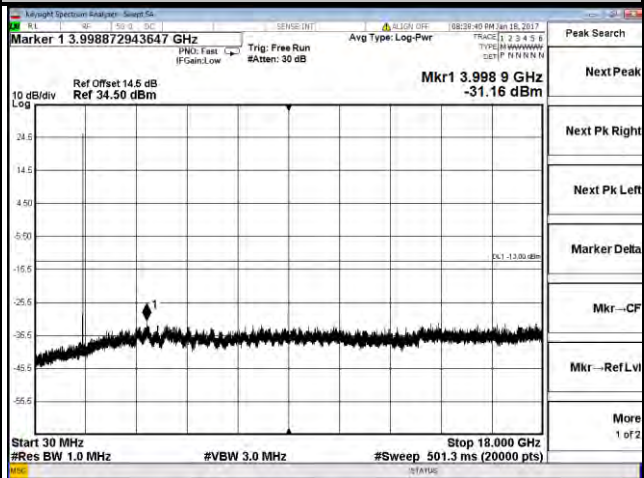

Channel 20393

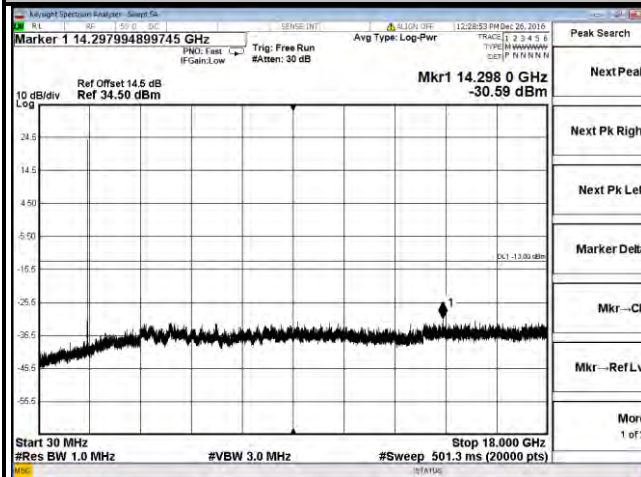

LTE Band 4
Channel Bandwidth: 3 MHz

Channel 19965

Channel 20175

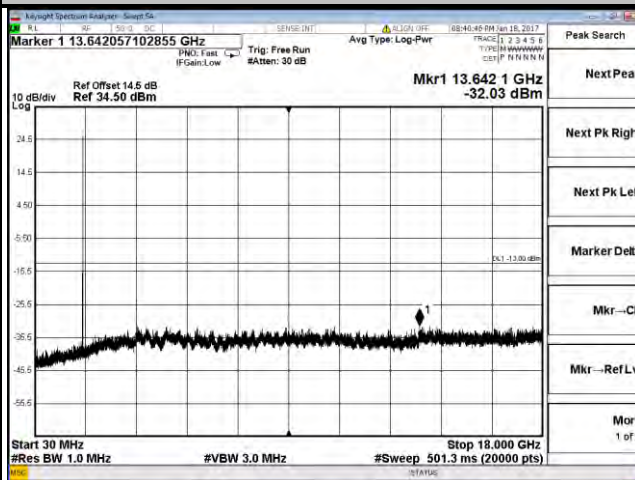
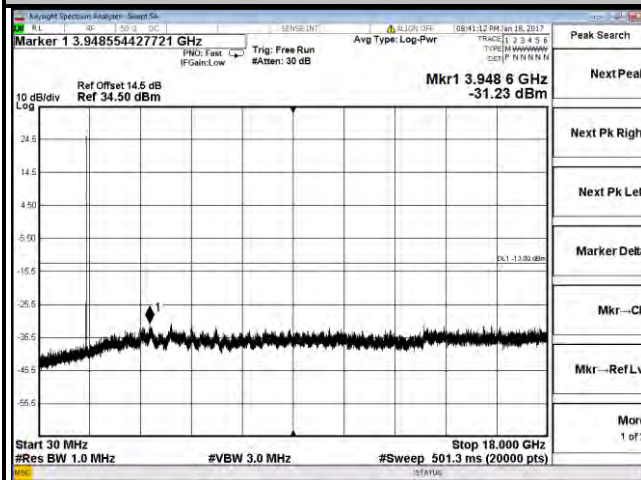

Channel 20385

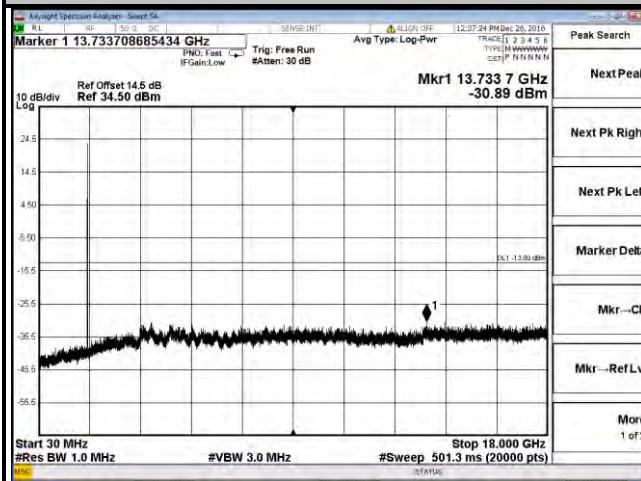

LTE Band 4
Channel Bandwidth: 5 MHz

Channel 19975

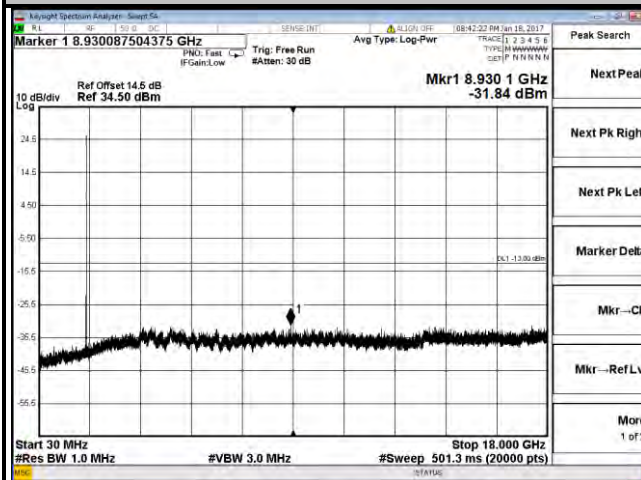

Channel 10715

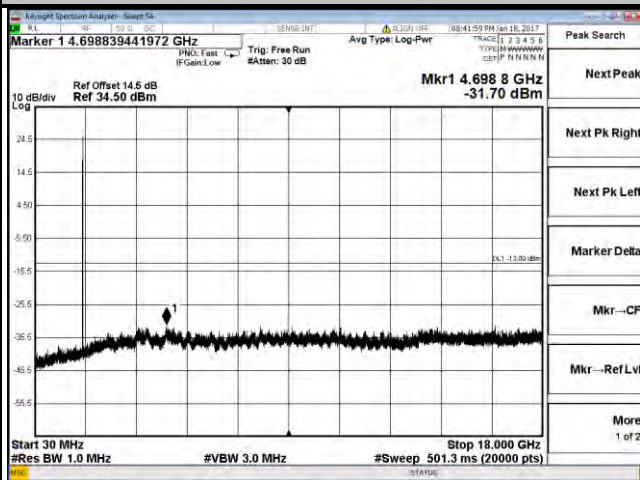

Channel 20375

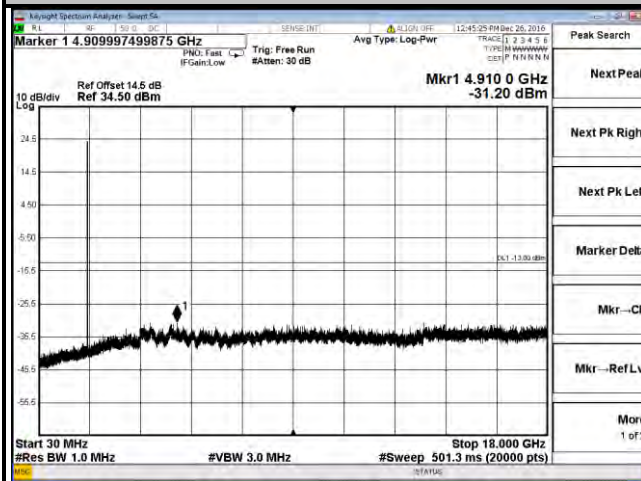

LTE Band 4
Channel Bandwidth: 10 MHz

Channel 2000

Channel 20175

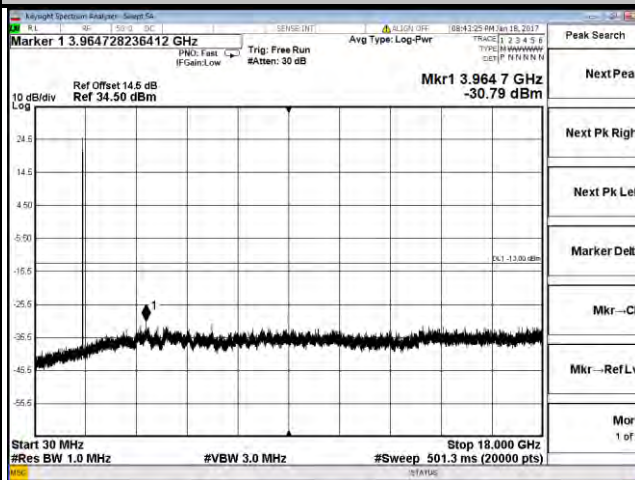
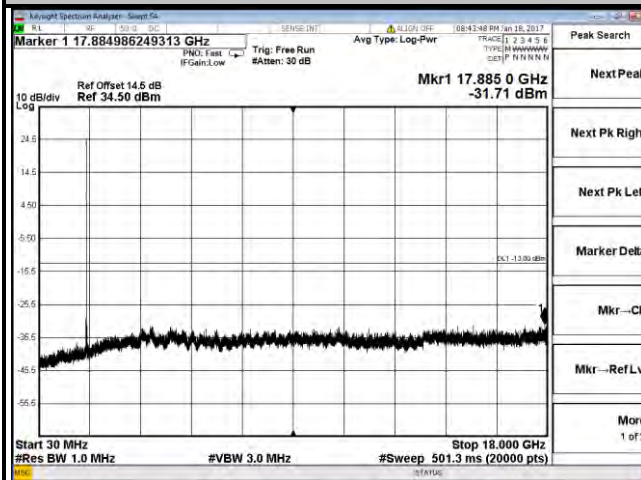

Channel 20350

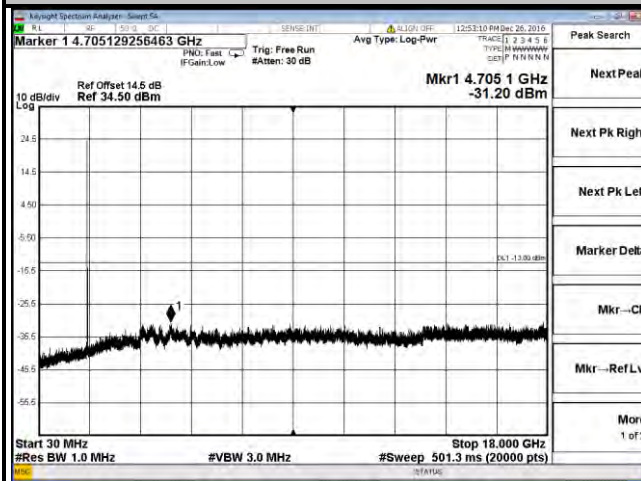

LTE Band 4
Channel Bandwidth: 15 MHz

Channel 20025

Channel 10175

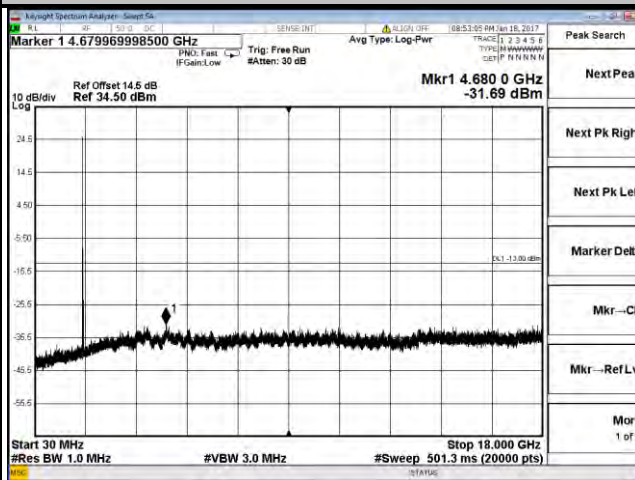
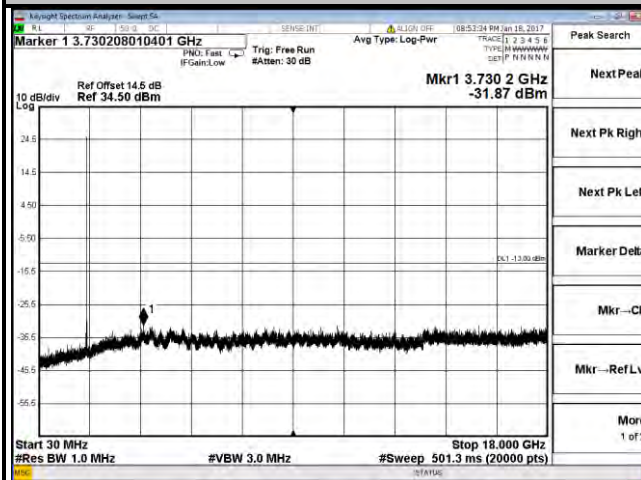

Channel 20325

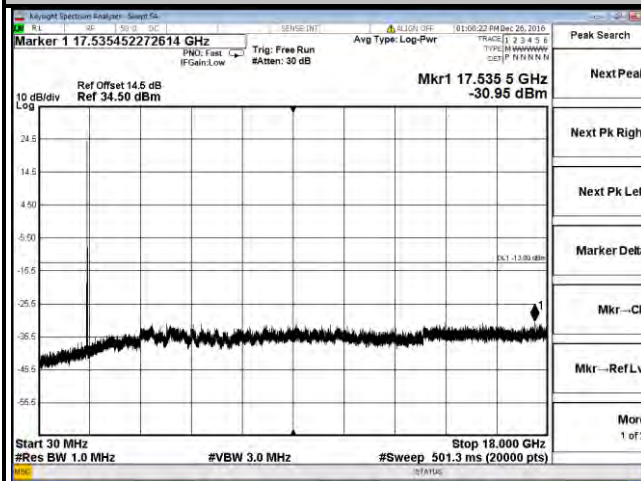

LTE Band 4
Channel Bandwidth: 20 MHz

Channel 20050

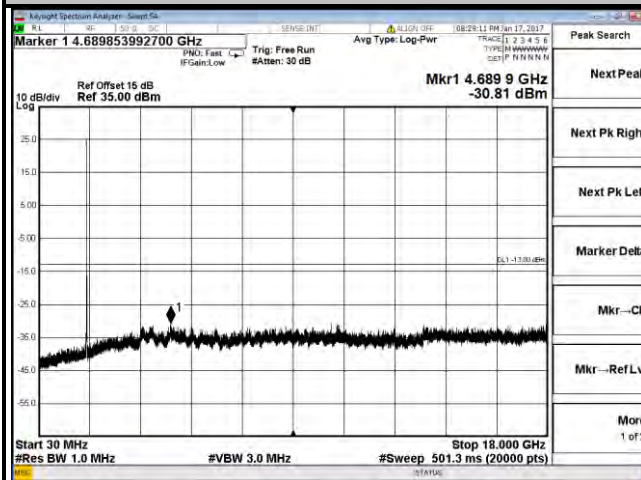

Channel 10175

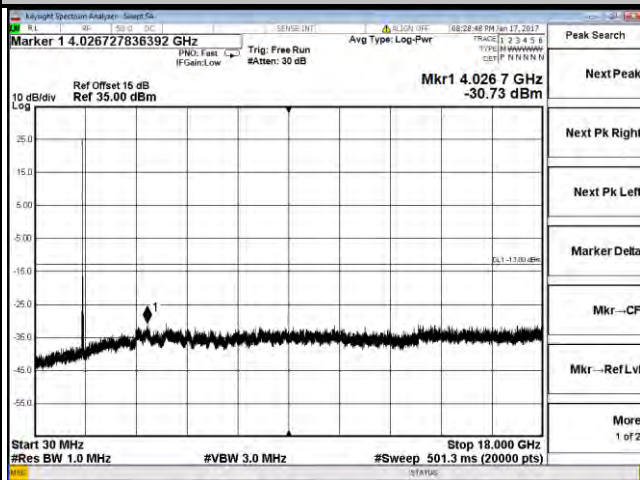

Channel 20300

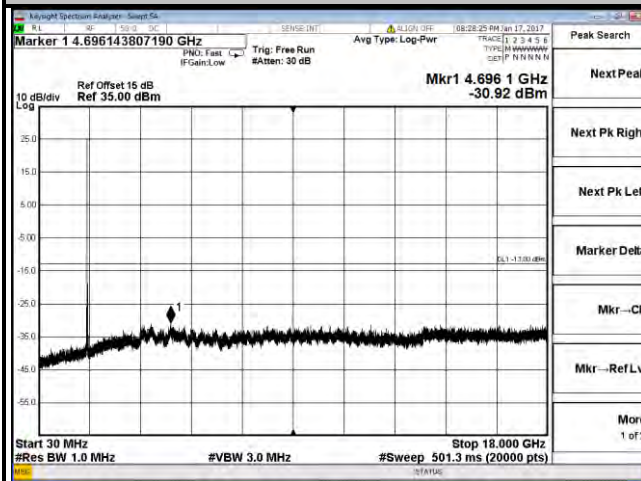

4.7 Radiated Emission Measurement

4.7.1 Limits of Radiated Emission Measurement

The power of any emission outside a licensee's frequency block shall be attenuated below the transmitter power (P) by at least $43 + 10 \log_{10}(P)$ dB. The limit of emission is equal to -13 dBm.

4.7.2 Test Procedure

- Substitution method is used for E.I.R.P measurement. In the semi-anechoic chamber, EUT placed on the 0.8 m height of Turn Table, rotated the table around 360 degrees to search the maximum radiation power and receiver antenna shall be rotated vertical and horizontal polarization and moved height from 1 m to 4 m to find the maximum polar radiated power. The "Read Value" is the spectrum reading the maximum power value.
- The substitution horn antenna is substituted for EUT at the same position and signals generator export the CW signal to the substitution antenna via a TX cable. Rotated the Turn Table and moved receiving antenna to find the maximum radiation power. Adjust output power level of S.G to get a Value of spectrum reading equal to "Read Value" of step a. Record the power level of S.G.
- $EIRP = \text{Output power level of S.G} - \text{TX cable loss} + \text{Antenna gain of substitution horn}$.
- E.R.P power can be calculated form E.I.R.P power by subtracting the gain of dipole, $E.R.P \text{ power} = E.I.P.R \text{ power} - 2.15 \text{ dBi}$.

Note: The resolution bandwidth of spectrum analyzer is 1 MHz and the video bandwidth is 3 MHz.

4.7.3 Deviation from Test Standard

No deviation.

4.7.4 Test Setup

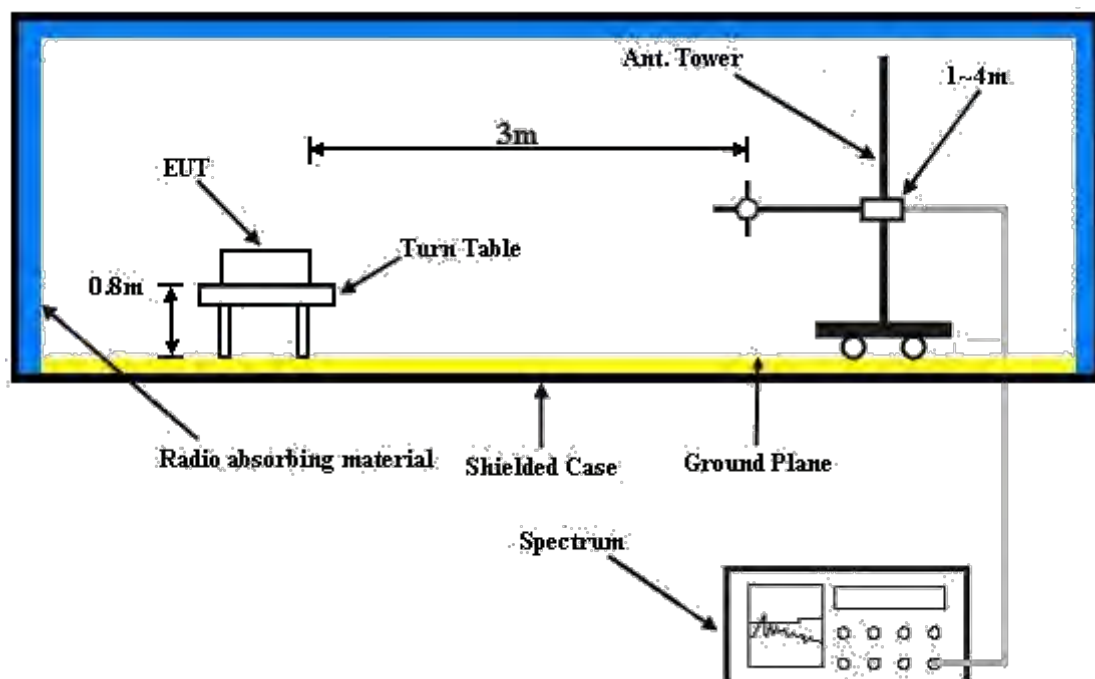

For the actual test configuration, please refer to the attached file (Test Setup Photo).

4.7.5 Test Results

LTE Band 4

Channel Bandwidth: 20 MHz / QPSK

Low Channel



Bureau Veritas Consumer Products Services Ltd., Taoyuan Branch

A D T

Data: 5

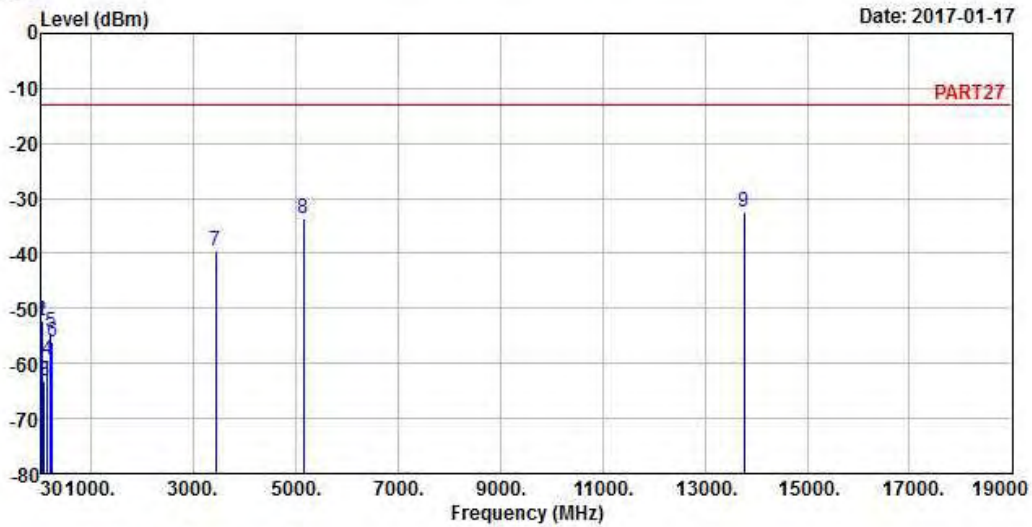

Site : 966 Chamber 5
 Condition: PART27 HORIZONTAL
 Remak : LTE Band 4 QPSK_20M_L-CH
 Tested by: Getaz Yang

	Freq	Level	Read Level	Limit Line	Over Limit	Factor	Remark
	MHz	dBm	dBm	dBm	dB	dB	
1	30.00	-52.38	-52.76	-13.00	-39.38	0.38	Peak
2	39.70	-52.27	-52.91	-13.00	-39.27	0.64	Peak
3	80.44	-63.20	-52.32	-13.00	-50.20	-10.88	Peak
4	145.43	-59.20	-51.13	-13.00	-46.20	-8.07	Peak
5	206.54	-54.31	-46.56	-13.00	-41.31	-7.75	Peak
6	237.58	-56.01	-49.51	-13.00	-43.01	-6.50	Peak
7	3440.00	-39.41	-30.41	-13.00	-26.41	-9.00	Peak
8	5160.00	-33.78	-30.85	-13.00	-20.78	-2.93	Peak
9	pp 13760.00	-32.61	-43.09	-13.00	-19.61	10.48	Peak



Bureau Veritas Consumer Products Services Ltd., Taoyuan Branch

A D T

Data: 6

Date: 2017-01-17

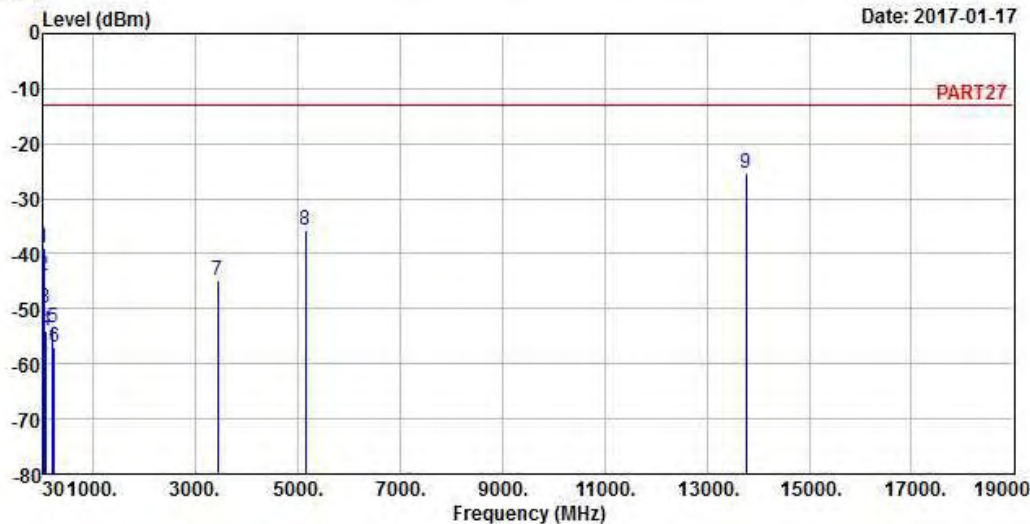

Site : 966 Chamber 5
 Condition: PART27 VERTICAL
 Remak : LTE Band 4 QPSK_20M_L-CH
 Tested by: Getaz Yang

	Freq	Level	Read Level	Limit Line	Over Limit	Factor	Remark
	MHz	dBm	dBm	dBm	dB	dB	
1	30.00	-38.82	-39.20	-13.00	-25.82	0.38	Peak
2	38.73	-43.95	-44.05	-13.00	-30.95	0.10	Peak
3	55.22	-49.92	-43.58	-13.00	-36.92	-6.34	Peak
4	77.53	-54.16	-43.96	-13.00	-41.16	-10.20	Peak
5	205.57	-53.45	-45.66	-13.00	-40.45	-7.79	Peak
6	241.46	-57.06	-50.72	-13.00	-44.06	-6.34	Peak
7	3440.00	-44.77	-35.77	-13.00	-31.77	-9.00	Peak
8	5160.00	-35.61	-32.68	-13.00	-22.61	-2.93	Peak
9 pp	13760.00	-25.53	-36.01	-13.00	-12.53	10.48	Peak

Middle Channel



Bureau Veritas Consumer Products Services Ltd., Taoyuan Branch

A D T

Data: 5

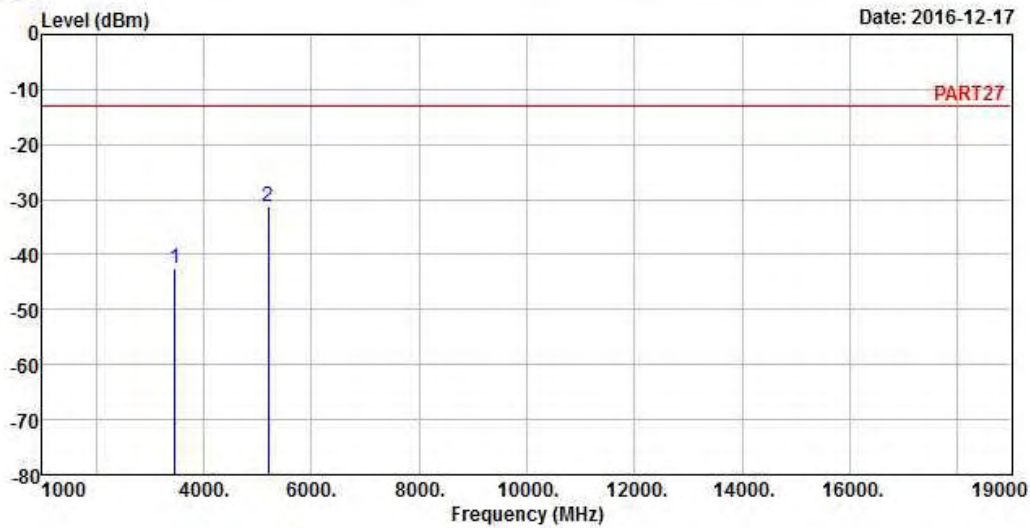

Site : 966 Chamber 5
 Condition: PART27 HORIZONTAL
 Remak : LTE Band 4 QPSK_20M_M-CH
 Tested by: Getaz Yang

	Freq	Level	Read Level	Limit Line	Over Limit	Factor	Remark
	MHz	dBm	dBm	dBm	dB	dB	
1	3465.00	-42.57	-33.66	-13.00	-29.57	-8.91	Peak
2 pp	5197.50	-31.40	-28.54	-13.00	-18.40	-2.86	Peak



Bureau Veritas Consumer Products Services Ltd., Taoyuan Branch

A D T

Data: 6

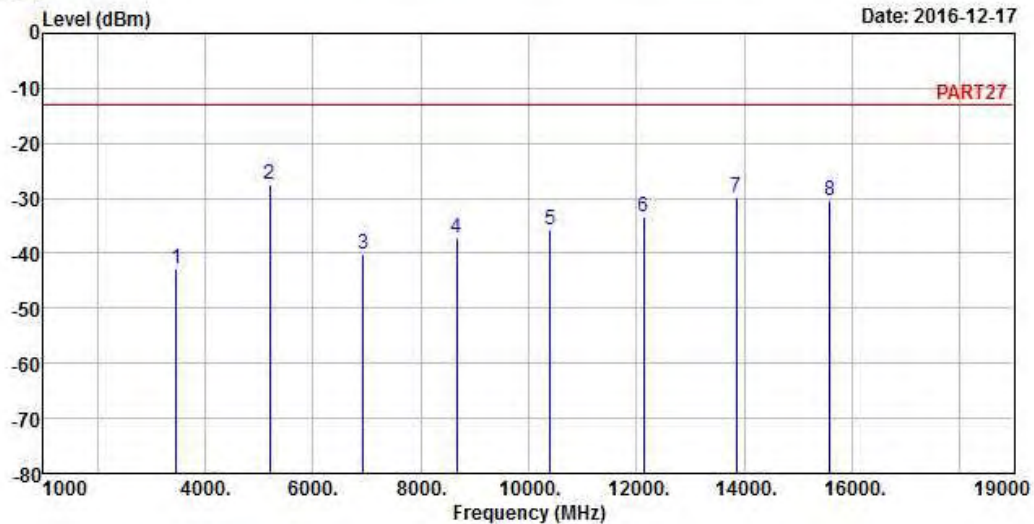

Site : 966 Chamber 5
 Condition: PART27 VERTICAL
 Remak : LTE Band 4 QPSK_20M_M-CH
 Tested by: Getaz Yang

	Freq	Level	Read Level	Limit Line	Over Limit	Factor	Remark
	MHz	dBm	dBm	dBm	dB	dB	
1	3465.00	-42.85	-33.94	-13.00	-29.85	-8.91	Peak
2 pp	5197.50	-27.38	-24.52	-13.00	-14.38	-2.86	Peak
3	6930.00	-40.14	-44.43	-13.00	-27.14	4.29	Peak
4	8662.50	-37.34	-44.62	-13.00	-24.34	7.28	Peak
5	10395.00	-35.79	-44.09	-13.00	-22.79	8.30	Peak
6	12127.50	-33.47	-44.26	-13.00	-20.47	10.79	Peak
7	13860.00	-29.72	-39.71	-13.00	-16.72	9.99	Peak
8	15592.50	-30.43	-41.16	-13.00	-17.43	10.73	Peak

High Channel



Bureau Veritas Consumer Products Services Ltd., Taoyuan Branch

A D T

Data: 3

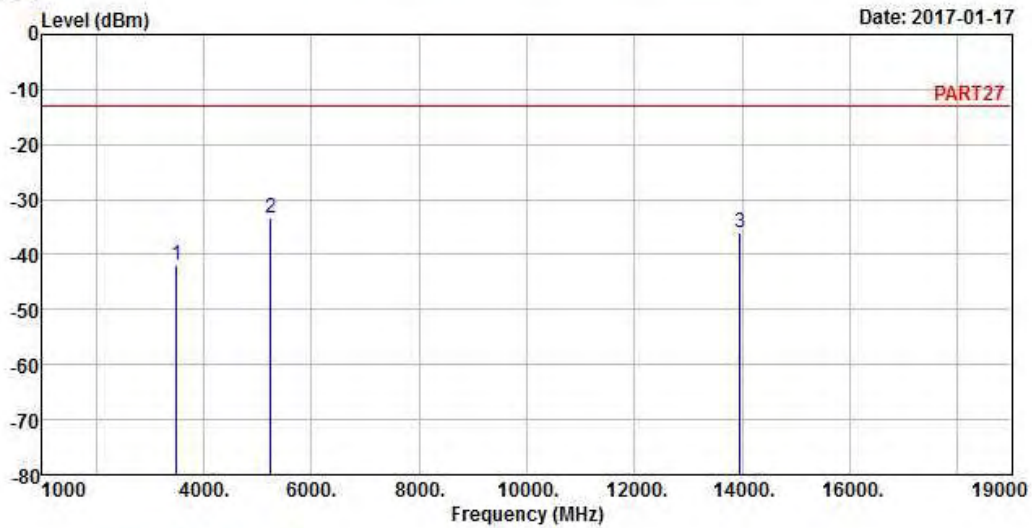

Date: 2017-01-17

Site : 966 Chamber 5
 Condition: PART27 HORIZONTAL
 Remak : LTE Band 4 QPSK_20M_H-CH
 Tested by: Getaz Yang

	Freq	Level	Read Level	Limit Line	Over Limit	Factor	Remark
	MHz	dBm	dBm	dBm	dB	dB	
1	3490.00	-41.90	-33.39	-13.00	-28.90	-8.51	Peak
2 pp	5235.00	-33.29	-30.62	-13.00	-20.29	-2.67	Peak
3	13960.00	-35.95	-45.63	-13.00	-22.95	9.68	Peak



Bureau Veritas Consumer Products Services Ltd., Taoyuan Branch

A D T

Data: 4

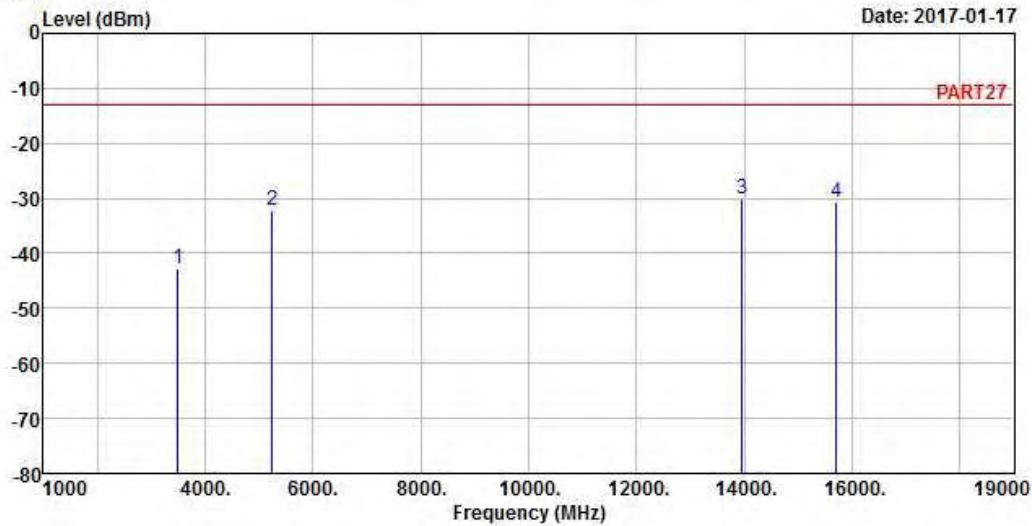

Site : 966 Chamber 5
 Condition: PART27 VERTICAL
 Remak : LTE Band 4 QPSK_20M_H-CH
 Tested by: Getaz Yang

	Freq	Level	Read Level	Limit Line	Over Limit	Factor	Remark
	MHz	dBm	dBm	dBm	dB	dB	
1	3490.00	-42.76	-34.25	-13.00	-29.76	-8.51	Peak
2	5235.00	-32.27	-29.60	-13.00	-19.27	-2.67	Peak
3 pp	13960.00	-30.16	-39.84	-13.00	-17.16	9.68	Peak
4	15705.00	-30.84	-41.86	-13.00	-17.84	11.02	Peak

LTE Band 12
 Channel Bandwidth: 10 MHz / QPSK
 Low Channel



Bureau Veritas Consumer Products Services Ltd., Taoyuan Branch

A D T

Data: 5

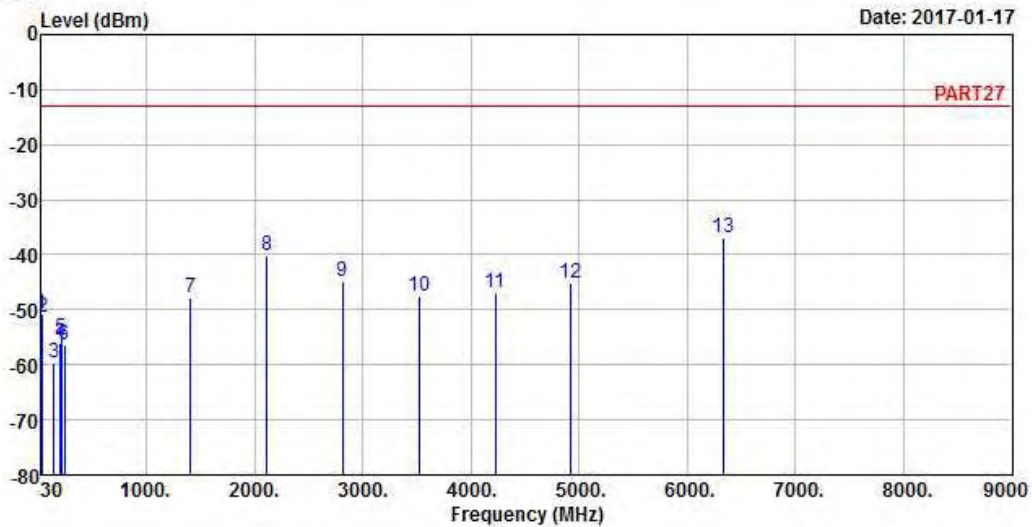

Site : 966 Chamber 5
 Condition: PART27 HORIZONTAL
 Remak : LTE Band 12 QPSK_10M_L-CH
 Tested by: Getaz Yang

	Freq	Level	Read Level	Limit Line	Over Limit	Factor	Remark
	MHz	dBm	dBm	dBm	dB	dB	
1	30.00	-50.75	-51.13	-13.00	-37.75	0.38	Peak
2	40.67	-51.26	-51.38	-13.00	-38.26	0.12	Peak
3	145.43	-59.74	-51.67	-13.00	-46.74	-8.07	Peak
4	205.57	-55.99	-48.20	-13.00	-42.99	-7.79	Peak
5	211.39	-55.30	-47.75	-13.00	-42.30	-7.55	Peak
6	240.49	-56.50	-50.12	-13.00	-43.50	-6.38	Peak
7	1408.00	-47.90	-33.56	-13.00	-34.90	-14.34	Peak
8	2112.00	-40.16	-27.92	-13.00	-27.16	-12.24	Peak
9	2816.00	-44.93	-35.15	-13.00	-31.93	-9.78	Peak
10	3520.00	-47.57	-39.34	-13.00	-34.57	-8.23	Peak
11	4224.00	-47.00	-40.25	-13.00	-34.00	-6.75	Peak
12	4928.00	-45.24	-42.62	-13.00	-32.24	-2.62	Peak
13	6336.00	-36.77	-37.84	-13.00	-23.77	1.07	Peak



Bureau Veritas Consumer Products Services Ltd., Taoyuan Branch

A D T

Data: 6

Date: 2017-01-17

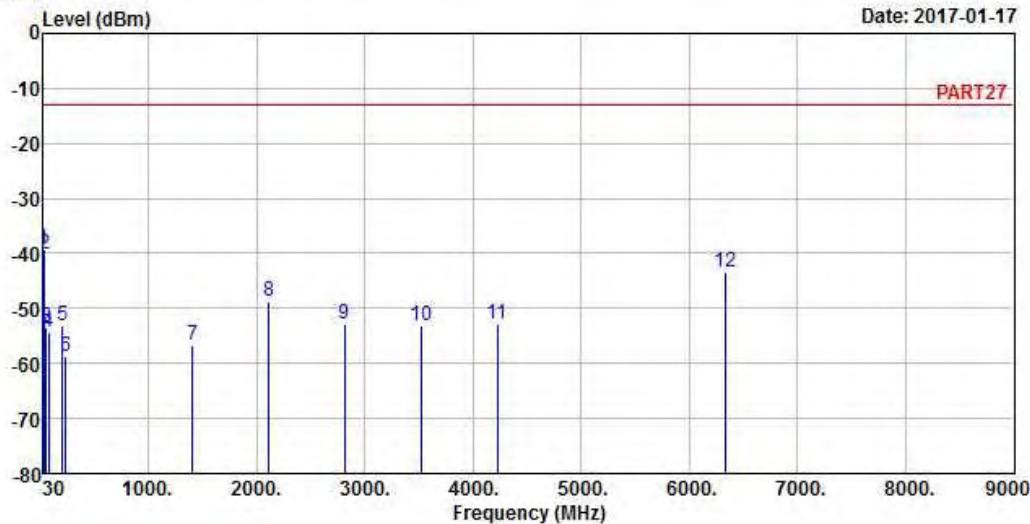

Site : 966 Chamber 5
 Condition: PART27 VERTICAL
 Remak : LTE Band 12 QPSK_10M_L-CH
 Tested by: Getaz Yang

	Freq	Level	Read Level	Limit Line	Over Limit	Factor	Remark
	MHz	dBm	dBm	dBm	dB	dB	
1	pp	30.00	-39.22	-39.60	-13.00	-26.22	0.38 Peak
2		39.70	-40.29	-40.93	-13.00	-27.29	0.64 Peak
3		53.28	-53.47	-47.66	-13.00	-40.47	-5.81 Peak
4		75.59	-54.40	-44.65	-13.00	-41.40	-9.75 Peak
5		208.48	-53.23	-45.56	-13.00	-40.23	-7.67 Peak
6		235.64	-58.87	-52.29	-13.00	-45.87	-6.58 Peak
7		1408.00	-56.54	-42.20	-13.00	-43.54	-14.34 Peak
8		2112.00	-48.80	-36.56	-13.00	-35.80	-12.24 Peak
9		2816.00	-52.85	-43.07	-13.00	-39.85	-9.78 Peak
10		3520.00	-53.15	-44.92	-13.00	-40.15	-8.23 Peak
11		4224.00	-52.75	-46.00	-13.00	-39.75	-6.75 Peak
12		6336.00	-43.49	-44.56	-13.00	-30.49	1.07 Peak

Middle Channel



Bureau Veritas Consumer Products Services Ltd., Taoyuan Branch

A D T

Data: 3

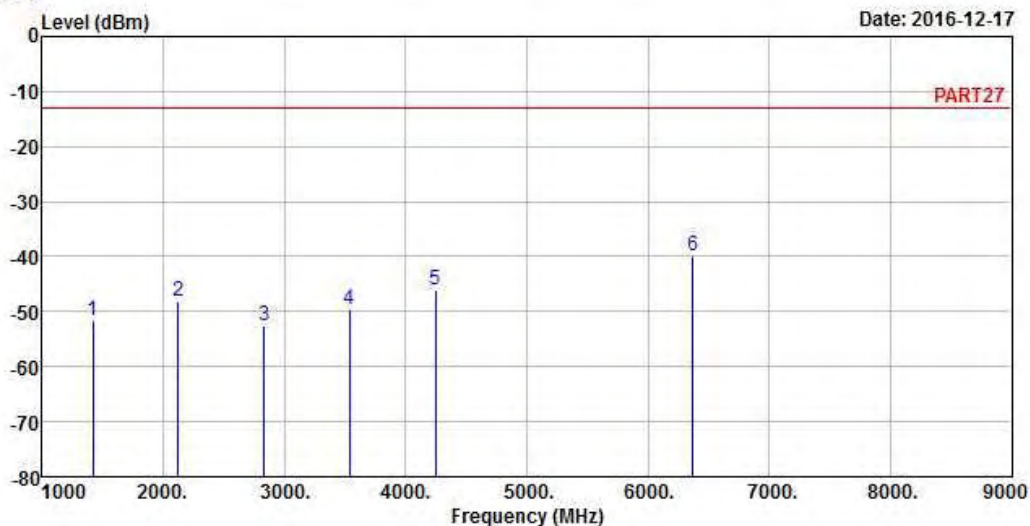

Site : 966 Chamber 5
 Condition: PART27 HORIZONTAL
 Remak : LTE Band 12 QPSK_10M_M-CH
 Tested by: Getaz Yang

	Freq	Level	Read Level	Limit Line	Over Limit	Factor	Remark
	MHz	dBm	dBm	dBm	dB	dB	
1	1415.00	-51.60	-37.26	-13.00	-38.60	-14.34	Peak
2	2122.50	-48.19	-35.95	-13.00	-35.19	-12.24	Peak
3	2830.00	-52.44	-42.73	-13.00	-39.44	-9.71	Peak
4	3537.50	-49.72	-41.37	-13.00	-36.72	-8.35	Peak
5	4245.00	-45.92	-39.10	-13.00	-32.92	-6.82	Peak
6 pp	6367.50	-39.92	-41.07	-13.00	-26.92	1.15	Peak



A D T

Data: 4

Date: 2016-12-17

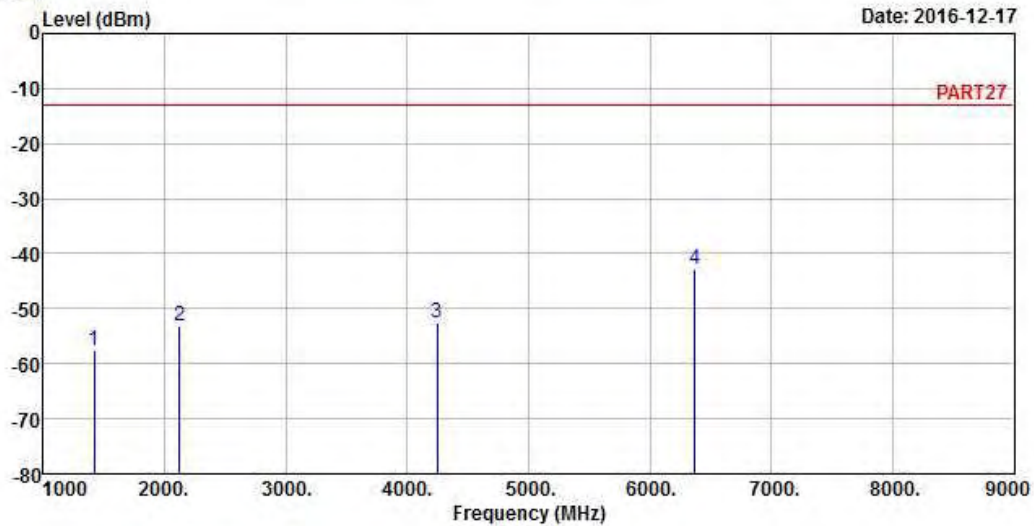

Site : 966 Chamber 5
 Condition: PART27 VERTICAL
 Remak : LTE Band 12 QPSK_10M_M-CH
 Tested by: Getaz Yang

	Freq	Level	Read Level	Limit Line	Over Limit	Factor	Remark
	MHz	dBm	dBm	dBm	dB	dB	
1	1415.00	-57.59	-43.25	-13.00	-44.59	-14.34	Peak
2	2122.50	-53.27	-41.03	-13.00	-40.27	-12.24	Peak
3	4245.00	-52.40	-45.58	-13.00	-39.40	-6.82	Peak
4 pp	6367.50	-42.71	-43.86	-13.00	-29.71	1.15	Peak

High Channel



Bureau Veritas Consumer Products Services Ltd., Taoyuan Branch

A D T

Data: 3

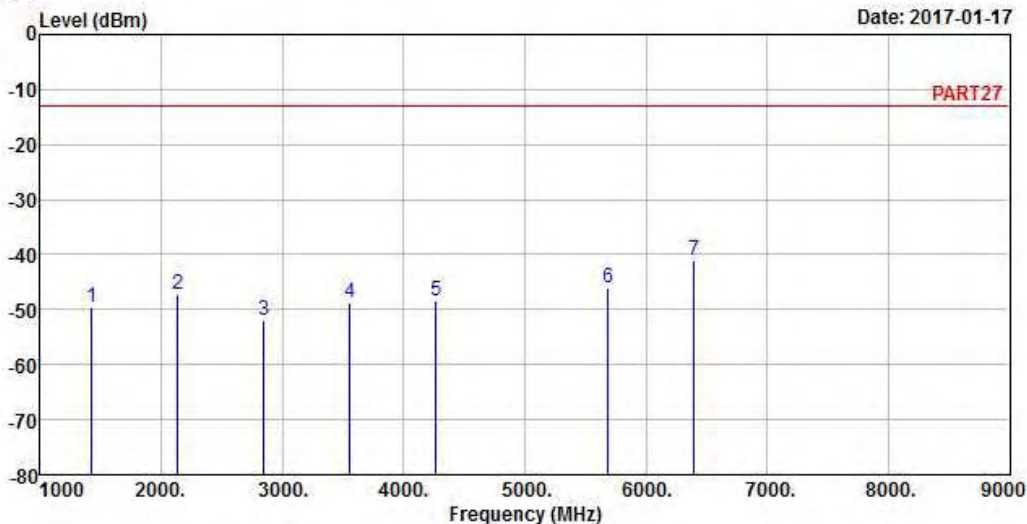

Site : 966 Chamber 5
 Condition: PART27 HORIZONTAL
 Remak : LTE Band 12 QPSK_10M_H-CH
 Tested by: Getaz Yang

	Freq	Level	Read Level	Limit Line	Over Limit	Factor	Remark
	MHz	dBm	dBm	dBm	dB	dB	
1	1422.00	-49.69	-35.35	-13.00	-36.69	-14.34	Peak
2	2133.00	-47.09	-35.02	-13.00	-34.09	-12.07	Peak
3	2844.00	-51.94	-42.23	-13.00	-38.94	-9.71	Peak
4	3555.00	-48.77	-40.31	-13.00	-35.77	-8.46	Peak
5	4266.00	-48.56	-41.67	-13.00	-35.56	-6.89	Peak
6	5688.00	-46.18	-44.04	-13.00	-33.18	-2.14	Peak
7 pp	6399.00	-41.11	-42.44	-13.00	-28.11	1.33	Peak



A D T

Data: 4

Date: 2017-01-17

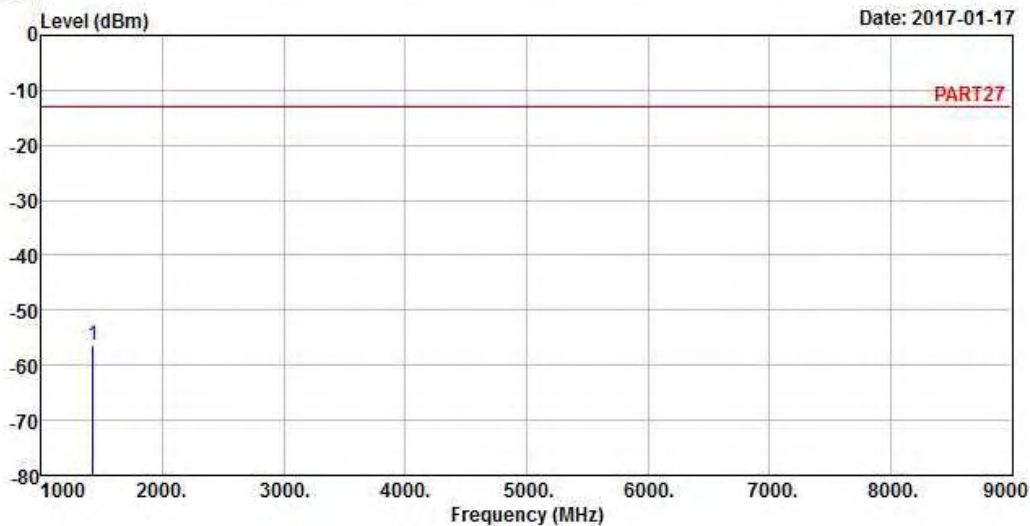

Site : 966 Chamber 5
 Condition: PART27 VERTICAL
 Remak : LTE Band 12 QPSK_10M_H-CH
 Tested by: Getaz Yang

	Freq	Level	Read Level	Limit Line	Over Limit	Factor	Remark
	MHz	dBm	dBm	dBm	dB	dB	
1	pp 1422.00	-56.32	-41.98	-13.00	-43.32	-14.34	Peak

5 Pictures of Test Arrangements

Please refer to the attached file (Test Setup Photo).

Appendix – Information on the Testing Laboratories

We, Bureau Veritas Consumer Products Services (H.K.) Ltd., Taoyuan Branch, were founded in 1988 to provide our best service in EMC, Radio, Telecom and Safety consultation. Our laboratories are accredited and approved according to ISO/IEC 17025.

If you have any comments, please feel free to contact us at the following:

Linko EMC/RF Lab

Tel: 886-2-26052180

Fax: 886-2-26051924

Hsin Chu EMC/RF/Telecom Lab

Tel: 886-3-6668565

Fax: 886-3-6668323

Hwa Ya EMC/RF/Safety

Tel: 886-3-3183232

Fax: 886-3-3270892

Email: service.adt@tw.bureauveritas.com

Web Site: www.bureauveritas-adt.com

The address and road map of all our labs can be found in our web site also.

--- END ---