

# FCC Test Report

## (PART 24)

**Report No.:** RF171027C05-2

**FCC ID:** XHG-R871A

**Test Model:** R871

**Received Date:** Nov. 17, 2016

**Test Date:** Dec. 17, 2016 ~ Dec. 27, 2016

**Issued Date:** Nov. 13, 2017

**Applicant:** Franklin Technology Inc.

**Address:** 906 JEI Platz, 186, Gasan digital 1-ro, Geumcheon-gu, Seoul, Korea,  
(08502)

**Issued By:** Bureau Veritas Consumer Products Services (H.K.) Ltd., Taoyuan Branch

**Lab Address:** No. 47-2, 14th Ling, Chia Pau Vil., Lin Kou Dist., New Taipei City, Taiwan  
( R.O.C )

**Test Location:** No. 19, Hwa Ya 2nd Rd, Wen Hwa Tsuen, Kwei Shan Hsiang, Taoyuan  
Hsien 333, Taiwan, R.O.C.



This report is for your exclusive use. Any copying or replication of this report to or for any other person or entity, or use of our name or trademark, is permitted only with our prior written permission. This report sets forth our findings solely with respect to the test samples identified herein. The results set forth in this report are not indicative or representative of the quality or characteristics of the lot from which a test sample was taken or any similar or identical product unless specifically and expressly noted. Our report includes all of the tests requested by you and the results thereof based upon the information that you provided to us. You have 60 days from date of issuance of this report to notify us of any material error or omission caused by our negligence, provided, however, that such notice shall be in writing and shall specifically address the issue you wish to raise. A failure to raise such issue within the prescribed time shall constitute your unqualified acceptance of the completeness of this report, the tests conducted and the correctness of the report contents. Unless specific mention, the uncertainty of measurement has been explicitly taken into account to declare the compliance or non-compliance to the specification. The report must not be used by the client to claim product certification, approval, or endorsement by TAF or any government agencies.

## Table of Contents

<b>Release Control Record</b> .....	<b>3</b>
<b>1 Certificate of Conformity</b> .....	<b>4</b>
<b>2 Summary of Test Results</b> .....	<b>5</b>
2.1 Measurement Uncertainty .....	5
2.2 Test Site And Instruments .....	6
<b>3 General Information</b> .....	<b>7</b>
3.1 General Description of EUT .....	7
3.2 Configuration of System under Test.....	9
3.2.1 Description of Support Units .....	9
3.3 Test Mode Applicability and Tested Channel Detail .....	10
3.4 EUT Operating Conditions .....	15
3.5 General Description of Applied Standards.....	15
<b>4 Test Types and Results</b> .....	<b>16</b>
4.1 Output Power Measurement .....	16
4.1.1 Limits of Output Power Measurement .....	16
4.1.2 Test Procedures.....	16
4.1.3 Test Setup .....	17
4.1.4 Test Results .....	18
4.2 Frequency Stability Measurement .....	29
4.2.1 Limits of Frequency Stability Measurement.....	29
4.2.2 Test Procedure .....	29
4.2.3 Test Setup .....	29
4.2.4 Test Results .....	30
4.3 Occupied Bandwidth Measurement.....	37
4.3.1 Test Procedure .....	37
4.3.2 Test Setup.....	37
4.3.3 Test Result .....	38
4.4 Band Edge Measurement .....	45
4.4.1 Limits of Band Edge Measurement .....	45
4.4.2 Test Setup.....	45
4.4.3 Test Procedures.....	45
4.4.4 Test Results .....	46
4.5 Peak to Average Ratio .....	58
4.5.1 Limits of Peak to Average Ratio Measurement .....	58
4.5.2 Test Setup.....	58
4.5.3 Test Procedures.....	58
4.5.4 Test Results .....	59
4.6 Conducted Spurious Emissions .....	66
4.6.1 Limits of Conducted Spurious Emissions Measurement.....	66
4.6.2 Test Setup.....	66
4.6.3 Test Procedure .....	66
4.6.4 Test Results .....	67
4.7 Radiated Emission Measurement.....	80
4.7.1 Limits of Radiated Emission Measurement .....	80
4.7.2 Test Procedure .....	80
4.7.3 Deviation from Test Standard .....	80
4.7.4 Test Setup.....	80
4.7.5 Test Results .....	81
<b>5 Pictures of Test Arrangements</b> .....	<b>99</b>
<b>Appendix – Information on the Testing Laboratories</b> .....	<b>100</b>

### Release Control Record

Issue No.	Description	Date Issued
RF171027C05-2	Original Release	Nov. 13, 2017

## 1 Certificate of Conformity

**Product:** Mobile Hotspot

**Brand:** Franklin

**Test Model:** R871

**Sample Status:** Production Unit

**Applicant:** Franklin Technology Inc.

**Test Date:** Dec. 17, 2016 ~ Dec. 27, 2016

**Standards:** FCC Part 24, Subpart E

The above equipment has been tested by **Bureau Veritas Consumer Products Services (H.K.) Ltd., Taoyuan Branch**, and found compliance with the requirement of the above standards. The test record, data evaluation & Equipment Under Test (EUT) configurations represented herein are true and accurate accounts of the measurements of the sample's EMC characteristics under the conditions specified in this report.

**Prepared by :**  , **Date:** Nov. 13, 2017  
Gina Liu / Specialist

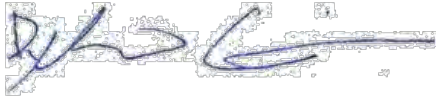
**Approved by :**  , **Date:** Nov. 13, 2017  
Dylan Chiou / Project Engineer

## 2 Summary of Test Results

Applied Standard: FCC Part 24 & Part 2			
FCC Clause	Test Item	Result	Remarks
2.1046 24.232	Effective Isotropic Radiated Power	Pass	Meet the requirement of limit.
2.1046 24.232(d)	Peak to Average Ratio	Pass	Meet the requirement of limit.
2.1055 24.235	Frequency Stability	Pass	Meet the requirement of limit.
2.1049 24.238(b)	Occupied Bandwidth	Pass	Meet the requirement of limit.
24.238(b)	Band Edge Measurements	Pass	Meet the requirement of limit.
2.1051 24.238	Conducted Spurious Emissions	Pass	Meet the requirement of limit.
2.1053 24.238	Radiated Spurious Emissions	Pass	Meet the requirement of limit. Minimum passing margin is -12.32 dB at 5715.00 MHz.

### 2.1 Measurement Uncertainty

Where relevant, the following measurement uncertainty levels have been estimated for tests performed on the EUT as specified in CISPR 16-4-2:

Measurement	Frequency	Expanded Uncertainty (k=2) (±)
Conducted Emissions at mains ports	150 kHz ~ 30 MHz	2.44 dB
Radiated Emissions up to 1 GHz	30 MHz ~ 200 MHz	2.93 dB
	200 MHz ~ 1000 MHz	2.95 dB
Radiated Emissions above 1 GHz	1 GHz ~ 18 GHz	2.26 dB
	18 GHz ~ 40 GHz	1.94 dB

## 2.2 Test Site And Instruments

Description & Manufacturer	Model No.	Serial No.	Date of Calibration	Due Date of Calibration
Test Receiver Agilent	N9038A	MY51210203	Jan. 21, 2016	Jan. 20, 2017
Spectrum Analyzer Agilent	N9010A	MY52220314	Dec. 16, 2016	Dec. 15, 2017
Spectrum Analyzer ROHDE & SCHWARZ	FSU43	101261	Dec. 13, 2016	Dec. 12, 2017
BILOG Antenna SCHWARZBECK	VULB9168	9168-472	Jan. 07, 2016	Jan. 06, 2017
HORN Antenna SCHWARZBECK	BBHA 9120 D	9120D-969	Jan. 04, 2016	Jan. 03, 2017
Double Ridge Guide Horn Antenna EMCO	3115	5619	Jan. 04, 2016	Jan. 03, 2017
BILOG Antenna SCHWARZBECK	VULB 9168	9168-153	Jan. 07, 2016	Jan. 06, 2017
Fixed Attenuator Mini-Circuits	BW-N10W5+	NA	Jul. 08, 2016	Jul. 07, 2017
MXG Vector signal generator Agilent	N5182B	MY53050430	Oct. 19, 2016	Oct. 18, 2017
Preamplifier EMCI	EMC 012645	980115	Oct. 21, 2016	Oct. 20, 2017
Preamplifier EMCI	EMC 184045	980116	Oct. 21, 2016	Oct. 20, 2017
Preamplifier EMCI	EMC 330H	980112	Oct. 21, 2016	Oct. 20, 2017
Power Meter Anritsu	ML2495A	1232002	Sep. 08, 2016	Sep. 07, 2017
Power Sensor Anritsu	MA2411B	1207325	Sep. 08, 2016	Sep. 07, 2017
RF signal cable HUBER+SUHNNER	SUCOFLEX 104	309219/4 2950114	Oct. 21, 2016	Oct. 20, 2017
RF signal cable HUBER+SUHNNER	SUCOFLEX 104	250130/4	Oct. 21, 2016	Oct. 20, 2017
RF Coaxial Cable Worken	8D-FB	Cable-Ch10-01	Oct. 21, 2016	Oct. 20, 2017
Software BV ADT	E3 6.120103	NA	NA	NA
Antenna Tower MF	MFA-440H	NA	NA	NA
Turn Table MF	MFT-201SS	NA	NA	NA
Antenna Tower & Turn Table Controller MF	MF-7802	NA	NA	NA
Fixed Attenuator Mini-Circuits	BW-N10W5+	NA	Jul. 08, 2016	Jul. 07, 2017
Radio Communication Analyzer	MT8820C	6201300640	Aug. 10, 2015	Aug. 09, 2017
Communications Tester-Wireless	8960 Series 10	MY53201073	Jul. 03, 2015	Jul. 02, 2017

- Note:
- The calibration interval of the above test instruments is 12 / 24 months and the calibrations are traceable to NML/ROC and NIST/USA.
  - The test was performed in HwaYa Chamber 10.
  - The horn antenna and preamplifier (model: EMC 184045) are used only for the measurement of emission frequency above 1 GHz if tested.
  - The FCC Designation Number is TW0003. The number will be varied with the Lab location and scope as attached.
  - The IC Site Registration No. is IC7450F-10.

### 3 General Information

#### 3.1 General Description of EUT

<b>Product</b>	Mobile Hotspot	
<b>Brand</b>	Franklin	
<b>Test Model</b>	R871	
<b>Status of EUT</b>	Production Unit	
<b>Power Supply Rating</b>	5.0 Vdc (adapter or host equipment) 3.8 Vdc (Li-ion battery)	
<b>Modulation Type</b>	CDMA	QPSK, OQPSK, HPSK
	LTE	QPSK, 16QAM
<b>Frequency Range</b>	CDMA	1851.3 ~ 1908.8 MHz
	LTE Band 2 (Channel Bandwidth: 1.4 MHz)	1850.7 ~ 1909.3 MHz
	LTE Band 2 (Channel Bandwidth: 3 MHz)	1851.5 ~ 1908.5 MHz
	LTE Band 2 (Channel Bandwidth: 5 MHz)	1852.5 ~ 1907.5 MHz
	LTE Band 2 (Channel Bandwidth: 10 MHz)	1855.0 ~ 1905.0 MHz
	LTE Band 2 (Channel Bandwidth: 15 MHz)	1857.5 ~ 1902.5 MHz
	LTE Band 2 (Channel Bandwidth: 20 MHz)	1860.0 ~ 1900.0 MHz
	LTE Band 25 (Channel Bandwidth: 1.4 MHz)	1850.7 ~ 1914.3 MHz
	LTE Band 25 (Channel Bandwidth: 3 MHz)	1851.5 ~ 1913.5 MHz
	LTE Band 25 (Channel Bandwidth: 5 MHz)	1852.5 ~ 1912.5 MHz
	LTE Band 25 (Channel Bandwidth: 10 MHz)	1855.0 ~ 1910.0 MHz
	LTE Band 25 (Channel Bandwidth: 15 MHz)	1857.5 ~ 1907.5 MHz
	LTE Band 25 (Channel Bandwidth: 20 MHz)	1860.0 ~ 1905.0 MHz
	<b>Max. EIRP Power</b>	CDMA
LTE Band 2 (Channel Bandwidth: 1.4 MHz)		122.24 mW
LTE Band 2 (Channel Bandwidth: 3 MHz)		123.94 mW
LTE Band 2 (Channel Bandwidth: 5 MHz)		134.65 mW
LTE Band 2 (Channel Bandwidth: 10 MHz)		138.42 mW
LTE Band 2 (Channel Bandwidth: 15 MHz)		142.96 mW
LTE Band 2 (Channel Bandwidth: 20 MHz)		153.18 mW
LTE Band 25 (Channel Bandwidth: 1.4 MHz)		139.00 mW
LTE Band 25 (Channel Bandwidth: 3 MHz)		147.23 mW
LTE Band 25 (Channel Bandwidth: 5 MHz)		181.97 mW
LTE Band 25 (Channel Bandwidth: 10 MHz)		208.93 mW
LTE Band 25 (Channel Bandwidth: 15 MHz)		210.86 mW
LTE Band 25 (Channel Bandwidth: 20 MHz)		212.32 mW

<b>Emission Designator</b>	CDMA	1M28F9W
	LTE Band 2 (Channel Bandwidth: 1.4 MHz)	1M09W7D
	LTE Band 2 (Channel Bandwidth: 3 MHz)	2M70G7D
	LTE Band 2 (Channel Bandwidth: 5 MHz)	4M50W7D
	LTE Band 2 (Channel Bandwidth: 10 MHz)	8M98G7D
	LTE Band 2 (Channel Bandwidth: 15 MHz)	13M5G7D
	LTE Band 2 (Channel Bandwidth: 20 MHz)	17M9W7D
	LTE Band 25 (Channel Bandwidth: 1.4 MHz)	1M09W7D
	LTE Band 25 (Channel Bandwidth: 3 MHz)	2M70G7D
	LTE Band 25 (Channel Bandwidth: 5 MHz)	4M49W7D
	LTE Band 25 (Channel Bandwidth: 10 MHz)	8M96W7D
	LTE Band 25 (Channel Bandwidth: 15 MHz)	13M5G7D
	LTE Band 25 (Channel Bandwidth: 20 MHz)	18M0W7D
	<b>Antenna Type</b>	Fixed Internal Antenna
<b>Accessory Device</b>	Refer to Note as below	
<b>Data Cable Supplied</b>	Refer to Note as below	

Note:

1. The EUT contains following accessory devices.

Product	Brand	Model	Description
Adapter	Franklin Wireless	FWCR900TVL	I/P: 100-240 Vac, 0.3 A O/P: 5 Vdc, 1.0 A 1.5 m cable non-shielded cable w/o core
Battery	Franklin Wireless	R850	3.8 Vdc, 2450 mAh

2. The above EUT information is declared by manufacturer and for more detailed features description, please refer to the manufacturer's specifications or user's manual.



### 3.2 Configuration of System under Test

#### <Radiated Emission Test>

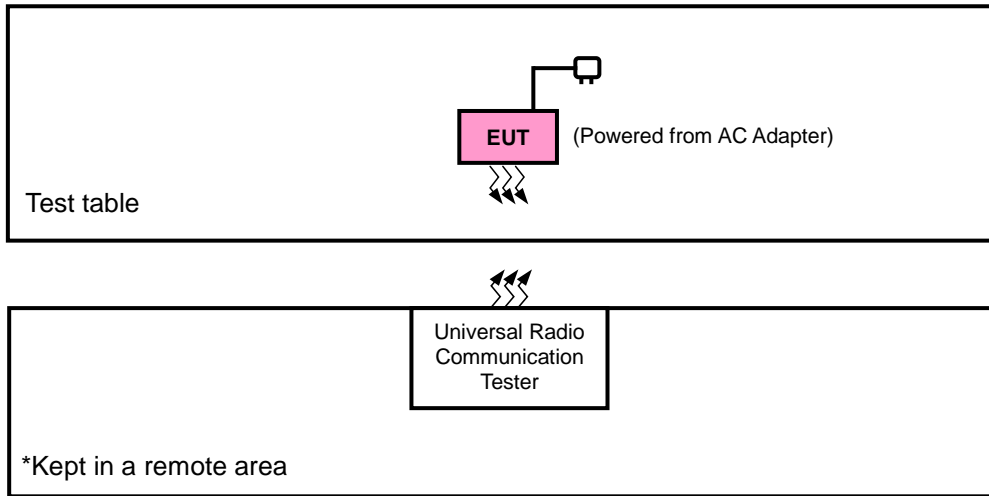

#### <E.I.R.P. Test>

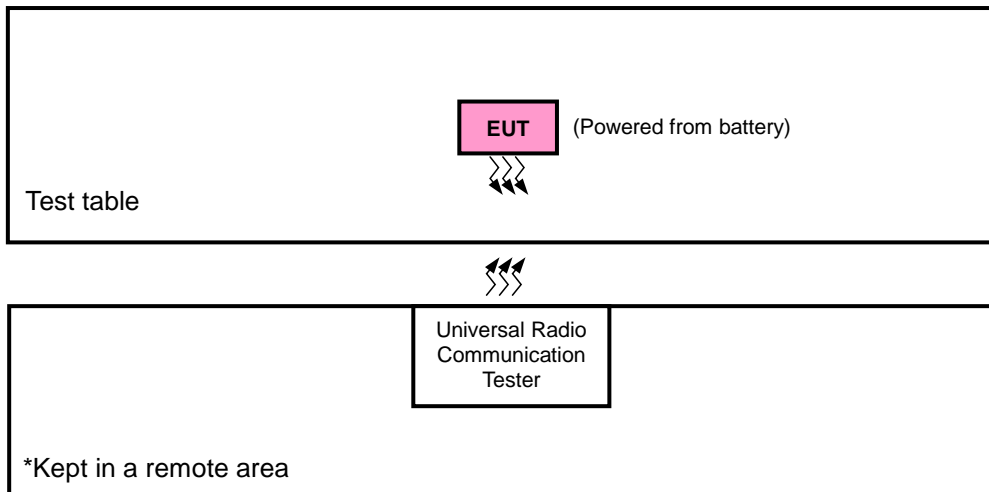

#### 3.2.1 Description of Support Units

The EUT has been tested as an independent unit together with other necessary accessories or support units.

### 3.3 Test Mode Applicability and Tested Channel Detail

Pre-Scan has been conducted to determine the worst-case mode from all possible combinations between available modulations, data rates, XYZ axis, and antenna ports.

The worst case was found when positioned as the table below. Following channel(s) was (were) selected for the final test as listed below:

Band	EIRP	Radiated Emission
CDMA	Y-plane	Y-axis
LTE Band 2	X-plane	Y-axis
LTE Band 25	X-plane	Y-axis

#### CDMA

EUT Configure Mode	Test Item	Available Channel	Tested Channel	Mode
-	ERP	25 to 1175	25, 600, 1175	1xEVDO
-	Frequency Stability	25 to 1175	600	1xEVDO
-	Occupied Bandwidth	25 to 1175	25, 600, 1175	1xEVDO
-	Band Edge	25 to 1175	25, 600, 1175	1xEVDO
-	Peak to Average Ratio	25 to 1175	25, 1175	1xEVDO
-	Condcudeted Emission	25 to 1175	25, 600, 1175	1xEVDO
-	Radiated Emission	25 to 1175	25, 600, 1175	1xEVDO

**LTE Band 2**

EUT Configure Mode	Test Item	Available Channel	Tested Channel	Channel Bandwidth	Modulation	Mode
-	EIRP	18607 to 19193	18607, 18900, 19193	1.4 MHz	QPSK	1 RB / 0 RB Offset
					16QAM	3 RB / 1 RB Offset
		18615 to 19185	18615, 18900, 19185	3 MHz	QPSK	1 RB / 0 RB Offset
					16QAM	1 RB / 7 RB Offset
		18625 to 19175	18625, 18900, 19175	5 MHz	QPSK	1 RB / 0 RB Offset
					16QAM	1 RB / 12 RB Offset
		18650 to 19150	18650, 18900, 19150	10 MHz	QPSK	1 RB / 0 RB Offset
					16QAM	1 RB / 0 RB Offset
		18675 to 19125	18675, 18900, 19125	15 MHz	QPSK	1 RB / 0 RB Offset
					16QAM	1 RB / 37 RB Offset
		18700 to 19100	18700, 18900, 19100	20 MHz	QPSK	1 RB / 0 RB Offset
					16QAM	1 RB / 50 RB Offset
-	Frequency Stability	18607 to 19193	18900	1.4 MHz	QPSK	1 RB / 0 RB Offset
		18615 to 19185	18900	3 MHz	QPSK	1 RB / 0 RB Offset
		18625 to 19175	18900	5 MHz	QPSK	1 RB / 0 RB Offset
		18650 to 19150	18900	10 MHz	QPSK	1 RB / 0 RB Offset
		18675 to 19125	18900	15 MHz	QPSK	1 RB / 0 RB Offset
		18700 to 19100	18900	20 MHz	QPSK	1 RB / 0 RB Offset
-	Occupied Bandwidth	18607 to 19193	18607, 18900, 19193	1.4 MHz	QPSK, 16QAM	6 RB / 0 RB Offset
		18615 to 19185	18615, 18900, 19185	3 MHz	QPSK, 16QAM	15 RB / 0 RB Offset
		18625 to 19175	18625, 18900, 19175	5 MHz	QPSK, 16QAM	25 RB / 0 RB Offset
		18650 to 19150	18650, 18900, 19150	10 MHz	QPSK, 16QAM	50 RB / 0 RB Offset
		18675 to 19125	18675, 18900, 19125	15 MHz	QPSK, 16QAM	75 RB / 0 RB Offset
		18700 to 19100	18700, 18900, 19100	20 MHz	QPSK, 16QAM	100 RB / 0 RB Offset
-	Peak to Average Ratio	18607 to 19193	18607, 18900, 19193	1.4 MHz	QPSK	1 RB / 0 RB Offset
					16QAM	3 RB / 1 RB Offset
		18615 to 19185	18615, 18900, 19185	3 MHz	QPSK	1 RB / 0 RB Offset
					16QAM	1 RB / 7 RB Offset
		18625 to 19175	18625, 18900, 19175	5 MHz	QPSK	1 RB / 0 RB Offset
					16QAM	1 RB / 12 RB Offset
		18650 to 19150	18650, 18900, 19150	10 MHz	QPSK	1 RB / 0 RB Offset
					16QAM	1 RB / 0 RB Offset
		18675 to 19125	18675, 18900, 19125	15 MHz	QPSK	1 RB / 0 RB Offset
					16QAM	1 RB / 37 RB Offset
		18700 to 19100	18700, 18900, 19100	20 MHz	QPSK	1 RB / 0 RB Offset
					16QAM	1 RB / 50 RB Offset

EUT Configure Mode	Test Item	Available Channel	Tested Channel	Channel Bandwidth	Modulation	Mode		
-	Band Edge	18607 to 19193	18607	1.4 MHz	QPSK	1 RB / 0 RB Offset		
			19193	1.4 MHz		6 RB / 0 RB Offset		
		18615 to 19185	18615	3 MHz	QPSK	1 RB / 5 RB Offset		
			19185	3 MHz		6 RB / 0 RB Offset		
		18625 to 19175	18625	5 MHz	QPSK	1 RB / 0 RB Offset		
			19175	5 MHz		15 RB / 0 RB Offset		
		18650 to 19150	18650	10 MHz	QPSK	1 RB / 14 RB Offset		
			19150	10 MHz		15 RB / 0 RB Offset		
		18675 to 19125	18675	15 MHz	QPSK	1 RB / 0 RB Offset		
			19125	15 MHz		25 RB / 0 RB Offset		
		18700 to 19100	18700	20 MHz	QPSK	1 RB / 24 RB Offset		
			19100	20 MHz		25 RB / 0 RB Offset		
		-	Conducted Emission	18607 to 19193	18607, 18900, 19193	1.4 MHz	QPSK	1 RB / 0 RB Offset
				18615 to 19185	18615, 18900, 19185	3 MHz		1 RB / 0 RB Offset
				18625 to 19175	18625, 18900, 19175	5 MHz		1 RB / 0 RB Offset
				18650 to 19150	18650, 18900, 19150	10 MHz		1 RB / 0 RB Offset
18675 to 19125	18675, 18900, 19125			15 MHz	1 RB / 0 RB Offset			
18700 to 19100	18700, 18900, 19100			20 MHz	1 RB / 0 RB Offset			
-	Radiated Emission	18700 to 19100	18700, 18900, 19100	20 MHz	QPSK	1 RB / 0 RB Offset		

**Note:** This device was tested under all bandwidths, RB configurations and modulations. The worst case was found in QPSK modulation.

**LTE Band 25**

EUT Configure Mode	Test Item	Available Channel	Tested Channel	Channel Bandwidth	Modulation	Mode
-	EIRP	26047 to 26683	26047, 26365, 26683	1.4 MHz	QPSK	1 RB / 0 RB Offset
					16QAM	3 RB / 3 RB Offset
		26055 to 26675	26055, 26365, 26675	3 MHz	QPSK	1 RB / 0 RB Offset
					16QAM	1 RB / 7 RB Offset
		26065 to 26665	26065, 26365, 26665	5 MHz	QPSK	1 RB / 0 RB Offset
					16QAM	1 RB / 0 RB Offset
		26090 to 26640	26090, 26365, 26640	10 MHz	QPSK	1 RB / 0 RB Offset
					16QAM	1 RB / 24 RB Offset
		26115 to 26615	26115, 26365, 26615	15 MHz	QPSK	1 RB / 0 RB Offset
					16QAM	1 RB / 0 RB Offset
		26140 to 26590	26140, 26365, 26590	20 MHz	QPSK	1 RB / 0 RB Offset
					16QAM	1 RB / 50 RB Offset
-	Frequency Stability	26047 to 26683	26365	1.4 MHz	QPSK	1 RB / 0 RB Offset
		26055 to 26675	26365	3 MHz	QPSK	1 RB / 0 RB Offset
		26065 to 26665	26365	5 MHz	QPSK	1 RB / 0 RB Offset
		26090 to 26640	26365	10 MHz	QPSK	1 RB / 0 RB Offset
		26115 to 26615	26365	15 MHz	QPSK	1 RB / 0 RB Offset
		26140 to 26590	26365	20 MHz	QPSK	1 RB / 0 RB Offset
-	Occupied Bandwidth	26047 to 26683	26047, 26365, 26683	1.4 MHz	QPSK / 16QAM	6 RB / 0 RB Offset
		26055 to 26675	26055, 26365, 26675	3 MHz	QPSK / 16QAM	15 RB / 0 RB Offset
		26065 to 26665	26065, 26365, 26665	5 MHz	QPSK / 16QAM	25 RB / 0 RB Offset
		26090 to 26640	26090, 26365, 26640	10 MHz	QPSK / 16QAM	50 RB / 0 RB Offset
		26115 to 26615	26115, 26365, 26615	15 MHz	QPSK / 16QAM	75 RB / 0 RB Offset
		26140 to 26590	26140, 26365, 26590	20 MHz	QPSK / 16QAM	100 RB / 0 RB Offset
-	Peak to Average Ratio	26047 to 26683	26047, 26365, 26683	1.4 MHz	QPSK	1 RB / 0 RB Offset
					16QAM	3 RB / 3 RB Offset
		26055 to 26675	26055, 26365, 26675	3 MHz	QPSK	1 RB / 0 RB Offset
					16QAM	1 RB / 7 RB Offset
		26065 to 26665	26065, 26365, 26665	5 MHz	QPSK	1 RB / 0 RB Offset
					16QAM	1 RB / 0 RB Offset
		26090 to 26640	26090, 26365, 26640	10 MHz	QPSK	1 RB / 0 RB Offset
					16QAM	1 RB / 24 RB Offset
		26115 to 26615	26115, 26365, 26615	15 MHz	QPSK	1 RB / 0 RB Offset
					16QAM	1 RB / 0 RB Offset
		26140 to 26590	26140, 26365, 26590	20 MHz	QPSK	1 RB / 0 RB Offset
					16QAM	1 RB / 50 RB Offset

EUT Configure Mode	Test Item	Available Channel	Tested Channel	Channel Bandwidth	Modulation	Mode		
-	Band Edge	26047 to 26683	26047	1.4 MHz	QPSK	1 RB / 0 RB Offset 6 RB / 0 RB Offset		
			26683	1.4 MHz	QPSK	1 RB / 5 RB Offset 6 RB / 0 RB Offset		
		26055 to 26675	26055	3 MHz	QPSK	1 RB / 0 RB Offset 1 RB / 0 RB Offset		
			26675	3 MHz	QPSK	1 RB / 14 RB Offset 15 RB / 0 RB Offset		
		26065 to 26665	26065	5 MHz	QPSK	1 RB / 0 RB Offset 25 RB / 0 RB Offset		
			26665	5 MHz	QPSK	1 RB / 24 RB Offset 25 RB / 0 RB Offset		
		26090 to 26640	26090	10 MHz	QPSK	1 RB / 0 RB Offset 50 RB / 0 RB Offset		
			26640	10 MHz	QPSK	1 RB / 49 RB Offset 50 RB / 0 RB Offset		
		26115 to 26615	26115	15 MHz	QPSK	1 RB / 0 RB Offset 75 RB / 0 RB Offset		
			26615	15 MHz	QPSK	1 RB / 74 RB Offset 75 RB / 0 RB Offset		
		26140 to 26590	26140	20 MHz	QPSK	1 RB / 0 RB Offset 100 RB / 0 RB Offset		
			26590	20 MHz	QPSK	1 RB / 99 RB Offset 100 RB / 0 RB Offset		
		-	Conducted Emission	26047 to 26683	26047, 26365, 26683	1.4 MHz	QPSK	1 RB / 0 RB Offset
				26055 to 26675	26055, 26365, 26675	3 MHz	QPSK	1 RB / 0 RB Offset
				26065 to 26665	26065, 26365, 26665	5 MHz	QPSK	1 RB / 0 RB Offset
				26090 to 26640	26090, 26365, 26640	10 MHz	QPSK	1 RB / 0 RB Offset
				26115 to 26615	26115, 26365, 26615	15 MHz	QPSK	1 RB / 0 RB Offset
				26140 to 26590	26140, 26365, 26590	20 MHz	QPSK	1 RB / 0 RB Offset
-	Radiated Emission	26140 to 26590	26140, 26365, 26590	20 MHz	QPSK	1 RB / 0 RB Offset		

**Note:** This device was tested under all bandwidths, RB configurations and modulations. The worst case was found in QPSK modulation.

**Test Condition:**

Test Item	Environmental Conditions	Input Power	Tested By
EIRP	26 deg. C, 58 % RH	3.8 Vdc	Gavin Wu
Frequency Stability	26 deg. C, 58 % RH	3.8 Vdc	Carlos Chen
Occupied Bandwidth	26 deg. C, 58 % RH	3.8 Vdc	Carlos Chen
Band Edge	26 deg. C, 58 % RH	3.8 Vdc	Carlos Chen
Peak to Average Ratio	26 deg. C, 58 % RH	3.8 Vdc	Carlos Chen
Condcudeted Emission	26 deg. C, 58 % RH	3.8 Vdc	Carlos Chen
Radiated Emission	25 deg. C, 65 % RH	120 Vac, 60 Hz	Gavin Wu

**3.4 EUT Operating Conditions**

The EUT makes a call to the communication simulator. The communication simulator station system controlled a EUT to export maximum output power under transmission mode and specific channel frequency

**3.5 General Description of Applied Standards**

The EUT is a RF Product. According to the specifications of the manufacturer, it must comply with the requirements of the following standards:

**FCC 47 CFR Part 2**

**FCC 47 CFR Part 24**

**KDB 971168 D01 Power Meas License Digital Systems v02r02**

**ANSI/TIA/EIA-603-D 2010**

**NOTE:** All test items have been performed and recorded as per the above standards.

## 4 Test Types and Results

### 4.1 Output Power Measurement

#### 4.1.1 Limits of Output Power Measurement

Mobile / Portable station are limited to 2 watts e.i.r.p.

#### 4.1.2 Test Procedures

##### **EIRP / ERP Measurement:**

- a. All measurements were done at low, middle and high operational frequency range. RBW and VBW is 5 MHz for CDMA and 10 MHz for LTE mode.
- b. Substitution method is used for E.I.R.P measurement. In the semi-anechoic chamber, EUT placed on the 0.8 m height of Turn Table, rotated the table around 360 degrees to search the maximum radiation power and receiver antenna shall be rotated vertical and horizontal polarization and moved height from 1m to 4m to find the maximum polar radiated power. The "Read Value" is the spectrum reading the maximum power value.
- c. The substitution horn antenna is substituted for EUT at the same position and signals generator export the CW signal to the substitution antenna via a tx cable. Rotated the Turn Table and moved receiving antenna to find the maximum radiation power. Adjust output power level of S.G to get a Value of spectrum reading equal to "Read Value" of step b. Record the power level of S.G.
- d.  $EIRP = \text{Output power level of S.G} - \text{TX cable loss} + \text{Antenna gain of substitution horn}$ . E.R.P power can be calculated form E.I.R.P power by subtracting the gain of dipole,  $E.R.P \text{ power} = E.I.P.R \text{ power} - 2.15 \text{ dBi}$ .

##### **Conducted Power Measurement:**

The EUT was set up for the maximum power with CDMA and LTE link data modulation and link up with simulator. Set the EUT to transmit under low, middle and high channel and record the power level shown on simulator.



### 4.1.3 Test Setup

#### EIRP / ERP Measurement:

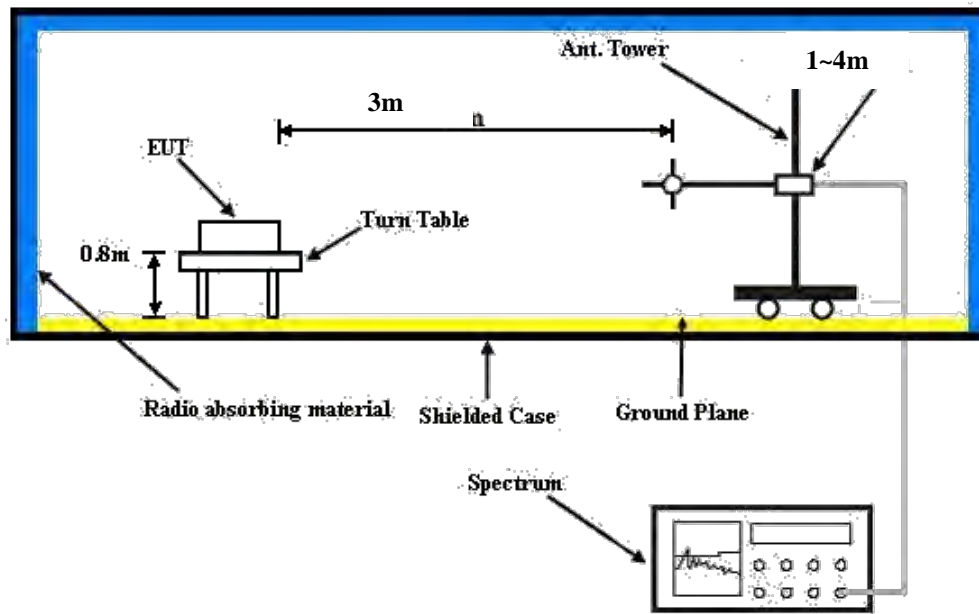

For the actual test configuration, please refer to the attached file (Test Setup Photo).

#### Conducted Power Measurement:



#### 4.1.4 Test Results

##### Conducted Output Power (dBm)

Band	CDMA		
	Channel	25	600
Frequency (MHz)	1851.25	1880	1908.75
RC1+SO55	20.71	20.97	20.38
RC3+SO55	20.55	20.82	20.38
RC3+SO32 (+F-SCH)	20.58	20.83	20.35
RC3+SO32 (+SCH)	20.51	20.87	20.43
RTAP 153.6	20.75	20.83	20.61
RETAP 4096	20.74	20.99	20.65

Band / BW	RB Size	RB Offset	QPSK			3GPP MPR (dB)	16QAM			3GPP MPR (dB)
			Low Ch 18607	Mid Ch 18900	High Ch 19193		Low Ch 18607	Mid Ch 18900	High Ch 19193	
			1850.7 MHz	1880.0 MHz	1909.3 MHz		1850.7 MHz	1880.0 MHz	1909.3 MHz	
2 / 1.4M	1	0	20.86	20.75	20.64	0	19.58	19.57	19.63	1
	1	2	20.81	20.81	20.61	0	19.62	19.53	19.30	1
	1	5	20.85	20.40	20.54	0	19.57	19.35	19.17	1
	3	0	20.84	20.84	20.53	0	19.75	19.63	19.50	1
	3	1	20.83	20.81	20.48	0	19.81	19.68	19.48	1
	3	3	20.84	20.83	20.50	0	19.79	19.69	19.49	1
	6	0	19.80	19.83	19.53	1	18.89	18.67	18.48	2

Band / BW	RB Size	RB Offset	QPSK			3GPP MPR (dB)	16QAM			3GPP MPR (dB)
			Low Ch 18615	Mid Ch 18900	High Ch 19185		Low Ch 18615	Mid Ch 18900	High Ch 19185	
			1851.5 MHz	1880.0 MHz	1908.5 MHz		1851.5 MHz	1880.0 MHz	1908.5 MHz	
2 / 3M	1	0	20.94	20.82	20.68	0	19.53	19.48	19.33	1
	1	7	20.80	20.79	20.62	0	19.28	19.73	19.28	1
	1	14	20.91	20.71	20.61	0	19.36	19.48	19.32	1
	8	0	19.86	19.72	19.52	1	18.98	18.84	18.58	2
	8	3	19.81	19.71	19.58	1	18.88	19.03	18.65	2
	8	7	19.78	19.68	19.56	1	18.97	19.01	18.61	2
	15	0	19.78	19.69	19.59	1	18.72	18.82	18.65	2

Band / BW	RB Size	RB Offset	QPSK			3GPP MPR (dB)	16QAM			3GPP MPR (dB)
			Low Ch 18625	Mid Ch 18900	High Ch 19175		Low Ch 18625	Mid Ch 18900	High Ch 19175	
			1852.5 MHz	1880.0 MHz	1907.5 MHz		1852.5 MHz	1880.0 MHz	1907.5 MHz	
2 / 5M	1	0	20.91	20.89	20.81	0	19.50	19.32	19.39	1
	1	12	20.81	20.80	20.82	0	19.42	19.64	19.22	1
	1	24	20.80	20.61	20.59	0	19.38	19.23	19.23	1
	12	0	19.78	19.67	19.53	1	18.54	18.58	18.27	2
	12	6	19.77	19.75	19.55	1	18.65	18.64	18.39	2
	12	13	19.80	19.68	19.52	1	18.63	18.59	18.46	2
	25	0	19.72	19.73	19.47	1	18.82	18.74	18.42	2

Band / BW	RB Size	RB Offset	QPSK			3GPP MPR (dB)	16QAM			3GPP MPR (dB)
			Low Ch 18650	Mid Ch 18900	High Ch 19150		Low Ch 18650	Mid Ch 18900	High Ch 19150	
			1855.0 MHz	1880.0 MHz	1905.0 MHz		1855.0 MHz	1880.0 MHz	1905.0 MHz	
2 / 10M	1	0	20.96	20.88	20.91	0	19.56	19.43	19.37	1
	1	24	20.91	20.88	20.84	0	19.52	19.48	19.34	1
	1	49	20.90	20.73	20.53	0	19.47	19.28	19.16	1
	25	0	19.90	19.76	19.62	1	19.02	18.65	18.76	2
	25	12	19.98	19.73	19.65	1	19.07	18.85	18.69	2
	25	25	19.80	19.70	19.46	1	18.78	18.60	18.56	2
	50	0	19.84	19.74	19.54	1	18.87	18.86	18.68	2

Band / BW	RB Size	RB Offset	QPSK			3GPP MPR (dB)	16QAM			3GPP MPR (dB)
			Low Ch 18675	Mid Ch 18900	High Ch 19125		Low Ch 18675	Mid Ch 18900	High Ch 19125	
			1857.5 MHz	1880.0 MHz	1902.5 MHz		1857.5 MHz	1880.0 MHz	1902.5 MHz	
2 / 15M	1	0	20.96	20.89	20.86	0	19.52	19.40	19.50	1
	1	37	20.86	20.87	20.65	0	19.59	19.72	19.48	1
	1	74	20.68	20.58	20.52	0	19.26	19.29	19.21	1
	36	0	19.83	19.73	19.68	1	18.83	18.70	18.75	2
	36	19	19.95	19.76	19.63	1	18.88	18.82	18.70	2
	36	39	19.64	19.59	19.49	1	18.65	18.62	18.45	2
	75	0	19.77	19.65	19.68	1	18.87	18.80	18.75	2

Band / BW	RB Size	RB Offset	QPSK			3GPP MPR (dB)	16QAM			3GPP MPR (dB)
			Low Ch 18700	Mid Ch 18900	High Ch 19100		Low Ch 18700	Mid Ch 18900	High Ch 19100	
			1860.0 MHz	1880.0 MHz	1900.0 MHz		1860.0 MHz	1880.0 MHz	1900.0 MHz	
2 / 20M	1	0	20.86	20.97	20.74	0	19.47	19.46	19.37	1
	1	50	20.84	20.71	20.76	0	19.88	19.74	19.73	1
	1	99	20.49	20.62	20.40	0	19.22	19.30	19.12	1
	50	0	19.87	19.91	19.69	1	18.99	18.89	18.79	2
	50	25	19.87	19.78	19.62	1	18.89	18.82	18.67	2
	50	50	19.57	19.64	19.48	1	18.61	18.67	18.53	2
	100	0	19.81	19.85	19.71	1	18.80	18.76	18.64	2

Band / BW	RB Size	RB Offset	QPSK			3GPP MPR (dB)	16QAM			3GPP MPR (dB)
			Low Ch 26047	Mid Ch 26365	High Ch 26683		Low Ch 26047	Mid Ch 26365	High Ch 26683	
			1850.7 MHz	1882.5 MHz	1914.3 MHz		1850.7 MHz	1882.5 MHz	1914.3 MHz	
25 / 1.4M	1	0	20.86	20.77	20.69	0	19.60	19.40	19.71	1
	1	2	20.72	20.63	20.51	0	19.50	19.33	19.34	1
	1	5	20.78	20.57	20.38	0	19.51	19.40	19.41	1
	3	0	20.71	20.66	20.55	0	20.03	19.64	19.65	1
	3	1	20.79	20.67	20.50	0	19.97	19.53	19.67	1
	3	3	20.81	20.69	20.57	0	20.03	19.48	19.38	1
	6	0	19.83	19.50	19.49	1	18.52	18.44	18.54	2

Band / BW	RB Size	RB Offset	QPSK			3GPP MPR (dB)	16QAM			3GPP MPR (dB)
			Low Ch 26055	Mid Ch 26365	High Ch 26675		Low Ch 26055	Mid Ch 26365	High Ch 26675	
			1851.5 MHz	1882.5 MHz	1913.5 MHz		1851.5 MHz	1882.5 MHz	1913.5 MHz	
25 / 3M	1	0	20.93	20.81	20.84	0	19.63	19.38	19.51	1
	1	7	20.87	20.66	20.64	0	19.34	19.12	19.69	1
	1	14	20.81	20.73	20.68	0	19.54	19.37	19.48	1
	8	0	19.85	19.48	19.77	1	18.87	18.56	18.75	2
	8	3	19.81	19.65	19.6	1	18.86	18.54	18.68	2
	8	7	19.82	19.56	19.65	1	18.85	18.74	18.79	2
	15	0	19.85	19.54	19.52	1	18.83	18.68	18.7	2

Band / BW	RB Size	RB Offset	QPSK			3GPP MPR (dB)	16QAM			3GPP MPR (dB)
			Low Ch 26065	Mid Ch 26365	High Ch 26665		Low Ch 26065	Mid Ch 26365	High Ch 26665	
			1852.5 MHz	1882.5 MHz	1912.5 MHz		1852.5 MHz	1882.5 MHz	1912.5 MHz	
25 / 5M	1	0	20.95	20.76	20.86	0	19.47	19.21	19.24	1
	1	12	20.90	20.47	20.57	0	19.40	19.11	19.28	1
	1	24	20.77	20.56	20.55	0	19.38	19.05	19.35	1
	12	0	19.86	19.52	19.50	1	18.72	18.36	18.41	2
	12	6	19.80	19.55	19.50	1	18.92	18.37	18.77	2
	12	13	19.81	19.59	19.64	1	18.77	18.43	18.71	2
	25	0	19.80	19.59	19.60	1	18.84	18.62	18.63	2

Band / BW	RB Size	RB Offset	QPSK			3GPP MPR (dB)	16QAM			3GPP MPR (dB)
			Low Ch 26090	Mid Ch 26365	High Ch 26640		Low Ch 26090	Mid Ch 26365	High Ch 26640	
			1855.0 MHz	1882.5 MHz	1910.0 MHz		1855.0 MHz	1882.5 MHz	1910.0 MHz	
25 / 10M	1	0	20.94	20.95	20.97	0	19.41	19.35	19.33	1
	1	24	20.9	20.7	20.76	0	19.43	19.03	19.01	1
	1	49	20.81	20.55	20.67	0	19.23	19.18	19.36	1
	25	0	19.68	19.6	19.58	1	18.82	18.63	18.72	2
	25	12	19.84	19.61	19.57	1	18.74	18.82	18.65	2
	25	25	19.57	19.547	19.54	1	18.74	18.71	18.65	2
	50	0	19.75	19.59	19.51	1	18.85	18.7	18.62	2

Band / BW	RB Size	RB Offset	QPSK			3GPP MPR (dB)	16QAM			3GPP MPR (dB)
			Low Ch 26115	Mid Ch 26365	High Ch 26615		Low Ch 26115	Mid Ch 26365	High Ch 26615	
			1857.5 MHz	1882.5 MHz	1907.5 MHz		1857.5 MHz	1882.5 MHz	1907.5 MHz	
25 / 15M	1	0	20.84	20.73	20.69	0	19.49	19.39	19.49	1
	1	37	20.73	20.64	20.1	0	19.48	19.37	19.18	1
	1	74	20.63	20.61	20.56	0	19.28	19.11	19.3	1
	36	0	19.77	19.55	19.66	1	18.82	18.51	18.69	2
	36	19	19.78	19.53	19.57	1	18.79	18.54	18.45	2
	36	39	19.58	19.46	19.55	1	18.67	18.59	18.63	2
	75	0	19.72	19.58	19.59	1	18.71	18.72	18.57	2

Band / BW	RB Size	RB Offset	QPSK			3GPP MPR (dB)	16QAM			3GPP MPR (dB)
			Low Ch 26140	Mid Ch 26365	High Ch 26590		Low Ch 26140	Mid Ch 26365	High Ch 26590	
			1860.0 MHz	1882.5 MHz	1905.0 MHz		1860.0 MHz	1882.5 MHz	1905.0 MHz	
25 / 20M	1	0	20.98	20.86	20.84	0	19.56	19.43	19.53	1
	1	50	20.93	20.87	20.82	0	19.67	19.6	19.53	1
	1	99	20.79	20.66	20.74	0	19.42	19.3	19.31	1
	50	0	19.76	19.65	19.75	1	18.67	18.56	18.87	2
	50	25	18.73	19.67	19.65	1	18.64	18.48	18.86	2
	50	50	19.62	19.51	19.58	1	18.59	18.72	18.64	2
	100	0	19.9	19.66	19.65	1	18.85	18.7	18.61	2

**EIRP Power (dBm)**

CDMA							
Plane	Channel	Frequency (MHz)	LVL (dBm)	Correction Factor (dB)	EIRP (dBm)	EIRP (mW)	Polarization (H/V)
Y	25	1851.25	-28.02	36.57	8.55	7.16	H
	600	1880.00	-28.53	37.22	8.69	7.40	
	1175	1908.75	-28.71	37.18	8.47	7.03	
	25	1851.25	-19.32	37.65	18.33	68.09	V
	600	1880.00	-19.19	37.58	18.39	69.07	
	1175	1908.75	-19.13	37.48	18.35	68.39	

LTE Band 2							
Channel Bandwidth: 1.4 MHz / QPSK							
Plane	Channel	Frequency (MHz)	LVL (dBm)	Correction Factor (dB)	EIRP (dBm)	EIRP (mW)	Polarization (H/V)
X	18607	1850.7	-16.65	36.57	19.92	98.22	H
	18900	1880.0	-16.45	37.22	20.77	119.51	
	19193	1909.3	-16.31	37.18	20.87	122.24	
	18607	1850.7	-22.45	37.65	15.20	33.12	V
	18900	1880.0	-22.29	37.58	15.29	33.83	
	19193	1909.3	-22.21	37.48	15.27	33.65	
Channel Bandwidth: 1.4 MHz / 16QAM							
X	18607	1850.7	-17.05	36.57	19.52	89.58	H
	18900	1880.0	-17.75	37.22	19.47	88.59	
	19193	1909.3	-17.71	37.18	19.47	88.55	
	18607	1850.7	-22.78	37.65	14.87	30.70	V
	18900	1880.0	-22.69	37.58	14.89	30.85	
	19193	1909.3	-22.65	37.48	14.83	30.41	

LTE Band 2							
Channel Bandwidth: 3 MHz / QPSK							
Plane	Channel	Frequency (MHz)	LVL (dBm)	Correction Factor (dB)	EIRP (dBm)	EIRP (mW)	Polarization (H/V)
X	18615	1851.5	-16.61	36.57	19.96	99.13	H
	18900	1880.0	-16.42	37.22	20.80	120.34	
	19185	1908.5	-16.25	37.18	20.93	123.94	
	18615	1851.5	-22.41	37.65	15.24	33.43	V
	18900	1880.0	-22.25	37.58	15.33	34.14	
	19185	1908.5	-22.19	37.48	15.29	33.81	
Channel Bandwidth: 3 MHz / 16QAM							
X	18615	1851.5	-17.45	36.57	19.12	81.70	H
	18900	1880.0	-17.36	37.22	19.86	96.92	
	19185	1908.5	-17.32	37.18	19.86	96.87	
	18615	1851.5	-22.75	37.65	14.90	30.91	V
	18900	1880.0	-22.65	37.58	14.93	31.14	
	19185	1908.5	-22.61	37.48	14.87	30.69	

LTE Band 2							
Channel Bandwidth: 5 MHz / QPSK							
Plane	Channel	Frequency (MHz)	LVL (dBm)	Correction Factor (dB)	EIRP (dBm)	EIRP (mW)	Polarization (H/V)
X	18625	1852.5	-15.78	36.57	20.79	120.01	H
	18900	1880.0	-15.94	37.22	21.28	134.40	
	19175	1907.5	-15.89	37.18	21.29	134.65	
	18625	1852.5	-22.34	37.65	15.31	33.97	V
	18900	1880.0	-20.50	37.58	17.08	51.09	
	19175	1907.5	-22.15	37.48	15.33	34.12	
Channel Bandwidth: 5 MHz / 16QAM							
X	18625	1852.5	-17.17	36.57	19.40	87.14	H
	18900	1880.0	-17.21	37.22	20.01	100.32	
	19175	1907.5	-17.33	37.18	19.85	96.65	
	18625	1852.5	-22.35	37.65	15.30	33.89	V
	18900	1880.0	-22.28	37.58	15.30	33.91	
	19175	1907.5	-22.19	37.48	15.29	33.81	

LTE Band 2							
Channel Bandwidth: 10 MHz / QPSK							
Plane	Channel	Frequency (MHz)	LVL (dBm)	Correction Factor (dB)	EIRP (dBm)	EIRP (mW)	Polarization (H/V)
X	18650	1855.0	-15.89	36.57	20.68	117.00	H
	18900	1880.0	-15.88	37.22	21.34	136.27	
	19150	1905.0	-15.77	37.18	21.41	138.42	
	18650	1855.0	-22.22	37.65	15.43	34.92	V
	18900	1880.0	-22.10	37.58	15.48	35.34	
	19150	1905.0	-22.01	37.48	15.47	35.24	
Channel Bandwidth: 10 MHz / 16QAM							
X	18650	1855.0	-16.61	36.57	19.96	99.13	H
	18900	1880.0	-16.53	37.22	20.69	117.33	
	19150	1905.0	-17.01	37.18	20.17	104.04	
	18650	1855.0	-22.31	37.65	15.34	34.21	V
	18900	1880.0	-22.20	37.58	15.38	34.54	
	19150	1905.0	-22.15	37.48	15.33	34.12	

LTE Band 2							
Channel Bandwidth: 15 MHz / QPSK							
Plane	Channel	Frequency (MHz)	LVL (dBm)	Correction Factor (dB)	EIRP (dBm)	EIRP (mW)	Polarization (H/V)
X	18675	1857.5	-15.82	36.57	20.75	118.90	H
	18900	1880.0	-15.86	37.22	21.36	136.90	
	19125	1902.5	-15.63	37.18	21.55	142.96	
	18675	1857.5	-22.14	37.65	15.51	35.57	V
	18900	1880.0	-21.96	37.58	15.62	36.50	
	19125	1902.5	-21.87	37.48	15.61	36.39	
Channel Bandwidth: 15 MHz / 16QAM							
X	18675	1857.5	-16.44	36.57	20.13	103.09	H
	18900	1880.0	-16.57	37.22	20.65	116.25	
	19125	1902.5	-16.68	37.18	20.50	112.25	
	18675	1857.5	-22.02	37.65	15.63	36.57	V
	18900	1880.0	-21.91	37.58	15.67	36.92	
	19125	1902.5	-21.85	37.48	15.63	36.56	



LTE Band 2							
Channel Bandwidth: 20 MHz / QPSK							
Plane	Channel	Frequency (MHz)	LVL (dBm)	Correction Factor (dB)	EIRP (dBm)	EIRP (mW)	Polarization (H/V)
X	18700	1860.0	-15.15	36.57	21.42	138.74	H
	18900	1880.0	-15.45	37.22	21.77	150.45	
	19100	1900.0	-15.33	37.18	21.85	153.18	
	18700	1860.0	-21.98	37.65	15.67	36.91	V
	18900	1880.0	-21.88	37.58	15.70	37.18	
	19100	1900.0	-21.79	37.48	15.69	37.07	
Channel Bandwidth: 20 MHz / 16QAM							
X	18700	1860.0	-16.13	36.57	20.44	110.71	H
	18900	1880.0	-16.22	37.22	21.00	126.01	
	19100	1900.0	-16.35	37.18	20.83	121.12	
	18700	1860.0	-21.95	37.65	15.70	37.16	V
	18900	1880.0	-21.84	37.58	15.74	37.52	
	19100	1900.0	-21.79	37.48	15.69	37.07	

LTE Band 25							
Channel Bandwidth: 1.4 MHz / QPSK							
Plane	Channel	Frequency (MHz)	LVL (dBm)	Correction Factor (dB)	EIRP (dBm)	EIRP (mW)	Polarization (H/V)
X	26047	1850.7	-16.48	36.57	20.09	102.14	H
	26365	1882.5	-16.35	37.22	20.87	122.29	
	26683	1914.3	-17.66	39.09	21.43	139.00	
	26047	1850.7	-23.15	37.65	14.50	28.19	V
	26365	1882.5	-23.02	37.58	14.56	28.60	
	26683	1914.3	-23.35	37.92	14.57	28.64	
Channel Bandwidth: 1.4 MHz / 16QAM							
X	26047	1850.7	-17.56	36.57	19.01	79.65	H
	26365	1882.5	-17.74	37.22	19.48	88.80	
	26683	1914.3	-18.65	39.09	20.44	110.66	
	26047	1850.7	-22.85	37.65	14.80	30.21	V
	26365	1882.5	-22.78	37.58	14.80	30.22	
	26683	1914.3	-23.05	37.92	14.87	30.69	

LTE Band 25							
Channel Bandwidth: 3 MHz / QPSK							
Plane	Channel	Frequency (MHz)	LVL (dBm)	Correction Factor (dB)	EIRP (dBm)	EIRP (mW)	Polarization (H/V)
X	26055	1851.5	-16.35	36.57	20.22	105.24	H
	26365	1882.5	-16.21	37.22	21.01	126.30	
	26675	1913.5	-17.43	39.11	21.68	147.23	
	26055	1851.5	-23.07	37.65	14.58	28.71	V
	26365	1882.5	-22.95	37.58	14.63	29.06	
	26675	1913.5	-23.16	37.93	14.77	29.99	
Channel Bandwidth: 3 MHz / 16QAM							
X	26055	1851.5	-17.06	36.57	19.51	89.37	H
	26365	1882.5	-17.12	37.22	20.10	102.42	
	26675	1913.5	-18.45	39.11	20.66	116.41	
	26055	1851.5	-22.71	37.65	14.94	31.20	V
	26365	1882.5	-22.61	37.58	14.97	31.43	
	26675	1913.5	-22.89	37.93	15.04	31.92	

LTE Band 25							
Channel Bandwidth: 5 MHz / QPSK							
Plane	Channel	Frequency (MHz)	LVL (dBm)	Correction Factor (dB)	EIRP (dBm)	EIRP (mW)	Polarization (H/V)
X	26065	1852.5	-15.95	36.57	20.62	115.40	H
	26365	1882.5	-15.90	37.22	21.32	135.64	
	26665	1912.5	-16.51	39.11	22.60	181.97	
	26065	1852.5	-22.91	37.65	14.74	29.79	V
	26365	1882.5	-22.80	37.58	14.78	30.08	
	26665	1912.5	-23.11	37.96	14.85	30.55	
Channel Bandwidth: 5 MHz / 16QAM							
X	26065	1852.5	-16.98	36.57	19.59	91.03	H
	26365	1882.5	-17.05	37.22	20.17	104.09	
	26665	1912.5	-18.22	39.11	20.89	122.74	
	26065	1852.5	-22.63	37.65	15.02	31.78	V
	26365	1882.5	-22.52	37.58	15.06	32.08	
	26665	1912.5	-22.85	37.96	15.11	32.43	

LTE Band 25							
Channel Bandwidth: 10 MHz / QPSK							
Plane	Channel	Frequency (MHz)	LVL (dBm)	Correction Factor (dB)	EIRP (dBm)	EIRP (mW)	Polarization (H/V)
X	26090	1855.0	-15.81	36.57	20.76	119.18	H
	26365	1882.5	-15.85	37.22	21.37	137.21	
	26640	1910.0	-15.99	39.19	23.20	208.93	
	26090	1855.0	-22.78	37.65	14.87	30.70	V
	26365	1882.5	-22.65	37.58	14.93	31.14	
	26640	1910.0	-22.99	38.15	15.16	32.81	

Channel Bandwidth: 10 MHz / 16QAM							
X	26090	1855.0	-16.56	36.57	20.01	100.28	H
	26365	1882.5	-16.98	37.22	20.24	105.78	
	26640	1910.0	-18.11	39.19	21.08	128.23	
	26090	1855.0	-22.61	37.65	15.04	31.92	V
	26365	1882.5	-22.40	37.58	15.18	32.98	
	26640	1910.0	-22.89	38.15	15.26	33.57	

LTE Band 25							
Channel Bandwidth: 15 MHz / QPSK							
Plane	Channel	Frequency (MHz)	LVL (dBm)	Correction Factor (dB)	EIRP (dBm)	EIRP (mW)	Polarization (H/V)
X	26115	1857.5	-15.78	36.57	20.79	120.01	H
	26365	1882.5	-15.74	37.22	21.48	140.73	
	26615	1907.5	-15.99	39.23	23.24	210.86	
	26115	1857.5	-22.09	37.65	15.56	35.98	V
	26365	1882.5	-22.01	37.58	15.57	36.08	
	26615	1907.5	-22.35	38.22	15.87	38.64	

Channel Bandwidth: 15 MHz / 16QAM							
X	26115	1857.5	-16.45	36.57	20.12	102.85	H
	26365	1882.5	-16.77	37.22	20.45	111.02	
	26615	1907.5	-17.93	39.23	21.30	134.90	
	26115	1857.5	-22.12	37.65	15.53	35.74	V
	26365	1882.5	-21.99	37.58	15.59	36.25	
	26615	1907.5	-22.56	38.22	15.66	36.81	

LTE Band 25							
Channel Bandwidth: 20 MHz / QPSK							
Plane	Channel	Frequency (MHz)	LVL (dBm)	Correction Factor (dB)	EIRP (dBm)	EIRP (mW)	Polarization (H/V)
X	26140	1860.0	-15.56	36.57	21.01	126.24	H
	26365	1882.5	-15.15	37.22	22.07	161.21	
	26590	1905.0	-15.45	38.72	23.27	212.32	
	26140	1860.0	-21.94	37.65	15.71	37.25	V
	26365	1882.5	-21.86	37.58	15.72	37.35	
	26590	1905.0	-21.78	37.56	15.78	37.84	
Channel Bandwidth: 20 MHz / 16QAM							
X	26140	1860.0	-16.05	36.57	20.52	112.77	H
	26365	1882.5	-16.33	37.22	20.89	122.86	
	26590	1905.0	-17.10	38.72	21.62	145.21	
	26140	1860.0	-21.79	37.65	15.86	38.56	V
	26365	1882.5	-21.68	37.58	15.90	38.93	
	26590	1905.0	-21.56	37.56	16.00	39.81	

## 4.2 Frequency Stability Measurement

### 4.2.1 Limits of Frequency Stability Measurement

The frequency stability shall be sufficient to ensure that the fundamental emission stays within the authorized frequency block.

### 4.2.2 Test Procedure

- Device is placed at the oven room. The oven room could control the temperatures and humidity. Power warm up is at least 15 min and power applied should perform before recording frequency error.
- EUT is connected the external power supply to control the DC input power. The test voltage range is from minimum to maximum working voltage. Each step shall be record the frequency error rate.
- The temperature range step is 10 degrees in this test items. All temperature levels shall be hold the  $\pm 0.5$  °C during the measurement testing. The each temperature step shall be at least 0.5 hours, consider the EUT could be test under the stability condition.

**NOTE:** The frequency error was recorded frequency error from the communication simulator.

### 4.2.3 Test Setup

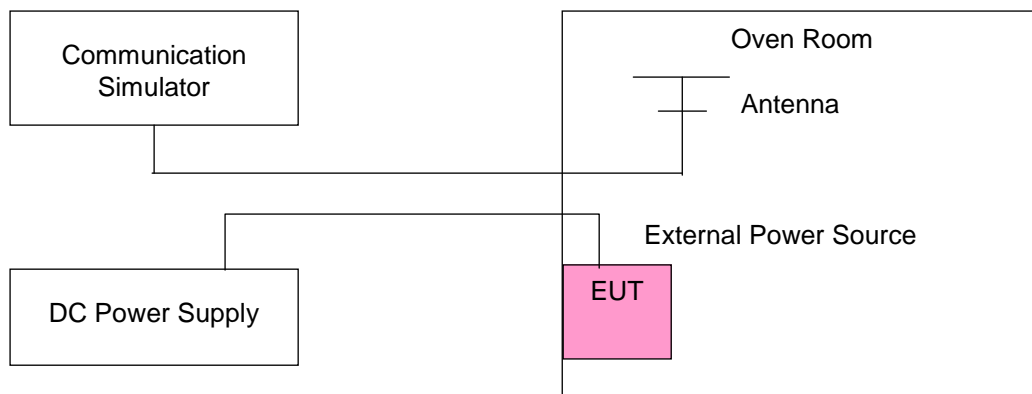

#### 4.2.4 Test Results

##### Frequency Error vs. Voltage

Voltage (Volts)	CDMA		Limit (ppm)
	Frequency (MHz)	Frequency Error (ppm)	
3.8	1880.000001	0.001	2.5
3.5	1880.000003	0.002	2.5
4.35	1880.000002	0.001	2.5

**Note:** The applicant defined the normal working voltage of the battery is from 3.5 Vdc to 4.35 Vdc.

##### Frequency Error vs. Temperature

Temp. (°C)	CDMA		Limit (ppm)
	Frequency (MHz)	Frequency Error (ppm)	
-30	1880.000001	0.001	2.5
-20	1880.000003	0.001	2.5
-10	1880.000002	0.001	2.5
0	1880.000004	0.002	2.5
10	1880.000003	0.001	2.5
20	1879.999997	-0.001	2.5
30	1879.999999	-0.001	2.5
40	1879.999997	-0.002	2.5
50	1879.999997	-0.002	2.5
55	1879.999998	-0.001	2.5

## Frequency Error vs. Voltage

Voltage (Volts)	LTE Band 2				Limit (ppm)
	1.4 MHz		3 MHz		
	Frequency (MHz)	Frequency Error (ppm)	Frequency (MHz)	Frequency Error (ppm)	
3.8	1880.000003	0.002	1880.000001	0.001	2.5
3.5	1880.000002	0.001	1880.000002	0.001	2.5
4.35	1880.000002	0.001	1880.000003	0.002	2.5

**Note:** The applicant defined the normal working voltage of the battery is from 3.5 Vdc to 4.35 Vdc.

## Frequency Error vs. Temperature

Temp. (°C)	LTE Band 2				Limit (ppm)
	1.4 MHz		3 MHz		
	Frequency (MHz)	Frequency Error (ppm)	Frequency (MHz)	Frequency Error (ppm)	
-30	1880.000002	0.001	1880.000001	0.001	2.5
-20	1880.000001	0.001	1880.000004	0.002	2.5
-10	1880.000001	0.001	1880.000004	0.002	2.5
0	1880.000004	0.002	1880.000002	0.001	2.5
10	1880.000004	0.002	1880.000002	0.001	2.5
20	1879.999997	-0.001	1879.999996	-0.002	2.5
30	1879.999999	-0.001	1879.999996	-0.002	2.5
40	1879.999998	-0.001	1879.999997	-0.002	2.5
50	1879.999998	-0.001	1879.999997	-0.002	2.5
55	1879.999997	-0.002	1879.999998	-0.001	2.5

Frequency Error vs. Voltage

Voltage (Volts)	LTE Band 2				Limit (ppm)
	5 MHz		10 MHz		
	Frequency (MHz)	Frequency Error (ppm)	Frequency (MHz)	Frequency Error (ppm)	
3.8	1880.000003	0.002	1880.000002	0.001	2.5
3.5	1880.000001	0.001	1880.000001	0.001	2.5
4.35	1880.000001	0.001	1880.000002	0.001	2.5

**Note:** The applicant defined the normal working voltage of the battery is from 3.5 Vdc to 4.35 Vdc.

Frequency Error vs. Temperature

Temp. (°C)	LTE Band 2				Limit (ppm)
	5 MHz		10 MHz		
	Frequency (MHz)	Frequency Error (ppm)	Frequency (MHz)	Frequency Error (ppm)	
-30	1880.000002	0.001	1880.000003	0.002	2.5
-20	1880.000003	0.002	1880.000004	0.002	2.5
-10	1880.000001	0.001	1880.000002	0.001	2.5
0	1880.000003	0.002	1880.000004	0.002	2.5
10	1880.000001	0.001	1880.000004	0.002	2.5
20	1879.999998	-0.001	1879.999998	-0.001	2.5
30	1879.999999	-0.001	1879.999997	-0.001	2.5
40	1879.999997	-0.002	1879.999996	-0.002	2.5
50	1879.999997	-0.002	1879.999999	-0.001	2.5
55	1879.999998	-0.001	1879.999999	-0.001	2.5



## Frequency Error vs. Voltage

Voltage (Volts)	LTE Band 2				Limit (ppm)
	15 MHz		20 MHz		
	Frequency (MHz)	Frequency Error (ppm)	Frequency (MHz)	Frequency Error (ppm)	
3.8	1880.000004	0.002	1880.000001	0.001	2.5
3.5	1880.000002	0.001	1880.000003	0.002	2.5
4.35	1880.000004	0.002	1880.000003	0.002	2.5

**Note:** The applicant defined the normal working voltage of the battery is from 3.5 Vdc to 4.35 Vdc.

## Frequency Error vs. Temperature

Temp. (°C)	LTE Band 2				Limit (ppm)
	15 MHz		20 MHz		
	Frequency (MHz)	Frequency Error (ppm)	Frequency (MHz)	Frequency Error (ppm)	
-30	1880.000003	0.002	1880.000002	0.001	2.5
-20	1880.000001	0.001	1880.000001	0.001	2.5
-10	1880.000004	0.002	1880.000004	0.002	2.5
0	1880.000002	0.001	1880.000004	0.002	2.5
10	1880.000002	0.001	1880.000003	0.002	2.5
20	1879.999997	-0.002	1879.999998	-0.001	2.5
30	1879.999997	-0.002	1879.999998	-0.001	2.5
40	1879.999999	-0.001	1879.999997	-0.002	2.5
50	1879.999998	-0.001	1879.999996	-0.002	2.5
55	1879.999998	-0.001	1879.999999	-0.001	2.5

## Frequency Error vs. Voltage

Voltage (Volts)	LTE Band 25				Limit (ppm)
	1.4 MHz		3 MHz		
	Frequency (MHz)	Frequency Error (ppm)	Frequency (MHz)	Frequency Error (ppm)	
3.8	1882.500001	0.001	1882.500003	0.001	2.5
3.5	1882.500001	0.001	1882.500004	0.002	2.5
4.35	1882.500003	0.001	1882.500003	0.001	2.5

**Note:** The applicant defined the normal working voltage of the battery is from 3.5 Vdc to 4.35 Vdc.

## Frequency Error vs. Temperature

Temp. (°C)	LTE Band 25				Limit (ppm)
	1.4 MHz		3 MHz		
	Frequency (MHz)	Frequency Error (ppm)	Frequency (MHz)	Frequency Error (ppm)	
-30	1882.500001	0.001	1882.500003	0.001	2.5
-20	1882.500003	0.001	1882.500004	0.002	2.5
-10	1882.500002	0.001	1882.500003	0.001	2.5
0	1882.500004	0.002	1882.500004	0.002	2.5
10	1882.500001	0.001	1882.500003	0.002	2.5
20	1882.499998	-0.001	1882.499998	-0.001	2.5
30	1882.499998	-0.001	1882.499997	-0.002	2.5
40	1882.499997	-0.002	1882.499997	-0.002	2.5
50	1882.499998	-0.001	1882.499998	-0.001	2.5
55	1882.499999	-0.001	1882.499998	-0.001	2.5

Frequency Error vs. Voltage

Voltage (Volts)	LTE Band 25				Limit (ppm)
	5 MHz		10 MHz		
	Frequency (MHz)	Frequency Error (ppm)	Frequency (MHz)	Frequency Error (ppm)	
3.8	1882.500003	0.002	1882.500004	0.002	2.5
3.5	1882.500004	0.002	1882.500002	0.001	2.5
4.35	1882.500002	0.001	1882.500003	0.002	2.5

**Note:** The applicant defined the normal working voltage of the battery is from 3.5 Vdc to 4.35 Vdc.

Frequency Error vs. Temperature

Temp. (°C)	LTE Band 25				Limit (ppm)
	5 MHz		10 MHz		
	Frequency (MHz)	Frequency Error (ppm)	Frequency (MHz)	Frequency Error (ppm)	
-30	1882.500002	0.001	1882.500004	0.002	2.5
-20	1882.500002	0.001	1882.500002	0.001	2.5
-10	1882.500002	0.001	1882.500001	0.001	2.5
0	1882.500002	0.001	1882.500001	0.001	2.5
10	1882.500003	0.002	1882.500004	0.002	2.5
20	1882.499998	-0.001	1882.499997	-0.002	2.5
30	1882.499996	-0.002	1882.499997	-0.002	2.5
40	1882.499997	-0.002	1882.499997	-0.002	2.5
50	1882.499999	-0.001	1882.499998	-0.001	2.5
55	1882.499998	-0.001	1882.499997	-0.002	2.5

Frequency Error vs. Voltage

Voltage (Volts)	LTE Band 25				Limit (ppm)
	15 MHz		20 MHz		
	Frequency (MHz)	Frequency Error (ppm)	Frequency (MHz)	Frequency Error (ppm)	
3.8	1882.500003	0.002	1882.500003	0.002	2.5
3.5	1882.500002	0.001	1882.500001	0.001	2.5
4.35	1882.500004	0.002	1882.500002	0.001	2.5

**Note:** The applicant defined the normal working voltage of the battery is from 3.5 Vdc to 4.35 Vdc.

Frequency Error vs. Temperature

Temp. (°C)	LTE Band 25				Limit (ppm)
	15 MHz		20 MHz		
	Frequency (MHz)	Frequency Error (ppm)	Frequency (MHz)	Frequency Error (ppm)	
-30	1882.500002	0.001	1882.500003	0.001	2.5
-20	1882.500003	0.001	1882.500003	0.001	2.5
-10	1882.500002	0.001	1882.500004	0.002	2.5
0	1882.500003	0.001	1882.500001	0.001	2.5
10	1882.500001	0.001	1882.500003	0.002	2.5
20	1882.499998	-0.001	1882.499999	-0.001	2.5
30	1882.499997	-0.002	1882.499996	-0.002	2.5
40	1882.499999	-0.001	1882.499997	-0.002	2.5
50	1882.499996	-0.002	1882.499998	-0.001	2.5
55	1882.499996	-0.002	1882.499998	-0.001	2.5

### 4.3 Occupied Bandwidth Measurement

#### 4.3.1 Test Procedure

The EUT makes a call to the communication simulator. All measurements were done at low, middle and high operational frequency range. The communication simulator station system controlled a EUT to export maximum output power under transmission mode and specific channel frequency. Use OBW measurement function of Spectrum analyzer to measure 99 % occupied bandwidth.

#### 4.3.2 Test Setup

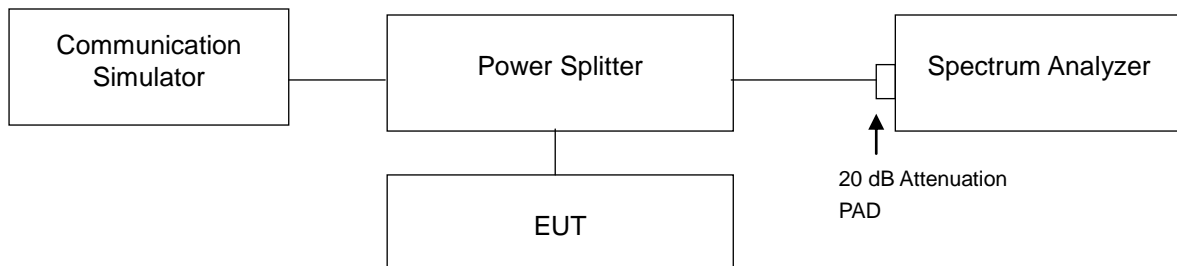

### 4.3.3 Test Result

Channel	Frequency (MHz)	99 % Occupied Bandwidth (kHz)
		CDMA
25	1851.25	1.2760
600	1880.00	1.2719
1175	1908.75	1.2737

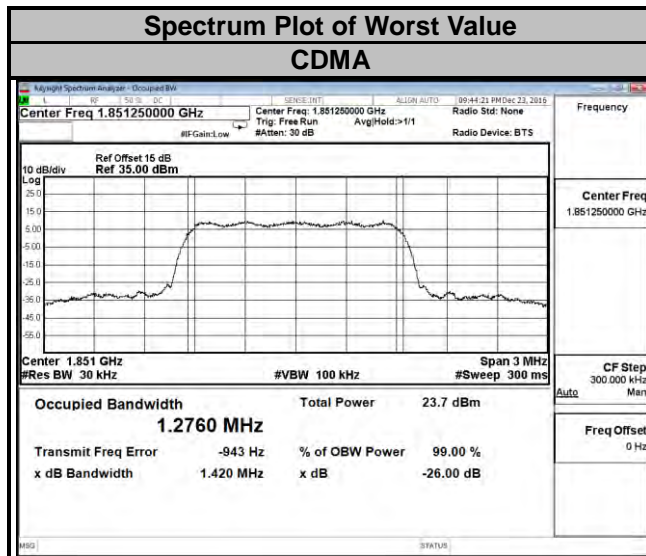

### LTE Band 2

Channel Bandwidth: 1.4 MHz				Channel Bandwidth: 3 MHz			
Channel	Frequency (MHz)	99 % Occupied Bandwidth (MHz)		Channel	Frequency (MHz)	99 % Occupied Bandwidth (MHz)	
		QPSK	16QAM			QPSK	16QAM
18607	1850.7	1.0874	1.0894	18615	1851.5	2.6998	2.6979
18900	1880.0	1.0879	1.0884	18900	1880.0	2.7022	2.6987
19193	1909.3	1.0887	1.0917	19185	1908.5	2.7021	2.6970

### Spectrum Plot of Worst Value

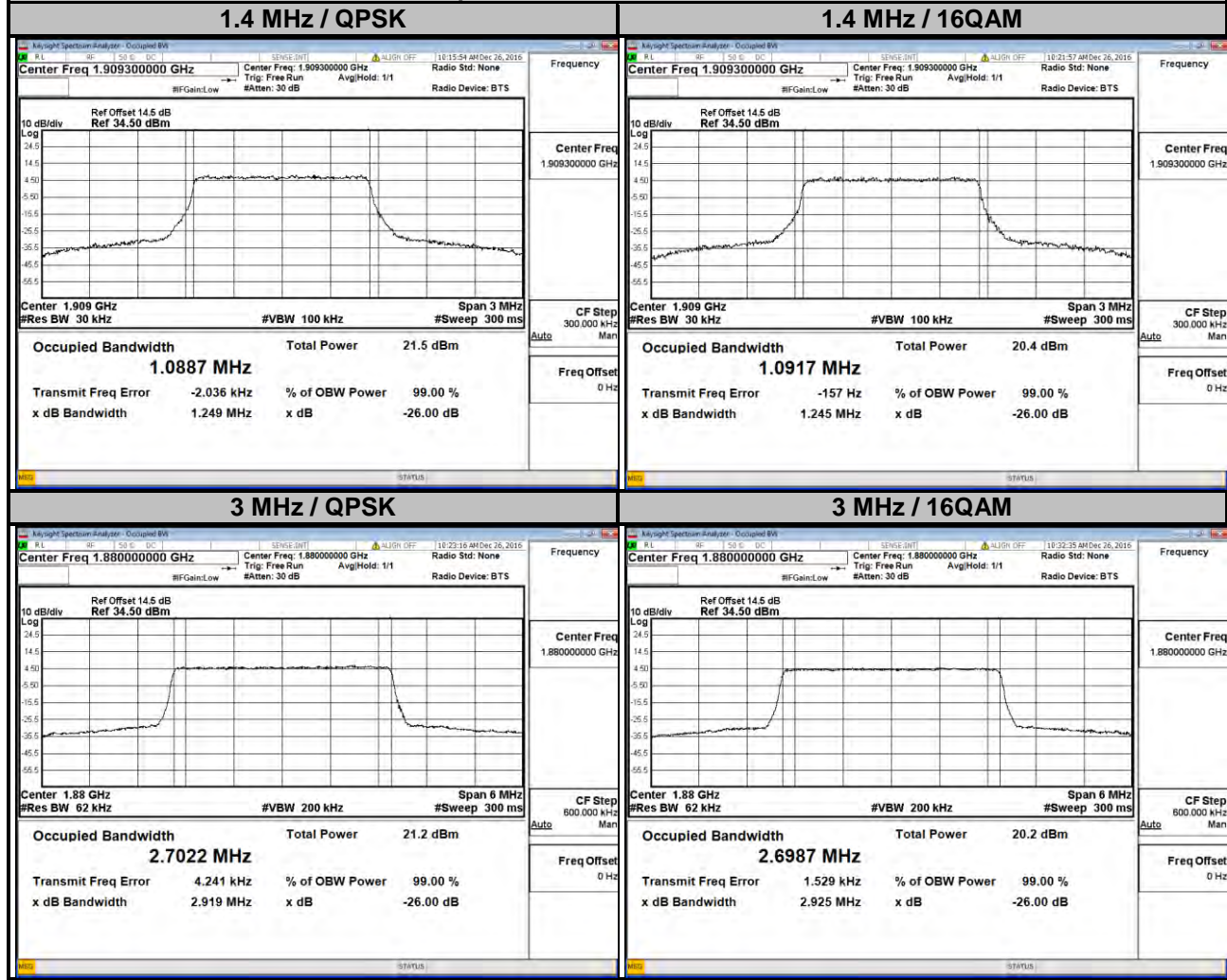

### LTE Band 2

Channel Bandwidth: 5 MHz				Channel Bandwidth: 10 MHz			
Channel	Frequency (MHz)	99 % Occupied Bandwidth (MHz)		Channel	Frequency (MHz)	99 % Occupied Bandwidth (MHz)	
		QPSK	16QAM			QPSK	16QAM
18625	1852.5	4.4906	4.4898	18650	1855.0	8.9456	8.9483
18900	1880.0	4.4928	4.4954	18900	1880.0	8.9625	8.9642
19175	1907.5	4.4945	4.4961	19150	1905.0	8.9777	8.9763

### Spectrum Plot of Worst Value

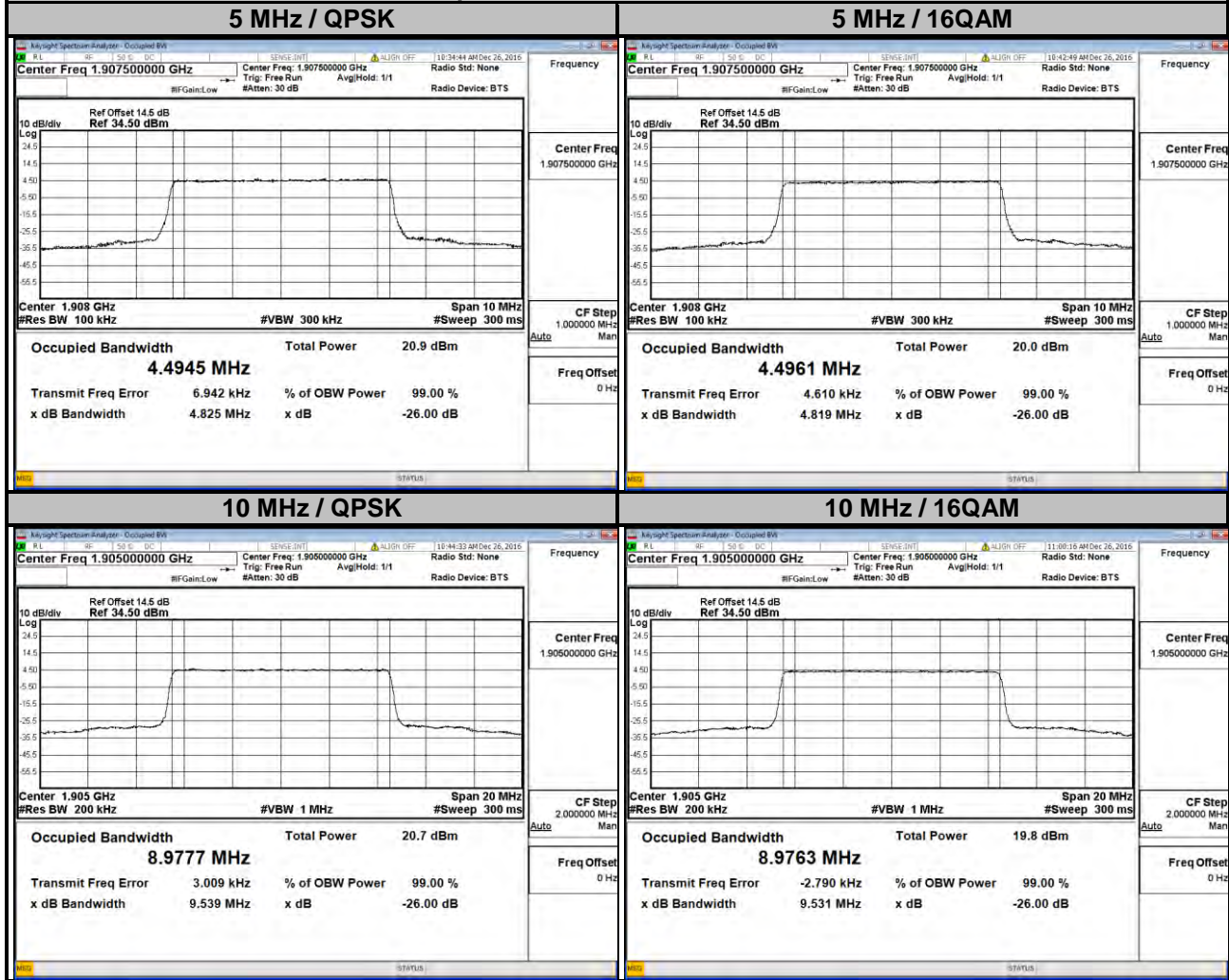



### LTE Band 2

Channel Bandwidth: 15 MHz				Channel Bandwidth: 20 MHz			
Channel	Frequency (MHz)	99 % Occupied Bandwidth (MHz)		Channel	Frequency (MHz)	99 % Occupied Bandwidth (MHz)	
		QPSK	16QAM			QPSK	16QAM
18675	1857.5	13.422	13.413	18700	1860.0	17.881	17.906
18900	1880.0	13.455	13.441	18900	1880.0	17.923	17.942
19125	1902.5	13.484	13.470	19100	1900.0	17.921	17.940

### Spectrum Plot of Worst Value



### LTE Band 25

Channel Bandwidth: 1.4 MHz				Channel Bandwidth: 3 MHz			
Channel	Frequency (MHz)	99 % Occupied Bandwidth (MHz)		Channel	Frequency (MHz)	99 % Occupied Bandwidth (MHz)	
		QPSK	16QAM			QPSK	16QAM
26047	1850.7	1.0875	1.0900	26055	1851.5	2.6999	2.6987
26365	1882.5	1.0882	1.0879	26365	1882.5	2.7022	2.6984
26683	1914.3	1.0881	1.0888	26675	1913.5	2.6978	2.6946

### Spectrum Plot of Worst Value

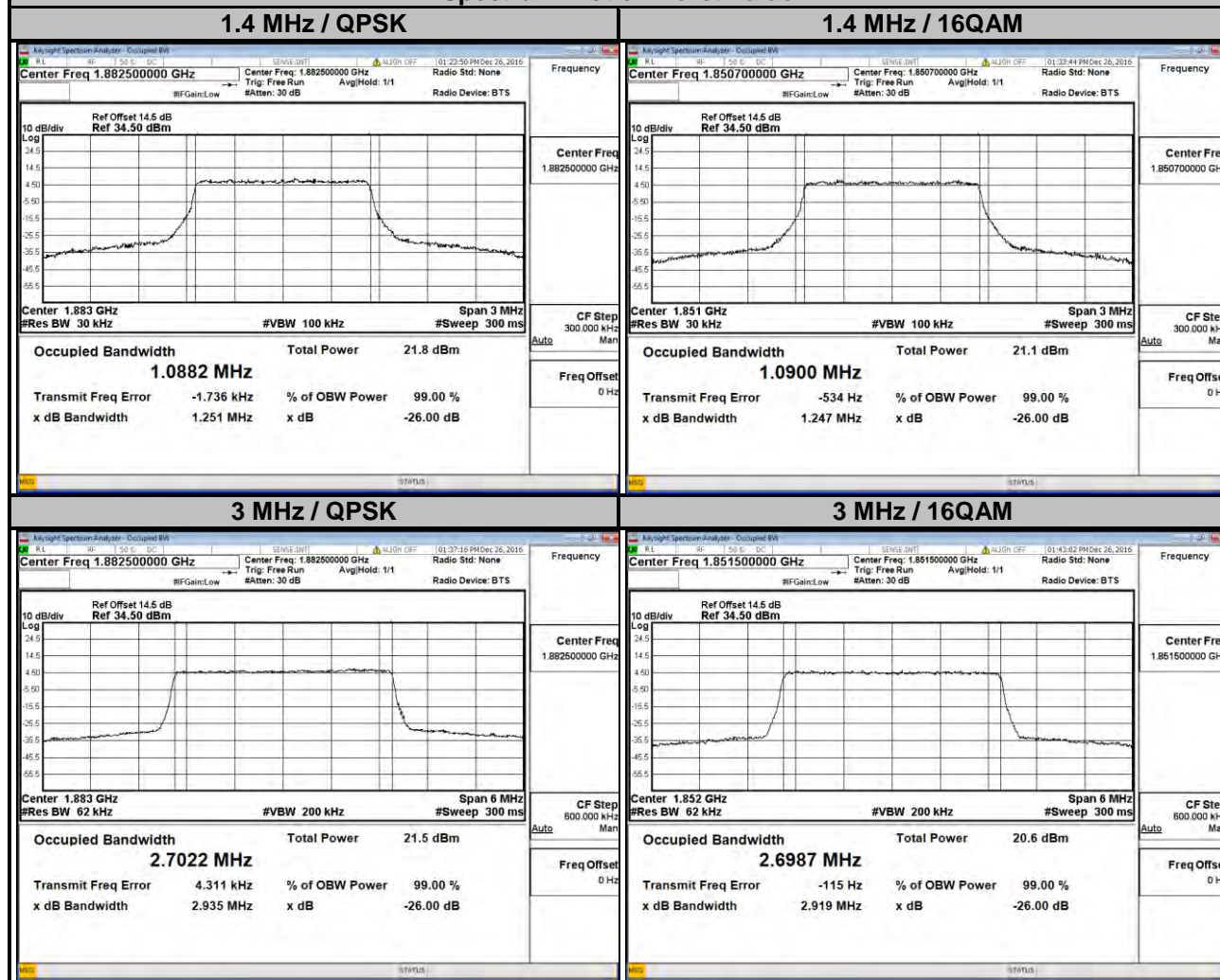

### LTE Band 25

Channel Bandwidth: 5 MHz				Channel Bandwidth: 10 MHz			
Channel	Frequency (MHz)	99 % Occupied Bandwidth (MHz)		Channel	Frequency (MHz)	99 % Occupied Bandwidth (MHz)	
		QPSK	16QAM			QPSK	16QAM
26065	1852.5	4.4899	4.4929	26090	1855.0	8.9463	8.9438
26365	1882.5	4.4938	4.4948	26365	1882.5	8.9581	8.9593
26665	1912.5	4.4824	4.4830	26640	1910.0	8.9393	8.9467

### Spectrum Plot of Worst Value

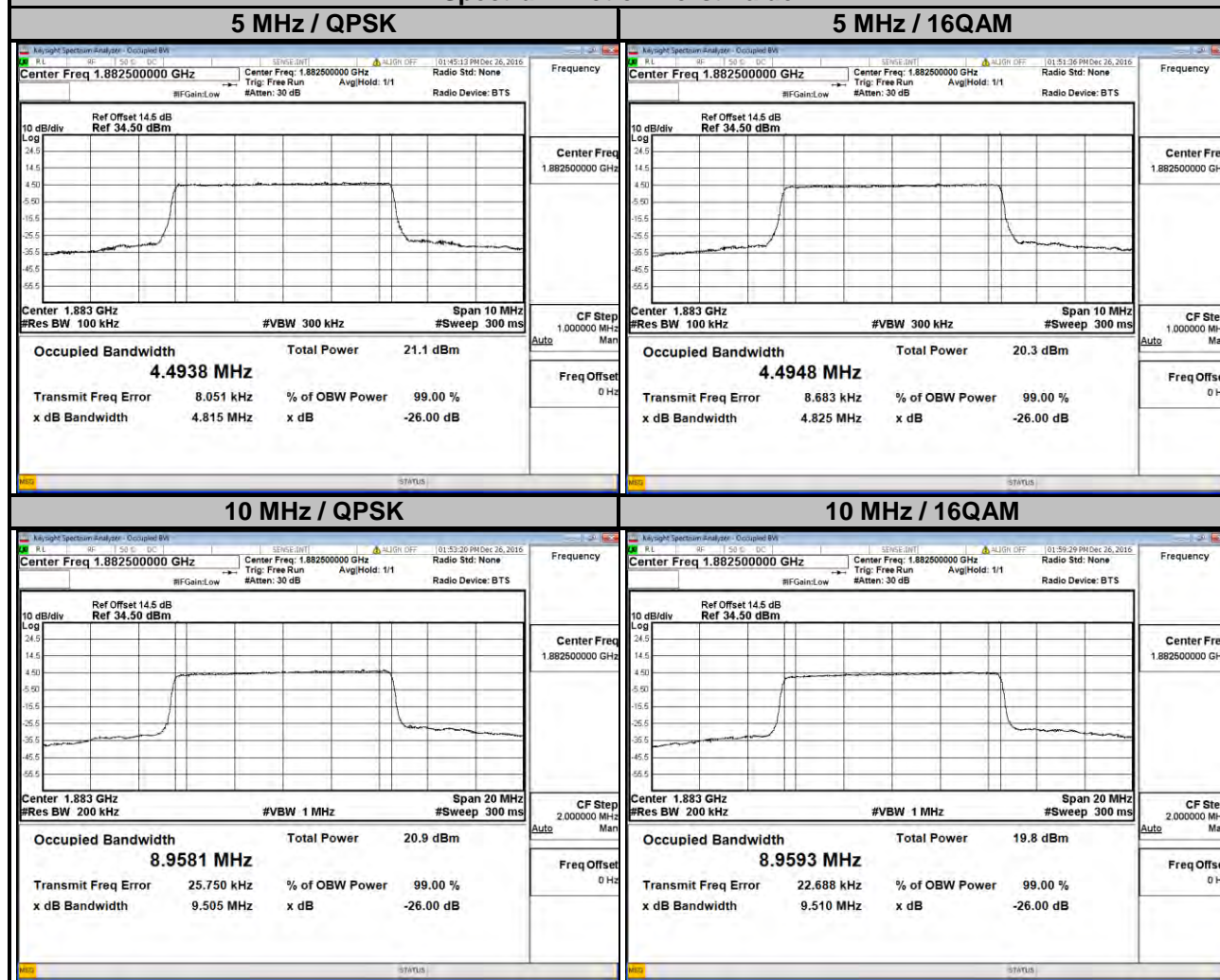

### LTE BAND 25

#### Channel Bandwidth: 15 MHz

#### Channel Bandwidth: 20 MHz

Channel	Frequency (MHz)	99 % Occupied Bandwidth (MHz)		Channel	Frequency (MHz)	99 % Occupied Bandwidth (MHz)	
		QPSK	16QAM			QPSK	16QAM
26115	1857.5	13.420	13.409	26140	1860.0	17.882	17.899
26365	1882.5	13.437	13.422	26365	1882.5	17.889	17.914
26615	1907.5	13.466	13.454	26590	1905.0	17.985	18.006

### Spectrum Plot of Worst Value

#### 15 MHz / QPSK

#### 15 MHz / 16QAM

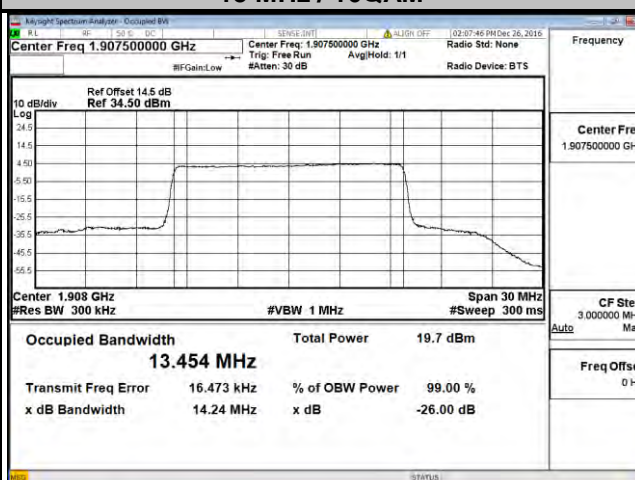
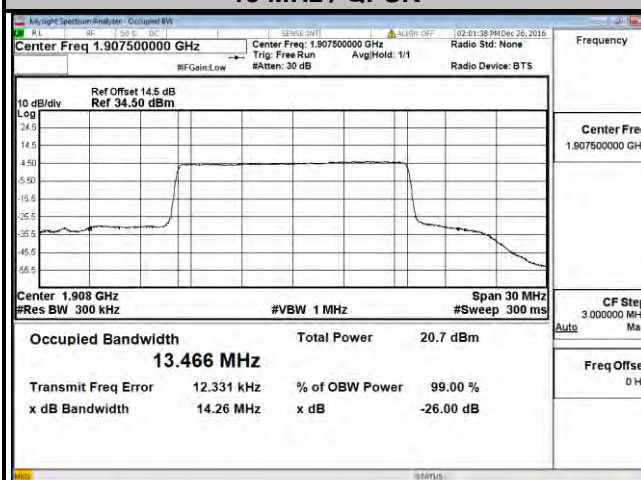

#### 20 MHz / QPSK

#### 20 MHz / 16QAM

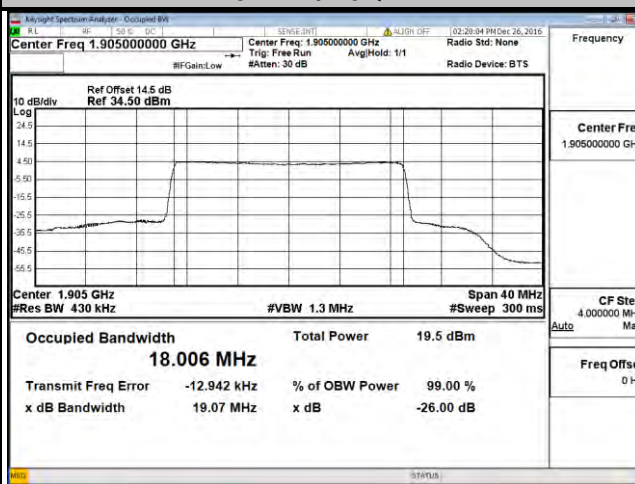
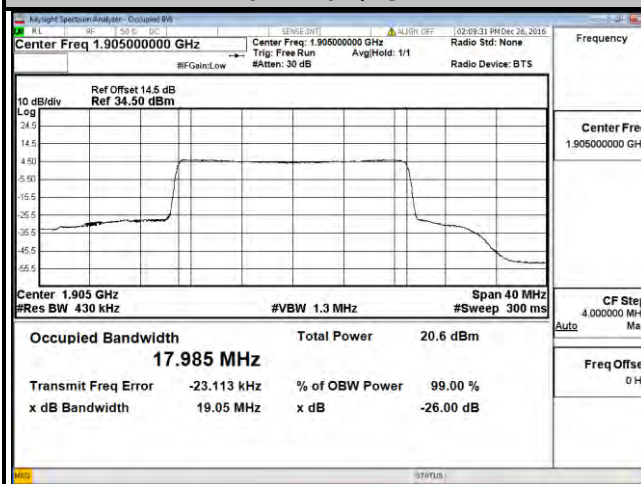

## 4.4 Band Edge Measurement

### 4.4.1 Limits of Band Edge Measurement

Power of any emission outside of the authorized operating frequency ranges must be attenuated below the transmitting power (P) by a factor of at least  $43 + 10 \log(P)$  dB. In the 1 MHz bands immediately outside and adjacent to the frequency block a resolution bandwidth of at least one percent of the emission bandwidth of the fundamental emission of the transmitter may be employed.

### 4.4.2 Test Setup

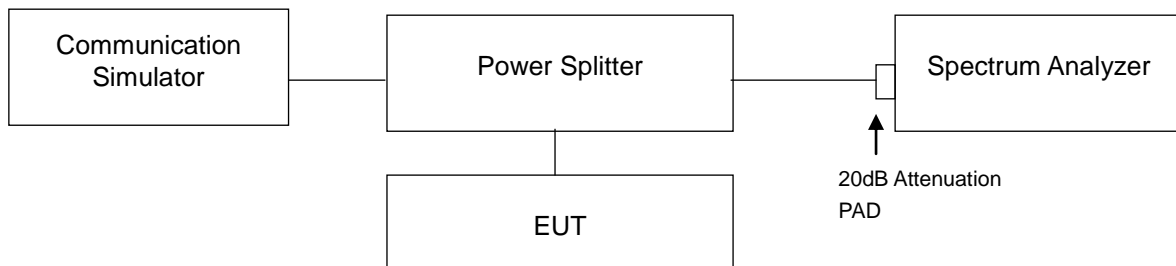

### 4.4.3 Test Procedures

- All measurements were done at low and high operational frequency range.
- The center frequency of spectrum is the band edge frequency and span is 1 MHz. RB of the spectrum is 13 kHz and VB of the spectrum is 51 kHz (CDMA / LTE Bandwidth 1.4 MHz).
- The center frequency of spectrum is the band edge frequency and span is 1 MHz. RB of the spectrum is 30 kHz and VB of the spectrum is 100 kHz (LTE Bandwidth 3 MHz).
- The center frequency of spectrum is the band edge frequency and span is 1 MHz. RB of the spectrum is 100 kHz and VB of the spectrum is 300 kHz (LTE Bandwidth 5 MHz/10 MHz).
- The center frequency of spectrum is the band edge frequency and span is 1 MHz. RB of the spectrum is 150 kHz and VB of the spectrum is 470 kHz (LTE Bandwidth 15 MHz).
- The center frequency of spectrum is the band edge frequency and span is 1 MHz. RB of the spectrum is 180 kHz and VB of the spectrum is 560 kHz (LTE Bandwidth 20 MHz).
- Record the max trace plot into the test report.

### 4.4.4 Test Results

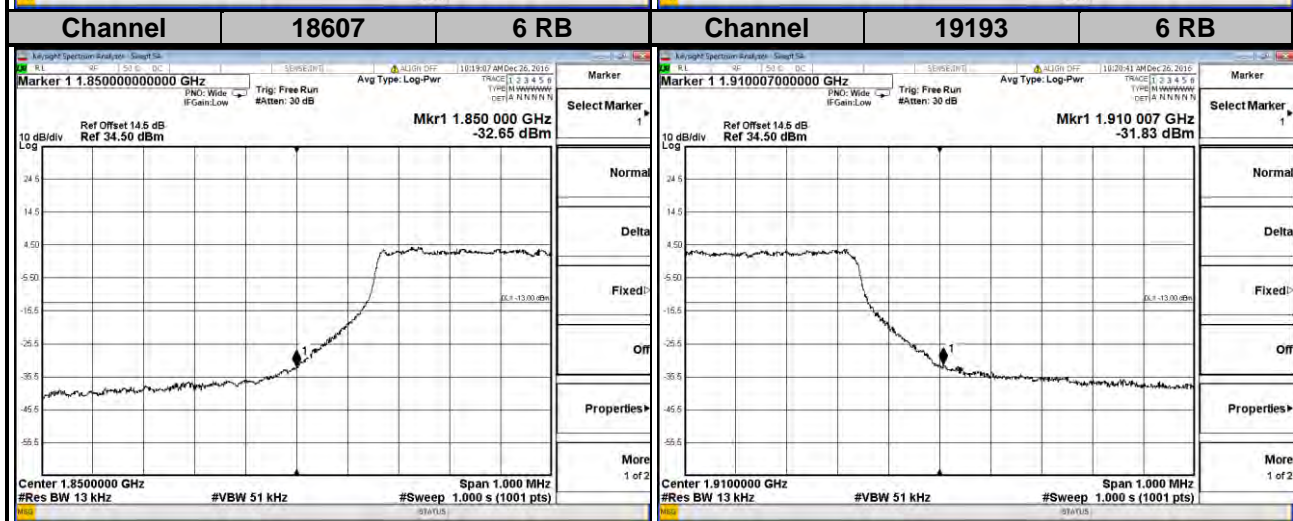
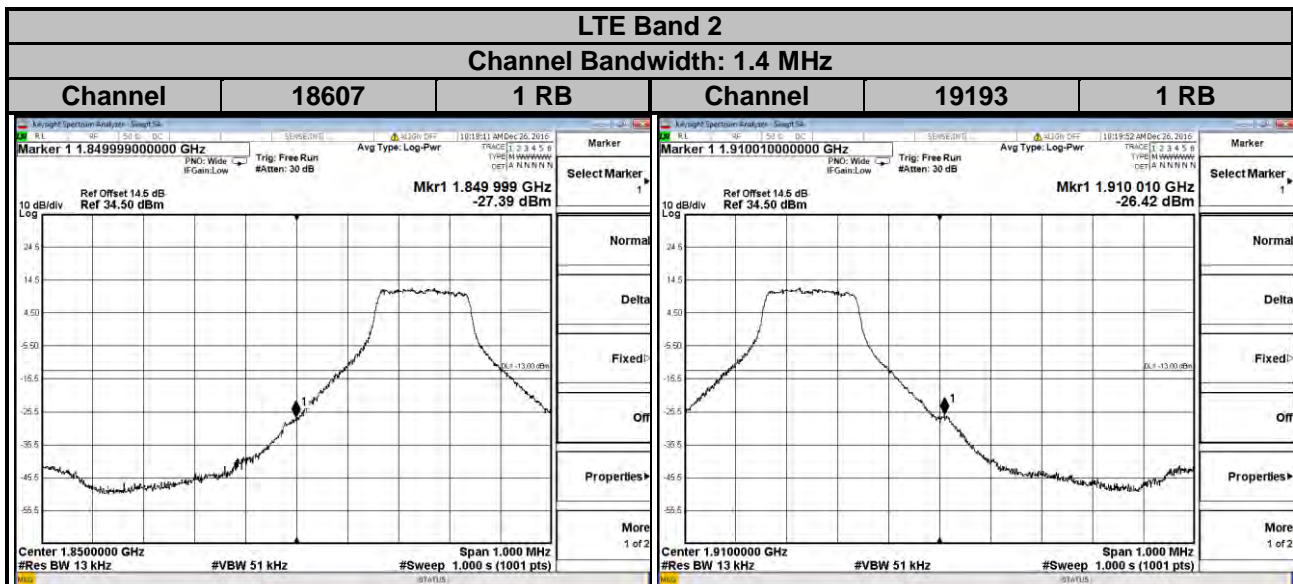
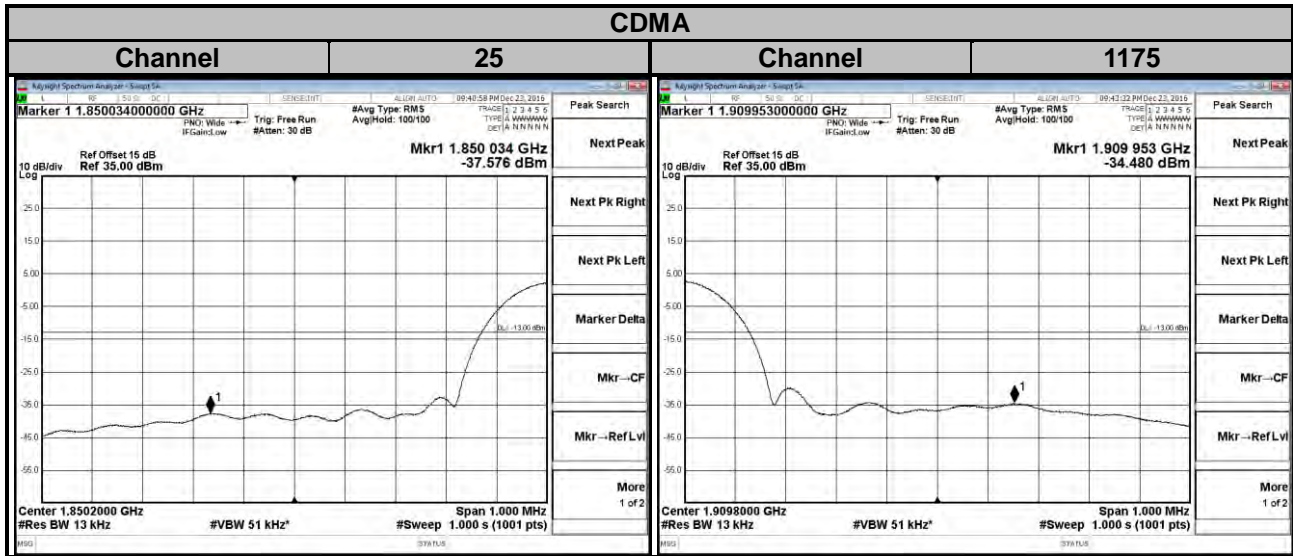

**LTE Band 2**  
**Channel Bandwidth: 3 MHz**

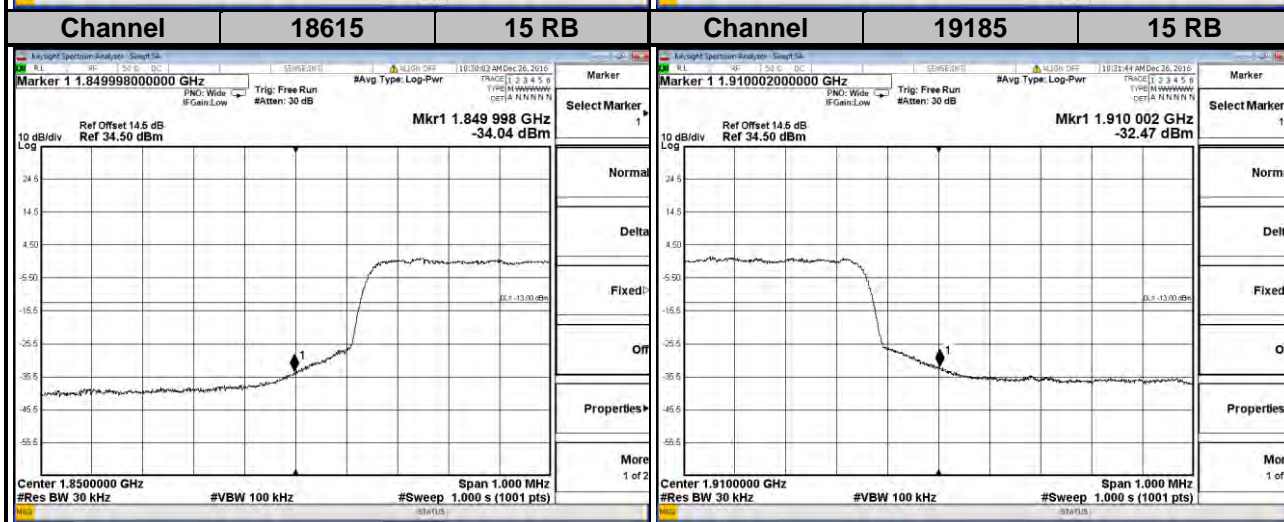
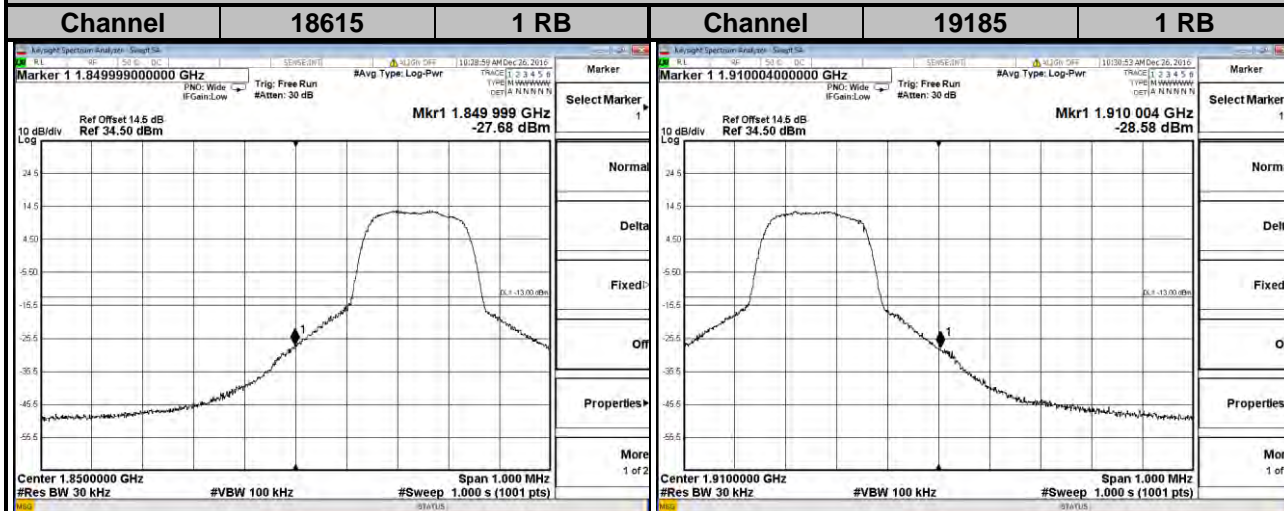

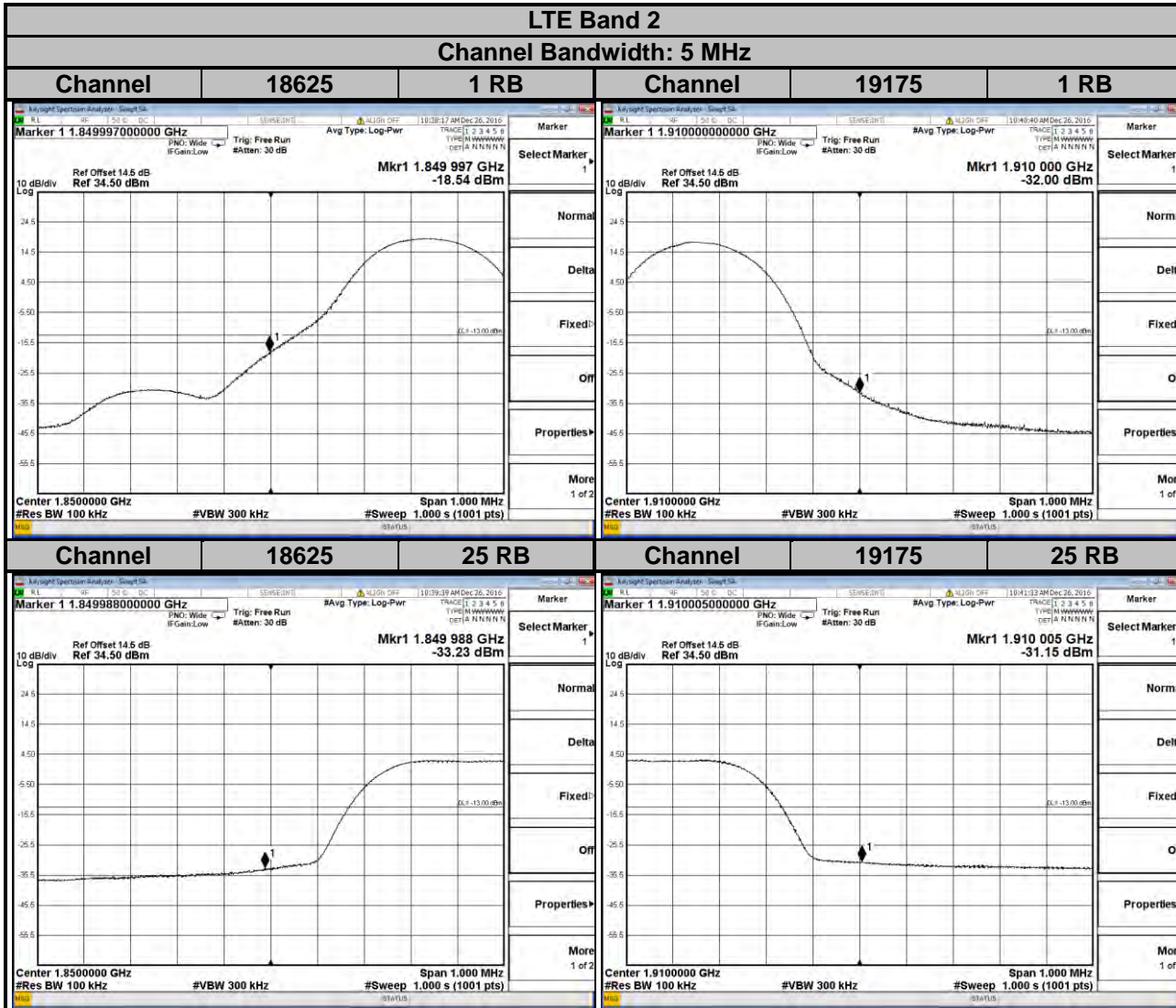



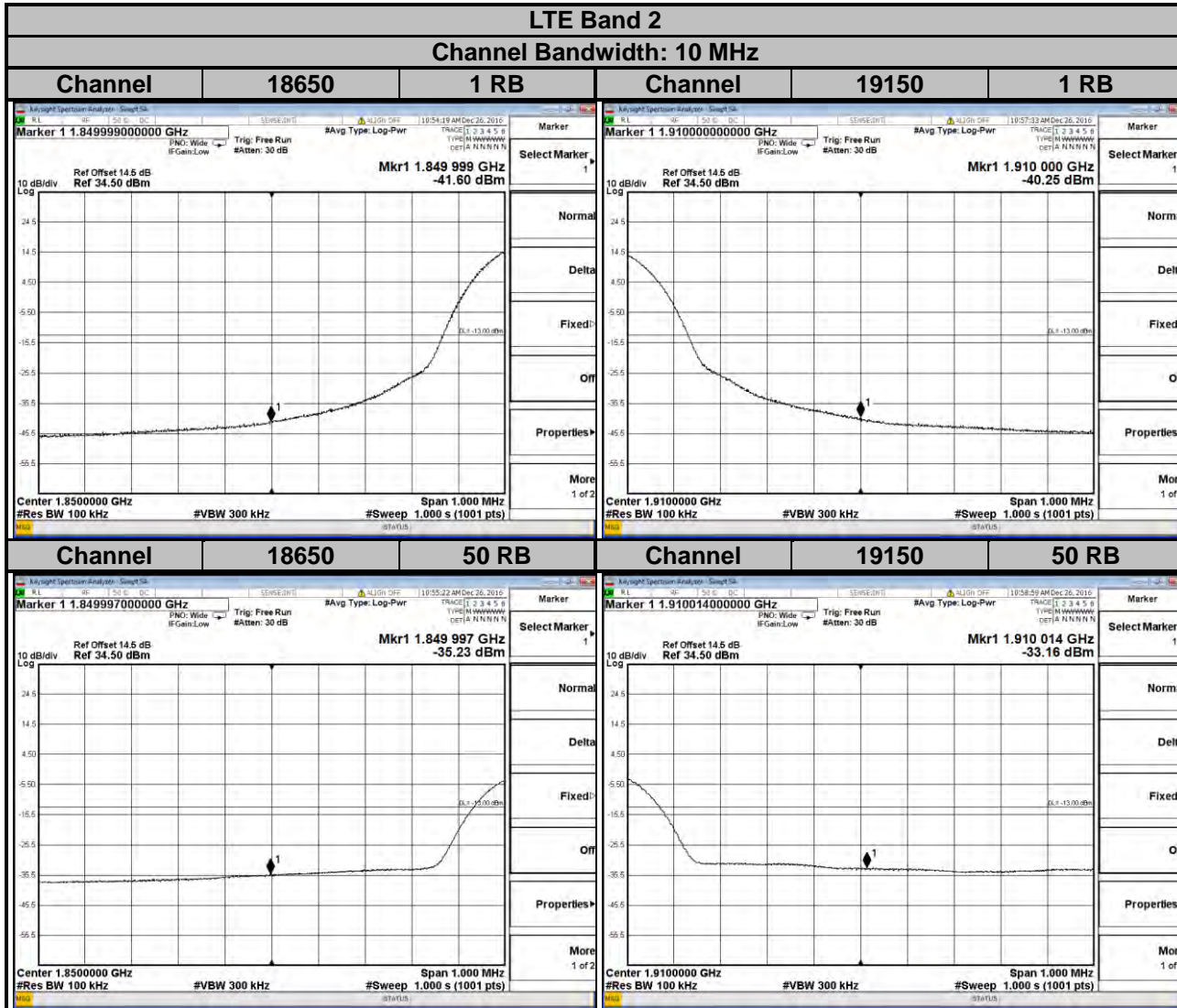

**LTE Band 2**  
**Channel Bandwidth: 15 MHz**

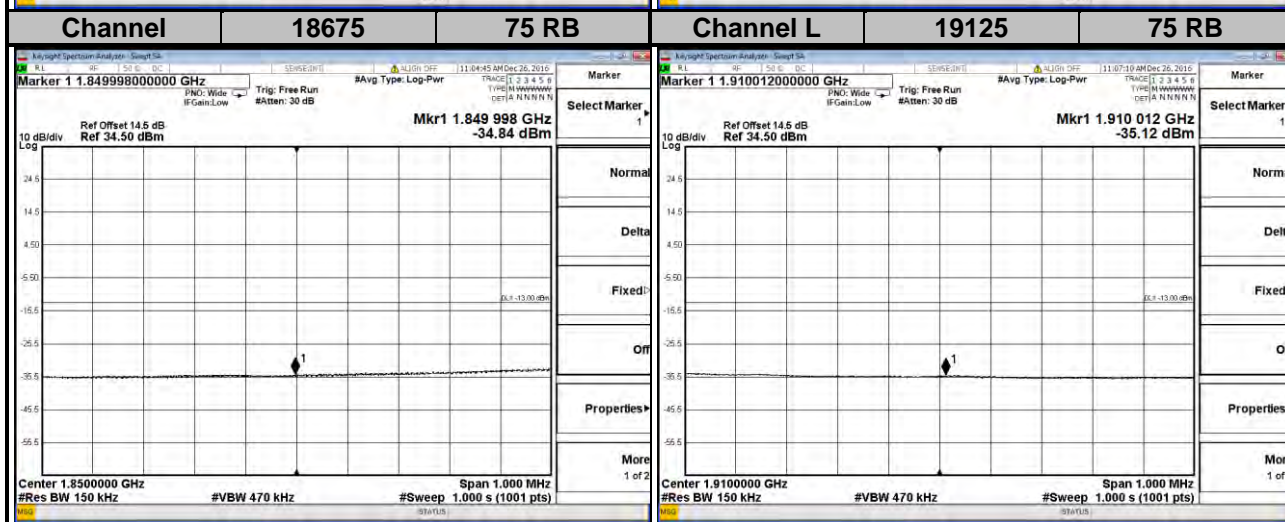
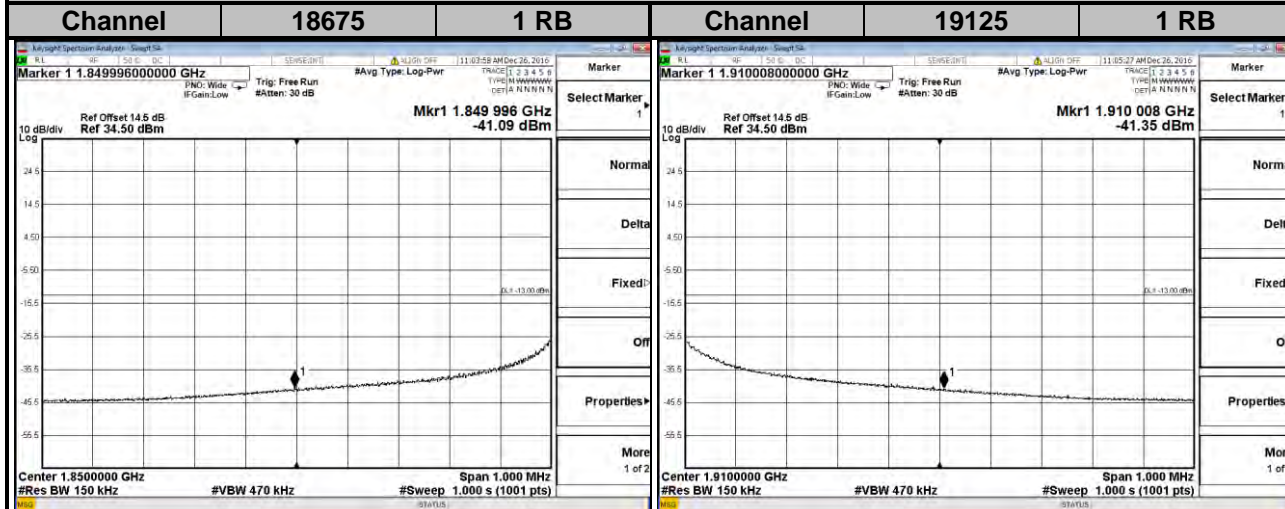

### LTE Band 2

Channel Bandwidth: 20 MHz

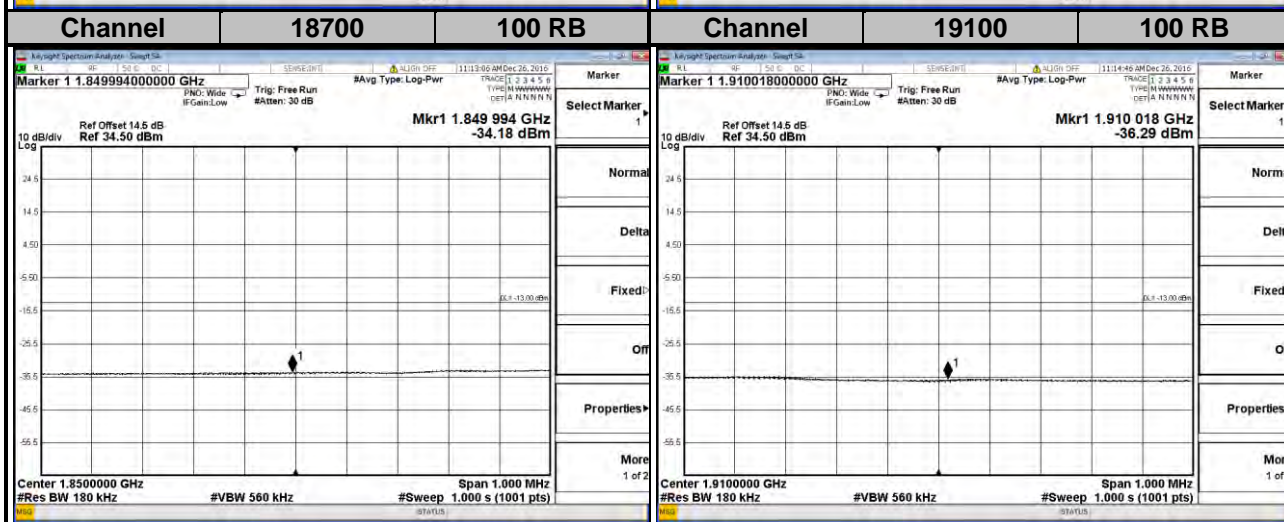
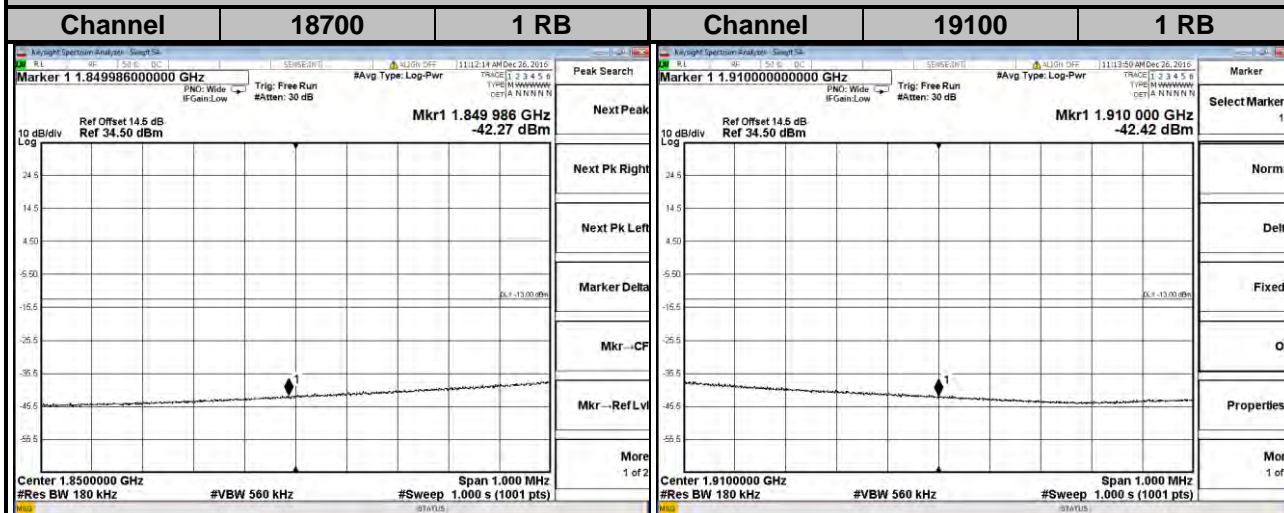

**LTE Band 25**  
**Channel Bandwidth: 1.4 MHz**

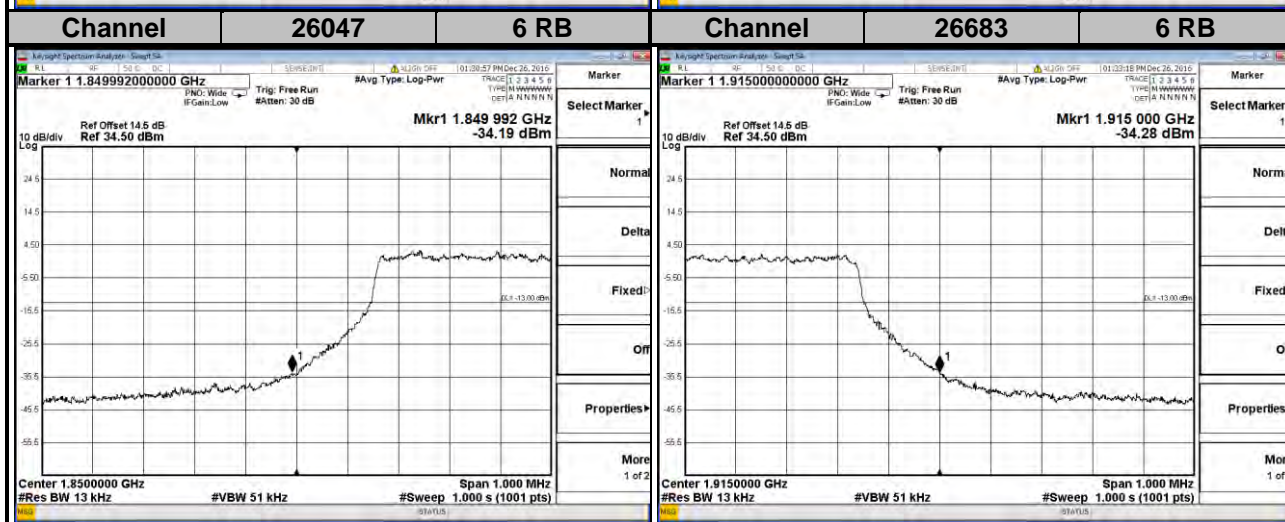
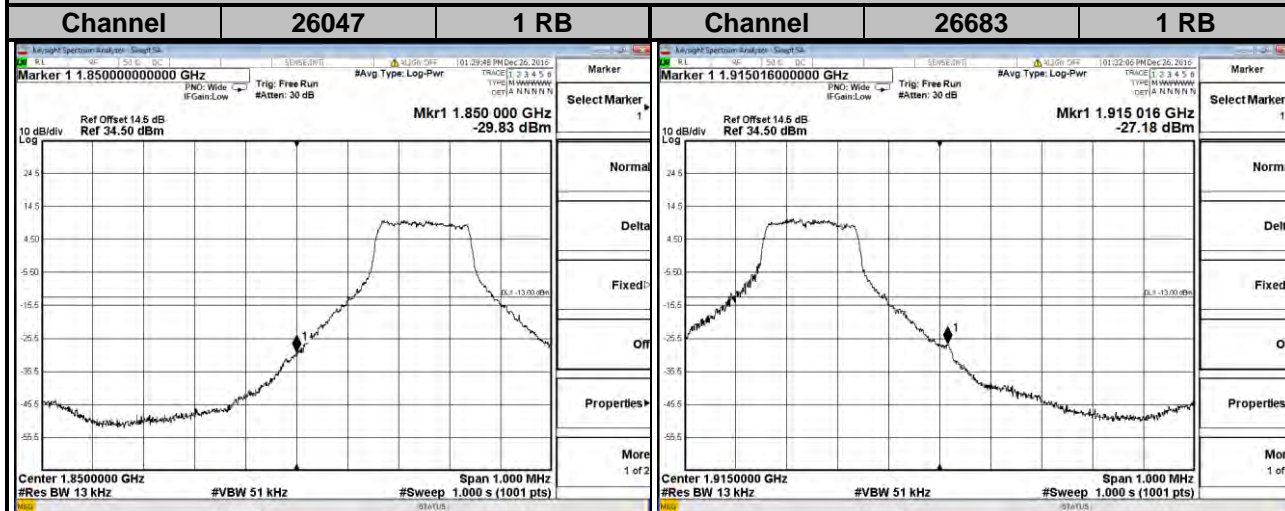

**LTE Band 25**  
**Channel Bandwidth: 3 MHz**

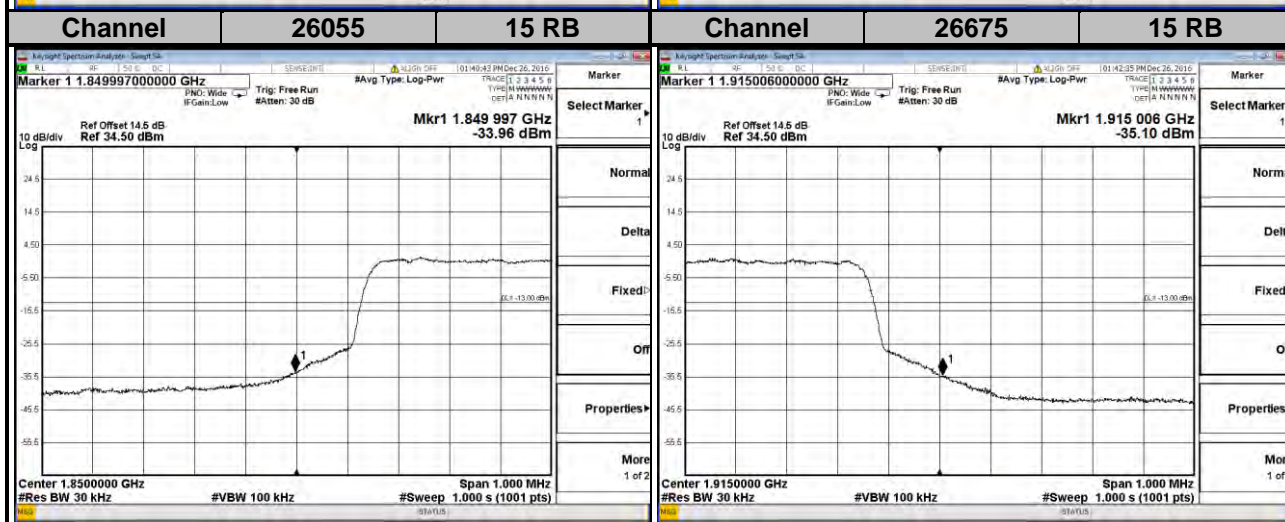
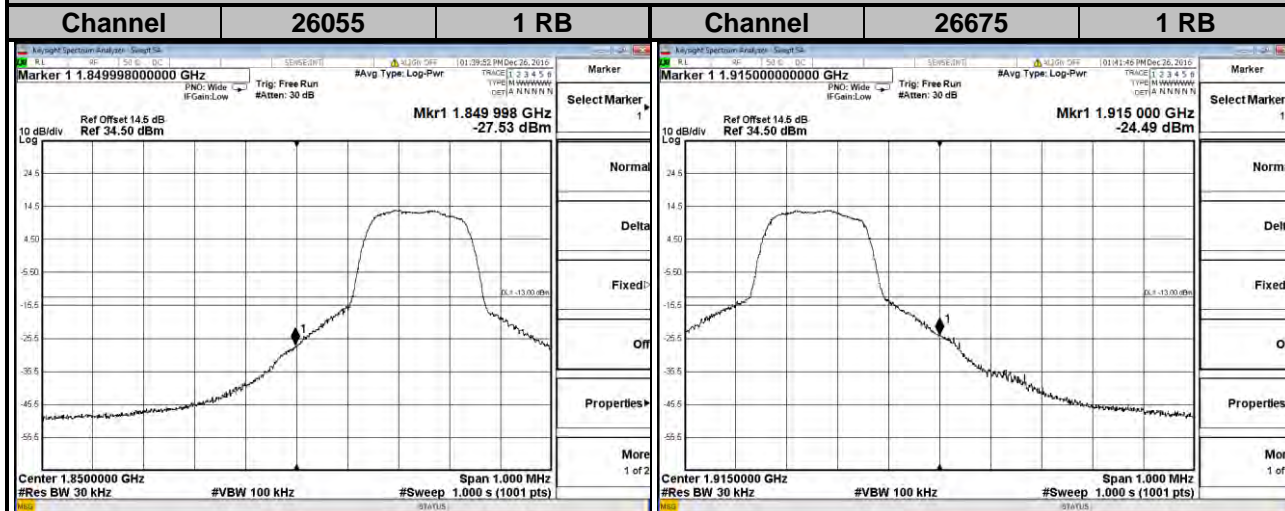

**LTE Band 25**  
**Channel Bandwidth: 5 MHz**

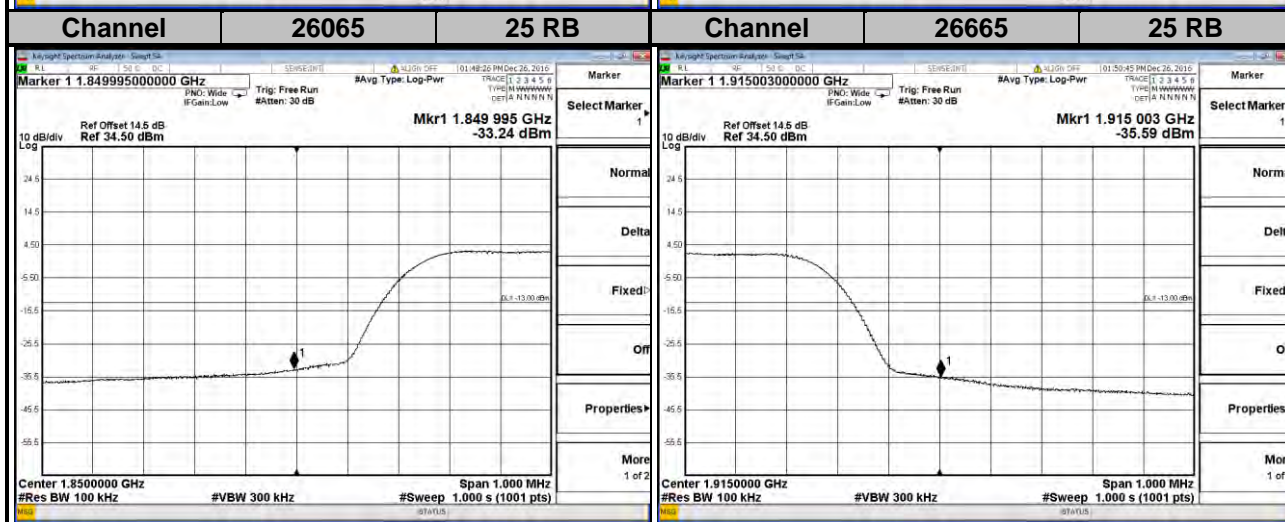
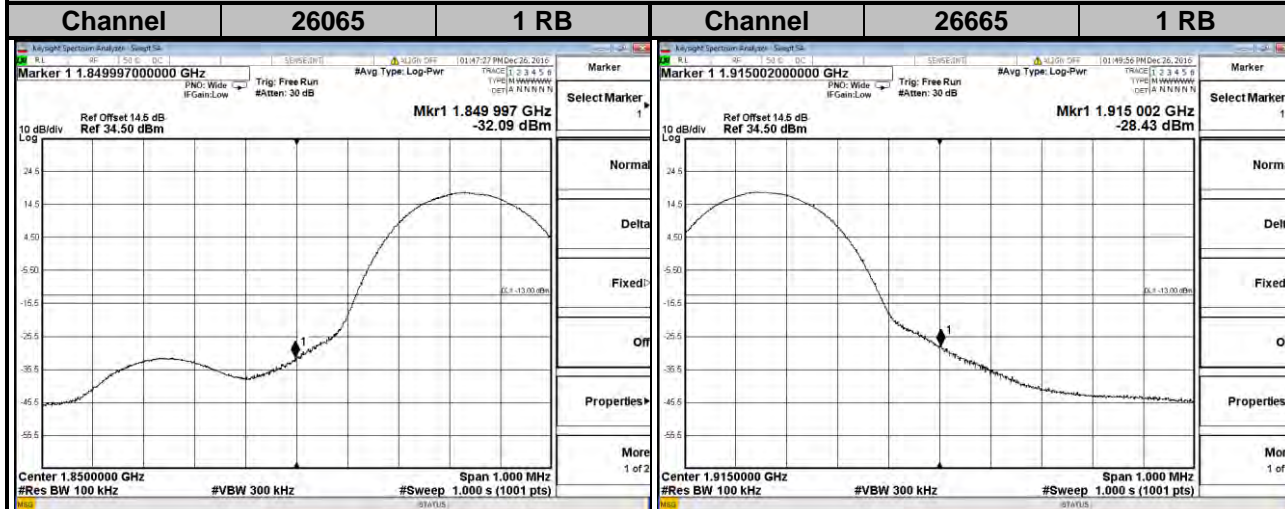

### LTE Band 25

Channel Bandwidth: 10 MHz

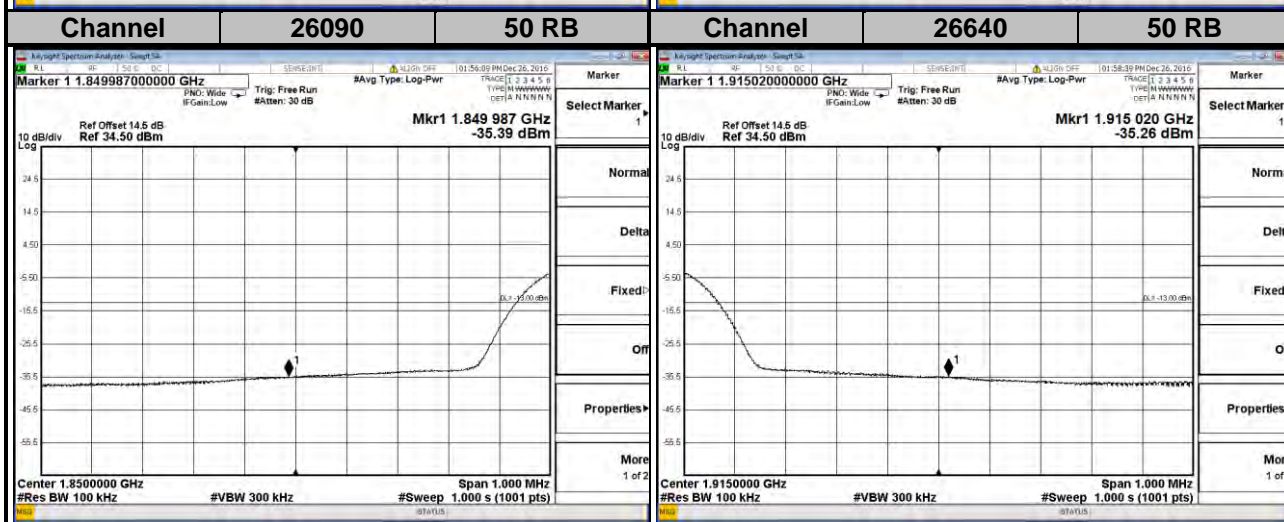
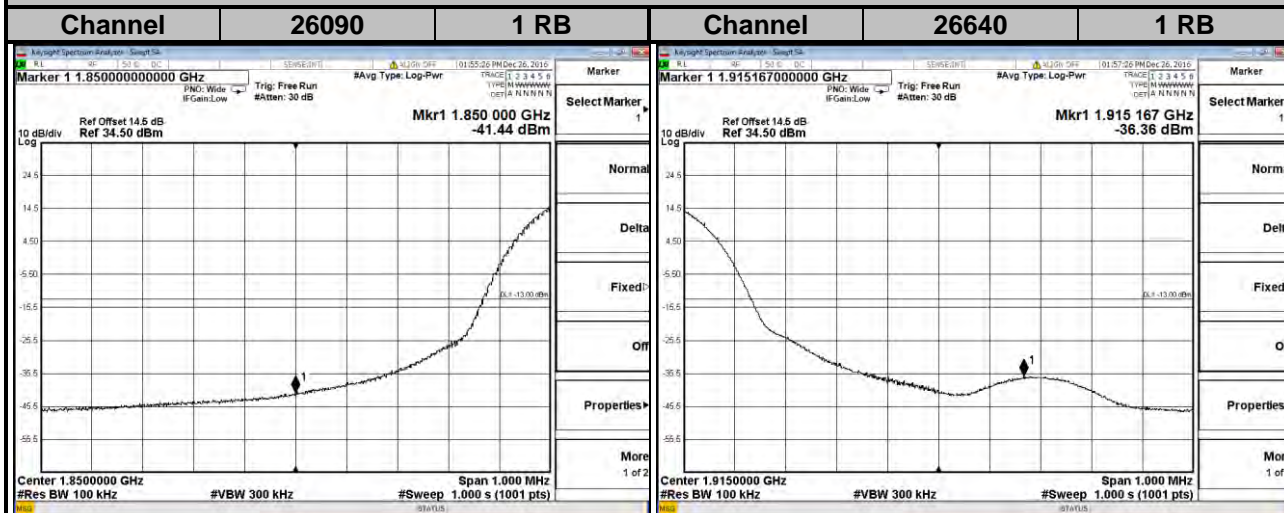

**LTE Band 25**  
**Channel Bandwidth: 15 MHz**

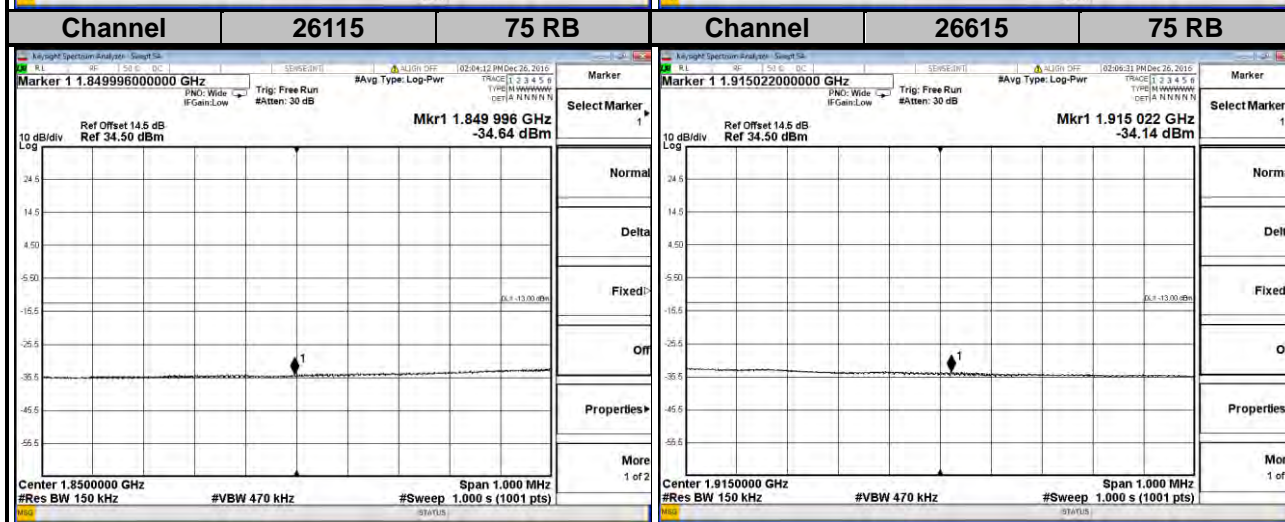
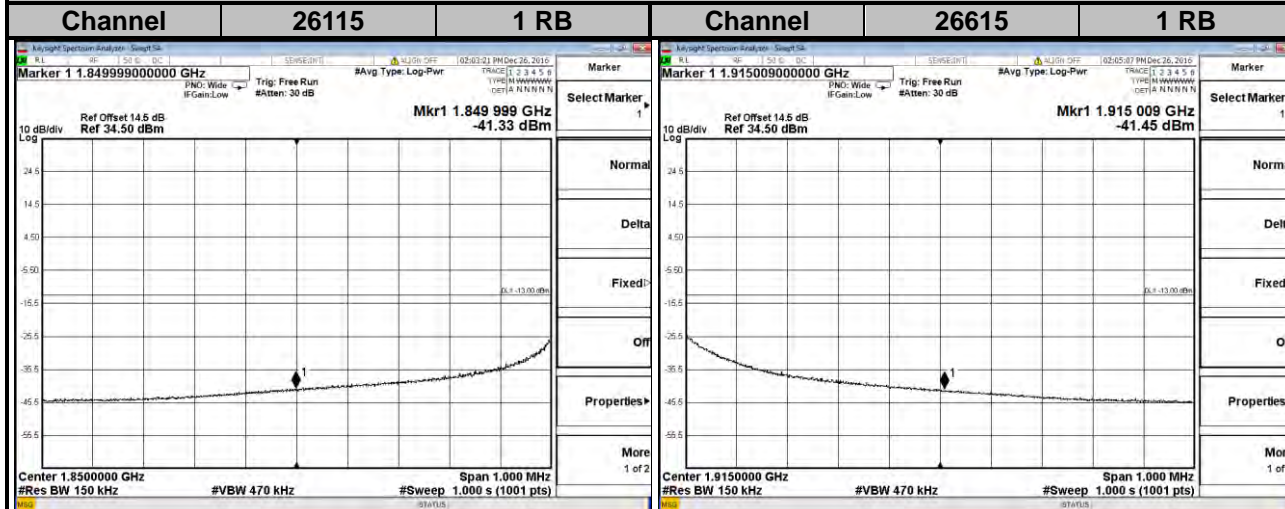



**LTE Band 25**  
**Channel Bandwidth: 20 MHz**

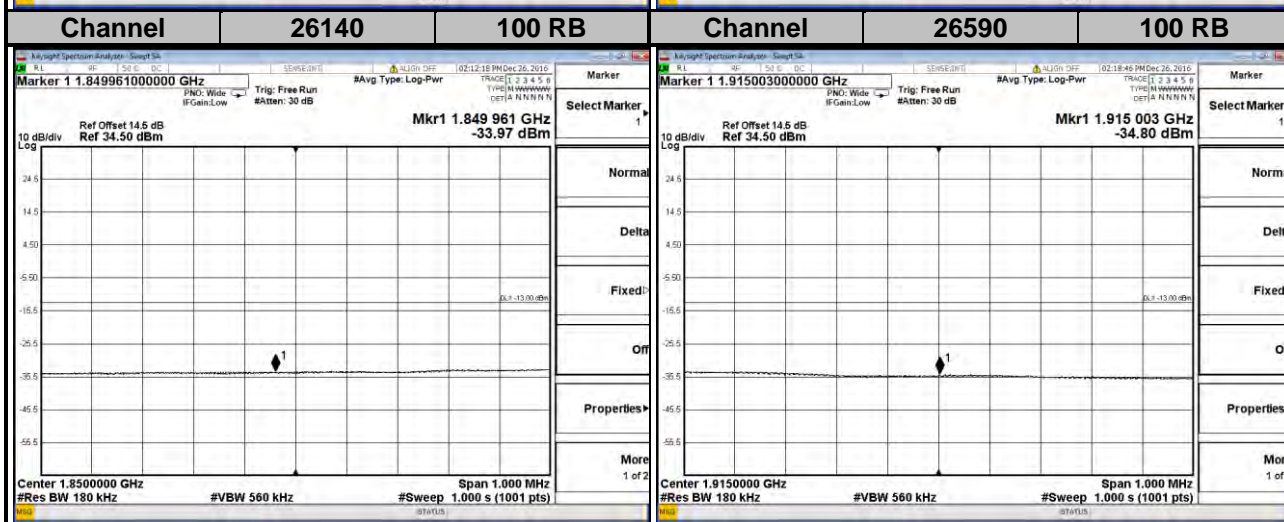
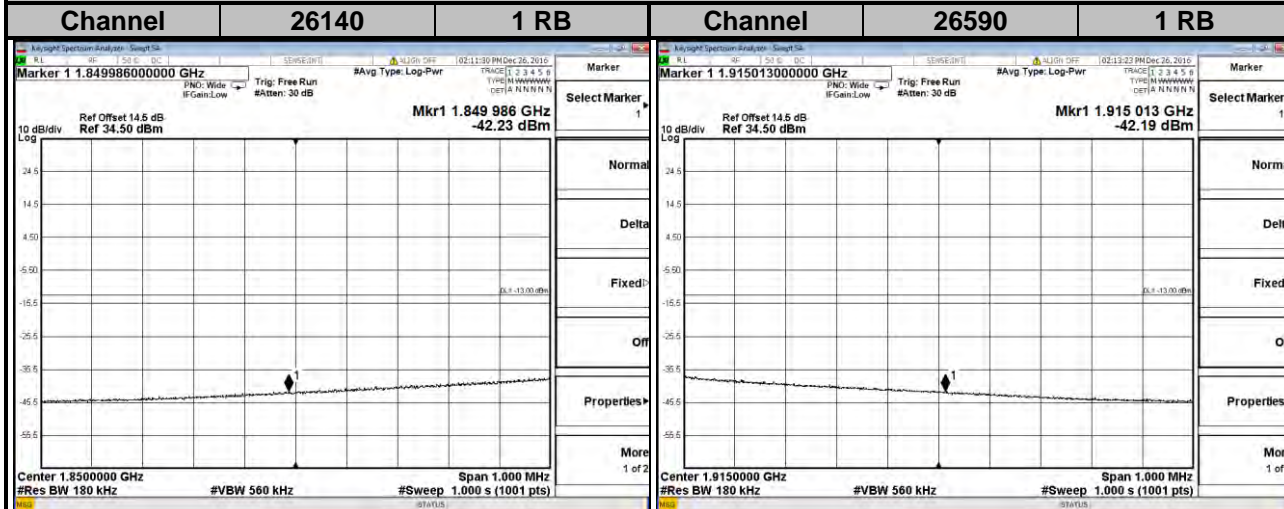

## 4.5 Peak to Average Ratio

### 4.5.1 Limits of Peak to Average Ratio Measurement

In measuring transmissions in this band using an average power technique, the peak to-average ratio (PAR) of the transmission may not exceed 13 dB.

### 4.5.2 Test Setup

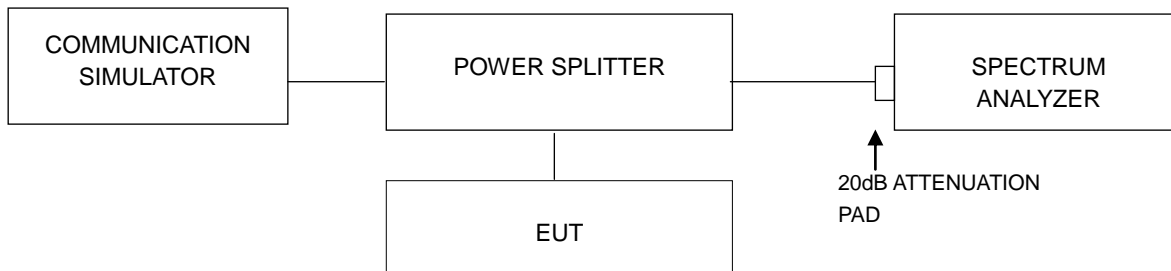

### 4.5.3 Test Procedures

1. Set resolution/measurement bandwidth  $\geq$  signal's occupied bandwidth;
2. Set the number of counts to a value that stabilizes the measured CCDF curve;
3. Record the maximum PAPR level associated with a probability of 0.1 %.

#### 4.5.4 Test Results

Channel	Frequency (MHz)	Peak to Average Ratio (dB)
		CDMA
25	1851.25	4.02
600	1880.00	4.21
1175	1908.75	4.14

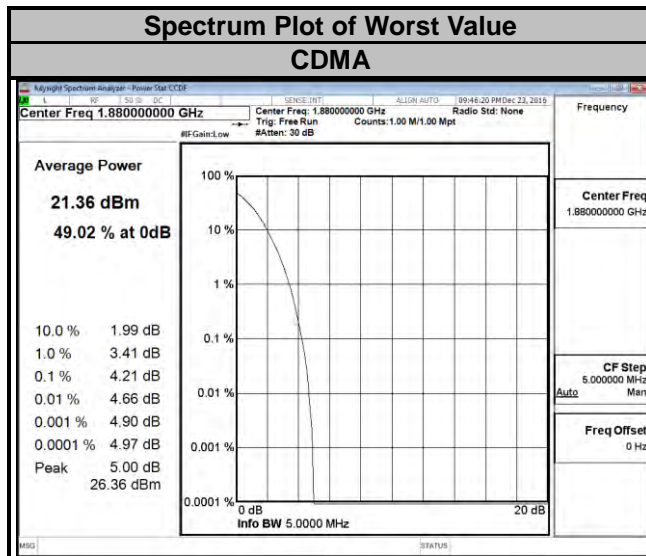

### LTE Band 2

Channel Bandwidth: 1.4 MHz				Channel Bandwidth: 3 MHz			
Channel	Frequency (MHz)	Peak to Average Ratio (dB)		Channel	Frequency (MHz)	Peak to Average Ratio (dB)	
		QPSK	16QAM			QPSK	16QAM
18607	1850.7	4.69	5.53	18615	1851.5	4.69	5.58
18900	1880.0	4.93	5.83	18900	1880.0	4.95	5.77
19193	1909.3	4.86	5.66	19185	1908.5	4.88	5.72

### Spectrum Plot of Worst Value

#### 1.4 MHz / QPSK

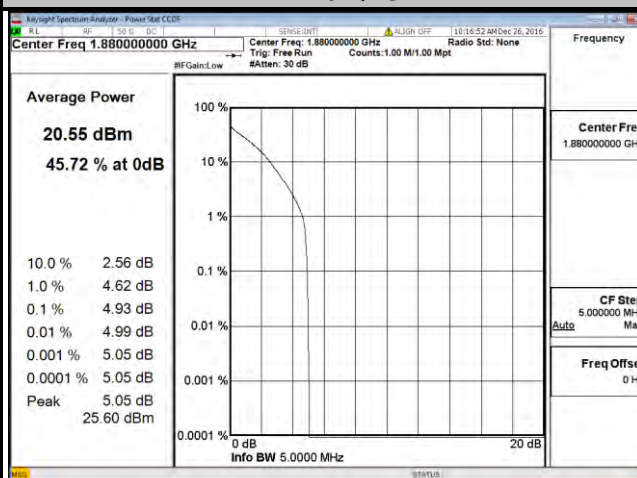

#### 1.4 MHz / 16QAM

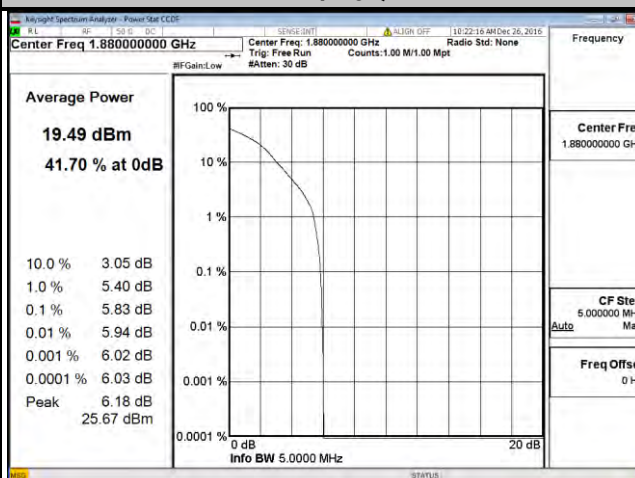

#### 3 MHz / QPSK

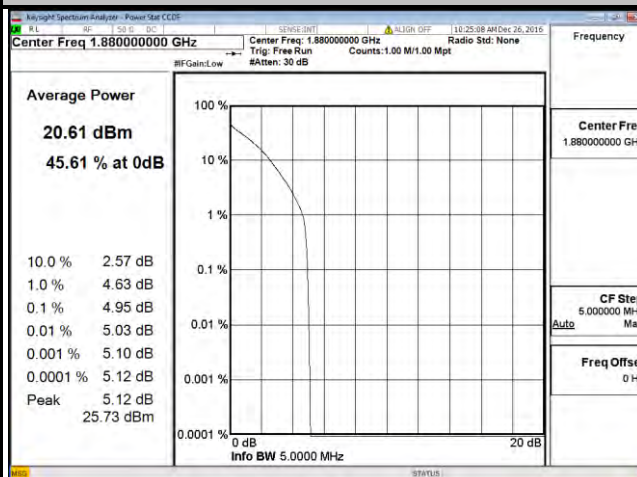

#### 3 MHz / 16QAM

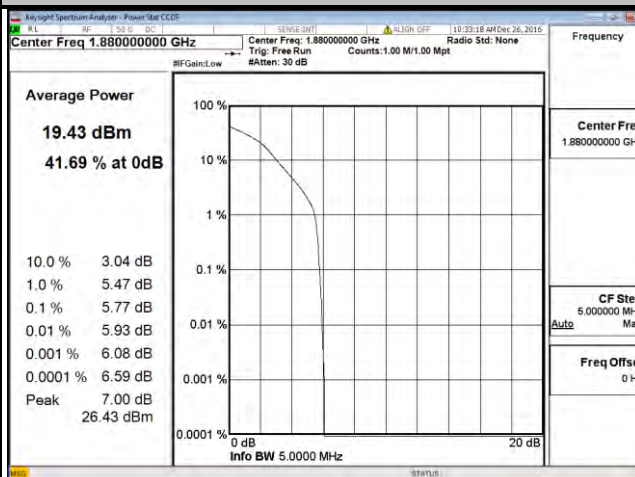

### LTE Band 2

Channel Bandwidth: 5 MHz				Channel Bandwidth: 10 MHz			
Channel	Frequency (MHz)	Peak to Average Ratio (dB)		Channel	Frequency (MHz)	Peak to Average Ratio (dB)	
		QPSK	16QAM			QPSK	16QAM
18625	1852.5	4.64	5.45	18650	1855.0	4.62	5.47
18900	1880.0	4.88	5.66	18900	1880.0	4.93	5.67
19175	1907.5	4.87	5.68	19150	1905.0	4.80	5.63

### Spectrum Plot of Worst Value

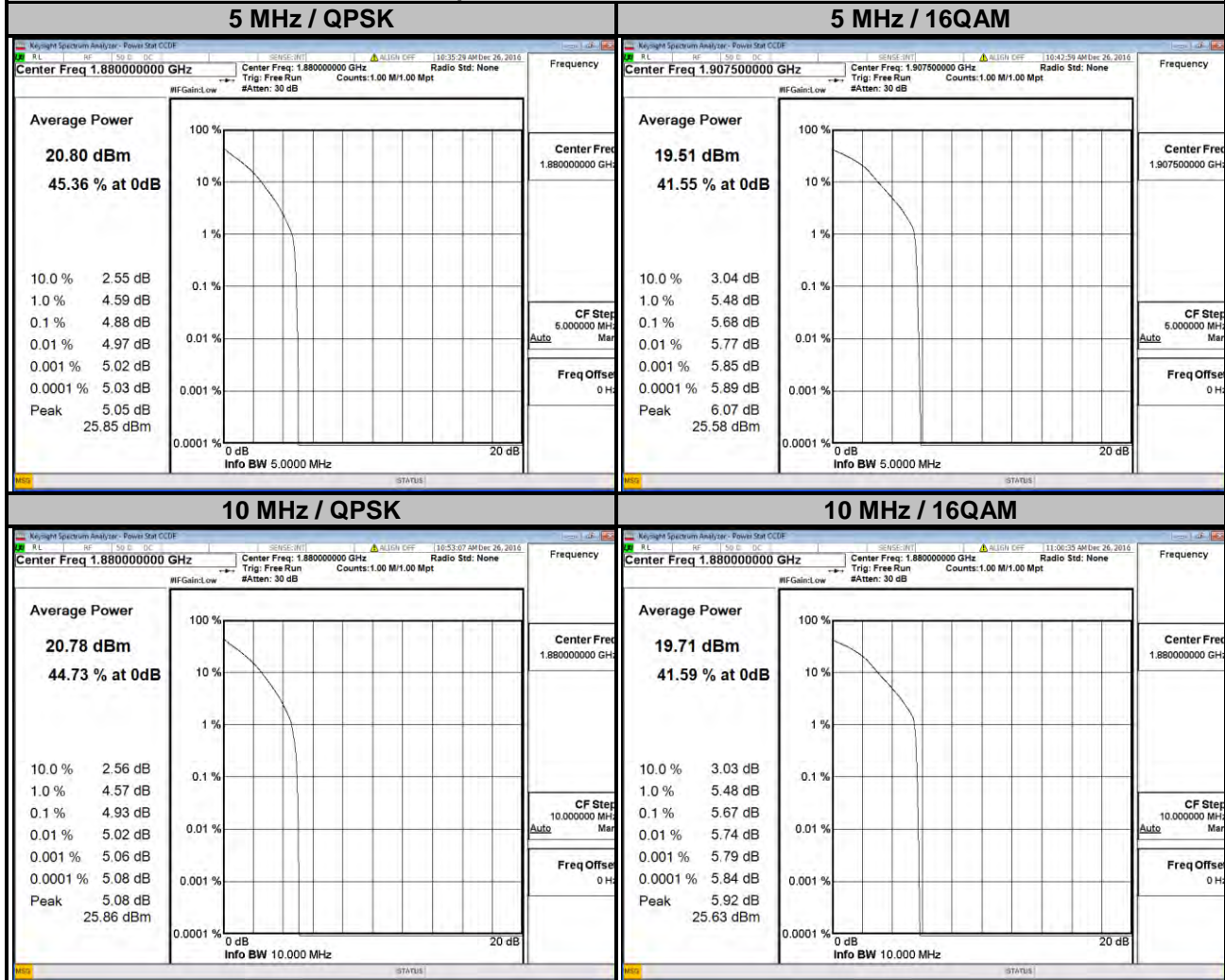

### LTE Band 2

#### Channel Bandwidth: 15 MHz

#### Channel Bandwidth: 20 MHz

Channel	Frequency (MHz)	Peak to Average Ratio (dB)		Channel	Frequency (MHz)	Peak to Average Ratio (dB)	
		QPSK	16QAM			QPSK	16QAM
18675	1857.5	4.63	5.48	18700	1860.0	4.58	5.45
18900	1880.0	4.95	5.63	18900	1880.0	4.93	5.71
19125	1902.5	4.73	5.55	19100	1900.0	4.71	5.50

### Spectrum Plot of Worst Value

#### 15 MHz / QPSK

#### 15 MHz / 16QAM

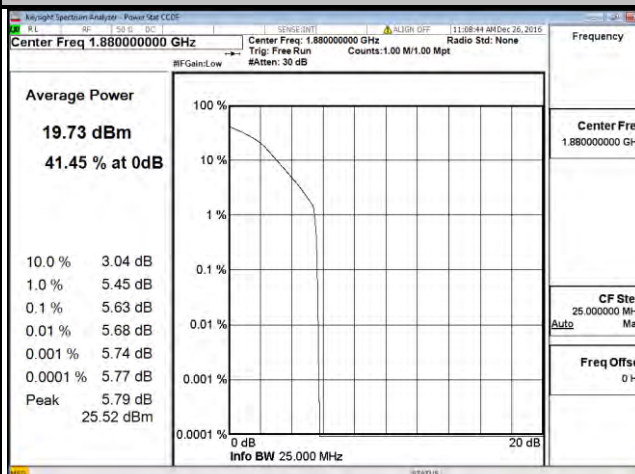
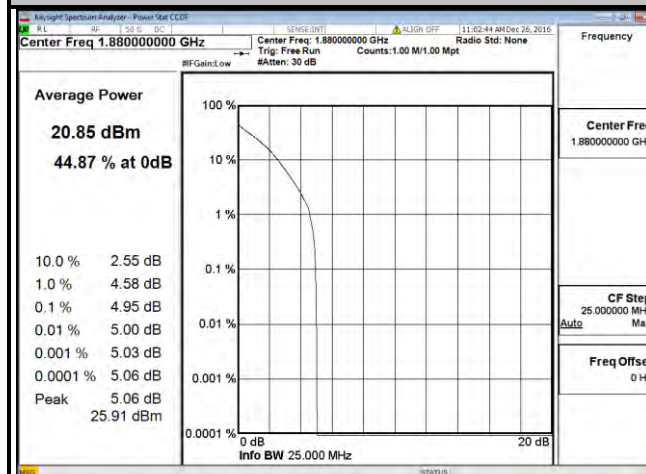

#### 20 MHz / QPSK

#### 20 MHz / 16QAM

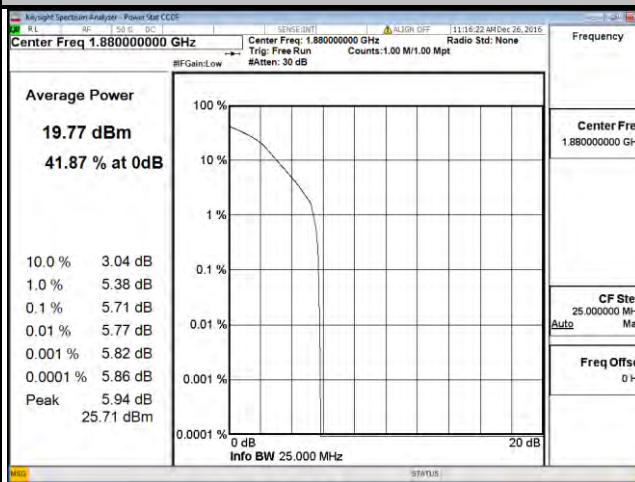
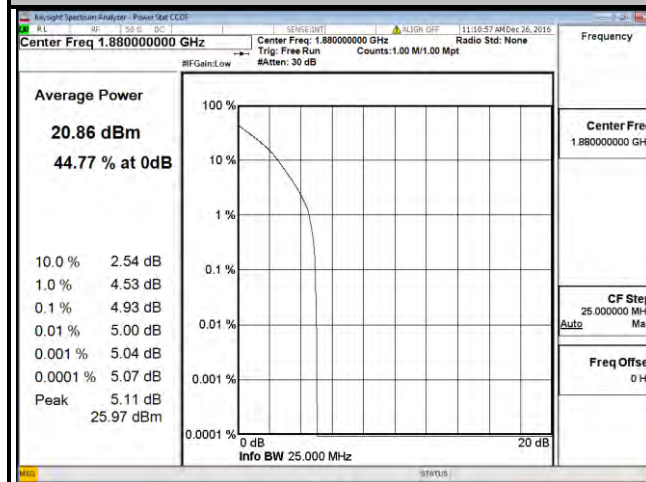

### LTE Band 25

Channel Bandwidth: 1.4 MHz				Channel Bandwidth: 3 MHz			
Channel	Frequency (MHz)	Peak to Average Ratio (dB)		Channel	Frequency (MHz)	Peak to Average Ratio (dB)	
		QPSK	16QAM			QPSK	16QAM
26047	1850.7	4.70	5.44	26055	1851.5	4.67	5.44
26365	1882.5	5.02	5.80	26365	1882.5	5.02	5.80
26683	1914.3	3.76	4.75	26675	1913.5	4.21	5.25

### Spectrum Plot of Worst Value

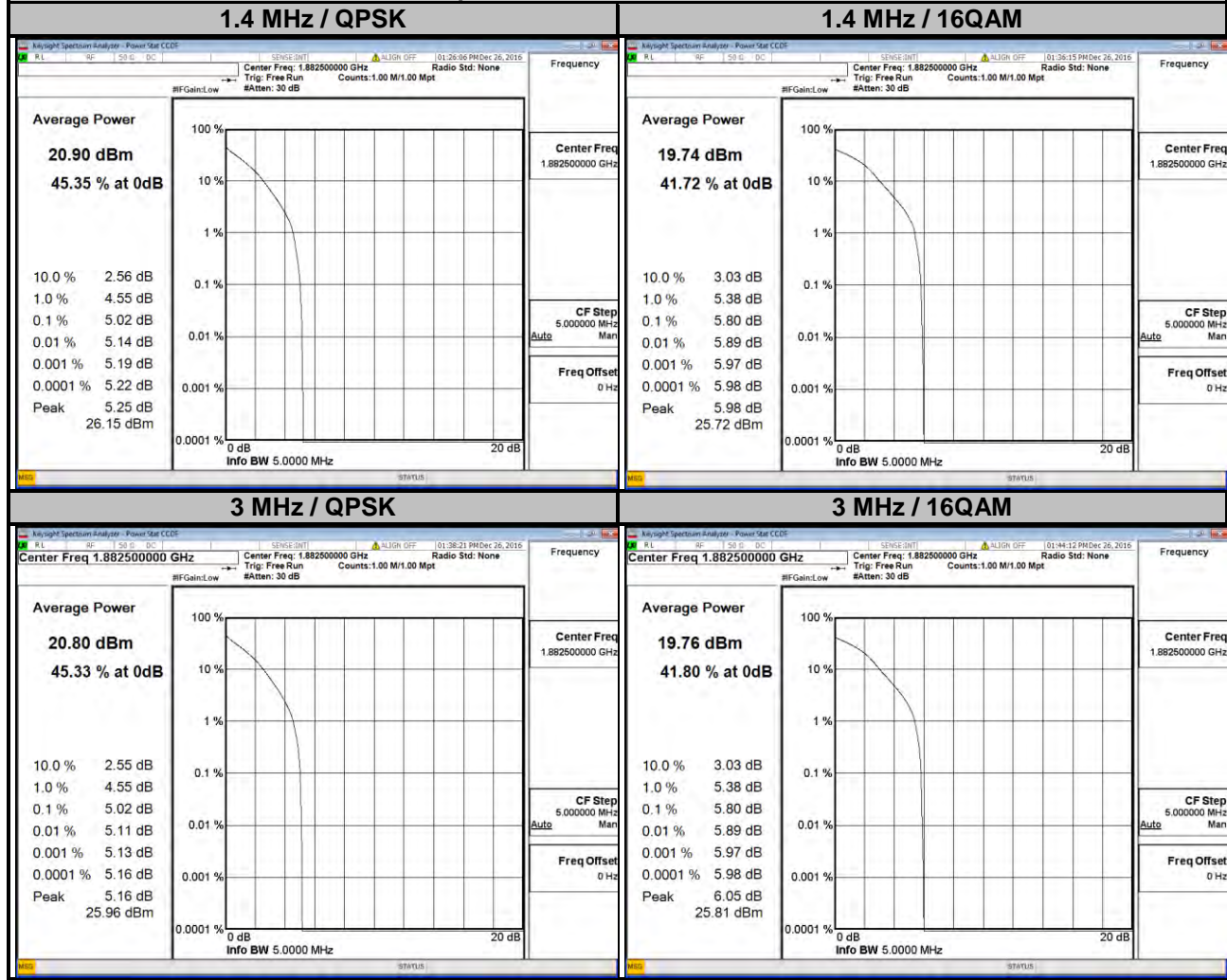

### LTE Band 25

Channel Bandwidth: 5 MHz				Channel Bandwidth: 10 MHz			
Channel	Frequency (MHz)	Peak to Average Ratio (dB)		Channel	Frequency (MHz)	Peak to Average Ratio (dB)	
		QPSK	16QAM			QPSK	16QAM
26065	1852.5	4.66	5.49	26090	1855.0	4.61	5.52
26365	1882.5	4.88	5.81	26365	1882.5	4.88	5.63
26665	1912.5	4.77	5.57	26640	1910.0	4.89	5.67

### Spectrum Plot of Worst Value

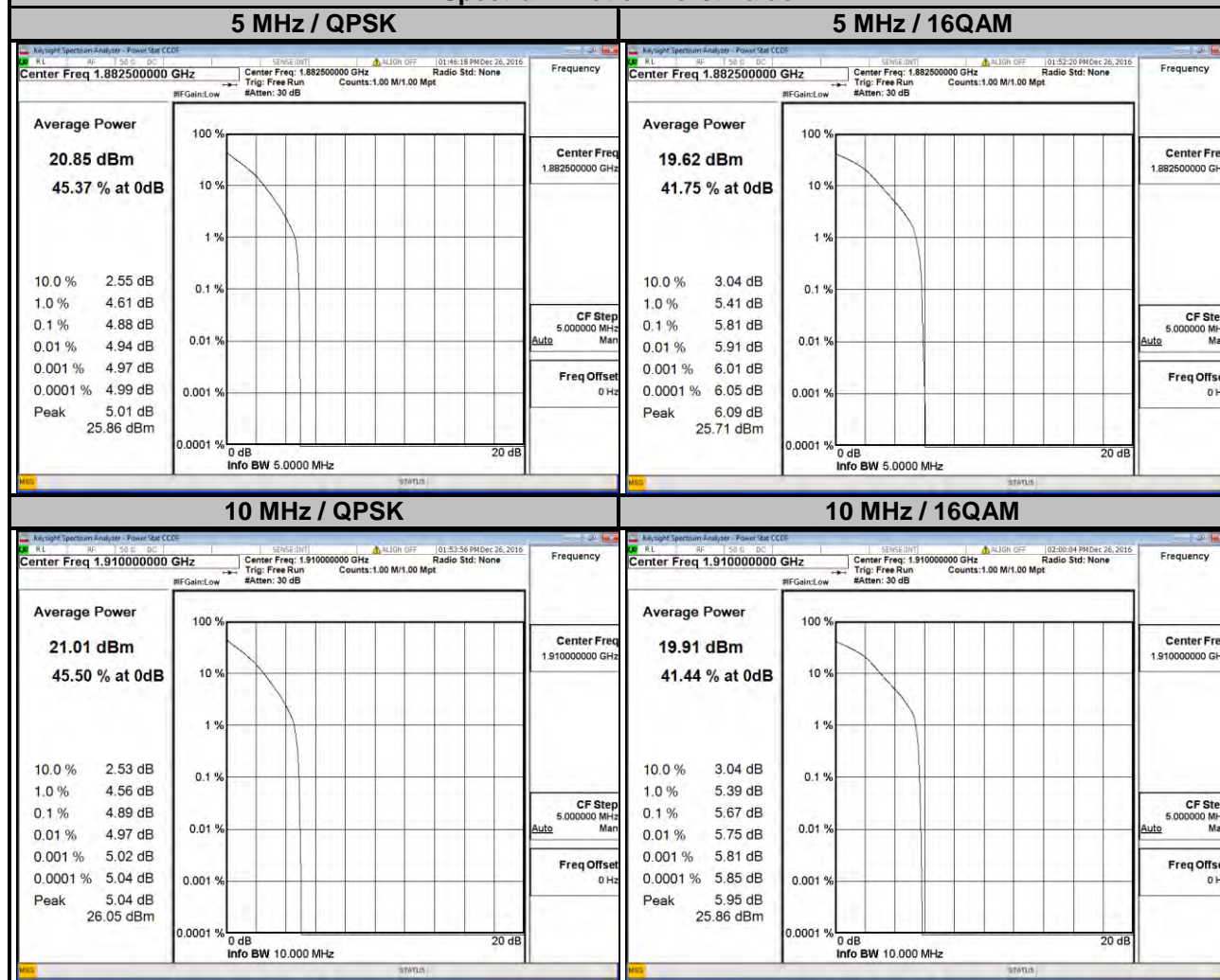



### LTE Band 25

Channel Bandwidth: 15 MHz				Channel Bandwidth: 20 MHz			
Channel	Frequency (MHz)	Peak to Average Ratio (dB)		Channel	Frequency (MHz)	Peak to Average Ratio (dB)	
		QPSK	16QAM			QPSK	16QAM
26115	1857.5	4.61	5.49	26140	1860	4.54	5.44
26365	1882.5	4.94	5.64	26365	1882.5	4.96	5.61
26615	1907.5	4.78	5.59	26590	1905	4.68	5.56

### Spectrum Plot of Worst Value

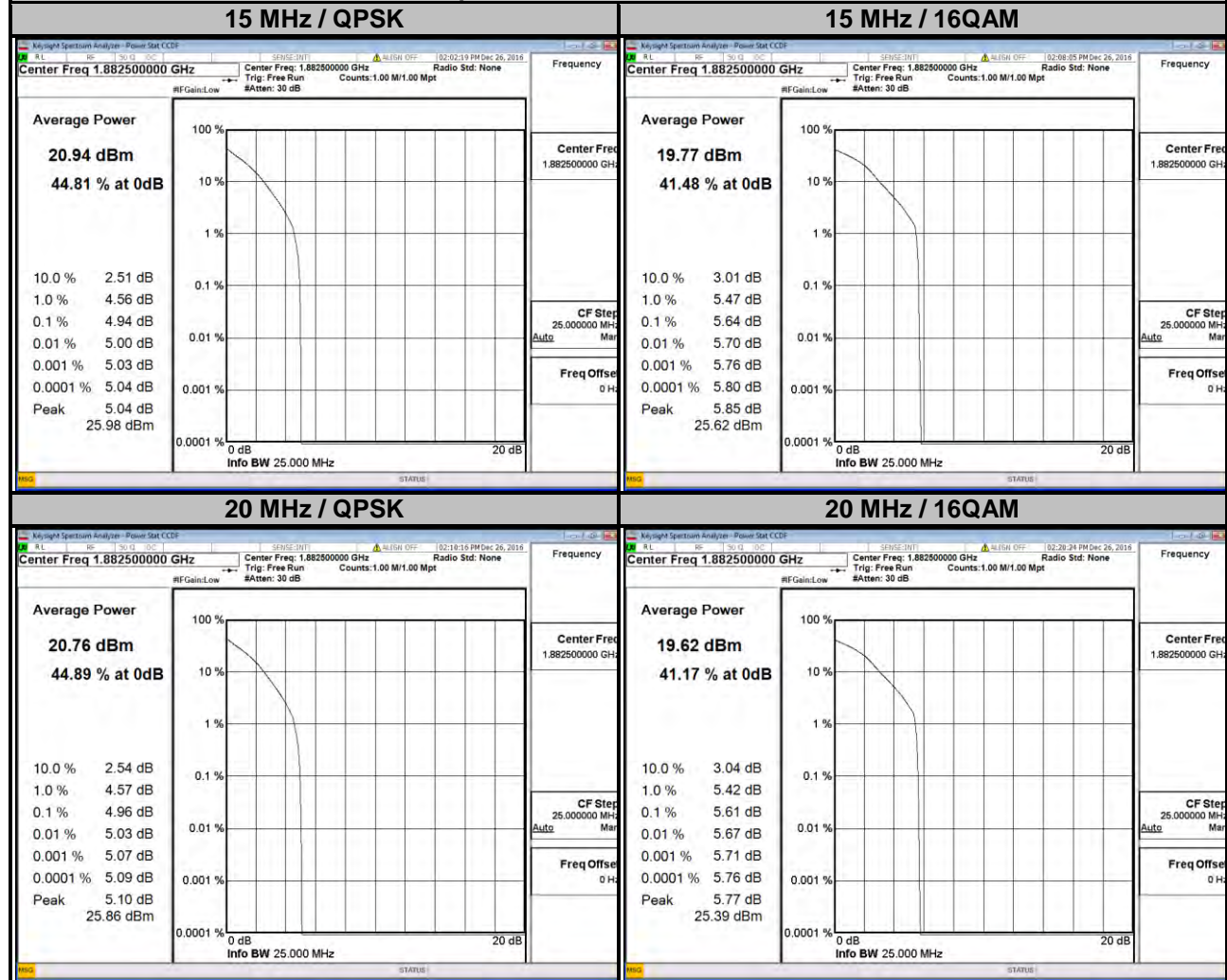

## 4.6 Conducted Spurious Emissions

### 4.6.1 Limits of Conducted Spurious Emissions Measurement

The power of any emission outside of the authorized operating frequency ranges must be attenuated below the transmitting power (P) by a factor of at least  $43 + 10 \log(P)$  dB. The emission limit equal to  $-13$  dBm.

### 4.6.2 Test Setup

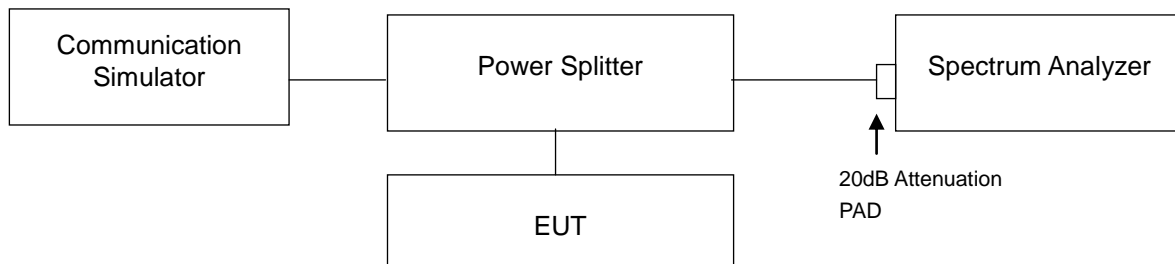

### 4.6.3 Test Procedure

- The EUT makes a phone call to the communication simulator. All measurements were done at low, middle and high operational frequency range.
- Measuring frequency range is from 9 kHz to 9 GHz. 20 dB attenuation pad is connected with spectrum. RBW=1 MHz and VBW=3 MHz is used for conducted emission measurement.

### 4.6.4 Test Results

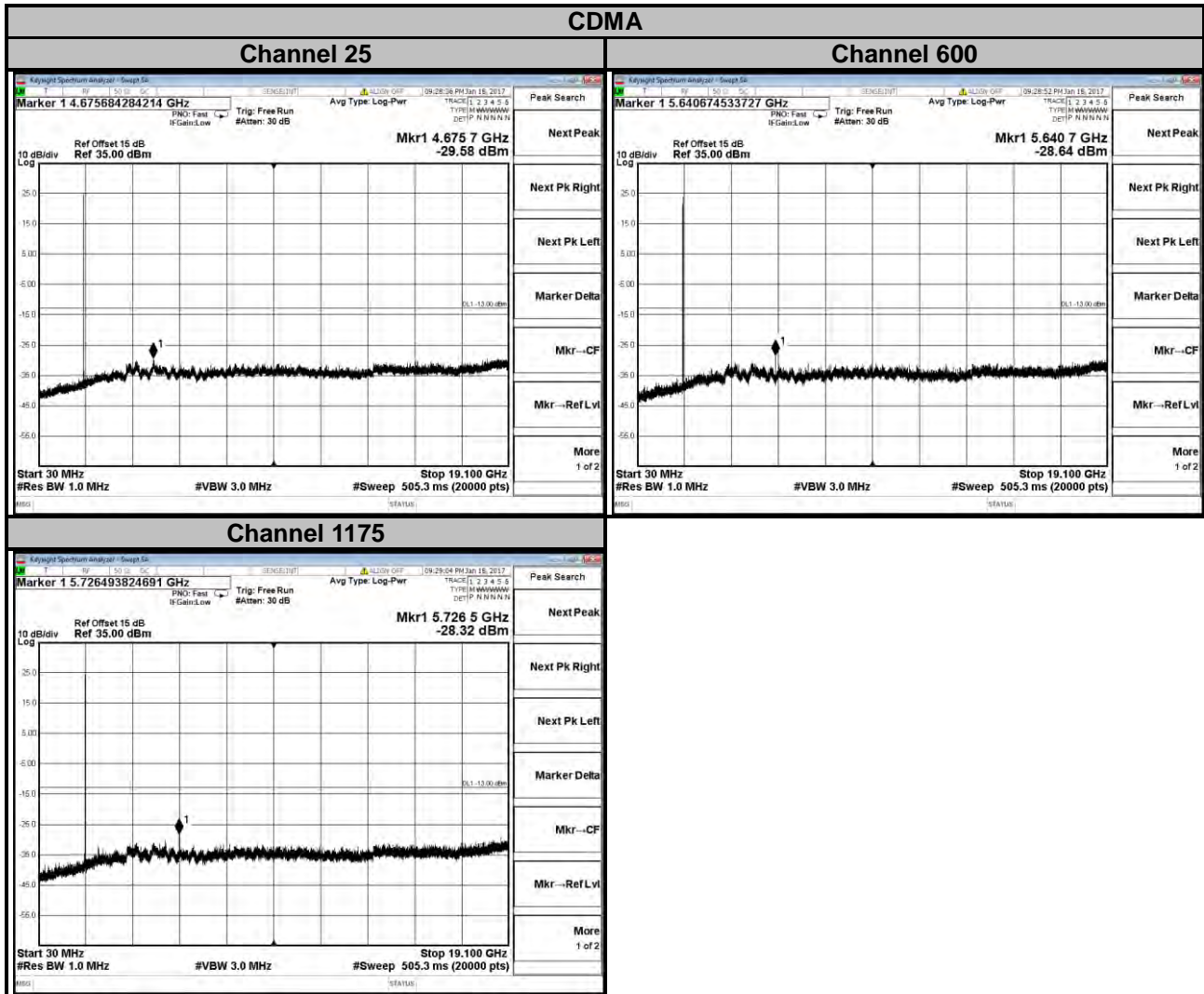

### LTE Band 2

Channel Bandwidth: 1.4 MHz

#### Channel 18607

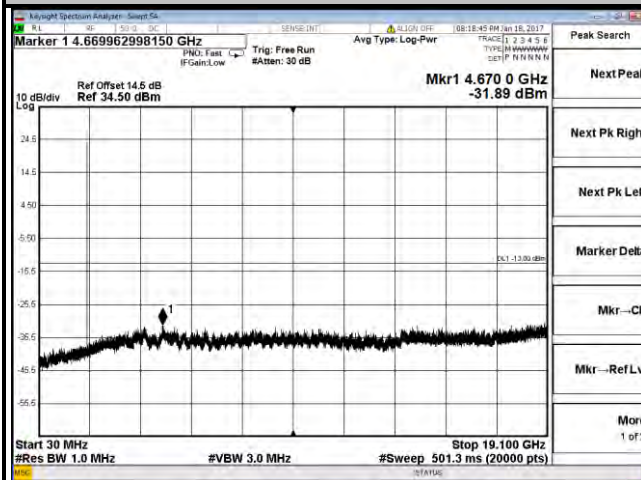

#### Channel 18900

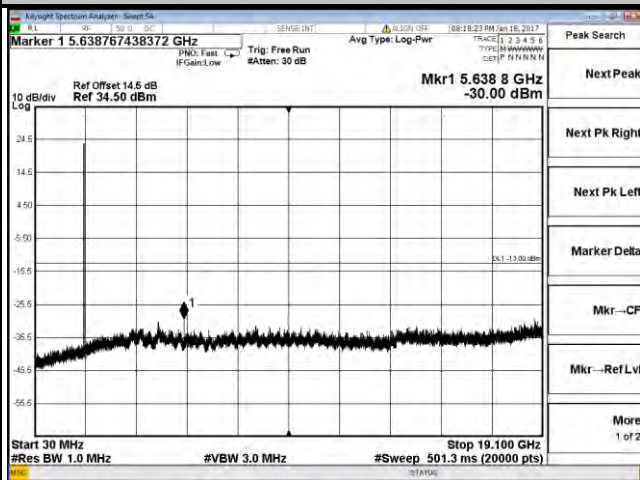

#### Channel 19193

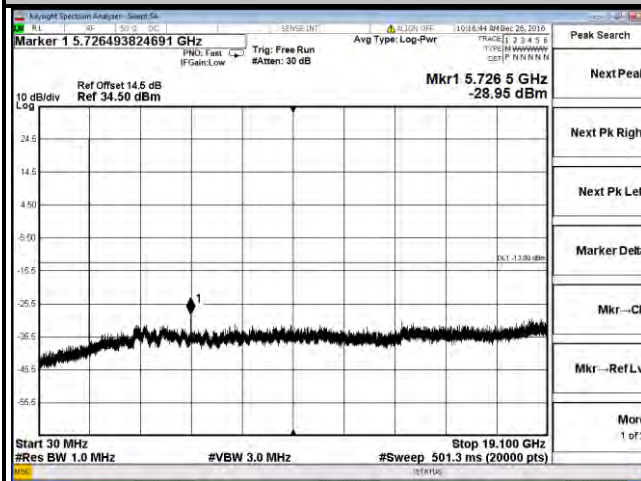

**LTE Band 2**  
**Channel Bandwidth: 3 MHz**

**Channel 18615**

**Channel 18900**

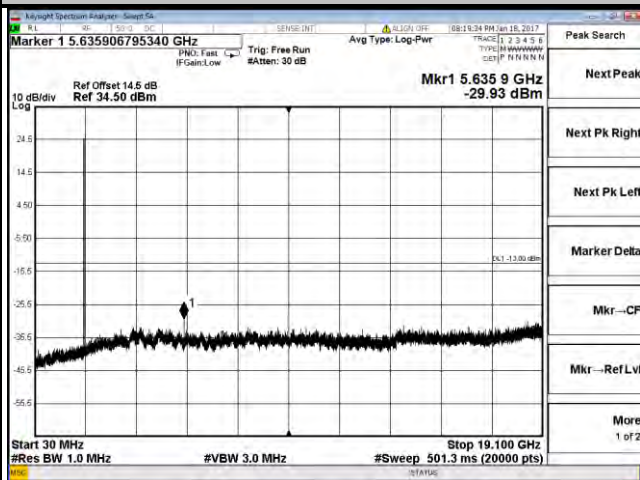
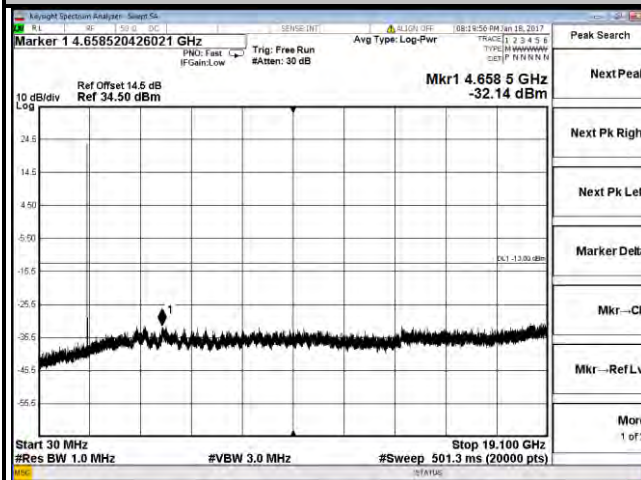

**Channel 19185**

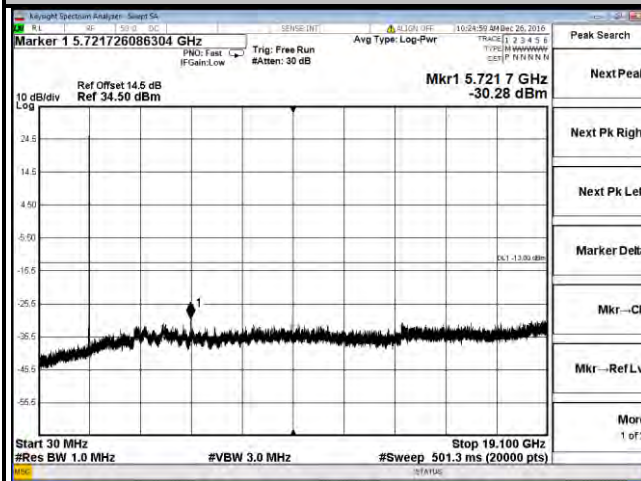

**LTE Band 2**  
**Channel Bandwidth: 5 MHz**

**Channel 18625**

**Channel 18900**

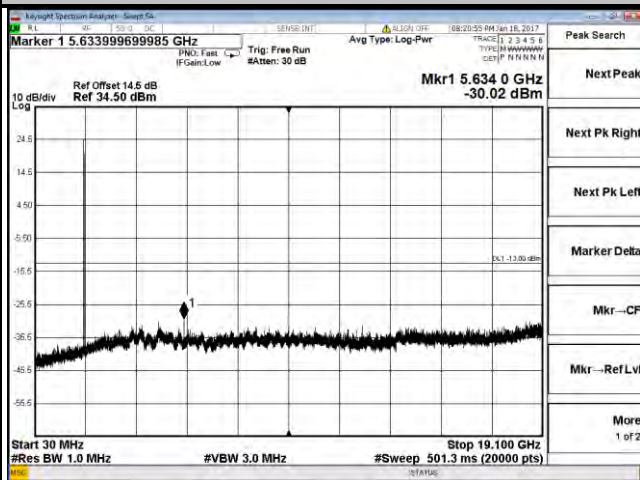
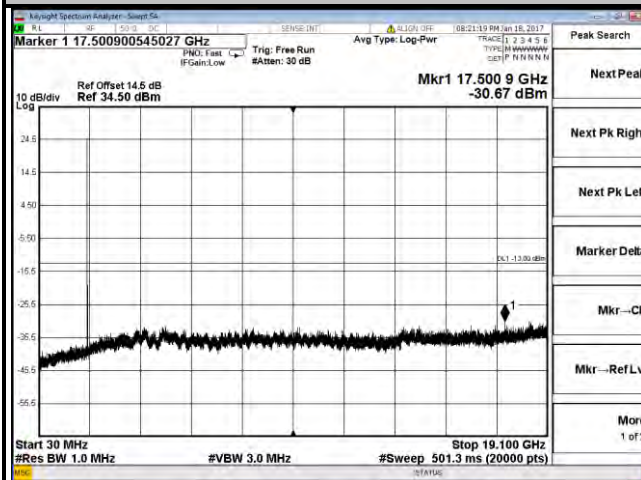

**Channel 19175**

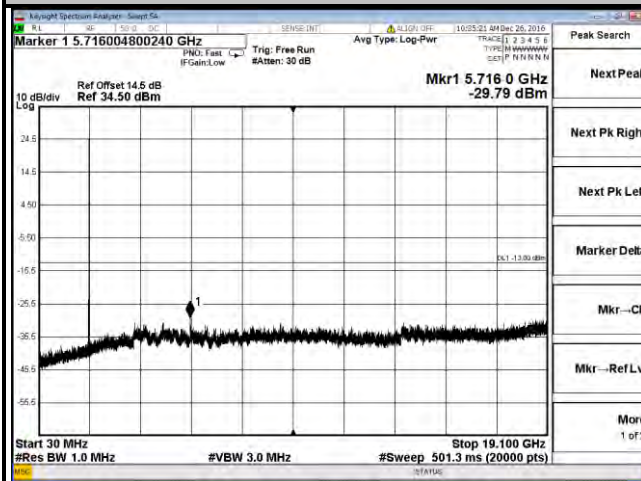

**LTE Band 2**  
**Channel Bandwidth: 10 MHz**

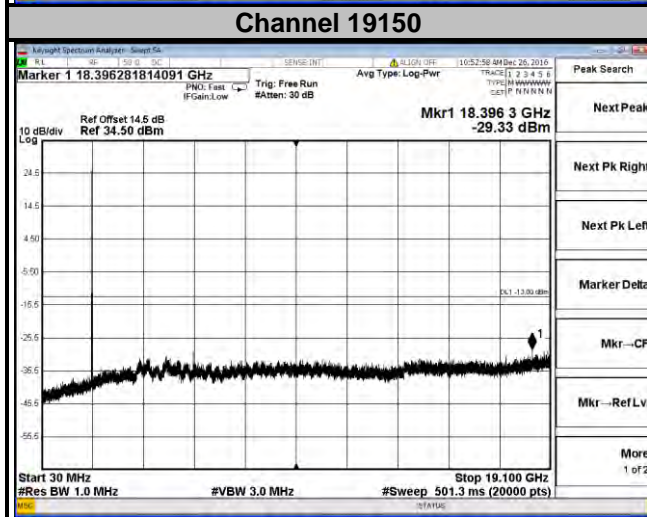
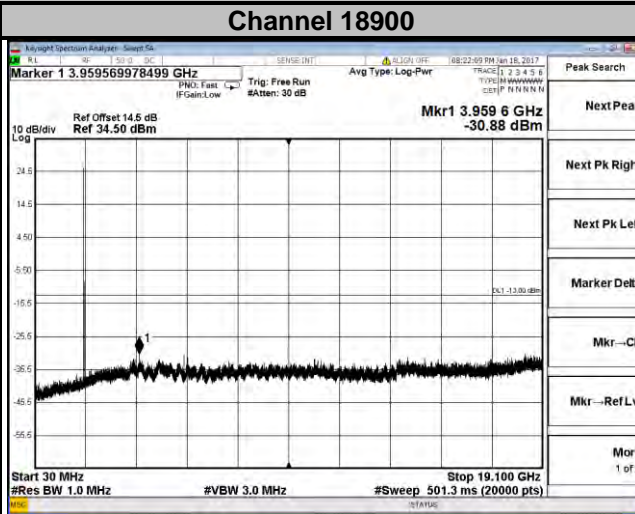
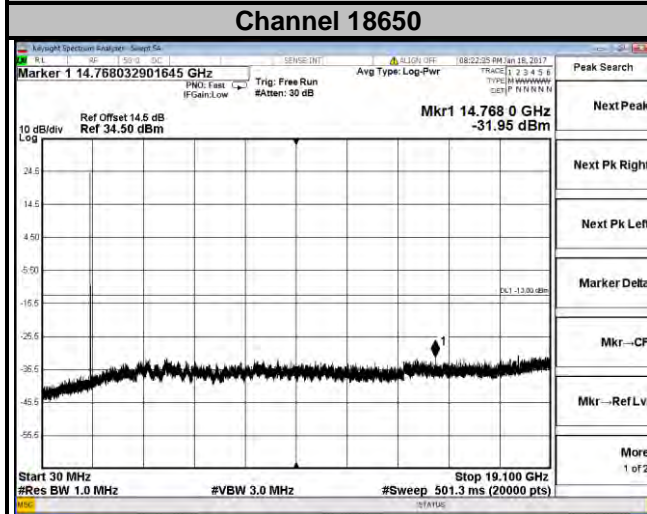

**LTE Band 2**  
**Channel Bandwidth: 15 MHz**

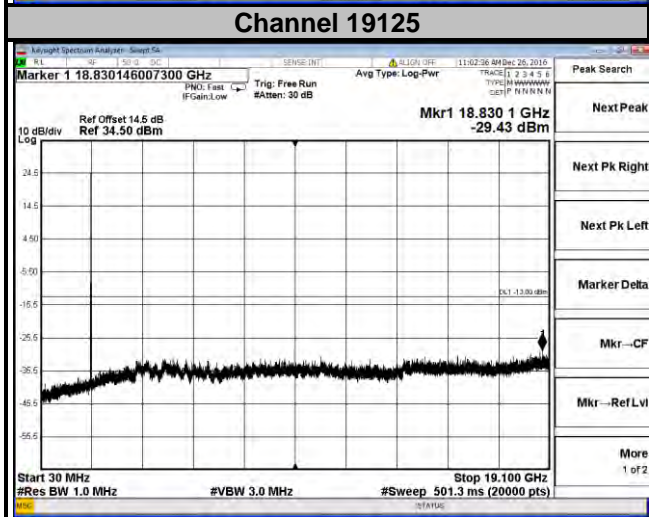
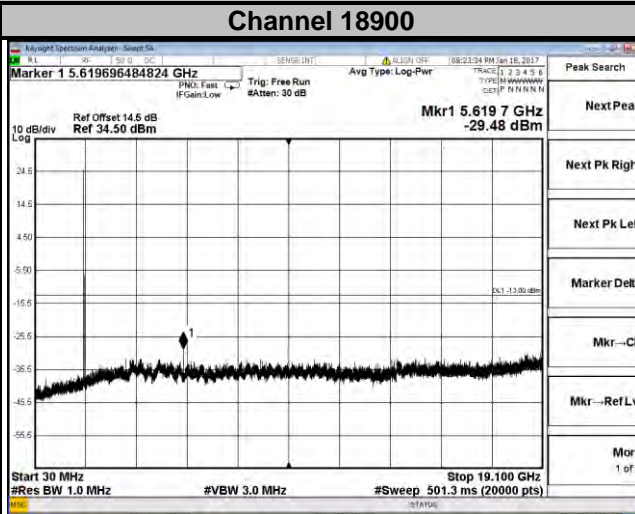
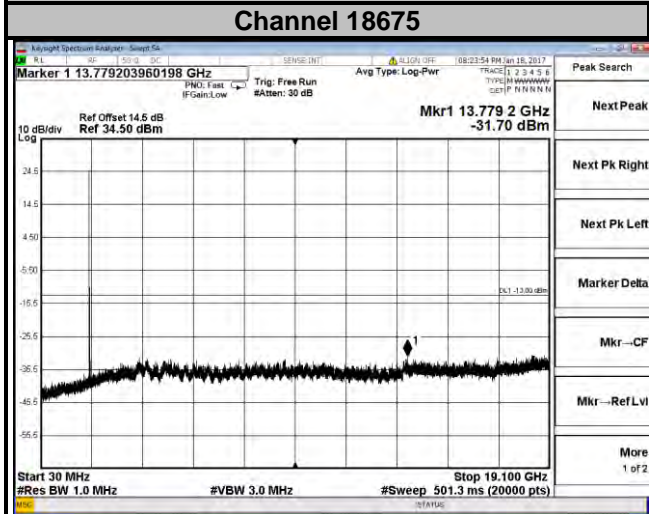



**LTE Band 2**  
**Channel Bandwidth: 20 MHz**

**Channel 18700**

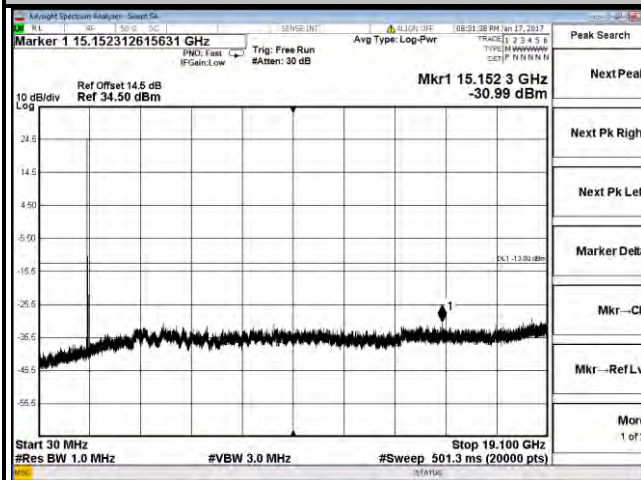

**Channel 18900**

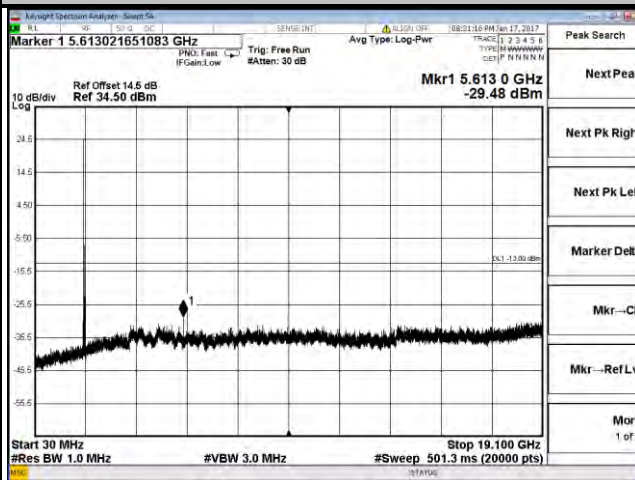

**Channel 19100**

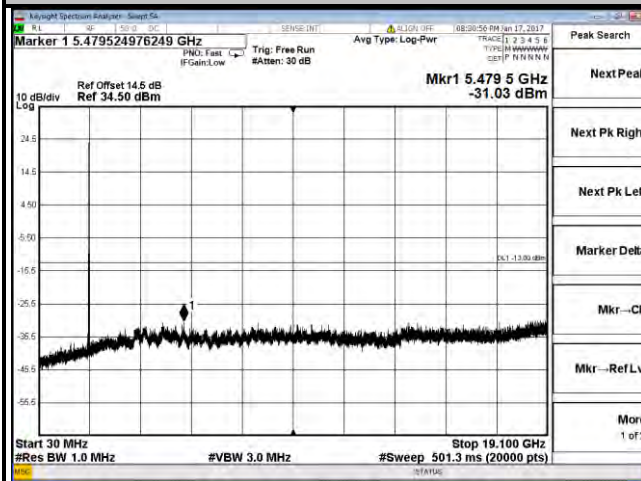

LTE Band 25

Channel Bandwidth: 1.4 MHz

Channel 26047

Channel 26365

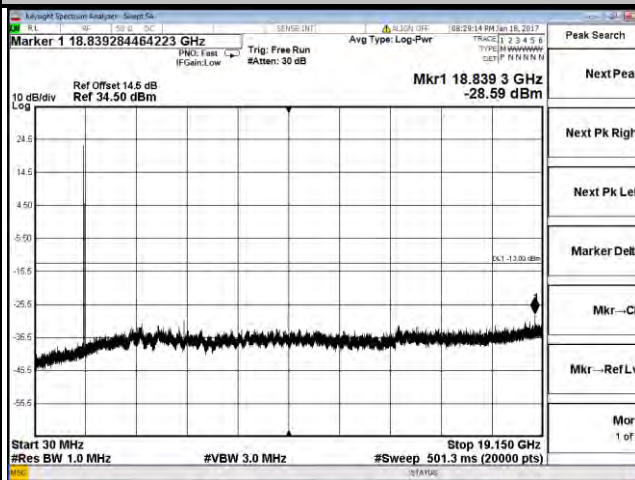
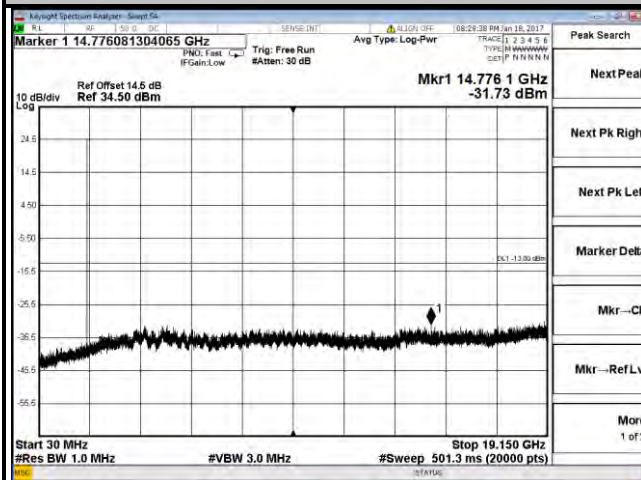

Channel 26683

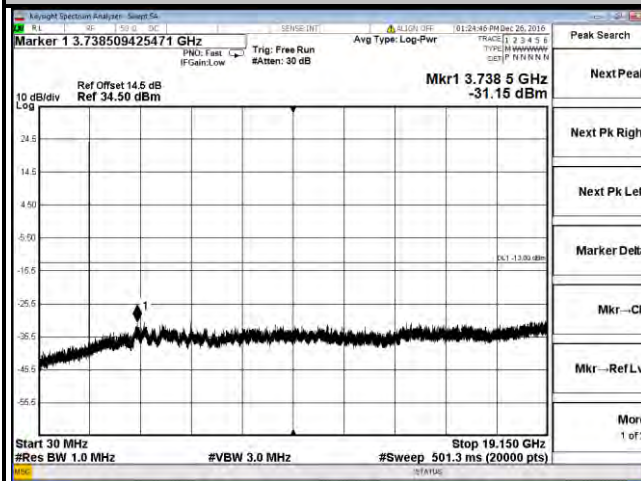

**LTE Band 25**  
**Channel Bandwidth: 3 MHz**

**Channel 26055**

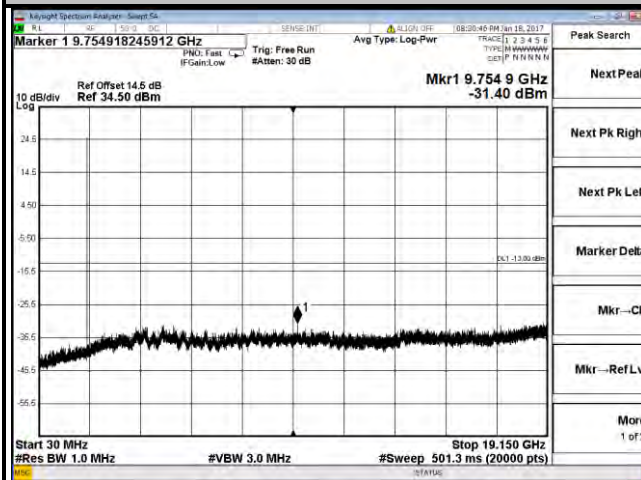

**Channel 26365**

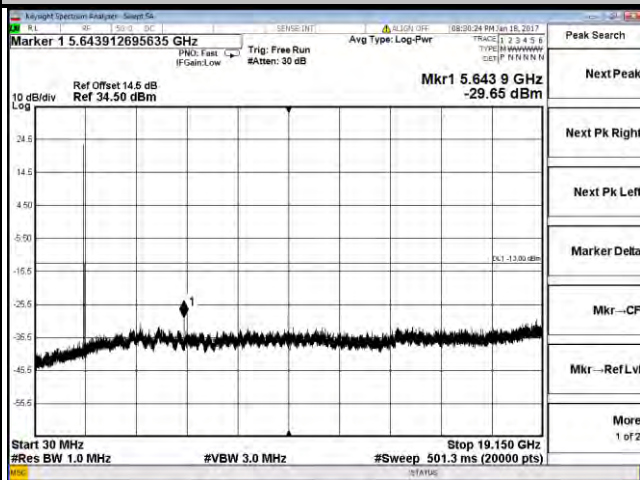

**Channel 26675**

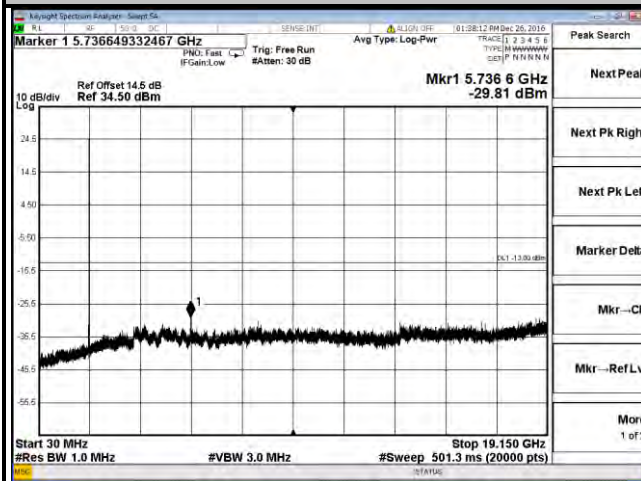

**LTE Band 25**  
**Channel Bandwidth: 5 MHz**

**Channel 26065**

**Channel 26365**

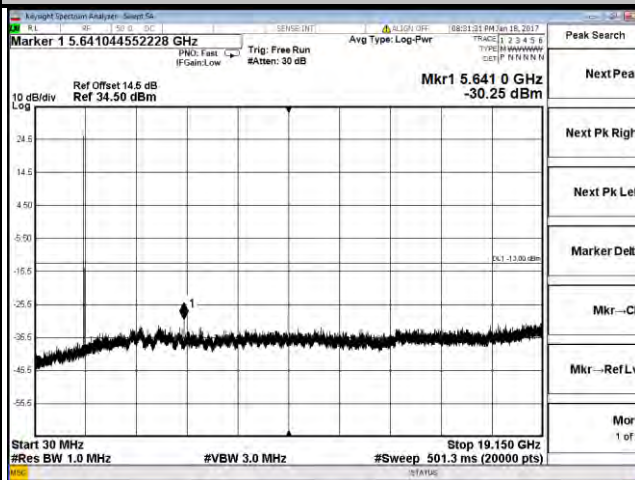
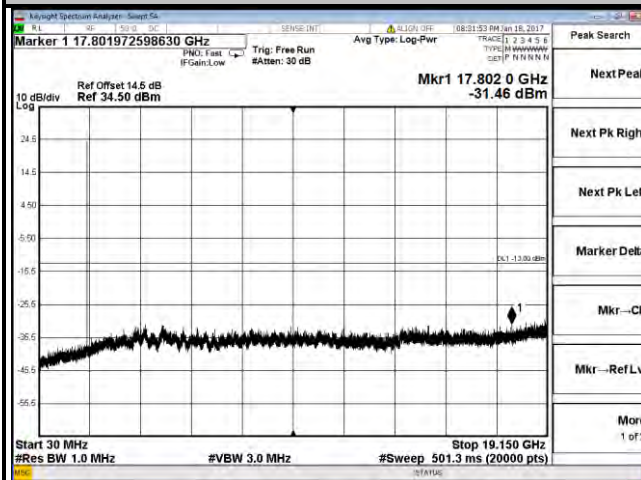

**Channel 26665**

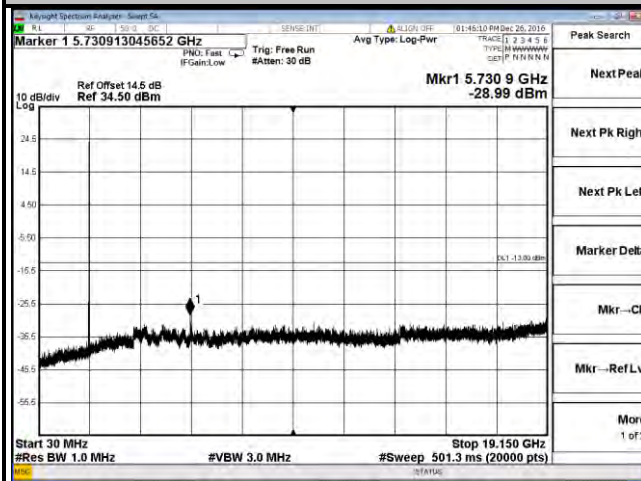

LTE Band 25

Channel Bandwidth: 10 MHz

Channel 26090

Channel 26365

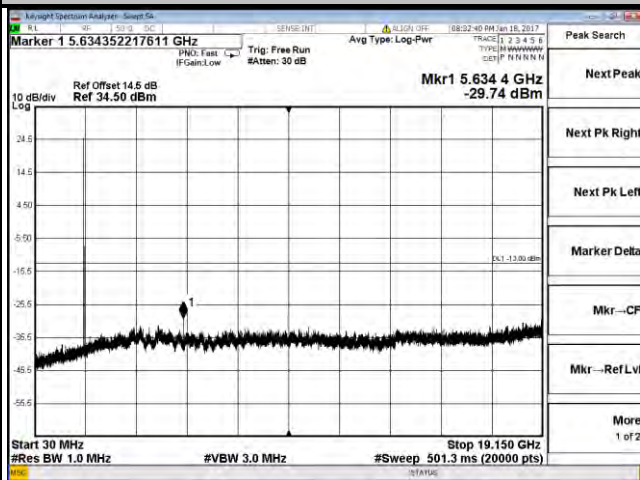
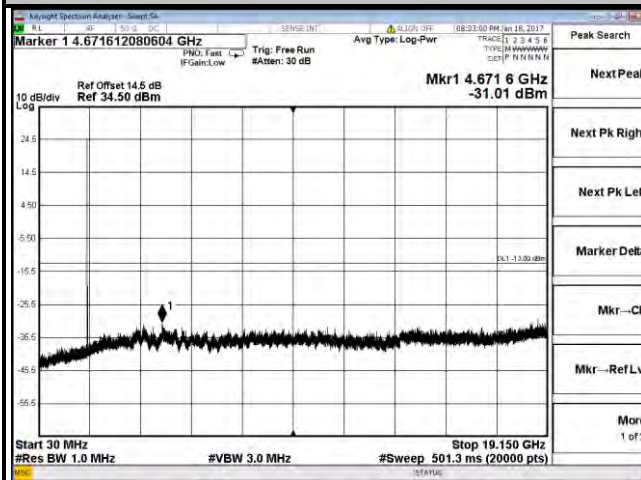

Channel 26640

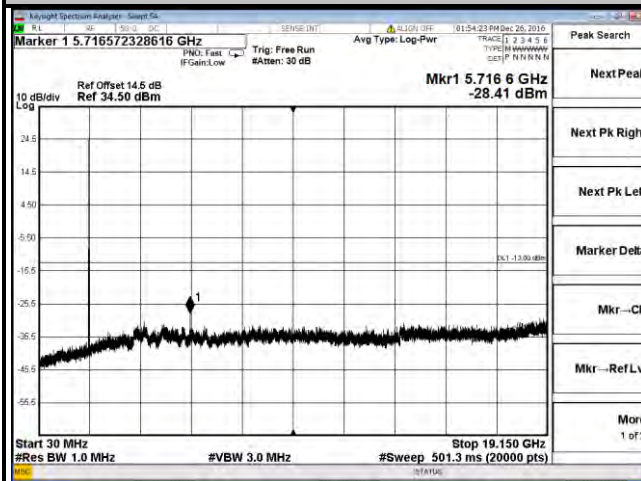

### LTE Band 25

Channel Bandwidth: 15 MHz

#### Channel 26115

#### Channel 26365

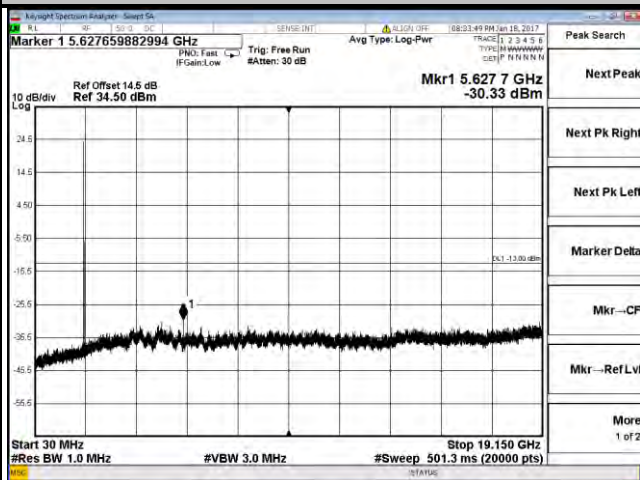
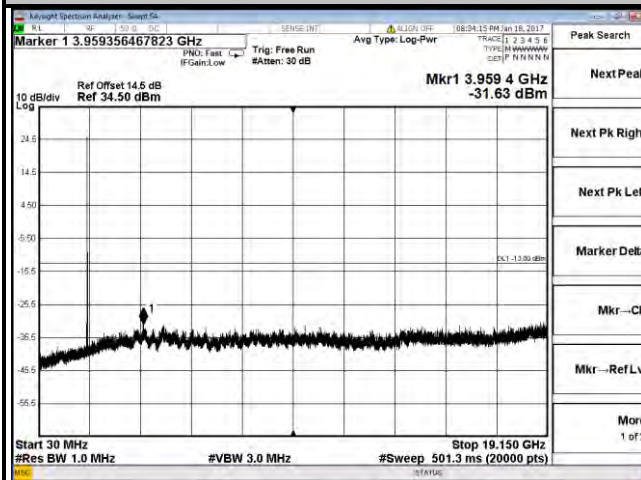

#### Channel 26615

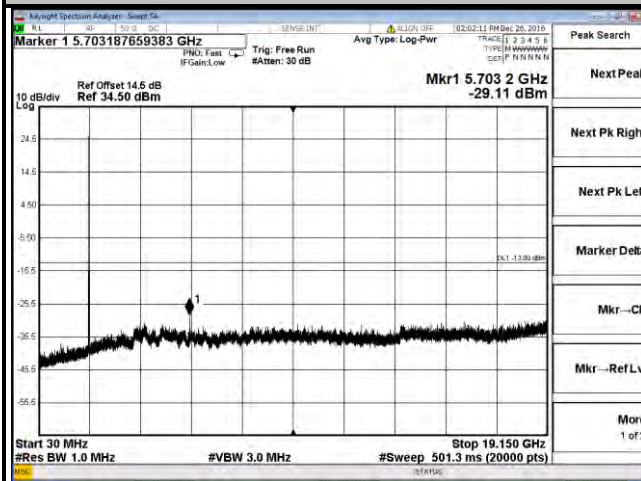

**LTE Band 25**  
**Channel Bandwidth: 20 MHz**

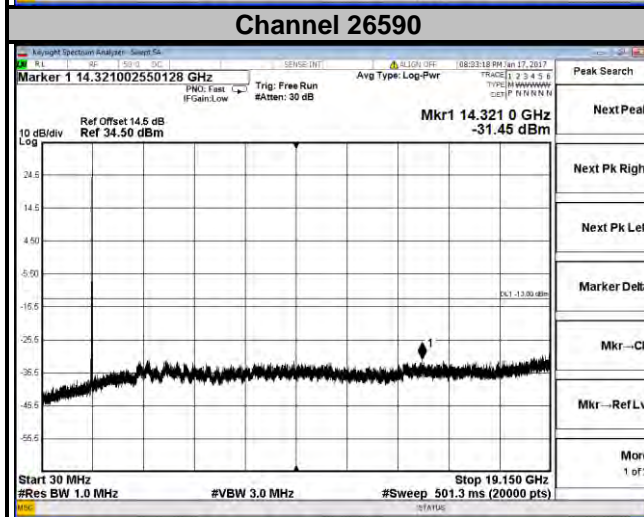
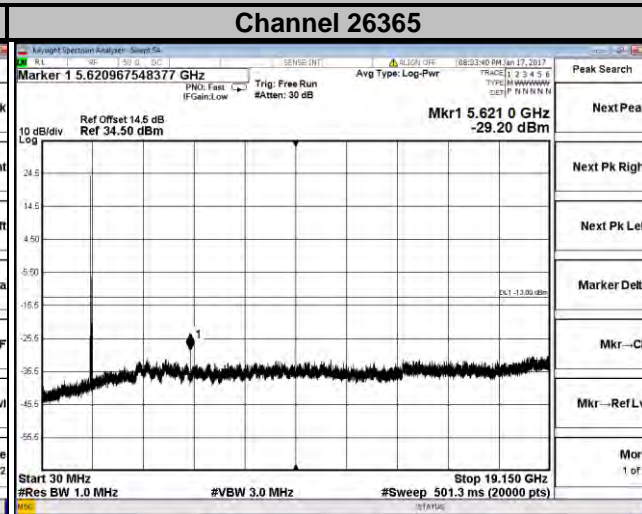
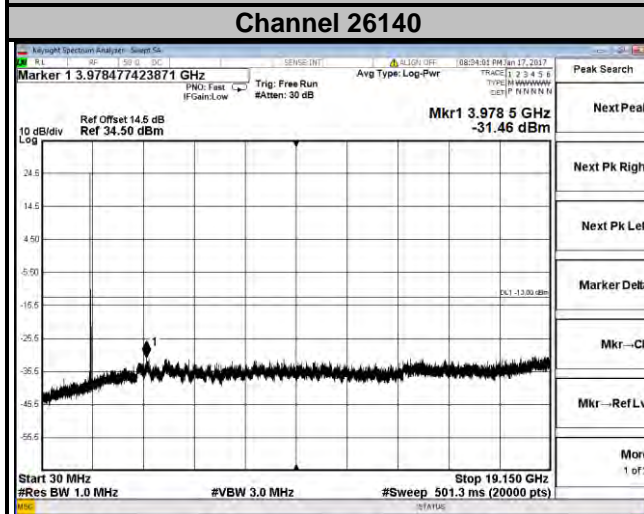

## 4.7 Radiated Emission Measurement

### 4.7.1 Limits of Radiated Emission Measurement

The power of any emission outside of the authorized operating frequency ranges must be attenuated below the transmitting power (P) by a factor of at least  $43 + 10 \log(P)$  dB. The emission limit is equal to  $-13$  dBm.

### 4.7.2 Test Procedure

- Substitution method is used for E.I.R.P measurement. In the semi-anechoic chamber, EUT placed on the 0.8 m height of Turn Table, rotated the table around 360 degrees to search the maximum radiation power and receiver antenna shall be rotated vertical and horizontal polarization and moved height from 1 m to 4 m to find the maximum polar radiated power. The "Read Value" is the spectrum reading the maximum power value.
- The substitution horn antenna is substituted for EUT at the same position and signals generator export the CW signal to the substitution antenna via a TX cable. Rotated the Turn Table and moved receiving antenna to find the maximum radiation power. Adjust output power level of S.G to get a Value of spectrum reading equal to "Read Value" of step a. Record the power level of S.G.
- $EIRP = \text{Output power level of S.G} - \text{TX cable loss} + \text{Antenna gain of substitution horn}$ .
- E.R.P power can be calculated form E.I.R.P power by subtracting the gain of dipole,  $E.R.P \text{ power} = E.I.P.R \text{ power} - 2.15 \text{ dBi}$ .

**NOTE:** The resolution bandwidth and video bandwidth of test receiver/spectrum analyzer is 1 MHz/3 MHz.

### 4.7.3 Deviation from Test Standard

No deviation.

### 4.7.4 Test Setup

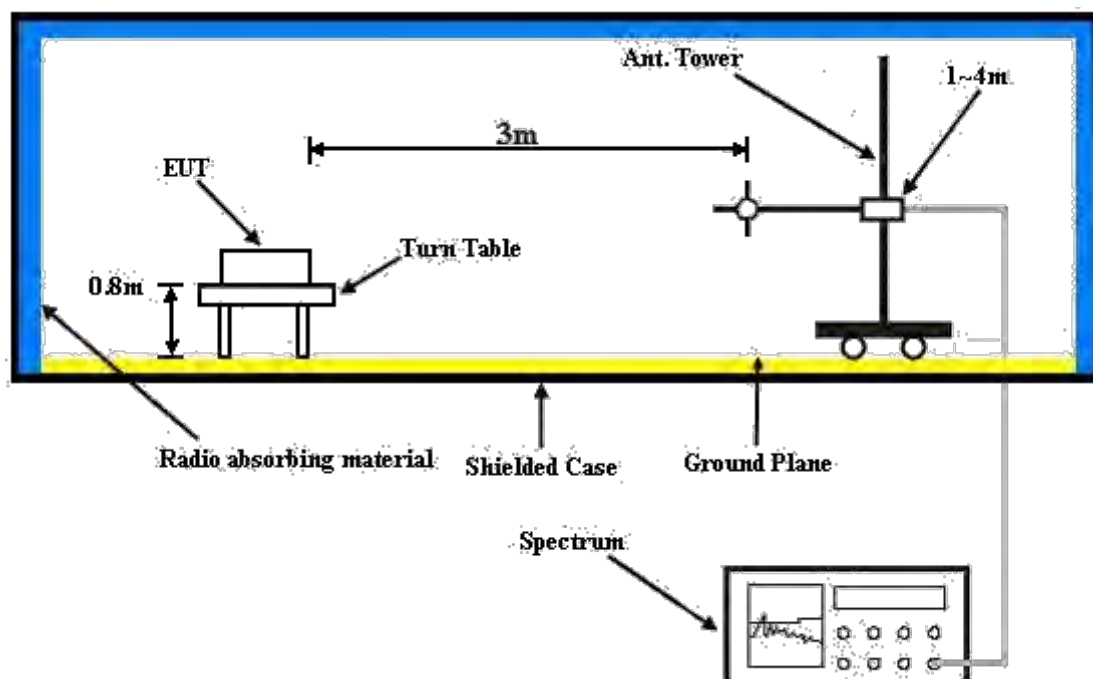

For the actual test configuration, please refer to the attached file (Test Setup Photo).



4.7.5 Test Results

CDMA:

Low Channel



Bureau Veritas Consumer Products Services Ltd., Taoyuan Branch

A D T

Data: 3

Date: 2017-01-17

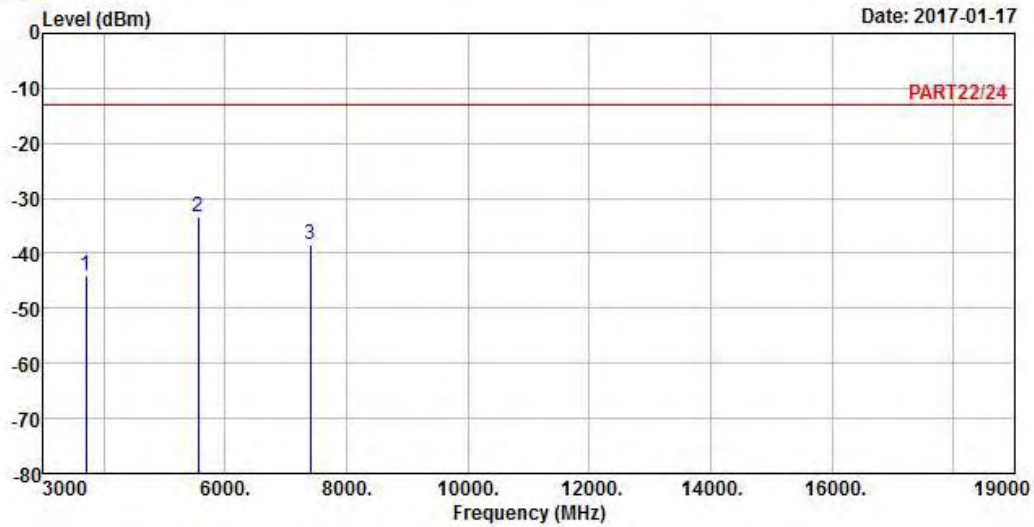

Site : 966 Chamber 5  
 Condition: PART22/24 HORIZONTAL  
 Remak : CDMA BC1\_L-CH  
 Tested by: Gavin Wu

	Freq	Level	Read Level	Limit Line	Over Limit	Factor	Remark
	MHz	dBm	dBm	dBm	dB	dB	
1	3702.50	-44.06	-35.89	-13.00	-31.06	-8.17	Peak
2 pp	5553.75	-33.44	-31.99	-13.00	-20.44	-1.45	Peak
3	7405.00	-38.26	-43.76	-13.00	-25.26	5.50	Peak



Bureau Veritas Consumer Products Services Ltd., Taoyuan Branch

A D T

Data: 4

Date: 2017-01-17

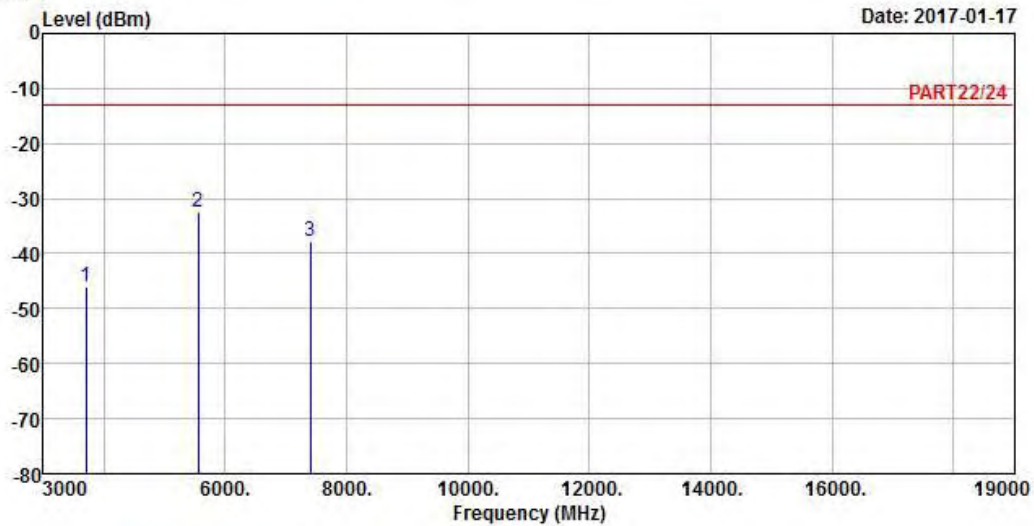

Site : 966 Chamber 5  
 Condition: PART22/24 VERTICAL  
 Remak : CDMA BC1\_L-CH  
 Tested by: Gavin Wu

	Freq	Level	Read Level	Limit Line	Over Limit	Factor	Remark
	MHz	dBm	dBm	dBm	dB	dB	
1	3702.50	-45.97	-37.80	-13.00	-32.97	-8.17	Peak
2 pp	5553.75	-32.36	-30.91	-13.00	-19.36	-1.45	Peak
3	7405.00	-37.71	-43.21	-13.00	-24.71	5.50	Peak

Middle Channel



Bureau Veritas Consumer Products Services Ltd., Taoyuan Branch

A D T

Data: 7

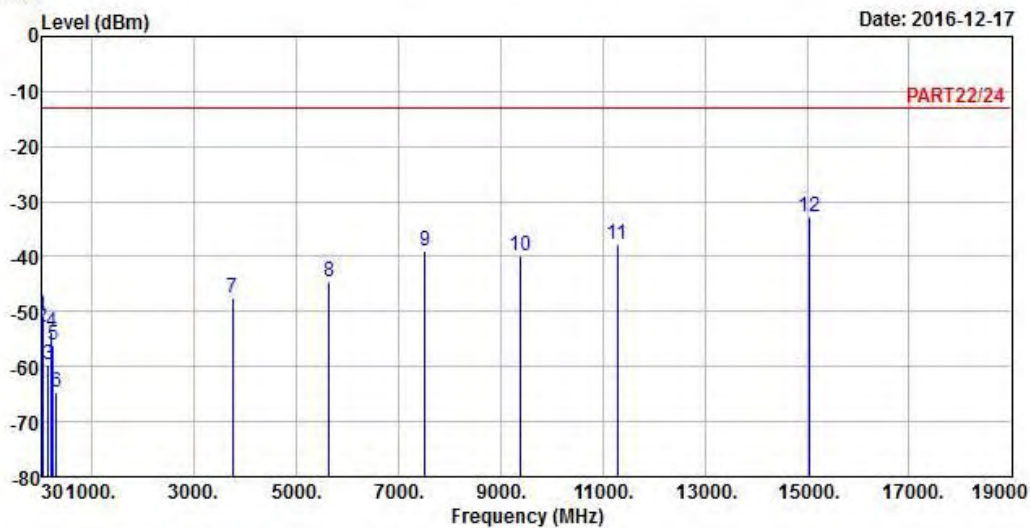

Site : 966 Chamber 5  
 Condition: PART22/24 HORIZONTAL  
 Remak : CDMA BC1\_M-CH  
 Tested by: Gavin Wu

	Freq	Level	Read Level	Limit Line	Over Limit	Factor	Remark
	MHz	dBm	dBm	dBm	dB	dB	
1	30.00	-50.90	-51.28	-13.00	-37.90	0.38	Peak
2	41.64	-52.93	-52.52	-13.00	-39.93	-0.41	Peak
3	142.52	-59.77	-51.41	-13.00	-46.77	-8.36	Peak
4	208.48	-53.85	-46.18	-13.00	-40.85	-7.67	Peak
5	237.58	-56.05	-49.55	-13.00	-43.05	-6.50	Peak
6	300.63	-64.50	-57.50	-13.00	-51.50	-7.00	Peak
7	3760.00	-47.39	-39.33	-13.00	-34.39	-8.06	Peak
8	5640.00	-44.71	-42.77	-13.00	-31.71	-1.94	Peak
9	7520.00	-38.94	-44.53	-13.00	-25.94	5.59	Peak
10	9400.00	-39.90	-47.95	-13.00	-26.90	8.05	Peak
11	11280.00	-37.84	-46.22	-13.00	-24.84	8.38	Peak
12	pp 15040.00	-32.90	-46.97	-13.00	-19.90	14.07	Peak



Bureau Veritas Consumer Products Services Ltd., Taoyuan Branch

A D T

Data: 8

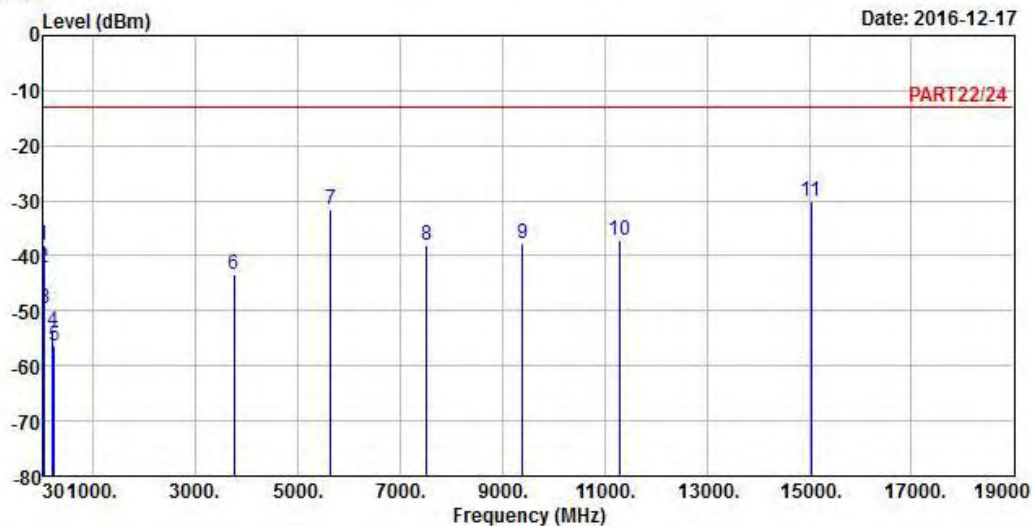

Site : 966 Chamber 5  
 Condition: PART22/24 VERTICAL  
 Remak : CDMA BC1\_M-CH  
 Tested by: Gavin Wu

	Freq	Level	Read Level	Limit Line	Over Limit	Factor	Remark
	MHz	dBm	dBm	dBm	dB	dB	
1	30.00	-37.96	-38.34	-13.00	-24.96	0.38	Peak
2	39.70	-42.07	-42.71	-13.00	-29.07	0.64	Peak
3	53.28	-49.69	-43.88	-13.00	-36.69	-5.81	Peak
4	207.51	-53.79	-46.08	-13.00	-40.79	-7.71	Peak
5	235.64	-56.46	-49.88	-13.00	-43.46	-6.58	Peak
6	3760.00	-43.33	-35.27	-13.00	-30.33	-8.06	Peak
7	5640.00	-31.60	-29.66	-13.00	-18.60	-1.94	Peak
8	7520.00	-37.96	-43.55	-13.00	-24.96	5.59	Peak
9	9400.00	-37.87	-45.92	-13.00	-24.87	8.05	Peak
10	11280.00	-37.07	-45.45	-13.00	-24.07	8.38	Peak
11 pp	15040.00	-30.25	-44.32	-13.00	-17.25	14.07	Peak

High Channel



Bureau Veritas Consumer Products Services Ltd., Taoyuan Branch

A D T

Data: 3

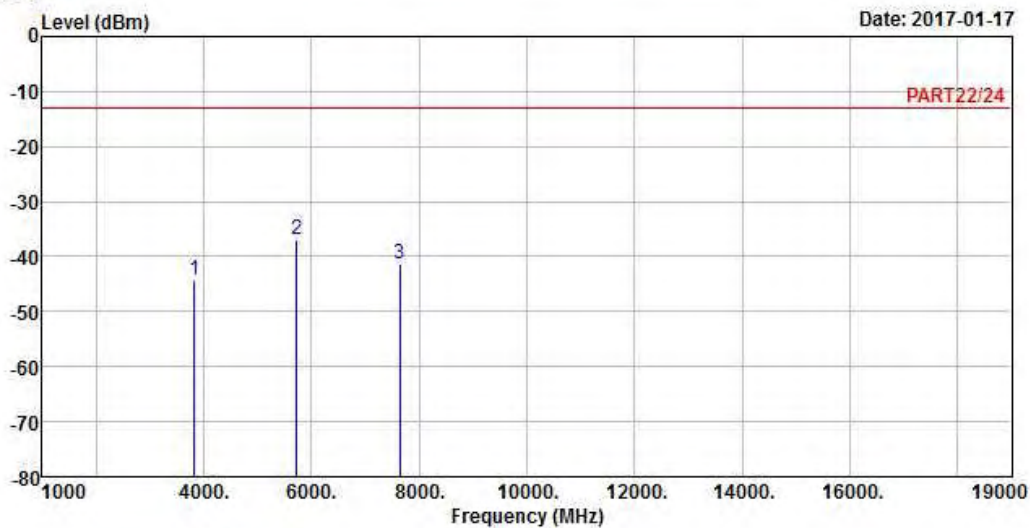

Site : 966 Chamber 5  
 Condition: PART22/24 HORIZONTAL  
 Remak : CDMA BC1\_H-CH  
 Tested by: Gavin Wu

	Freq	Level	Read Level	Limit Line	Over Limit	Factor	Remark
	MHz	dBm	dBm	dBm	dB	dB	
1	3817.50	-44.25	-36.57	-13.00	-31.25	-7.68	Peak
2 pp	5726.25	-36.98	-35.40	-13.00	-23.98	-1.58	Peak
3	7635.00	-41.33	-46.39	-13.00	-28.33	5.06	Peak



Bureau Veritas Consumer Products Services Ltd., Taoyuan Branch

A D T

Data: 4

Date: 2017-01-17

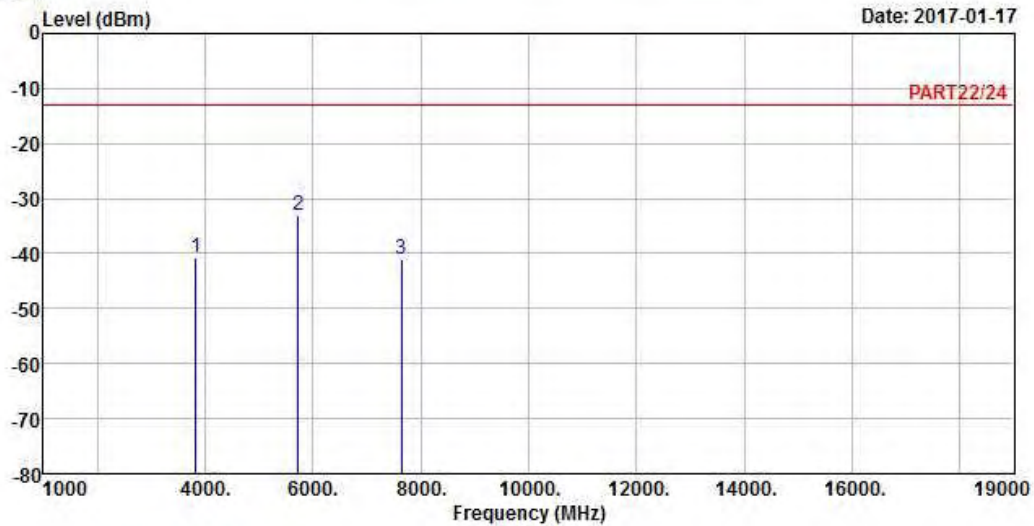

Site : 966 Chamber 5  
 Condition: PART22/24 VERTICAL  
 Remak : CDMA BC1\_H-CH  
 Tested by: Gavin Wu

	Freq	Level	Read Level	Limit Line	Over Limit	Factor	Remark
	MHz	dBm	dBm	dBm	dB	dB	
1	3817.50	-40.68	-33.00	-13.00	-27.68	-7.68	Peak
2 pp	5726.25	-33.14	-31.56	-13.00	-20.14	-1.58	Peak
3	7635.00	-41.02	-46.08	-13.00	-28.02	5.06	Peak

LTE Band 2  
Channel Bandwidth: 20 MHz / QPSK  
Low Channel



Bureau Veritas Consumer Products Services Ltd., Taoyuan Branch

A D T

Data: 3

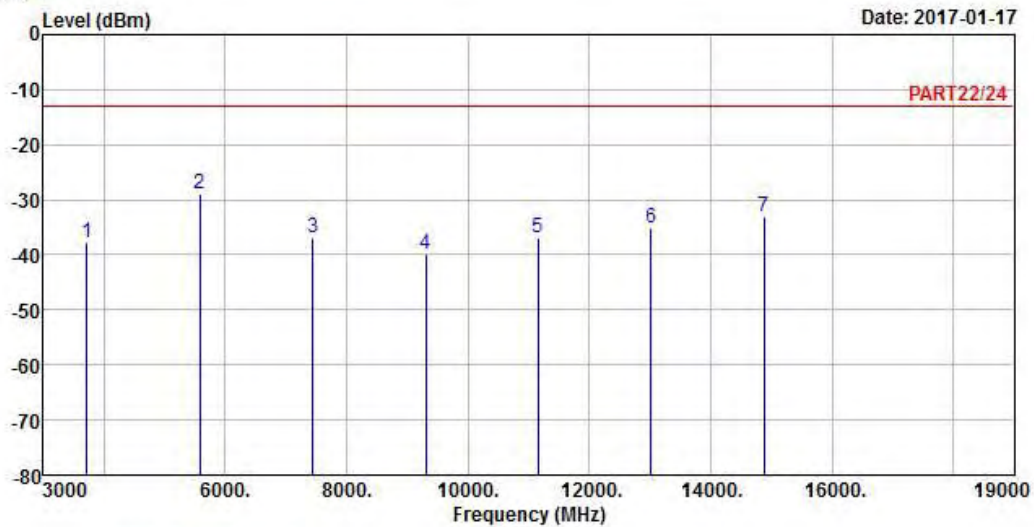

Site : 966 Chamber 5  
Condition: PART22/24 VERTICAL  
Remak : LTE Band II\_QPSK\_20M\_L-CH  
Tested by: Getaz Yang

	Freq	Level	Read Level	Limit	Over	Factor	Remark
	MHz	dBm	dBm	dBm	dB	dB	
1	3720.00	-37.65	-29.52	-13.00	-24.65	-8.13	Peak
2 pp	5580.00	-28.82	-27.27	-13.00	-15.82	-1.55	Peak
3	7440.00	-36.83	-42.39	-13.00	-23.83	5.56	Peak
4	9300.00	-39.80	-47.59	-13.00	-26.80	7.79	Peak
5	11160.00	-36.93	-45.05	-13.00	-23.93	8.12	Peak
6	13020.00	-35.11	-46.61	-13.00	-22.11	11.50	Peak
7	14880.00	-33.19	-45.29	-13.00	-20.19	12.10	Peak



Bureau Veritas Consumer Products Services Ltd., Taoyuan Branch

A D T

Data: 4

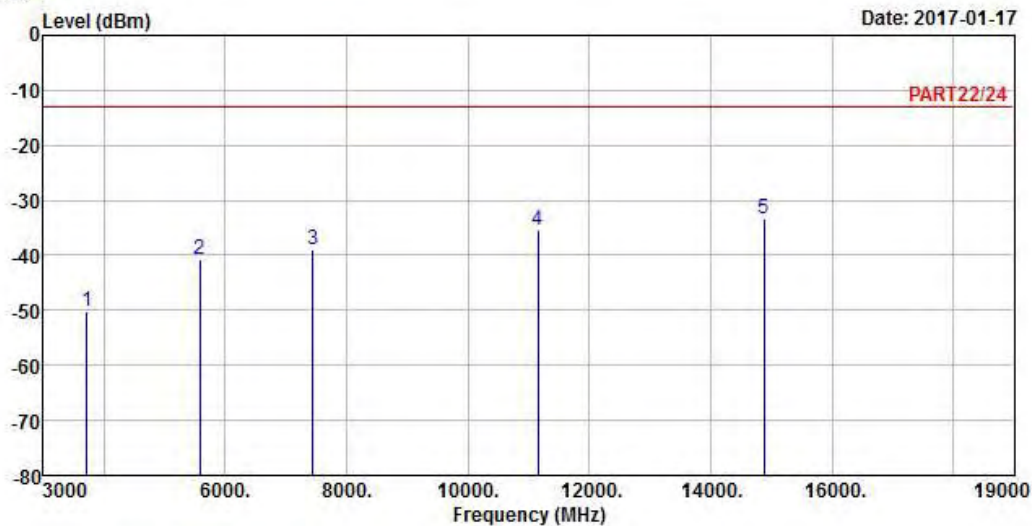

Site : 966 Chamber 5  
 Condition: PART22/24 VERTICAL  
 Remak : LTE Band II\_QPSK\_20M\_L-CH  
 Tested by: Getaz Yang

	Freq	Level	Read Level	Limit Line	Over Limit	Factor	Remark
	MHz	dBm	dBm	dBm	dB	dB	
1	3720.00	-50.32	-42.19	-13.00	-37.32	-8.13	Peak
2	5580.00	-40.74	-39.19	-13.00	-27.74	-1.55	Peak
3	7440.00	-39.02	-44.58	-13.00	-26.02	5.56	Peak
4	11160.00	-35.33	-43.45	-13.00	-22.33	8.12	Peak
5	14880.00	-33.30	-45.40	-13.00	-20.30	12.10	Peak



Middle Channel



Bureau Veritas Consumer Products Services Ltd., Taoyuan Branch

A D T

Data: 7

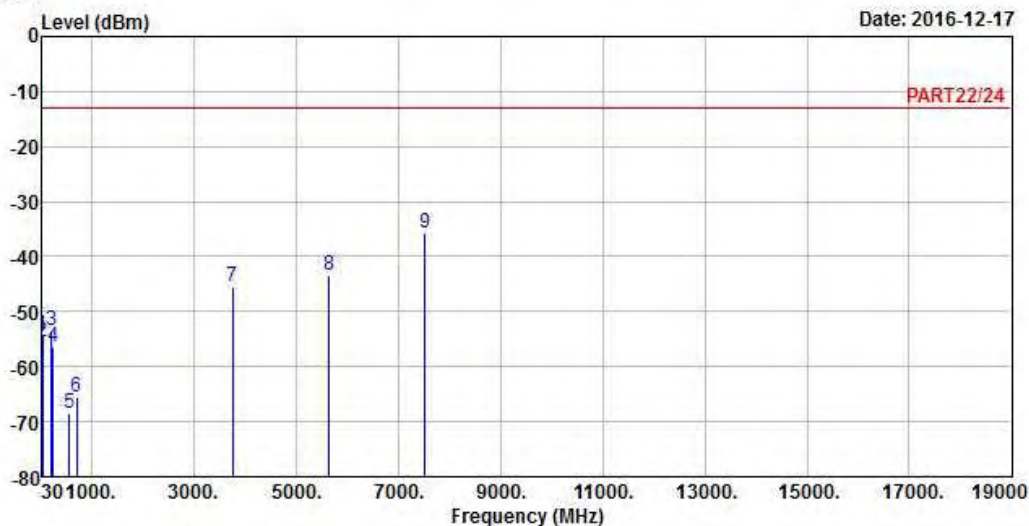

Site : 966 Chamber 5  
 Condition: PART22/24 HORIZONTAL  
 Remak : LTE Band II\_QPSK\_20M\_M-CH  
 Tested by: Getaz Yang

	Freq	Level	Read Level	Limit Line	Over Limit	Factor	Remark
	MHz	dBm	dBm	dBm	dB	dB	
1	32.91	-54.34	-53.25	-13.00	-41.34	-1.09	Peak
2	42.61	-55.41	-54.47	-13.00	-42.41	-0.94	Peak
3	209.45	-53.44	-45.81	-13.00	-40.44	-7.63	Peak
4	236.61	-56.46	-49.92	-13.00	-43.46	-6.54	Peak
5	551.86	-68.54	-65.77	-13.00	-55.54	-2.77	Peak
6	701.24	-65.56	-65.48	-13.00	-52.56	-0.08	Peak
7	3760.00	-45.50	-37.44	-13.00	-32.50	-8.06	Peak
8	5640.00	-43.44	-41.50	-13.00	-30.44	-1.94	Peak
9 pp	7520.00	-35.60	-41.19	-13.00	-22.60	5.59	Peak



Bureau Veritas Consumer Products Services Ltd., Taoyuan Branch

A D T

Data: 8

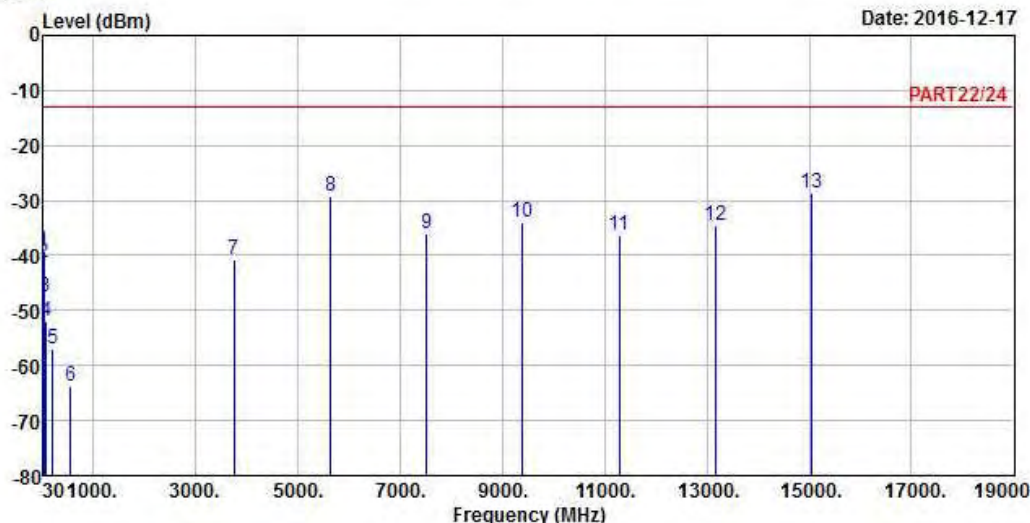

Site : 966 Chamber 5  
 Condition: PART22/24 VERTICAL  
 Remak : LTE Band II\_QPSK\_20M\_M-CH  
 Tested by: Getaz Yang

	Freq	Level	Read Level	Limit Line	Over Limit	Factor	Remark
	MHz	dBm	dBm	dBm	dB	dB	
1	30.00	-39.36	-39.74	-13.00	-26.36	0.38	Peak
2	39.70	-41.21	-41.85	-13.00	-28.21	0.64	Peak
3	53.28	-47.45	-41.64	-13.00	-34.45	-5.81	Peak
4	77.53	-51.94	-41.74	-13.00	-38.94	-10.20	Peak
5	212.36	-56.83	-49.32	-13.00	-43.83	-7.51	Peak
6	565.44	-63.86	-61.66	-13.00	-50.86	-2.20	Peak
7	3760.00	-40.86	-32.80	-13.00	-27.86	-8.06	Peak
8	5640.00	-29.26	-27.32	-13.00	-16.26	-1.94	Peak
9	7520.00	-36.01	-41.60	-13.00	-23.01	5.59	Peak
10	9400.00	-33.92	-41.97	-13.00	-20.92	8.05	Peak
11	11280.00	-36.18	-44.56	-13.00	-23.18	8.38	Peak
12	13160.00	-34.65	-45.56	-13.00	-21.65	10.91	Peak
13	pp 15040.00	-28.61	-42.68	-13.00	-15.61	14.07	Peak

High Channel



Bureau Veritas Consumer Products Services Ltd., Taoyuan Branch

A D T

Data: 3

Date: 2017-01-17

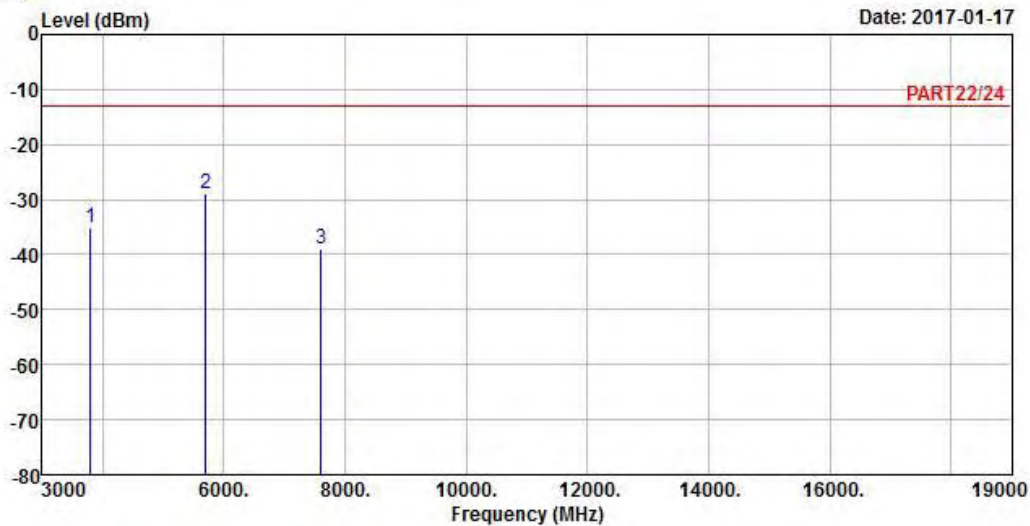

Site : 966 Chamber 5  
 Condition: PART22/24 HORIZONTAL  
 Remak : LTE Band II\_QPSK\_20M\_H-CH  
 Tested by: Getaz Yang

	Freq	Level	Read Level	Limit Line	Over Limit	Factor	Remark
	MHz	dBm	dBm	dBm	dB	dB	
1	3800.00	-35.07	-27.29	-13.00	-22.07	-7.78	Peak
2 pp	5700.00	-29.02	-27.07	-13.00	-16.02	-1.95	Peak
3	7600.00	-38.96	-44.00	-13.00	-25.96	5.04	Peak



Bureau Veritas Consumer Products Services Ltd., Taoyuan Branch

A D T

Data: 4

Date: 2017-01-17

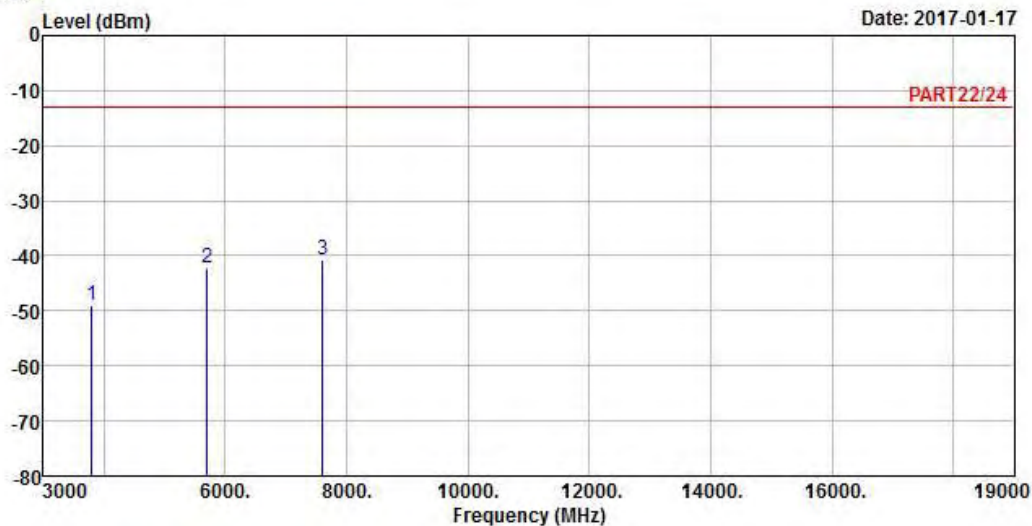

Site : 966 Chamber 5  
 Condition: PART22/24 VERTICAL  
 Remak : LTE Band II\_QPSK\_20M\_H-CH  
 Tested by: Getaz Yang

	Freq	Level	Read Level	Limit Line	Over Limit	Factor	Remark
	MHz	dBm	dBm	dBm	dB	dB	
1	3800.00	-48.98	-41.20	-13.00	-35.98	-7.78	Peak
2	5700.00	-42.14	-40.19	-13.00	-29.14	-1.95	Peak
3 pp	7600.00	-40.66	-45.70	-13.00	-27.66	5.04	Peak

LTE Band 25  
 Channel Bandwidth: 20 MHz / QPSK  
 Low Channel



Bureau Veritas Consumer Products Services Ltd., Taoyuan Branch

A D T

Data: 3

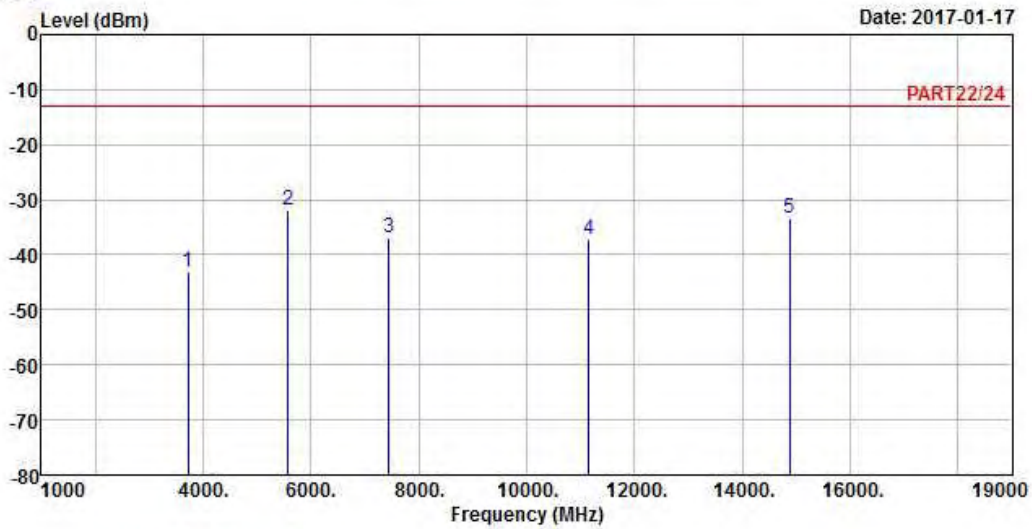

Site : 966 Chamber 5  
 Condition: PART22/24 HORIZONTAL  
 Remak : LTE Band 25\_QPSK\_20M\_L-CH  
 Tested by: Getaz Yang

	Freq	Level	Read Level	Limit Line	Over Limit	Factor	Remark
	MHz	dBm	dBm	dBm	dB	dB	
1	3720.00	-43.18	-35.05	-13.00	-30.18	-8.13	Peak
2 pp	5580.00	-31.91	-30.36	-13.00	-18.91	-1.55	Peak
3	7440.00	-36.87	-42.43	-13.00	-23.87	5.56	Peak
4	11160.00	-37.11	-45.23	-13.00	-24.11	8.12	Peak
5	14880.00	-33.46	-45.56	-13.00	-20.46	12.10	Peak



A D T

Data: 4

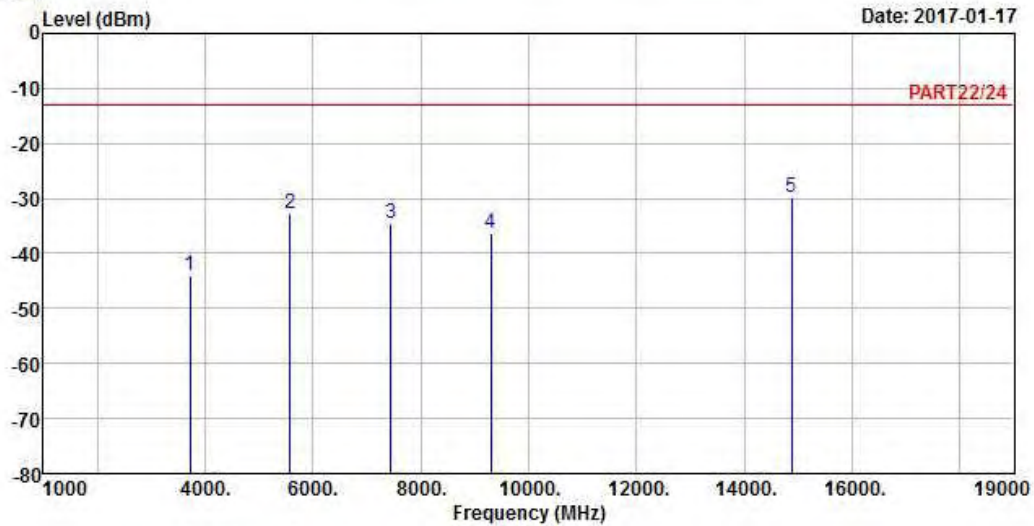

Site : 966 Chamber 5  
 Condition: PART22/24 VERTICAL  
 Remak : LTE Band 25\_QPSK\_20M\_L-CH  
 Tested by: Getaz Yang

	Freq	Level	Read Level	Limit Line	Over Limit	Factor	Remark
	MHz	dBm	dBm	dBm	dB	dB	
1	3720.00	-44.06	-35.93	-13.00	-31.06	-8.13	Peak
2	5580.00	-32.77	-31.22	-13.00	-19.77	-1.55	Peak
3	7440.00	-34.63	-40.19	-13.00	-21.63	5.56	Peak
4	9300.00	-36.21	-44.00	-13.00	-23.21	7.79	Peak
5 pp	14880.00	-29.94	-42.04	-13.00	-16.94	12.10	Peak

Middle Channel



Bureau Veritas Consumer Products Services Ltd., Taoyuan Branch

A D T

Data: 5

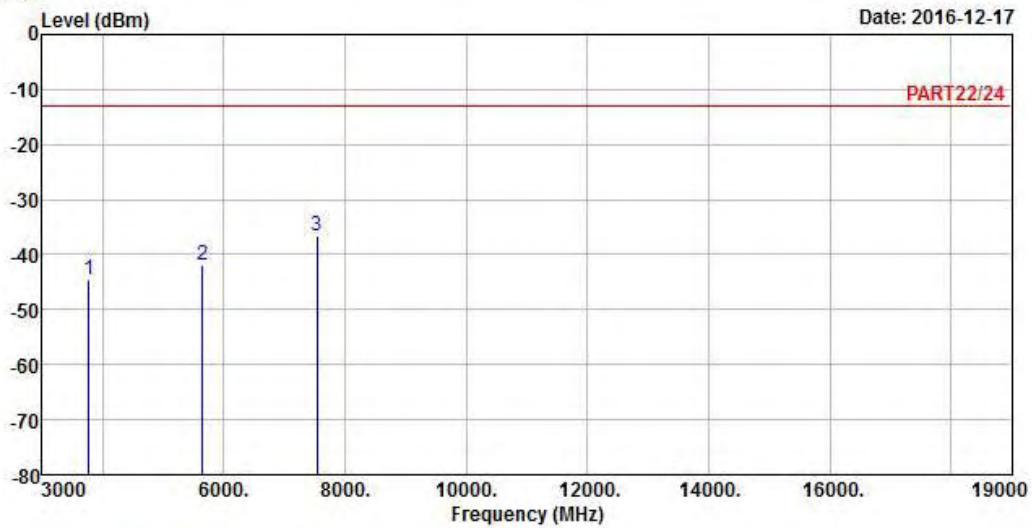

Site : 966 Chamber 5  
 Condition: PART22/24 HORIZONTAL  
 Remak : LTE Band 25\_QPSK\_20M\_M-CH  
 Tested by: Getaz Yang

	Freq	Level	Read Level	Limit Line	Over Limit	Factor	Remark
	MHz	dBm	dBm	dBm	dB	dB	
1	3765.00	-44.44	-36.47	-13.00	-31.44	-7.97	Peak
2	5647.50	-41.98	-40.04	-13.00	-28.98	-1.94	Peak
3 pp	7530.00	-36.51	-41.52	-13.00	-23.51	5.01	Peak



A D T

Data: 6

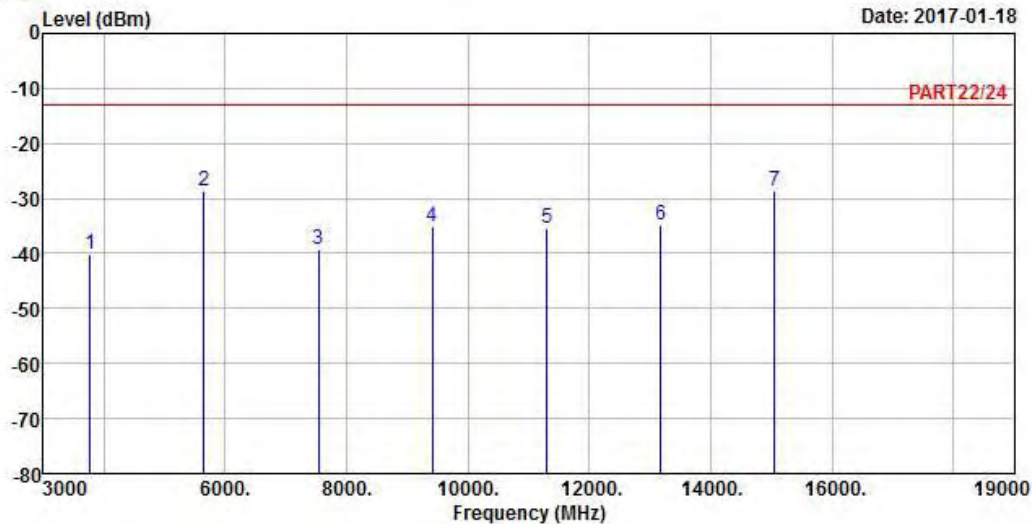

Site : 966 Chamber 5  
 Condition: PART22/24 VERTICAL  
 Remak : LTE Band 25\_QPSK\_20M\_M-CH  
 Tested by: Getaz Yang

	Freq	Level	Read Level	Limit Line	Over Limit	Factor	Remark
	MHz	dBm	dBm	dBm	dB	dB	
1	3765.00	-40.12	-32.15	-13.00	-27.12	-7.97	Peak
2 pp	5647.50	-28.71	-26.77	-13.00	-15.71	-1.94	Peak
3	7530.00	-39.31	-44.32	-13.00	-26.31	5.01	Peak
4	9412.50	-35.03	-43.08	-13.00	-22.03	8.05	Peak
5	11295.00	-35.32	-43.68	-13.00	-22.32	8.36	Peak
6	13177.50	-34.77	-45.74	-13.00	-21.77	10.97	Peak
7	15060.00	-28.78	-42.76	-13.00	-15.78	13.98	Peak



High Channel



Bureau Veritas Consumer Products Services Ltd., Taoyuan Branch

A D T

Data: 5

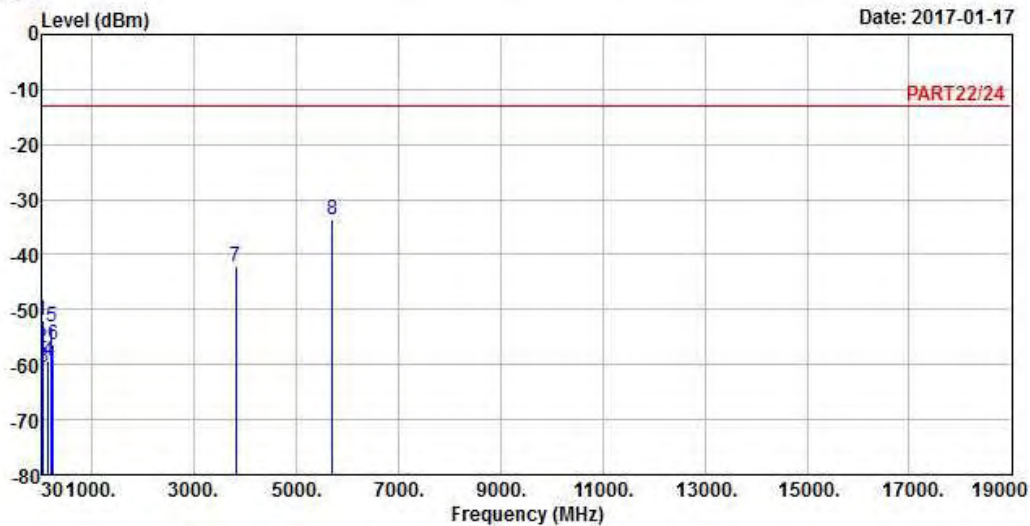

Site : 966 Chamber 5  
 Condition: PART22/24 HORIZONTAL  
 Remak : LTE Band 25\_QPSK\_20M\_H-CH  
 Tested by: Getaz Yang

	Freq	Level	Read Level	Limit Line	Over Limit	Factor	Remark
	MHz	dBm	dBm	dBm	dB	dB	
1	30.00	-51.95	-52.33	-13.00	-38.95	0.38	Peak
2	38.73	-56.91	-57.01	-13.00	-43.91	0.10	Peak
3	53.28	-60.46	-54.65	-13.00	-47.46	-5.81	Peak
4	145.43	-59.42	-51.35	-13.00	-46.42	-8.07	Peak
5	211.39	-53.08	-45.53	-13.00	-40.08	-7.55	Peak
6	234.67	-56.52	-49.90	-13.00	-43.52	-6.62	Peak
7	3810.00	-42.28	-34.50	-13.00	-29.28	-7.78	Peak
8 pp	5715.00	-33.62	-31.86	-13.00	-20.62	-1.76	Peak



Bureau Veritas Consumer Products Services Ltd., Taoyuan Branch

A D T

Data: 6

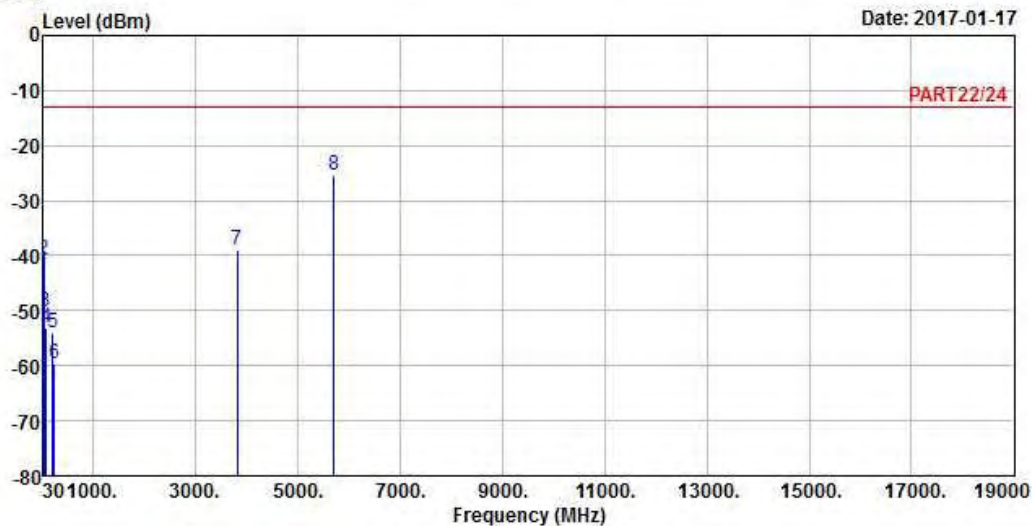

Site : 966 Chamber 5  
 Condition: PART22/24 VERTICAL  
 Remak : LTE Band 25\_QPSK\_20M\_H-CH  
 Tested by: Getaz Yang

	Freq	Level	Read Level	Limit Line	Over Limit	Factor	Remark
	MHz	dBm	dBm	dBm	dB	dB	
1	32.91	-42.73	-41.64	-13.00	-29.73	-1.09	Peak
2	40.67	-40.81	-40.93	-13.00	-27.81	0.12	Peak
3	56.19	-50.07	-43.47	-13.00	-37.07	-6.60	Peak
4	77.53	-53.23	-43.03	-13.00	-40.23	-10.20	Peak
5	204.60	-53.95	-46.12	-13.00	-40.95	-7.83	Peak
6	244.37	-59.58	-53.35	-13.00	-46.58	-6.23	Peak
7	3810.00	-38.96	-31.18	-13.00	-25.96	-7.78	Peak
8 pp	5715.00	-25.32	-23.56	-13.00	-12.32	-1.76	Peak

## 5 Pictures of Test Arrangements

Please refer to the attached file (Test Setup Photo).

## Appendix – Information on the Testing Laboratories

We, Bureau Veritas Consumer Products Services (H.K.) Ltd., Taoyuan Branch, were founded in 1988 to provide our best service in EMC, Radio, Telecom and Safety consultation. Our laboratories are accredited and approved according to ISO/IEC 17025.

If you have any comments, please feel free to contact us at the following:

**Linko EMC/RF Lab**

Tel: 886-2-26052180

Fax: 886-2-26051924

**Hsin Chu EMC/RF/Telecom Lab**

Tel: 886-3-6668565

Fax: 886-3-6668323

**Hwa Ya EMC/RF/Safety**

Tel: 886-3-3183232

Fax: 886-3-3270892

**Email:** [service.adt@tw.bureauveritas.com](mailto:service.adt@tw.bureauveritas.com)

**Web Site:** [www.bureauveritas-adt.com](http://www.bureauveritas-adt.com)

The address and road map of all our labs can be found in our web site also.

--- END ---