

FCC Test Report

(PART 22)

Report No.: RF171027C05-1

FCC ID: XHG-R871A

Test Model: R871

Received Date: Nov. 17, 2016

Test Date: Dec. 17, 2016 ~ Dec. 27, 2016

Issued Date: Nov. 13, 2017

Applicant: Franklin Technology Inc.

Address: 906 JEI Platz, 186, Gasan digital 1-ro, Geumcheon-gu, Seoul, Korea,
(08502)

Issued By: Bureau Veritas Consumer Products Services (H.K.) Ltd., Taoyuan Branch

Lab Address: No. 47-2, 14th Ling, Chia Pau Vil., Lin Kou Dist., New Taipei City, Taiwan
(R.O.C)

Test Location: No. 19, Hwa Ya 2nd Rd, Wen Hwa Tsuen, Kwei Shan Hsiang, Taoyuan
Hsien 333, Taiwan, R.O.C.



This report is for your exclusive use. Any copying or replication of this report to or for any other person or entity, or use of our name or trademark, is permitted only with our prior written permission. This report sets forth our findings solely with respect to the test samples identified herein. The results set forth in this report are not indicative or representative of the quality or characteristics of the lot from which a test sample was taken or any similar or identical product unless specifically and expressly noted. Our report includes all of the tests requested by you and the results thereof based upon the information that you provided to us. You have 60 days from date of issuance of this report to notify us of any material error or omission caused by our negligence, provided, however, that such notice shall be in writing and shall specifically address the issue you wish to raise. A failure to raise such issue within the prescribed time shall constitute your unqualified acceptance of the completeness of this report, the tests conducted and the correctness of the report contents. Unless specific mention, the uncertainty of measurement has been explicitly taken into account to declare the compliance or non-compliance to the specification. The report must not be used by the client to claim product certification, approval, or endorsement by TAF or any government agencies

Table of Contents

Release Control Record	3
1 Certificate of Conformity	4
2 Summary of Test Results	5
2.1 Measurement Uncertainty	5
2.2 Test Site and Instruments	6
3 General Information	7
3.1 General Description of EUT	7
3.2 Configuration of System under Test	8
3.2.1 Description of Support Units	8
3.3 Test Mode Applicability and Tested Channel Detail	9
3.4 EUT Operating Conditions	11
3.5 General Description of Applied Standards	11
4 Test Types and Results	12
4.1 Output Power Measurement	12
4.1.1 Limits of Output Power Measurement	12
4.1.2 Test Procedures	12
4.1.3 Test Setup	13
4.1.4 Test Results	14
4.2 Frequency Stability Measurement	19
4.2.1 Limits of Frequency Stability Measurement	19
4.2.2 Test Procedure	19
4.2.3 Test Setup	19
4.2.4 Test Results	20
4.3 Occupied Bandwidth Measurement	23
4.3.1 Test Procedure	23
4.3.2 Test Setup	23
4.3.3 Test Result	24
4.4 Band Edge Measurement	27
4.4.1 Limits of Band Edge Measurement	27
4.4.2 Test Setup	27
4.4.3 Test Procedures	27
4.4.4 Test Results	28
4.5 Peak to Average Ratio	32
4.5.1 Limits of Peak to Average Ratio Measurement	32
4.5.2 Test Setup	32
4.5.3 Test Procedures	32
4.5.4 Test Results	33
4.6 Conducted Spurious Emissions	36
4.6.1 Limits of Conducted Spurious Emissions Measurement	36
4.6.2 Test Setup	36
4.6.3 Test Procedure	36
4.6.4 Test Results	37
4.7 Radiated Emission Measurement	42
4.7.1 Limits of Radiated Emission Measurement	42
4.7.2 Test Procedure	42
4.7.3 Deviation from Test Standard	42
4.7.4 Test Setup	42
4.7.5 Test Results	43
5 Pictures of Test Arrangements	55
Appendix – Information on the Testing Laboratories	56

Release Control Record

Issue No.	Description	Date Issued
RF171027C05-1	Original Release	Nov. 13, 2017

1 Certificate of Conformity

Product: Mobile Hotspot

Brand: Franklin

Test Model: R871

Sample Status: Production Unit

Applicant: Franklin Technology Inc.

Test Date: Dec. 17, 2016 ~ Dec. 27, 2016

Standards: FCC Part 22, Subpart H

The above equipment has been tested by **Bureau Veritas Consumer Products Services (H.K.) Ltd., Taoyuan Branch**, and found compliance with the requirement of the above standards. The test record, data evaluation & Equipment Under Test (EUT) configurations represented herein are true and accurate accounts of the measurements of the sample's EMC characteristics under the conditions specified in this report.

Prepared by : Gina Liu , **Date:** Nov. 13, 2017
Gina Liu / Specialist

Approved by : Dylan Chiou , **Date:** Nov. 13, 2017
Dylan Chiou / Project Engineer

2 Summary of Test Results

Applied Standard: FCC Part 22 & Part 2			
FCC Clause	Test Item	Result	Remarks
2.1046 22.913 (a)	Effective Radiated Power	Pass	Meet the requirement of limit.
---	Peak to Average Ratio	Pass	Meet the requirement of limit.
2.1055 22.355	Frequency Stability	Pass	Meet the requirement of limit.
2.1049	Occupied Bandwidth	Pass	Meet the requirement of limit.
22.917	Band Edge Measurements	Pass	Meet the requirement of limit.
2.1051 22.917	Conducted Spurious Emissions	Pass	Meet the requirement of limit.
2.1053 22.917	Radiated Spurious Emissions	Pass	Meet the requirement of limit. Minimum passing margin is -22.18 dB at 6691.20 MHz.

2.1 Measurement Uncertainty

Where relevant, the following measurement uncertainty levels have been estimated for tests performed on the EUT as specified in CISPR 16-4-2:

Measurement	Frequency	Expanded Uncertainty (k=2) (±)
Conducted Emissions at mains ports	150 kHz ~ 30 MHz	2.44 dB
Radiated Emissions up to 1 GHz	30 MHz ~ 200 MHz	2.93 dB
	200 MHz ~ 1000 MHz	2.95 dB
Radiated Emissions above 1 GHz	1 GHz ~ 18 GHz	2.26 dB
	18 GHz ~ 40 GHz	1.94 dB

2.2 Test Site and Instruments

Description & Manufacturer	Model No.	Serial No.	Date of Calibration	Due Date of Calibration
Test Receiver Agilent	N9038A	MY51210203	Jan. 21, 2016	Jan. 20, 2017
Spectrum Analyzer Agilent	N9010A	MY52220314	Dec. 16, 2016	Dec. 15, 2017
Spectrum Analyzer ROHDE & SCHWARZ	FSU43	101261	Dec. 13, 2016	Dec. 12, 2017
BILOG Antenna SCHWARZBECK	VULB9168	9168-472	Jan. 07, 2016	Jan. 06, 2017
HORN Antenna SCHWARZBECK	BBHA 9120 D	9120D-969	Jan. 04, 2016	Jan. 03, 2017
Double Ridge Guide Horn Antenna EMCO	3115	5619	Jan. 04, 2016	Jan. 03, 2017
BILOG Antenna SCHWARZBECK	VULB 9168	9168-153	Jan. 07, 2016	Jan. 06, 2017
Fixed Attenuator Mini-Circuits	BW-N10W5+	NA	Jul. 08, 2016	Jul. 07, 2017
MXG Vector signal generator Agilent	N5182B	MY53050430	Oct. 19, 2016	Oct. 18, 2017
Preamplifier EMCI	EMC 012645	980115	Oct. 21, 2016	Oct. 20, 2017
Preamplifier EMCI	EMC 184045	980116	Oct. 21, 2016	Oct. 20, 2017
Preamplifier EMCI	EMC 330H	980112	Oct. 21, 2016	Oct. 20, 2017
Power Meter Anritsu	ML2495A	1232002	Sep. 08, 2016	Sep. 07, 2017
Power Sensor Anritsu	MA2411B	1207325	Sep. 08, 2016	Sep. 07, 2017
RF signal cable HUBER+SUHNNER	SUCOFLEX 104	309219/4 2950114	Oct. 21, 2016	Oct. 20, 2017
RF signal cable HUBER+SUHNNER	SUCOFLEX 104	250130/4	Oct. 21, 2016	Oct. 20, 2017
RF Coaxial Cable Worken	8D-FB	Cable-Ch10-01	Oct. 21, 2016	Oct. 20, 2017
Software BV ADT	E3 6.120103	NA	NA	NA
Antenna Tower MF	MFA-440H	NA	NA	NA
Turn Table MF	MFT-201SS	NA	NA	NA
Antenna Tower & Turn Table Controller MF	MF-7802	NA	NA	NA
Fixed Attenuator Mini-Circuits	BW-N10W5+	NA	Jul. 08, 2016	Jul. 07, 2017
Radio Communication Analyzer	MT8820C	6201300640	Aug. 10, 2015	Aug. 09, 2017
Communications Tester-Wireless	8960 Series 10	MY53201073	Jul. 03, 2015	Jul. 02, 2017

- Note:
1. The calibration interval of the above test instruments is 12 / 24 months and the calibrations are traceable to NML/ROC and NIST/USA.
 2. The test was performed in HwaYa Chamber 10.
 3. The horn antenna and preamplifier (model: EMC 184045) are used only for the measurement of emission frequency above 1 GHz if tested.
 4. The FCC Designation Number is TW0003. The number will be varied with the Lab location and scope as attached.
 5. The IC Site Registration No. is IC7450F-10.

3 General Information

3.1 General Description of EUT

Product	Mobile Hotspot	
Brand	Franklin	
Test Model	R871	
Status of EUT	Production Unit	
Power Supply Rating	5.0 Vdc (adapter or host equipment) 3.8 Vdc (Li-ion battery)	
Modulation Type	CDMA	QPSK, OPQKS, HPSK
	LTE	QPSK, 16QAM
Frequency Range	CDMA	824.7 ~ 848.31 MHz
	LTE 5 (Channel Bandwidth: 1.4 MHz)	824.7 ~ 848.3 MHz
	LTE 5 (Channel Bandwidth: 3 MHz)	825.5 ~ 847.5 MHz
	LTE 5 (Channel Bandwidth: 5 MHz)	826.5 ~ 846.5 MHz
	LTE 5 (Channel Bandwidth: 10 MHz)	829 ~ 844 MHz
Max. ERP Power	CDMA	93.54 mW
	LTE 5 (Channel Bandwidth: 1.4 MHz)	110.15 mW
	LTE 5 (Channel Bandwidth: 3 MHz)	113.50 mW
	LTE 5 (Channel Bandwidth: 5 MHz)	115.61 mW
	LTE 5 (Channel Bandwidth: 10 MHz)	118.58 mW
Emission Designator	CDMA	1M28F9W
	LTE 5 (Channel Bandwidth: 1.4 MHz)	1M09W7D
	LTE 5 (Channel Bandwidth: 3 MHz)	2M71G7D
	LTE 5 (Channel Bandwidth: 5 MHz)	4M51G7D
	LTE 5 (Channel Bandwidth: 10 MHz)	8M98G7D
Antenna Type	Fixed Internal Antenna	
Accessory Device	Refer to Note as below	
Data Cable Supplied	Refer to Note as below	

Note:

1. The EUT contains following accessory devices.

Product	Brand	Model	Description
Adapter	Franklin Wireless	FWCR900TVL	I/P: 100-240 Vac, 0.3 A O/P: 5 Vdc, 1.0 A 1.5 m cable non-shielded cable w/o core
Battery	Franklin Wireless	R850	3.8 Vdc, 2450 mAh

2. The above EUT information is declared by manufacturer and for more detailed features description, please refer to the manufacturer's specifications or user's manual.

3.2 Configuration of System under Test

<Radiated Emission Test>

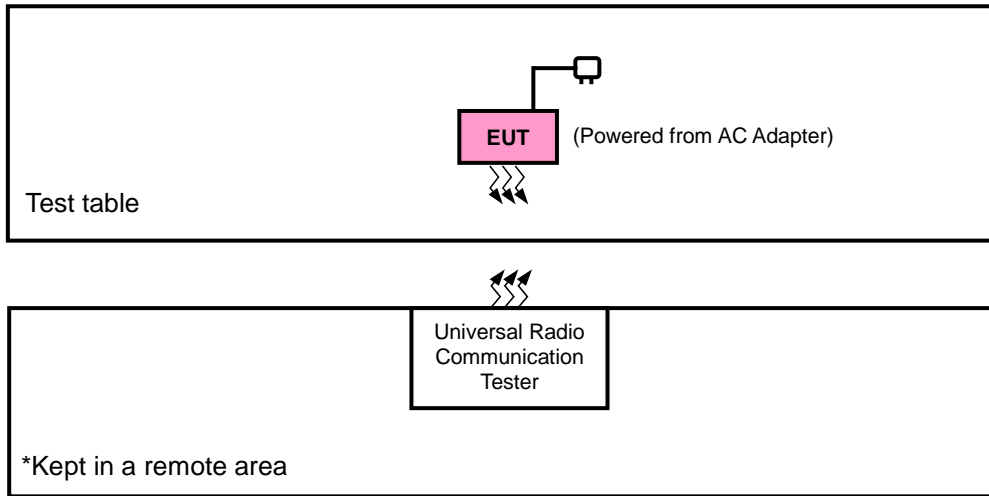

<E.R.P. Test>

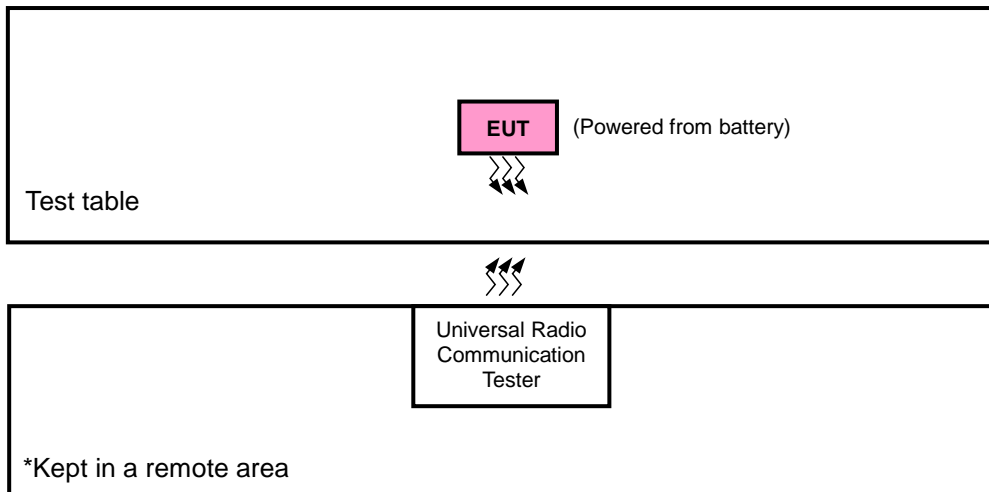

3.2.1 Description of Support Units

The EUT has been tested as an independent unit together with other necessary accessories or support units.

3.3 Test Mode Applicability and Tested Channel Detail

Pre-Scan has been conducted to determine the worst-case mode from all possible combinations between available modulations, data rates, XYZ axis, and antenna ports.

The worst case was found when positioned as the table below. Following channel(s) was (were) selected for the final test as listed below:

Band	ERP	Radiated Emission
CDMA	Y-plane	Y-axis
LTE Band 5	Y-plane	Z-axis

CDMA

EUT Configure Mode	Test Item	Available Channel	Tested Channel	Mode
-	ERP	1013 to 777	1013, 384, 777	1xEVDO
-	Frequency Stability	1013 to 777	384	1xEVDO
-	Occupied Bandwidth	1013 to 777	1013, 384, 777	1xEVDO
-	Band Edge	1013 to 777	1013, 777	1xEVDO
-	Peak to Average Ratio	1013 to 777	1013, 384, 777	1xEVDO
-	Condcudeted Emission	1013 to 777	1013, 384, 777	1xEVDO
-	Radiated Emission	1013 to 777	1013, 384, 777	1xEVDO

LTE Band 5

EUT Configure Mode	Test Item	Available Channel	Tested Channel	Channel Bandwidth	Modulation	Mode
-	ERP	20407 to 20643	20407, 20525, 20643	1.4 MHz	QPSK	1 RB / 0 RB Offset
					16QAM	3 RB / 1 RB Offset
		20415 to 20635	20415, 20525, 20635	3 MHz	QPSK	1 RB / 0 RB Offset
					16QAM	1 RB / 7 RB Offset
		20425 to 20625	20425, 20525, 20625	5 MHz	QPSK	1 RB / 0 RB Offsett
					16QAM	1 RB / 12 RB Offset
20450 to 20600	20450, 20525, 20600	10 MHz	QPSK	1 RB / 0 RB Offset		
16QAM	1 RB / 0 RB Offset					
-	Frequency Stability	20407 to 20643	20525	1.4 MHz	QPSK	1 RB / 0 RB Offset
		20415 to 20635	20525	3 MHz	QPSK	1 RB / 0 RB Offset
		20425 to 20625	20525	5 MHz	QPSK	1 RB / 0 RB Offsett
		20450 to 20600	20525	10 MHz	QPSK	1 RB / 0 RB Offset

EUT Configure Mode	Test Item	Available Channel	Tested Channel	Channel Bandwidth	Modulation	Mode		
-	Occupied Bandwidth	20407 to 20643	20407, 20525, 20643	1.4 MHz	QPSK, 16QAM	6 RB / 0 RB Offset		
		20415 to 20635	20415, 20525, 20635	3 MHz	QPSK, 16QAM	15 RB / 0 RB Offset		
		20425 to 20625	20425, 20525, 20625	5 MHz	QPSK, 16QAM	25 RB / 0 RB Offset		
		20450 to 20600	20450, 20525, 20600	10 MHz	QPSK, 16QAM	50 RB / 0 RB Offset		
-	Band Edge	20407 to 20643	20407	1.4MHz	QPSK	1 RB / 0 RB Offset 6 RB / 0 RB Offset		
			20643	1.4MHz	QPSK	1 RB / 5 RB Offset 6 RB / 0 RB Offset		
		20415 to 20635	20415	3 MHz	QPSK	1 RB / 0 RB Offset 15 RB / 0 RB Offset		
			20635	3 MHz	QPSK	1 RB / 14 RB Offset 15 RB / 0 RB Offset		
		20425 to 20625	20425	5 MHz	QPSK	1 RB / 0 RB Offset 25 RB / 0 RB Offset		
			20625	5 MHz	QPSK	1 RB / 24 RB Offset 25 RB / 0 RB Offset		
		20450 to 20600	20450	10 MHz	QPSK	1 RB / 0 RB Offset 50 RB / 0 RB Offset		
			20600	10 MHz	QPSK	1 RB / 49 RB Offset 50 RB / 0 RB Offset		
		-	Peak to Average Ratio	20407 to 20643	20407, 20525, 20643	1.4 MHz	QPSK	1 RB / 0 RB Offset
							16QAM	3 RB / 1 RB Offset
				20415 to 20635	20415, 20525, 20635	3 MHz	QPSK	1 RB / 0 RB Offset
							16QAM	1 RB / 7 RB Offset
20425 to 20625	20425, 20525, 20625			5 MHz	QPSK	1 RB / 0 RB Offset		
					16QAM	1 RB / 12 RB Offset		
20450 to 20600	20450, 20525, 20600	10 MHz	QPSK	1 RB / 0 RB Offset				
			16QAM	1 RB / 0 RB Offset				
-	Conducted Emission	20407 to 20643	20407, 20525, 20643	1.4 MHz	QPSK	1 RB / 0 RB Offset		
		20415 to 20635	20415, 20525, 20635	3 MHz	QPSK	1 RB / 0 RB Offset		
		20425 to 20625	20425, 20525, 20625	5 MHz	QPSK	1 RB / 0 RB Offset		
		20450 to 20600	20450, 20525, 20600	10 MHz	QPSK	1 RB / 0 RB Offset		
-	Radiated Emission	20450 to 20600	20450, 20525, 20600	10 MHz	QPSK	1 RB / 0 RB Offset		

Note: This device was tested under all bandwidths, RB configurations and modulations. The worst case was found in QPSK modulation.

Test Condition:

Test Item	Environmental Conditions	Input Power	Tested By
ERP	25 deg. C, 65 % RH	3.8 Vdc	Gavin Wu
Frequency Stability	25 deg. C, 65 % RH	3.8 Vdc	Carlos Chen
Occupied Bandwidth	25 deg. C, 65 % RH	3.8 Vdc	Carlos Chen
Band Edge	25 deg. C, 65 % RH	3.8 Vdc	Carlos Chen
Peak to Average Ratio	25 deg. C, 65 % RH	3.8 Vdc	Carlos Chen
Condcudeted Emission	25 deg. C, 65 % RH	3.8 Vdc	Carlos Chen
Radiated Emission	25 deg. C, 65 % RH	120 Vac, 60 Hz	Gavin Wu

3.4 EUT Operating Conditions

The EUT makes a call to the communication simulator. The communication simulator station system controlled a EUT to export maximum output power under transmission mode and specific channel frequency.

3.5 General Description of Applied Standards

The EUT is a RF Product. According to the specifications of the manufacturer, it must comply with the requirements of the following standards:

FCC 47 CFR Part 2

FCC 47 CFR Part 22

KDB 971168 D01 Power Meas License Digital Systems v02r02

ANSI/TIA/EIA-603-D 2010

Note: All test items have been performed and recorded as per the above standards.

4 Test Types and Results

4.1 Output Power Measurement

4.1.1 Limits of Output Power Measurement

Mobile / Portable station are limited to 7 watts e.r.p.

4.1.2 Test Procedures

EIRP / ERP Measurement:

- a. All measurements were done at low, middle and high operational frequency range. RBW and VBW is 5 MHz for CDMA and 10 MHz for LTE mode.
- b. Substitution method is used for E.I.R.P measurement. In the semi-anechoic chamber, EUT placed on the 0.8 m height of Turn Table, rotated the table around 360 degrees to search the maximum radiation power and receiver antenna shall be rotated vertical and horizontal polarization and moved height from 1 m to 4 m to find the maximum polar radiated power. The "Read Value" is the spectrum reading the maximum power value.
- c. The substitution horn antenna is substituted for EUT at the same position and signals generator export the CW signal to the substitution antenna via a tx cable. Rotated the Turn Table and moved receiving antenna to find the maximum radiation power. Adjust output power level of S.G to get a Value of spectrum reading equal to "Read Value" of step b. Record the power level of S.G.
- d. $EIRP = \text{Output power level of S.G} - \text{TX cable loss} + \text{Antenna gain of substitution horn}$. E.R.P power can be calculated form E.I.R.P power by subtracting the gain of dipole, $E.R.P \text{ power} = E.I.P.R \text{ power} - 2.15 \text{ dBi}$.

Conducted Power Measurement:

The EUT was set up for the maximum power with CDMA and LTE link data modulation and link up with simulator. Set the EUT to transmit under low, middle and high channel and record the power level shown on simulator.

4.1.3 Test Setup

EIRP / ERP Measurement:

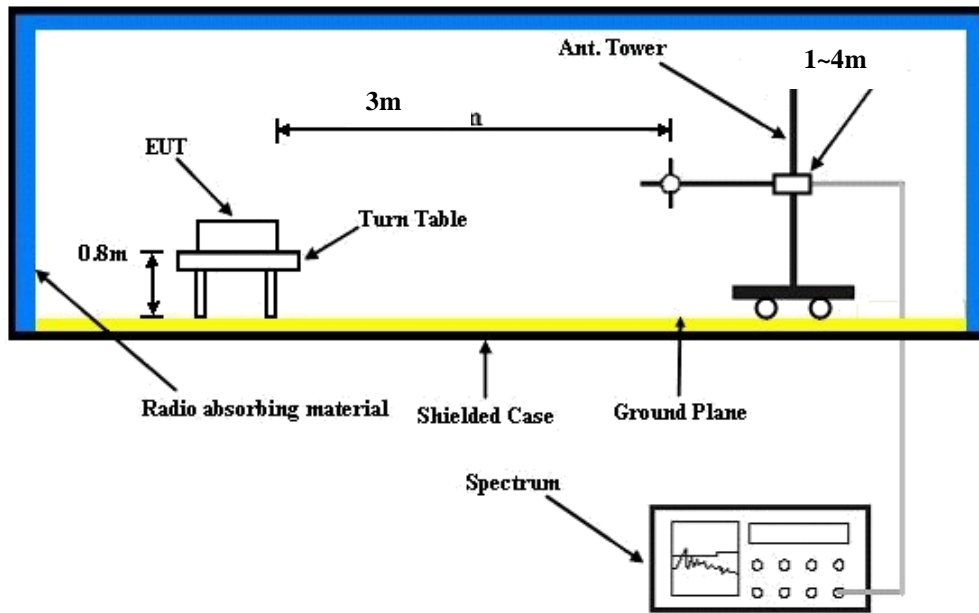

For the actual test configuration, please refer to the attached file (Test Setup Photo).

Conducted Power Measurement:

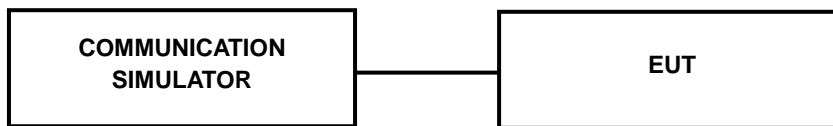

4.1.4 Test Results

Conducted Output Power (dBm)

Band	CDMA		
	1013	384	777
Channel	824.70	836.52	848.31
Frequency (MHz)	824.70	836.52	848.31
RC1+SO55	23.75	23.71	23.71
RC3+SO55	23.38	23.17	23.27
RC3+SO32(+ F-SCH)	23.22	23.20	23.27
RC3+SO32(+SCH)	23.41	23.21	23.40
RTAP 153.6	23.79	23.68	23.52
RETAP 4096	23.37	23.38	23.33

Band / BW	RB Size	RB Offset	QPSK			3GPP MPR (dB)	16QAM			3GPP MPR (dB)
			Low Ch 20407	Mid Ch 20525	High Ch 20643		Low Ch 20407	Mid Ch 20525	High Ch 20643	
			824.7 MHz	836.5 MHz	848.3 MHz		824.7 MHz	836.5 MHz	848.3 MHz	
5 / 1.4M	1	0	23.91	23.92	23.89	0	22.52	22.48	22.63	1
	1	2	23.87	23.80	23.77	0	22.65	22.53	22.59	1
	1	5	23.89	23.80	23.87	0	22.52	22.28	22.56	1
	3	0	23.84	23.76	23.70	0	22.42	22.53	22.57	1
	3	1	23.87	23.87	23.77	0	22.38	22.65	22.71	1
	3	3	23.83	23.79	23.73	0	22.37	22.56	22.58	1
	6	0	22.78	22.59	22.70	1	21.57	21.47	21.47	2

Band / BW	RB Size	RB Offset	QPSK			3GPP MPR (dB)	16QAM			3GPP MPR (dB)
			Low Ch 20415	Mid Ch 20525	High Ch 20635		Low Ch 20415	Mid Ch 20525	High Ch 20635	
			825.5 MHz	836.5 MHz	847.5 MHz		825.5 MHz	836.5 MHz	847.5 MHz	
5 / 3M	1	0	23.96	23.85	23.95	0	22.47	22.23	22.33	1
	1	7	23.91	23.75	23.82	0	22.53	21.99	22.22	1
	1	14	23.87	23.72	23.85	0	22.46	22.33	22.33	1
	8	0	22.85	22.64	22.78	1	21.56	21.13	21.69	2
	8	3	22.78	22.63	22.82	1	21.54	21.39	21.68	2
	8	7	22.63	22.67	22.76	1	21.47	21.83	21.67	2
	15	0	22.67	22.57	22.68	1	21.46	21.53	21.53	2

Band / BW	RB Size	RB Offset	QPSK			3GPP MPR (dB)	16QAM			3GPP MPR (dB)
			Low Ch 20425	Mid Ch 20525	High Ch 20625		Low Ch 20425	Mid Ch 20525	High Ch 20625	
			826.5 MHz	836.5 MHz	846.5 MHz		826.5 MHz	836.5 MHz	846.5 MHz	
5 / 5M	1	0	23.88	23.82	23.96	0	22.49	22.40	22.44	1
	1	12	23.79	23.72	23.63	0	22.70	22.03	22.50	1
	1	24	23.72	23.63	23.72	0	22.38	21.83	22.24	1
	12	0	22.63	22.61	22.61	1	21.38	21.33	21.45	2
	12	6	22.69	22.60	22.71	1	21.48	21.44	21.53	2
	12	13	22.65	22.54	22.60	1	21.62	21.36	21.59	2
	25	0	22.61	22.47	22.67	1	21.56	21.30	21.42	2

Band / BW	RB Size	RB Offset	QPSK			3GPP MPR (dB)	16QAM			3GPP MPR (dB)
			Low Ch 20450	Mid Ch 20525	High Ch 20600		Low Ch 20450	Mid Ch 20525	High Ch 20600	
			829.0 MHz	836.5 MHz	844.0 MHz		829.0 MHz	836.5 MHz	844.0 MHz	
5 / 10M	1	0	23.95	23.86	23.97	0	22.59	22.35	22.43	1
	1	24	23.88	23.79	23.91	0	22.58	22.40	22.58	1
	1	49	23.71	23.84	23.89	0	22.42	22.42	22.43	1
	25	0	22.60	22.60	22.73	1	21.55	21.63	21.72	2
	25	12	22.61	22.58	22.66	1	21.59	21.61	21.69	2
	25	25	22.59	22.57	22.55	1	21.42	21.41	21.67	2
	50	0	22.61	22.58	22.70	1	21.54	21.43	21.68	2

ERP Power (dBm)

CDMA							
Plane	Channel	Frequency (MHz)	LVL (dBm)	Correction Factor (dB)	ERP (dBm)	ERP (mW)	Polarization (H/V)
Y	1013	824.7	-10.79	32.62	19.68	92.90	H
	384	836.52	-10.66	32.52	19.71	93.54	
	777	848.31	-10.87	32.65	19.63	91.83	
	1013	824.7	-17.52	32.76	13.09	20.37	V
	384	836.52	-17.11	32.39	13.13	20.56	
	777	848.31	-17.33	32.54	13.06	20.23	

LTE Band 5							
Channel Bandwidth: 1.4 MHz / QPSK							
Plane	Channel	Frequency (MHz)	LVL (dBm)	Correction Factor (dB)	ERP (dBm)	ERP (mW)	Polarization (H/V)
Y	20407	824.7	-10.12	32.62	20.35	108.39	H
	20525	836.5	-9.95	32.52	20.42	110.15	
	20643	848.3	-10.11	32.65	20.39	109.40	
	20407	824.7	-15.41	32.76	15.20	33.11	V
	20525	836.5	-14.94	32.39	15.30	33.88	
	20643	848.3	-15.15	32.54	15.24	33.42	
Channel Bandwidth: 1.4 MHz / 16QAM							
Y	20407	824.7	-10.79	32.62	19.68	92.90	H
	20525	836.5	-10.65	32.52	19.72	93.76	
	20643	848.3	-10.80	32.65	19.70	93.33	
	20407	824.7	-15.91	32.76	14.70	29.51	V
	20525	836.5	-15.52	32.39	14.72	29.65	
	20643	848.3	-15.72	32.54	14.67	29.31	

LTE Band 5							
Channel Bandwidth: 3 MHz / QPSK							
Plane	Channel	Frequency (MHz)	LVL (dBm)	Correction Factor (dB)	ERP (dBm)	ERP (mW)	Polarization (H/V)
Y	20415	825.5	-10.05	32.62	20.42	110.15	H
	20525	836.5	-9.82	32.52	20.55	113.50	
	20635	847.5	-10.05	32.65	20.45	110.92	
	20415	825.5	-15.34	32.76	15.27	33.65	V
	20525	836.5	-14.89	32.39	15.35	34.28	
	20635	847.5	-15.06	32.54	15.33	34.12	
Channel Bandwidth: 3 MHz / 16QAM							
Y	20415	825.5	-10.70	32.62	19.77	94.84	H
	20525	836.5	-10.57	32.52	19.80	95.50	
	20635	847.5	-10.71	32.65	19.79	95.28	
	20415	825.5	-15.86	32.76	14.75	29.85	V
	20525	836.5	-15.48	32.39	14.76	29.92	
	20635	847.5	-15.71	32.54	14.68	29.38	

LTE Band 5							
Channel Bandwidth: 5 MHz / QPSK							
Plane	Channel	Frequency (MHz)	LVL (dBm)	Correction Factor (dB)	ERP (dBm)	ERP (mW)	Polarization (H/V)
Y	20425	826.5	-9.97	32.62	20.50	112.20	H
	20525	836.5	-9.74	32.52	20.63	115.61	
	20625	846.5	-9.96	32.65	20.54	113.24	
	20425	826.5	-15.30	32.76	15.31	33.96	V
	20525	836.5	-14.84	32.39	15.40	34.67	
	20625	846.5	-15.01	32.54	15.38	34.51	
Channel Bandwidth: 5 MHz / 16QAM							
Y	20425	826.5	-10.62	32.62	19.85	96.61	H
	20525	836.5	-10.47	32.52	19.90	97.72	
	20625	846.5	-10.67	32.65	19.83	96.16	
	20425	826.5	-15.83	32.76	14.78	30.06	V
	20525	836.5	-15.44	32.39	14.80	30.20	
	20625	846.5	-15.65	32.54	14.74	29.79	

LTE Band 5							
Channel Bandwidth: 10 MHz / QPSK							
Plane	Channel	Frequency (MHz)	LVL (dBm)	Correction Factor (dB)	ERP (dBm)	ERP (mW)	Polarization (H/V)
Y	20450	829.0	-9.80	32.62	20.67	116.68	H
	20525	836.5	-9.63	32.52	20.74	118.58	
	20600	844.0	-9.82	32.65	20.68	116.95	
	20450	829.0	-15.23	32.76	15.38	34.51	V
	20525	836.5	-14.80	32.39	15.44	34.99	
	20600	844.0	-14.98	32.54	15.41	34.75	
Channel Bandwidth: 10 MHz / 16QAM							
Y	20450	829.0	-10.58	32.62	19.89	97.50	H
	20525	836.5	-10.44	32.52	19.93	98.40	
	20600	844.0	-10.60	32.65	19.90	97.72	
	20450	829.0	-15.79	32.76	14.82	30.34	V
	20525	836.5	-15.38	32.39	14.86	30.62	
	20600	844.0	-15.59	32.54	14.80	30.20	

4.2 Frequency Stability Measurement

4.2.1 Limits of Frequency Stability Measurement

1.5 ppm is for base and fixed station. 2.5 ppm is for mobile station.

4.2.2 Test Procedure

- Device is placed at the oven room. The oven room could control the temperatures and humidity. Power warm up is at least 15 min and power applied should perform before recording frequency error.
- EUT is connected the external power supply to control the DC input power. The test voltage range is from minimum to maximum working voltage. Each step shall be record the frequency error rate.
- The temperature range step is 10 degrees in this test items. All temperature levels shall be hold the ± 0.5 °C during the measurement testing. The each temperature step shall be at least 0.5 hours, consider the EUT could be test under the stability condition.

NOTE: The frequency error was recorded frequency error from the communication simulator.

4.2.3 Test Setup

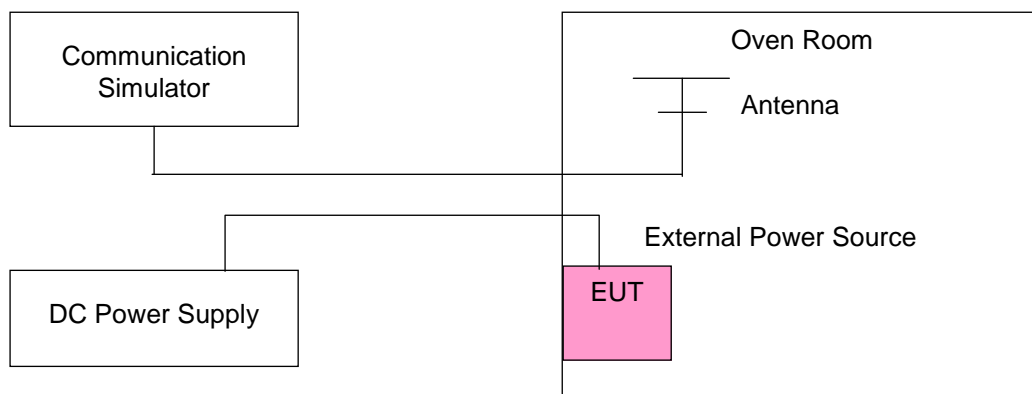

4.2.4 Test Results

Frequency Error vs. Voltage

Voltage (Volts)	CDMA		Limit (ppm)
	Frequency (MHz)	Frequency Error (ppm)	
3.8	836.520001	0.002	2.5
3.5	836.520001	0.002	2.5
4.35	836.520003	0.004	2.5

Note: The applicant defined the normal working voltage of the battery is from 3.5 Vdc to 4.35 Vdc.

Frequency Error vs. Temperature

Temp. (°C)	CDMA		Limit (ppm)
	Frequency (MHz)	Frequency Error (ppm)	
-30	836.520003	0.003	2.5
-20	836.520004	0.004	2.5
-10	836.520001	0.001	2.5
0	836.520004	0.005	2.5
10	836.520002	0.003	2.5
20	836.519998	-0.002	2.5
30	836.519999	-0.001	2.5
40	836.519996	-0.005	2.5
50	836.519997	-0.004	2.5
55	836.519996	-0.005	2.5

Frequency Error vs. Voltage

Voltage (Volts)	LTE Band 5				Limit (ppm)
	1.4 MHz		3 MHz		
	Frequency (MHz)	Frequency Error (ppm)	Frequency (MHz)	Frequency Error (ppm)	
3.8	836.500001	0.002	836.500001	0.002	2.5
3.5	836.500003	0.003	836.500002	0.003	2.5
4.35	836.500003	0.004	836.500003	0.003	2.5

Note: The applicant defined the normal working voltage of the battery is from 3.5 Vdc to 4.35 Vdc.

Frequency Error vs. Temperature

Temp. (°C)	LTE Band 5				Limit (ppm)
	1.4 MHz		3 MHz		
	Frequency (MHz)	Frequency Error (ppm)	Frequency (MHz)	Frequency Error (ppm)	
-30	836.500003	0.003	836.500001	0.001	2.5
-20	836.500004	0.005	836.500004	0.005	2.5
-10	836.500002	0.002	836.500002	0.002	2.5
0	836.500003	0.003	836.500004	0.004	2.5
10	836.500002	0.003	836.500001	0.002	2.5
20	836.499998	-0.003	836.499998	-0.003	2.5
30	836.499999	-0.001	836.499996	-0.005	2.5
40	836.499997	-0.004	836.499997	-0.004	2.5
50	836.499998	-0.003	836.499998	-0.002	2.5
55	836.499996	-0.005	836.499996	-0.005	2.5

Frequency Error vs. Voltage

Voltage (Volts)	LTE Band 5				Limit (ppm)
	5 MHz		10 MHz		
	Frequency (MHz)	Frequency Error (ppm)	Frequency (MHz)	Frequency Error (ppm)	
3.8	836.500003	0.004	836.500003	0.003	2.5
3.5	836.500003	0.004	836.500003	0.004	2.5
4.35	836.500002	0.002	836.500003	0.004	2.5

Note: The applicant defined the normal working voltage of the battery is from 3.5 Vdc to 4.35 Vdc.

Frequency Error vs. Temperature

Temp. (°C)	LTE Band 5				Limit (ppm)
	5 MHz		10 MHz		
	Frequency (MHz)	Frequency Error (ppm)	Frequency (MHz)	Frequency Error (ppm)	
-30	836.500002	0.002	836.500002	0.003	2.5
-20	836.500003	0.004	836.500002	0.002	2.5
-10	836.500002	0.002	836.500002	0.002	2.5
0	836.500002	0.002	836.500003	0.004	2.5
10	836.500001	0.002	836.500003	0.003	2.5
20	836.499997	-0.003	836.499996	-0.004	2.5
30	836.499997	-0.004	836.499998	-0.003	2.5
40	836.499998	-0.002	836.499997	-0.004	2.5
50	836.499998	-0.002	836.499996	-0.005	2.5
55	836.499999	-0.002	836.499999	-0.002	2.5

4.3 Occupied Bandwidth Measurement

4.3.1 Test Procedure

The EUT makes a call to the communication simulator. All measurements were done at low, middle and high operational frequency range. The communication simulator station system controlled a EUT to export maximum output power under transmission mode and specific channel frequency. Use OBW measurement function of Spectrum analyzer to measure 99 % occupied bandwidth.

4.3.2 Test Setup

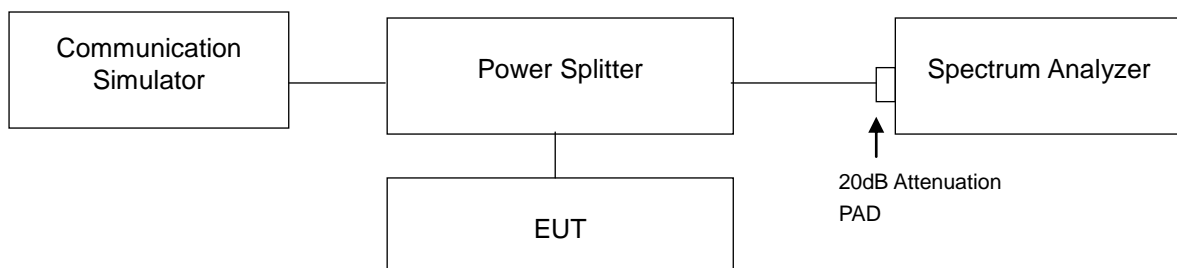

4.3.3 Test Result

Channel	Frequency (MHz)	99 % Occupied Bandwidth (kHz)
		CDMA
1013	824.70	1.2763
384	836.52	1.2726
777	848.31	1.2759

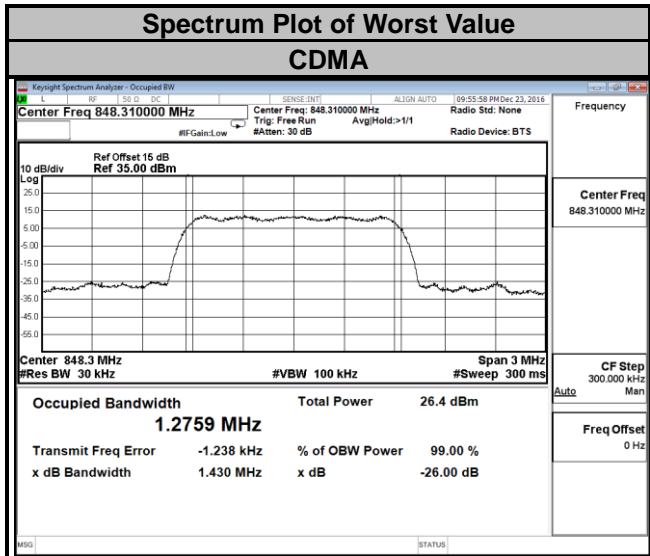

LTE Band 5							
Channel Bandwidth: 1.4 MHz				Channel Bandwidth: 3 MHz			
Channel	Frequency (MHz)	99 % Occupied Bandwidth (MHz)		Channel	Frequency (MHz)	99 % Occupied Bandwidth (MHz)	
		QPSK	16QAM			QPSK	16QAM
20407	824.7	1.0911	1.0920	20415	825.5	2.7089	2.7008
20525	836.5	1.0892	1.0902	20525	836.5	2.7024	2.6975
20643	848.3	1.0888	1.0908	20635	847.5	2.7040	2.7006

Spectrum Plot of Worst Value

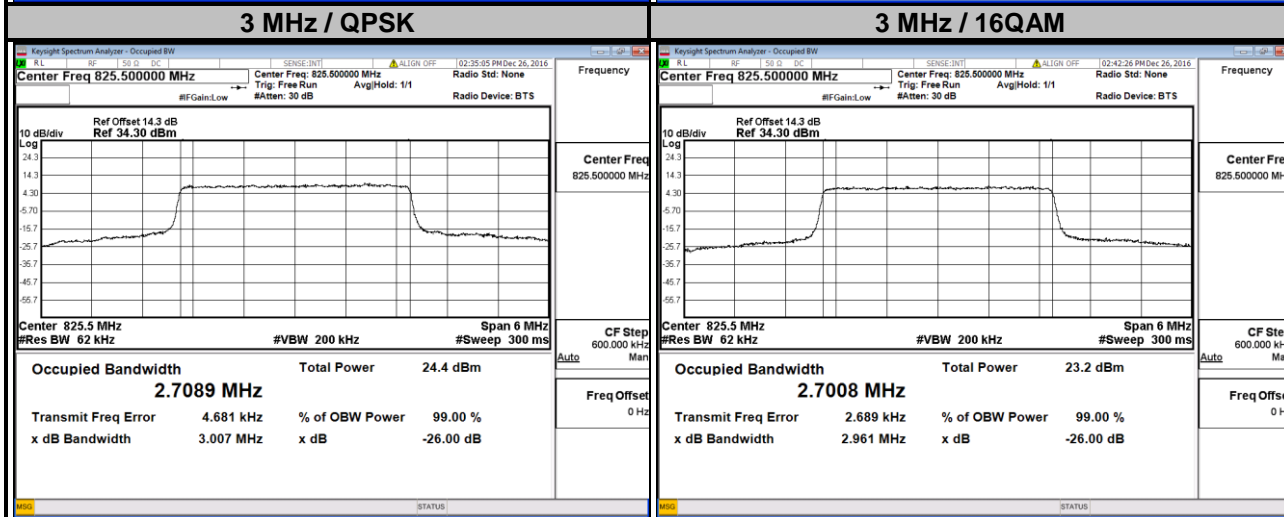
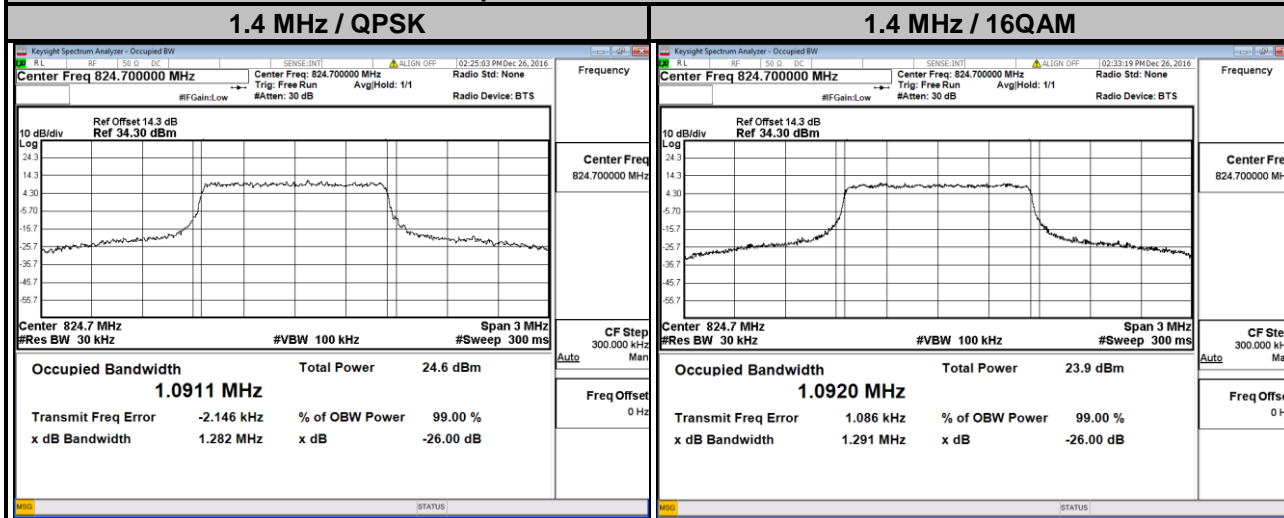

LTE Band 5

Channel Bandwidth: 5 MHz				Channel Bandwidth: 10 MHz			
Channel	Frequency (MHz)	99 % Occupied Bandwidth (MHz)		Channel	Frequency (MHz)	99 % Occupied Bandwidth (MHz)	
		QPSK	16QAM			QPSK	16QAM
20425	826.5	4.5056	4.4972	20450	829.0	8.9826	8.9675
20525	836.5	4.4905	4.4942	20525	836.5	8.9713	8.9750
20625	846.5	4.4925	4.4936	20600	844.0	8.9387	8.9330

Spectrum Plot of Worst Value

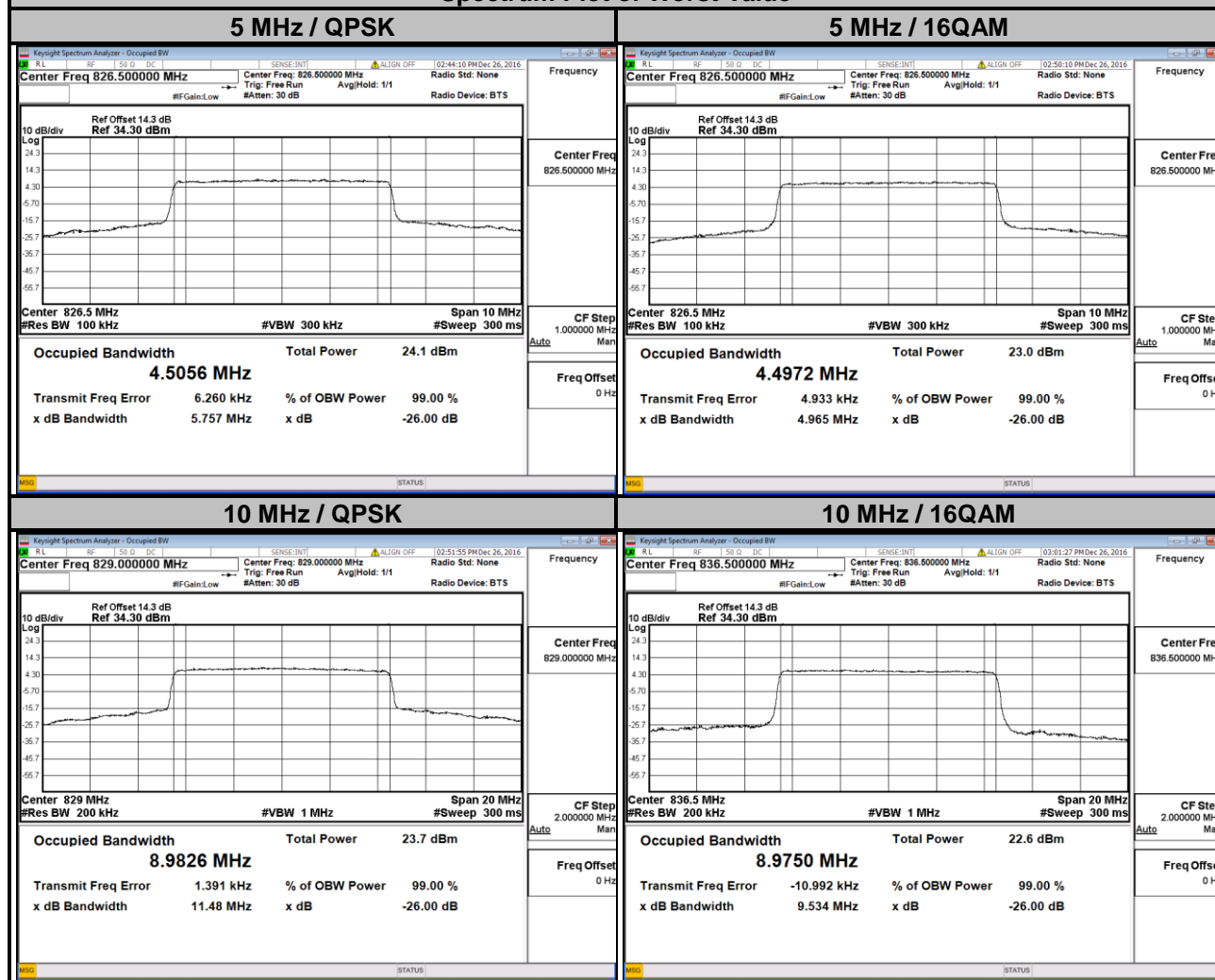

4.4 Band Edge Measurement

4.4.1 Limits of Band Edge Measurement

Power of any emission outside of the authorized operating frequency ranges must be attenuated below the transmitting power (P) by a factor of at least $43 + 10 \log(P)$ dB. In the 1 MHz bands immediately outside and adjacent to the frequency block a resolution bandwidth of at least one percent of the emission bandwidth of the fundamental emission of the transmitter may be employed.

4.4.2 Test Setup

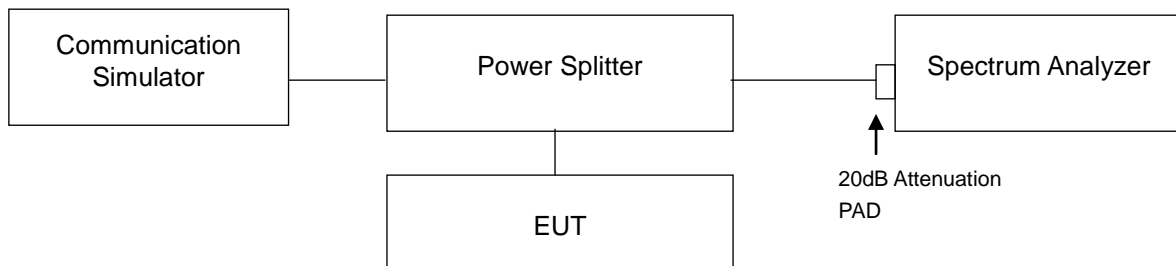

4.4.3 Test Procedures

- All measurements were done at low and high operational frequency range.
- The center frequency of spectrum is the band edge frequency and span is 1 MHz. RB of the spectrum is 13 kHz and VB of the spectrum is 51 kHz (CDMA / LTE Bandwidth 1.4 MHz).
- The center frequency of spectrum is the band edge frequency and span is 1 MHz. RB of the spectrum is 30 kHz and VB of the spectrum is 100 kHz (LTE Bandwidth 3 MHz).
- The center frequency of spectrum is the band edge frequency and span is 1 MHz. RB of the spectrum is 100 kHz and VB of the spectrum is 300 kHz (LTE Bandwidth 5 MHz/10 MHz).
- Record the max trace plot into the test report.

4.4.4 Test Results

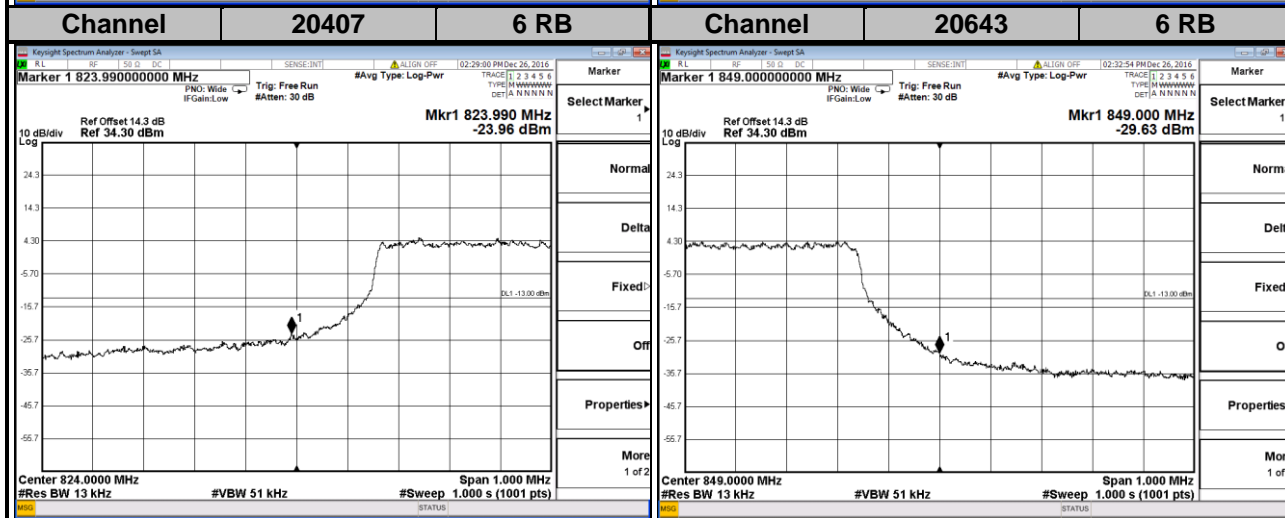
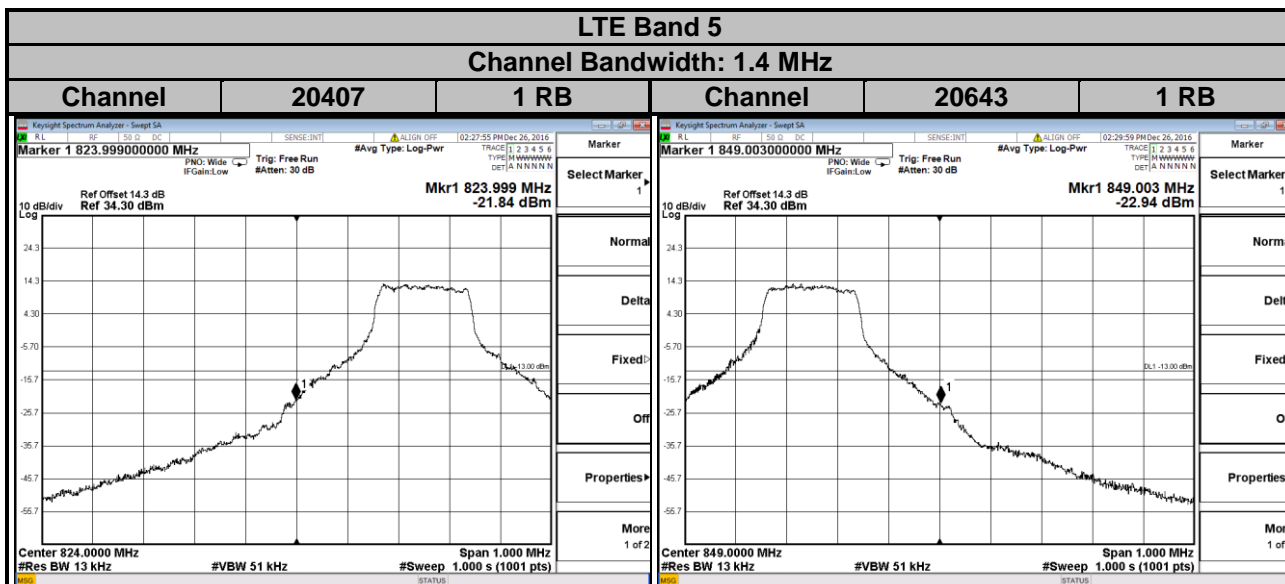
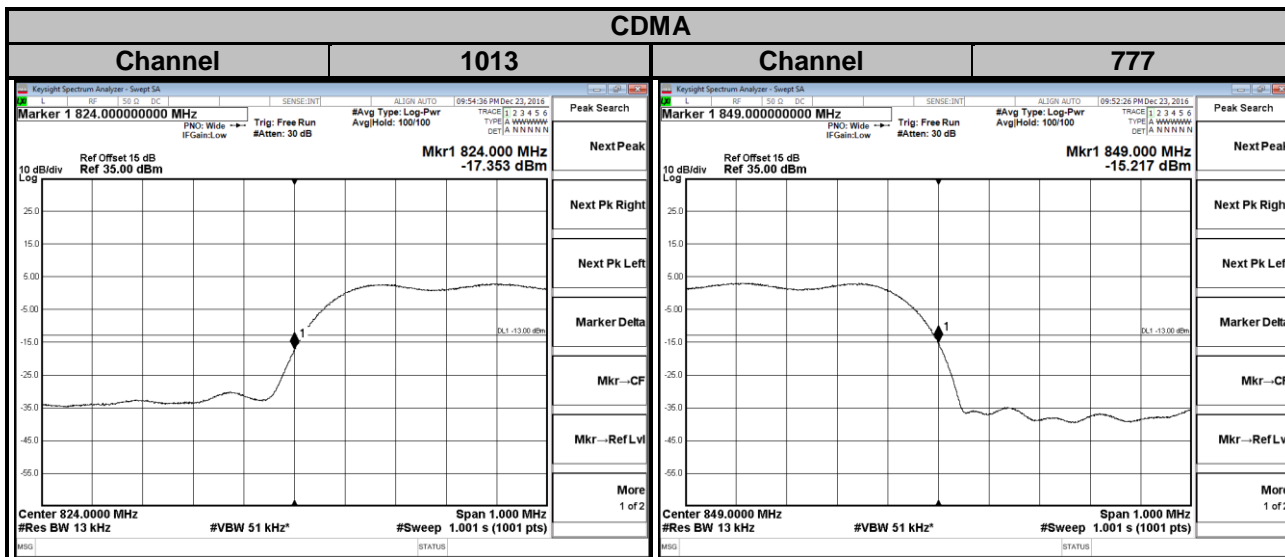

LTE Band 5

Channel Bandwidth: 3 MHz

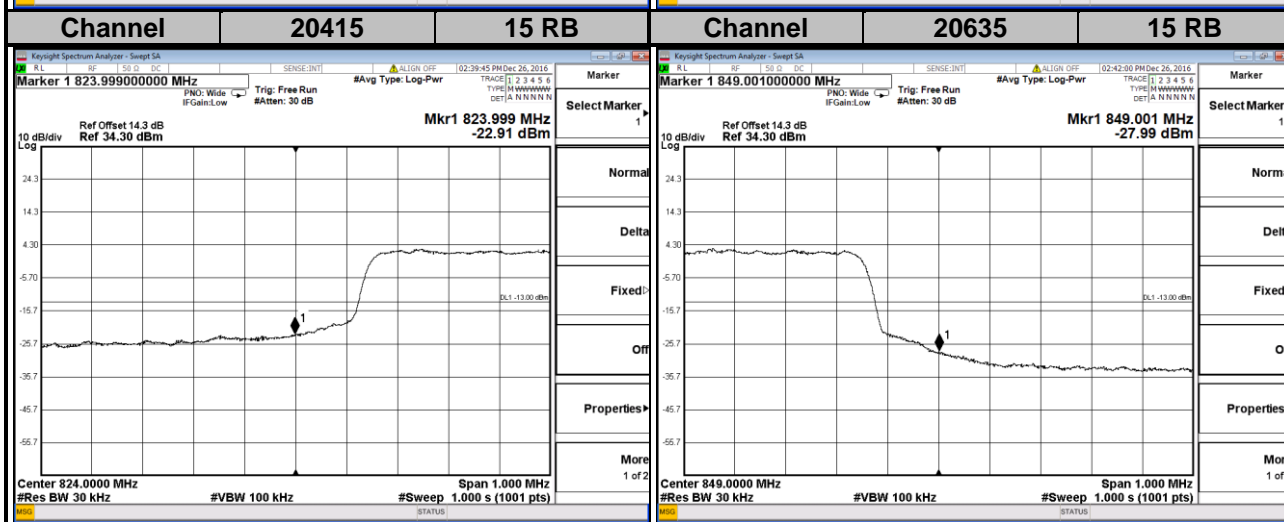
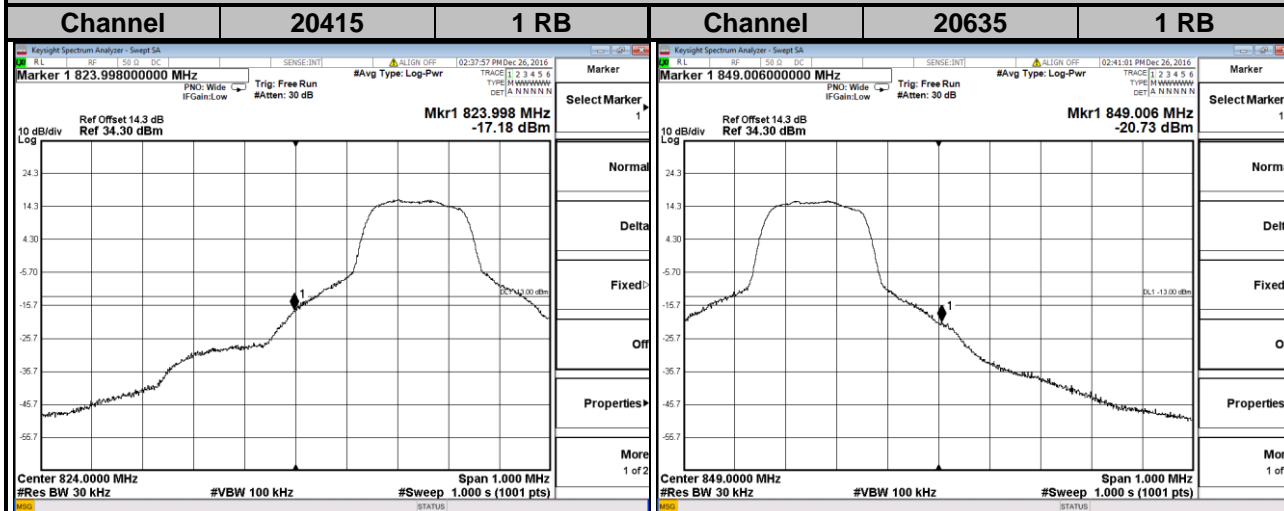

LTE Band 5
Channel Bandwidth: 5 MHz

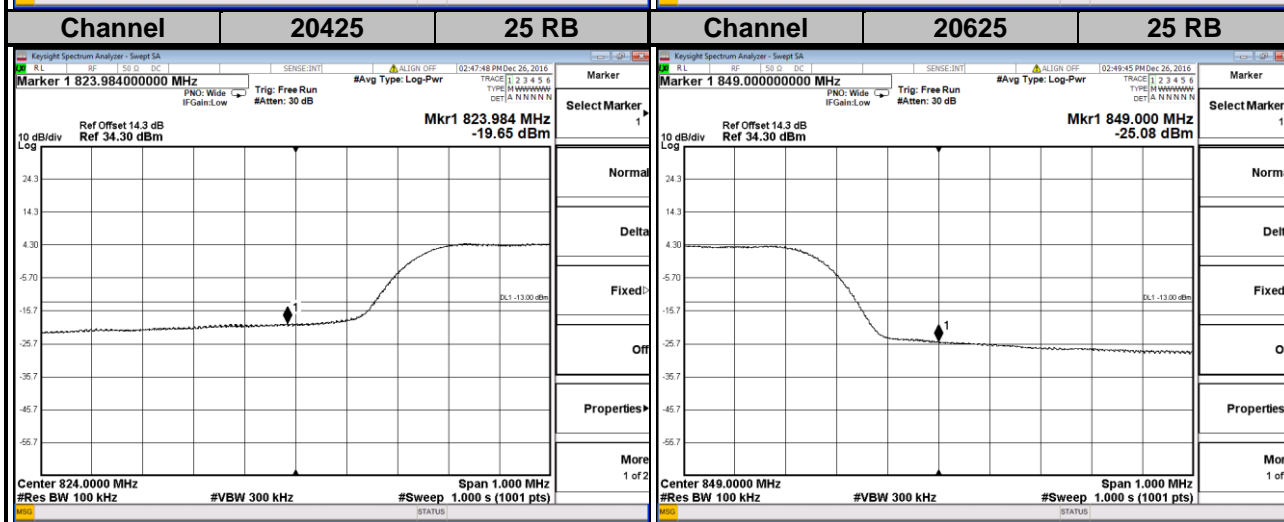
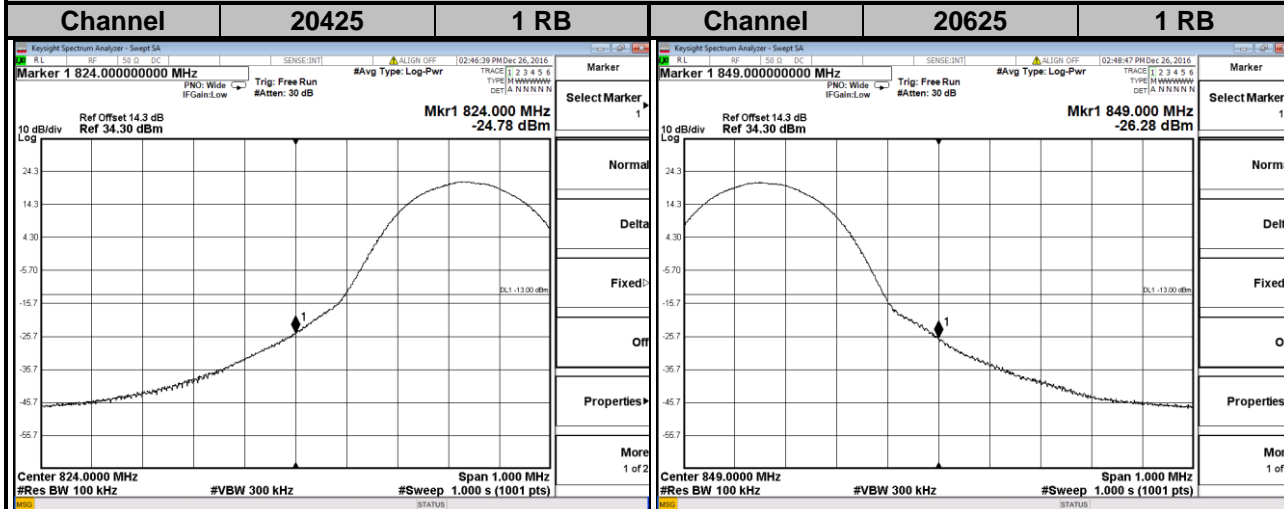

LTE Band 5
Channel Bandwidth: 10 MHz

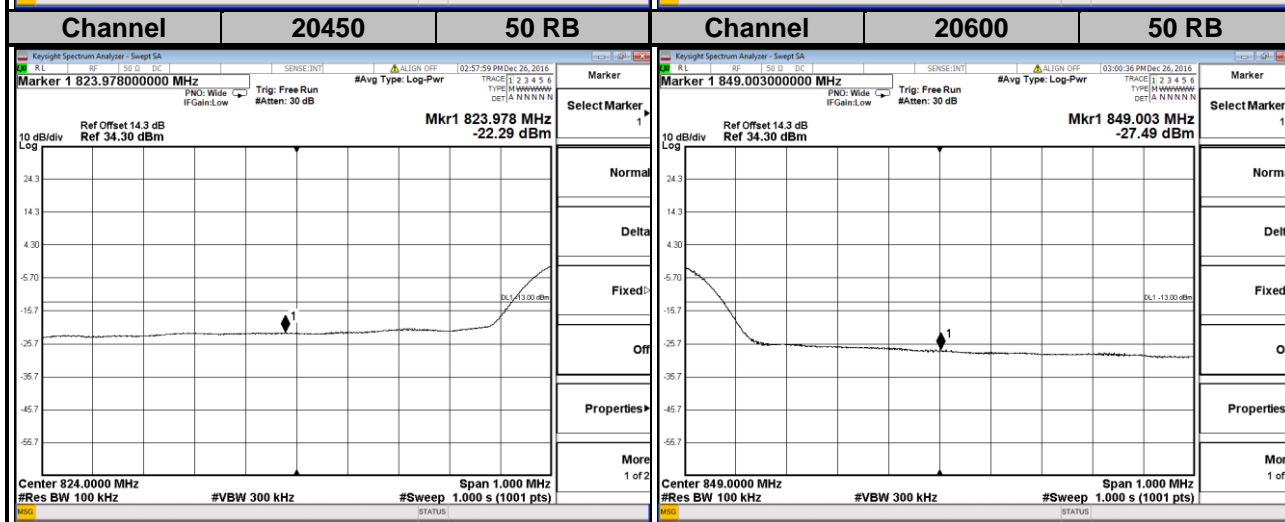
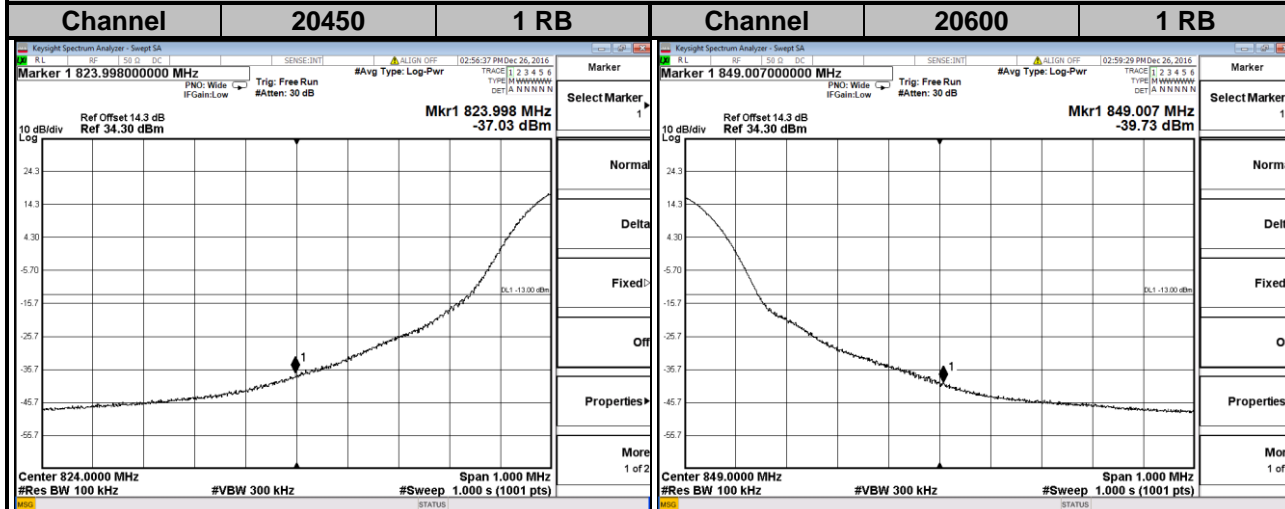

4.5 Peak to Average Ratio

4.5.1 Limits of Peak to Average Ratio Measurement

In measuring transmissions in this band using an average power technique, the peak to-average ratio (PAR) of the transmission may not exceed 13 dB.

4.5.2 Test Setup

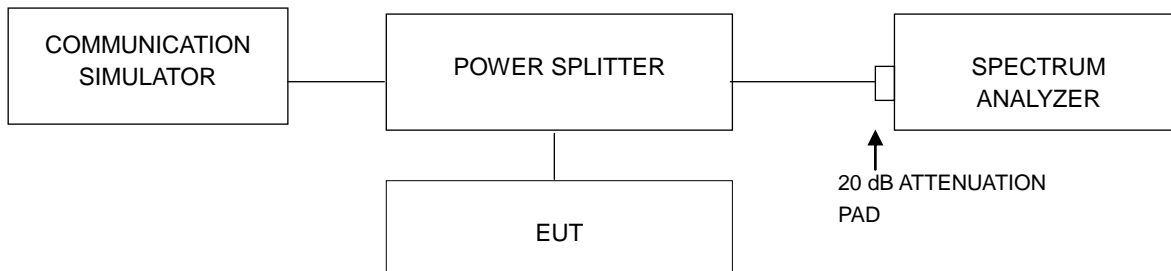

4.5.3 Test Procedures

1. Set resolution/measurement bandwidth \geq signal's occupied bandwidth;
2. Set the number of counts to a value that stabilizes the measured CCDF curve;
3. Record the maximum PAPR level associated with a probability of 0.1 %.

4.5.4 Test Results

Channel	Frequency (MHz)	Peak to Average Ratio (dB)
		CDMA
1013	824.70	2.74
384	836.52	3.69
777	848.31	3.09

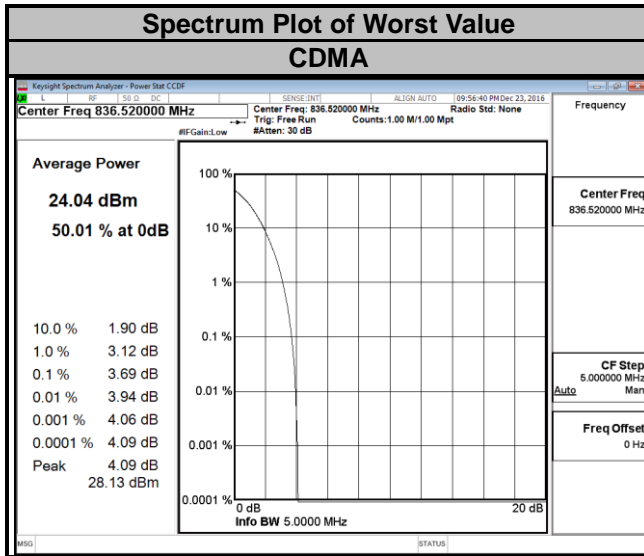

LTE Band 5

Channel Bandwidth: 1.4 MHz

Channel Bandwidth: 3 MHz

Channel	Frequency (MHz)	Peak to Average Ratio (dB)		Channel	Frequency (MHz)	Peak to Average Ratio (dB)	
		QPSK	16QAM			QPSK	16QAM
20407	824.7	2.95	3.93	20415	825.5	2.82	3.96
20525	836.5	3.85	4.75	20525	836.5	3.51	4.46
20643	848.3	3.19	4.32	20635	847.5	2.62	3.44

Spectrum Plot of Worst Value

1.4 MHz / QPSK

1.4 MHz / 16QAM

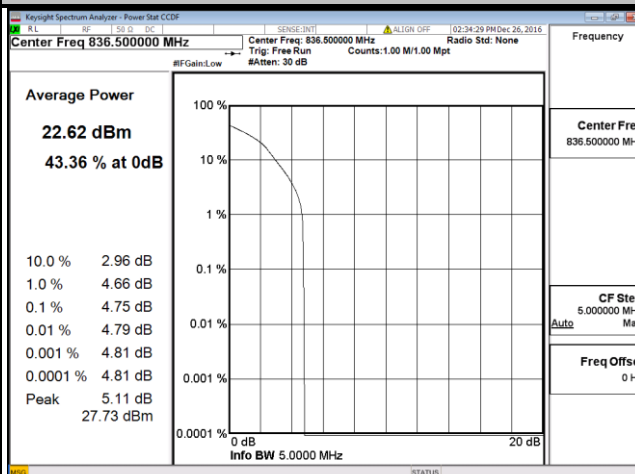
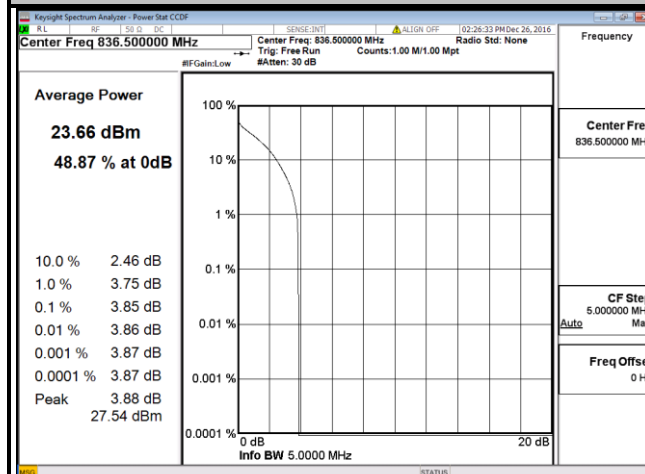

3 MHz / QPSK

3 MHz / 16QAM

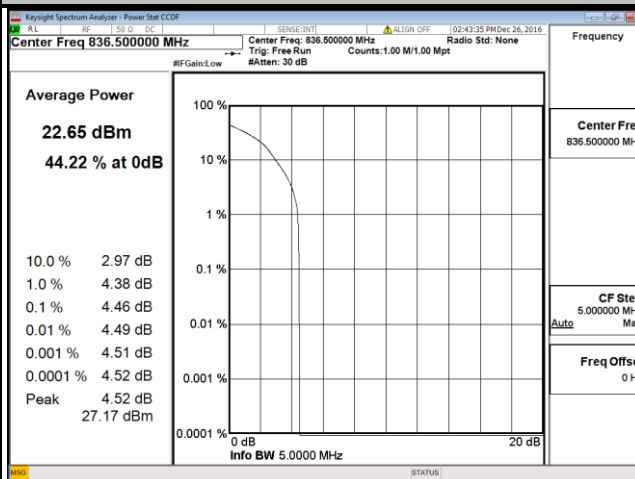
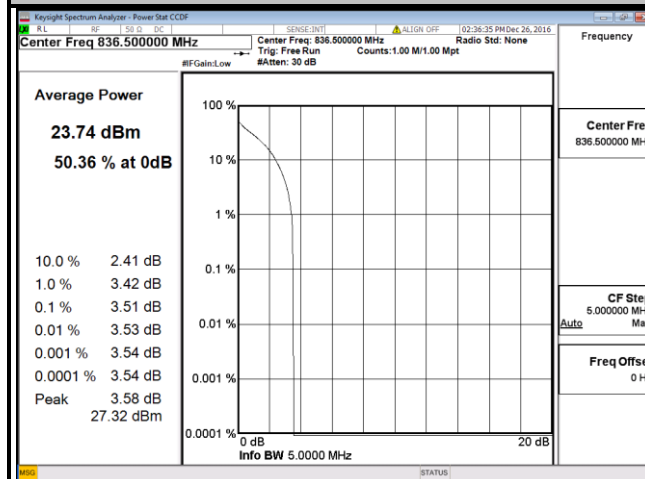

LTE Band 5							
Channel Bandwidth: 5 MHz				Channel Bandwidth: 10 MHz			
Channel	Frequency (MHz)	Peak to Average Ratio (dB)		Channel	Frequency (MHz)	Peak to Average Ratio (dB)	
		QPSK	16QAM			QPSK	16QAM
20425	826.5	2.88	3.96	20450	829.0	2.79	3.65
20525	836.5	3.31	4.39	20525	836.5	2.21	3.09
20625	846.5	2.30	3.33	20600	844.0	3.86	4.95

Spectrum Plot of Worst Value

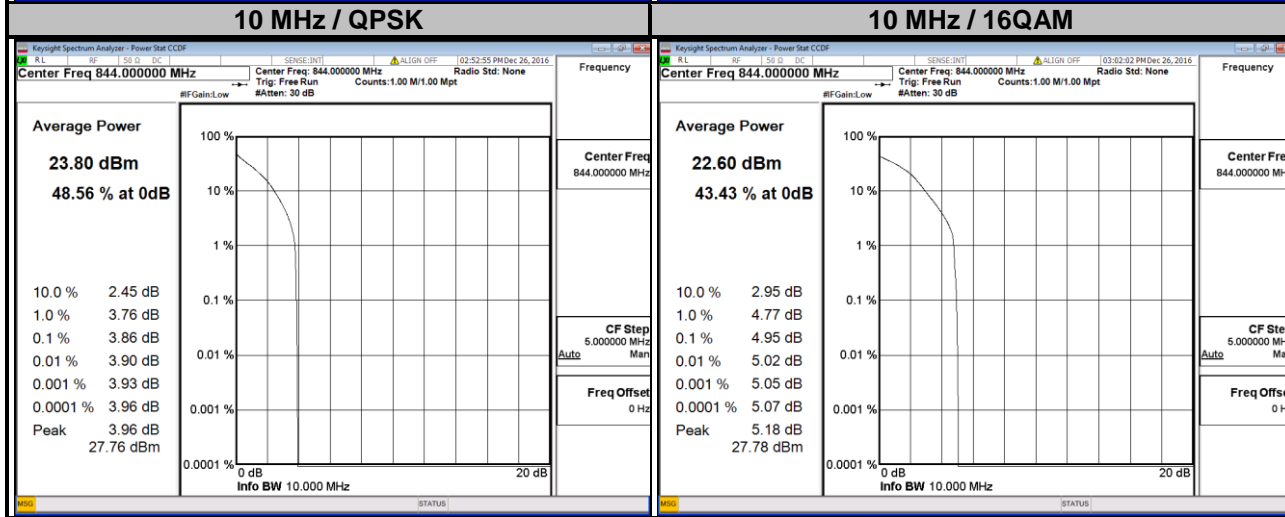
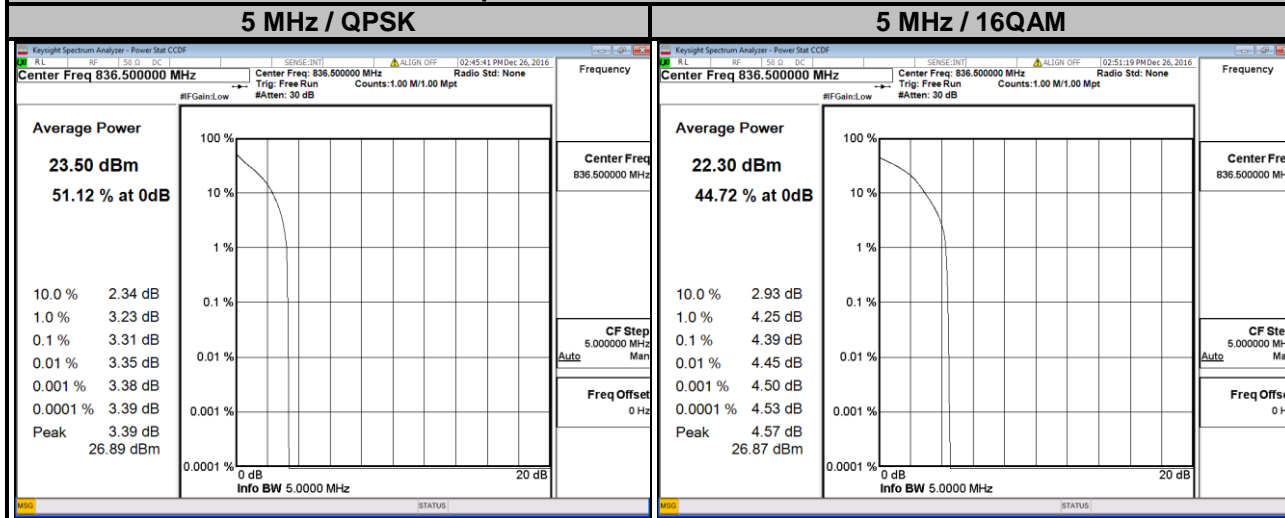

4.6 Conducted Spurious Emissions

4.6.1 Limits of Conducted Spurious Emissions Measurement

The power of any emission outside of the authorized operating frequency ranges must be attenuated below the transmitting power (P) by a factor of at least $43 + 10 \log(P)$ dB. The emission limit equal to -13 dBm.

4.6.2 Test Setup

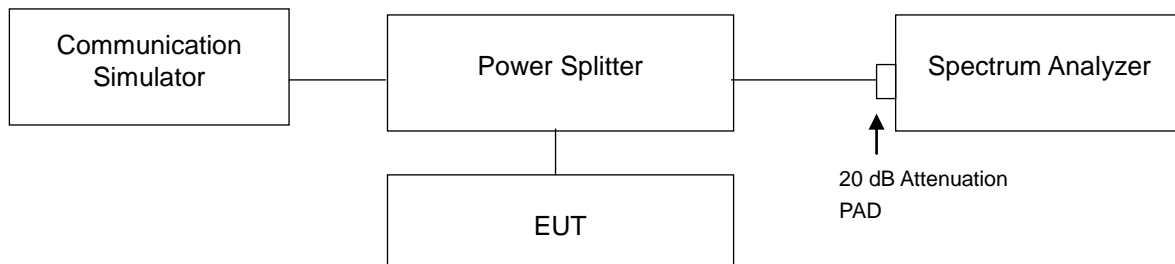

4.6.3 Test Procedure

- The EUT makes a phone call to the communication simulator. All measurements were done at low, middle and high operational frequency range.
- Measuring frequency range is from 9 kHz to 9 GHz. 20 dB attenuation pad is connected with spectrum. RBW=1 MHz and VBW=3 MHz is used for conducted emission measurement.

4.6.4 Test Results

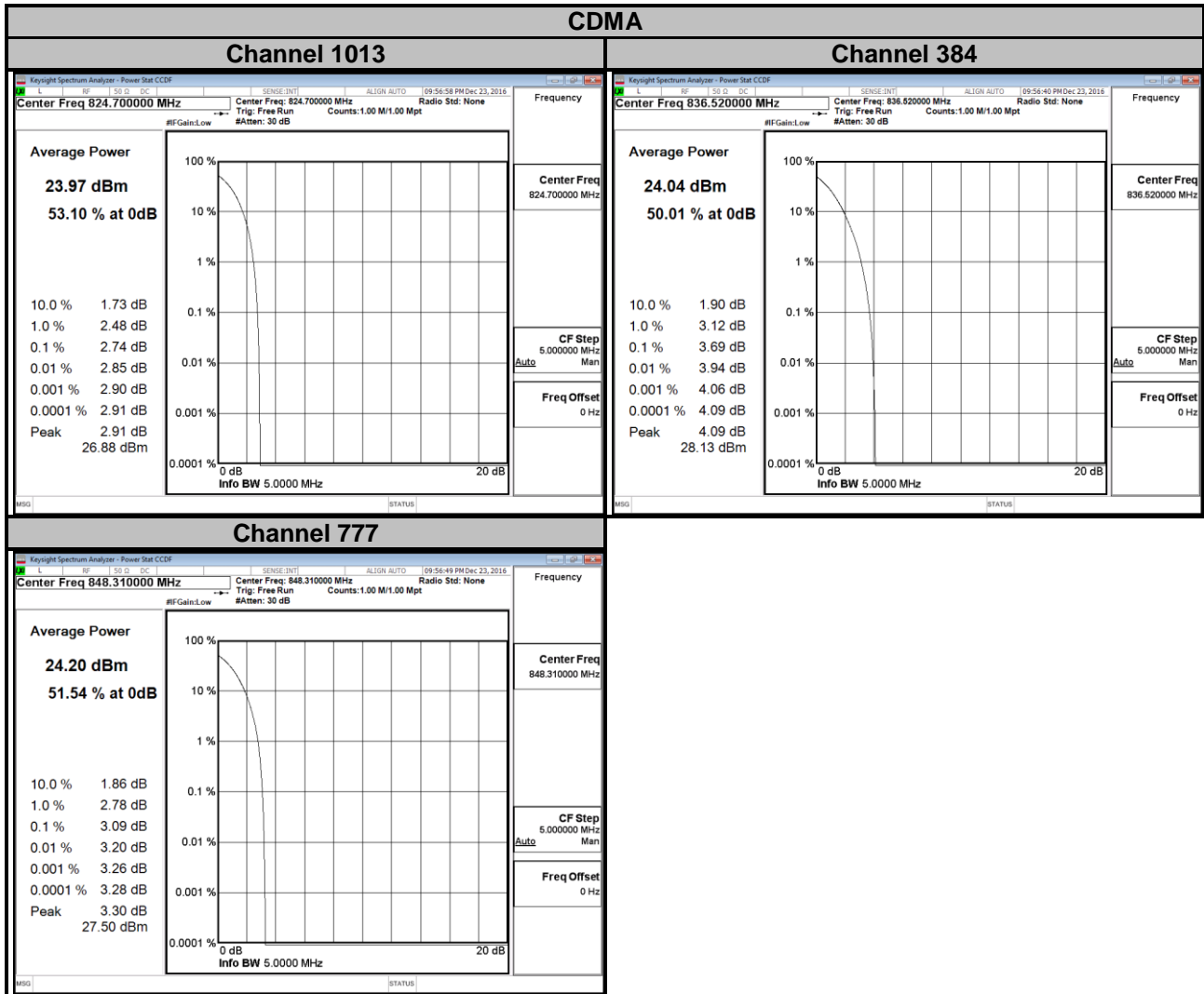

LTE Band 5
Channel Bandwidth: 1.4 MHz

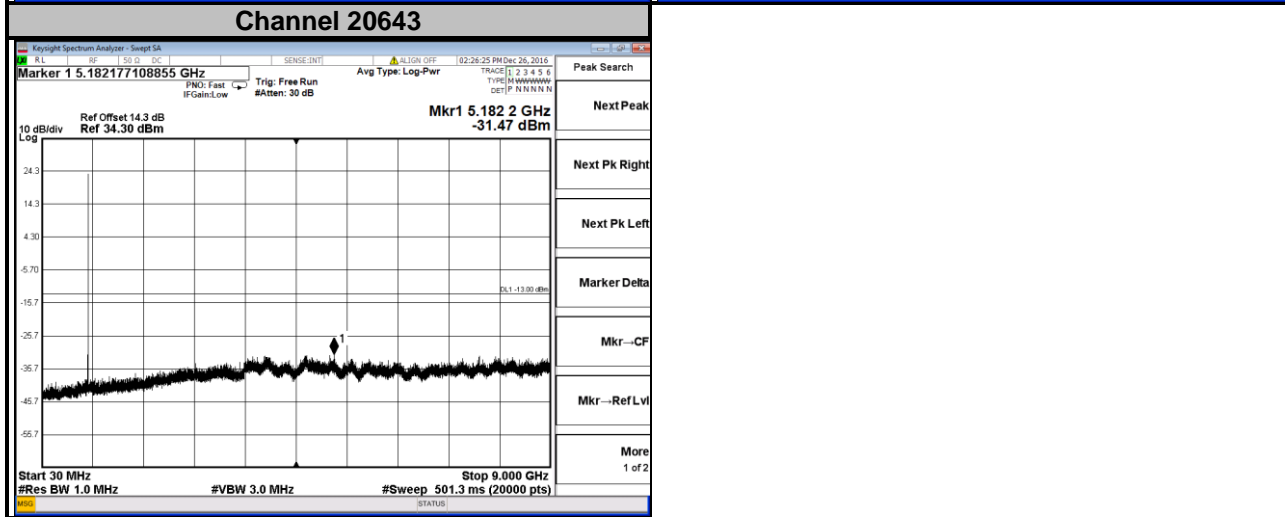
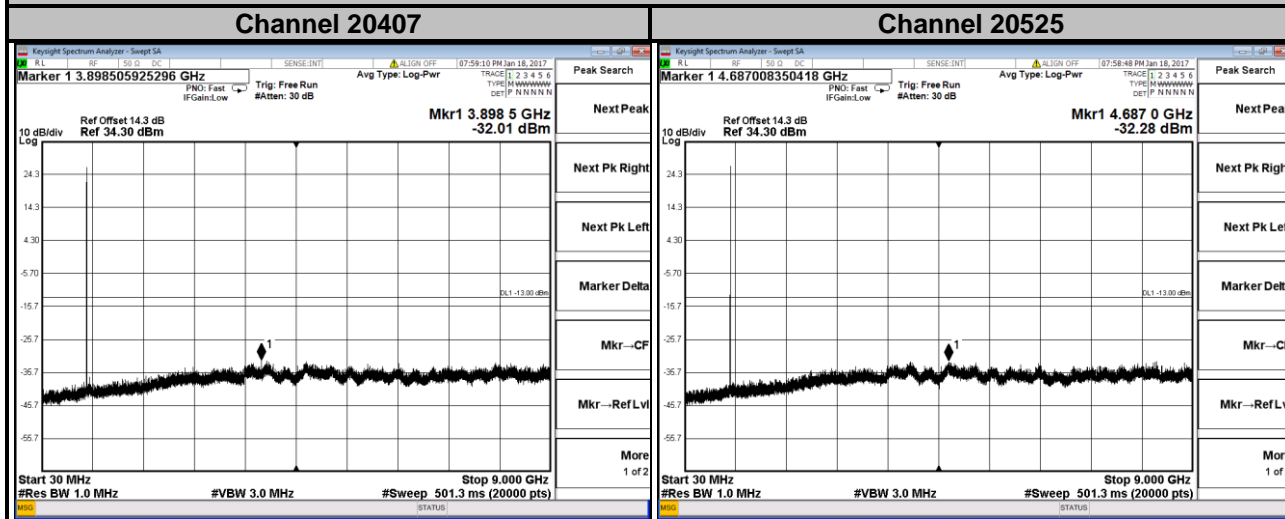

LTE Band 5
Channel Bandwidth: 3 MHz

Channel 20415

Channel 20525

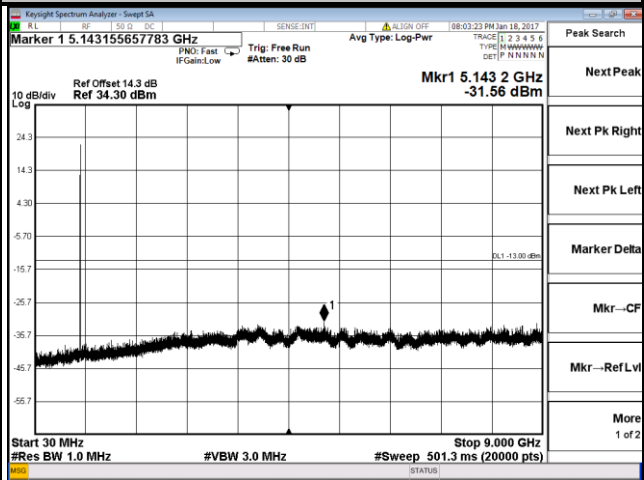
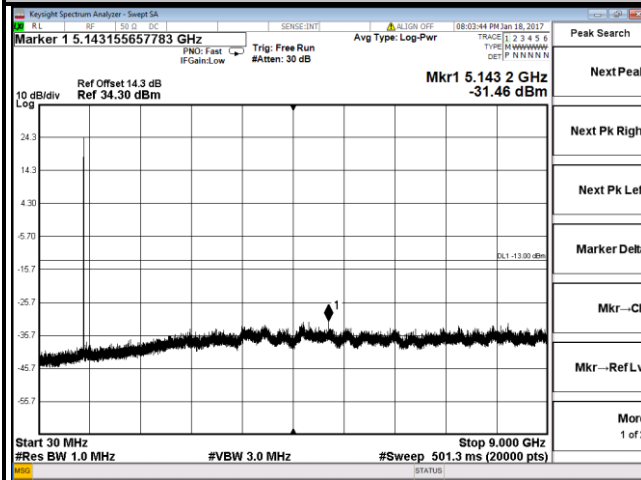

Channel 20635

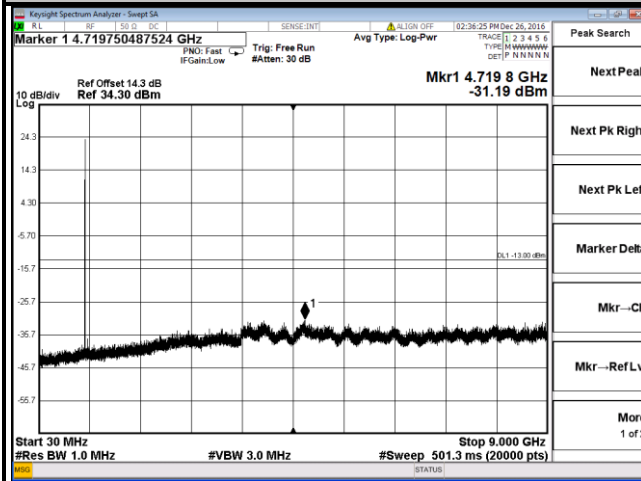

LTE Band 5
Channel Bandwidth: 5 MHz

Channel 20425

Channel 20525

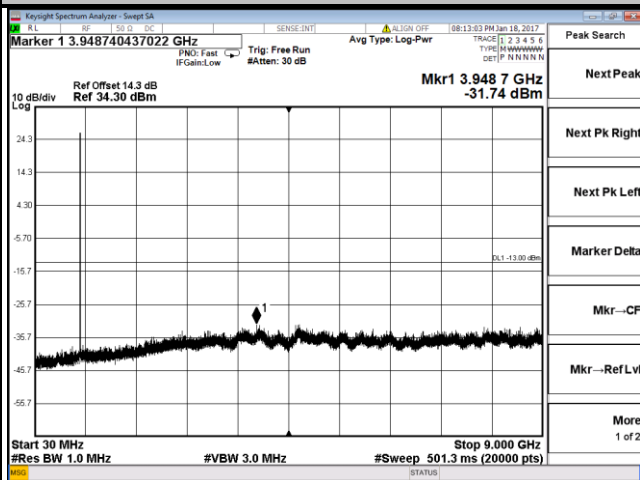
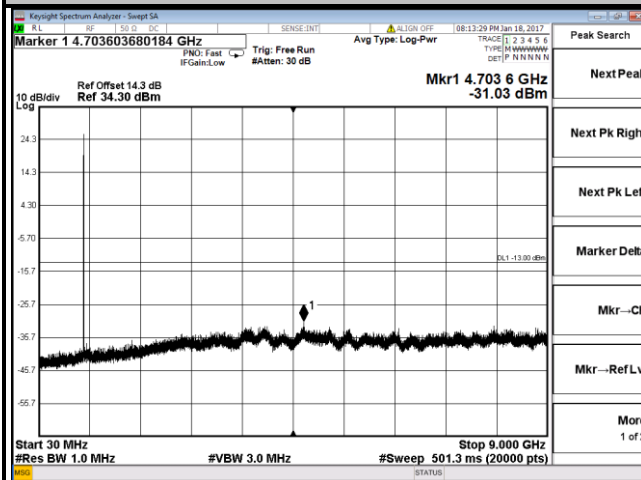

Channel 20625

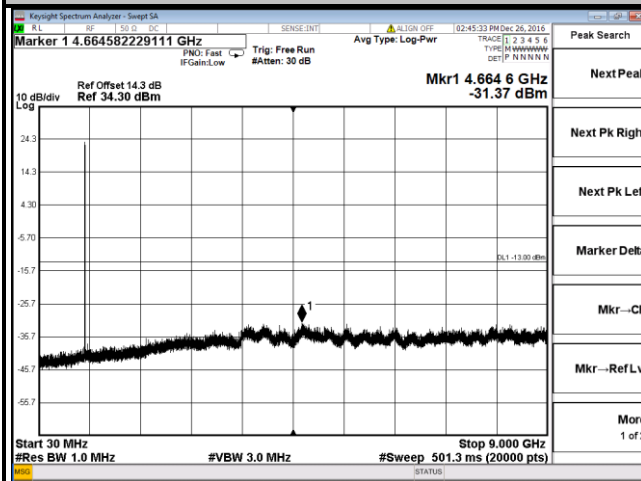

LTE Band 5
Channel Bandwidth: 10 MHz

Channel 20450

Channel 20525

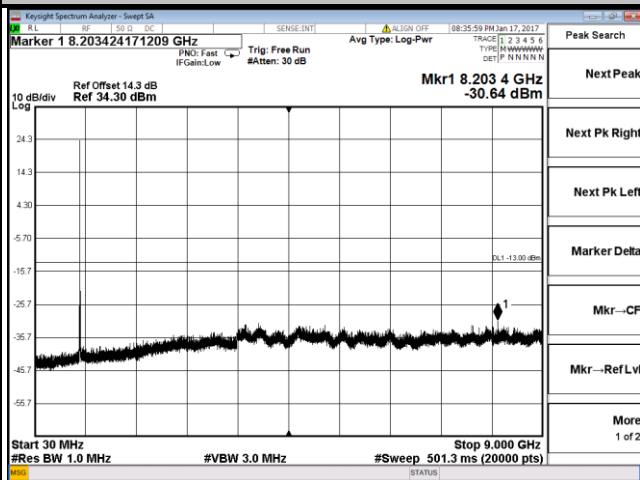
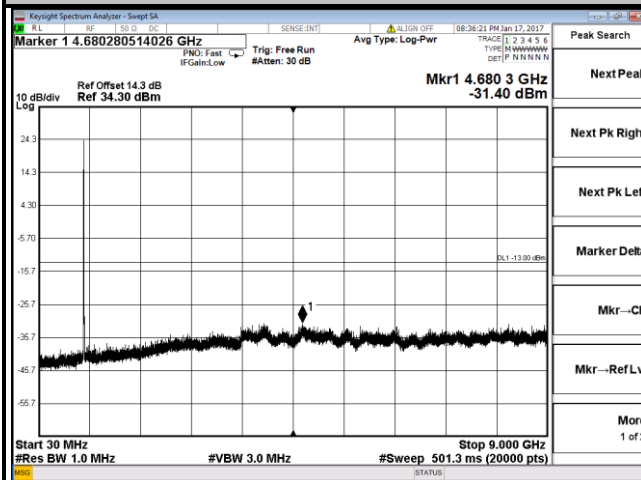

Channel 20600

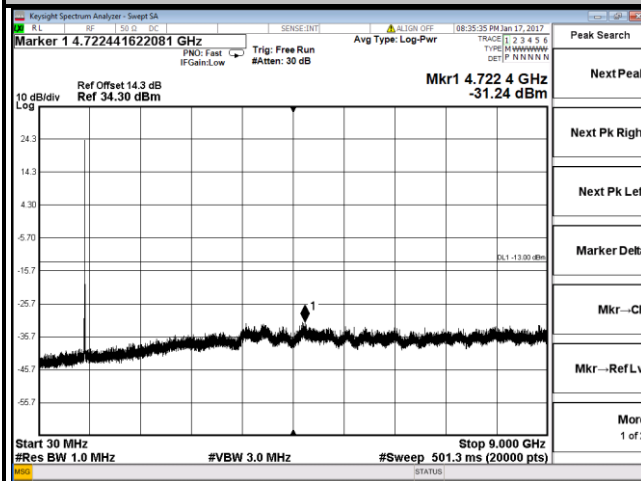

4.7 Radiated Emission Measurement

4.7.1 Limits of Radiated Emission Measurement

The power of any emission outside of the authorized operating frequency ranges must be attenuated below the transmitting power (P) by a factor of at least $43 + 10 \log(P)$ dB. The emission limit is equal to -13 dBm.

4.7.2 Test Procedure

- Substitution method is used for E.I.R.P measurement. In the semi-anechoic chamber, EUT placed on the 0.8 m height of Turn Table, rotated the table around 360 degrees to search the maximum radiation power and receiver antenna shall be rotated vertical and horizontal polarization and moved height from 1 m to 4 m to find the maximum polar radiated power. The "Read Value" is the spectrum reading the maximum power value.
- The substitution horn antenna is substituted for EUT at the same position and signals generator export the CW signal to the substitution antenna via a TX cable. Rotated the Turn Table and moved receiving antenna to find the maximum radiation power. Adjust output power level of S.G to get a Value of spectrum reading equal to "Read Value" of step a. Record the power level of S.G
- $EIRP = \text{Output power level of S.G} - \text{TX cable loss} + \text{Antenna gain of substitution horn}$.
- E.R.P power can be calculated form E.I.R.P power by subtracting the gain of dipole, $E.R.P \text{ power} = E.I.P.R \text{ power} - 2.15 \text{ dBi}$.

NOTE: The resolution bandwidth and video bandwidth of test receiver/spectrum analyzer is 1 MHz/3 MHz.

4.7.3 Deviation from Test Standard

No deviation.

4.7.4 Test Setup

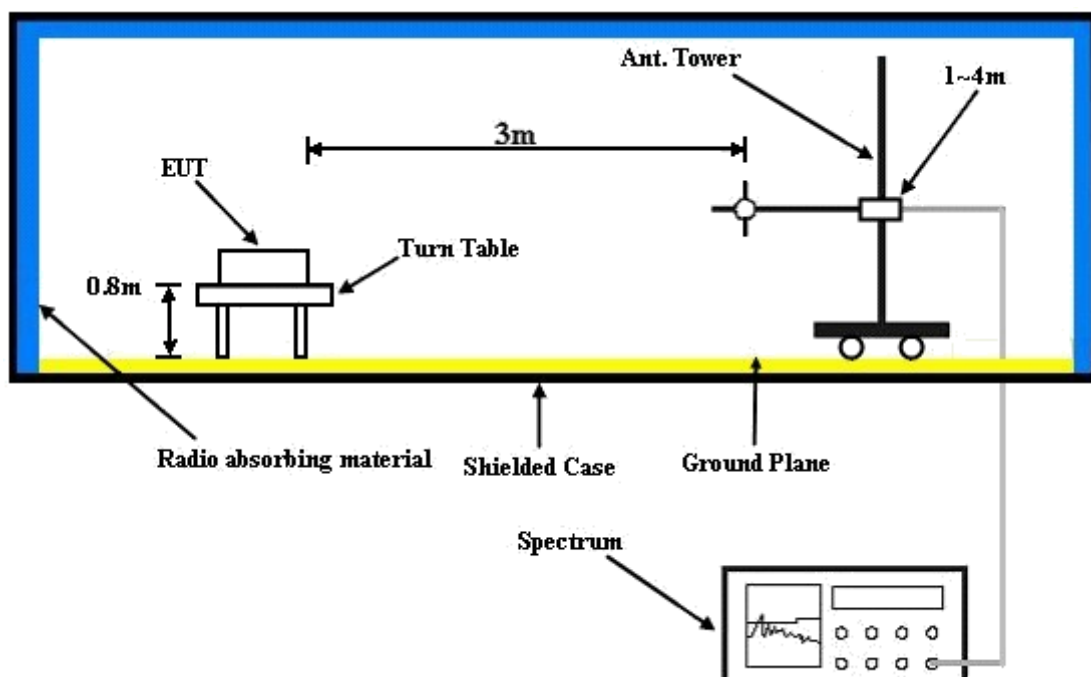

For the actual test configuration, please refer to the attached file (Test Setup Photo).

4.7.5 Test Results

CDMA:
Low Channel



Bureau Veritas Consumer Products Services Ltd., Taoyuan Branch

A D T

Data: 3

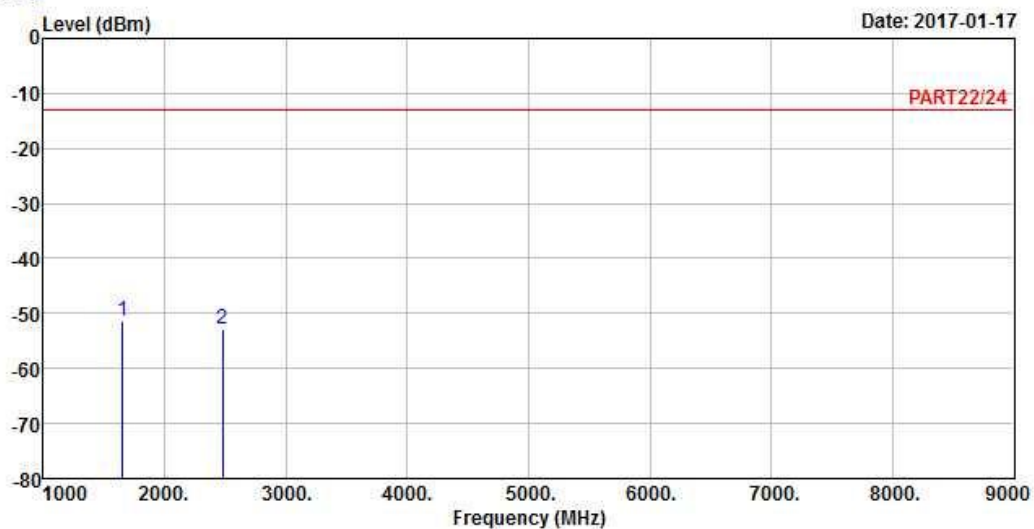

Site : 966 Chamber 5
Condition: PART22/24 HORIZONTAL
Remak : CDMA BC0_L-CH
Tested by: Gavin Wu

	Freq	Level	Read Level	Limit Line	Over Limit	Factor	Remark
	MHz	dBm	dBm	dBm	dB	dB	
1 pp	1649.40	-51.50	-36.77	-13.00	-38.50	-14.73	Peak
2	2474.10	-52.81	-42.37	-13.00	-39.81	-10.44	Peak



Bureau Veritas Consumer Products Services Ltd., Taoyuan Branch

A D T

Data: 4

Date: 2017-01-17

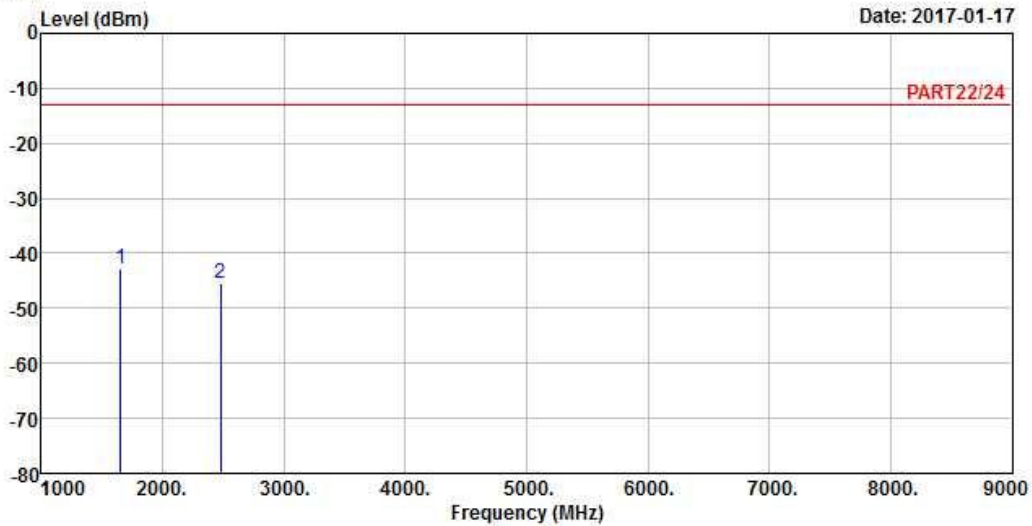

Site : 966 Chamber 5
 Condition: PART22/24 VERTICAL
 Remak : CDMA BC0_L-CH
 Tested by: Gavin Wu

	Freq	Level	Read Level	Limit Line	Over Limit	Factor	Remark
	MHz	dBm	dBm	dBm	dB	dB	
1 pp	1649.40	-42.80	-28.07	-13.00	-29.80	-14.73	Peak
2	2474.10	-45.53	-35.09	-13.00	-32.53	-10.44	Peak

Middle Channel



Bureau Veritas Consumer Products Services Ltd., Taoyuan Branch

A D T

Data: 3

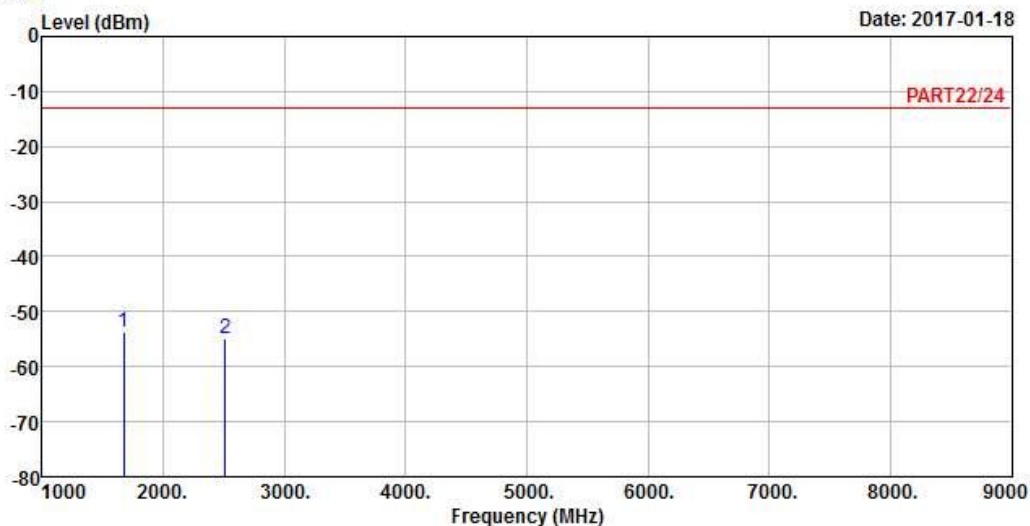

Site : 966 Chamber 5
 Condition: PART22/24 HORIZONTAL
 Remak : CDMA BC0_M-CH
 Tested by: Gavin Wu

	Read	Limit	Over			
Freq	Level	Level	Line	Limit	Factor	Remark
MHz	dBm	dBm	dBm	dB	dB	
1 pp 1673.04	-53.74	-39.06	-13.00	-40.74	-14.68	Peak
2 2509.56	-55.04	-44.13	-13.00	-42.04	-10.91	Peak



A D T

Data: 4

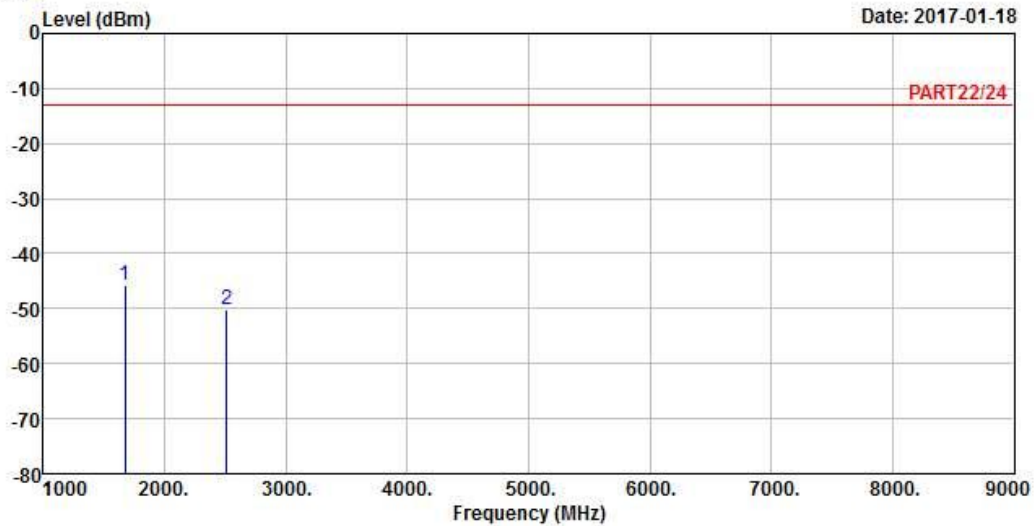

Site : 966 Chamber 5
 Condition: PART22/24 VERTICAL
 Remak : CDMA BC0_M-CH
 Tested by: Gavin Wu

	Freq	Level	Read Level	Limit Line	Over Limit	Factor	Remark
	MHz	dBm	dBm	dBm	dB	dB	
1 pp	1673.04	-45.89	-31.21	-13.00	-32.89	-14.68	Peak
2	2509.56	-50.24	-39.33	-13.00	-37.24	-10.91	Peak

High Channel



Bureau Veritas Consumer Products Services Ltd., Taoyuan Branch

A D T

Data: 5

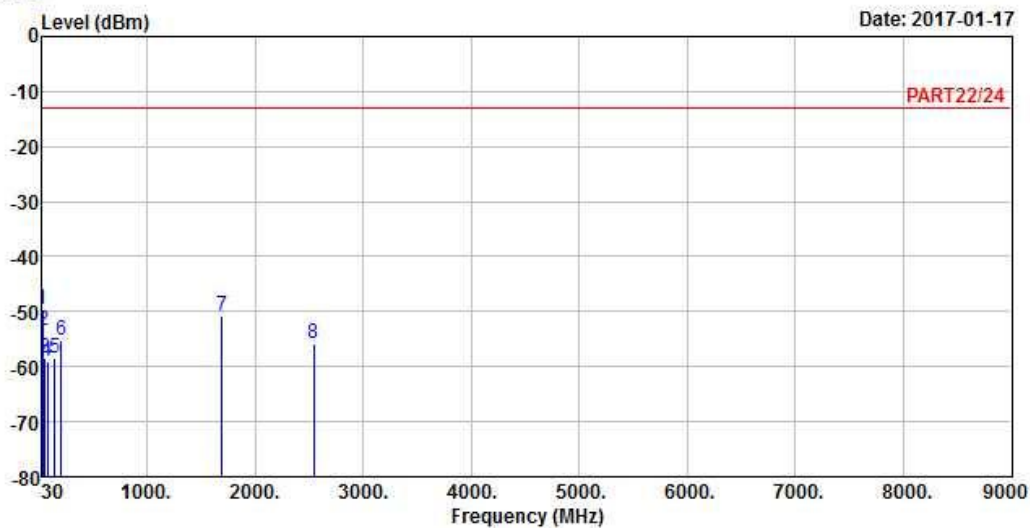

Site : 966 Chamber 5
 Condition: PART22/24 HORIZONTAL
 Remak : CDMA BC0_H-CH
 Tested by: Gavin Wu

	Freq	Level	Read Level	Limit Line	Over Limit	Factor	Remark
	MHz	dBm	dBm	dBm	dB	dB	
1 pp	32.91	-49.54	-48.45	-13.00	-36.54	-1.09	Peak
2	40.67	-53.38	-53.50	-13.00	-40.38	0.12	Peak
3	56.19	-58.31	-51.71	-13.00	-45.31	-6.60	Peak
4	78.50	-58.97	-48.54	-13.00	-45.97	-10.43	Peak
5	142.52	-58.30	-49.94	-13.00	-45.30	-8.36	Peak
6	206.54	-55.16	-47.41	-13.00	-42.16	-7.75	Peak
7	1696.62	-50.81	-36.28	-13.00	-37.81	-14.53	Peak
8	2544.93	-55.73	-44.96	-13.00	-42.73	-10.77	Peak



Bureau Veritas Consumer Products Services Ltd., Taoyuan Branch

A D T

Data: 6

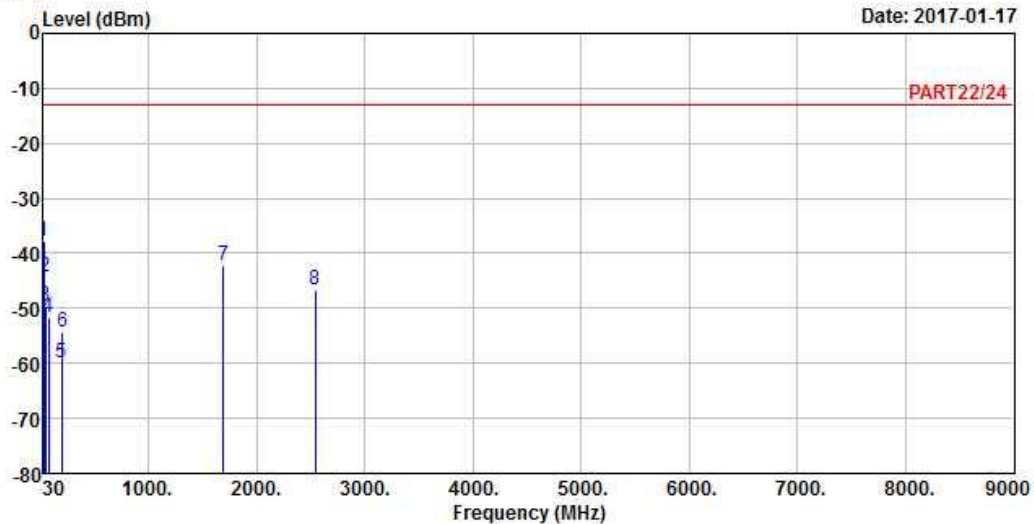

Site : 966 Chamber 5
 Condition: PART22/24 VERTICAL
 Remak : CDMA BC0_H-CH
 Tested by: Gavin Wu

	Freq	Level	Read Level	Limit Line	Over Limit	Factor	Remark
	MHz	dBm	dBm	dBm	dB	dB	
1 pp	30.00	-37.86	-38.24	-13.00	-24.86	0.38	Peak
2	41.64	-44.37	-43.96	-13.00	-31.37	-0.41	Peak
3	50.37	-49.63	-44.62	-13.00	-36.63	-5.01	Peak
4	75.59	-51.53	-41.78	-13.00	-38.53	-9.75	Peak
5	198.78	-59.81	-51.88	-13.00	-46.81	-7.93	Peak
6	207.51	-54.33	-46.62	-13.00	-41.33	-7.71	Peak
7	1696.62	-42.35	-27.82	-13.00	-29.35	-14.53	Peak
8	2544.93	-46.73	-35.96	-13.00	-33.73	-10.77	Peak

LTE Band 5
 Channel Bandwidth: 10 MHz / QPSK
 Low Channel



Bureau Veritas Consumer Products Services Ltd., Taoyuan Branch

A D T

Data: 3

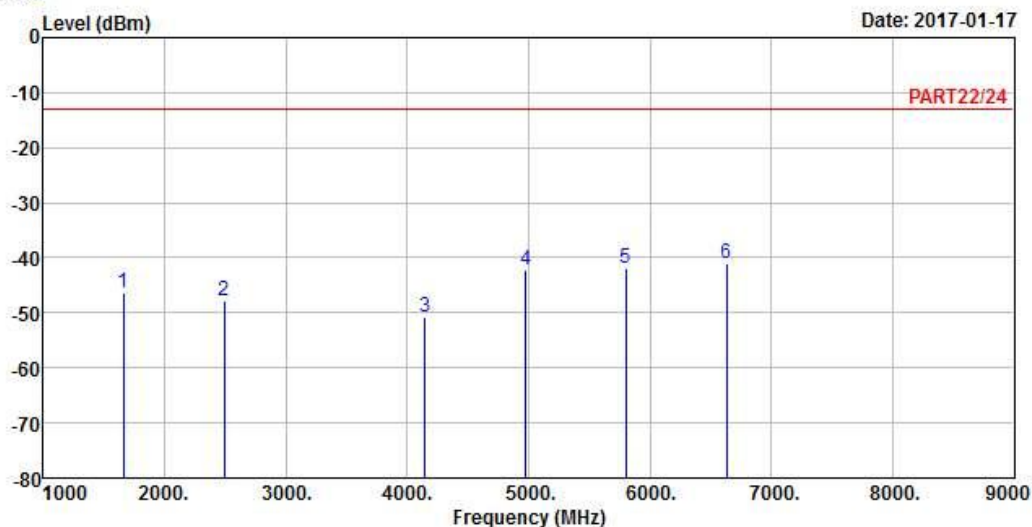

Site : 966 Chamber 5
 Condition: PART22/24 HORIZONTAL
 Remak : LTE Band 5_QPSK_10M_L-CH
 Tested by: Getaz Yang

	Freq	Level	Read Level	Limit Line	Over Limit	Factor	Remark
	MHz	dBm	dBm	dBm	dB	dB	
1	1658.00	-46.42	-31.74	-13.00	-33.42	-14.68	Peak
2	2487.00	-47.78	-37.34	-13.00	-34.78	-10.44	Peak
3	4145.00	-50.65	-43.89	-13.00	-37.65	-6.76	Peak
4	4974.00	-42.22	-39.73	-13.00	-29.22	-2.49	Peak
5	5803.00	-41.93	-41.10	-13.00	-28.93	-0.83	Peak
6 pp	6632.00	-41.00	-43.82	-13.00	-28.00	2.82	Peak



Bureau Veritas Consumer Products Services Ltd., Taoyuan Branch

A D T

Data: 4

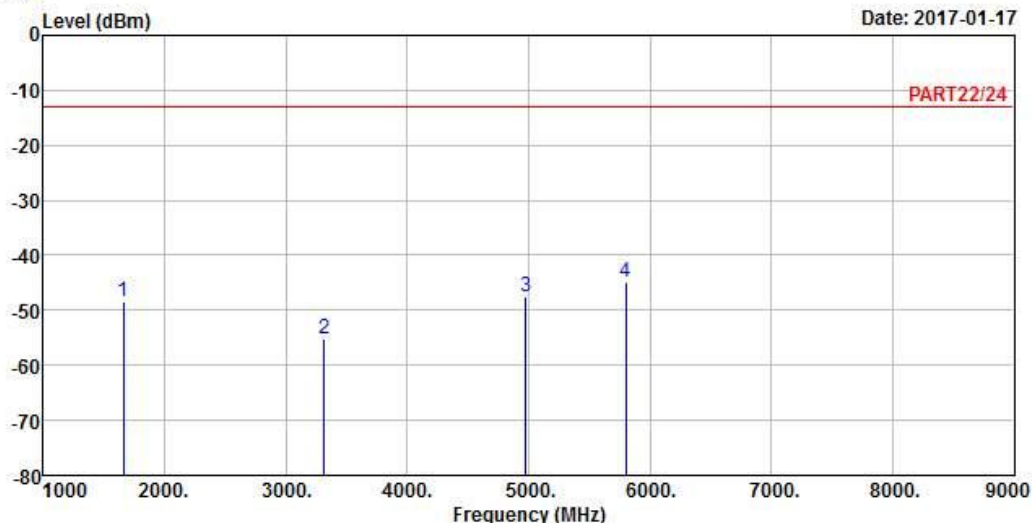

Site : 966 Chamber 5
 Condition: PART22/24 VERTICAL
 Remak : LTE Band 5_QPSK_10M_L-CH
 Tested by: Getaz Yang

	Freq	Level	Read Level	Limit Line	Over Limit	Factor	Remark
	MHz	dBm	dBm	dBm	dB	dB	
1	1658.00	-48.49	-33.81	-13.00	-35.49	-14.68	Peak
2	3316.00	-55.11	-45.61	-13.00	-42.11	-9.50	Peak
3	4974.00	-47.47	-44.98	-13.00	-34.47	-2.49	Peak
4 pp	5803.00	-44.92	-44.09	-13.00	-31.92	-0.83	Peak

Middle Channel



Bureau Veritas Consumer Products Services Ltd., Taoyuan Branch

A D T

Data: 5

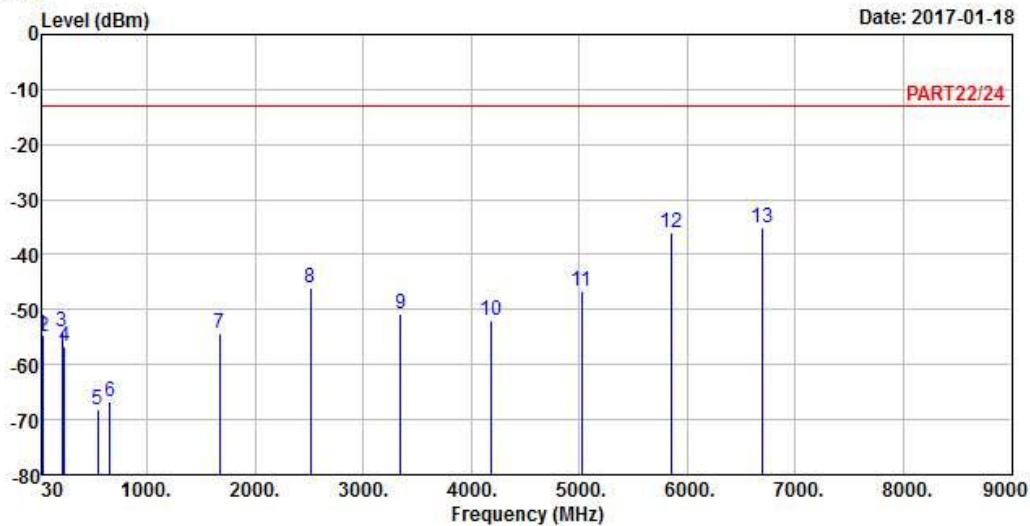

Site : 966 Chamber 5
 Condition: PART22/24 HORIZONTAL
 Remak : LTE Band 5_QPSK_10M_M-CH
 Tested by: Gavin Wu

	Read	Limit	Over				
Freq	Level	Level	Line	Limit	Factor	Remark	
MHz	dBm	dBm	dBm	dB	dB		
1	32.91	-54.66	-53.57	-13.00	-41.66	-1.09	Peak
2	41.64	-54.84	-54.43	-13.00	-41.84	-0.41	Peak
3	209.45	-53.88	-46.25	-13.00	-40.88	-7.63	Peak
4	233.70	-56.60	-49.94	-13.00	-43.60	-6.66	Peak
5	546.04	-68.10	-65.11	-13.00	-55.10	-2.99	Peak
6	653.71	-66.83	-66.01	-13.00	-53.83	-0.82	Peak
7	1673.00	-54.19	-39.51	-13.00	-41.19	-14.68	Peak
8	2509.50	-46.05	-35.14	-13.00	-33.05	-10.91	Peak
9	3346.00	-50.75	-41.21	-13.00	-37.75	-9.54	Peak
10	4182.50	-51.92	-45.30	-13.00	-38.92	-6.62	Peak
11	5019.00	-46.51	-43.28	-13.00	-33.51	-3.23	Peak
12	5855.50	-36.14	-35.88	-13.00	-23.14	-0.26	Peak
13 pp	6692.00	-35.18	-38.26	-13.00	-22.18	3.08	Peak



Bureau Veritas Consumer Products Services Ltd., Taoyuan Branch

A D T

Data: 6

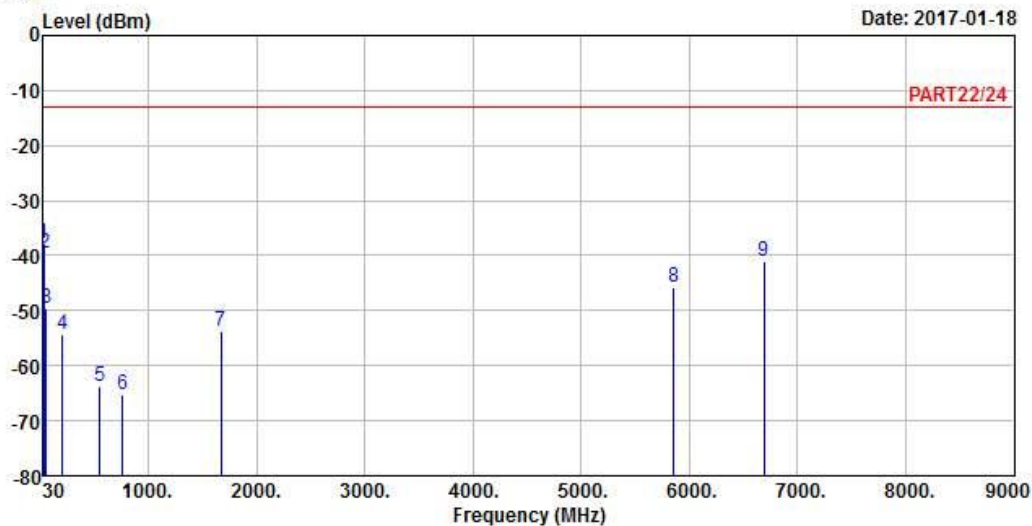

Site : 966 Chamber 5
 Condition: PART22/24 VERTICAL
 Remak : LTE Band 5_QPSK_10M_M-CH
 Tested by: Gavin Wu

	Freq	Level	Read Level	Limit Line	Over Limit	Factor	Remark
	MHz	dBm	dBm	dBm	dB	dB	
1 pp	30.00	-37.85	-38.23	-13.00	-24.85	0.38	Peak
2	40.67	-39.65	-39.77	-13.00	-26.65	0.12	Peak
3	53.28	-49.45	-43.64	-13.00	-36.45	-5.81	Peak
4	205.57	-54.40	-46.61	-13.00	-41.40	-7.79	Peak
5	552.83	-63.75	-61.02	-13.00	-50.75	-2.73	Peak
6	762.35	-65.33	-66.17	-13.00	-52.33	0.84	Peak
7	1673.00	-53.71	-39.03	-13.00	-40.71	-14.68	Peak
8	5855.50	-45.67	-45.41	-13.00	-32.67	-0.26	Peak
9	6692.00	-41.06	-44.14	-13.00	-28.06	3.08	Peak

High Channel



Bureau Veritas Consumer Products Services Ltd., Taoyuan Branch

A D T

Data: 3

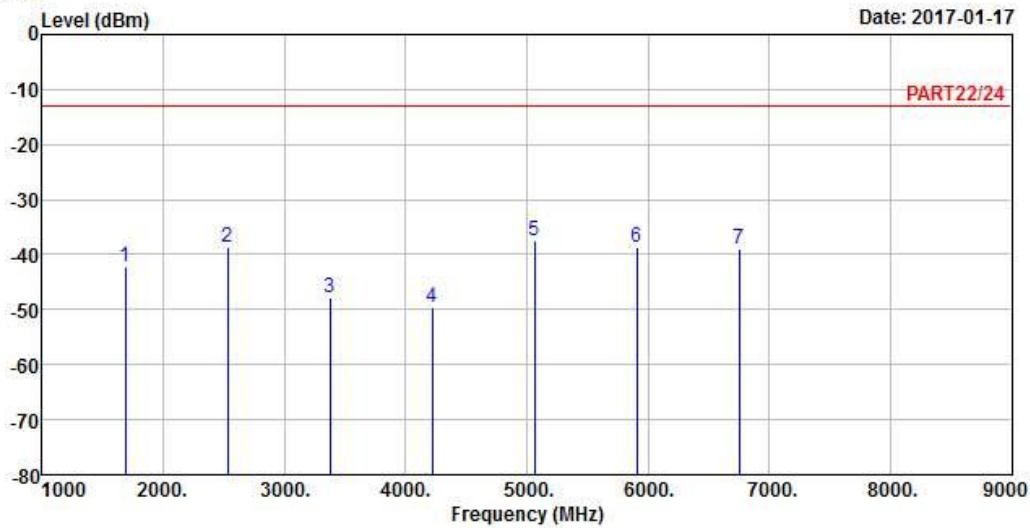

Site : 966 Chamber 5
 Condition: PART22/24 HORIZONTAL
 Remak : LTE Band 5_QPSK_10M_H-CH
 Tested by: Getaz Yang

	Freq	Level	Read Level	Limit Line	Over Limit	Factor	Remark
	MHz	dBm	dBm	dBm	dB	dB	
1	1688.00	-42.31	-27.71	-13.00	-29.31	-14.60	Peak
2	2528.00	-38.60	-27.76	-13.00	-25.60	-10.84	Peak
3	3376.00	-47.90	-38.54	-13.00	-34.90	-9.36	Peak
4	4220.00	-49.71	-42.96	-13.00	-36.71	-6.75	Peak
5 pp	5064.00	-37.40	-34.28	-13.00	-24.40	-3.12	Peak
6	5908.00	-38.55	-38.37	-13.00	-25.55	-0.18	Peak
7	6752.00	-38.98	-42.43	-13.00	-25.98	3.45	Peak



Bureau Veritas Consumer Products Services Ltd., Taoyuan Branch

A D T

Data: 4

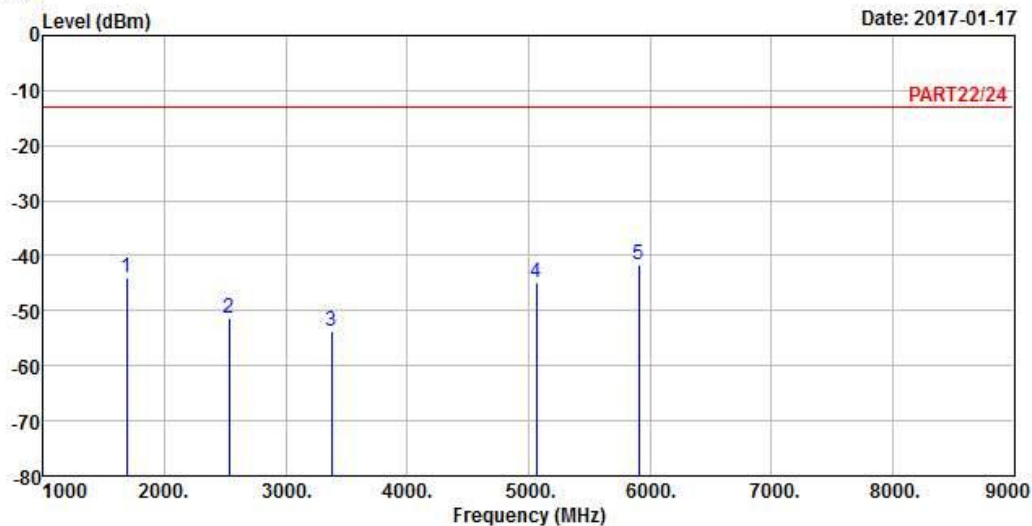

Site : 966 Chamber 5
 Condition: PART22/24 VERTICAL
 Remak : LTE Band 5_QPSK_10M_H-CH
 Tested by: Getaz Yang

	Freq	Level	Read Level	Limit Line	Over Limit	Factor	Remark
	MHz	dBm	dBm	dBm	dB	dB	
1	1688.00	-44.11	-29.51	-13.00	-31.11	-14.60	Peak
2	2532.00	-51.24	-40.40	-13.00	-38.24	-10.84	Peak
3	3376.00	-53.84	-44.48	-13.00	-40.84	-9.36	Peak
4	5064.00	-44.95	-41.83	-13.00	-31.95	-3.12	Peak
5 pp	5908.00	-41.50	-41.32	-13.00	-28.50	-0.18	Peak

5 Pictures of Test Arrangements

Please refer to the attached file (Test Setup Photo).

Appendix – Information on the Testing Laboratories

We, Bureau Veritas Consumer Products Services (H.K.) Ltd., Taoyuan Branch, were founded in 1988 to provide our best service in EMC, Radio, Telecom and Safety consultation. Our laboratories are accredited and approved according to ISO/IEC 17025.

If you have any comments, please feel free to contact us at the following:

Linko EMC/RF Lab

Tel: 886-2-26052180

Fax: 886-2-26051924

Hsin Chu EMC/RF/Telecom Lab

Tel: 886-3-6668565

Fax: 886-3-6668323

Hwa Ya EMC/RF/Safety

Tel: 886-3-3183232

Fax: 886-3-3270892

Email: service.adt@tw.bureauveritas.com

Web Site: www.bureauveritas-adt.com

The address and road map of all our labs can be found in our web site also.

--- END ---