

# FCC LTE REPORT

## FCC Certification

**Applicant Name:**  
Franklin Technology Inc.

**Date of Issue:**  
May 18, 2016

**Location:**

**Address:**  
906, gasan-Dong, JEIPlatz 186, Gasan digital 1-ro,  
Geumcheon-gu, Seoul, Korea (08502)

HCT CO., LTD.,

74, Seoicheon-ro 578beon-gil, Majang-myeon,  
Icheon-si, Gyeonggi-do, 17383, Rep. of KOREA

**Report No.:** HCT-R-1605-F020

**HCT FRN:** 0005866421

**FCC ID:** XHG-R815

**APPLICANT:** Franklin Technology Inc.

**FCC Model(s):** MHS815L  
**EUT Type:** Mobile Router  
**FCC Classification:** PCS Licensed Transmitter (PCB)  
**FCC Rule Part(s):** §27, §2

Mode (MHz)	Tx Frequency (MHz)	Emission Designator	Modulation	EIRP	
				Max. Power (W)	Max. Power (dBm)
LTE – Band4 (5)	1712.5 – 1752.5	4M57G7D	QPSK	0.118	20.74
		4M55W7D	16QAM	0.102	20.08
LTE – Band4 (10)	1715.0 – 1750.0	9M04G7D	QPSK	0.120	20.81
		9M10W7D	16QAM	0.105	20.21
LTE – Band4 (15)	1717.5 – 1747.5	13M6G7D	QPSK	0.139	21.44
		13M6W7D	16QAM	0.119	20.76
LTE – Band4 (20)	1720.0 – 1745.0	18M1G7D	QPSK	0.120	20.78
		18M1W7D	16QAM	0.101	20.03

Mode (MHz)	Tx Frequency (MHz)	Emission Designator	Modulation	ERP	
				Max. Power (W)	Max. Power (dBm)
LTE – Band13 (5)	779.5–784.5	4M55G7D	QPSK	0.061	17.83
		4M57W7D	16QAM	0.049	16.88
LTE – Band13 (10)	782.0	9M05G7D	QPSK	0.041	16.09
		9M10W7D	16QAM	0.033	15.21

The measurements shown in this report were made in accordance with the procedures specified in CFR 47 section 2.947. I assume full responsibility for the accuracy and completeness of these measurements, and for the qualifications of all persons taking them.

**HCT CO., LTD.** Certifies that no party to this application has subject to a denial of Federal benefits that includes FCC benefits pursuant to section 5301 of the Anti-Drug Abuse Act of 1998, 21 U.S. C. 853(a)



Report prepared by  
: Ki Hyun Kim  
Test engineer of RF Team



Approved by  
: Kyoung Houn Seo  
Manager of RF Team

This report only responds to the tested sample and may not be reproduced, except in full, without written approval of the HCT Co., Ltd.

## Version

TEST REPORT NO.	DATE	DESCRIPTION
HCT-R-1605-F020	May 18, 2016	- First Approval Report

# Table of Contents

1. GENERAL INFORMATION .....	6
2. INTRODUCTION .....	8
2.1. EUT DESCRIPTION.....	8
2.2. MEASURING INSTRUMENT CALIBRATION.....	8
2.3. TEST FACILITY .....	8
3. DESCRIPTION OF TESTS .....	9
3.1 ERP/EIRP RADIATED POWER AND RADIATED SPURIOUS EMISSIONS.....	9
3.2 BLOCK B FREQUENCY RANGE (775 – 788 MHz) .....	10
3.3 AWS – MOBILE FREQUENCY BLOCKS (1710 – 1755 MHz) .....	10
3.4 PEAK-AVERAGE RATIO. ....	11
3.5 OCCUPIED BANDWIDTH. ....	13
3.6 SPURIOUS AND HARMONIC EMISSIONS AT ANTENNA TERMINAL.....	14
3.7 FREQUENCY STABILITY / VARIATION OF AMBIENT TEMPERATURE .....	15
4. LIST OF TEST EQUIPMENT .....	16
5. MEASUREMENT UNCERTAINTY.....	17
6. SUMMARY OF TEST RESULTS .....	18
7. SAMPLE CALCULATION.....	19
8. TEST DATA .....	20
8.1 EQUIVALENT ISOTROPIC RADIATED POWER (Band 4) .....	20
8.2 EFFECTIVE RADIATED POWER (Band 13).....	23
8.3 RADIATED SPURIOUS EMISSIONS.....	24
8.3.1 RADIATED SPURIOUS EMISSIONS (5 MHz Band 4 LTE) .....	24
8.3.2 RADIATED SPURIOUS EMISSIONS (10 MHz Band 4 LTE) .....	25
8.3.3 RADIATED SPURIOUS EMISSIONS (15 MHz Band 4 LTE) .....	26
8.3.4 RADIATED SPURIOUS EMISSIONS (20 MHz Band 4 LTE) .....	27
8.3.5 RADIATED SPURIOUS EMISSIONS (5 MHz Band 13 LTE).....	28
8.3.6 RADIATED SPURIOUS EMISSIONS (10 MHz Band 13 LTE).....	29
8.3.6.1 RADIATED SPURIOUS EMISSIONS (1559 ~ 1610 MHz Band).....	30
8.3.6.2 RADIATED SPURIOUS EMISSIONS (1559 ~ 1610 MHz Band).....	30
8.4 PEAK-TO-AVERAGE RATIO .....	31
8.5 OCCUPIED BANDWIDTH .....	32
8.6 CONDUCTED SPURIOUS EMISSIONS .....	33
8.6.1 BAND EDGE.....	34
8.7 FREQUENCY STABILITY / VARIATION OF AMBIENT TEMPERATURE .....	35
8.7.1 FREQUENCY STABILITY (5 MHz Band 4 LTE) .....	35

8.7.2 FREQUENCY STABILITY (10 MHz Band 4 LTE) .....	36
8.7.3 FREQUENCY STABILITY (15 MHz Band 4 LTE) .....	37
8.7.4 FREQUENCY STABILITY (20 MHz Band 4 LTE) .....	38
8.7.5 FREQUENCY STABILITY (5 MHz Band 13LTE) .....	39
8.7.6 FREQUENCY STABILITY (10 MHz Band 13 LTE) .....	40
9. TEST PLOTS.....	41

# MEASUREMENT REPORT

## 1. GENERAL INFORMATION

<b>Applicant Name:</b>	Franklin Technology Inc.	
<b>Address:</b>	906, gasan-Dong,JEIPlatz 186,Gasan digital 1-ro, Geumcheon-gu, Seoul, Korea (08502)	
<b>FCC ID:</b>	XHG-R815	
<b>Application Type:</b>	Certification	
<b>FCC Classification:</b>	PCS Licensed Transmitter (PCB)	
<b>FCC Rule Part(s):</b>	§27, §2	
<b>EUT Type:</b>	Mobile Router	
<b>FCC Model(s):</b>	MHS815L	
<b>Tx Frequency:</b>	1712.5 MHz – 1752.5 MHz (LTE – Band 4 (5 MHz)) 1715.0 MHz – 1750.0 MHz (LTE – Band 4 (10 MHz)) 1717.5 MHz – 1747.5 MHz (LTE – Band 4 (15 MHz)) 1720.0 MHz – 1745.0 MHz (LTE – Band 4 (20 MHz))  779.5 MHz–784.5 MHz (LTE – Band 13 (5MHz)) 782 MHz (LTE – Band 13 (10 MHz))	
<b>Max. RF Output Power:</b>	Band 4 (5 MHz):	0.118W (QPSK) (20.74 dBm) 0.102 W (16-QAM) (20.08 dBm)
	Band 4 (10 MHz):	0.120 W (QPSK) (20.81 dBm) 0.105 W (16-QAM) (20.21 dBm)
	Band 4 (15 MHz):	0.139 W (QPSK) (21.44 dBm) 0.119 W (16-QAM) (20.76 dBm)
	Band 4 (20 MHz):	0.120 W (QPSK) (20.78 dBm) 0.101 W (16-QAM) (20.03 dBm)
	Band 13 ( 5 MHz) :	0.061 W (QPSK) (17.83 dBm) 0.049 W (16-QAM) (16.88 dBm)
	Band 13 (10 MHz) :	0.041 W (QPSK) (16.09 dBm) 0.033 W (16-QAM) (15.21 dBm)
<b>Emission Designator(s):</b>	Band 4 (5 MHz):	4M57G7D (QPSK) / 4M55W7D (16-QAM)
	Band 4 (10 MHz):	9M04G7D (QPSK) / 9M10W7D (16-QAM)
	Band 4 (15 MHz):	13M6G7D (QPSK) / 13M6W7D (16-QAM)
	Band 4 (20 MHz):	18M1G7D (QPSK) / 18M1W7D (16-QAM)
	Band 13 ( 5 MHz) :	4M55G7D (QPSK) / 4M57W7D (16-QAM)
	Band 13 (10 MHz) :	9M05G7D (QPSK) / 9M10W7D (16-QAM)

**Date(s) of Tests:** April 04, 2016 ~ May 18, 2016

**Antenna Specification:** Manufacturer: HUTECH Co.,Ltd  
Antenna type: Internal Antenna  
Peak Gain: Band 4: 3.75dBi  
Band 13: 1.11dBi

## **2. INTRODUCTION**

### **2.1. EUT DESCRIPTION**

The Franklin Technology Inc. MHS815L Mobile Router consists of LTE 4 and 13.

### **2.2. MEASURING INSTRUMENT CALIBRATION**

The measuring equipment, which was utilized in performing the tests documented herein, has been calibrated in accordance with the manufacturer's recommendations for utilizing calibration equipment, which is traceable to recognized national standards.

### **2.3. TEST FACILITY**

The Fully-anechoic chamber and conducted measurement facility used to collect the radiated data are located at the **74, Seoicheon-ro 578beon-gil, Majang-myeon, Icheon-si, Gyeonggi-do, 17383, Rep. of KOREA.**



### **3. DESCRIPTION OF TESTS**

#### **3.1 ERP/EIRP RADIATED POWER AND RADIATED SPURIOUS EMISSIONS**

Note: ERP(Effective Radiated Power), EIRP(Effective Isotropic Radiated Power)

Test Procedure

Radiated emission measurements are performed in the Fully-anechoic chamber. The equipment under test is placed on a non-conductive table 3-meters away from the receive antenna in accordance with ANSI/TIA-603-D-2010 Clause 2.2.17. The turntable is rotated through 360 degrees, and the receiving antenna scans in order to determine the level of the maximized emission. The level and position of the maximized emission is recorded with the spectrum analyzer using a RMS detector.

A half wave dipole is then substituted in place of the EUT. For emissions above 1GHz, a horn antenna is substituted in place of the EUT. The substitute antenna is driven by a signal generator and the previously recorded signal was duplicated.

The power is calculated by the following formula;

$$P_{d(dBm)} = P_{g(dBm)} - \text{cable loss}_{(dB)} + \text{antenna gain}_{(dB)}$$

Where:  $P_d$  is the dipole equivalent power and  $P_g$  is the generator output power into the substitution antenna.

The maximum EIRP is calculated by adding the forward power to the calibrated source plus its appropriate gain value. These steps are repeated with the receiving antenna in both vertical and horizontal polarization. the difference between the gain of the horn and an isotropic antenna are taken into consideration

#### **Radiated spurious emissions**

: Frequency Range : 30 MHz ~ 10<sup>th</sup> Harmonics of highest channel fundamental frequency.

### 3.2BLOCK B FREQUENCY RANGE (775 – 788 MHz)

§27.5(b)

746-758 MHz, 775-788 MHz, and 805-806 MHz bands. The following frequencies are available for licensing pursuant to this part in the 746-758 MHz, 775-788 MHz, and 805-806 MHz bands:

(1) Two paired channels of 1 megahertz each are available for assignment in Block A in the 757-758 MHz and 787-788 MHz bands.

(2) Two paired channels of 1 megahertz each are available for assignment in Block B in the 775-776 MHz and 805-806 MHz bands.

(3) Two paired channels of 11 megahertz each are available for assignment in Block C in the 746-757 MHz and 776-787 MHz bands. In the event that no licenses for two channels in this Block C are assigned based on the results of the first auction in which such licenses were offered because the auction results do not satisfy the applicable reserve price, the spectrum in the 746-757 MHz and 776-787 MHz bands will instead be made available for assignment at a subsequent auction as follows:

(i) Two paired channels of 6 megahertz each available for assignment in Block C1 in the 746-752 MHz and 776-782 MHz bands.

(ii) Two paired channels of 5 megahertz each available for assignment in Block C2 in the 752-757 MHz and 782-787 MHz band.

### 3.3AWS – MOBILE FREQUENCY BLOCKS (1710 – 1755 MHz)

§27.5(h)

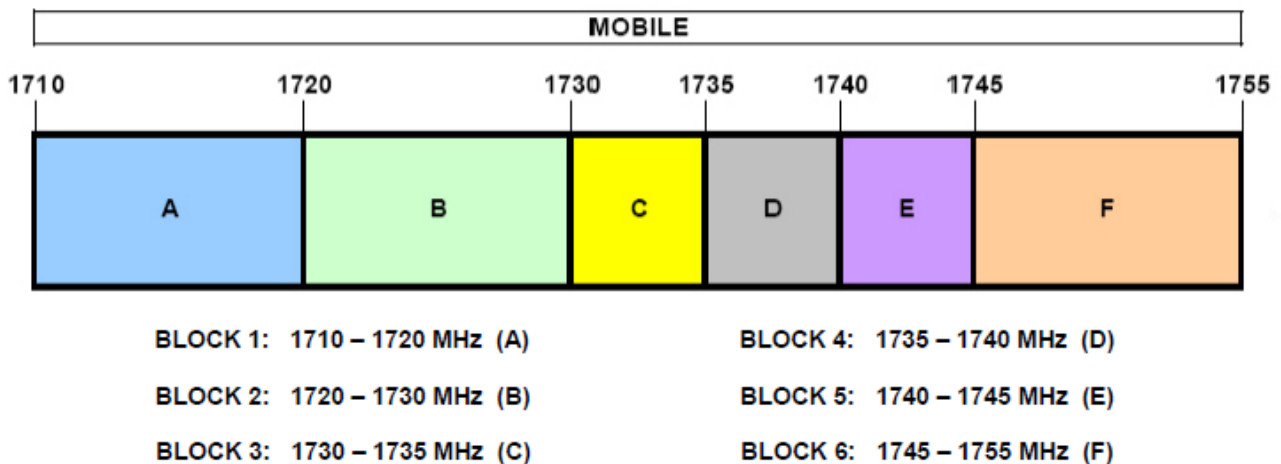

### 3.4 PEAK-AVERAGE RATIO.

#### Test Procedure

Peak to Average Power Ratio is tested in accordance with KDB971168 D01 Power Meas License Digital Systems v02r02, October 17, 2014, Section 5.7.

#### - Section 5.7.1 CCDF Procedure

- a) Set resolution/measurement bandwidth  $\geq$  signal's occupied bandwidth;
- b) Set the number of counts to a value that stabilizes the measured CCDF curve;
- c) Set the measurement interval as follows:
  - 1) for continuous transmissions, set to 1 ms,
  - 2) for burst transmissions, employ an external trigger that is synchronized with the EUT burst timing sequence, or use the internal burst trigger with a trigger level that allows the burst to stabilize and set the measurement interval to a time that is less than or equal to the burst duration.
- d) Record the maximum PAPR level associated with a probability of 0.1%.

#### - Section 5.7.2 Alternate Procedure

Use one of the procedures presented in 5.1 to measure the total peak power and record as  $P_{Pk}$ . Use one of the applicable procedures presented 5.2 to measure the total average power and record as  $P_{Avg}$ . Determine the P.A.R. from:  $P.A.R_{(dB)} = P_{Pk(dBm)} - P_{Avg(dBm)}$  ( $P_{Avg}$  = Average Power + Duty cycle Factor)

#### 5.1.1 Peak power measurements with a spectrum/signal analyzer or EMI receiver

The following procedure can be used to determine the total peak output power.

- a) Set the RBW  $\geq$  OBW.
- b) Set VBW  $\geq 3 \times$  RBW.
- c) Set span  $\geq 2 \times$  RBW
- d) Sweep time = auto couple.
- e) Detector = peak.
- f) Ensure that the number of measurement points  $\geq$  span/RBW.
- g) Trace mode = max hold.
- h) Allow trace to fully stabilize.
- i) Use the peak marker function to determine the peak amplitude level.

## **5.2.2 Procedures for use with a spectrum/signal analyzer when EUT cannot be configured to transmit continuously and sweep triggering/signal gating cannot be properly implemented**

If the EUT cannot be configured to transmit continuously (burst duty cycle < 98%), then one of the following procedures can be used. The selection of the applicable procedure will depend on the characteristics of the measured burst duty cycle.

Measure the burst duty cycle with a spectrum/signal analyzer or EMC receiver can be used in zero-span mode if the response time and spacing between bins on the sweep are sufficient to permit accurate measurement of the burst on/off time of the transmitted signal.

### **5.2.2.2 Constant burst duty cycle**

If the measured burst duty cycle is constant (i.e., duty cycle variations are less than  $\pm 2$  percent), then:

- a) Set span to at least 1.5 times the OBW.
- b) Set RBW = 1-5% of the OBW, not to exceed 1 MHz.
- c) Set VBW  $\geq 3 \times$  RBW.
- d) Number of points in sweep  $\geq 2 \times$  span / RBW. (This gives bin-to-bin spacing  $\leq$  RBW/2, so that narrowband signals are not lost between frequency bins.)
- e) Sweep time = auto.
- f) Detector = RMS (power averaging).
- g) Set sweep trigger to "free run".
- h) Trace average at least 100 traces in power averaging (i.e., RMS) mode.
- i) Compute power by integrating the spectrum across the OBW of the signal using the instrument's band power measurement function with band limits set equal to the OBW band edges. If the instrument does not have a band power function, sum the spectrum levels (in power units) at intervals equal to the RBW extending across the entire OBW of the spectrum.
- j) Add  $10 \log (1/x)$ , where  $x$  is the duty cycle, to the measured power in order to compute the average power during the actual transmission times (because the measurement represents an average over both the on and off times of the transmission).

For example, add  $10 \log (1/0.25) = 6$  dB if the duty cycle is a constant 25%.

### 3.5 OCCUPIED BANDWIDTH.

Test set-up

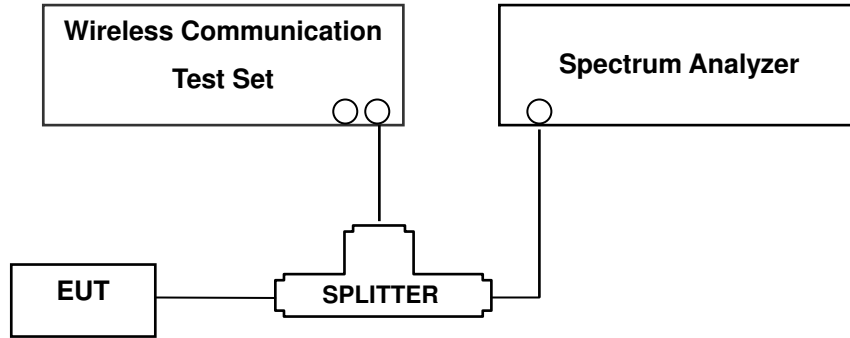

(Configuration of conducted Emission measurement)

The width of a frequency band such that, below the lower and above the upper frequency limits, the mean powers emitted are each equal to a specified percentage 0.5 % of the total mean power of a given emission.

#### Test Procedure

OBW is tested in accordance with KDB971168 D01 Power Meas License Digital Systems v02r02, October 17, 2014, Section 4.2.

The EUT makes a call to the communication simulator. The power was measured with R&S Spectrum Analyzer. All measurements were done at 3 channels(low, middle and high operational range.)

The conducted occupied bandwidth used the power splitter via EUT RF power connector between simulation base station and spectrum analyzer.

The communication simulator station system controlled a EUT to export maximum output power under transmission mode and specific channel frequency. Use OBW measurement function of Spectrum analyzer to measure 99 % occupied bandwidth

### 3.6 SPURIOUS AND HARMONIC EMISSIONS AT ANTENNA TERMINAL.

#### Test Procedure

Spurious and harmonic emissions at antenna terminal is tested in accordance with KDB971168 D01 Power Meas License Digital Systems v02r02, October 17, 2014, Section 6.0.

The level of the carrier and the various conducted spurious and harmonic frequencies is measured by means of a calibrated spectrum analyzer.

The spectrum is scanned from the lowest frequency generated in the equipment up to a frequency including its 10th harmonic. On any frequency outside a licensee's frequency block, the power of any emission shall be attenuated below the transmitter power (P) by at least  $43 + 10 \log(P)$  dB. Compliance with these provisions is based on the use of measurement instrumentation employing a resolution bandwidth of 1 MHz or greater. However, in the 100 kHz bands immediately outside and adjacent to the frequency block a resolution bandwidth of at least 30kHz bandwidth may be employed. The emission bandwidth is defined as the width of the signal between two points, one below the carrier center frequency and one above the carrier center frequency

Additionally, for operations in the 776-788MHz band, the power of any emission outside the licensee's frequency band of operation shall be attenuated below the transmitted power (P) within the licensed band(s) of operation, measured in watts, in accordance with the following:

- (1) On any frequency outside the 776-788MHz band, the power of any emission shall be attenuated outside the band below the transmitter power (P) by at least  $43+10\log(P)$ dB.
- (2) On all frequencies between 763-775 and 793-805MHz, by a factor not less than  $65+10\log(P)$ dB in a 6.25kHz band segment.

For operations in the 788–793 MHz band, the power of any emission outside the licensee's frequency bands of operation shall be attenuated below the transmitter power (P) within the licensed band(s) of operation, measured in watts, in accordance with the following:

- (1) On all frequencies between 769–775 MHz and 799–805 MHz, by a factor not less than  $65 + 10 \log (P)$  dB in a 6.25 kHz band segment, for mobile and portable stations;
- (2) On any frequency between 775–788 MHz, above 805 MHz, and below 758 MHz, by at least  $43 + 10 \log (P)$  dB

**NOTES:** The analyzer plot offsets were determined by below conditions.

- For LTE Band 4, total offset 27.2 dB = 20 dB attenuator + 6 dB Divider + 1.2 dB RF cables.
- For LTE Band 13 total offset 26.4 dB = 20 dB attenuator + 6 dB Divider + 0.4 dB RF cables.

### 3.7 FREQUENCY STABILITY / VARIATION OF AMBIENT TEMPERATURE

#### Test Set-up

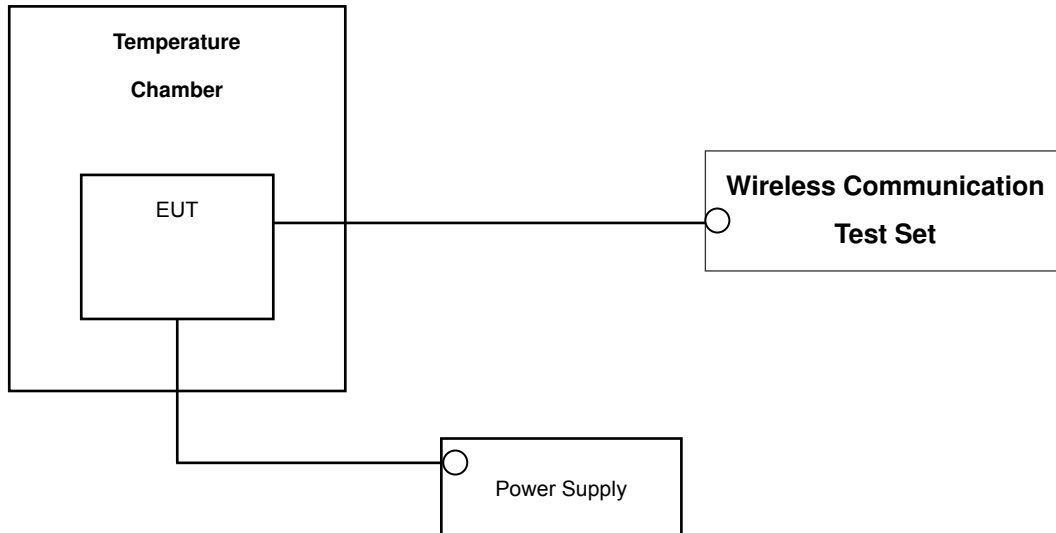

\* Nominal Operating Voltage

#### Test Procedure

Frequency stability is tested in accordance with ANSI/TIA-603-D-2010 section 2.2.2

The frequency stability of the transmitter is measured by:

- a.) **Temperature:** The temperature is varied from - 30 °C to + 50 °C using an environmental chamber.
- b.) **Primary Supply Voltage:** The primary supply voltage is varied from the end point to 100 % of the voltage normally at the input to the device or at the power supply terminals if cables are not normally supplied.

Specification — the frequency stability shall be sufficient to ensure that the fundamental emission stays within the authorized frequency block

#### Time Period and Procedure:

The carrier frequency of the transmitter is measured at room temperature (20°C to provide a reference).

1. The equipment is turned on in a “standby” condition for one minute before applying power to the transmitter. Measurement of the carrier frequency of the transmitter is made within one minute after applying power to the transmitter.
2. Frequency measurements are made at 10°C intervals ranging from -30°C to +50°C. A period of at least one half-hour is provided to allow stabilization of the equipment at each temperature level.

**NOTE: The EUT is tested down to the battery endpoint.**

## 4. LIST OF TEST EQUIPMENT

Manufacture	Model/ Equipment	Serial Number	Calibration Interval	Calibration Due
MITEQ	AMF-6D-001180-35-20P/AMP	1081666	Annual	09/03/2016
Wainwright	WHK1.2/15G-10EF/H.P.F	4	Annual	04/11/2017
Wainwright	WHK3.3/18G-10EF/H.P.F	2	Annual	04/11/2017
Hewlett Packard	11667B / Power Splitter	10545	Annual	02/15/2017
Hewlett Packard	11667B / Power Splitter	11275	Annual	04/29/2017
ITECH	IT6720/ Power Supply	0100215626700119	Annual	11/02/2016
Schwarzbeck	UHAP/ Dipole Antenna	557	Biennial	03/23/2017
Schwarzbeck	UHAP/ Dipole Antenna	558	Biennial	03/23/2017
EXP	EX-TH400/ Chamber	None	Annual	05/29/2016
Schwarzbeck	BBHA 9120D/ Horn Antenna	147	Biennial	09/01/2016
Schwarzbeck	BBHA 9120D/ Horn Antenna	1299	Biennial	05/15/2017
Schwarzbeck	BBHA 9170/ Horn Antenna(15~40GHz)	BBHA9170342	Biennial	04/30/2017
Schwarzbeck	BBHA 9170/ Horn Antenna(15~35GHz)	BBHA9170124	Biennial	04/30/2017
Agilent	N9020A/Signal Analyzer	MY52090906	Annual	05/13/2017
Hewlett Packard	8493C/ATTENUATOR	17280	Annual	06/29/2016
REOHDE&SCHWARZ	FSV40/Spectrum Analyzer	1307.9002K40-100931-NK	Annual	06/04/2016
Agilent	8960 (E5515C)/ Base Station	MY48360800	Annual	10/30/2016
Anritsu Corp.	MT8820C/Wideband Radio Communication Tester	6200863156	Annual	02/26/2017
Anritsu Corp.	MT8820C/Wideband Radio Communication Tester	6201026545	Annual	02/16/2017
Schwarzbeck	VULB9160/ Bilog Antenna	3150	Biennial	11/17/2016
Schwarzbeck	VULB9160/ Bilog Antenna	3368	Biennial	10/10/2016



## 5. MEASUREMENT UNCERTAINTY

The measurement uncertainties shown below were calculated in accordance with the requirements of ANSI C63.4:2014.

All measurement uncertainty values are shown with a coverage factor of  $k = 2$  to indicate a 95 % level of confidence. The measurement data shown herein meets or exceeds the  $U_{\text{CISPR}}$  measurement uncertainty values specified in CISPR 16-4-2 and, thus, can be compared directly to specified limits to determine compliance.

Parameter	Expanded Uncertainty ( $\pm$ dB)
Conducted Disturbance (150 kHz ~ 30 MHz)	1.82
Radiated Disturbance (9 kHz ~ 30 MHz)	3.40
Radiated Disturbance (30 MHz ~ 1 GHz)	4.80
Radiated Disturbance (1 GHz ~ 18 GHz)	6.07

## 6. SUMMARY OF TEST RESULTS

FCC Part Section(s)	Test Description	Test Limit	Test Condition	Test Result
2.1049	Occupied Bandwidth	N/A	CONDUCTED	PASS
2.1051, 27.53(c), 27.53(h)	Band Edge / Spurious and Harmonic Emissions at Antenna Terminal.	< 43 +10 log <sub>10</sub> (P[Watts]) at Band Edge and for all-of-band emissions <65 + 10 log (P[Watts]) in a 6.25kHz bandwidth for emissions in the 777–787 MHz bands		PASS
27.50(d)(5)	Peak-Average Ratio	< 13 dB		PASS
2.1046	*Conducted Output Power	N/A		PASS
2.1055, 27.54	Frequency stability / variation of ambient temperature	Emission must remain in band		PASS
27.50(b)(10)	Effective Radiated Power (Band 13)	< 3 Watts max. ERP	RADIATED	PASS
27.50(d)(4)	Equivalent Isotropic Radiated Power (Band 4)	< 1 Watts max. EIRP		PASS
2.1051, 27.53(h)	Undesirable Out-of-Band Emissions	< 43 +10 log <sub>10</sub> (P[Watts]) for all out-of-band emissions		PASS
2.1053,27.53(f)	Undesirable Emissions in the 1559 – 1610 MHz band	< -70dBW/MHz EIRP (wideband) < -80dBW EIRP (narrowband)		PASS

\*: See SAR Report

### Note regarding all Emission Mask test plots:

The FCC limit is  $65 + 10\log_{10}(P_{\text{Watts}}) = -35$  dBm in a 6.25 kHz bandwidth. Since it was not possible to set the resolution bandwidth to 6.25 kHz with the available equipment, a bandwidth of 10 kHz was used instead to show compliance. By using a 10 kHz bandwidth, the limit was adjusted by  $10\log_{10}(10 \text{ kHz}/6.25 \text{ kHz}) = 2.04$  dB. Thus, the limit shown in all emission mask plots for all available modulation types was  $-35$  dBm + 2.04 dB =  $-32.96$  dBm.

## 7. SAMPLE CALCULATION

### A. EIRP Sample Calculation

Mode	Ch./ Freq.		Measured Level(dBm)	Substitute LEVEL(dBm)	Ant. Gain (dBi)	C.L	Pol.	Limit	EIRP	
	channel	Freq.(MHz)						W	W	dBm
LTE Band4	20175	1,732.50	-15.75	18.45	9.90	1.76	H	<1.00	0.456	26.59

**EIRP = SubstituteLEVEL(dBm) + Ant. Gain – CL(Cable Loss)**

- 1) The EUT mounted on a wooden tripod is 2.5 meter above test site ground level.
- 2) During the test , the turn table is rotated and the antenna height is found.
- 3) Record the field strength meter's level.
- 4) Replace the EUT with dipole/Horn antenna that is connected to a calibrated signal generator.
- 5) Increase the signal generator output till the field strength meter's level is equal to the item (3).
- 6) The signal generator output level with Ant. Gain and cable loss are the rating of effective radiated power (**EIRP**).

## B. Emission Designator

### QPSK Modulation

**Emission Designator = 4M48G7D**

LTE BW = 4.48 MHz

G = Phase Modulation

7 = Quantized/Digital Info

D = Data transmission; telemetry; telecommand

### 16QAM Modulation

**Emission Designator = 4M48W7D**

LTE BW = 4.48 MHz

W = main carrier modulated in a combination of two

or more of the following modes;

amplitude, angle, pulse

7 = Quantized/Digital Info

D = Data transmission; telemetry; telecommand

## 8. TEST DATA

### 8.1 EQUIVALENT ISOTROPIC RADIATED POWER (Band 4)

Freq (MHz)	Bandwidth (MHz)	Modulation	Measured Level (dBm)	Substitute Level (dBm)	Ant. Gain(dBi)	C.L	Pol	Limit	EIRP	
								W	W	dBm
1712.5	5	QPSK	-24.13	9.21	9.37	2.45	H	< 1.00	0.041	16.13
		16-QAM	-24.86	8.48	9.37	2.45	H		0.035	15.40
1732.5		QPSK	-19.55	13.77	9.44	2.47	H		0.118	20.74
		16-QAM	-20.21	13.11	9.44	2.47	H		0.102	20.08
1752.5		QPSK	-23.71	9.61	9.51	2.47	H		0.046	16.65
		16-QAM	-24.43	8.89	9.51	2.47	H		0.039	15.93

#### Equivalent Isotropic Radiated Power Data (5 MHz Band4 LTE)

Note: All of RB size has been tested for emissions and EIRP, with the 1RB configuration observed as the worst case

Freq (MHz)	Bandwidth (MHz)	Modulation	Measured Level (dBm)	Substitute Level (dBm)	Ant. Gain(dBi)	C.L	Pol	Limit	EIRP	
								W	W	dBm
1715.0	10	QPSK	-24.62	8.72	9.39	2.46	H	< 1.00	0.037	15.65
		16-QAM	-25.35	7.99	9.39	2.46	H		0.031	14.92
1732.5		QPSK	-19.48	13.84	9.44	2.47	H		0.120	20.81
		16-QAM	-20.08	13.24	9.44	2.47	H		0.105	20.21
1750.0		QPSK	-24.40	8.92	9.51	2.47	H		0.039	15.96
		16-QAM	-25.10	8.22	9.51	2.47	H		0.034	15.26

#### Equivalent Isotropic Radiated Power Data (10 MHz Band4 LTE)

Note: All of RB size has been tested for emissions and EIRP, with the 1RB configuration observed as the worst case

Freq (MHz)	Bandwidth (MHz)	Modulation	Measured Level (dBm)	Substitute Level (dBm)	Ant. Gain(dBi)	C.L	Pol	Limit	EIRP	
								W	W	dBm
1717.5	15	QPSK	-23.71	9.63	9.40	2.47	H	< 1.00	0.045	16.56
		16-QAM	-24.56	8.78	9.40	2.47	H		0.037	15.71
1732.5		QPSK	-18.85	14.47	9.44	2.47	H		0.139	21.44
		16-QAM	-19.53	13.79	9.44	2.47	H		0.119	20.76
1747.5		QPSK	-22.31	11.01	9.51	2.47	H		0.064	18.05
		16-QAM	-23.11	10.21	9.51	2.47	H		0.053	17.25

**Equivalent Isotropic Radiated Power Data (15 MHz Band4 LTE)**

Note: All of RB size has been tested for emissions and EIRP, with the 1RB configuration observed as the worst case

Freq (MHz)	Bandwidth (MHz)	Modulation	Measured Level (dBm)	Substitute Level (dBm)	Ant. Gain(dBi)	C.L	Pol	Limit	EIRP	
								W	W	dBm
1720.0	20	QPSK	-23.61	9.73	9.40	2.47	H	< 1.00	0.046	16.66
		16-QAM	-24.33	9.01	9.40	2.47	H		0.039	15.94
1732.5		QPSK	-19.51	13.81	9.44	2.47	H		0.120	20.78
		16-QAM	-20.26	13.06	9.44	2.47	H		0.101	20.03
1745.0		QPSK	-20.53	12.83	9.49	2.47	H		0.097	19.85
		16-QAM	-21.28	12.08	9.49	2.47	H		0.081	19.10

**Equivalent Isotropic Radiated Power Data (20 MHz Band4 LTE)**

Note: All of RB size has been tested for emissions and EIRP, with the 1RB configuration observed as the worst case

**NOTES:**

Equivalent Isotropic Radiated Power Measurements by Substitution Method

according to ANSI/TIA/EIA-603-D-2010 June 24, 2010:

The EUT was placed on a non-conductive styrofoam resin table 3-meters from the receive antenna. The receive antenna height and turntable rotation was adjusted for the highest reading on the receive spectrum analyzer. For LTE signals, RBW = 1-5% of the OBW, not to exceed 1MHz, VBW  $\geq 3 \times$  RBW, Detector = RMS. A Horn antenna was substituted in place of the EUT. This Horn antenna was driven by a signal generator and the level of the signal generator was adjusted to obtain the same receive spectrum analyzer reading. The conducted power at the terminals of the Horn antenna is measured. The difference between the gain of the horn and an isotropic antenna is taken into consideration and the EIRP is recorded.

Also, we have done x, y, z planes in EUT and horizontal and vertical polarization in detecting antenna. The worst case of the EUT is x plane in LTE mode. Also worst case of detecting Antenna is horizontal polarization in LTE mode.

### 8.2EFFECTIVE RADIATED POWER (Band 13)

Freq (MHz)	Bandwidth (MHz)	Modulation	Measured Level (dBm)	Substitute Level (dBm)	Ant. Gain(dBd)	C.L	Pol	Limit	ERP	
								W	W	dBm
779.5	5	QPSK	-33.05	28.32	-10.58	1.63	V	< 3.00	0.041	16.11
		16-QAM	-34.00	27.37	-10.58	1.63	V		0.033	15.16
782.0		QPSK	-31.47	30.07	-10.60	1.64	V		0.061	17.83
		16-QAM	-32.42	29.12	-10.60	1.64	V		0.049	16.88
784.5		QPSK	-32.05	29.70	-10.61	1.64	V		0.056	17.45
		16-QAM	-32.85	28.90	-10.61	1.64	V		0.046	16.65

**Effective Radiated Power Data (5 MHz Band 13 LTE)**

Note: All of RB size has been tested for emissions and ERP, with the 1RB configuration observed as the worst case

Freq (MHz)	Bandwidth (MHz)	Modulation	Measured Level (dBm)	Substitute Level (dBm)	Ant. Gain(dBd)	C.L	Pol	Limit	ERP	
								W	W	dBm
782.0	10	QPSK	-33.21	28.33	-10.60	1.64	V	< 3.00	0.041	16.09
		16-QAM	-34.09	27.45	-10.60	1.64	V		0.033	15.21

**Effective Radiated Power Data (10 MHz Band 13 LTE)**

Note: All of RB size has been tested for emissions and ERP, with the 1RB configuration observed as the worst case

**NOTES:**

Effective Radiated Power Output Measurements by Substitution Method

according to ANSI/TIA/EIA-603-D-2010 June 24, 2010:

The EUT was placed on a non-conductive styrofoam resin table 3-meters from the receive antenna. The receive antenna height and turntable rotation was adjusted for the highest reading on the receive spectrum analyzer. For LTE signals, RBW = 1-5% of the OBW, not to exceed 1MHz, VBW ≥ 3 x RBW, Detector = RMS. A half-wave dipole was substituted in place of the EUT. This dipole antenna was driven by a signal generator and the level of the signal generator was adjusted to obtain the same receive spectrum analyzer reading. The conducted power at the terminals of the dipole is measured. The ERP is recorded.

Also, we have done x, y, z planes in EUT and horizontal and vertical polarization in detecting antenna. The worst case of the EUT is y plane in LTE mode. Also worst case of detecting Antenna is vertical polarization in LTE mode.

### 8.3 RADIATED SPURIOUS EMISSIONS

#### 8.3.1 RADIATED SPURIOUS EMISSIONS (5 MHz Band 4 LTE)

- ▣ OPERATING FREQUENCY: 1732.50 MHz
- ▣ MEASURED OUTPUT POWER: 20.74dBm = 0.118 W
- ▣ MODULATION SIGNAL: 5 MHz QPSK
- ▣ DISTANCE: 3 meters
- ▣ LIMIT:  $43 + 10 \log_{10}(W) =$  33.74dBc

Ch	Freq (MHz)	Measured Level (dBm)	Ant. Gain (dBi)	Substitute Level (dBm)	C.L	Pol	EIRP (dBm)	dBc
19975 (1712.5)	3,425.00	-57.34	12.20	-56.98	3.58	V	-48.36	69.10
	5,137.50	-58.05	12.77	-50.42	4.61	V	-42.26	63.00
	6,850.00	-57.62	12.04	-43.77	5.50	V	-37.23	57.97
20175 (1732.5)	3,465.00	-58.11	12.28	-57.22	3.52	V	-48.46	69.20
	5,197.50	-58.63	12.86	-51.49	4.74	V	-43.37	64.11
	6,930.00	-57.74	11.87	-42.34	5.57	V	-36.04	56.78
20375 (1752.5)	3,505.00	-58.11	12.35	-56.62	3.70	V	-47.97	68.71
	5,257.50	-58.50	12.95	-51.82	4.72	V	-43.59	64.33
	7,010.00	-57.87	11.73	-43.71	5.47	V	-37.45	58.19

- NOTES:**
1. Radiated Spurious Emission Measurements at 3 meters by Substitution Method according to ANSI/TIA/EIA-603-D-2010 June 24, 2010:
  2. We are performed all frequency to 10<sup>th</sup> harmonics from 30 MHz. Measurements above show only up to 3 maximum emissions noted, or would be lesser if no specific emissions from the EUT are recorded (ie: margin > 20 dB from the applicable limit) and considered that's already beyond the background noise floor.
  3. We have done x, y, z planes in EUT and horizontal and vertical polarization in detecting antenna.
  4. All of RB size has been tested for emissions and EIRP, with the 1RB configuration observed as the worst case
  5. We are performed 16QAM and QPSK modulations. The worst case data are reported in the table above.



### 8.3.2 RADIATED SPURIOUS EMISSIONS (10 MHz Band 4 LTE)

- ▣ OPERATING FREQUENCY: 1732.50 MHz
- ▣ MEASURED OUTPUT POWER: 20.81dBm = 0.120 W
- ▣ MODULATION SIGNAL: 10 MHz QPSK
- ▣ DISTANCE: 3 meters
- ▣ LIMIT:  $43 + 10 \log_{10}(W) =$  33.81dBc

Ch	Freq (MHz)	Measured Level (dBm)	Ant. Gain (dBi)	Substitute Level (dBm)	C.L	Pol	EIRP (dBm)	dBc
20000 (1715.0)	3,430.00	-57.50	12.21	-57.11	3.58	V	-48.48	69.29
	5,145.00	-59.38	12.78	-51.90	4.60	V	-43.72	64.53
	6,860.00	-58.09	12.01	-44.27	5.49	V	-37.75	58.56
20175 (1732.5)	3,465.00	-58.33	12.28	-57.44	3.52	V	-48.68	69.49
	5,197.50	-58.27	12.86	-51.13	4.74	V	-43.01	63.82
	6,930.00	-57.80	11.87	-42.40	5.57	V	-36.10	56.91
20350 (1750.0)	3,500.00	-57.73	12.35	-56.25	3.70	V	-47.60	68.41
	5,250.00	-58.16	12.93	-51.23	4.65	V	-42.95	63.76
	7,000.00	-57.18	11.73	-43.43	5.45	V	-37.15	57.96

- NOTES:**
1. Radiated Spurious Emission Measurements at 3 meters by Substitution Method according to ANSI/TIA/EIA-603-D-2010 June 24, 2010:
  2. We are performed all frequency to 10<sup>th</sup> harmonics from 30 MHz. Measurements above show only up to 3 maximum emissions noted, or would be lesser if no specific emissions from the EUT are recorded (ie: margin > 20 dB from the applicable limit) and considered that's already beyond the background noise floor.
  3. We have done x, y, z planes in EUT and horizontal and vertical polarization in detecting antenna.
  4. All of RB size has been tested for emissions and EIRP, with the 1RB configuration observed as the worst case
  5. We are performed 16QAM and QPSK modulations. The worst case data are reported in the table above.

### 8.3.3 RADIATED SPURIOUS EMISSIONS (15 MHz Band 4 LTE)

- ▣ OPERATING FREQUENCY: 1732.50 MHz
- ▣ MEASURED OUTPUT POWER: 21.44dBm = 0.139 W
- ▣ MODULATION SIGNAL: 15 MHz QPSK
- ▣ DISTANCE: 3 meters
- ▣ LIMIT:  $43 + 10 \log_{10}(W) =$  34.44dBc

Ch	Freq (MHz)	Measured Level (dBm)	Ant. Gain (dBi)	Substitute Level (dBm)	C.L	Pol	EIRP (dBm)	dBc
20025 (1717.5)	3,435.00	-57.79	12.22	-57.26	3.57	V	-48.60	70.04
	5,152.50	-58.60	12.79	-51.27	4.59	V	-43.07	64.51
	6,870.00	-58.27	11.99	-44.09	5.47	V	-37.57	59.01
20175 (1732.5)	3,465.00	-58.18	12.28	-57.29	3.52	V	-48.53	69.97
	5,197.50	-58.48	12.86	-51.34	4.74	V	-43.22	64.66
	6,930.00	-57.07	11.87	-41.67	5.57	V	-35.37	56.81
20325 (1747.5)	3,495.00	-57.18	12.34	-55.83	3.65	V	-47.14	68.58
	5,242.50	-57.84	12.92	-51.05	4.61	V	-42.74	64.18
	6,990.00	-57.08	11.75	-41.60	5.44	V	-35.29	56.73

- NOTES:**
1. Radiated Spurious Emission Measurements at 3 meters by Substitution Method according to ANSI/TIA/EIA-603-D-2010 June 24, 2010:
  2. We are performed all frequency to 10<sup>th</sup> harmonics from 30 MHz. Measurements above show only up to 3 maximum emissions noted, or would be lesser if no specific emissions from the EUT are recorded (ie: margin > 20 dB from the applicable limit) and considered that's already beyond the background noise floor.
  3. We have done x, y, z planes in EUT and horizontal and vertical polarization in detecting antenna.
  4. All of RB size has been tested for emissions and EIRP, with the 1RB configuration observed as the worst case
  5. We are performed 16QAM and QPSK modulations. The worst case data are reported in the table above.

### 8.3.4 RADIATED SPURIOUS EMISSIONS (20 MHz Band 4 LTE)

- ▣ OPERATING FREQUENCY: 1732.50 MHz
- ▣ MEASURED OUTPUT POWER: 20.78dBm = 0.120 W
- ▣ MODULATION SIGNAL: 20 MHz QPSK
- ▣ DISTANCE: 3 meters
- ▣ LIMIT:  $43 + 10 \log_{10}(W) =$  33.78dBc

Ch	Freq (MHz)	Measured Level (dBm)	Ant. Gain (dBi)	Substitute Level (dBm)	C.L	Pol	EIRP (dBm)	dBc
20050 (1720.0)	3,440.00	-56.52	12.23	-55.85	3.55	V	-47.17	67.95
	5,160.00	-57.71	12.80	-50.50	4.65	V	-42.35	63.13
	6,880.00	-57.76	11.97	-43.27	5.42	V	-36.72	57.50
20175 (1732.5)	3,465.00	-57.72	12.28	-56.83	3.52	H	-48.07	68.85
	5,197.50	-57.75	12.86	-50.61	4.74	V	-42.49	63.27
	6,930.00	-57.13	11.87	-41.73	5.57	V	-35.43	56.21
20300 (1745.0)	3,490.00	-58.50	12.33	-57.29	3.59	H	-48.55	69.33
	5,235.00	-57.36	12.91	-50.42	4.62	V	-42.13	62.91
	6,980.00	-56.75	11.77	-41.03	5.58	V	-34.84	55.62

- NOTES:**
1. Radiated Spurious Emission Measurements at 3 meters by Substitution Method according to ANSI/TIA/EIA-603-D-2010 June 24, 2010:
  2. We are performed all frequency to 10<sup>th</sup> harmonics from 30 MHz. Measurements above show only up to 3 maximum emissions noted, or would be lesser if no specific emissions from the EUT are recorded (ie: margin > 20 dB from the applicable limit) and considered that's already beyond the background noise floor.
  3. We have done x, y, z planes in EUT and horizontal and vertical polarization in detecting antenna.
  4. All of RB size has been tested for emissions and EIRP, with the 1RB configuration observed as the worst case
  5. We are performed 16QAM and QPSK modulations. The worst case data are reported in the table above.

### 8.3.5 RADIATED SPURIOUS EMISSIONS (5 MHz Band 13 LTE)

- ▣ OPERATING FREQUENCY: 782.00 MHz
- ▣ MEASURED OUTPUT POWER: 17.83dBm = 0.061 W
- ▣ MODULATION SIGNAL: 5 MHz QPSK
- ▣ DISTANCE: 3 meters
- ▣ LIMIT:  $43 + 10 \log_{10}(W) =$  30.83dBc

Ch	Freq (MHz)	Measured Level (dBm)	Ant. Gain (dBd)	Substitute Level (dBm)	C.L	Pol	ERP (dBm)	dBc
23205 (779.5)	2,338.50	-57.28	10.77	-55.75	2.89	H	-47.87	65.70
	3,118.00	-53.13	11.54	-50.84	3.31	V	-42.61	60.44
	3,897.50	-58.21	12.66	-55.50	3.88	V	-46.72	64.55
23230 (782.0)	2,346.00	-58.13	10.78	-56.55	2.90	V	-48.67	66.50
	3,128.00	-52.07	11.57	-50.31	3.37	H	-42.11	59.94
	3,910.00	-56.65	12.67	-53.87	3.87	V	-45.07	62.90
23255 (784.5)	2,353.50	-58.35	10.78	-56.89	2.92	V	-49.03	66.86
	3,138.00	-54.09	11.59	-52.10	3.34	V	-43.85	61.68
	3,922.50	-57.12	12.67	-54.50	3.84	H	-45.67	63.50

- NOTES:**
1. Radiated Spurious Emission Measurements at 3 meters by Substitution Method according to ANSI/TIA/EIA-603-D-2010 June 24, 2010:
  2. We are performed all frequency to 10<sup>th</sup> harmonics from 30 MHz. Measurements above show only up to 3 maximum emissions noted, or would be lesser if no specific emissions from the EUT are recorded (ie: margin > 20 dB from the applicable limit) and considered that's already beyond the background noise floor.
  3. We have done x, y, z planes in EUT and horizontal and vertical polarization in detecting antenna.
  4. All of RB size has been tested for emissions and ERP, with the 1RB configuration observed as the worst case
  5. We are performed 16QAM and QPSK modulations. The worst case data are reported in the table above.

### 8.3.6 RADIATED SPURIOUS EMISSIONS (10 MHz Band 13 LTE)

- ▣ OPERATING FREQUENCY: 782.00 MHz
- ▣ MEASURED OUTPUT POWER: 16.09dBm = 0.041 W
- ▣ MODULATION SIGNAL: 10 MHz QPSK
- ▣ DISTANCE: 3 meters
- ▣ LIMIT:  $43 + 10 \log_{10}(W) =$  29.09dBc

Ch	Freq (MHz)	Measured Level (dBm)	Ant. Gain (dBd)	Substitute Level (dBm)	C.L	Pol	ERP (dBm)	dBc
23230 (782.00)	2,346.00	-58.62	10.78	-57.04	2.90	V	-49.16	65.25
	3,128.00	-57.10	11.57	-55.34	3.37	H	-47.14	63.23
	3,910.00	-57.26	12.67	-54.48	3.87	V	-45.68	61.77

- NOTES:**
1. Radiated Spurious Emission Measurements at 3 meters by Substitution Method according to ANSI/TIA/EIA-603-D-2010 June 24, 2010:
  2. We are performed all frequency to 10<sup>th</sup> harmonics from 30 MHz. Measurements above show only up to 3 maximum emissions noted, or would be lesser if no specific emissions from the EUT are recorded (ie: margin > 20 dB from the applicable limit) and considered that's already beyond the background noise floor.
  3. We have done x, y, z planes in EUT and horizontal and vertical polarization in detecting antenna.
  4. All of RB size has been tested for emissions and ERP, with the 1RB configuration observed as the worst case
  5. We are performed 16QAM and QPSK modulations. The worst case data are reported in the table above.

**8.3.6.1 RADIATED SPURIOUS EMISSIONS (1559 ~ 1610 MHz Band)**

- ▣ OPERATING FREQUENCY: 779.5 MHz, 782.0 MHz, 784.5 MHz
- ▣ MODULATION SIGNAL: 5 MHz QPSK
- ▣ DISTANCE: 3 meters
- ▣ WIDEBAND EMISSION LIMIT: -70dBW/MHz (= -40 dBm/MHz)

Operating Frequency (MHz)	Measured Frequency (MHz)	EMISSION TYPE	Measured Level (dBm)	Ant. Gain (dBd)	Substitute Level (dBm)	C.L	Pol	ERP (dBm)
779.5	1565.2	WIDEBAND	-58.93	8.84	-60.44	2.33	H	-53.93
782.0	1559.6		-56.21	8.82	-57.88	2.33	H	-51.39
784.5	1564.6		-55.66	9.21	-57.81	2.41	H	-51.01

**8.3.6.2 RADIATED SPURIOUS EMISSIONS (1559 ~ 1610 MHz Band)**

- ▣ OPERATING FREQUENCY: 782.00 MHz
- ▣ MODULATION SIGNAL: 10 MHz QPSK
- ▣ DISTANCE: 3 meters
- ▣ WIDEBAND EMISSION LIMIT: -70dBW/MHz (= -40 dBm/MHz)

Operating Frequency (MHz)	Measured Frequency (MHz)	EMISSION TYPE	Measured Level (dBm)	Ant. Gain (dBd)	Substitute Level (dBm)	C.L	Pol	ERP (dBm)
782.0	1599.7	WIDEBAND	-58.61	8.98	-60.46	2.36	H	-53.84

**8.4PEAK-TO-AVERAGE RATIO**

Band	Band Width	Frequency (MHz)	Modulation	Resource Block Size	Resource Block Offset	Data (dB )
4	5 MHz	1732.5	QPSK	25	0	5.39
			16-QAM	25		6.11
	10 MHz		QPSK	50		5.44
			16-QAM	50		6.06
	15 MHz		QPSK	75		5.27
			16-QAM	75		5.94
	20 MHz		QPSK	100		5.34
			16-QAM	100		6.00

- Plots of the EUT's Peak- to- Average Ratio are shown Page48~ 51.

### 8.5 OCCUPIED BANDWIDTH

Band	Band Width (MHz)	Frequency (MHz)	Modulation	Resource Block Size	Resource Block Offset	Data ( MHz )
4	5	1732.5	QPSK	25	0	4.5658
			16-QAM	25		4.5493
	10		QPSK	50		9.0350
			16-QAM	50		9.1022
	15		QPSK	75		13.573
			16-QAM	75		13.586
	20		QPSK	100		18.063
			16-QAM	100		18.061

Band	Band Width (MHz)	Frequency (MHz)	Modulation	Resource Block Size	Resource Block Offset	Data ( MHz )
13	5	782.0	QPSK	25	0	4.5483
			16-QAM	25		4.5656
	10		QPSK	50		9.0468
			16-QAM	50		9.0982

- Plots of the EUT's Occupied Bandwidth are shown Page 42 ~ 47.



### 8.6 CONDUCTED SPURIOUS EMISSIONS

■ FACTORS FOR FREQUENCY

Frequency Range (GHz)	Factor [dB]
0.03 – 1	27.145
1 – 5	26.960
5 – 10	27.542
10 – 15	28.439
15 – 20	29.144
Above 20	30.148

**NOTES:**

Factor(dB) = Cable Loss + Attenuator + Power Splitter

Band	Band Width (MHz)	Frequency (MHz)	Frequency of Maximum Harmonic (GHz)	Factor (dB)	Measurement Maximum Data (dBm)	Result (dBm)	Limit (dBm)
4	5	1712.5	2.4153	27.542	-55.810	-28.268	-13.00
		1732.5	2.4123	27.542	-56.240	-28.698	
		1752.5	2.4153	27.542	-55.760	-28.218	
	10	1715.0	2.4153	27.542	-56.780	-29.238	
		1732.5	2.4153	27.542	-56.460	-28.918	
		1750.0	2.4143	27.542	-56.336	-28.794	
	15	1717.5	2.4143	27.542	-54.823	-27.281	
		1732.5	2.4118	27.542	-56.489	-28.947	
		1747.5	2.4108	27.542	-55.692	-28.150	
	20	1720.0	2.4148	27.542	-56.610	-29.068	
		1732.5	2.4148	27.542	-56.009	-28.467	
		1745.0	2.4148	27.542	-54.625	-27.083	

Band	Band Width (MHz)	Frequency (MHz)	Frequency of Maximum Harmonic (GHz)	Factor (dB)	Measurement Maximum Data (dBm)	Result (dBm)	Limit (dBm)
13	5	779.5	2.4113	26.960	-57.795	-30.835	-13.00
		782.0	2.4143	26.960	-58.879	-31.919	
		784.5	2.4113	26.960	-57.205	-30.245	
	10	782	5.8465	27.542	-58.543	-31.001	

**NOTES:**

1. Conducted Spurious Emissions was Tested QPSK Modulation, Resource Block Size 1 and Resource Block Offset 0
2. Result (dBm) = Measurement Maximum Data (dBm) + Factor (dB)

- Plots of the EUT's Conducted Spurious Emissions are shown Page 70 ~ 83.

**8.6.1 BAND EDGE**

- Plots of the EUT's Band Edge are shown Page 52 ~ 69.

**8.7 FREQUENCY STABILITY / VARIATION OF AMBIENT TEMPERATURE**

**8.7.1 FREQUENCY STABILITY (5 MHz Band 4 LTE)**

- ▣ OPERATING FREQUENCY: 1732,500,000 Hz
- ▣ CHANNEL: 20175 (5 MHz)
- ▣ REFERENCE VOLTAGE: 3.8 VDC
- ▣ DEVIATION LIMIT: Emission must remain in band

Voltage (%)	Power (VDC)	Temp. (°C)	Frequency (Hz)	Frequency Error (Hz)	Deviation (%)	ppm
100%	3.8	+20(Ref)	1732 500 010	0.0	0.000 000	0.000
100%		-30	1732 500 016	5.7	0.000 000	0.003
100%		-20	1732 500 014	4.0	0.000 000	0.002
100%		-10	1732 500 016	6.3	0.000 000	0.004
100%		0	1732 500 005	-4.8	0.000 000	-0.003
100%		+10	1732 500 021	11.1	0.000 001	0.006
100%		+30	1732 500 015	5.2	0.000 000	0.003
100%		+40	1732 500 019	8.5	0.000 000	0.005
100%		+50	1732 500 018	8.1	0.000 000	0.005
Batt. Endpoint		3.5	+20	1732 500 019	8.7	0.000 001

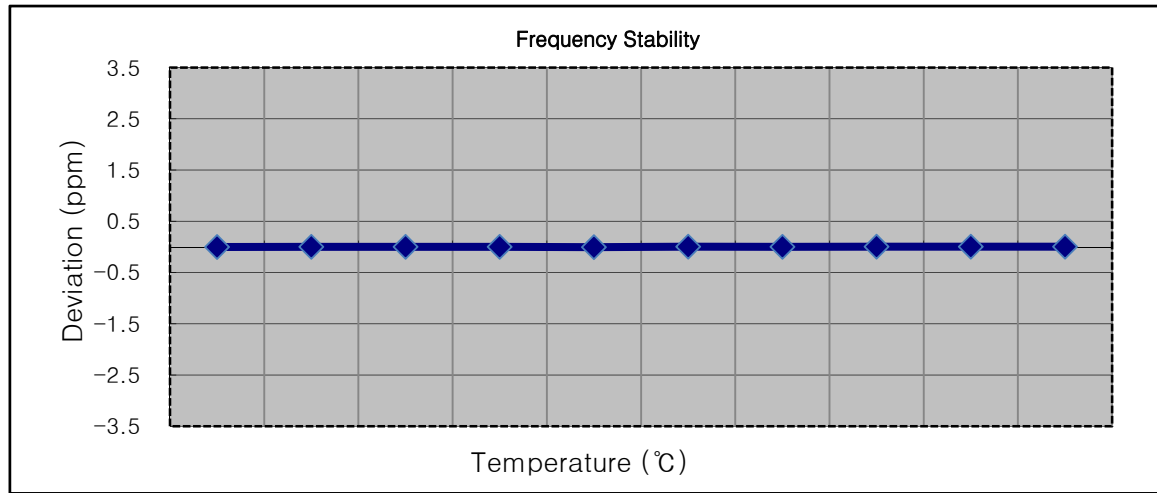

**8.7.2 FREQUENCY STABILITY (10 MHz Band 4 LTE)**

- ▣ OPERATING FREQUENCY: 1732,500,000 Hz
- ▣ CHANNEL: 20175 (10 MHz)
- ▣ REFERENCE VOLTAGE: 3.8 VDC
- ▣ DEVIATION LIMIT: Emission must remain in band

Voltage (%)	Power (VDC)	Temp. (°C)	Frequency (Hz)	Frequency Error (Hz)	Deviation (%)	ppm
100%	3.8	+20(Ref)	1732 500 005	0.0	0.000 000	0.000
100%		-30	1732 500 011	6.3	0.000 000	0.004
100%		-20	1732 499 999	-5.8	0.000 000	-0.003
100%		-10	1732 500 011	6.2	0.000 000	0.004
100%		0	1732 500 014	9.0	0.000 001	0.005
100%		+10	1732 499 998	-6.8	0.000 000	-0.004
100%		+30	1732 500 012	7.9	0.000 000	0.005
100%		+40	1732 500 000	-4.3	0.000 000	-0.002
100%		+50	1732 499 999	-5.2	0.000 000	-0.003
Batt. Endpoint	3.5	+20	1732 500 000	-4.9	0.000 000	-0.003

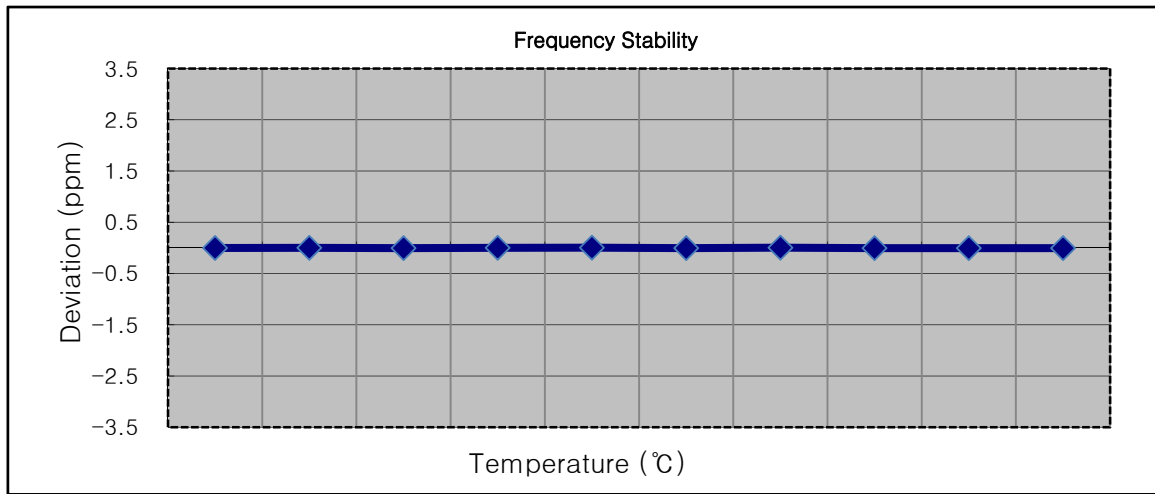

**8.7.3 FREQUENCY STABILITY (15 MHz Band 4 LTE)**

- ▣ OPERATING FREQUENCY: 1732,500,000 Hz
- ▣ CHANNEL: 20175 (15 MHz)
- ▣ REFERENCE VOLTAGE: 3.8 VDC
- ▣ DEVIATION LIMIT: Emission must remain in band

Voltage (%)	Power (VDC)	Temp. (°C)	Frequency (Hz)	Frequency Error (Hz)	Deviation (%)	ppm
100%	3.8	+20(Ref)	1732 499 993	0.0	0.000 000	0.000
100%		-30	1732 499 997	4.2	0.000 000	0.002
100%		-20	1732 499 998	5.7	0.000 000	0.003
100%		-10	1732 499 987	-5.3	0.000 000	-0.003
100%		0	1732 499 999	5.9	0.000 000	0.003
100%		+10	1732 499 998	4.9	0.000 000	0.003
100%		+30	1732 499 998	5.2	0.000 000	0.003
100%		+40	1732 499 997	4.6	0.000 000	0.003
100%		+50	1732 499 998	5.7	0.000 000	0.003
Batt. Endpoint	3.5	+20	1732 499 999	6.2	0.000 000	0.004

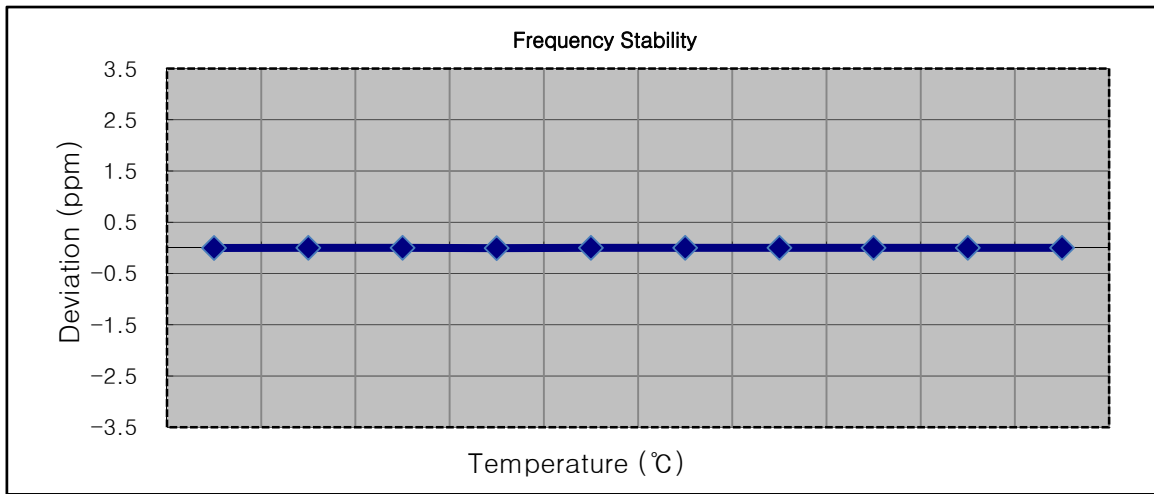

**8.7.4 FREQUENCY STABILITY (20 MHz Band 4 LTE)**

- ▣ OPERATING FREQUENCY: 1732,500,000 Hz
- ▣ CHANNEL: 20175 (20 MHz)
- ▣ REFERENCE VOLTAGE: 3.8 VDC
- ▣ DEVIATION LIMIT: Emission must remain in band

Voltage (%)	Power (VDC)	Temp. (°C)	Frequency (Hz)	Frequency Error (Hz)	Deviation (%)	ppm
100%	3.8	+20(Ref)	1732 499 992	0.0	0.000 000	0.000
100%		-30	1732 499 988	-4.7	0.000 000	-0.003
100%		-20	1732 499 997	4.3	0.000 000	0.002
100%		-10	1732 499 987	-5.2	0.000 000	-0.003
100%		0	1732 499 997	4.1	0.000 000	0.002
100%		+10	1732 499 988	-4.4	0.000 000	-0.003
100%		+30	1732 499 997	4.8	0.000 000	0.003
100%		+40	1732 499 988	-4.7	0.000 000	-0.003
100%		+50	1732 499 989	-3.6	0.000 000	-0.002
Batt. Endpoint	3.5	+20	1732 499 998	5.7	0.000 000	0.003

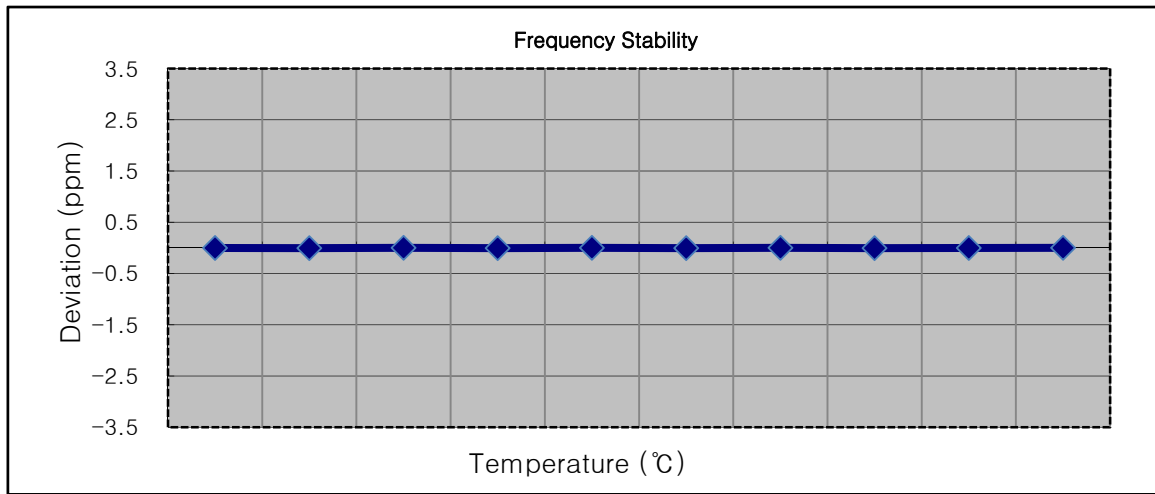

**8.7.5 FREQUENCY STABILITY (5 MHz Band 13LTE)**

- ▣ OPERATING FREQUENCY: 782,000,000 Hz
- ▣ CHANNEL: 23230 (5 MHz)
- ▣ REFERENCE VOLTAGE: 3.8 VDC
- ▣ DEVIATION LIMIT: Emission must remain in band

Voltage (%)	Power (VDC)	Temp. (°C)	Frequency (Hz)	Frequency Error (Hz)	Deviation (%)	ppm
100%	3.8	+20(Ref)	781 999 968	0.0	0.000 000	0.0000
100%		-30	781 999 944	-24.2	-0.000 003	-0.0309
100%		-20	781 999 935	-33.6	-0.000 004	-0.0430
100%		-10	781 999 940	-28.6	-0.000 004	-0.0366
100%		0	781 999 931	-37.4	-0.000 005	-0.0478
100%		+10	781 999 934	-34.3	-0.000 004	-0.0439
100%		+30	781 999 936	-32.1	-0.000 004	-0.0410
100%		+40	781 999 942	-26.8	-0.000 003	-0.0343
100%		+50	781 999 943	-25.6	-0.000 003	-0.0327
Batt. Endpoint	3.5	+20	781 999 934	-34.2	-0.000 004	-0.0437

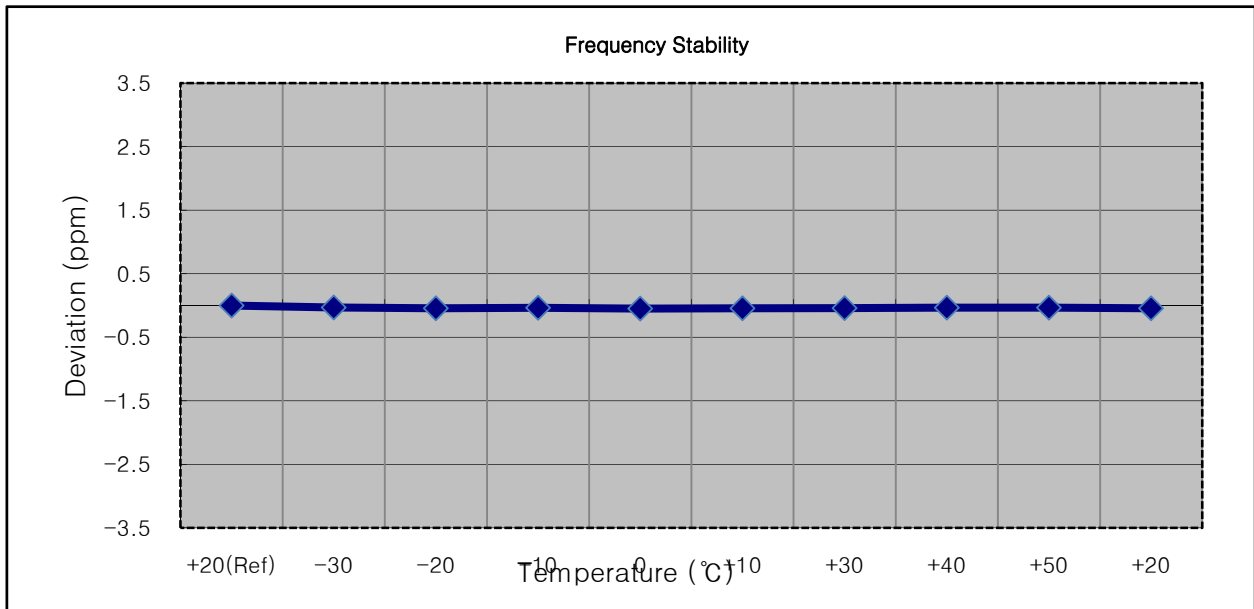

**8.7.6 FREQUENCY STABILITY (10 MHz Band 13 LTE)**

- ▣ OPERATING FREQUENCY: 782,000,000 Hz
- ▣ CHANNEL: 23230 (10 MHz)
- ▣ REFERENCE VOLTAGE: 3.8 VDC
- ▣ DEVIATION LIMIT: Emission must remain in band

Voltage (%)	Power (VDC)	Temp. (°C)	Frequency (Hz)	Frequency Error (Hz)	Deviation (%)	ppm
100%	3.8	+20(Ref)	781 999 961	0.0	0.000 000	0.0000
100%		-30	781 999 928	-32.8	-0.000 004	-0.0419
100%		-20	781 999 928	-33.6	-0.000 004	-0.0430
100%		-10	781 999 925	-36.2	-0.000 005	-0.0463
100%		0	781 999 928	-32.9	-0.000 004	-0.0421
100%		+10	781 999 929	-32.2	-0.000 004	-0.0412
100%		+30	781 999 919	-42.1	-0.000 005	-0.0538
100%		+40	781 999 921	-40.5	-0.000 005	-0.0518
100%		+50	781 999 923	-38.6	-0.000 005	-0.0494
Batt. Endpoint	3.5	+20	781 999 922	-38.8	-0.000 005	-0.0496

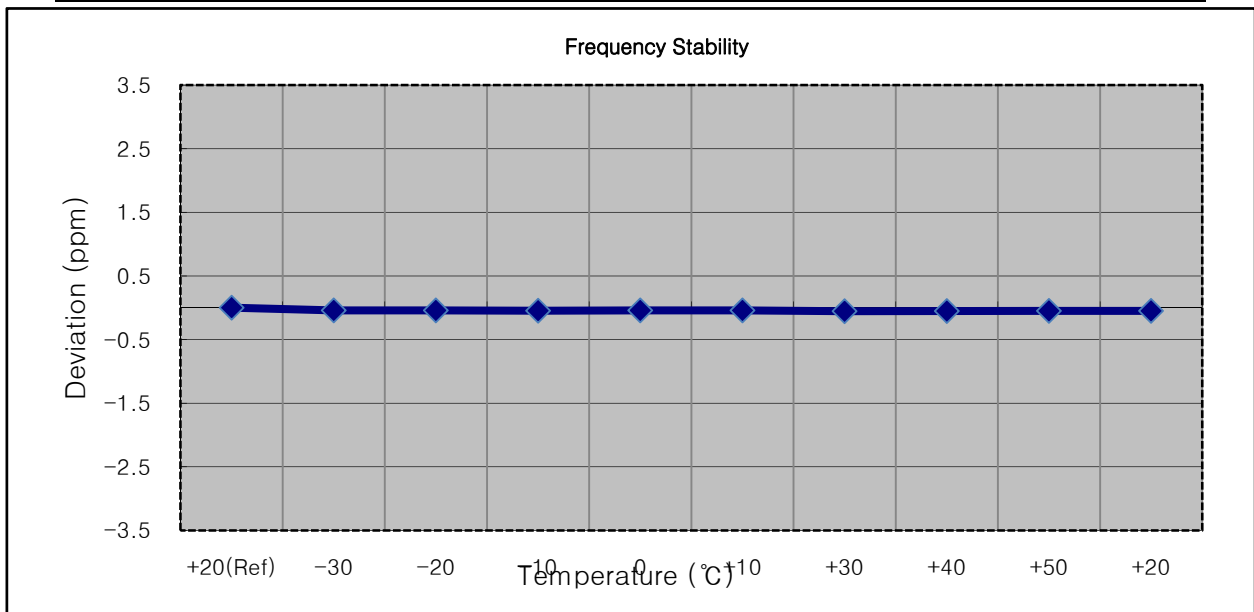



## 9. TEST PLOTS

BAND 4. Occupied Bandwidth Plot (5M BW Ch.20175 QPSK RB 25)

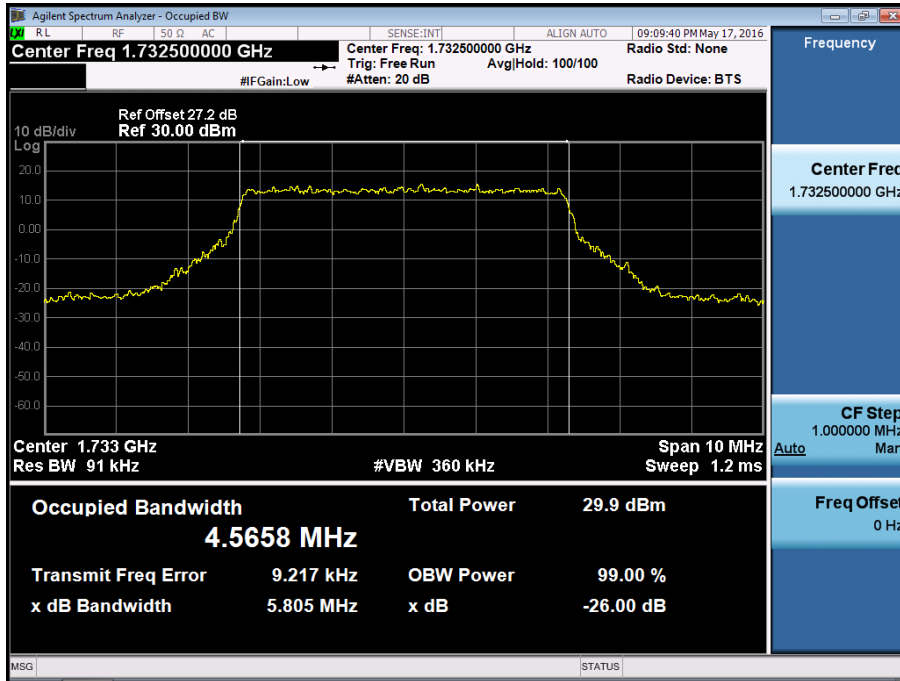

BAND 4. Occupied Bandwidth Plot (5M BW Ch.20175 16QAM RB 25)

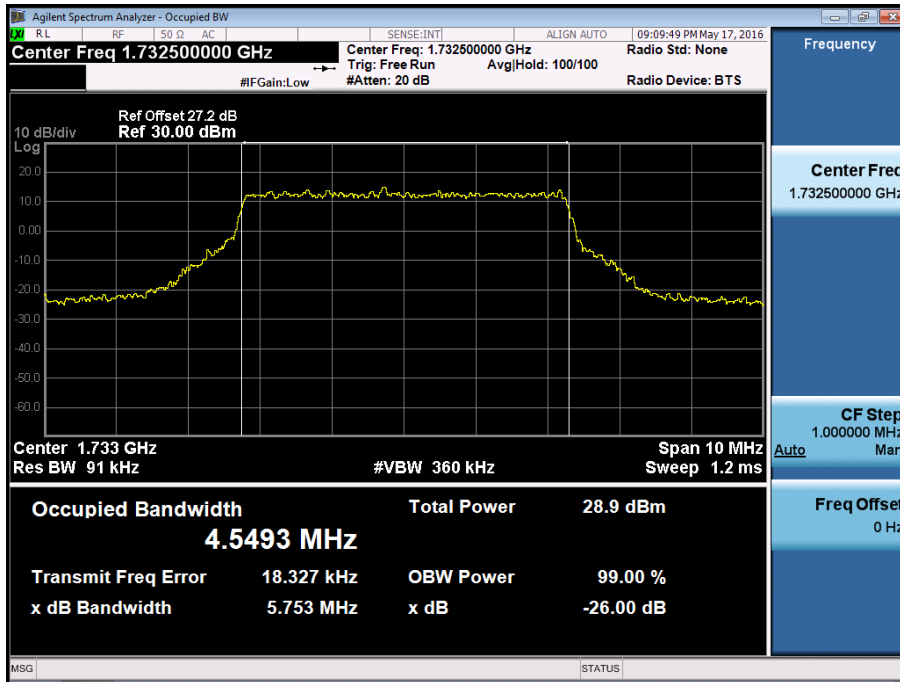

BAND 4. Occupied Bandwidth Plot (10M BW Ch.20175 QPSK RB 50)

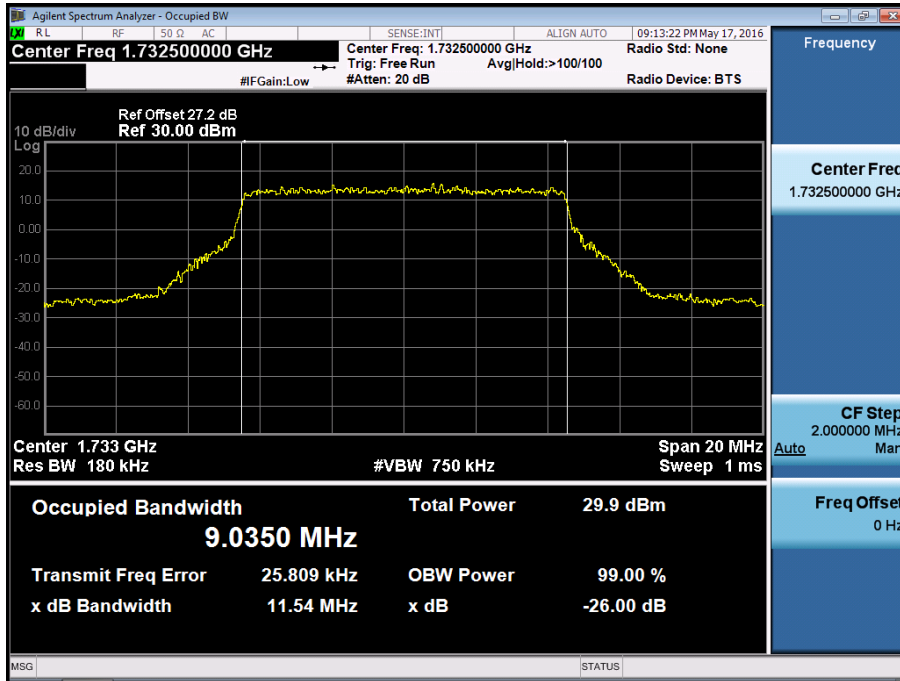

BAND 4. Occupied Bandwidth Plot (10M BW Ch.20175 16QAM RB 50)

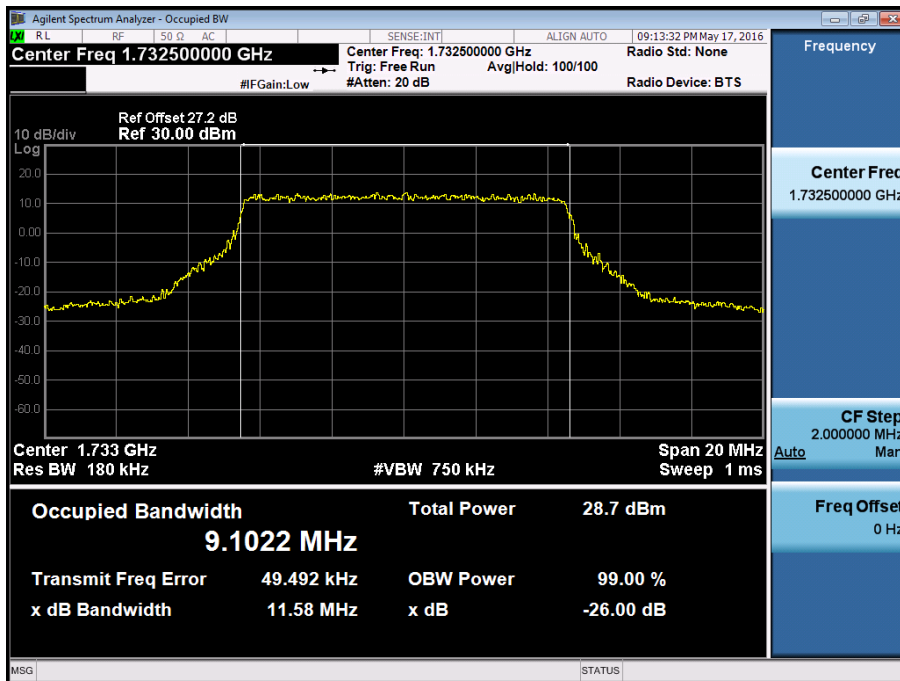

BAND 4. Occupied Bandwidth Plot (15M BW Ch.20175 QPSK RB 75)

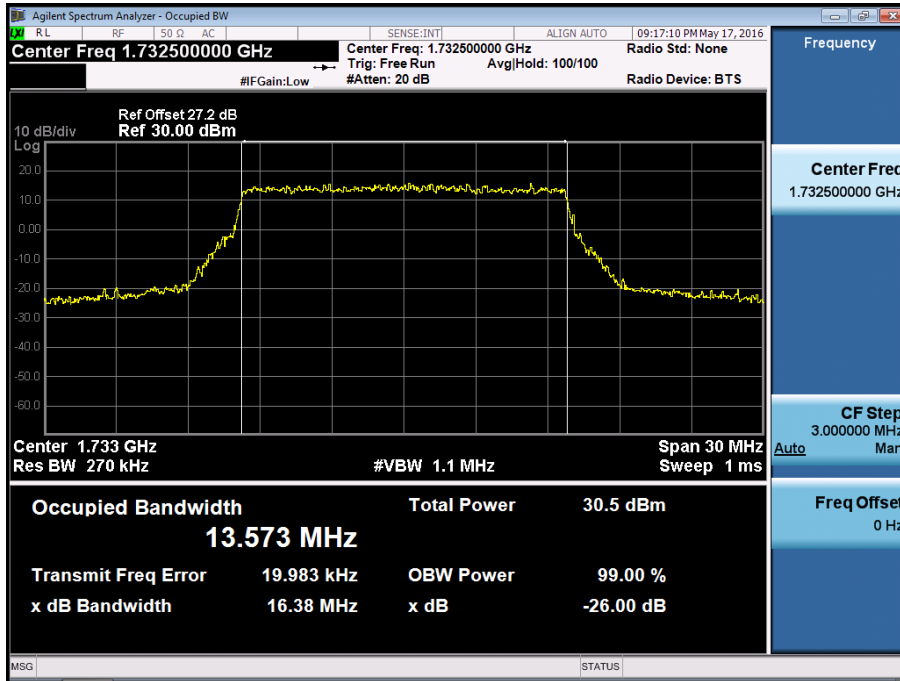

BAND 4. Occupied Bandwidth Plot (15M BW Ch.20175 16QAM RB 75)

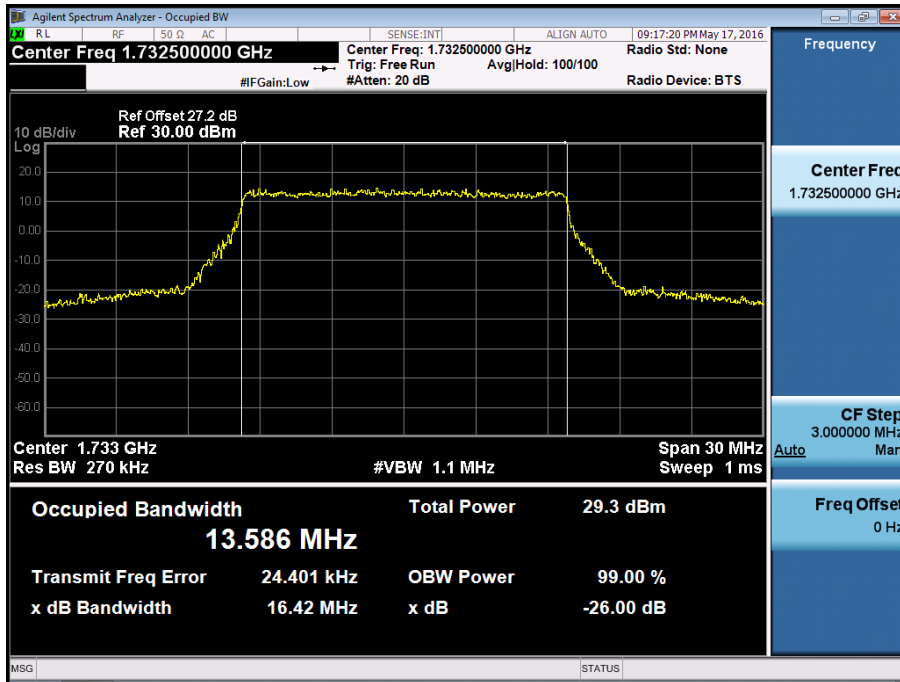

BAND 4. Occupied Bandwidth Plot (20M BW Ch.20175 QPSK RB 100)

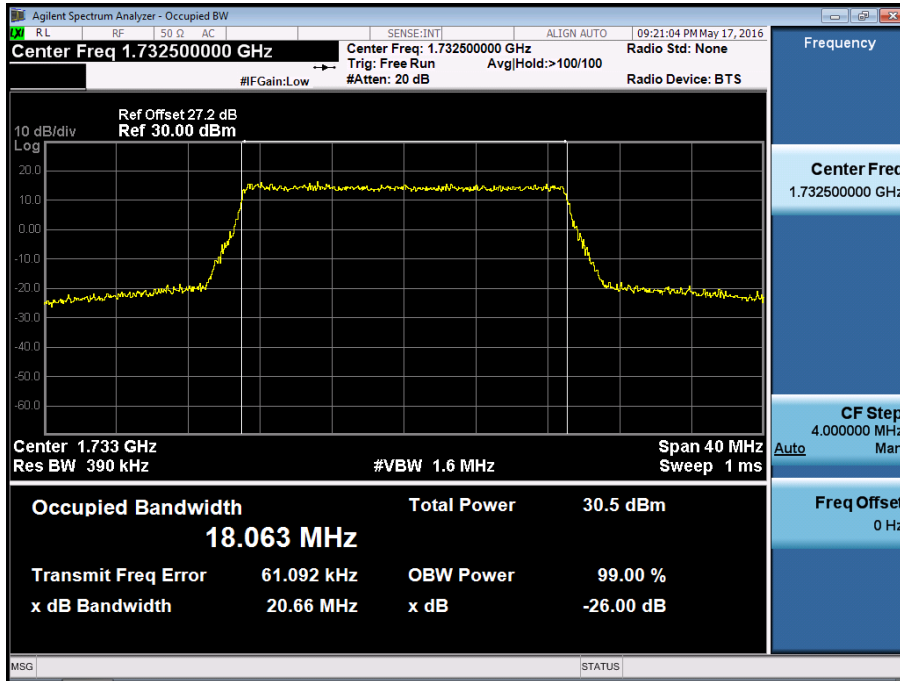

BAND 4. Occupied Bandwidth Plot (20M BW Ch.20175 16QAM RB 100)

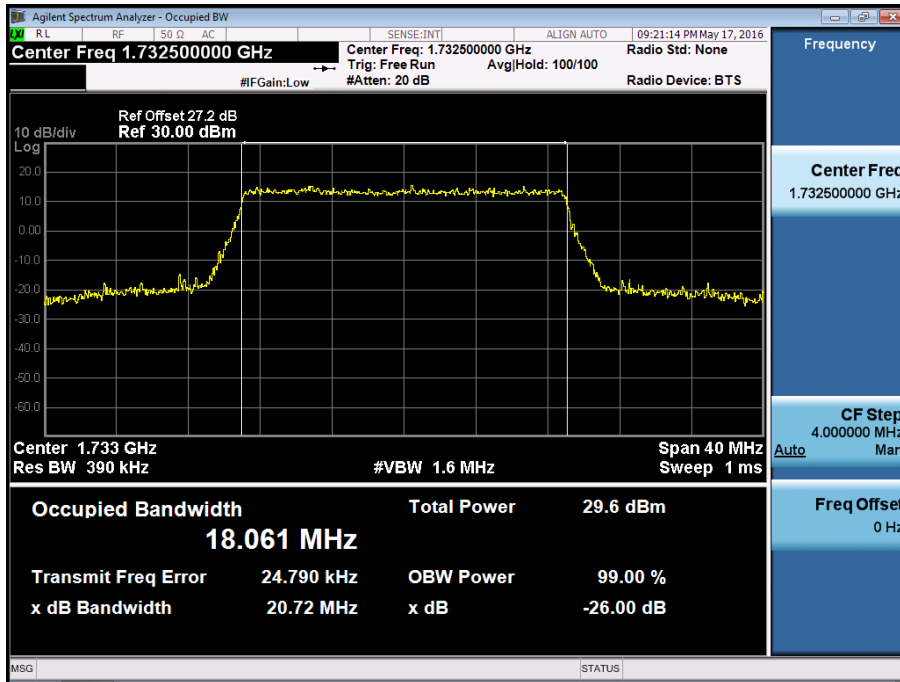

BAND 13. Occupied Bandwidth Plot (Ch.23230 QPSK RB 25) 5 MHz

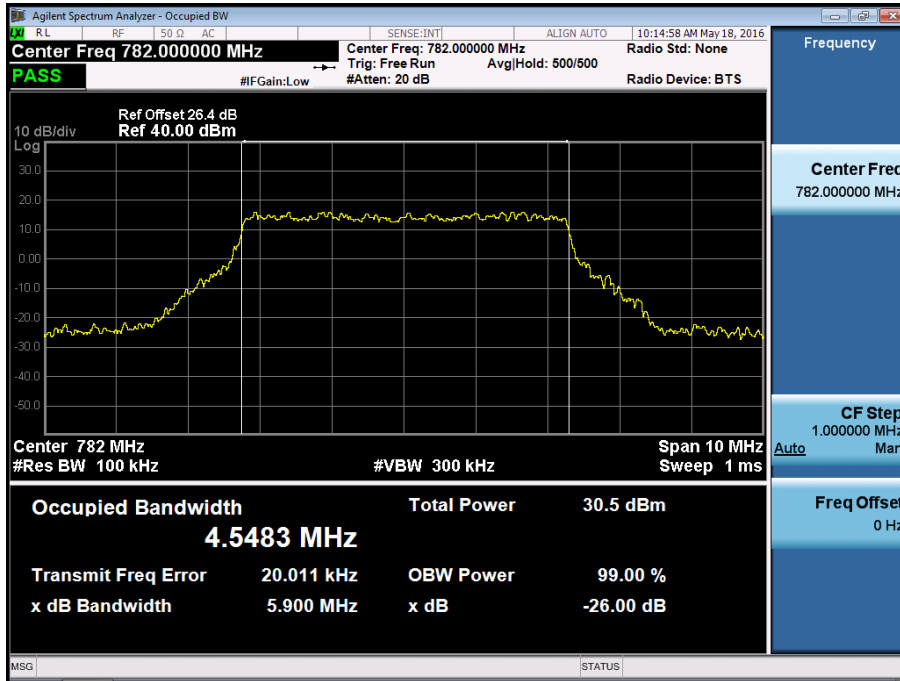

BAND 13. Occupied Bandwidth Plot (Ch.23230 16-QAM RB 25) 5 MHz

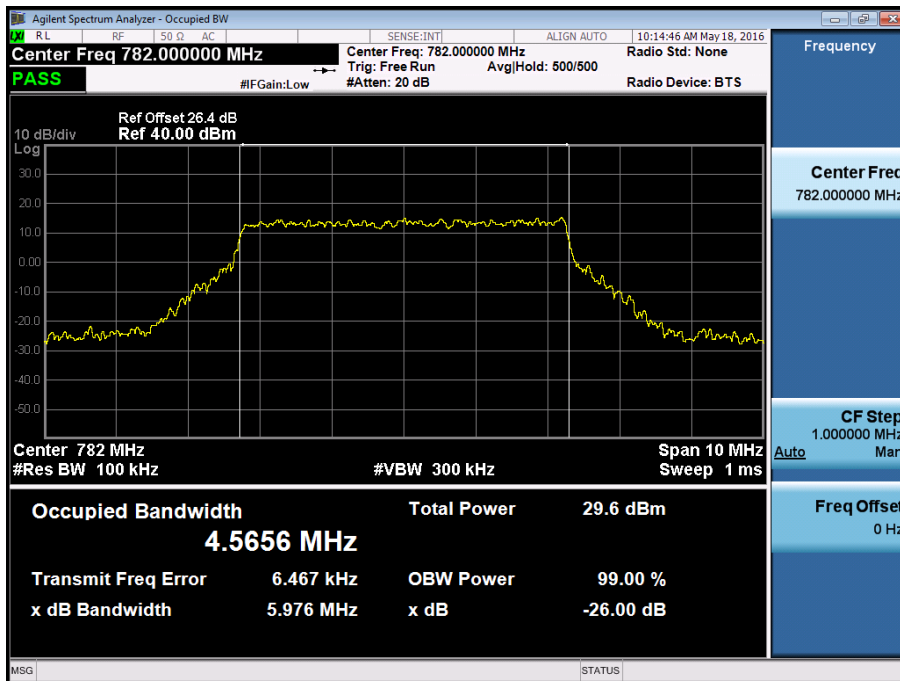

BAND 13. Occupied Bandwidth Plot (Ch.23230 QPSK RB 50) 10 MHz

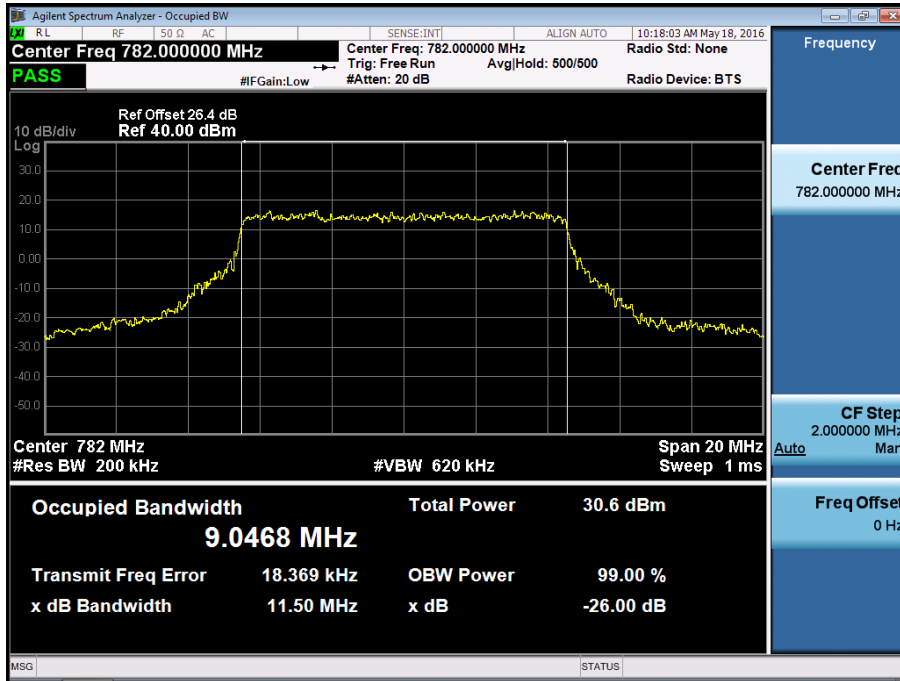

BAND 13. Occupied Bandwidth Plot (Ch.23230 16-QAM RB 50) 10 MHz

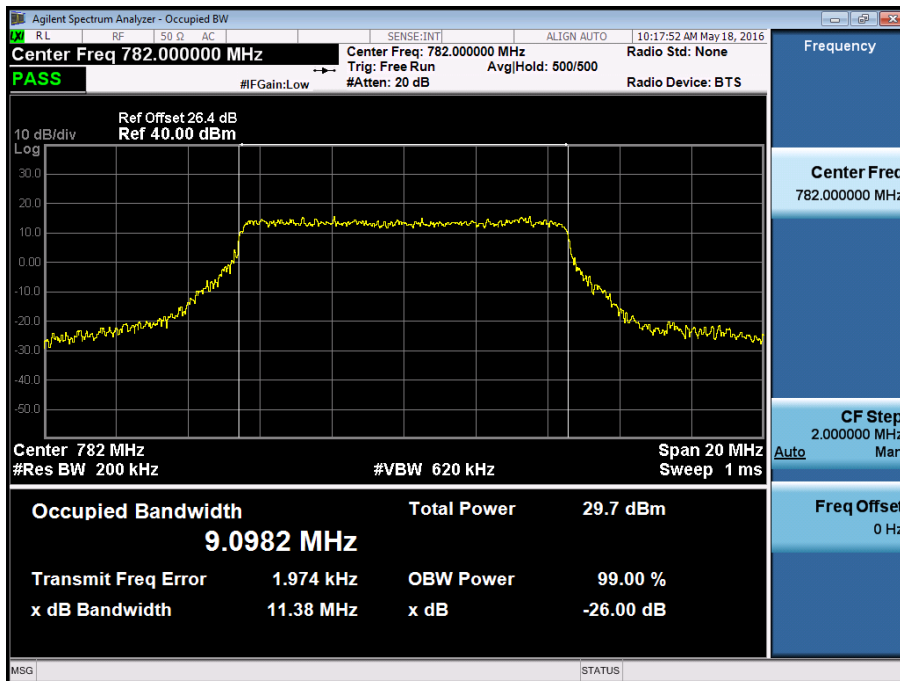

BAND 4. PAR Plot (5M BW\_Ch.20175\_QPSK\_RB25\_0)

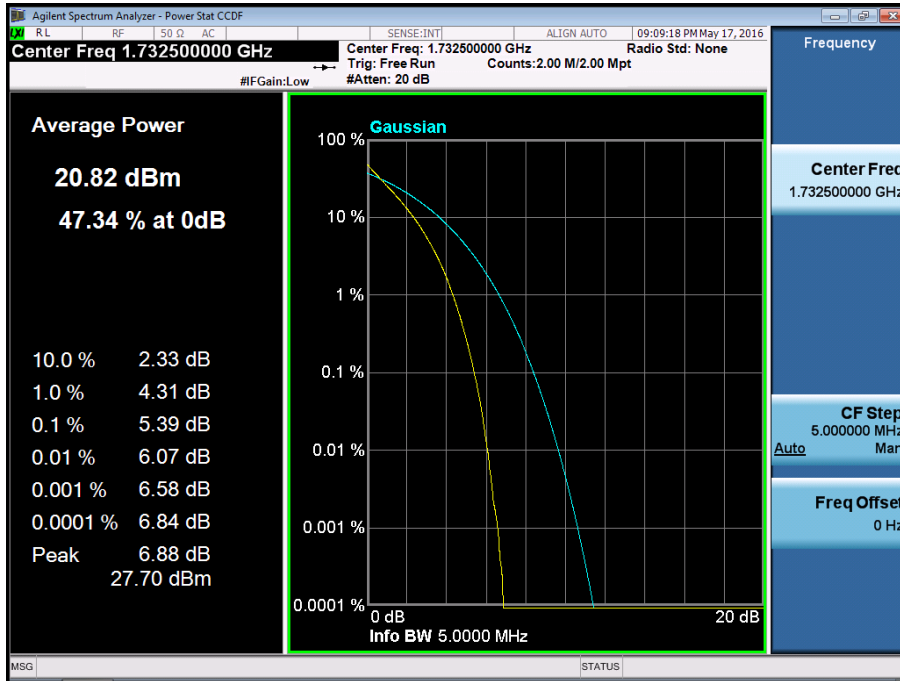

BAND 4. PAR Plot (5M BW\_Ch.20175\_16QAM\_RB25\_0)

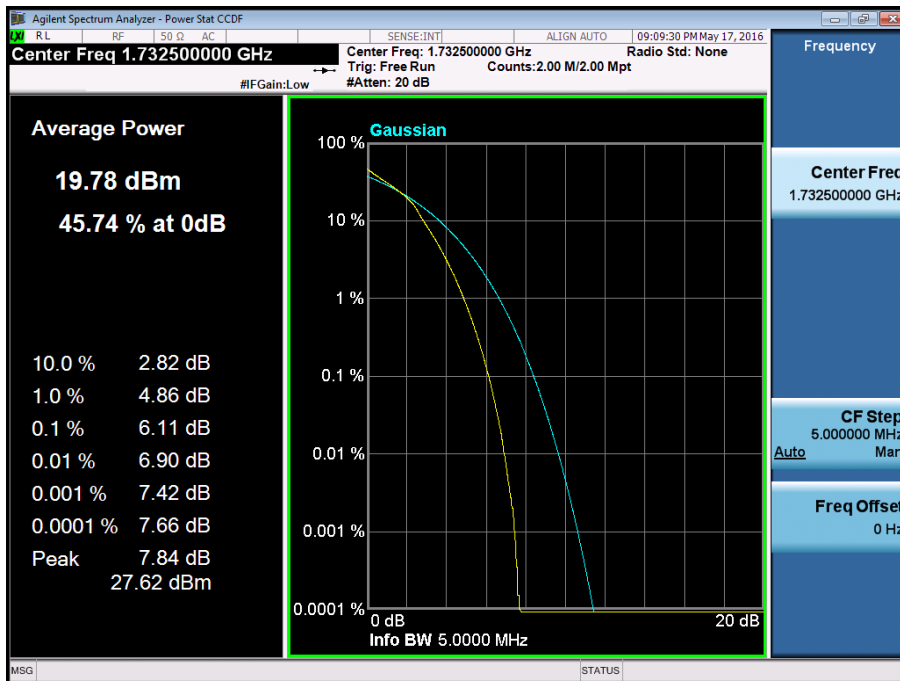



BAND 4. PAR Plot (10M BW\_Ch.20175\_QPSK\_RB50\_0)

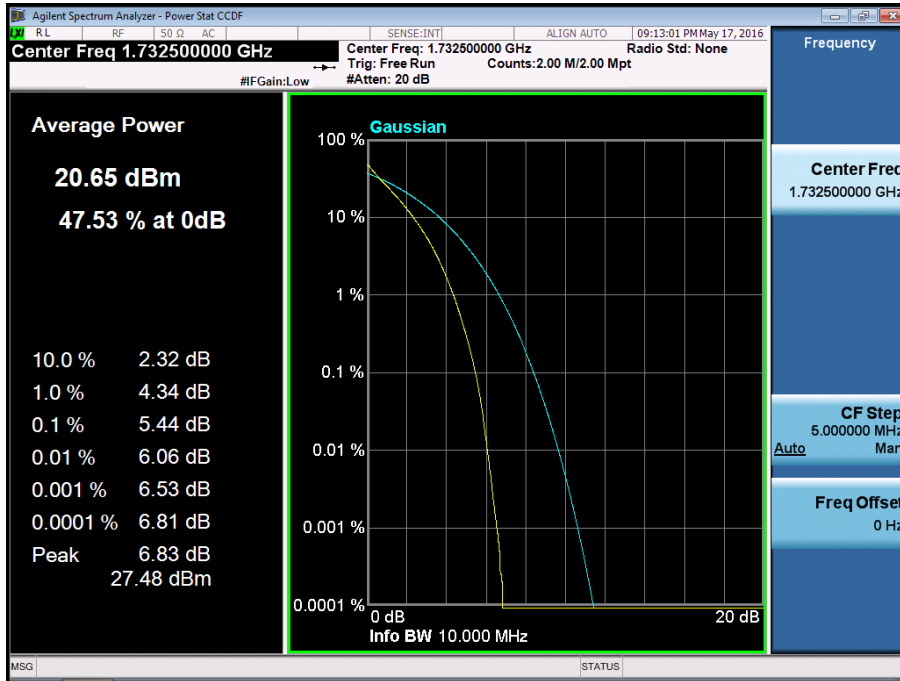

BAND 4. PAR Plot (10M BW\_Ch.20175\_16QAM\_RB50\_0)

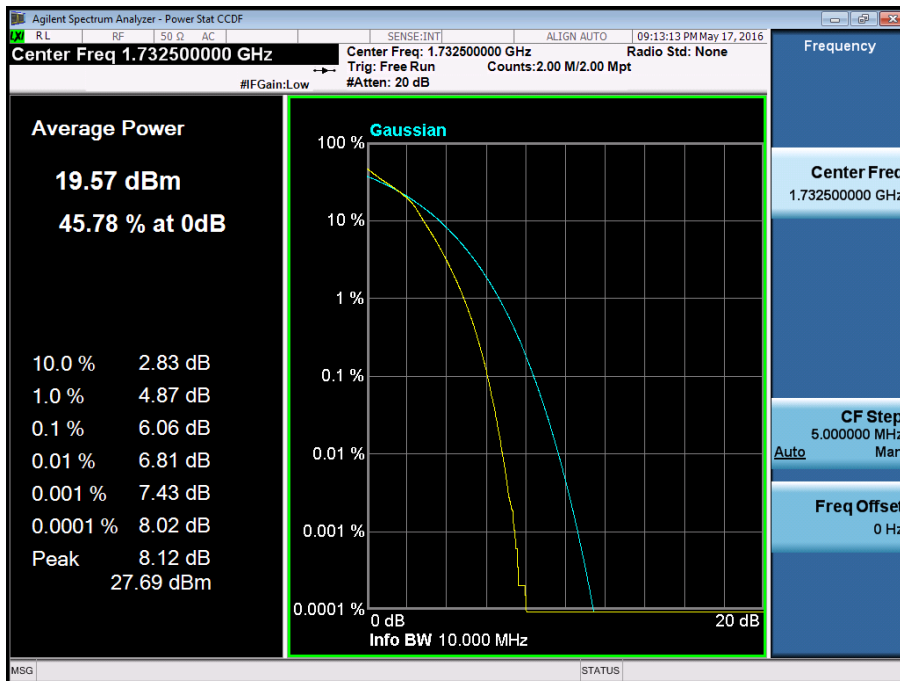

BAND 4. PAR Plot (15M BW\_Ch.20175\_QPSK\_RB75\_0)

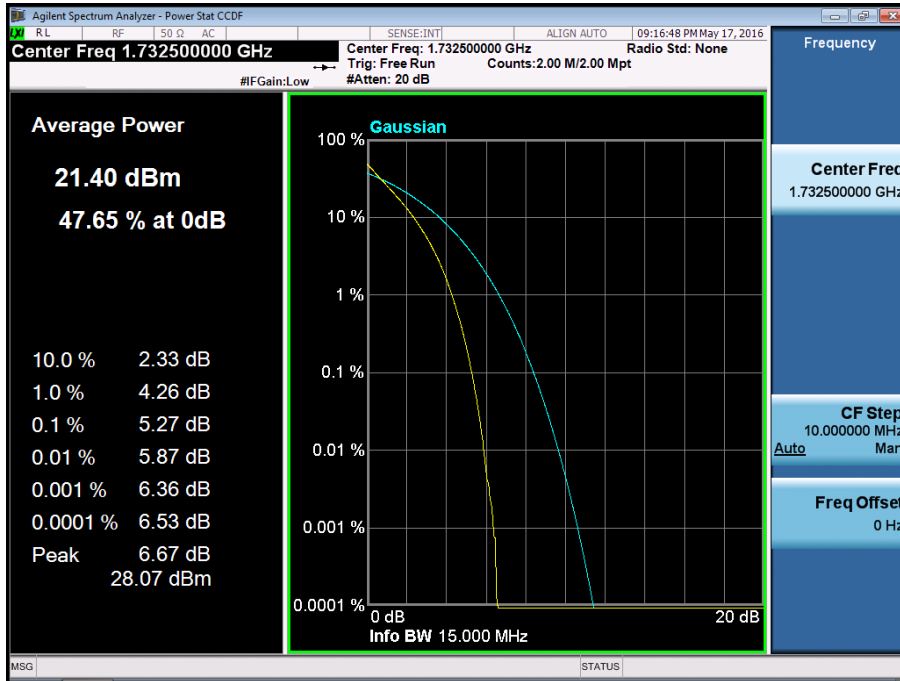

BAND 4. PAR Plot (15M BW\_Ch.20175\_16QAM\_RB75\_0)

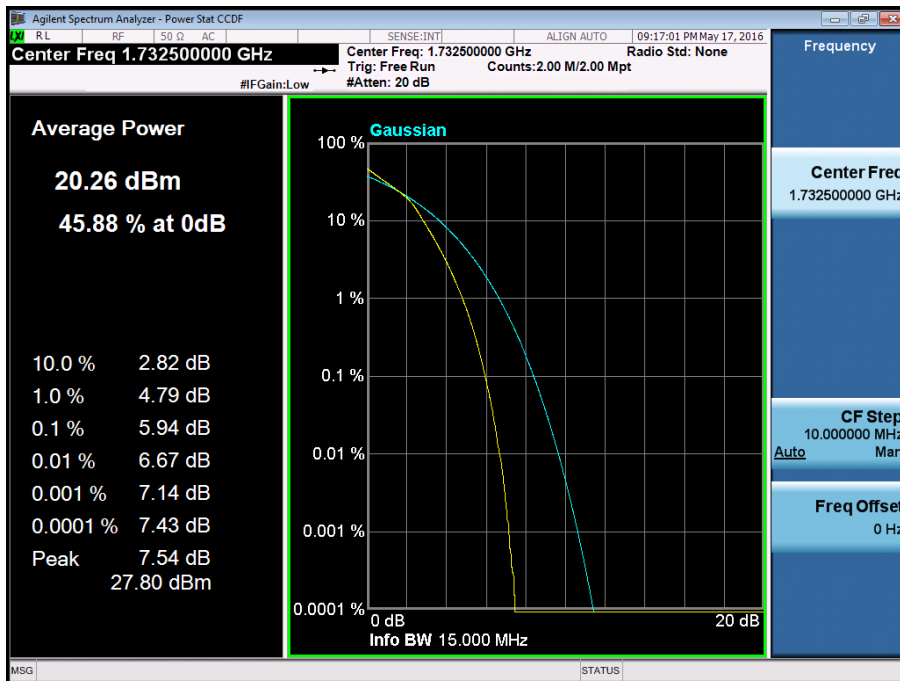

BAND 4. PAR Plot (20M BW\_Ch.20175\_QPSK\_RB100\_0)

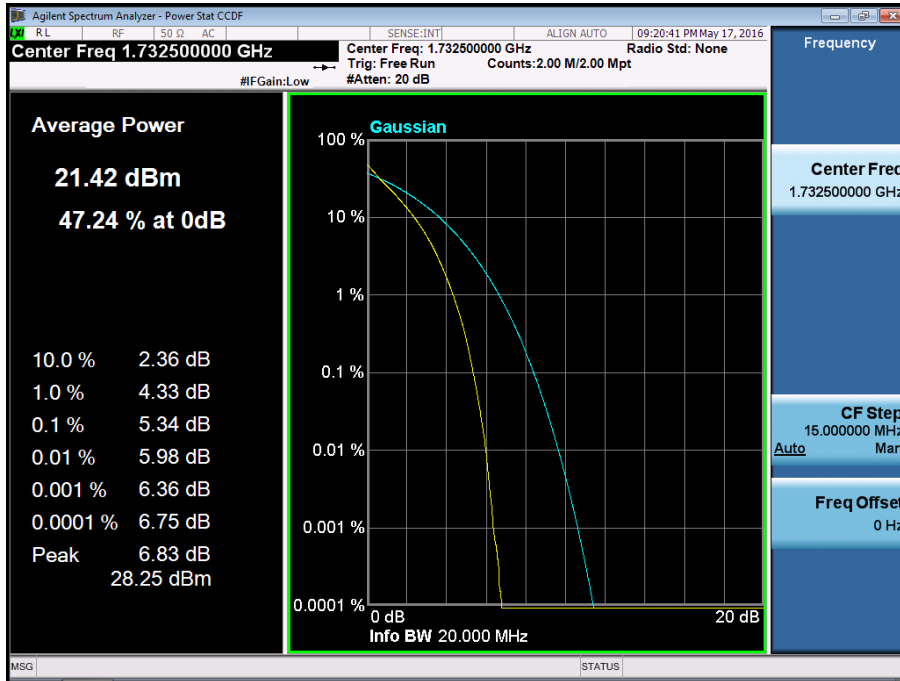

BAND 4. PAR Plot (20M BW\_Ch.20175\_16QAM\_RB100\_0)

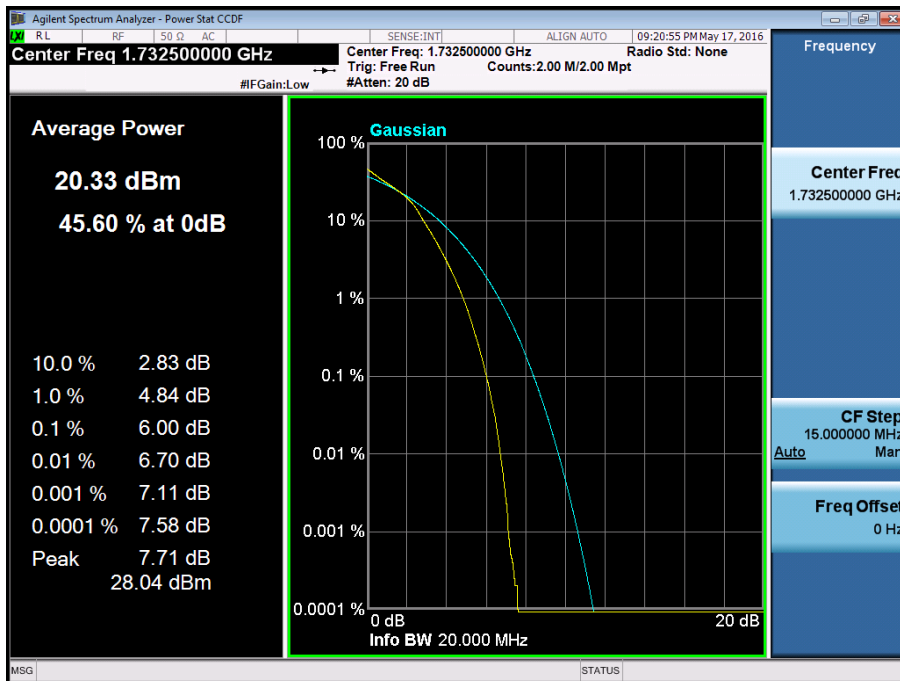

BAND 4.Lower Band Edge Plot (5M BW Ch.19975 QPSK RB 1, Offset 0) -1



BAND 4. Lower Band Edge Plot (5M BW Ch.19975 QPSK RB 25) -2

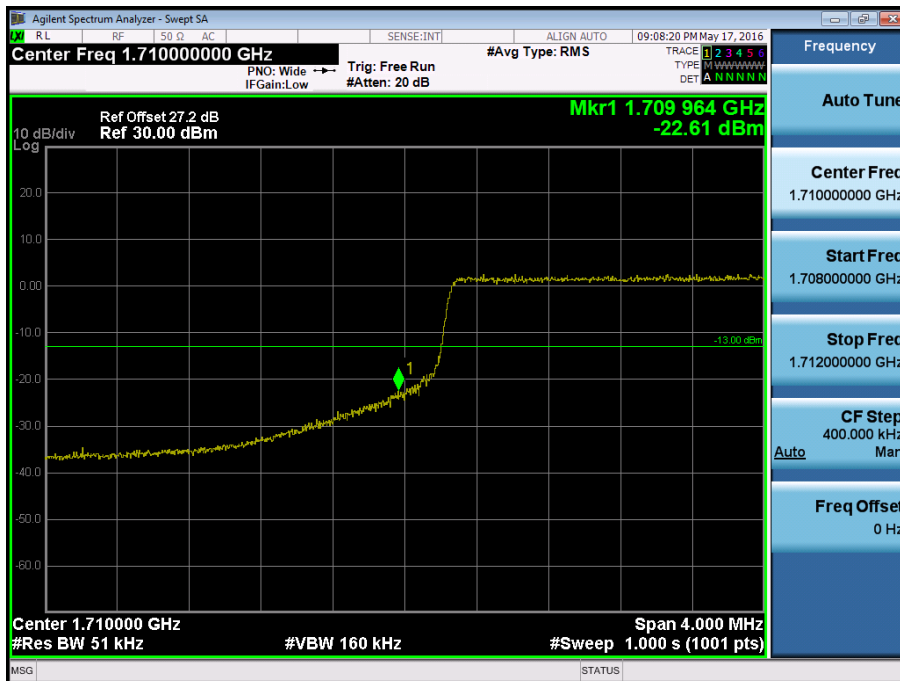

BAND 4. Lower Extended Band Edge Plot (5M BW Ch.19975 QPSK\_RB25\_0) -3

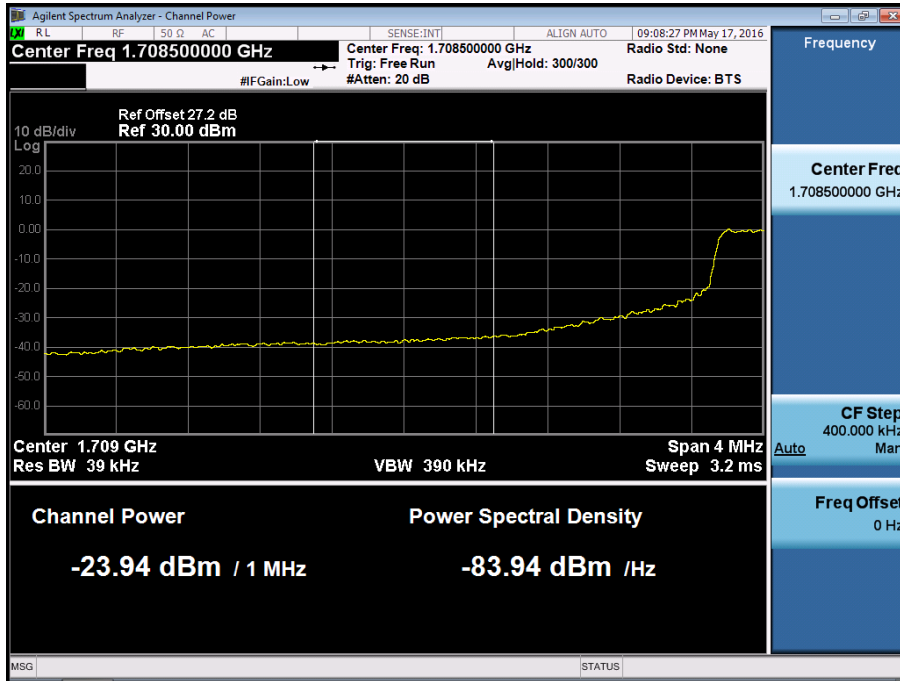

BAND 4. Lower Band Edge Plot (10M BW Ch.20000 QPSK RB 1, Offset 0) -1

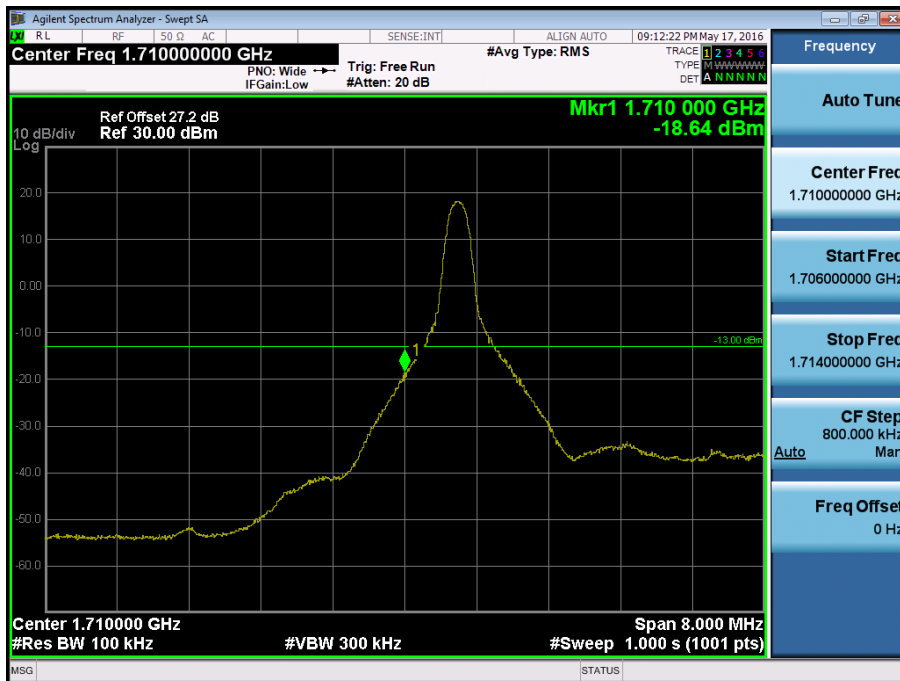

BAND 4. Lower Band Edge Plot (10M BW Ch.20000 QPSK RB 50) -2

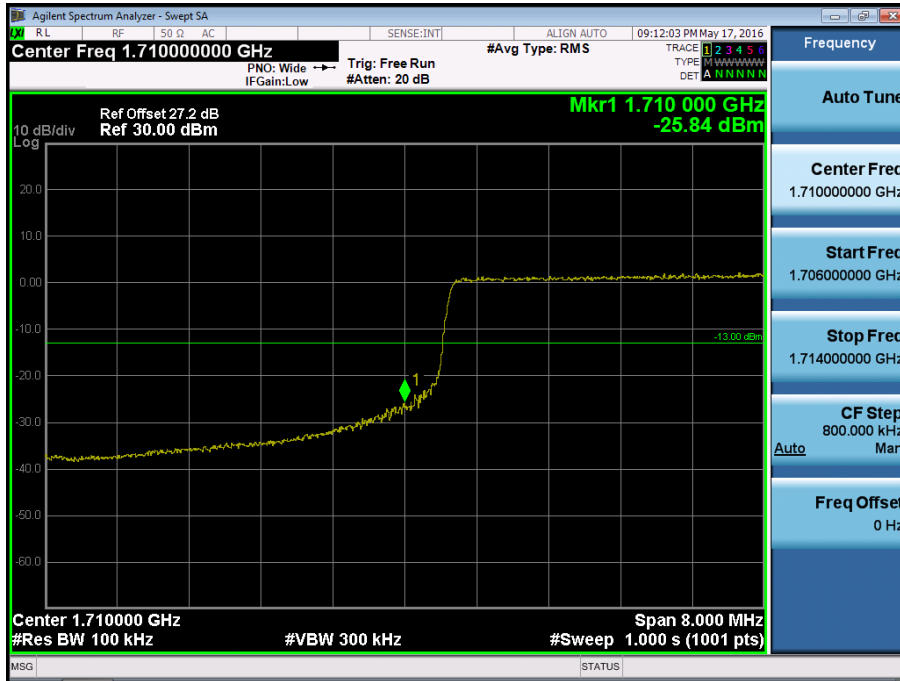

BAND 4.Lower Extended Band Edge Plot (10M BW Ch.20000 QPSK\_RB50\_0) -3

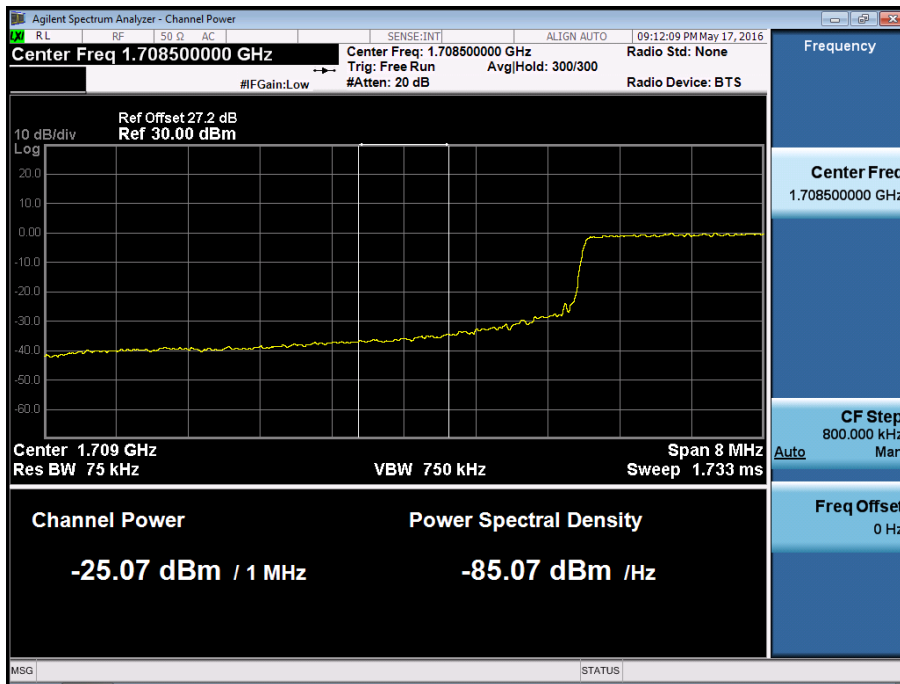

BAND 4. Lower Band Edge Plot (15M BW Ch.20025 QPSK RB 1, Offset 0) -1



BAND 4.Lower Band Edge Plot (15M BW Ch.20025 QPSK RB 75) -2

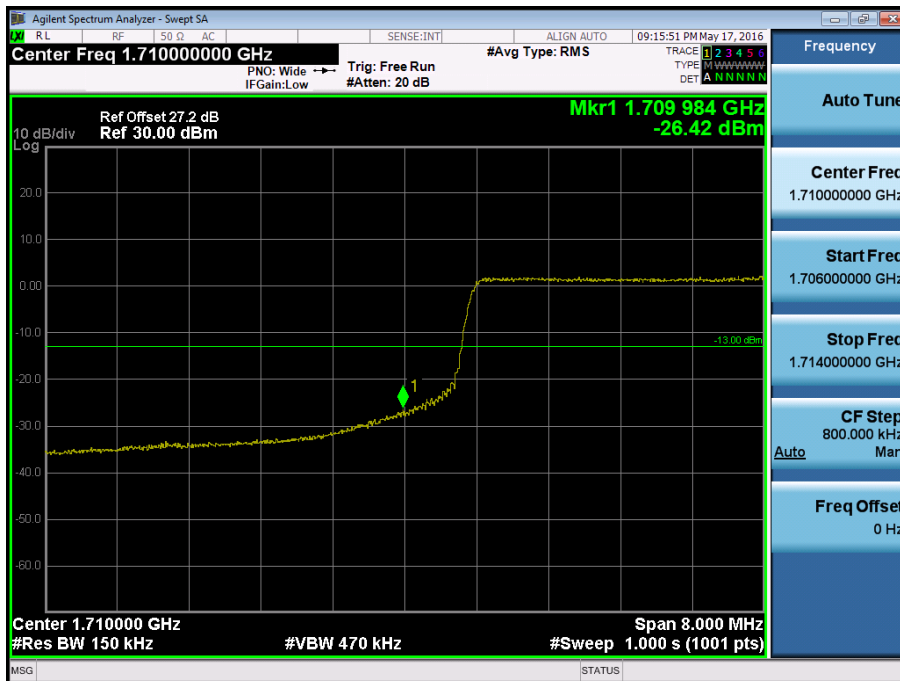

BAND 4. Lower Extended Band Edge Plot (15M BW Ch.20025 QPSK\_RB75\_0) -3

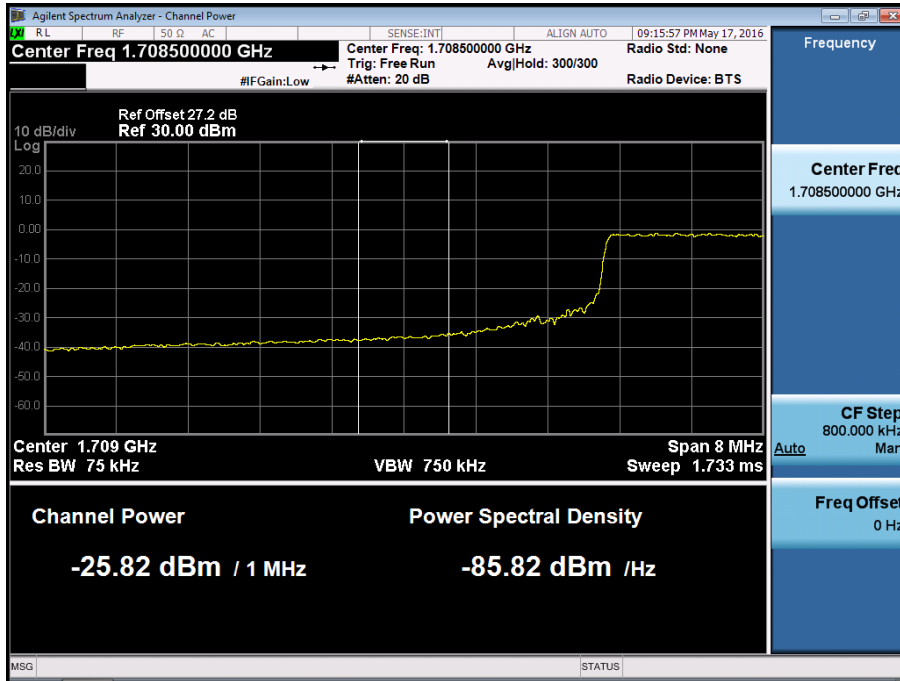

BAND 4.Lower Band Edge Plot (20M BW Ch.20050 QPSK RB 1, Offset 0) -1

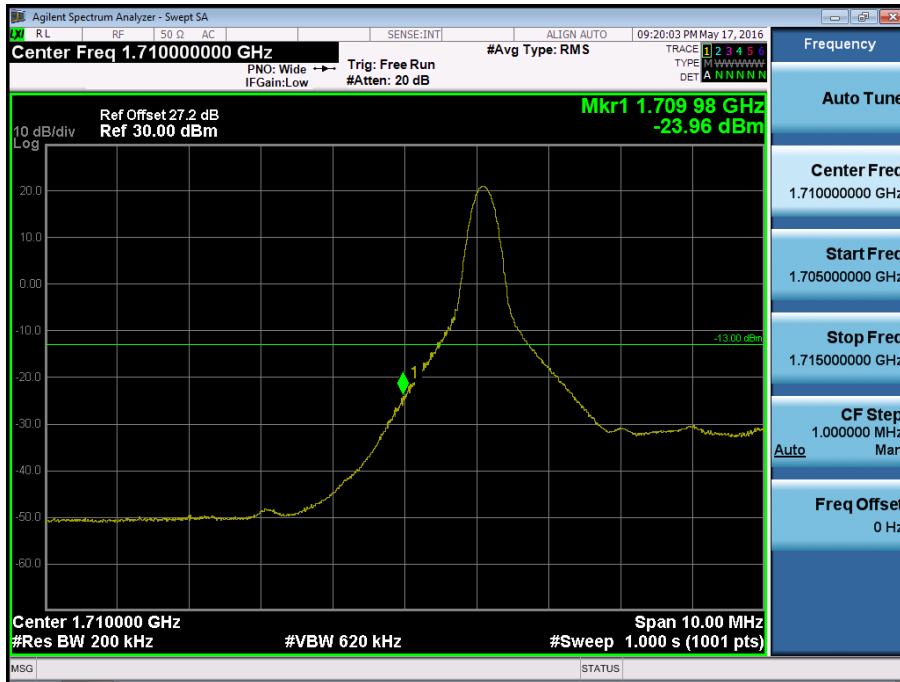



BAND 4.Lower Band Edge Plot (20M BW Ch.20050 QPSK RB 100) -2



BAND 4.Lower Extended Band Edge Plot (20M BW Ch.20050 QPSK\_RB100\_0) -3

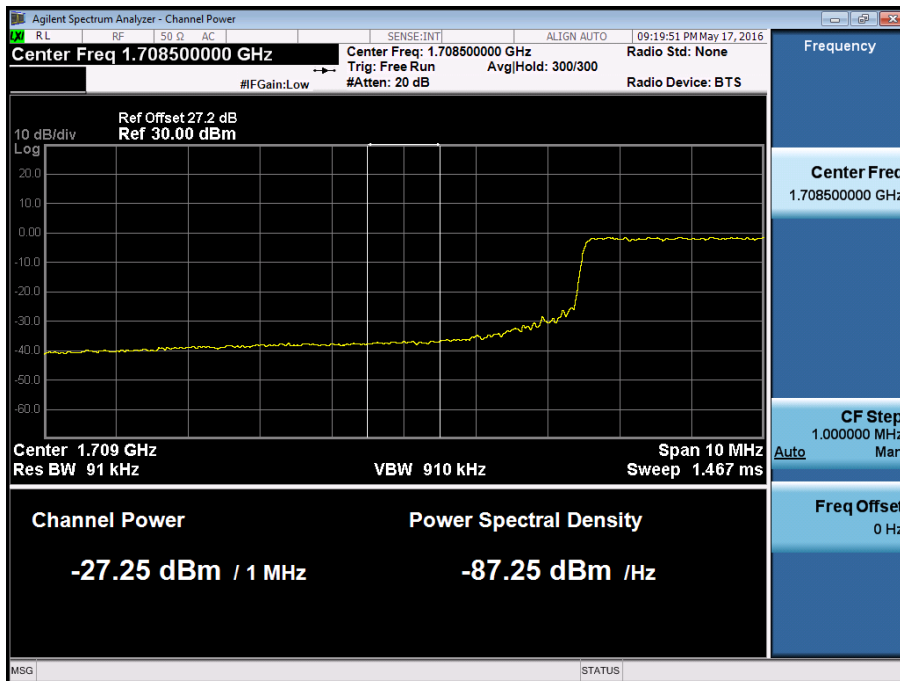

BAND 4. Upper Band Edge Plot (5M BW Ch.20375 QPSK\_RB1\_Offset 24) -1



BAND 4. Upper Band Edge Plot (5M BW Ch.20375 QPSK\_RB25) -2



BAND 4. Upper Extended Band Edge Plot (5M BW Ch.20375 QPSK\_RB25) -3

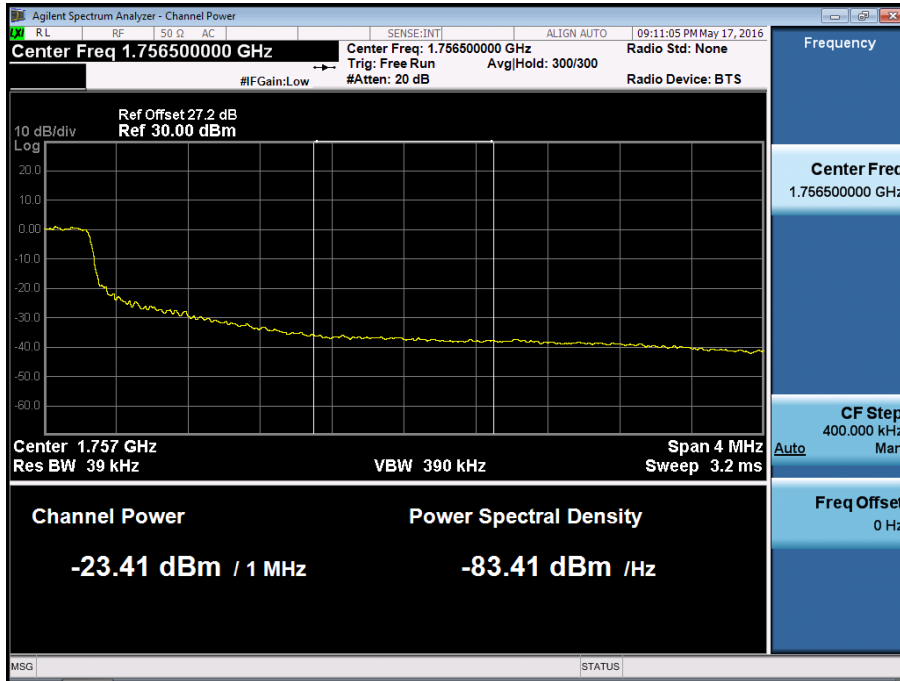

BAND 4. Upper Band Edge Plot (10M BW Ch.20350 QPSK\_RB1\_Offset 49) -1

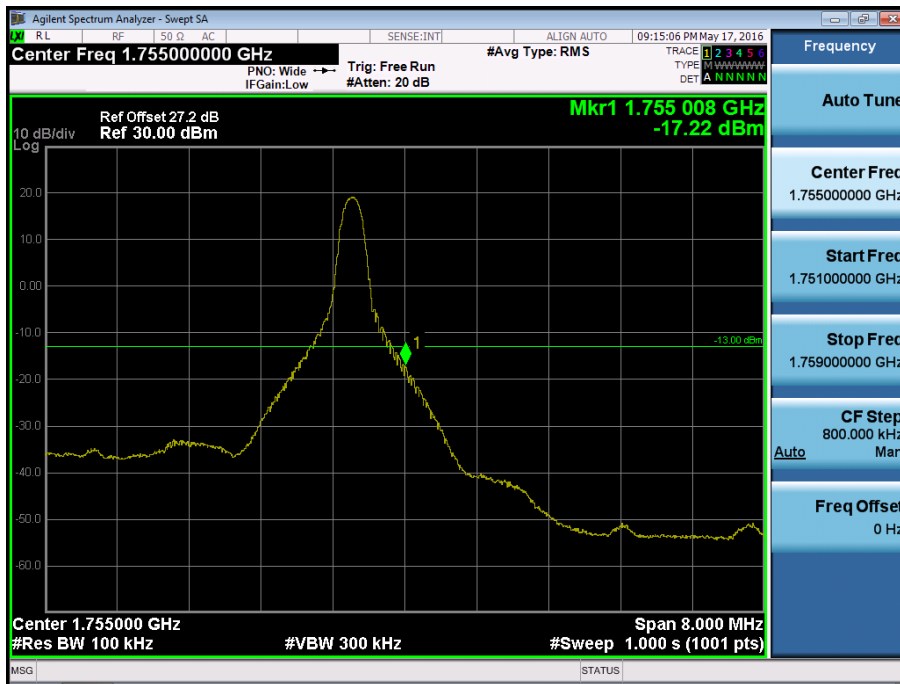

BAND 4. Upper Band Edge Plot (10M BW Ch.20350 QPSK\_RB50) -2



BAND 4. Upper Extended Band Edge Plot (10M BW Ch.20350 QPSK\_RB50) -3

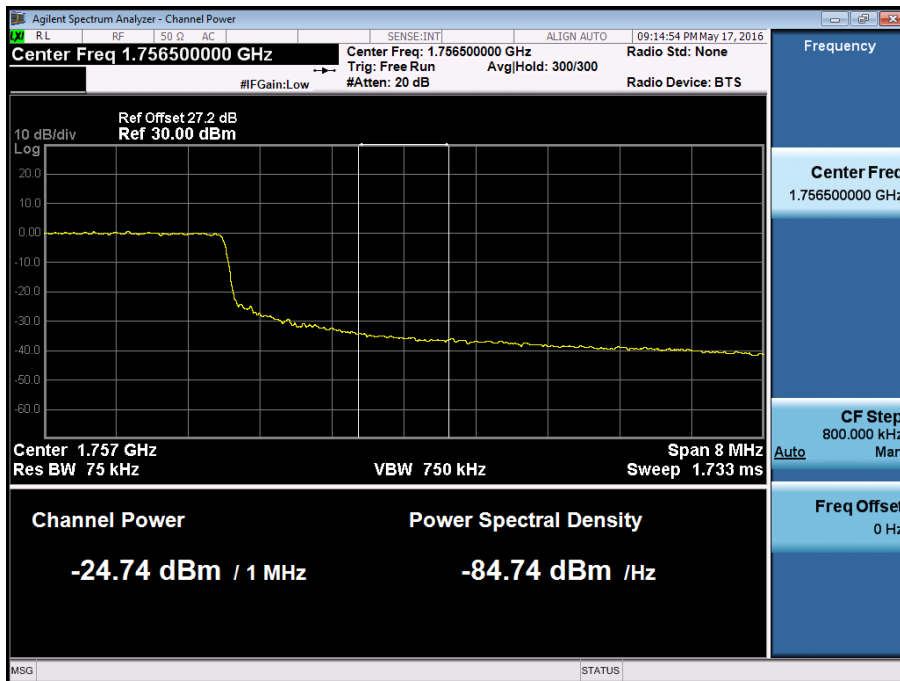

BAND 4. Upper Band Edge Plot (15M BW Ch.20325 QPSK\_RB1\_Offset 74) -1

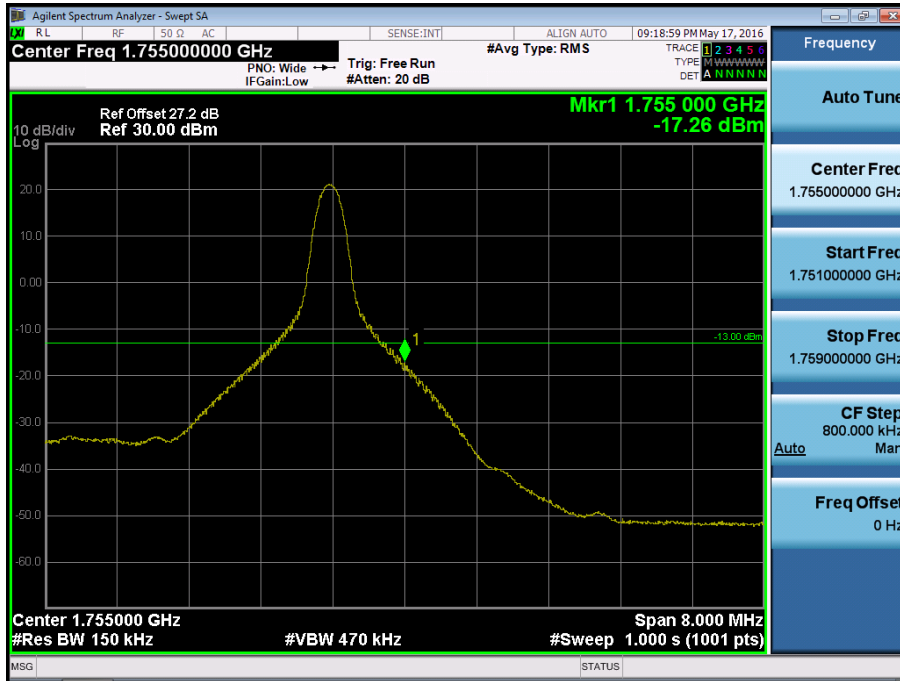

BAND 4. Upper Band Edge Plot (15M BW Ch.20325 QPSK\_RB75) -2



BAND 4. Upper Extended Band Edge Plot (15M BW Ch.20325 QPSK\_RB75) -3

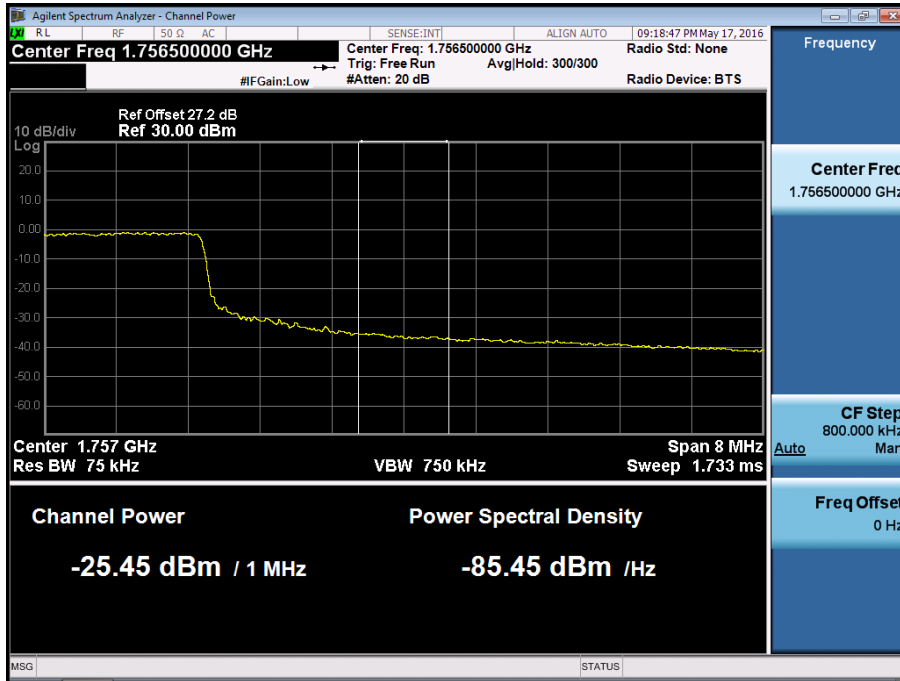

BAND 4. Upper Band Edge Plot (20M BW Ch.20300 QPSK\_RB1\_Offset 99) -1

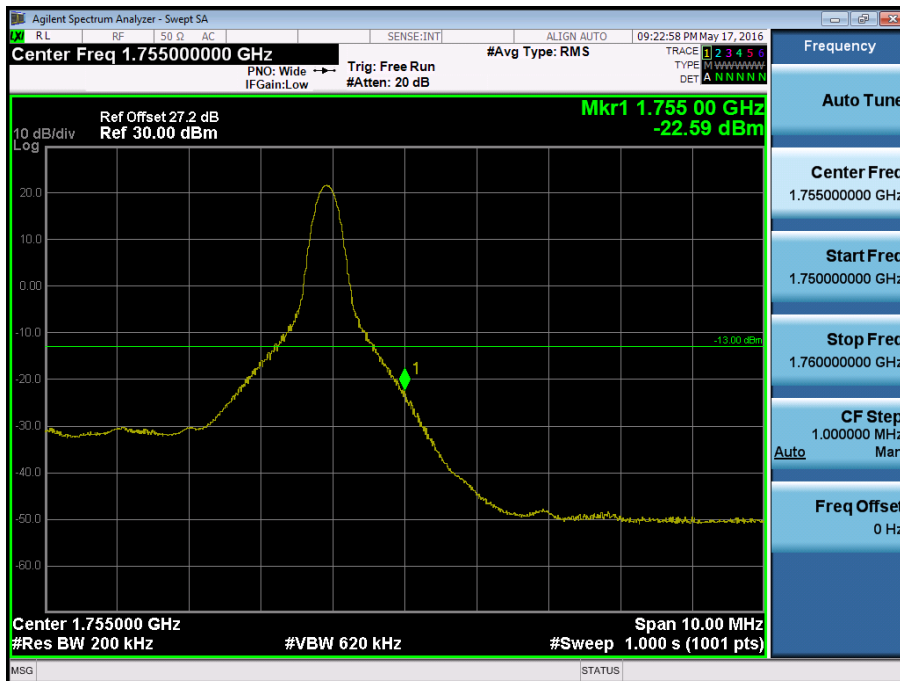

BAND 4. Upper Band Edge Plot (20M BW Ch.20300 QPSK\_RB100) -2



BAND 4. Upper Extended Band Edge Plot (20M BW Ch.20300 QPSK\_RB100) -3



BAND 13.Lower Emission Mask Plot (5M BW Ch.23205 QPSK RB 1, Offset 0) -1

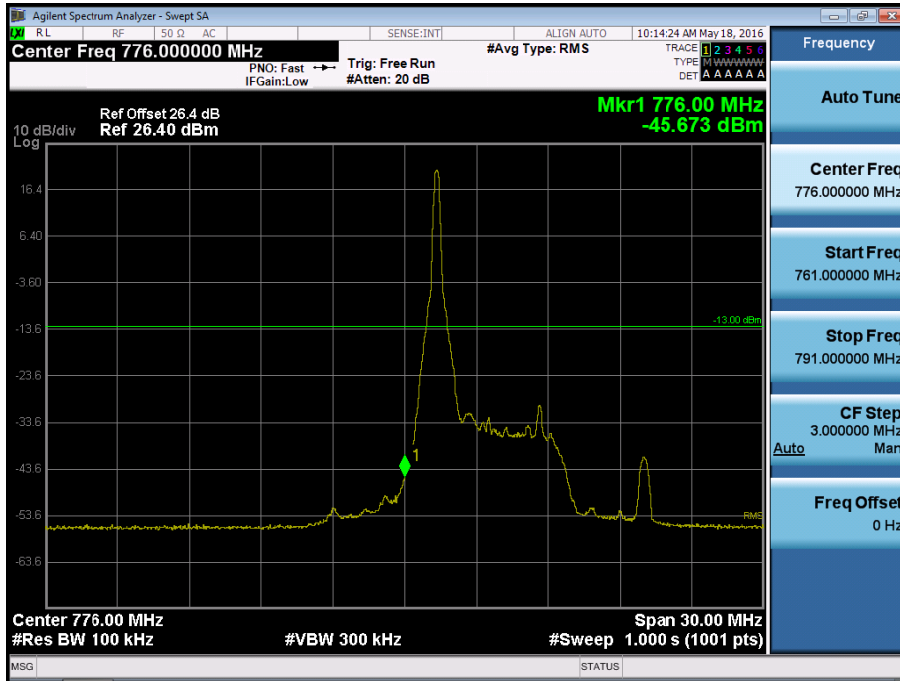

BAND 13. Lower Emission Mask Plot (5M BW Ch.23205 QPSK RB 25) -2





BAND 13. Lower Emission Mask Plot (5M BW Ch.23205 QPSK\_RB25\_0) -3

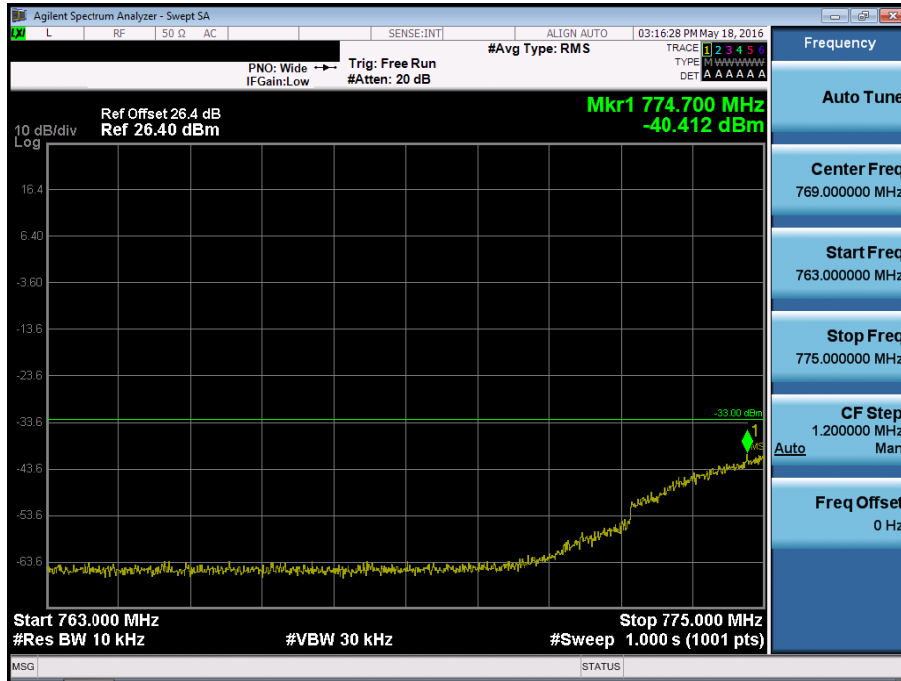

BAND 13. Lower Emission Mask Plot (10M BW Ch.23230 QPSK RB 1, Offset 0) -1

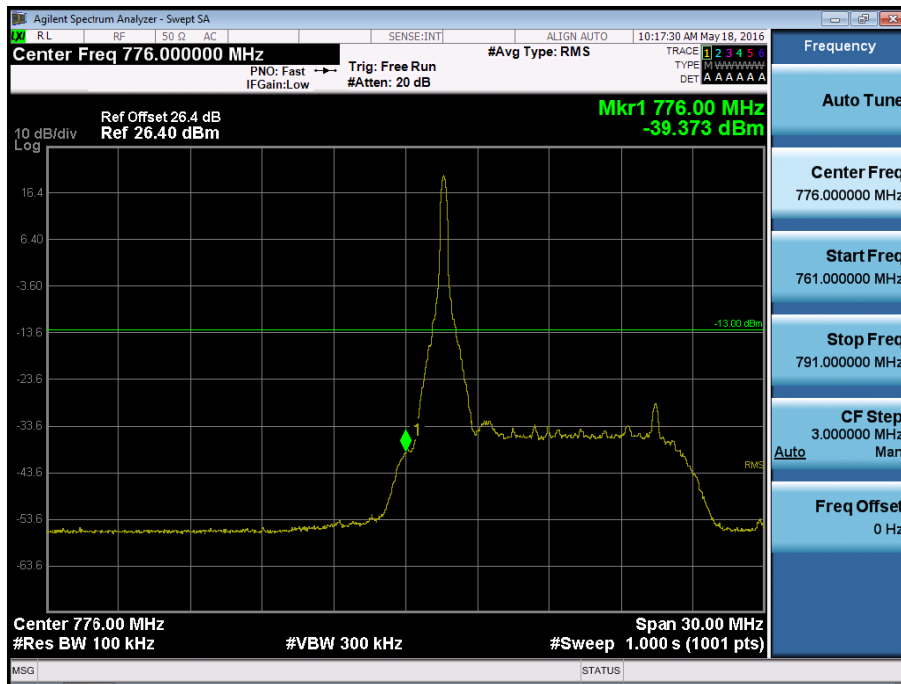

BAND 13. Lower Emission Mask Plot (10M BW Ch.23230 QPSK RB 50) -2

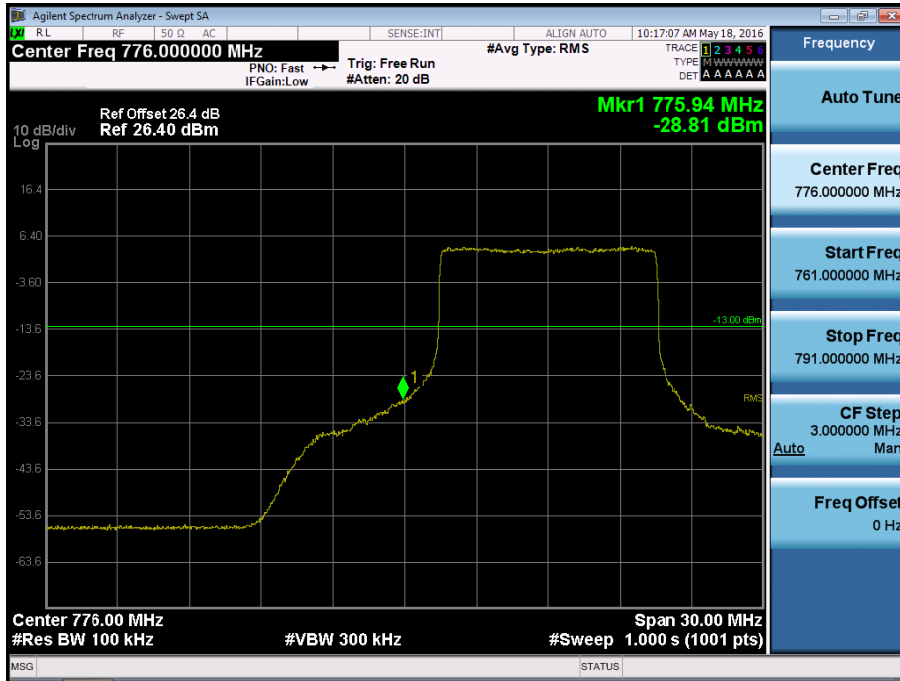

BAND 13.Lower Emission Mask Plot (10M BW Ch.23230 QPSK\_RB50\_0) -3

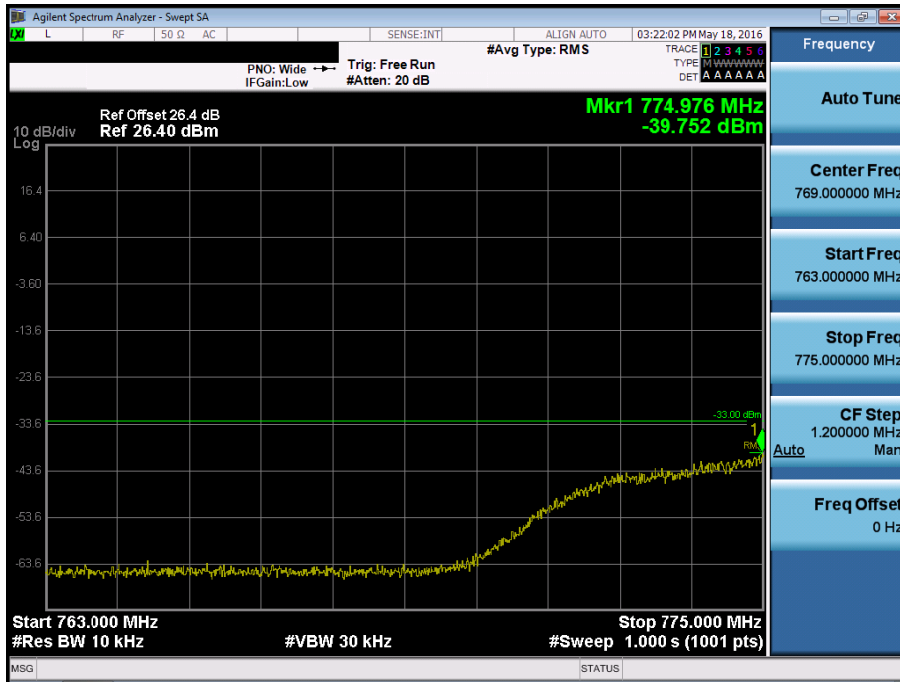

BAND 13. Upper Emission Mask Plot (5M BW Ch.23255 QPSK\_RB1\_Offset 24) -1

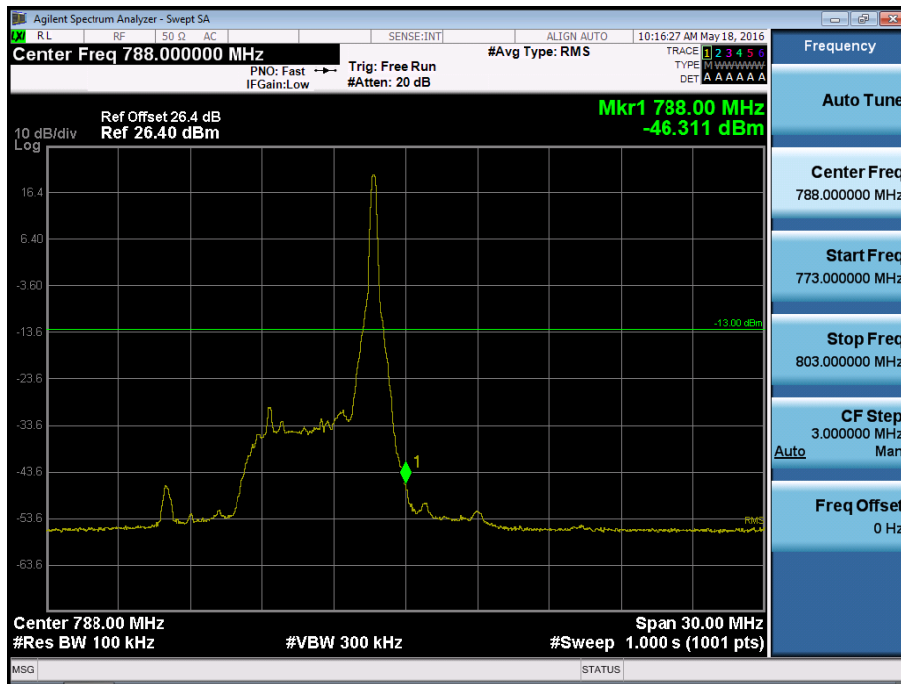

BAND 13. Upper Emission Mask Plot (5M BW Ch.23255 QPSK\_RB25) -2

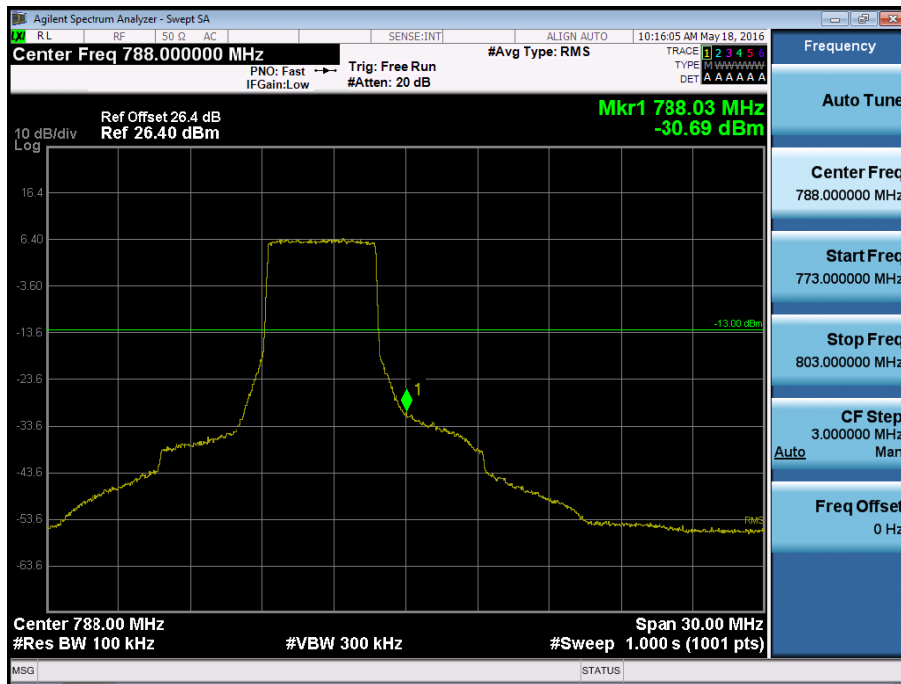

BAND 13. Upper Emission Mask Plot (5M BW Ch.23255 QPSK\_RB25) -3

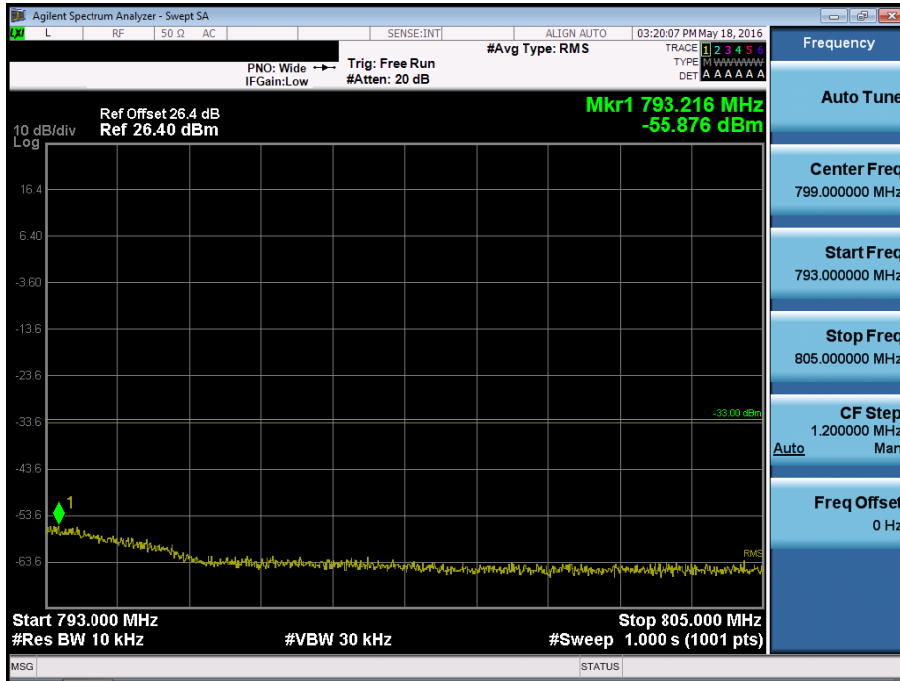

BAND 13. Upper Emission Mask Plot (10M BW Ch.23230 QPSK\_RB1\_Offset 49) -1

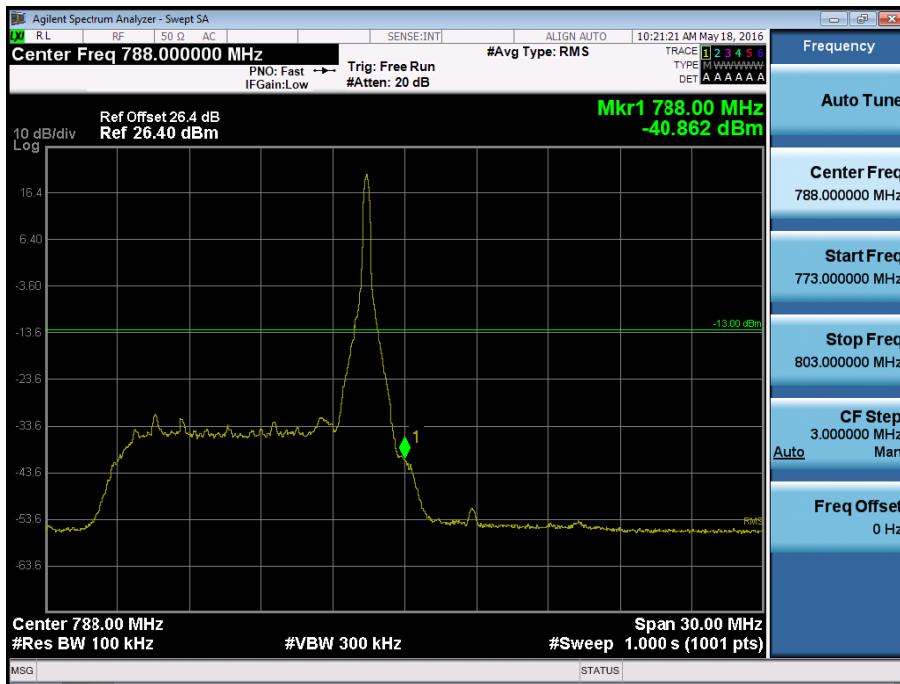

BAND 13. Upper Emission Mask Plot (10M BW Ch.23230 QPSK\_RB50) -2



BAND 13. Upper Emission Mask Plot (10M BW Ch.23230 QPSK\_RB50) -3

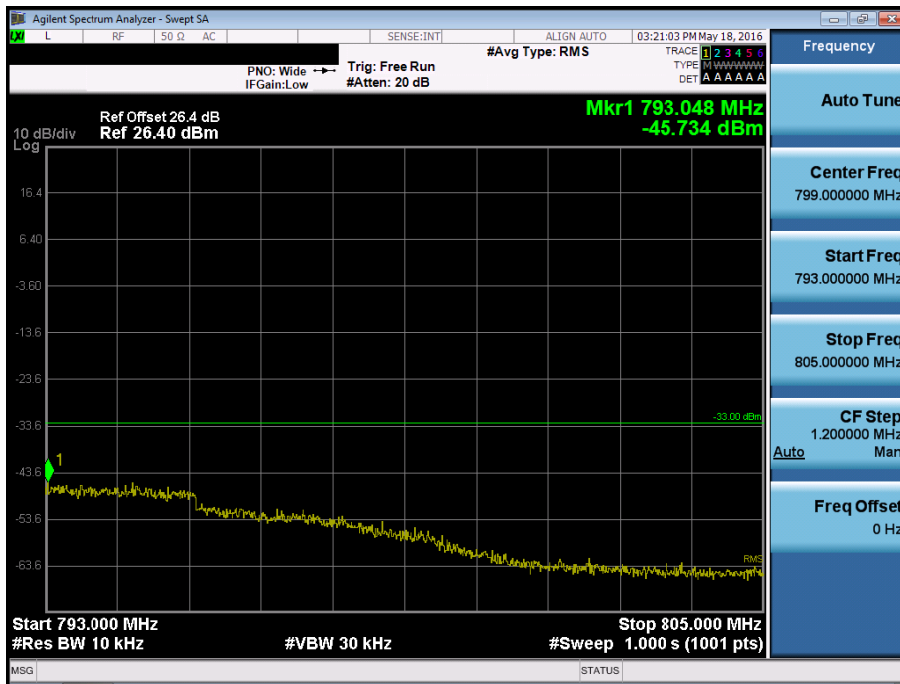

BAND 4. Conducted Spurious Plot\_1 (19975ch\_5MHz\_QPSK\_RB 1\_0)

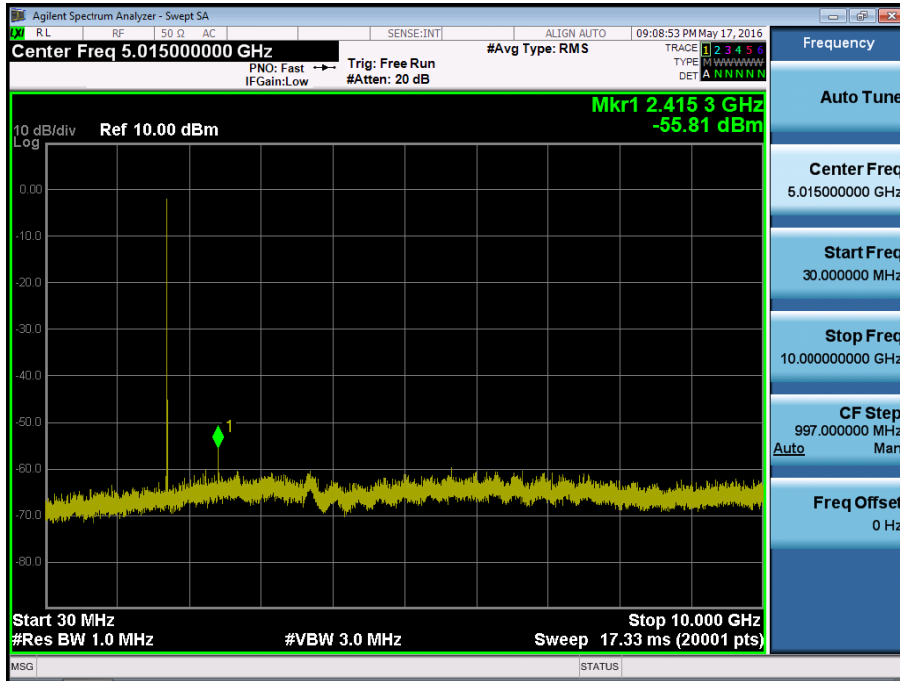

BAND 4. Conducted Spurious Plot\_2 (19975ch\_5MHz\_QPSK\_RB 1\_0)

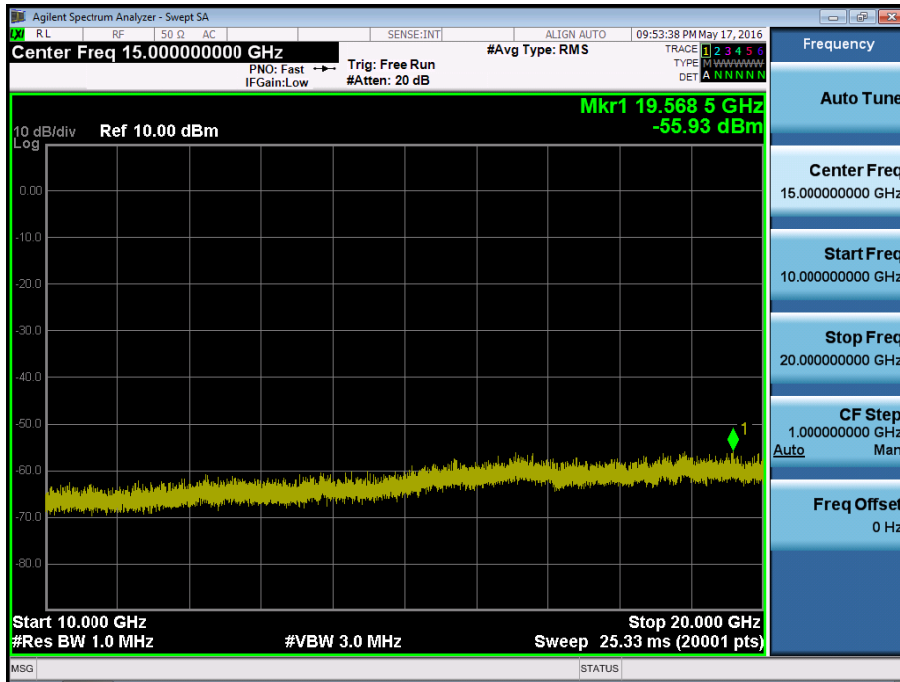

BAND 4. Conducted Spurious Plot\_1 (20175ch\_5MHz\_QPSK\_RB 1\_0)

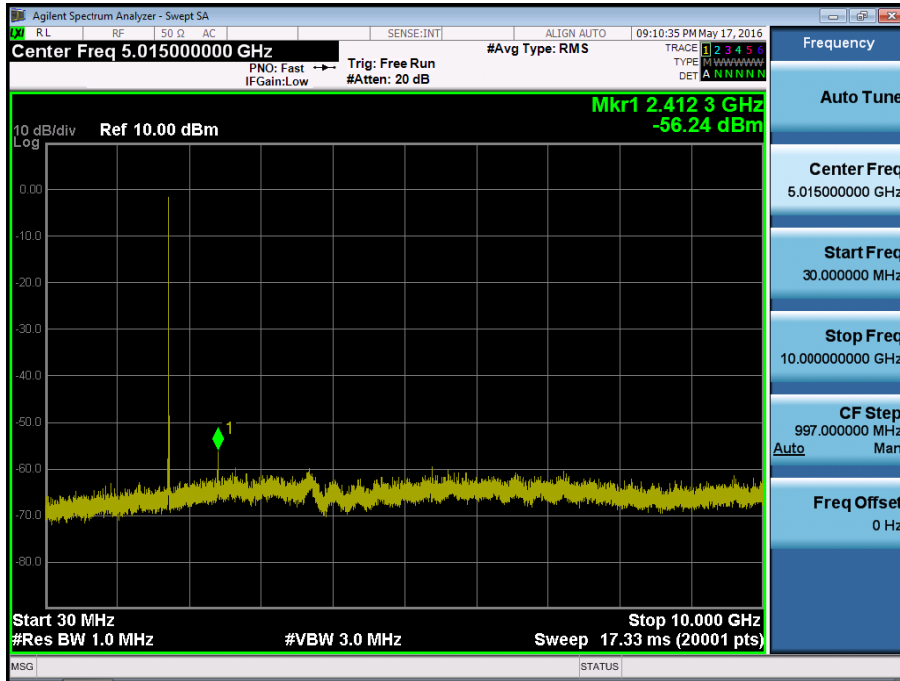

BAND 4. Conducted Spurious Plot\_2 (20175ch\_5MHz\_QPSK\_RB 1\_0)

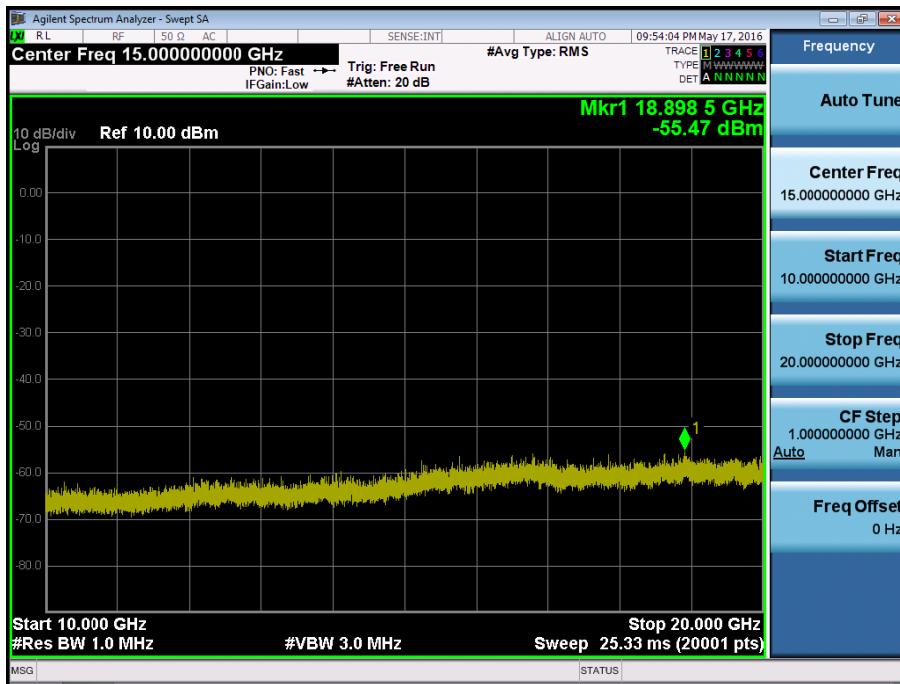

BAND 4. Conducted Spurious Plot\_1 (20375ch\_5MHz\_QPSK\_RB 1\_0)

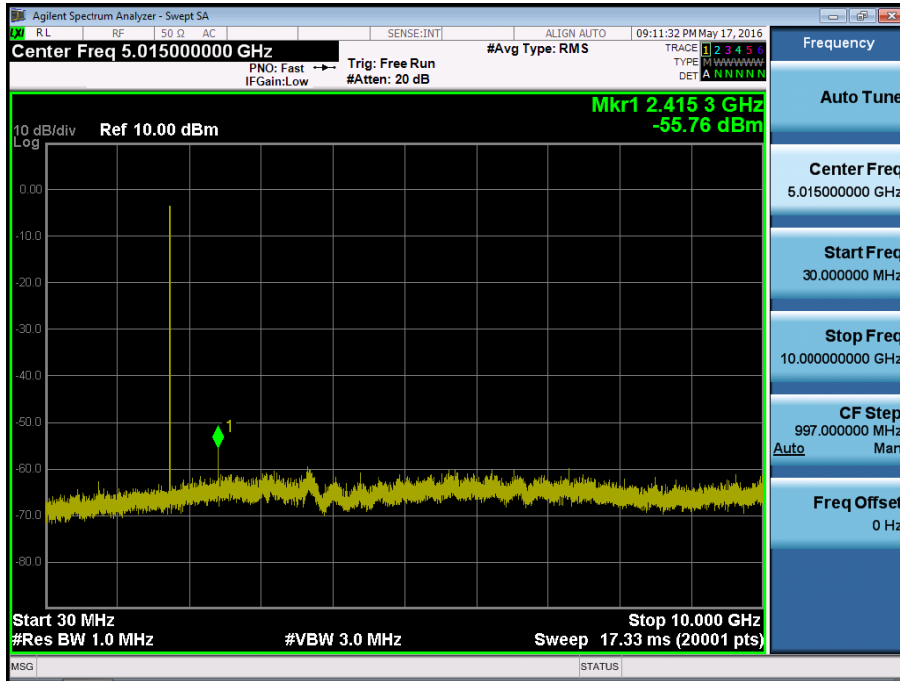

BAND 4. Conducted Spurious Plot\_2 (20375ch\_5MHz\_QPSK\_RB 1\_0)

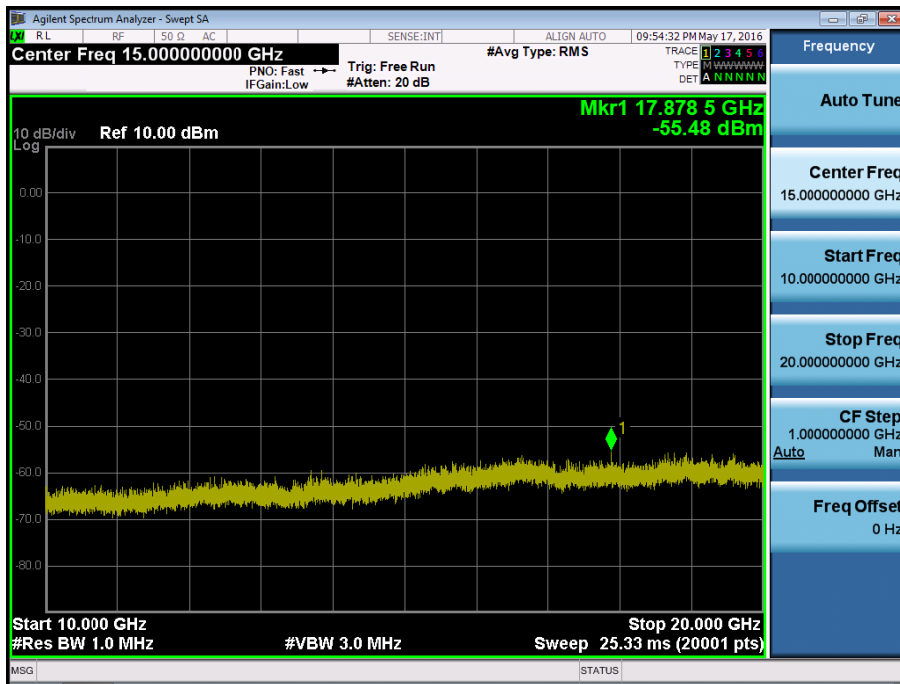



BAND 4. Conducted Spurious Plot\_1 (20000ch\_10MHz\_QPSK\_RB 1\_0)

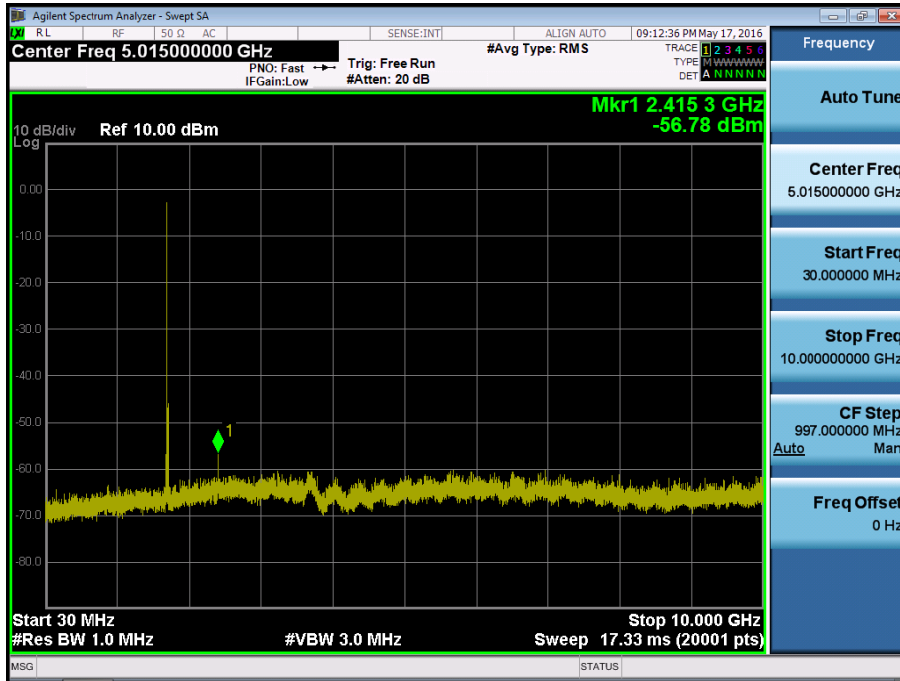

BAND 4. Conducted Spurious Plot\_2 (20000ch\_10MHz\_QPSK\_RB 1\_0)

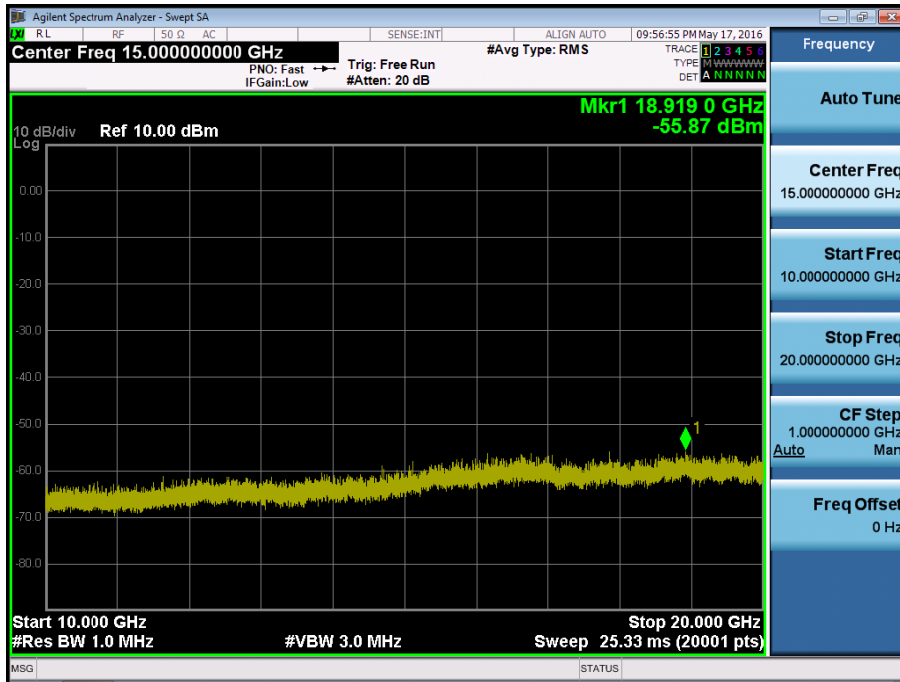

BAND 4. Conducted Spurious Plot\_1 (20175ch\_10MHz\_QPSK\_RB 1\_0)

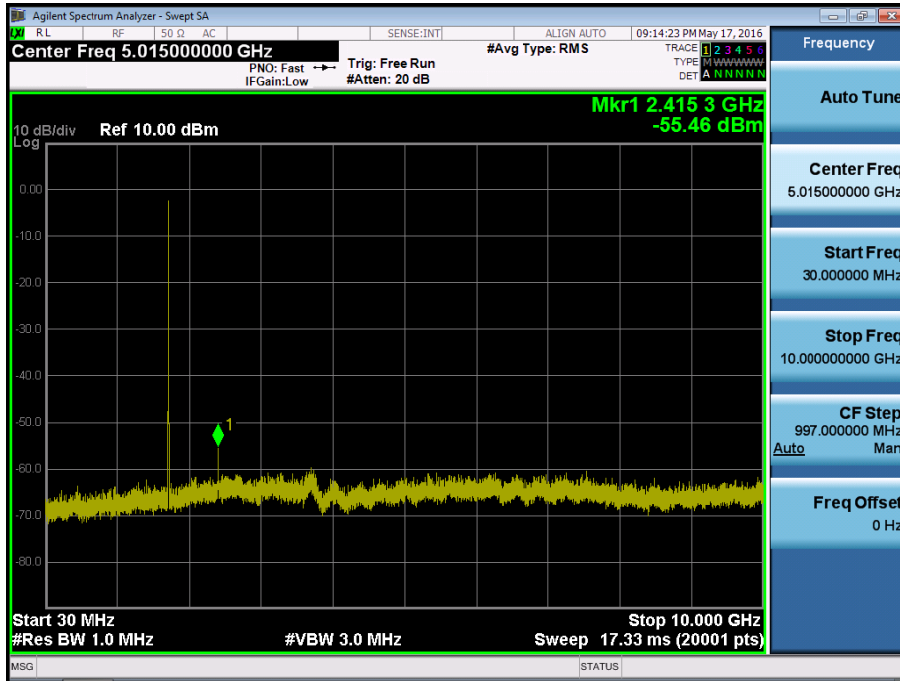

BAND 4. Conducted Spurious Plot\_2 (20175ch\_10MHz\_QPSK\_RB 1\_0)

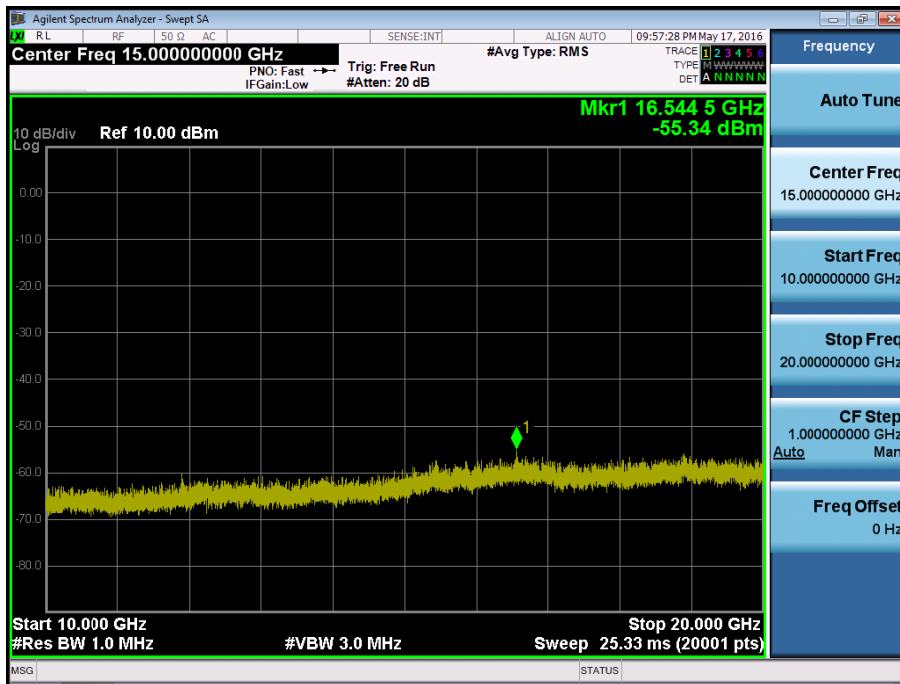

BAND 4. Conducted Spurious Plot\_1 (20350ch\_10MHz\_QPSK\_RB 1\_0)

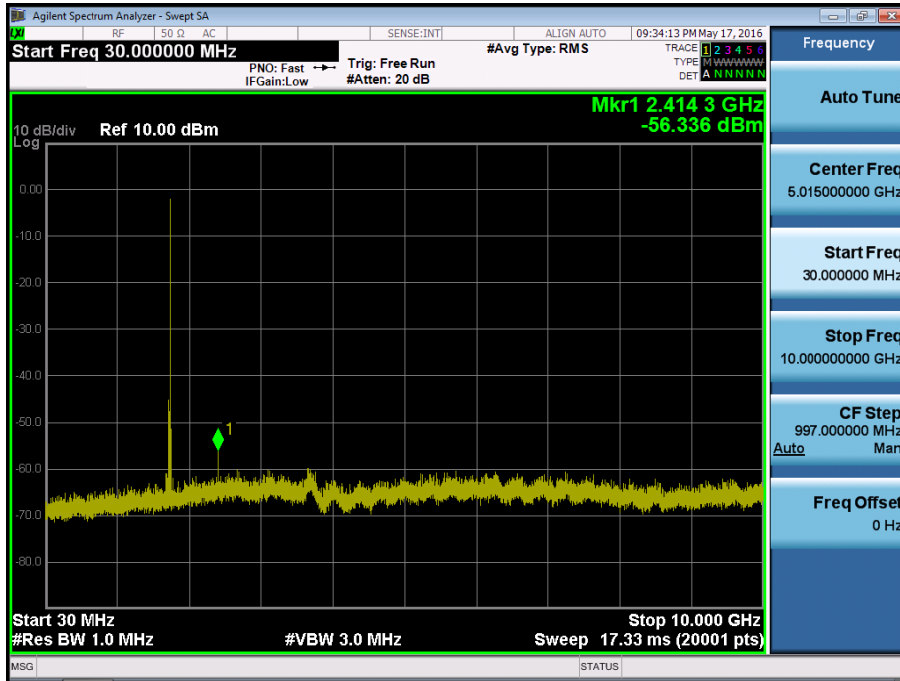

BAND 4. Conducted Spurious Plot\_2 (20350ch\_10MHz\_QPSK\_RB 1\_0)

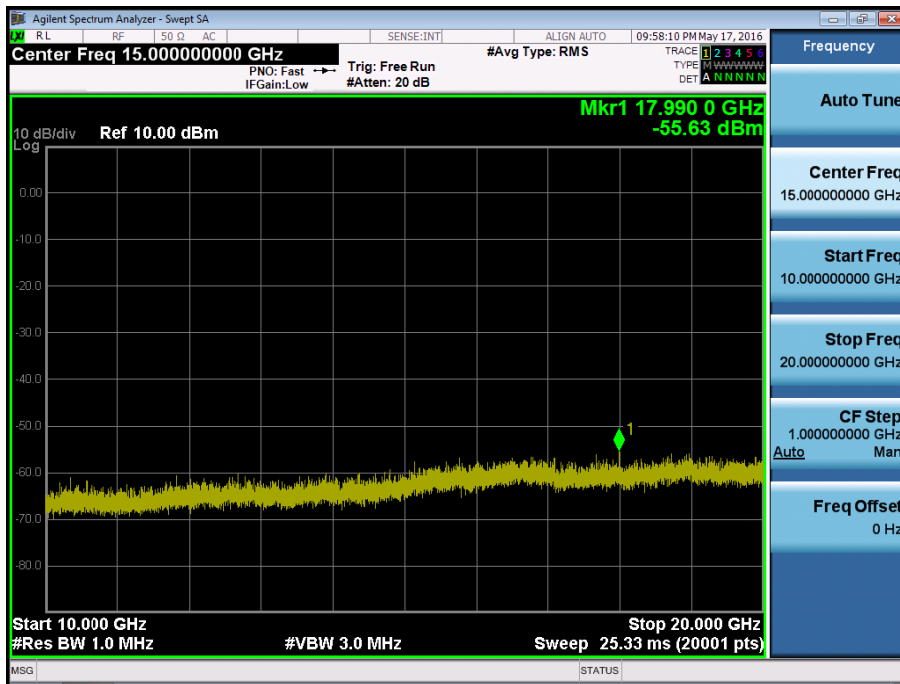

BAND 4. Conducted Spurious Plot\_1 (20025ch\_15MHz\_QPSK\_RB 1\_0)

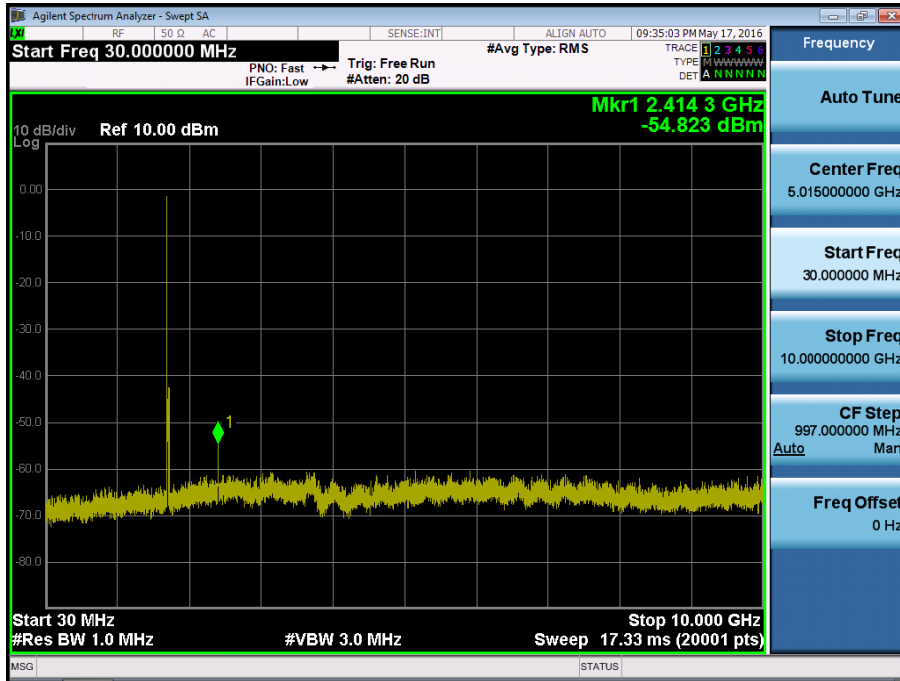

BAND 4. Conducted Spurious Plot\_2 (20025ch\_15MHz\_QPSK\_RB 1\_0)

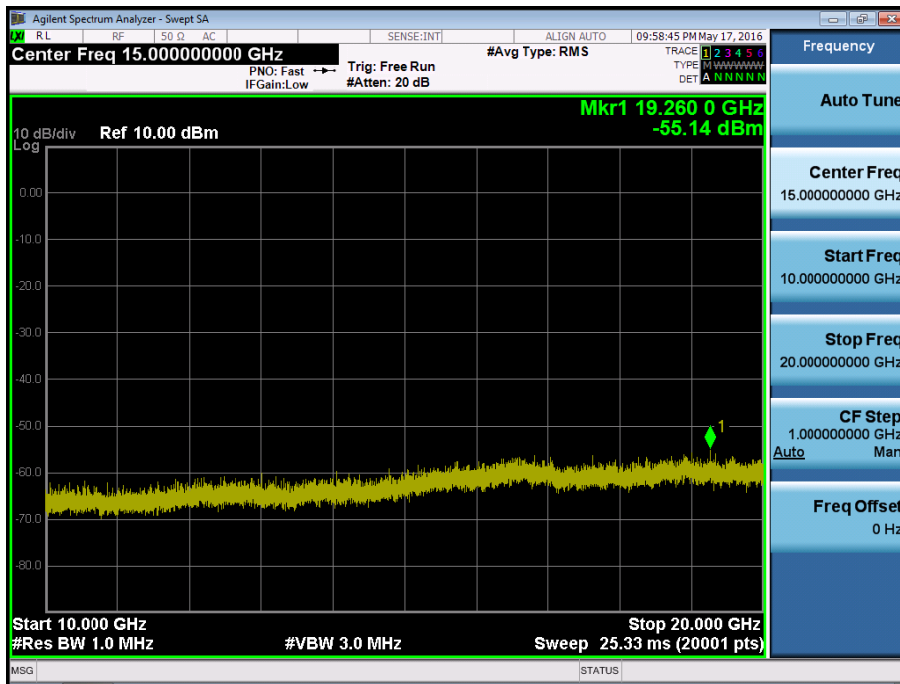

BAND 4. Conducted Spurious Plot\_1 (20175ch\_15MHz\_QPSK\_RB 1\_0)

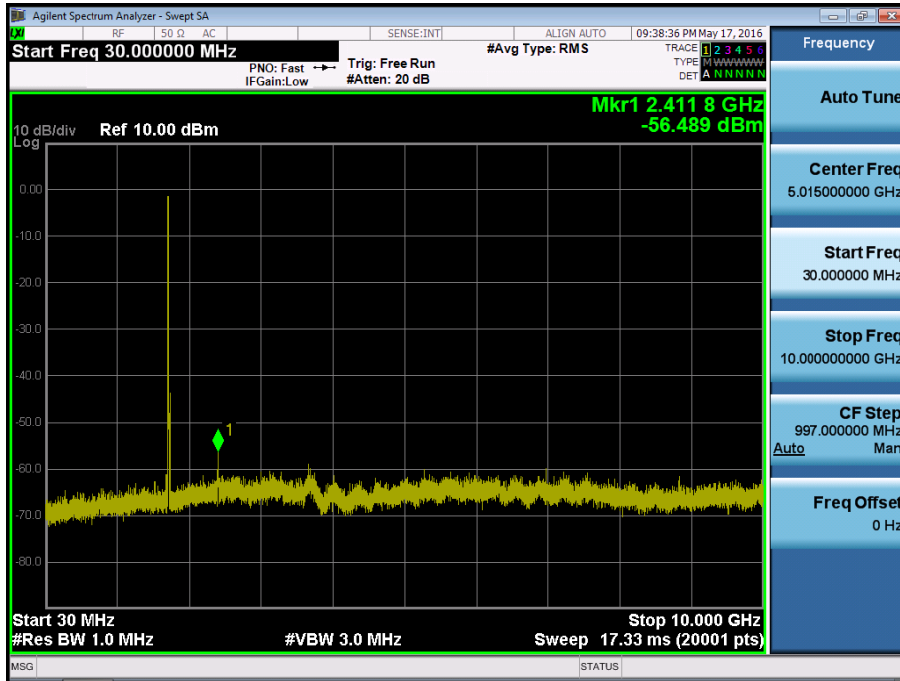

BAND 4. Conducted Spurious Plot\_2 (20175ch\_15MHz\_QPSK\_RB 1\_0)

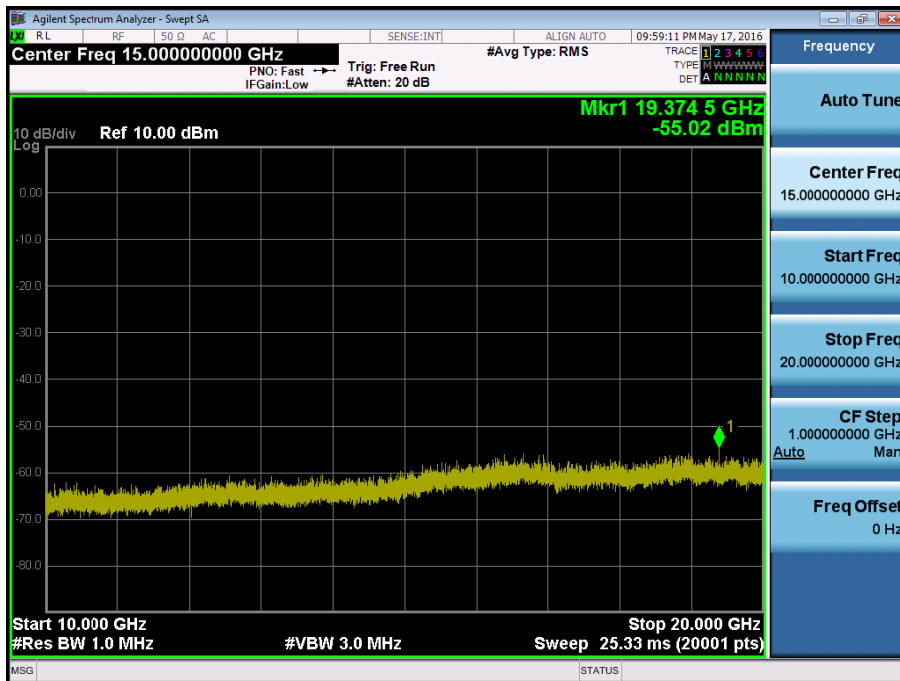

BAND 4. Conducted Spurious Plot\_1 (20325ch\_15MHz\_QPSK\_RB 1\_0)

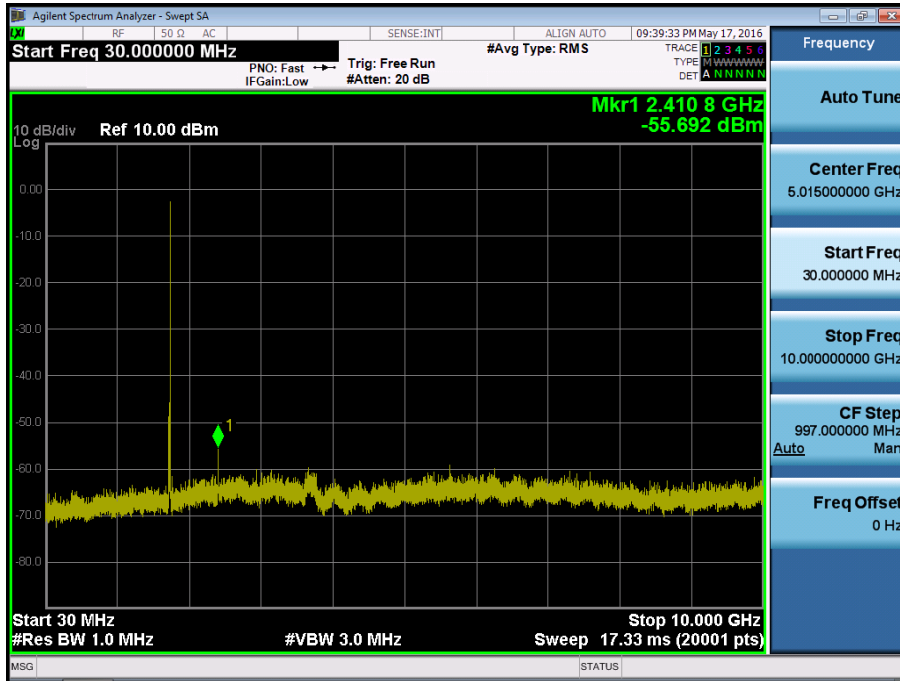

BAND 4. Conducted Spurious Plot\_2 (20325ch\_15MHz\_QPSK\_RB 1\_0)

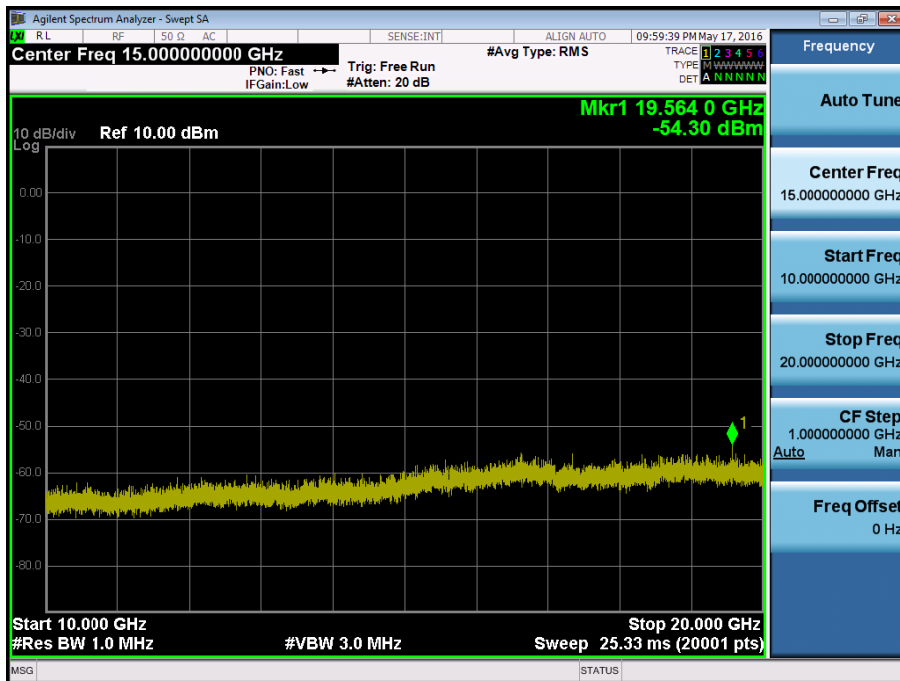

BAND 4. Conducted Spurious Plot\_1 (20050ch\_20MHz\_QPSK\_RB 1\_0)

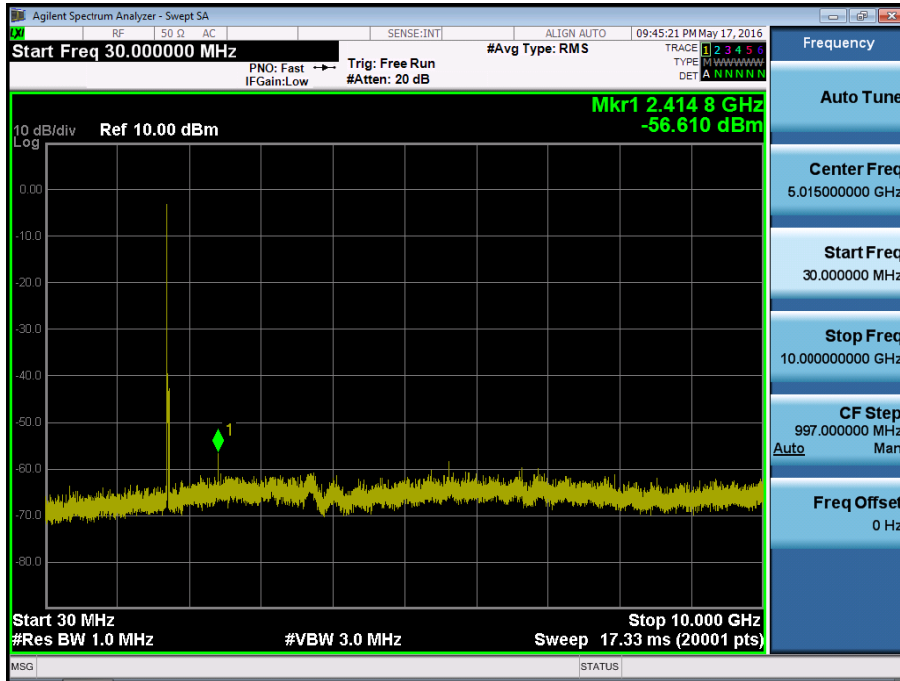

BAND 4. Conducted Spurious Plot\_2 (20050ch\_20MHz\_QPSK\_RB 1\_0)

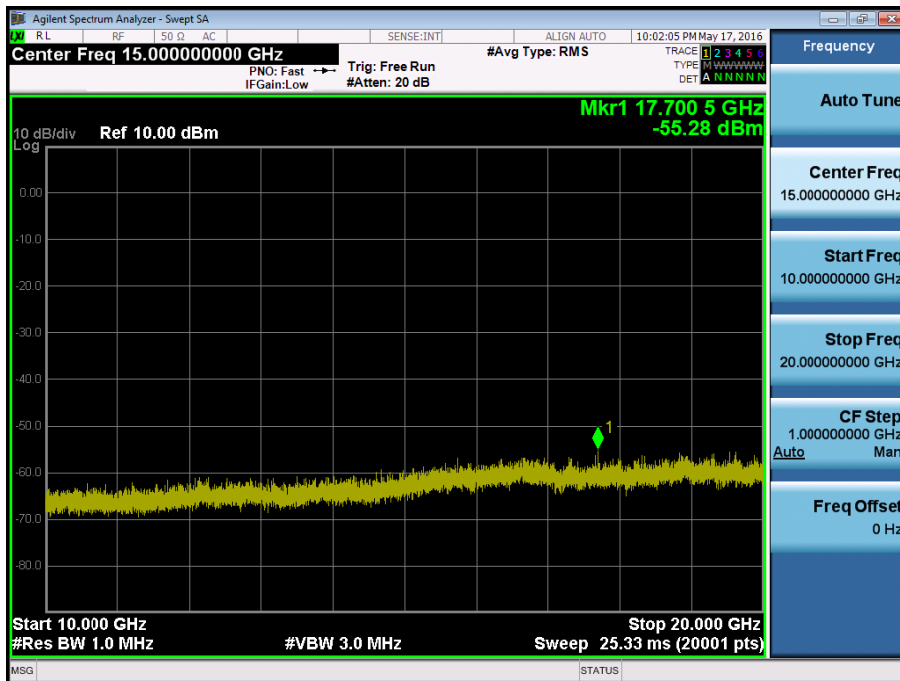

BAND 4. Conducted Spurious Plot\_1 (20175ch\_20MHz\_QPSK\_RB 1\_0)

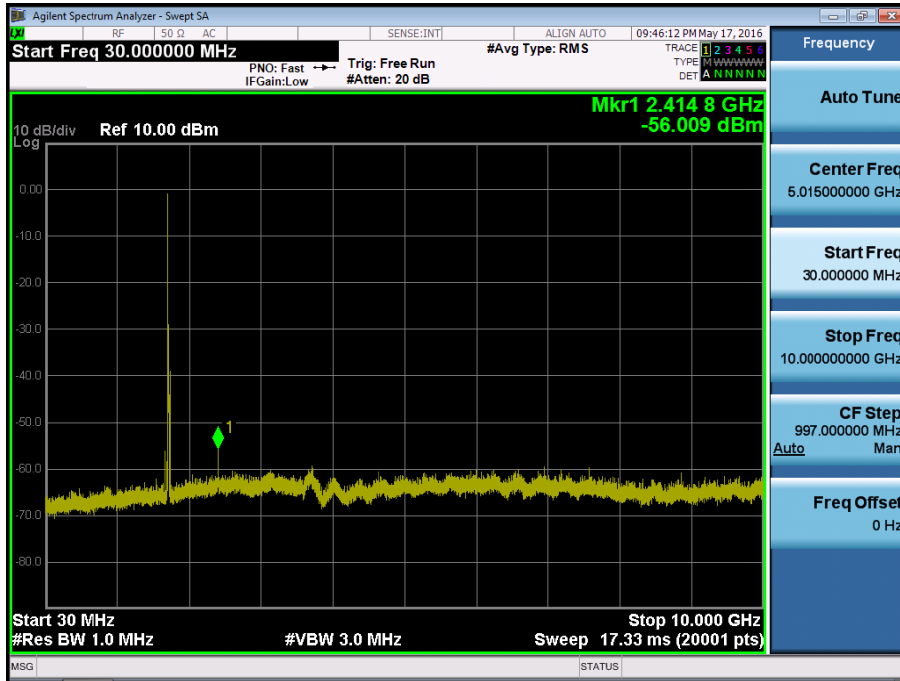

BAND 4. Conducted Spurious Plot\_2 (20175ch\_20MHz\_QPSK\_RB 1\_0)

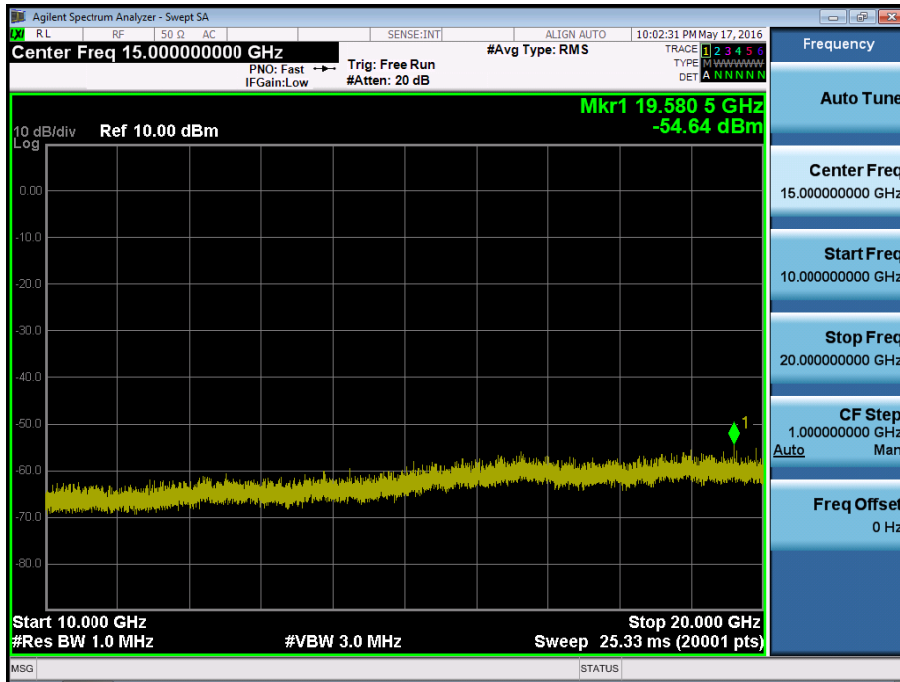



BAND 4. Conducted Spurious Plot\_1 (20300ch\_20MHz\_QPSK\_RB 1\_0)

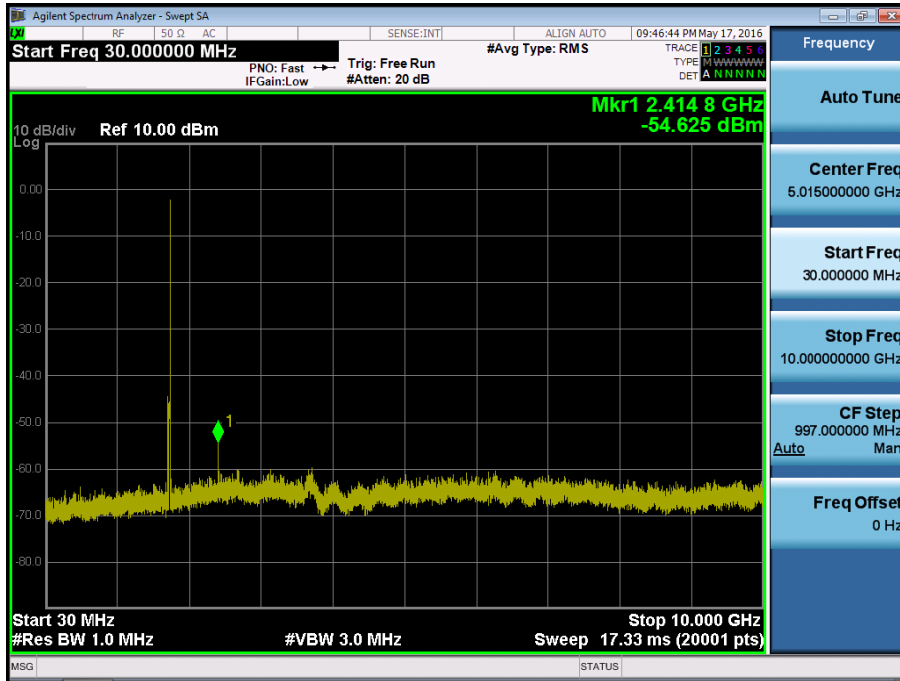

BAND 4. Conducted Spurious Plot\_2 (20300ch\_20MHz\_QPSK\_RB 1\_0)

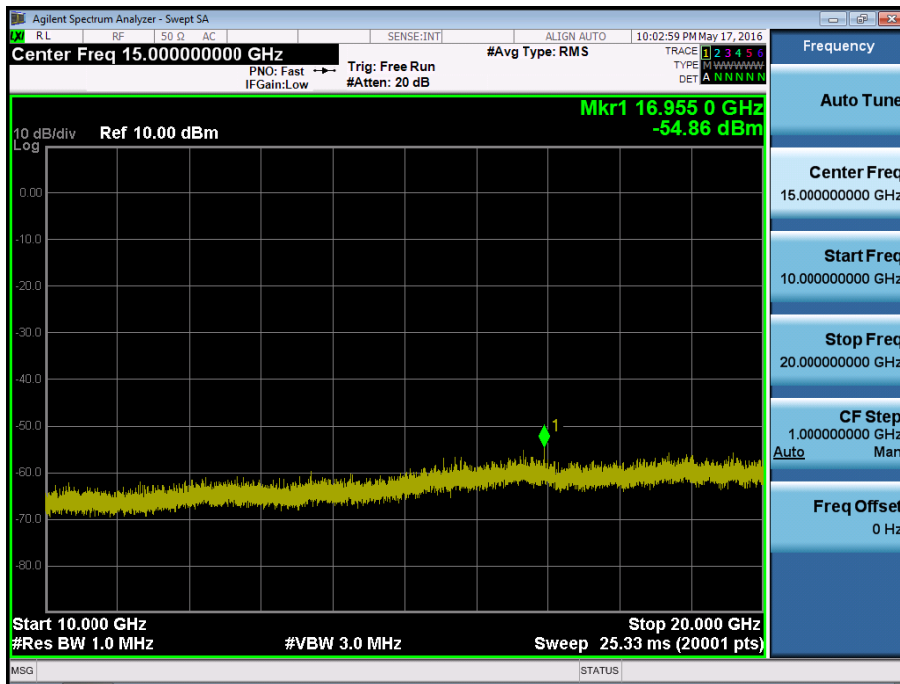

BAND 13. Conducted Spurious Plot (23205ch\_5MHz\_QPSK\_RB 1\_0)

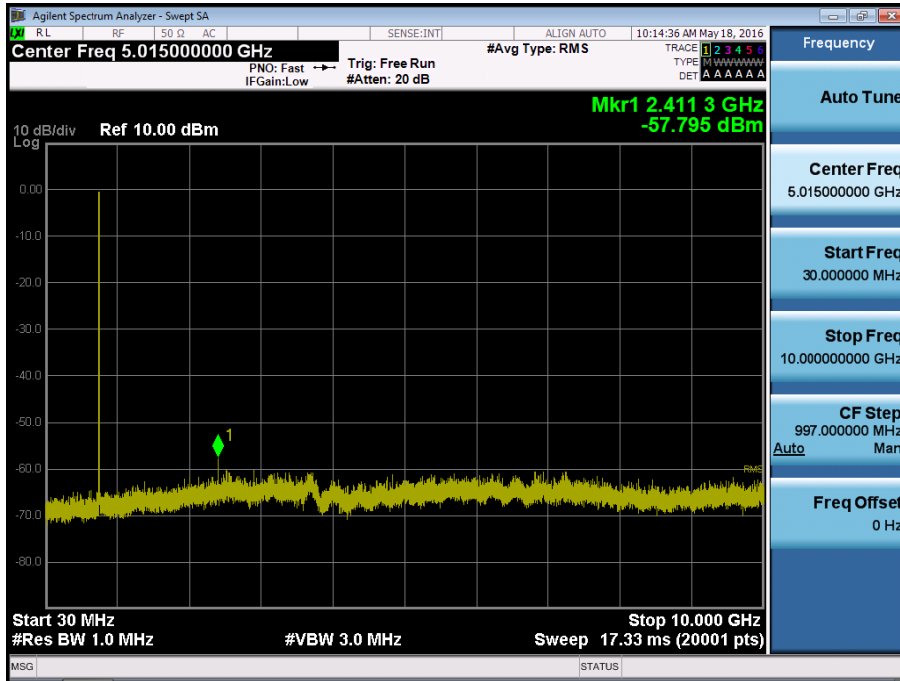

BAND 13. Conducted Spurious Plot (23230ch\_5MHz\_QPSK\_RB 1\_0)

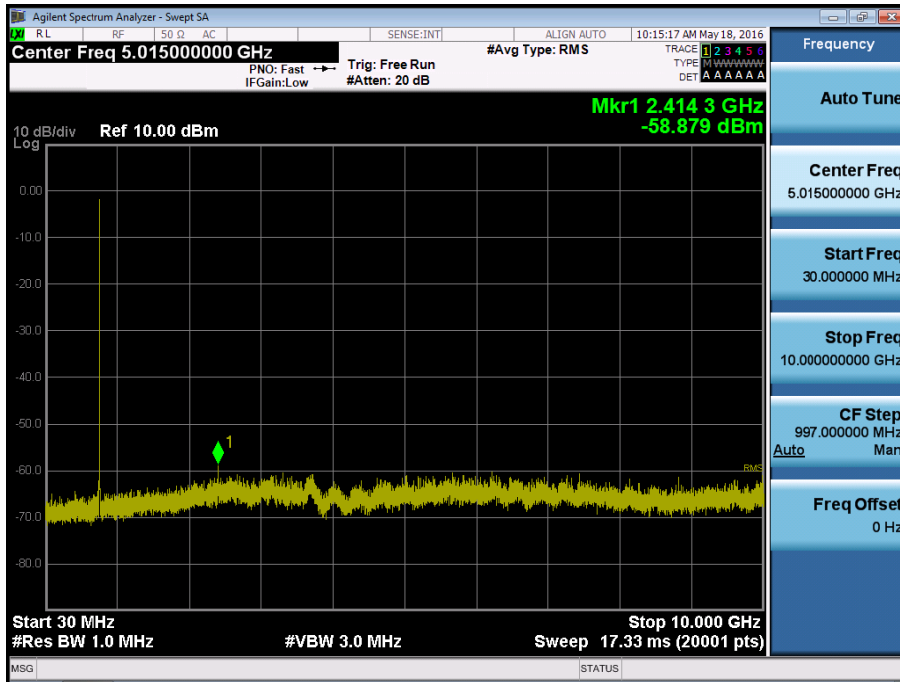

BAND 13. Conducted Spurious Plot (23255ch\_5MHz\_QPSK\_RB 1\_0)

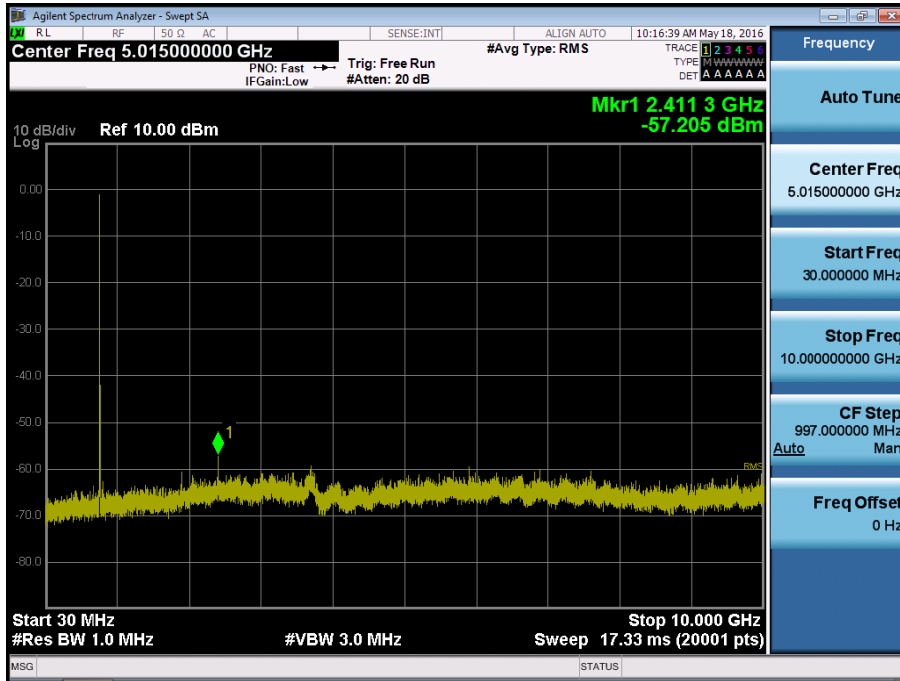

BAND 13. Conducted Spurious Plot (Ch.23230 10 MHz QPSK RB 1, Offset 0)

