

CONFORMANCE TEST REPORT**FOR****Subpart C Part 15.247****Report No. : JNDL-NU-14R-0005**

Client: Franklin Technology Inc.
Product: LTE/WIFI MOBILE ROUTER
Model: R774
Manufacture/supplier: Franklin Technology Inc.



Date test item received: 2014/04/18
Date test campaign completed: 2014/05/29
Date of issue: 2014/06/02

ATTESTATION STATEMENT

This equipment has been tested in accordance with the standards identified in the referenced test report. To the best of my knowledge and belief, these tests were performed using the measurement procedures described in this report and demonstrate that the equipment complies with the appropriate standards.

All JNDL Laboratory. CO., LTD instrumentation and accessories used to test products for compliance to the indicated standards are calibrated regularly in accordance with ISO 17025 requirements.

Total number of pages of this test report : 99 pages

Test engineer	Report reviewed by
 2014.6.2	 2014.6.2
Sang-hun kang	Kyoung-Pil, Yeom

REPORT SUMMARY

Purpose of Test :	To demonstrate the EUT in compliance with Part 15.247 Subpart C of the FCC's
Disclaimer :	The test results relate only to the items tested.
Applicable Standards :	Pt 15.247, ANSI 63.4:2009

TEST ENVIRONMENT AND TEST SETUP

Test Facilities :	Test Firm Registration # : 748649 3m & 10m Open Site : 386-1, Ho-dong, Cheoin-gu, Yongin-si, Gyeonggi-do, Korea 3m semi-Anechoic chamber : B 114~115, 810 Kwanyang-Dong, dongan-Gu, Anyang-Si, Kyunggi-Do, 431-060, Korea
Laboratory Test Conditions :	Open Site : Temperature 25 °C, Humidity : 55 % 3m anechoic chamber : Temperature 25 °C, Humidity : 53 %
Test Exercise :	The EUT was set in continuous transmit mode(99% Duty cycle) of operation unless stated otherwise.
Modification to the EUT :	No modification was made.
Supporting Accessories :	None

REVISION HISTORY

Revision	Date	Descriptions
0	2014.06.02	Original release

Table of Contents

1. General Remarks	4
2. Test Site	4
2.1 Location	4
2.2 List of Test equipment used for tests.....	4
2.3 Test Date	4
3. Description of the Equipment Under Test	5
3.1 Manufacturers declarations	5
3.2 Information about EUT.....	6
4. List of Measurements.....	7
5. Transmitter Conducted & Radiated emissions setup.....	8
6. Occupied Bandwidth (6 dB).....	10
7. Transmitter Output Power.....	16
8. Out of Band Emissions / Band Edge.....	50
9. Transmitter Power Spectral Density	77
10. General Field Strength Limits(Restricted Bands and Radiated Emission Limits).....	84
11. AC Power Line Conducted Emissions	92
12. Antenna Requirement.....	99

1. General Remarks

The test results in this report apply to the particular Equipment Under Test (EUT) as declared in this report.
The test results presented in this report relate only to the item tested.

2. Test Site

2.1 Location

JNDL Laboratory. CO., LTD. (Test Firm Registration # : 748649)

3m anechoic chamber : B 114~115, 810 Kwanyang-Dong, dongan-Gu, Anyang-Si, Kyunggi-Do, Korea

3m & 10m Open site : 386-1, Ho-dong, Cheoin-gu, Yongin-si, Gyeonggi-do, Korea

2.2 List of Test equipment used for tests

No.	Instrument	Model No.	Due to Calibration	Manufactor	Serial No.
<input checked="" type="checkbox"/>	PSA SPECTRUM ANALYZER (3 Hz ~ 26.5 GHz)	E4440A	2014-10-15	Agilent Technologies	MY46185375
<input checked="" type="checkbox"/>	SPECTRUM ANALYZER (20 Hz ~ 40.0 GHz)	FSP40	2015-01-08	Rohde & Schwarz	100308
<input checked="" type="checkbox"/>	SIGNAL GENERATOR (10 MHz ~ 40 GHz)	MG3694B	2014-10-15	Anritsu Corp	062513
<input checked="" type="checkbox"/>	POWER METER (DC ~ 67 GHz)	NRP2	2014-10-15	Rohde & Schwarz	100973
<input checked="" type="checkbox"/>	POWER SENSOR (50 MHz ~ 40 GHz)	NRP-Z85	2014-10-15	Rohde & Schwarz	101121
<input checked="" type="checkbox"/>	POWER SENSOR (9 KHz ~ 6 GHz)	NRP-Z92	2014-10-15	Rohde & Schwarz	100093
<input checked="" type="checkbox"/>	EMI TEST RECEIVER (20 MHz ~ 1000 MHz)	ESVS30	2014-10-15	Rohde & Schwarz	828525/005
<input checked="" type="checkbox"/>	EMI TEST RECEIVER (9 KHz ~ 2700 MHz)	ESCS30	2014-08-20	Rohde & Schwarz	845553/026
<input checked="" type="checkbox"/>	2-LINE V-NETWORK	ENV216	2015-05-06	Rohde & Schwarz	101456
<input checked="" type="checkbox"/>	2-LINE V-NETWORK	ENV216	2015-05-06	Rohde & Schwarz	101457
<input checked="" type="checkbox"/>	BILOG ANTENNA (30 MHz ~ 1000 MHz)	VULB 9168	2015-02-17	Schwarzbeck	9168-505
<input type="checkbox"/>	BILOG ANTENNA (30 MHz ~ 1000 MHz)	VULB 9168	2014-10-23	Schwarzbeck	9168-506
<input checked="" type="checkbox"/>	HORN ANTENNA (1 GHz ~ 18 GHz)	BBHA 9120D	2014-12-12	Schwarzbeck	568
<input type="checkbox"/>	HORN ANTENNA (1 GHz ~ 18 GHz)	3117	2014-10-24	ETS-Lindgren	00135889
<input type="checkbox"/>	HORN ANTENNA (18 GHz ~ 40 GHz)	BBHA 9170	2014-10-03	Schwarzbeck	9170-499
<input type="checkbox"/>	HORN ANTENNA (18 GHz ~ 40 GHz)	BBHA 9170	2014-10-03	Schwarzbeck	9170-500
<input checked="" type="checkbox"/>	Microwave Amplifier (1 GHz ~ 18 GHz)	TK-PA18	2014-09-05	TESTEK	1200020
<input type="checkbox"/>	Low Noise Amplifier (18 GHz ~ 40 GHz)	AMF-6F-18004000-37-8P	2015-05-06	MITEQ	1814914
<input checked="" type="checkbox"/>	High Pass Filter (3 GHz ~ 10 GHz)	WHJS3000-10EF	2014-12-02	WAINWRIGHT	2

→ All equipment is calibrated with traceable calibrations.

2.3 Test Date

Date of Application: 2014- 04 - 18

Date of Test: 2014- 04 - 22 ~ 2014 - 05 - 29

3. Description of the Equipment Under Test

3.1 Manufacturers declarations

Manufacturer :	Franklin Technology Inc.
Product Description :	LTE/WIFI MOBILE ROUTER inside the Atheros AR6003 is single chip, small form factor IEEE 802.11b/g/n MAC/baseband/radio optimized for low-power mobile applications. It is the 3rd generation WLAN design in the ROCm family, employing the world's lowest power consumption WLAN architecture in the smallest possible form factor. The AR6003 is single stream 1x1 802.11n implementation providing improved link robustness, extended range, increased throughput and better performance for an unparalleled user experience. The AR6003 is part of Align product family.
FCC ID :	XHG-R774
Model Name :	R774
Multiple Model Name :	None
Operating Frequency :	2 412 MHz ~ 2 462 MHz (802.11b/g/n)
Occupied Bandwidth :	≤ 20 MHz (at 99%)
Operation Channel :	11
Max. RF Output Power	2.4 GHz Band <ul style="list-style-type: none"> • 802.11b : 18.52 dBm • 802.11g : 22.25 dBm • 802.11n(HT20) : 20.92 dBm
Modulation Type :	<ul style="list-style-type: none"> • 802.11b : DSSS/CCK • 802.11g/n : OFDM/16QAM,64QAM
EUT Power Source :	Primary power – 3.7 Vdc Battery
	Secondary Power – Via AC Mains Powered DC 5V adapter
Test Item :	Prototype
Type of Equipment :	Mobile
Antennas :	PIFA Antenna (1TX/1RX) Antenna max peak gain : 1.3 dBi (TX/RX)
Antenna Connector :	DIP Connection(INTENNA)

→ All the testing were performed according to the procedures in FCC Parts 15.247
 The EUT was operation in special test mode.

3.2 Information about EUT

- ▶ All-CMOS IEEE 802.11b/g/n single-chip client.
- ▶ Single stream 802.11n provides highest throughput and superior RF performance for handhelds.
- ▶ Integrated high-output Atheros Efficient Power Amplifier and LNA for lowest BOM.
- ▶ Supports popular interfaces used in embedded designs.
- ▶ Lowest power consumption in the industry with near zero in idle/standby modes, extending battery life.
- ▶ Integrated on-chip processor to minimize the loading on host processor.
- ▶ Supports 2/3/4-wire enhanced PTA scheme for use with any BT solution for optimal coexistence implementation.
- ▶ Supports several reference clock from 19.2MHz to 52MHz..



4. List of Measurements

Guide Lines	FCC Rules Part 15	Result
Occupied Bandwidth (6dB)	15.247(a)	PASS
Transmitter Output Power	15.247(b)	PASS
Out of Band Emissions / Band Edge	15.247(d)	PASS
Transmitter Power Spectral Density	15.247(e)	PASS
General Field Strength Limits (Restricted Bands and Radiated Emission Limits)	15.205 /15.209	PASS
AC Power Line Conducted Emissions	15.207	PASS
Antenna Requirement	15.203	PASS

5. Transmitter Conducted & Radiated emissions setup

5.1 Test setup for 9 KHz ~ 30 MHz

The diagram below shows the test setup that is utilized to make the measurements for emission from 9 KHz to 30 MHz Conducted emissions

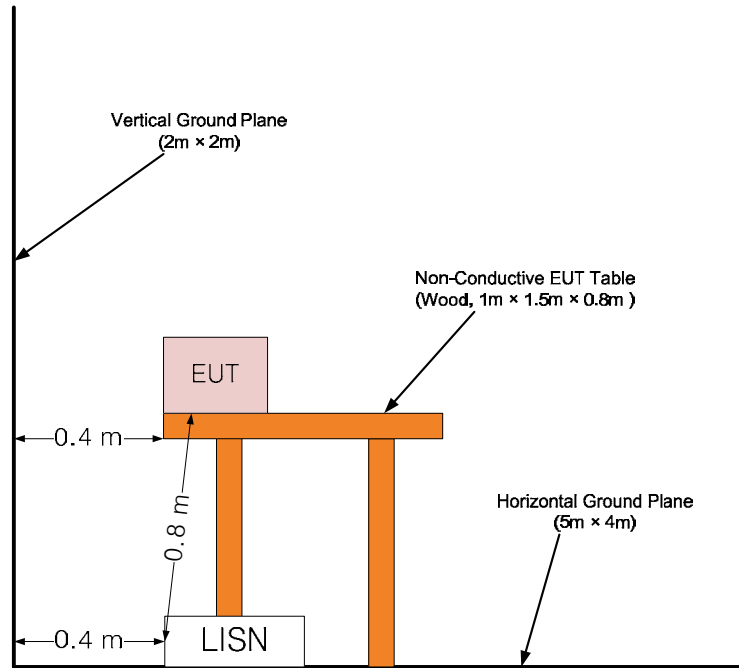

5.2 Test setup for 30 MHz ~ 1 GHz

The diagram below shows the test setup that is utilized to make the measurements for emission from 30 MHz to 1 GHz emissions

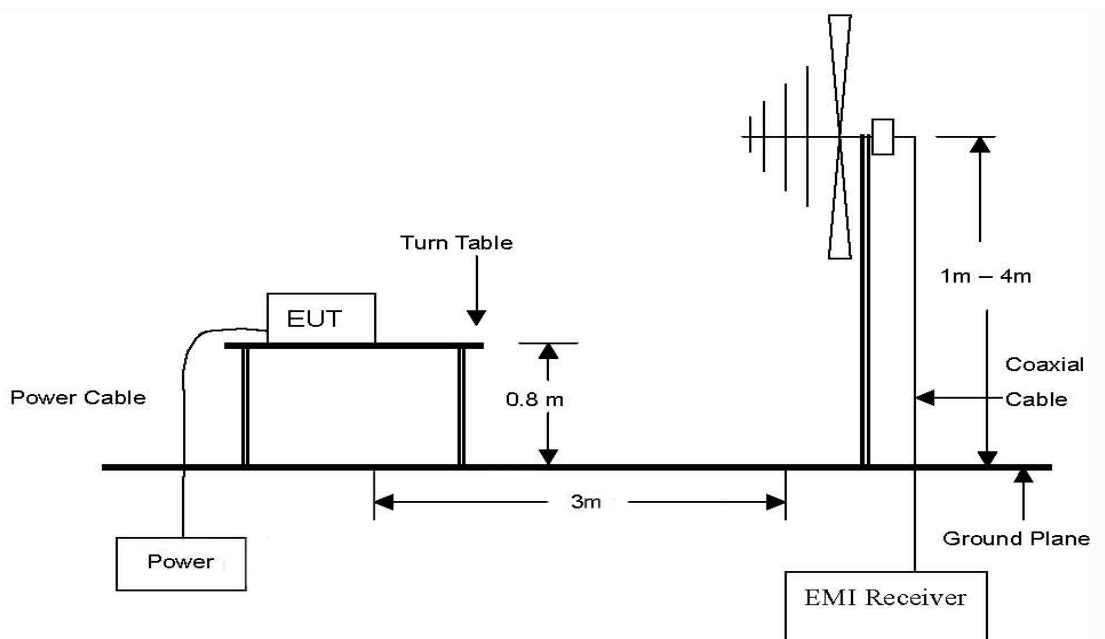

5.3 Test setup for 1 GHz ~ 26.5 GHz

The diagram below shows the test setup that is utilized to make the measurements for emission from 1 GHz to 26.5 GHz emissions. As required by subpart 15.33 emissions were measured to 24.7 GHz.(10th carrier frequency)

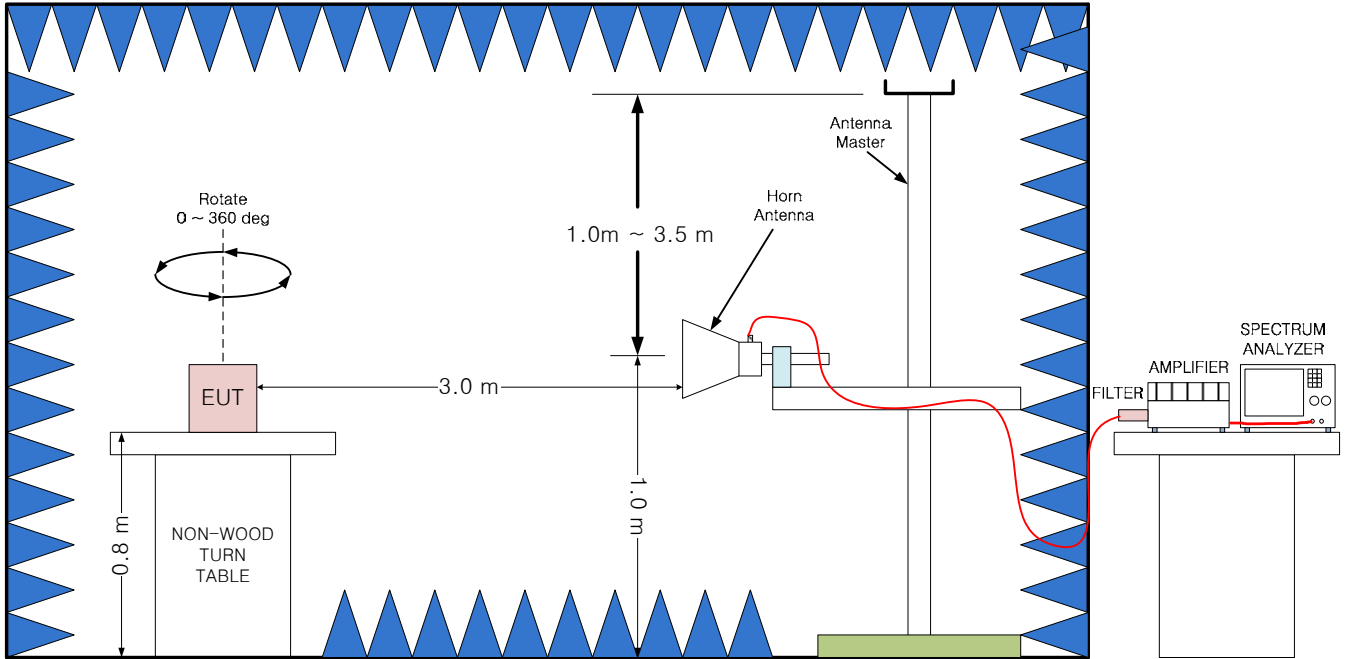

5.4 Measurement methods

Generally the tests were performed according to the KDB 558074 v03r1. And ANSI C63.10-2009 was used to reference appropriate EUT setup and maximizing procedures of radiated spurious emission and AC line conducted emission testing.

5.5 Worst-case Configuration and mode

Radiated emission and power line conducted emission were performed with the EUT set to transmit at the channel with highest output power as worst-case scenario.

The fundamental of the EUT was investigated in three orthogonal orientations XY, YZ, ZX, it was determined that XY orientation was worst-case orientation; therefore, all final radiated testing was performed with the EUT in XY orientation.

Based on the baseline scan, the worst-case data rates were:

- 802.11b mode: 1 Mbps (TX Rate : 0, TX POWER : 15 dBm)
- 802.11g mode: 36 Mbps (TX Rate : 9, TX POWER : 13 dBm)
- 802.11n HT20mode: MCS6(TX Rate : 18, TX POWER : 11 dBm)

6. Occupied Bandwidth (6 dB)

6.1 Definition

Systems using digital modulation techniques may operate in the 902-928 MHz, 2400-2483.5 MHz, and 5725-5850 MHz bands. The minimum 6 dB bandwidth shall be at least 500 kHz.

6.2 Test Procedure

Reference to KDB 558074 D01 DTS Meas Guidance v03r01: The transmitter output is connected to a spectrum analyzer with the RBW set to 100 KHz, the VBW $\geq 3 \times$ RBW, peak detector and max hold.

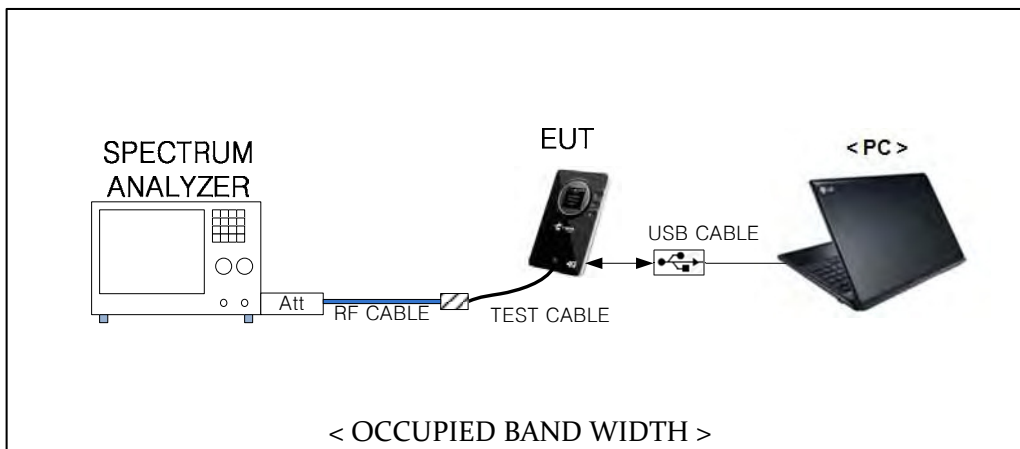

* RF Cable : Radiall / 1800920921500PJ / DC-40 GHz / 1.5m

* Attenuator : 10 dB (Weinshel /56-10/ DC-28 GHz) + 6 dB(Weinshel / 56-6 / DC-28 GHz)

* TEST Cable : Connected WIFI Antenna port (5 cm / SMA connector)

* Path Loss Information

Frequency(MHz)	RF Cable (dB)	10 dB ATT (dB)	6 dB ATT (dB)	Test Cable (dB)	Total Loss (dB)
2 412 ~ 2 462	0.99	9.63	5.64	0.30	16.56

6.3 Test Criteria

The minimum 6 dB bandwidth shall be at least 500 kHz..

6.4 Test Result

Unit : MHz

Modulation	RATE	Low Channel [1]	Mid Channel [6]	High Channel [11]
		Frequency(MHz) 2412	Frequency(MHz) 2437	Frequency(MHz) 2462
802.11 b	1 Mbps	10.078	10.026	9.556
802.11 g	36 Mbps	16.350	16.132	16.130
802.11 n	MCS6	17.624	17.426	16.993

6.5 Test Plots

Plot #1 { 802.11b / 1 Mbps / 2 412 MHz }

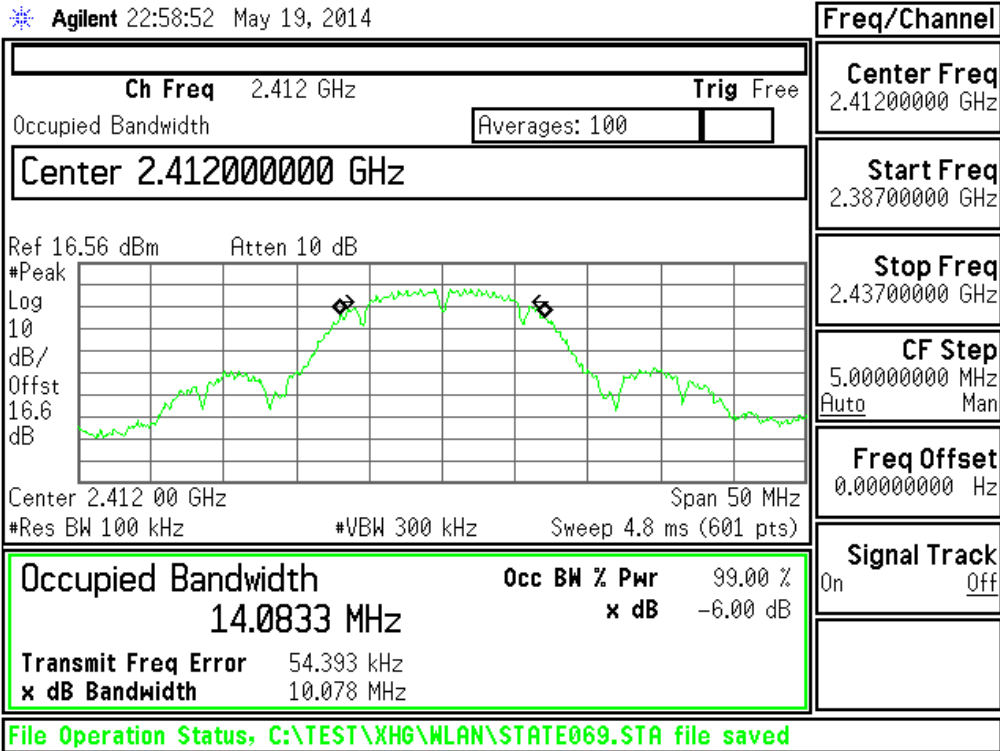

Freq/Channel	
Center Freq	2.41200000 GHz
Start Freq	2.38700000 GHz
Stop Freq	2.43700000 GHz
CF Step	5.00000000 MHz
Auto	Man
Freq Offset	0.00000000 Hz
Signal Track	On <u>Off</u>

Plot #2 { 802.11b / 1 Mbps / 2 437 MHz }

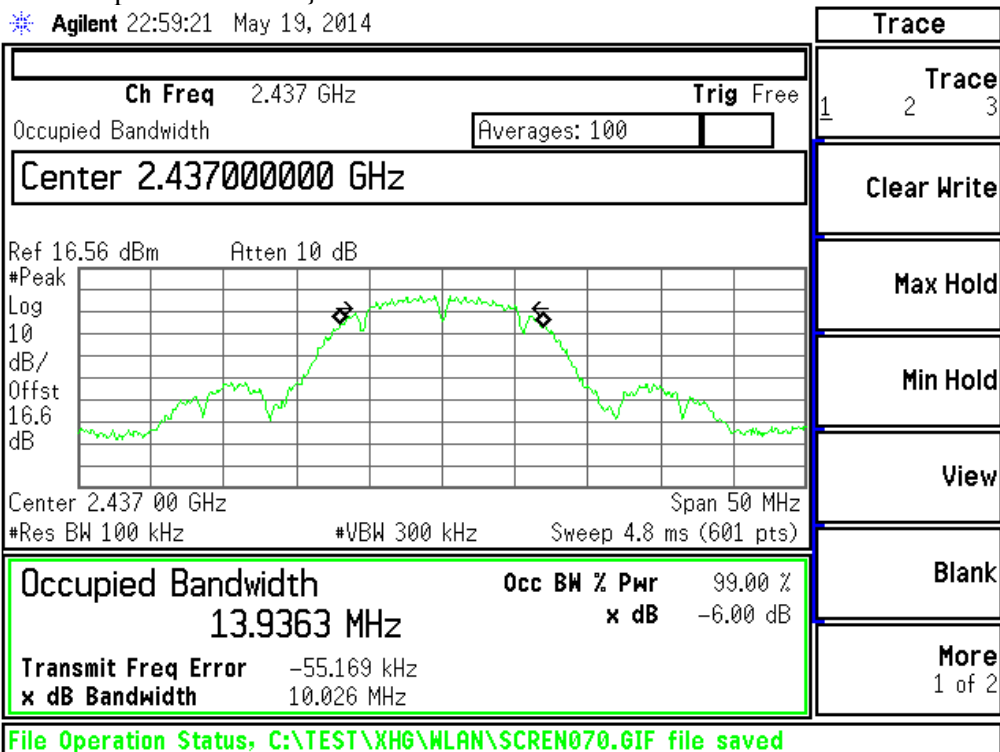

Trace		
1	2	3
Trace		
Clear Write		
Max Hold		
Min Hold		
View		
Blank		
More		
1 of 2		

Plot #3 {802.11b / 1 Mbps / 2 462 MHz }

Agilent 22:59:47 May 19, 2014

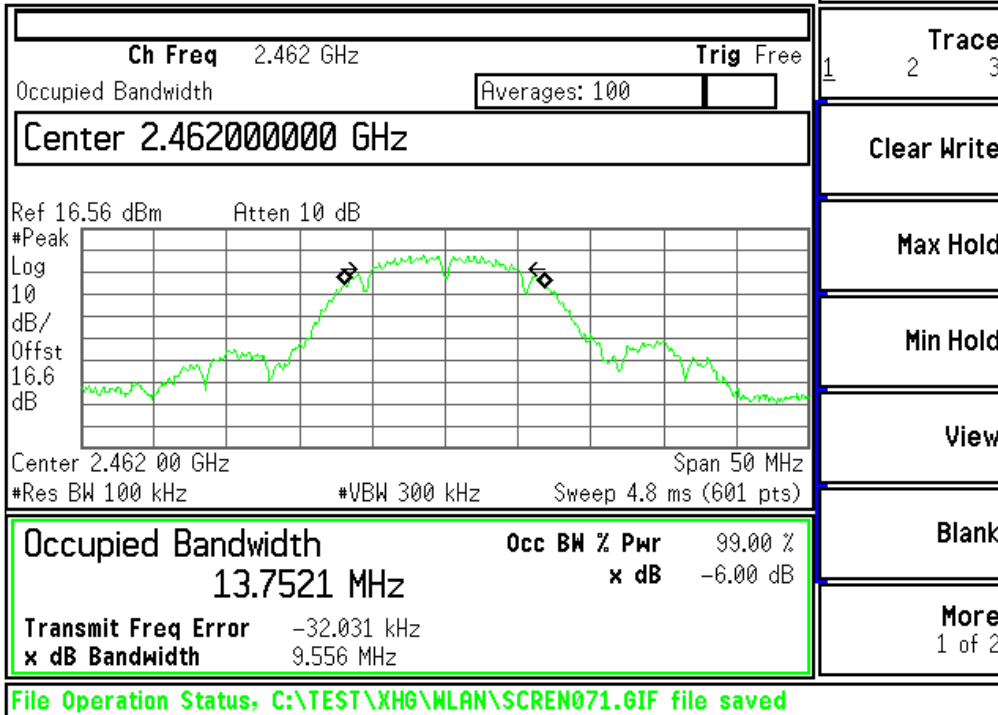

Trace		
1	Trace	3
2		
3		
Clear Write		
Max Hold		
Min Hold		
View		
Blank		
More 1 of 2		

Plot #4 {802.11g / 36 Mbps / 2 412 MHz }

Agilent 23:01:09 May 19, 2014

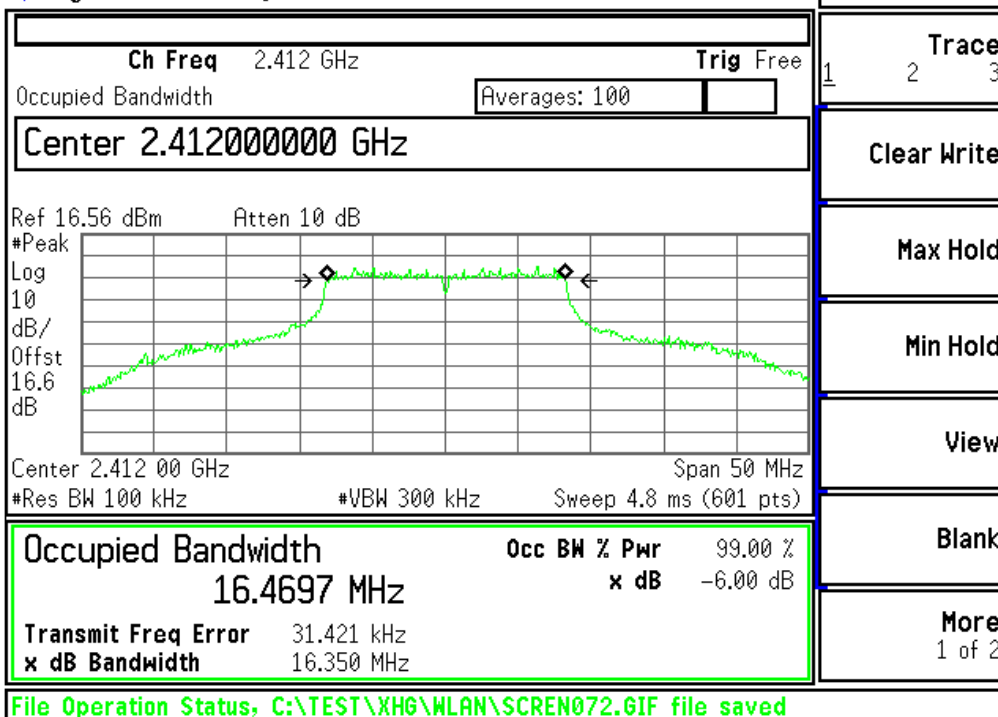

Trace		
1	Trace	3
2		
3		
Clear Write		
Max Hold		
Min Hold		
View		
Blank		
More 1 of 2		

Plot #5 { 802.11g / 36 Mbps / 2 437 MHz }

Agilent 23:01:32 May 19, 2014

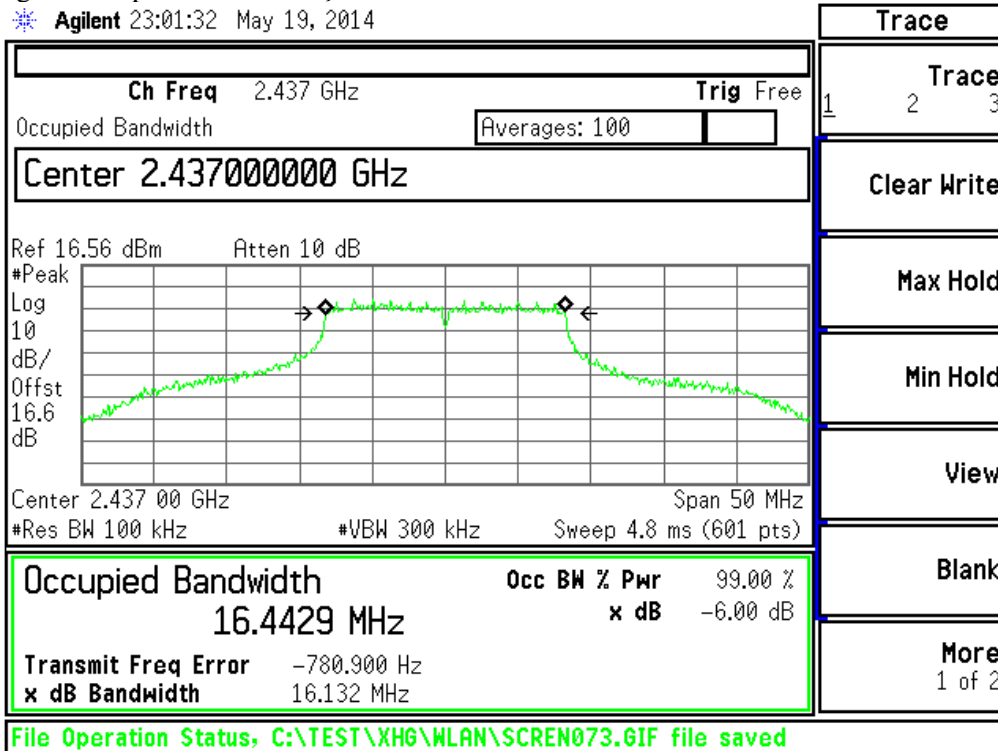

Trace		
1	Trace	3
2		
3		
Clear Write		
Max Hold		
Min Hold		
View		
Blank		
More 1 of 2		

Plot #6 { 802.11g / 36 Mbps / 2 462 MHz }

Agilent 23:01:57 May 19, 2014

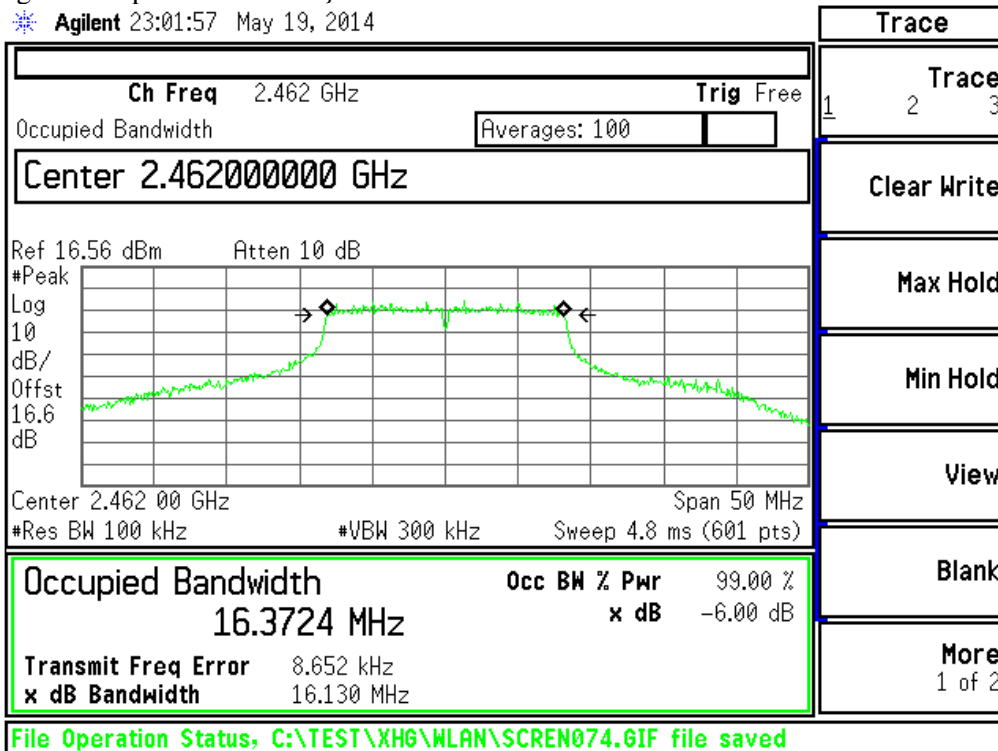

Trace		
1	Trace	3
2		
3		
Clear Write		
Max Hold		
Min Hold		
View		
Blank		
More 1 of 2		

Plot #7 { 802.11n / MCS6 / 2 412 MHz }

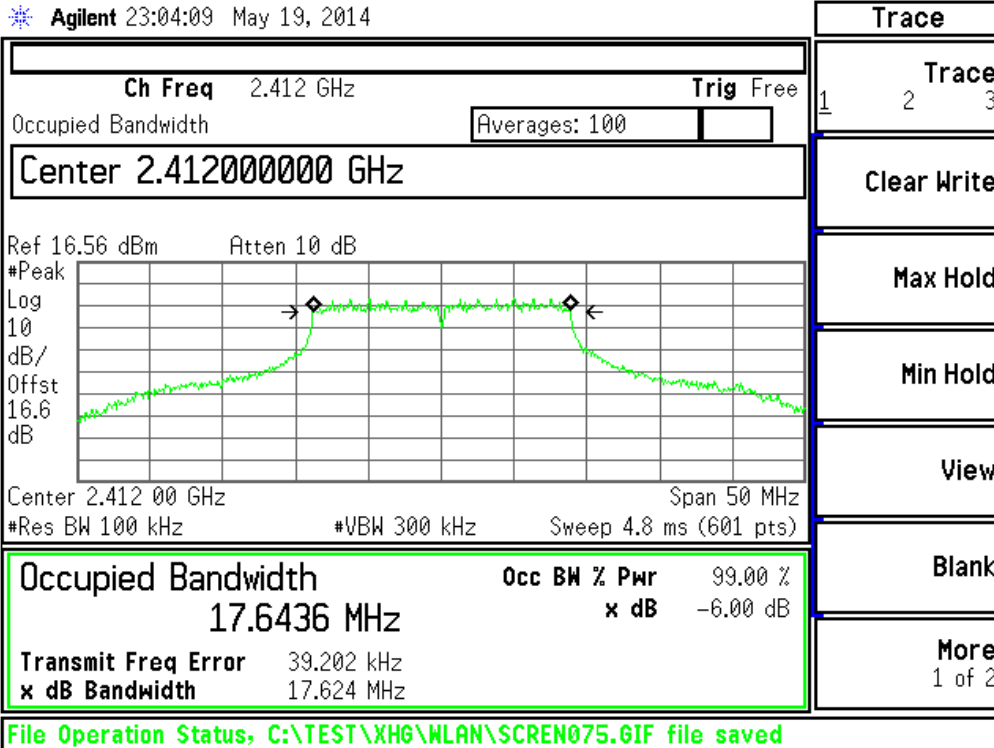

Trace		
1	Trace	3
2		
3		
Clear Write		
Max Hold		
Min Hold		
View		
Blank		
More 1 of 2		

Plot #8 { 802.11n / MCS6 / 2 437 MHz }

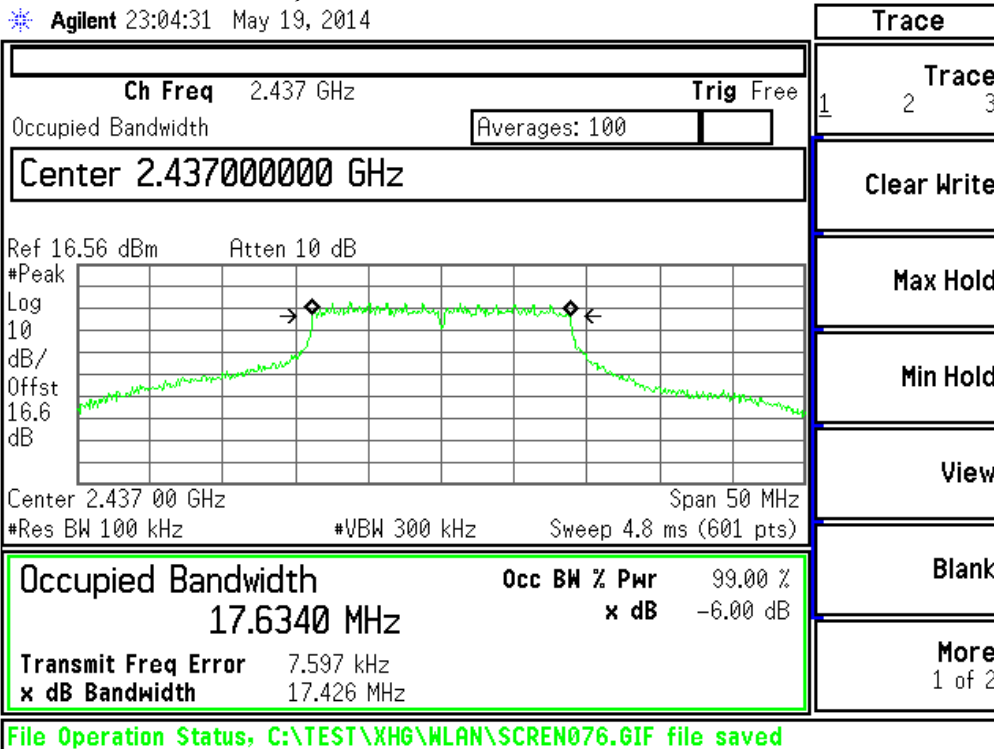

Trace		
1	Trace	3
2		
3		
Clear Write		
Max Hold		
Min Hold		
View		
Blank		
More 1 of 2		

Plot #9 { 802.11n / MCS6 / 2 462 MHz }

Agilent 23:05:03 May 19, 2014

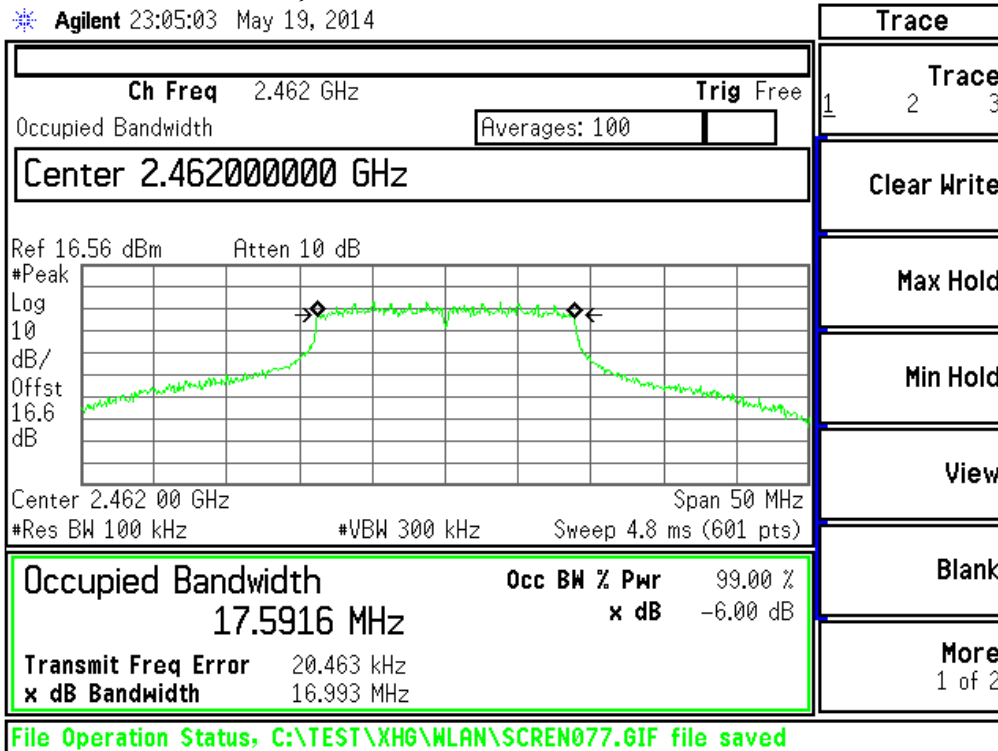

7. Transmitter Output Power

7.1 Definition

For systems using digital modulation in the 902-928 MHz, 2400-2483.5 MHz, and 5725-5850 MHz bands: 1 Watt. As an alternative to a peak power measurement, compliance with the one Watt limit can be based on a measurement of the maximum conducted output power. Maximum Conducted Output Power is defined as the total transmit power delivered to all antennas and antenna elements averaged across all symbols in the signaling alphabet when the transmitter is operating at its maximum power control level. Power must be summed across all antennas and antenna elements. The average must not include any time intervals during which the transmitter is off or is transmitting at a reduced power level. If multiple modes of operation are possible (e.g., alternative modulation methods), the maximum conducted output power is the highest total transmit power occurring in any mode.

7.2 Test Procedure

(1) PKPM1 Peak power meter method of KDB 558074 v03r1

The maximum peak conducted output powers were measured using a broadband peak RF power meter which has greater video bandwidth than EUT's DTS bandwidth and utilize a fast-responding diode detector

(2) Method AVGPM-G (Measurement using a gated RF average power meter) of KDB 558074 v03r1

The average conducted output powers were measured using a wideband gated RF power meter provided that the gate parameters are adjusted such that the power is measured only when the EUT is transmitting at its maximum power control level. Since this measurement is made only during the ON time of the transmitter, no duty cycle correction is required.

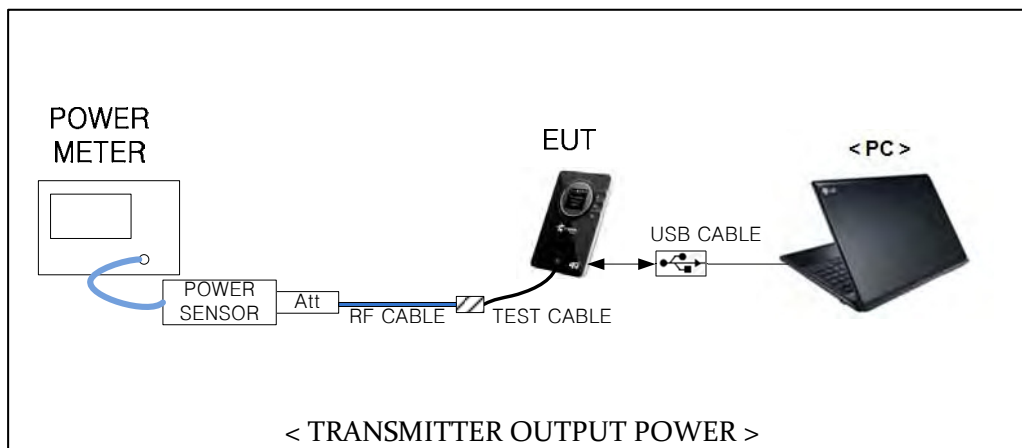

* RF Cable : Radiall / 1800920921500PJ / DC-40 GHz / 1.5m

* Attenuator : 10 dB (Weinshel /56-10/ DC-28 GHz) + 6 dB(Weinshel / 56-6 / DC-28 GHz)

* TEST Cable : Connect WIFI Antenna port (5 cm / SMA connector)

* Path Loss Information

Frequency(MHz)	RF Cable (dB)	10 dB ATT (dB)	6 dB ATT (dB)	Test Cable (dB)	Total Loss (dB)
2 412 ~ 2 462	0.99	9.63	5.64	0.30	16.56

7.3 Test Criteria

The maximum permissible conducted output power is 1 Watt.(30 dBm)

7.4 Test Result

7.4.1 mode : 802.11b

Unit : dBm

Modulation	RATE	Detector	Low Channel [1]	Mid Channel [6]	High Channel [11]
			Frequency(MHz) 2412	Frequency(MHz) 2437	Frequency(MHz) 2462
802.11 b	1 Mbps	PEAK	18.52	17.13	17.46
		AVERAGE	15.30	14.46	14.94
	2 Mbps	PEAK	18.49	17.11	17.37
		AVERAGE	15.35	14.46	14.89
	5.5 Mbps	PEAK	18.49	17.17	17.47
		AVERAGE	15.47	14.56	15.04
	11 Mbps	PEAK	18.49	16.90	17.22
		AVERAGE	15.28	14.21	14.70

* Average power is corrected Duty cycle (%)

Mode	RATE	T total (ms)	Ton (ms)	Duty cycle	Duty cycle (%)	Duty Factor(dB)
802.11 b	1 Mbps	12.442	12.416	0.99791	99.79 %	0.009
	2 Mbps	6.330	6.304	0.99589	99.59 %	0.018
	5.5 Mbps	2.441	2.415	0.98935	98.93 %	0.047
	11 Mbps	1.329	1.303	0.98044	98.04 %	0.086

* Duty Cycle = T on / T total

 * Duty Cycle Factor = $10 \cdot \log(1/\text{Duty Cycle})$

* EUT Power level is 15 dBm at 802.11b test mode

7.4.2 mode : 802.11g

Unit : dBm

Modulation	RATE	Detector	Low Channel [1]	Mid Channel [6]	High Channel [11]
			Frequency(MHz) 2412	Frequency(MHz) 2437	Frequency(MHz) 2462
802.11 g	6 Mbps	PEAK	21.06	20.20	20.04
		AVERAGE	11.31	10.21	10.51
	9 Mbps	PEAK	20.79	20.32	20.10
		AVERAGE	11.31	10.24	10.45
	12 Mbps	PEAK	21.04	20.70	20.44
		AVERAGE	11.18	10.15	10.43
	18 Mbps	PEAK	20.48	19.83	19.90
		AVERAGE	11.32	10.22	10.50
	24 Mbps	PEAK	21.66	21.20	20.63
		AVERAGE	12.07	11.39	11.38
	36 Mbps	PEAK	22.25	21.75	21.47
		AVERAGE	12.23	11.48	11.49
	48 Mbps	PEAK	21.83	21.49	21.17
		AVERAGE	12.29	11.53	11.49
	54 Mbps	PEAK	22.11	21.87	21.79
		AVERAGE	12.25	11.53	11.52

* Average power is corrected Duty cycle (%)

Mode	RATE	T total (ms)	Ton (ms)	Duty cycle	Duty cycle (%)	Duty Factor(dB)
802.11 g	6 Mbps	2.096	2.064	0.98473	98.47 %	0.067
	9 Mbps	1.416	1.384	0.97740	97.74 %	0.099
	12 Mbps	1.076	1.044	0.97026	97.03 %	0.131
	18 Mbps	0.736	0.704	0.95652	95.65 %	0.193
	24 Mbps	0.564	0.531	0.94149	94.15 %	0.262
	36 Mbps	0.396	0.364	0.91919	91.92 %	0.366
	48 Mbps	0.308	0.276	0.89610	89.61 %	0.476
	54 Mbps	0.280	0.248	0.88571	88.57 %	0.527

* Duty Cycle = T on / T total

* Duty Cycle Factor = 10*log(1/Duty Cycle)

* EUT Power level is 13 dBm at 802.11g test mode

7.4.3 mode : 802.11n

Unit : dBm

Modulation	RATE	Detector	Low Channel [1]	Mid Channel [6]	High Channel [11]
			Frequency(MHz) 2412	Frequency(MHz) 2437	Frequency(MHz) 2462
802.11 n	MCS0	PEAK	17.95	18.28	17.83
		AVERAGE	8.24	8.50	7.08
	MCS1	PEAK	18.89	18.65	18.34
		AVERAGE	8.52	8.42	7.55
	MCS2	PEAK	18.69	18.27	17.86
		AVERAGE	8.65	8.52	7.62
	MCS3	PEAK	19.82	19.60	19.62
		AVERAGE	10.75	10.18	10.40
	MCS4	PEAK	20.40	20.21	19.98
		AVERAGE	10.77	10.16	10.43
	MCS5	PEAK	20.80	20.45	20.28
		AVERAGE	10.84	10.23	10.41
	MCS6	PEAK	20.92	20.90	20.81
		AVERAGE	10.85	10.26	10.47
MCS7	PEAK	20.35	19.95	19.97	
	AVERAGE	10.86	10.25	10.44	

* Average power is corrected Duty cycle (%)

Mode	RATE	T total (ms)	Ton (ms)	Duty cycle	Duty cycle (%)	Duty Factor(dB)
802.11 n	6.5 Mbps	1.925	1.92	0.99740	99.74 %	0.011
	13 Mbps	1.012	0.98	0.96838	96.84 %	0.140
	19.5 Mbps	0.696	0.665	0.95546	95.55 %	0.198
	26 Mbps	0.540	0.508	0.94074	94.07 %	0.265
	39 Mbps	0.384	0.352	0.91667	91.67 %	0.378
	52 Mbps	0.304	0.272	0.89474	89.47 %	0.483
	58.5 Mbps	0.280	0.248	0.88571	88.57 %	0.527
	65 Mbps	0.260	0.228	0.87692	87.69 %	0.570

* Duty Cycle = T on / T total

* Duty Cycle Factor = 10*log(1/Duty Cycle)

* EUT Power level is 11 dBm at 802.11n test mode

7.5 Test Plots

Plot #1 { 802.11b / 1 Mbps / 2 412 MHz }

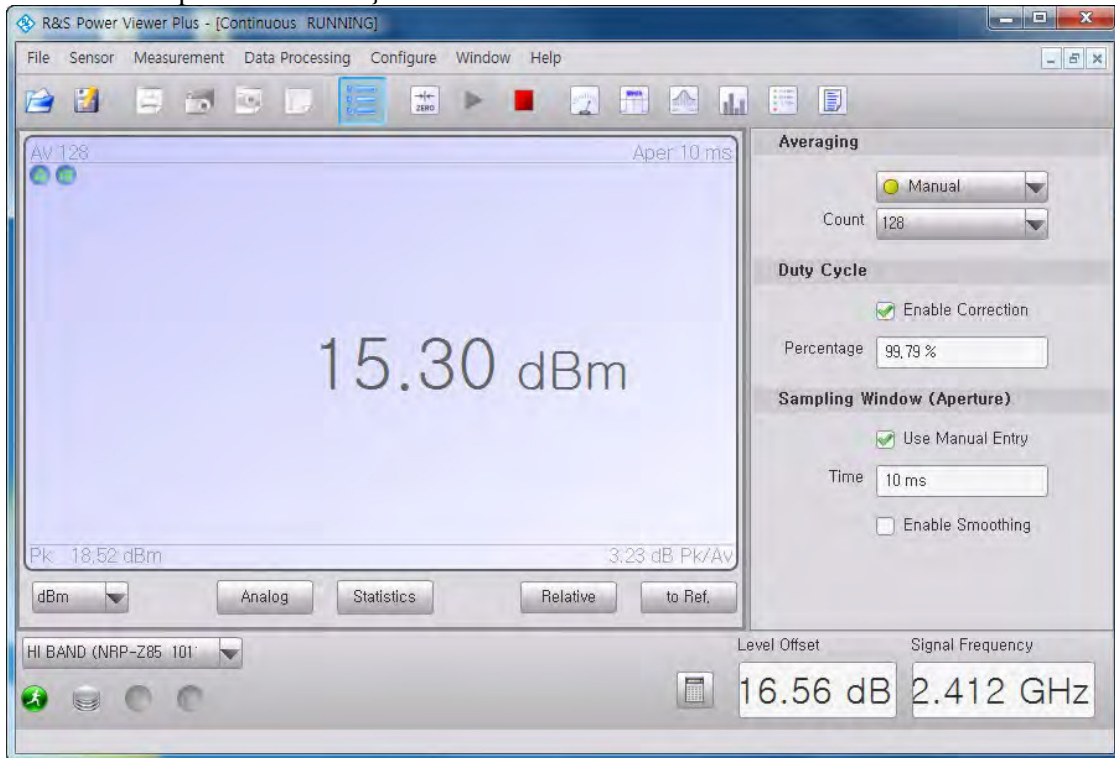

Plot #2 { 802.11b / 1 Mbps / 2 437 MHz }

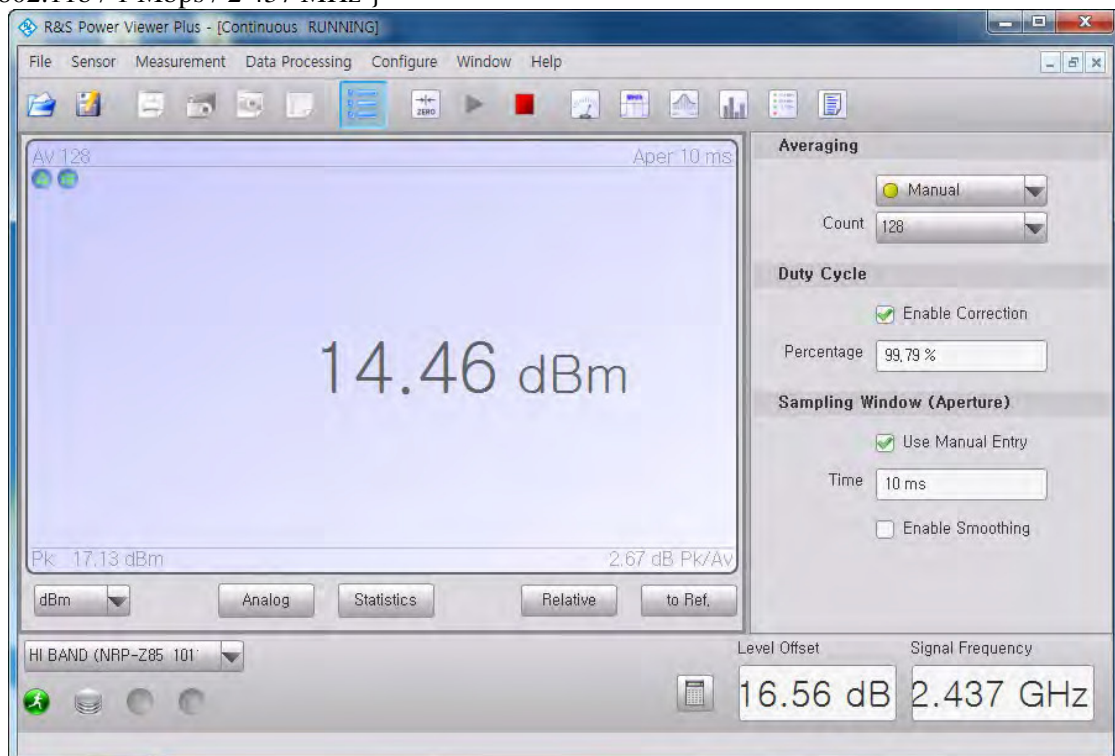

Plot #3 { 802.11b / 1 Mbps / 2.462 MHz }

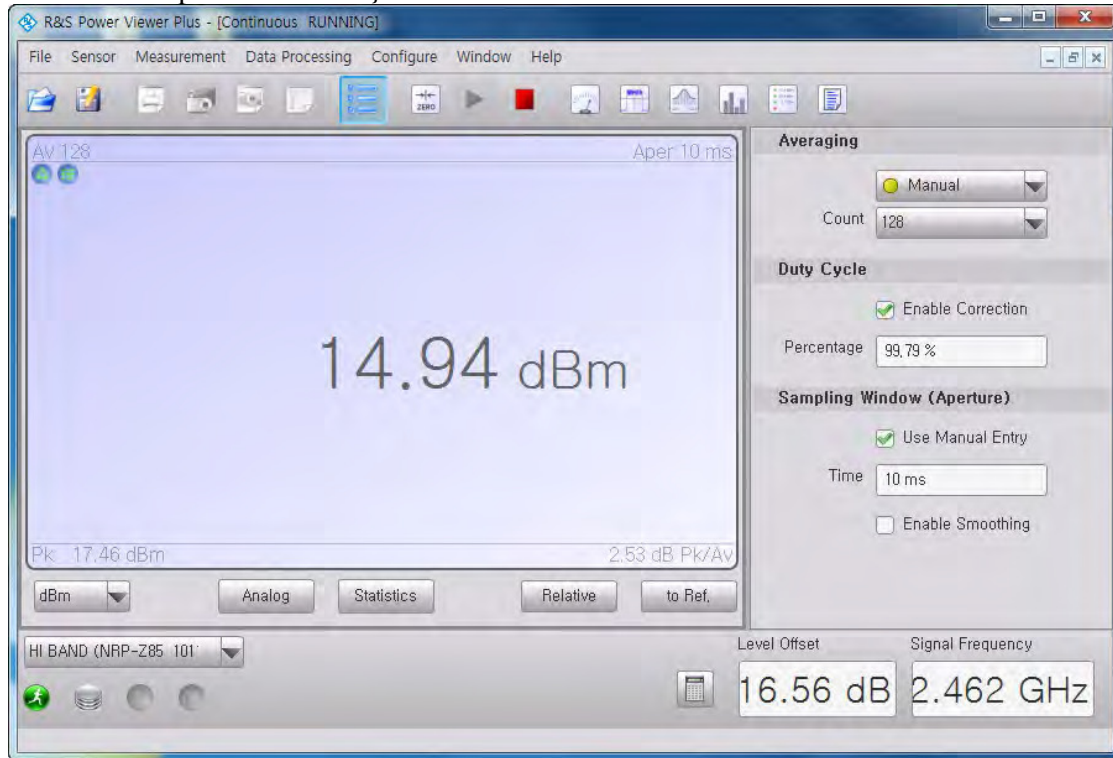

Plot #4 { 802.11b / 2 Mbps / 2.412 MHz }

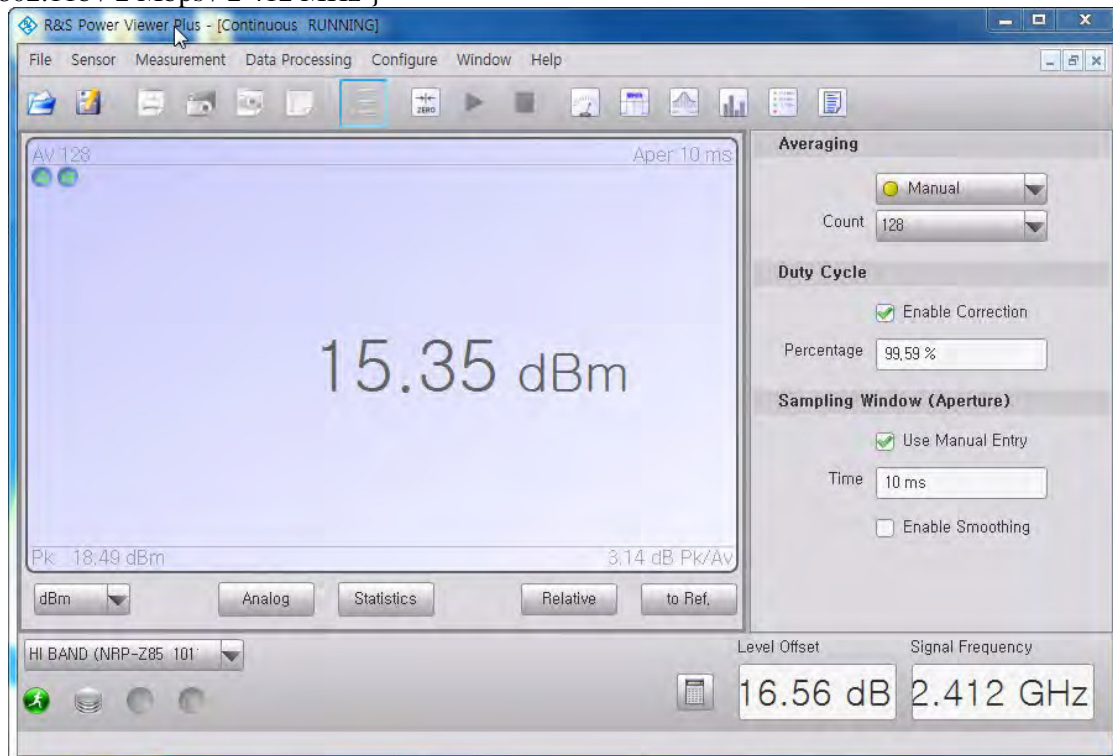

Plot #5 { 802.11b / 2 Mbps / 2 437 MHz }

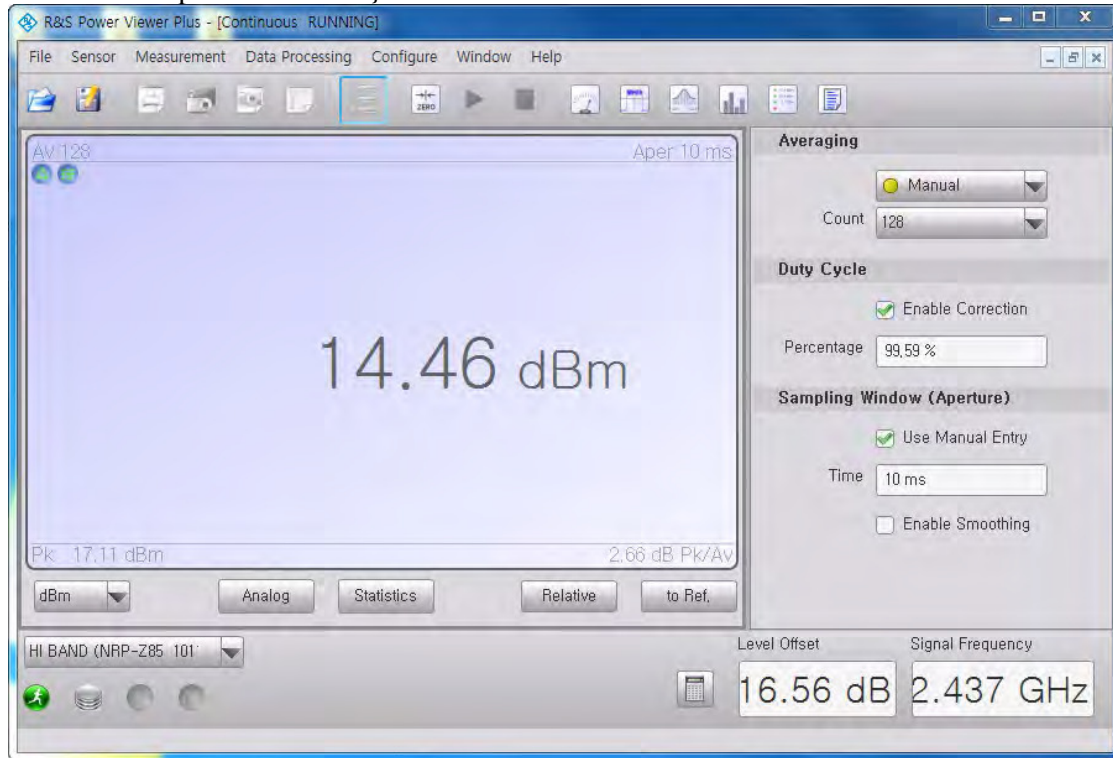

Plot #6 { 802.11b / 2 Mbps / 2 462MHz }

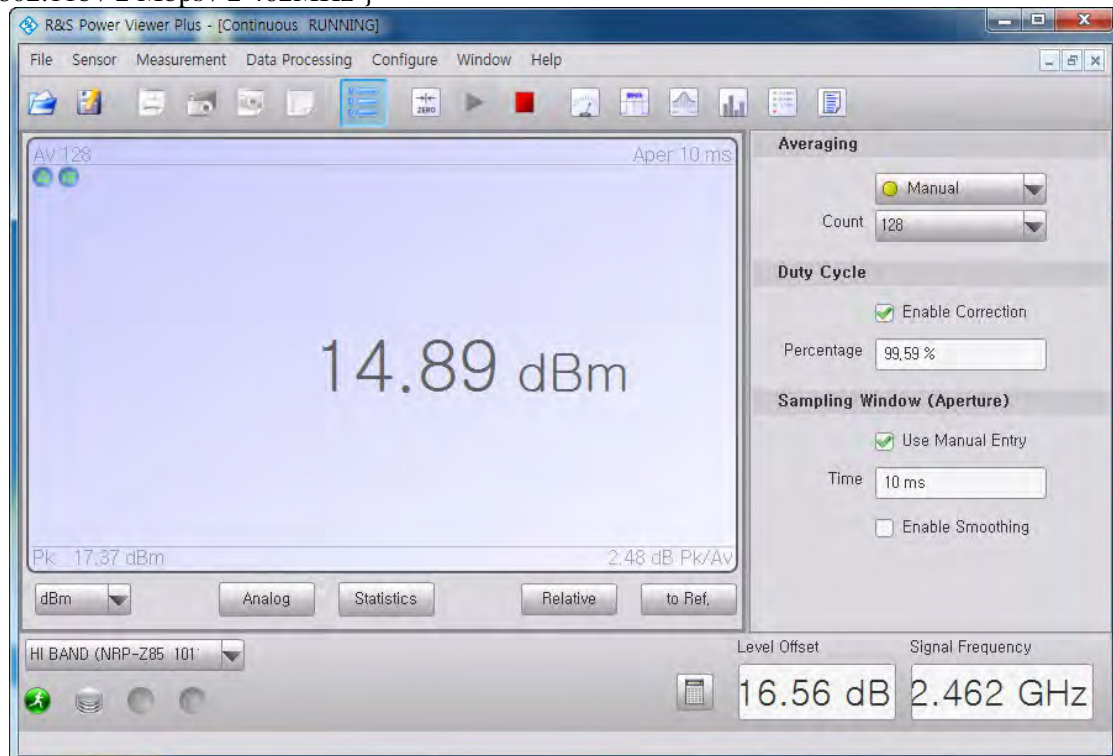

Plot #7{802.11b / 5.5Mbps / 2 412 MHz }

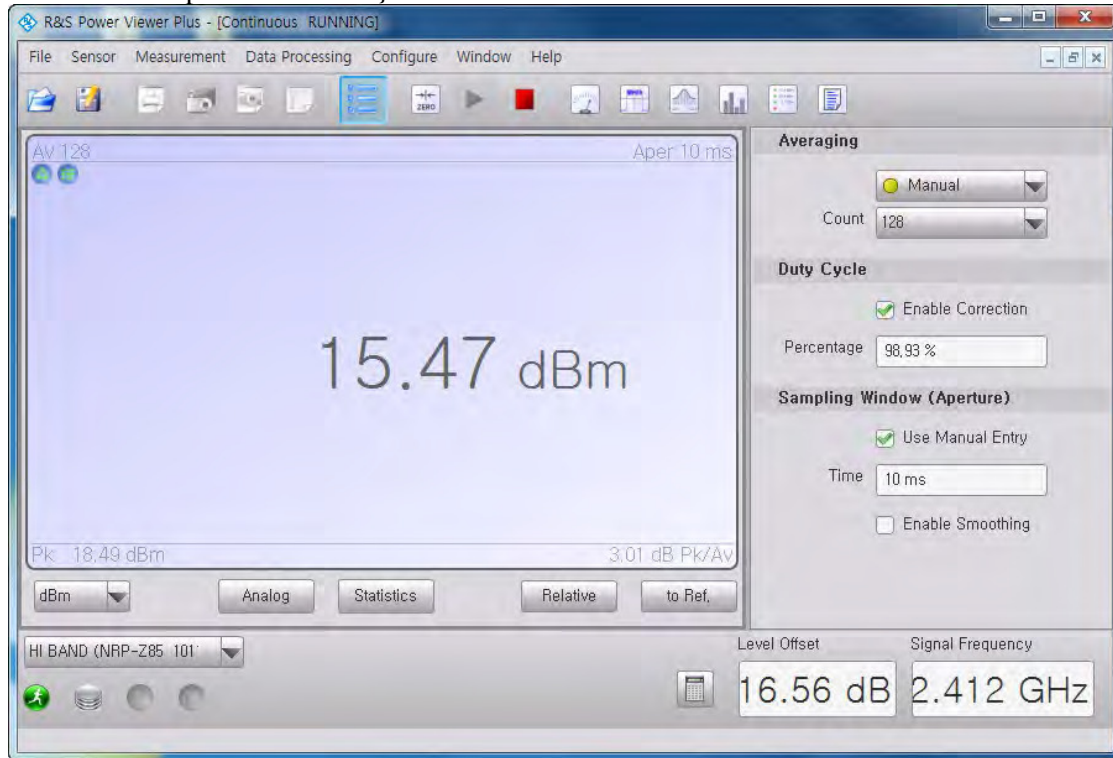

Plot #8{802.11b / 5.5Mbps / 2 437 MHz }

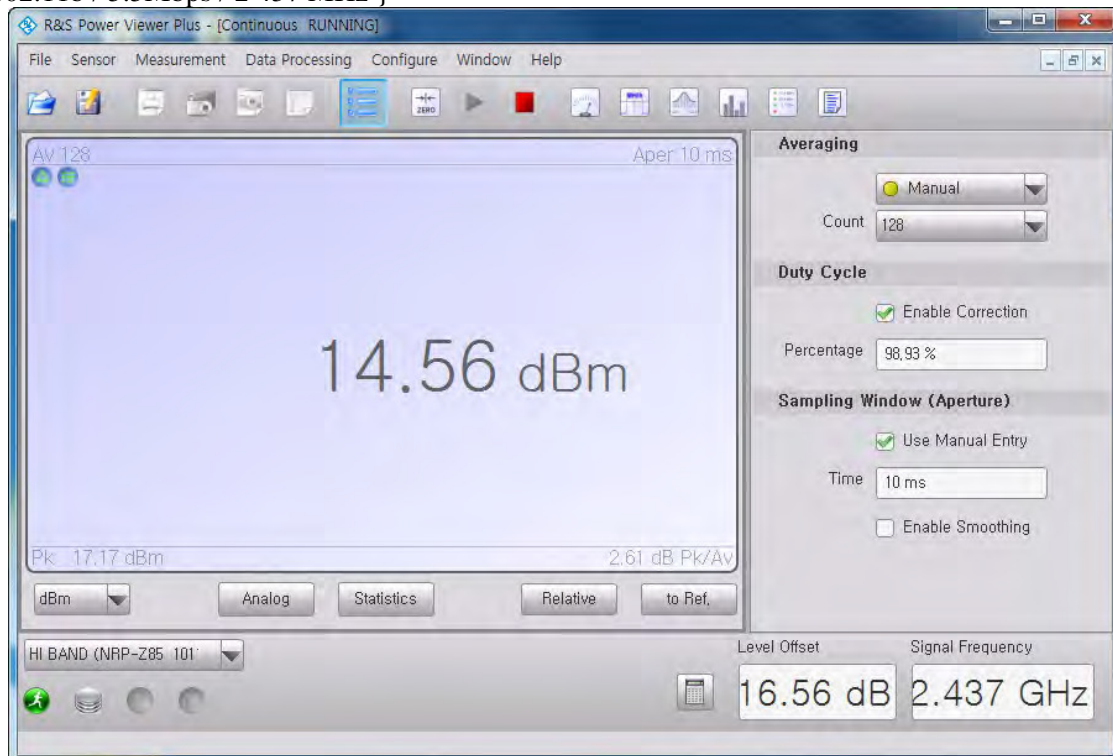

Plot #9{802.11b / 5.5Mbps / 2.462 MHz }

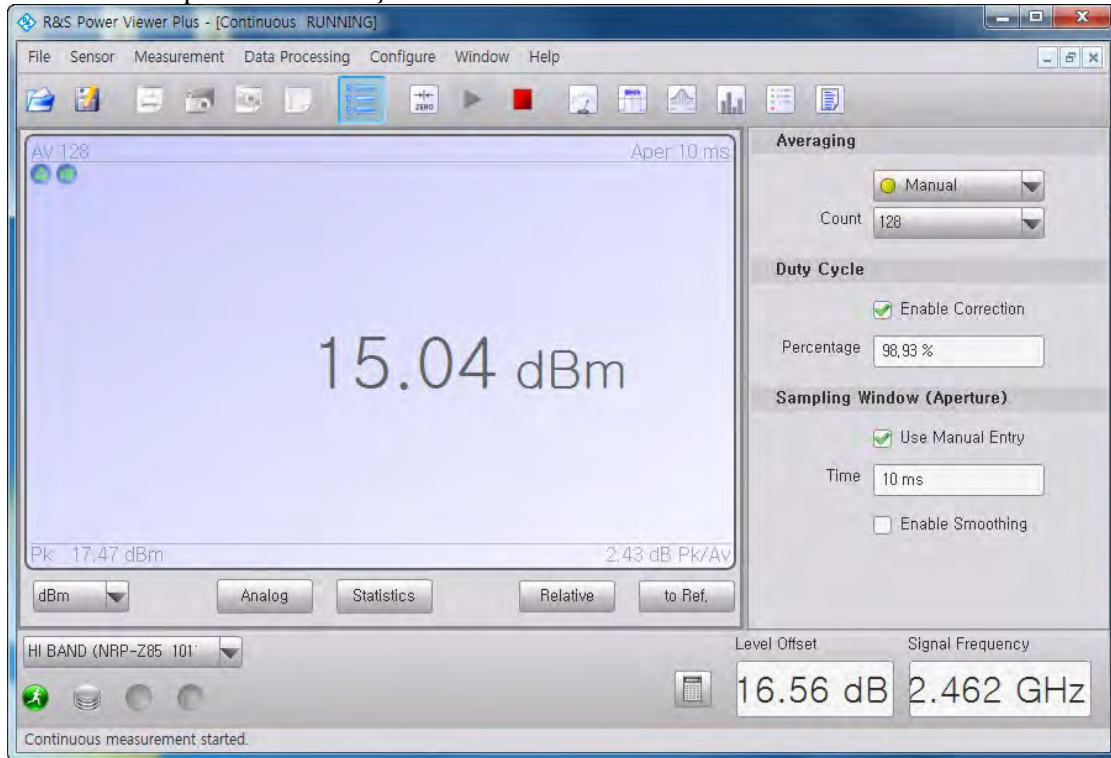

Plot #10{802.11b / 11Mbps / 2.412 MHz }

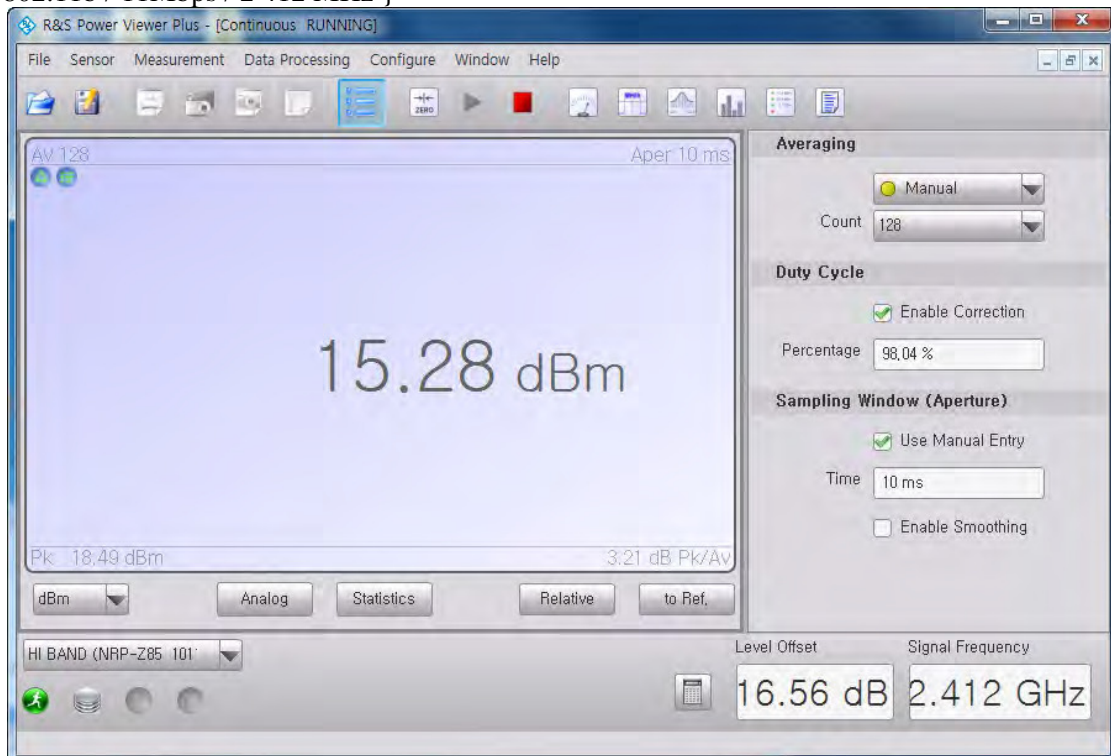

Plot #11{802.11b / 11Mbps / 2 437 MHz }

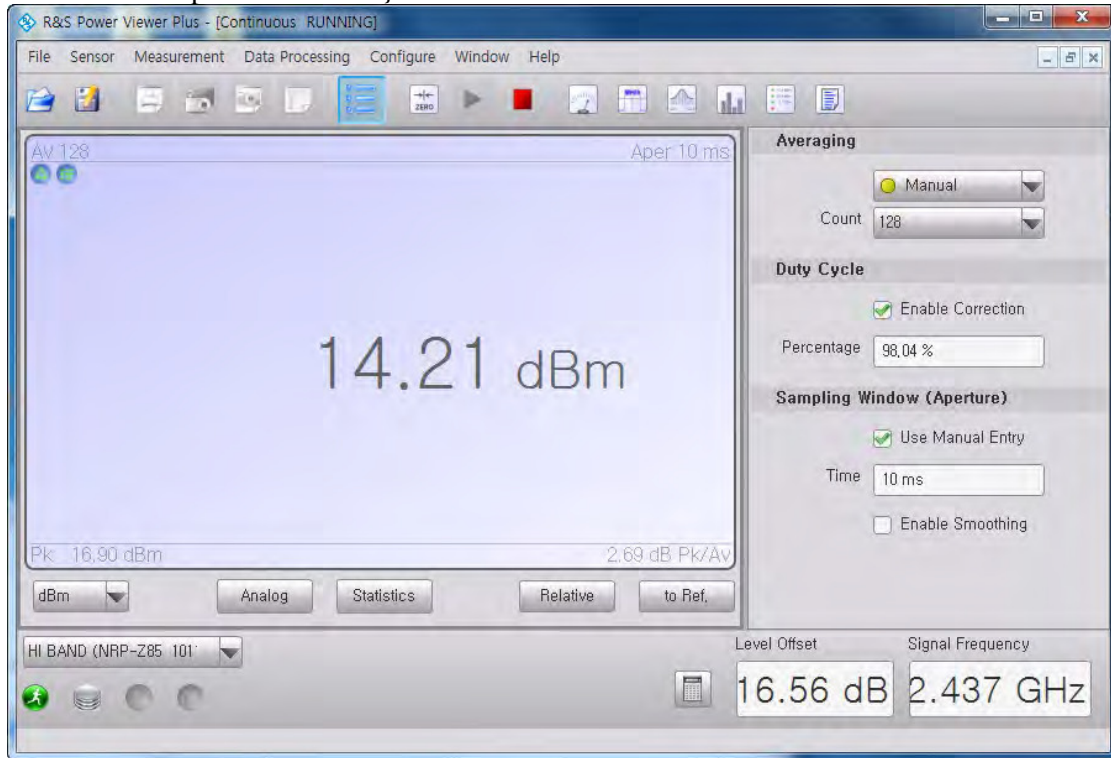

Plot #12{802.11b / 11Mbps / 2 462 MHz }

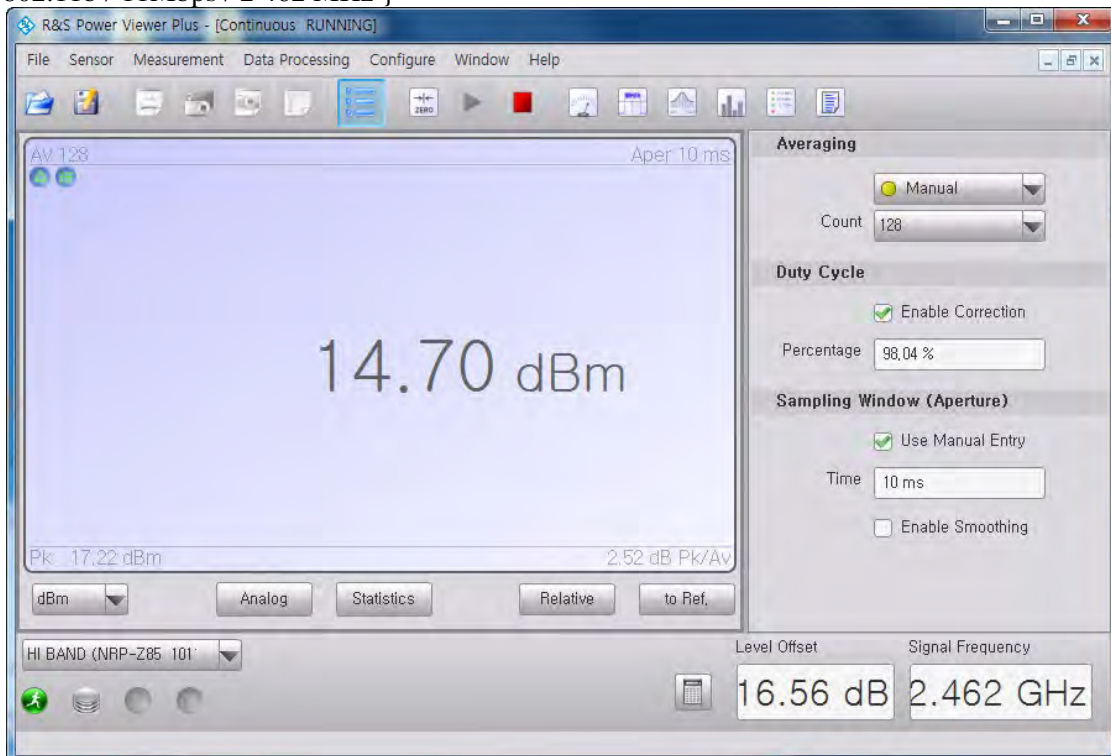

Plot #13{802.11g / 6Mbps / 2 412 MHz }

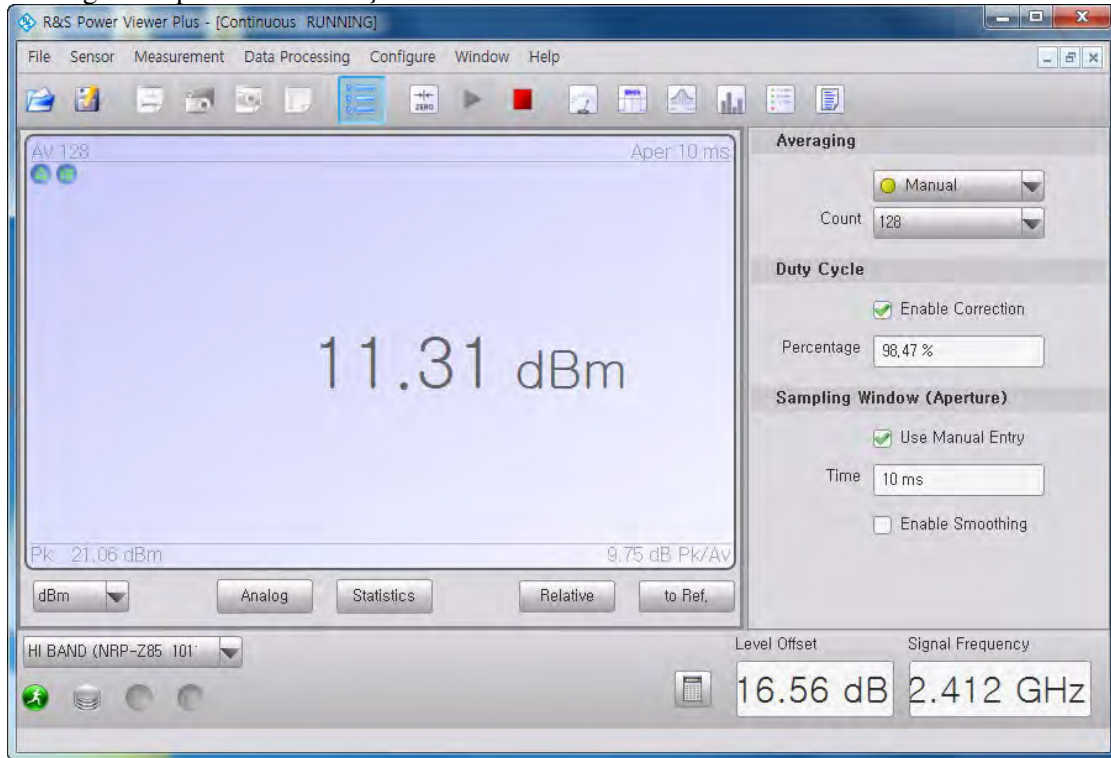

Plot #14{802.11g / 6Mbps / 2 437 MHz }

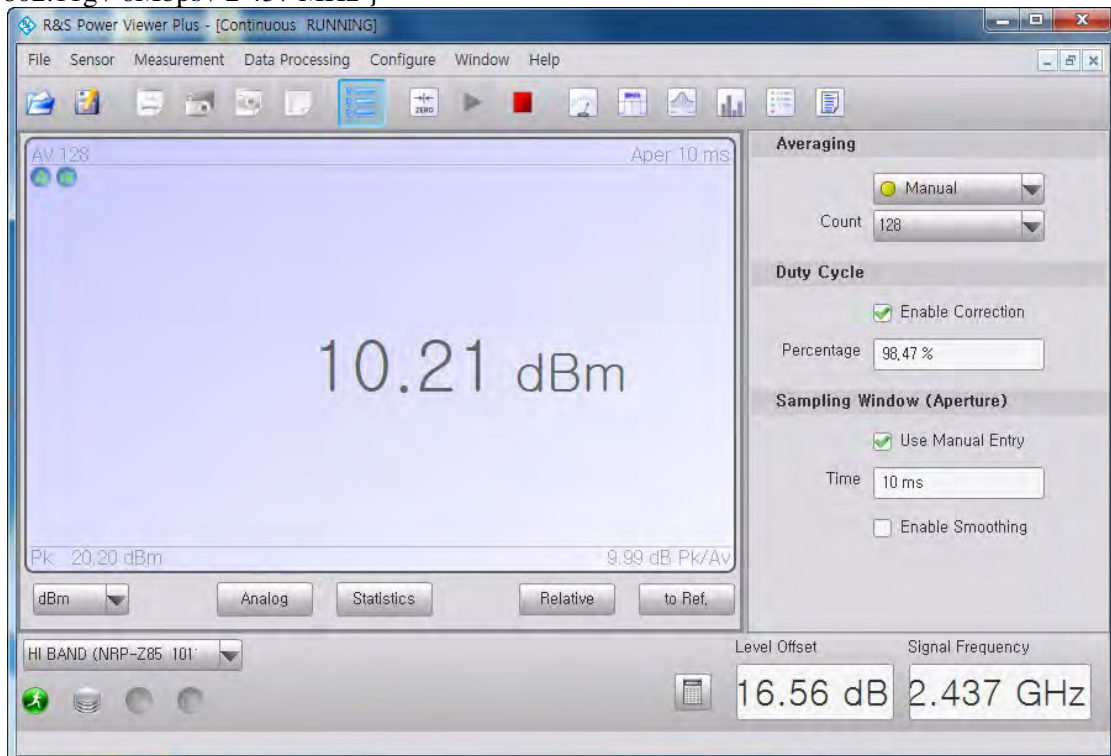

Plot #15{802.11g / 6Mbps / 2.462 MHz }

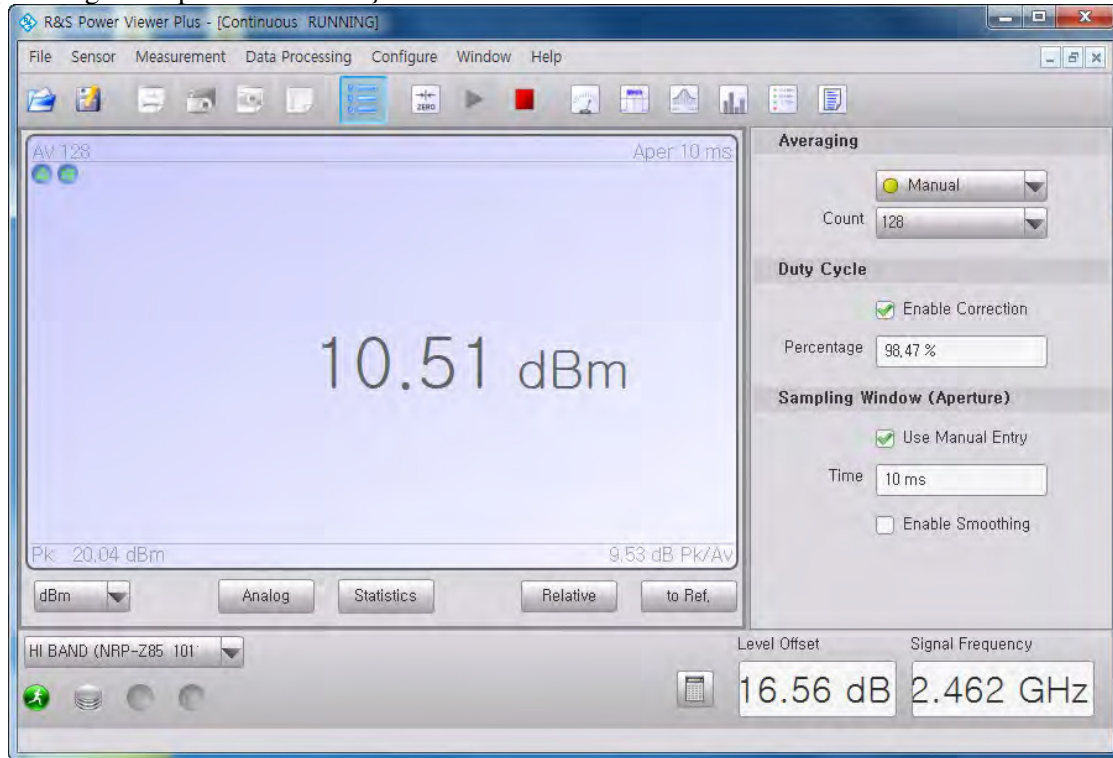

Plot #16{802.11g / 9Mbps / 2.412 MHz }

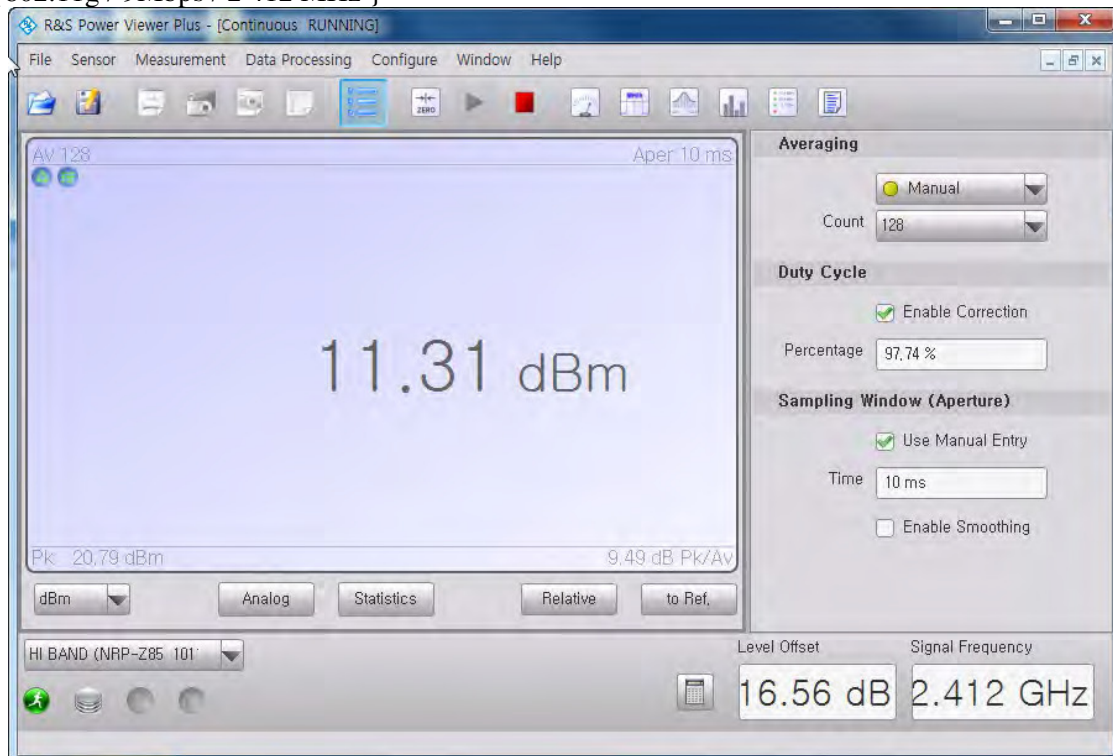

Plot #17{802.11g / 9Mbps / 2 437 MHz }

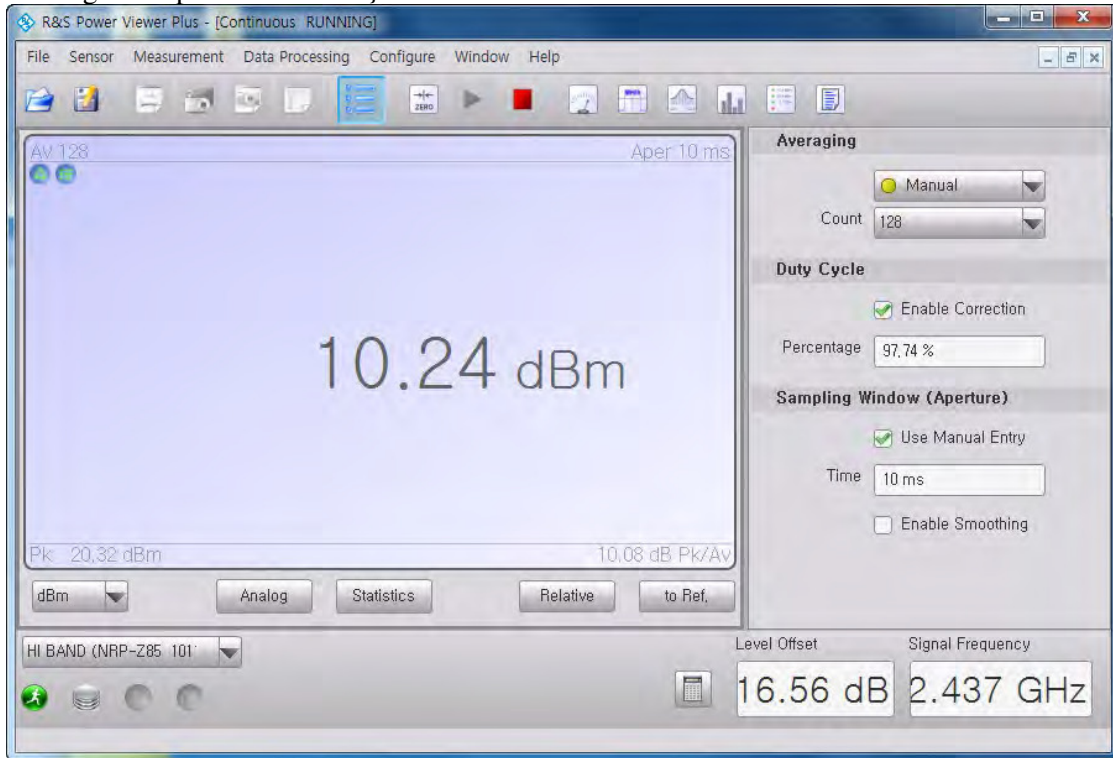

Plot #18{802.11g / 9Mbps / 2 462 MHz }

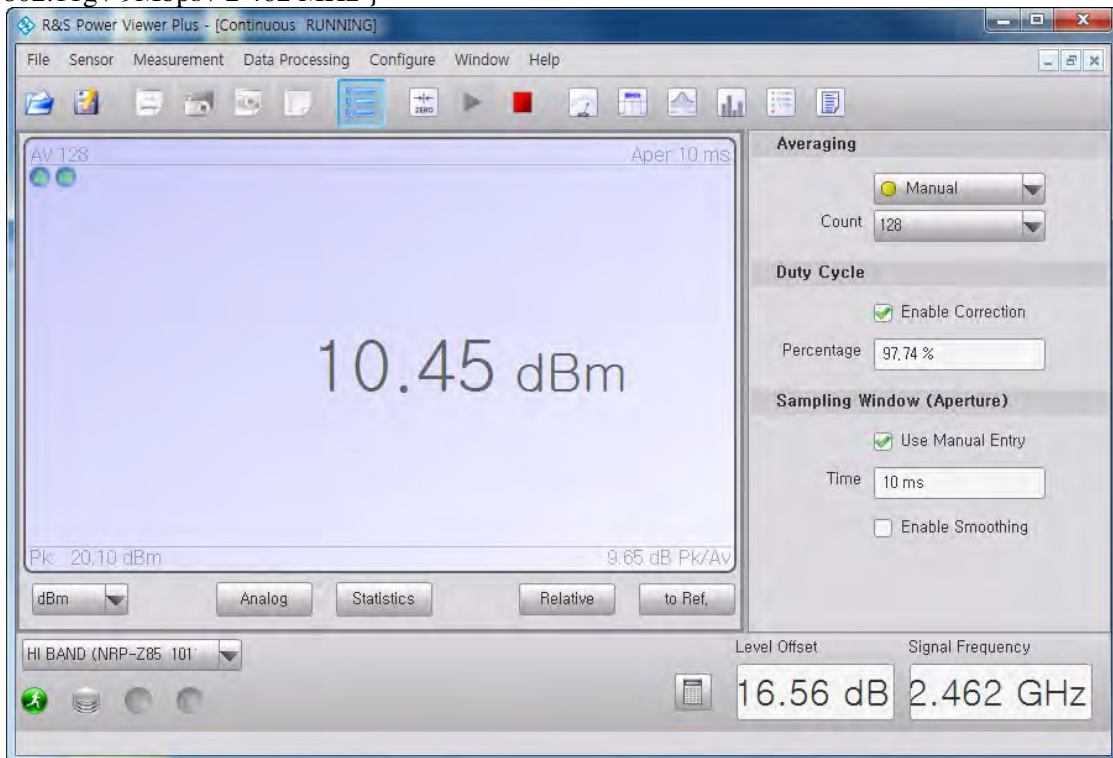

Plot #19{802.11g / 12Mbps / 2 412 MHz }

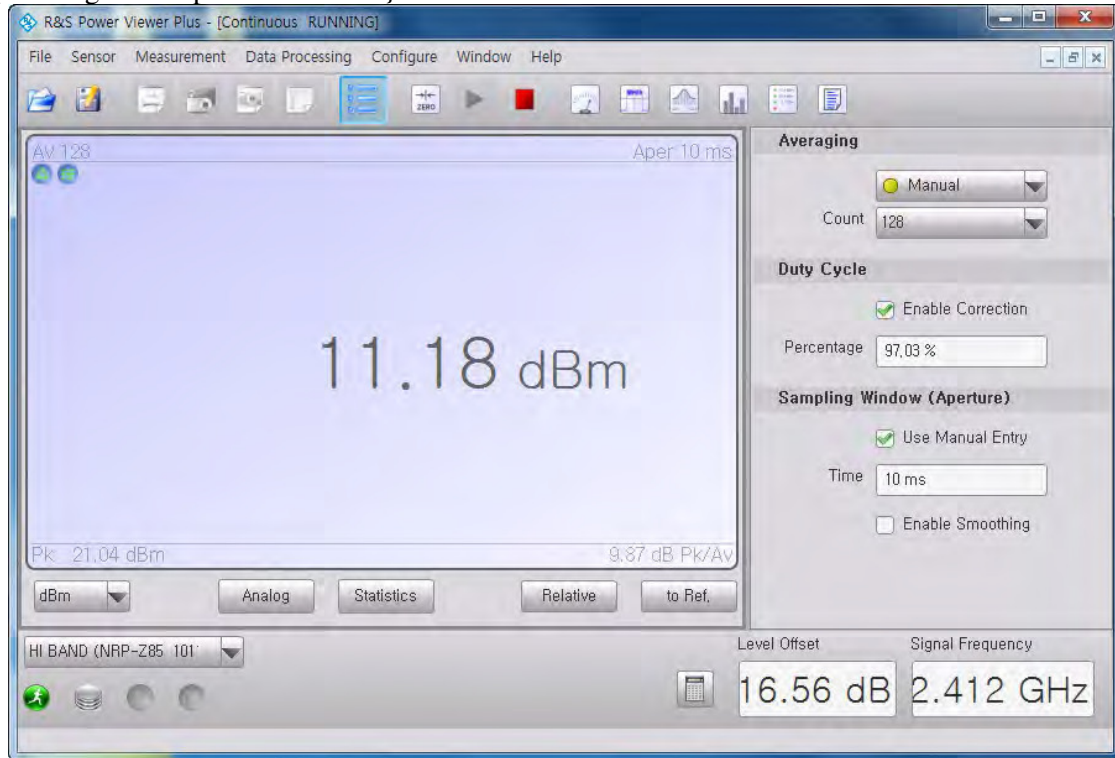

Plot #20{802.11g / 12Mbps / 2 437 MHz }

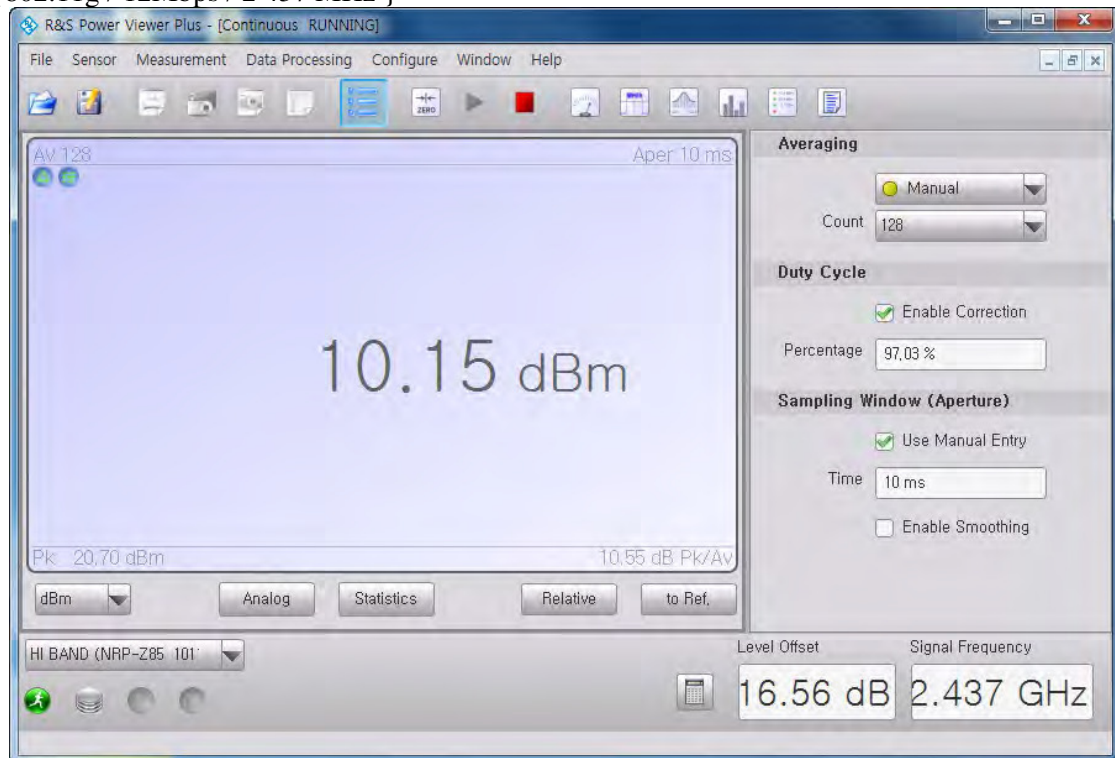

Plot #21 { 802.11g / 12Mbps / 2 462 MHz }

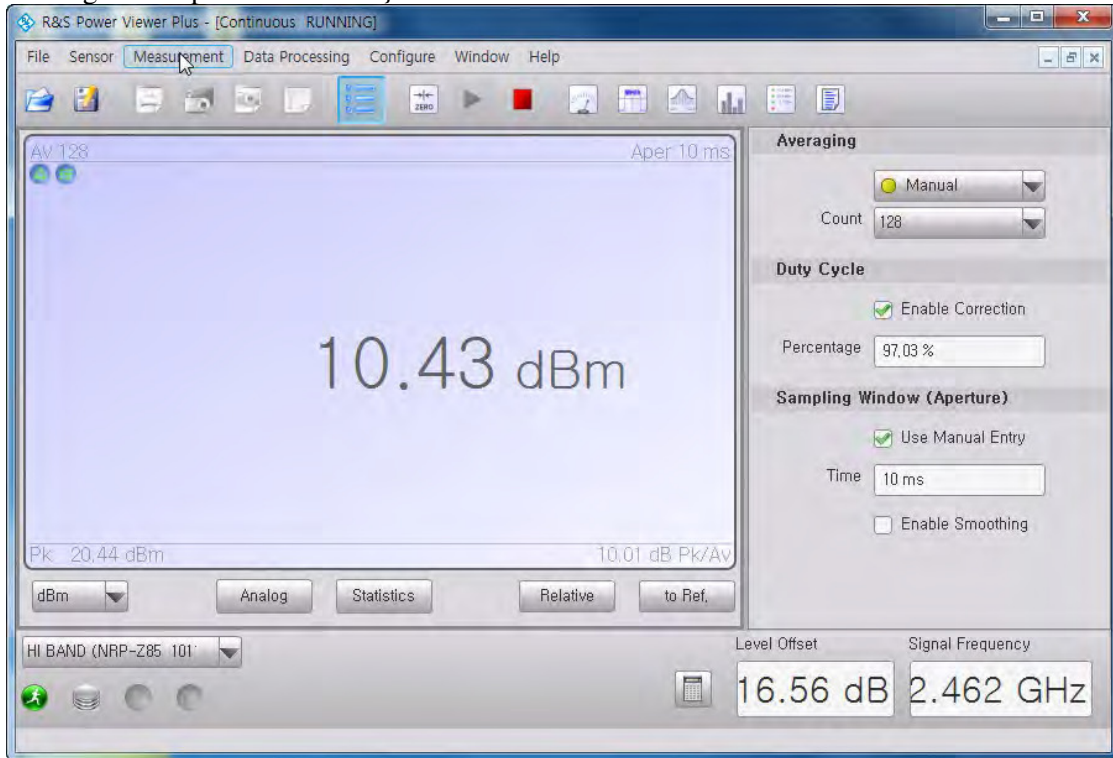

Plot #22 { 802.11g / 18Mbps / 2 412 MHz }

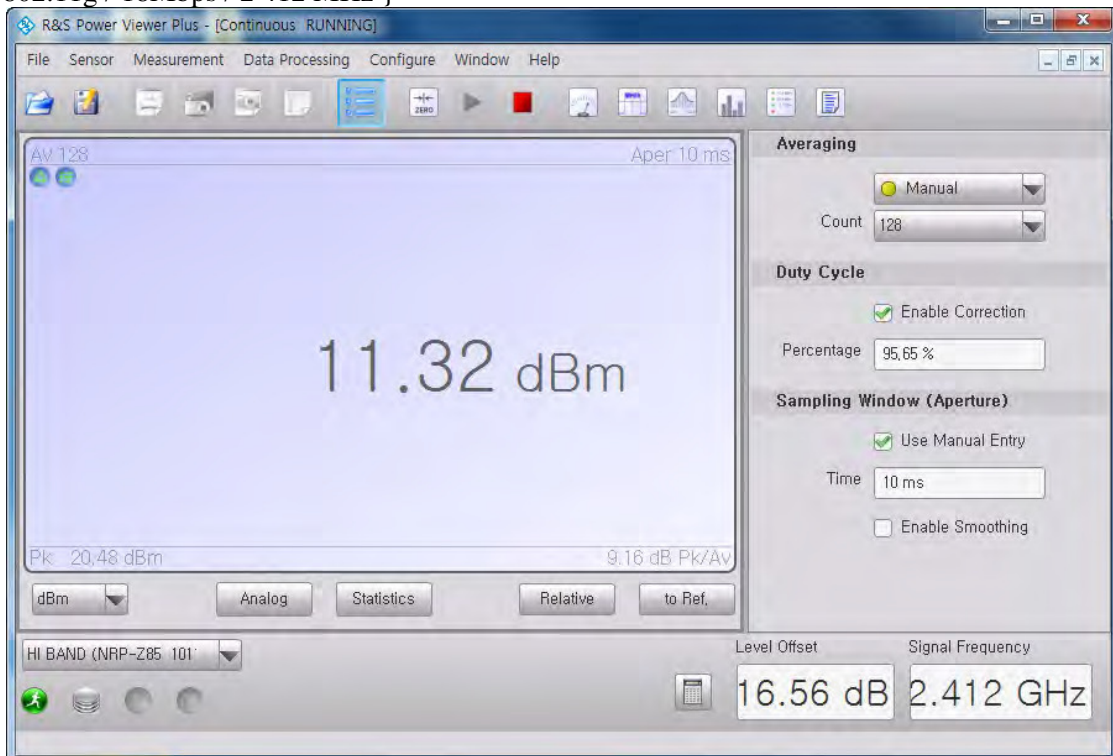

Plot #23{802.11g / 18Mbps / 2 437 MHz }

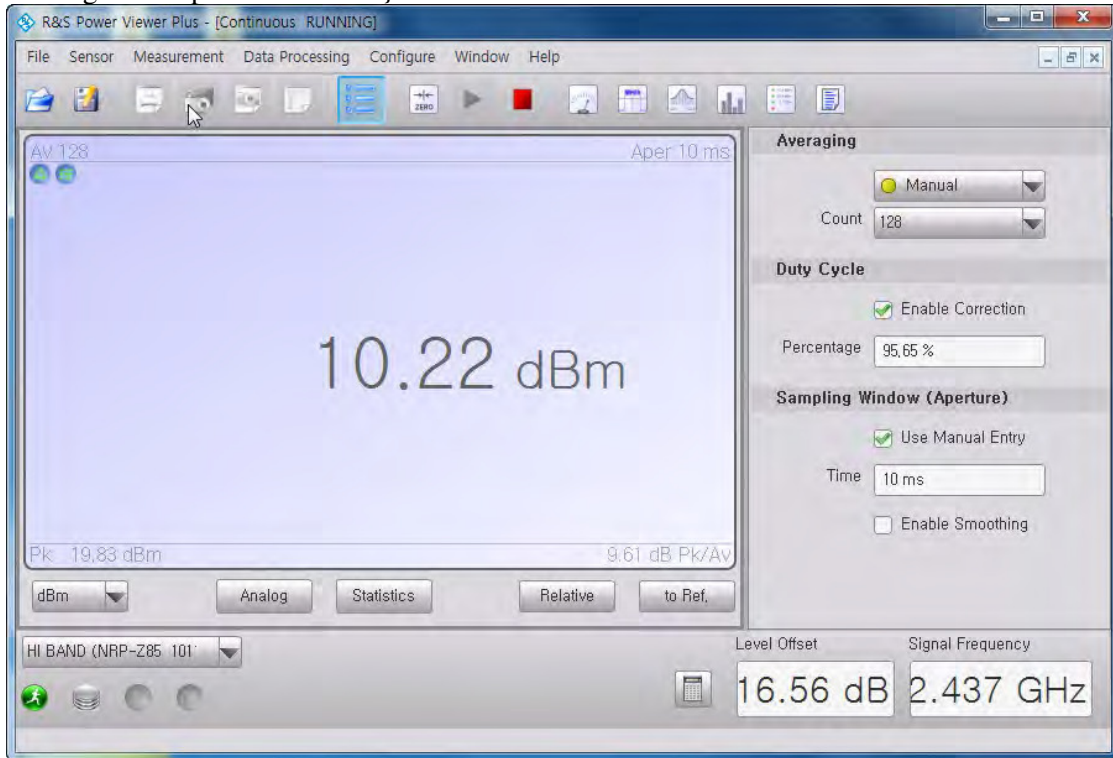

Plot #24{802.11g / 18Mbps / 2 462 MHz }

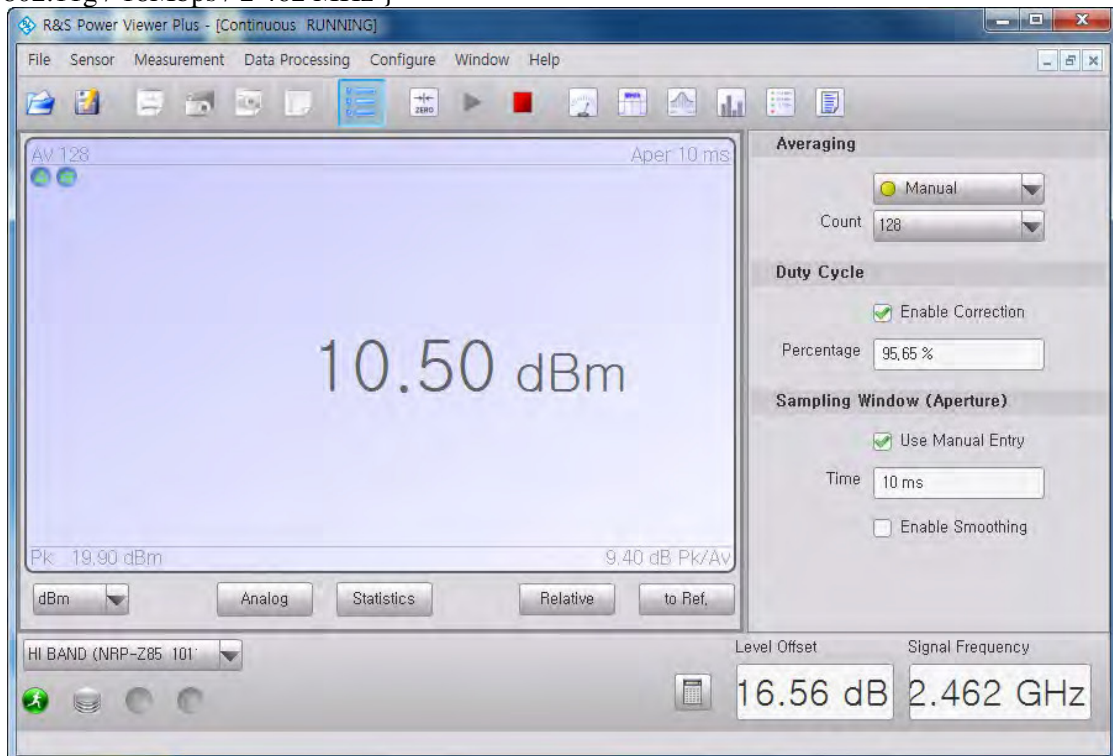

Plot #25{802.11g / 24Mbps / 2 412 MHz }

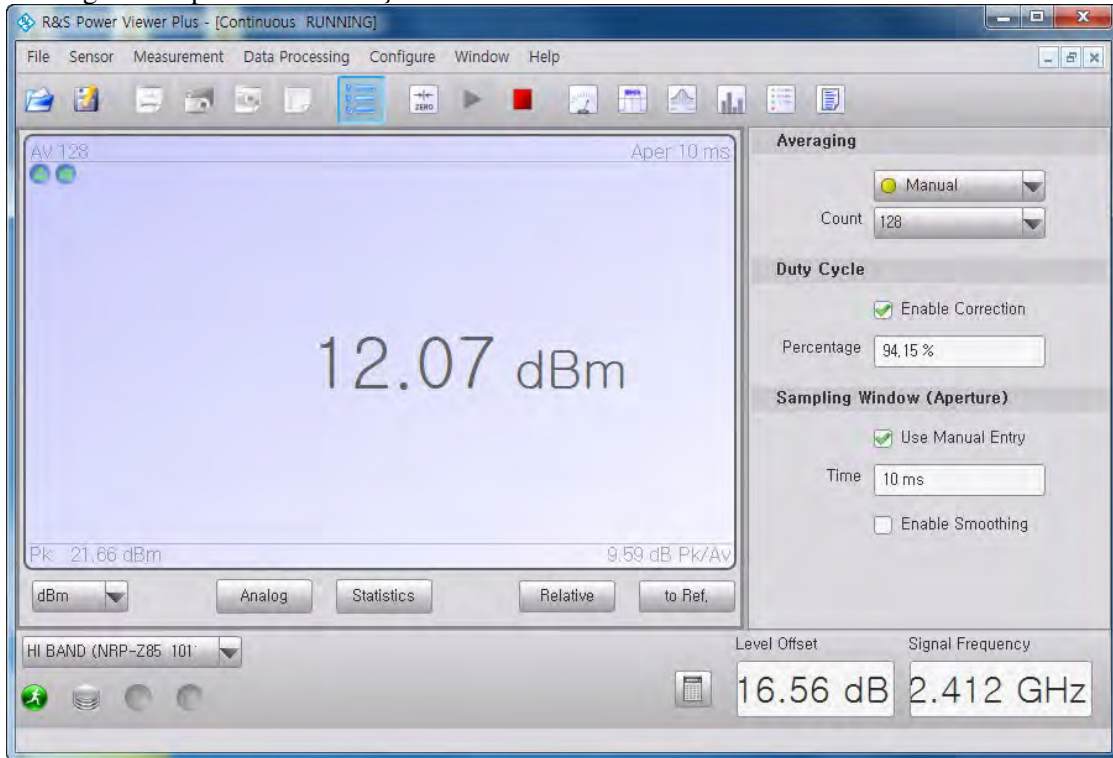

Plot #26{802.11g / 24Mbps / 2 437 MHz }

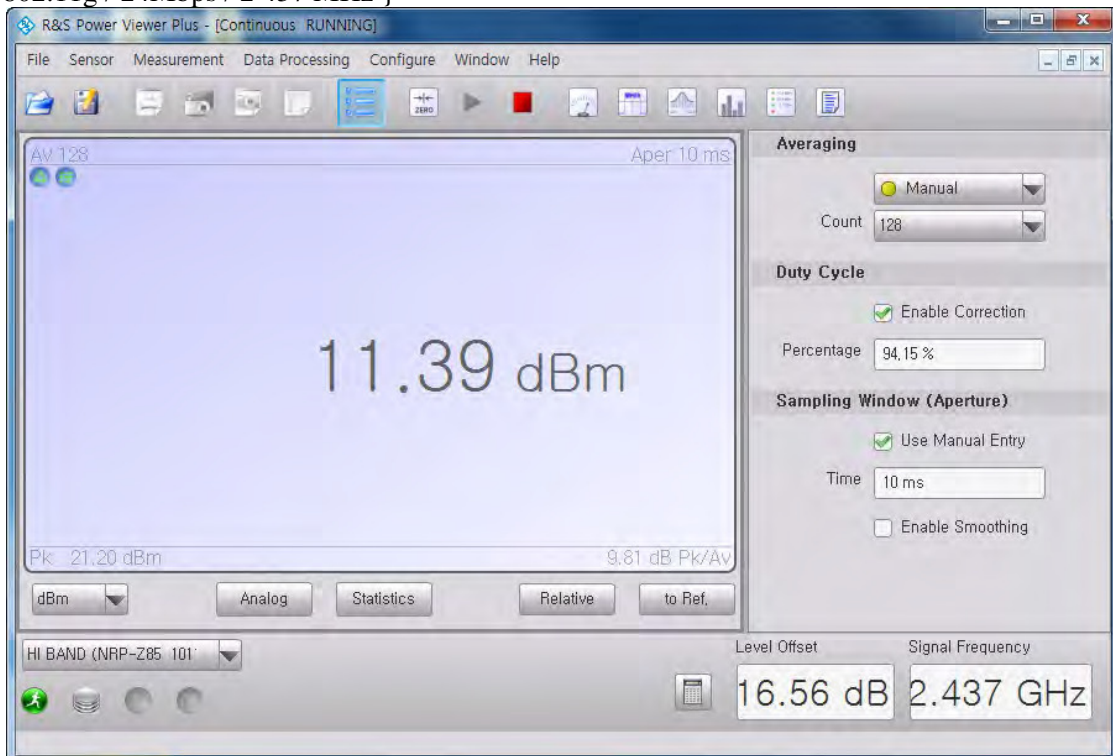

Plot #27{802.11g / 24Mbps / 2 462 MHz }

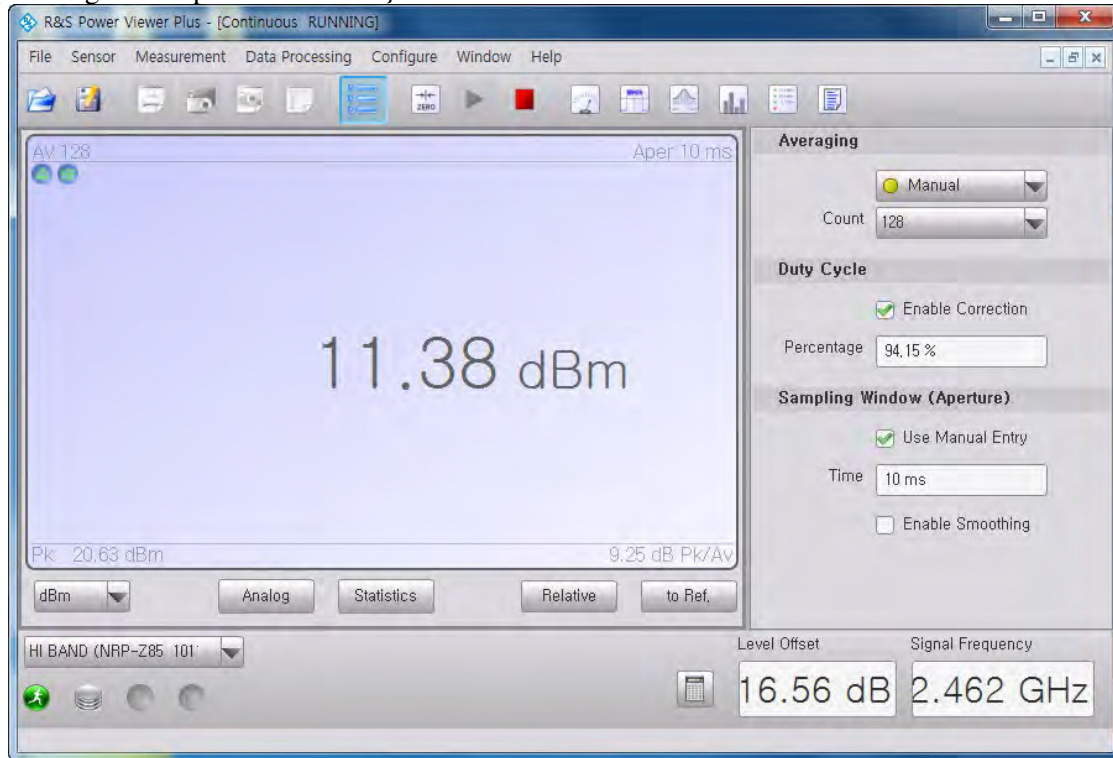

Plot #28{802.11g / 36Mbps / 2 412 MHz }

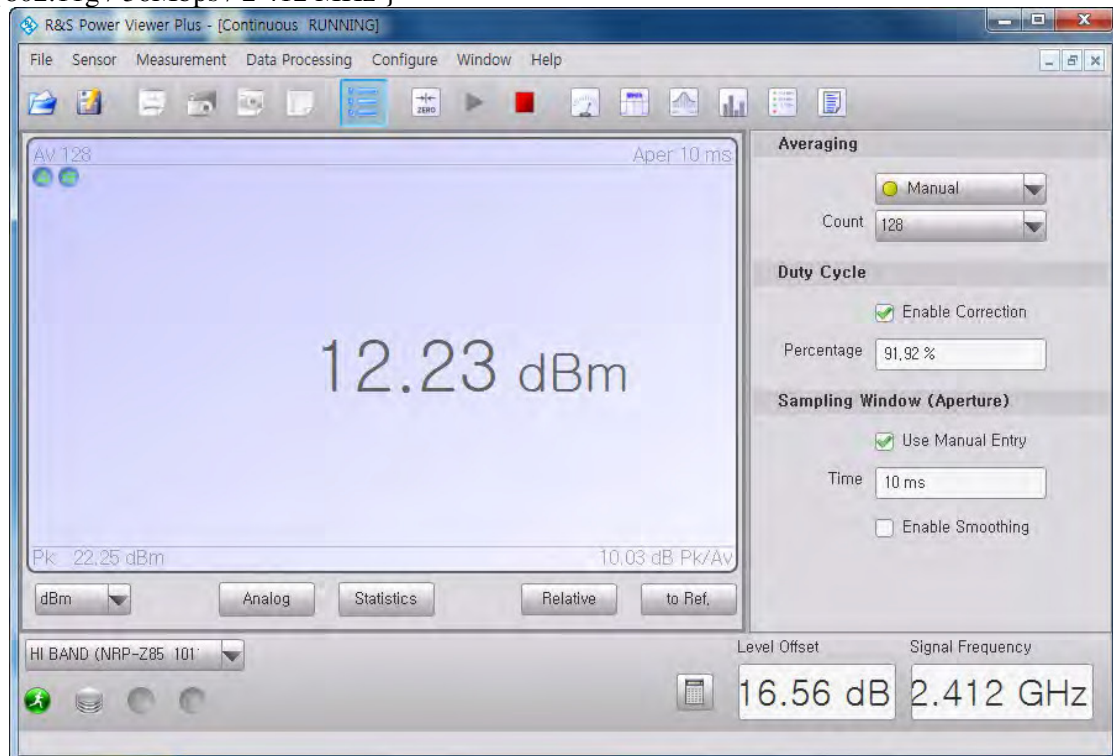

Plot #29{802.11g / 36Mbps / 2 437 MHz }

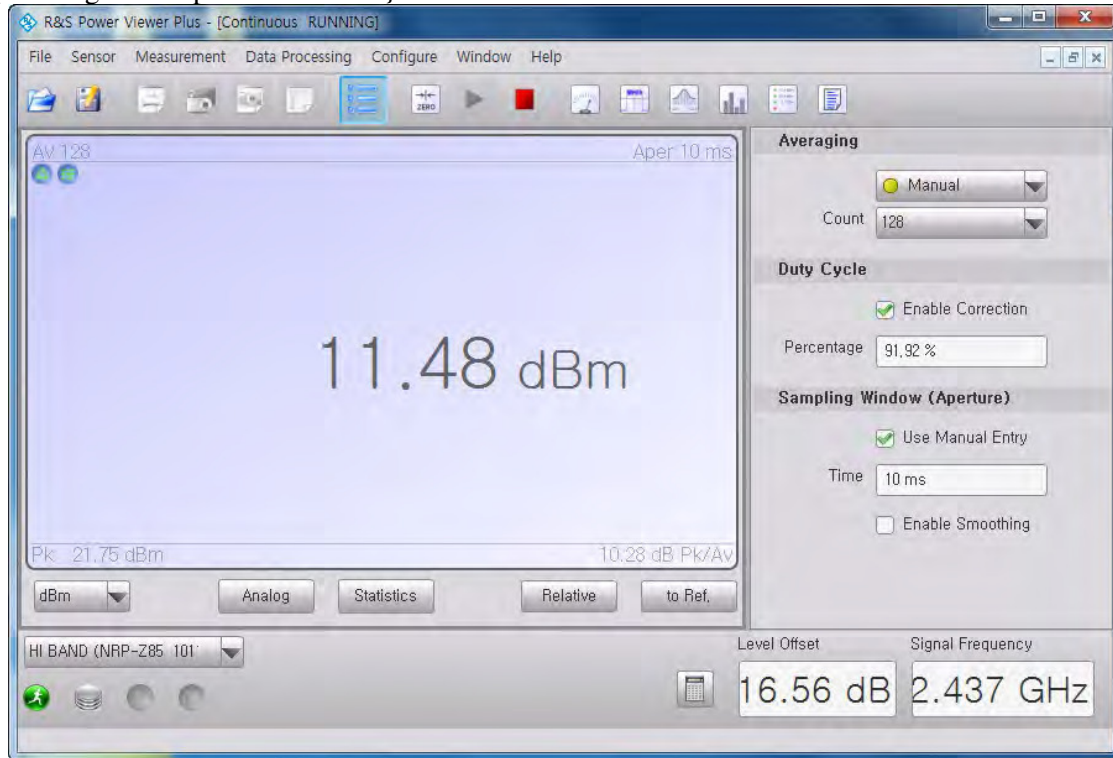

Plot #30{802.11g / 36Mbps / 2 462 MHz }

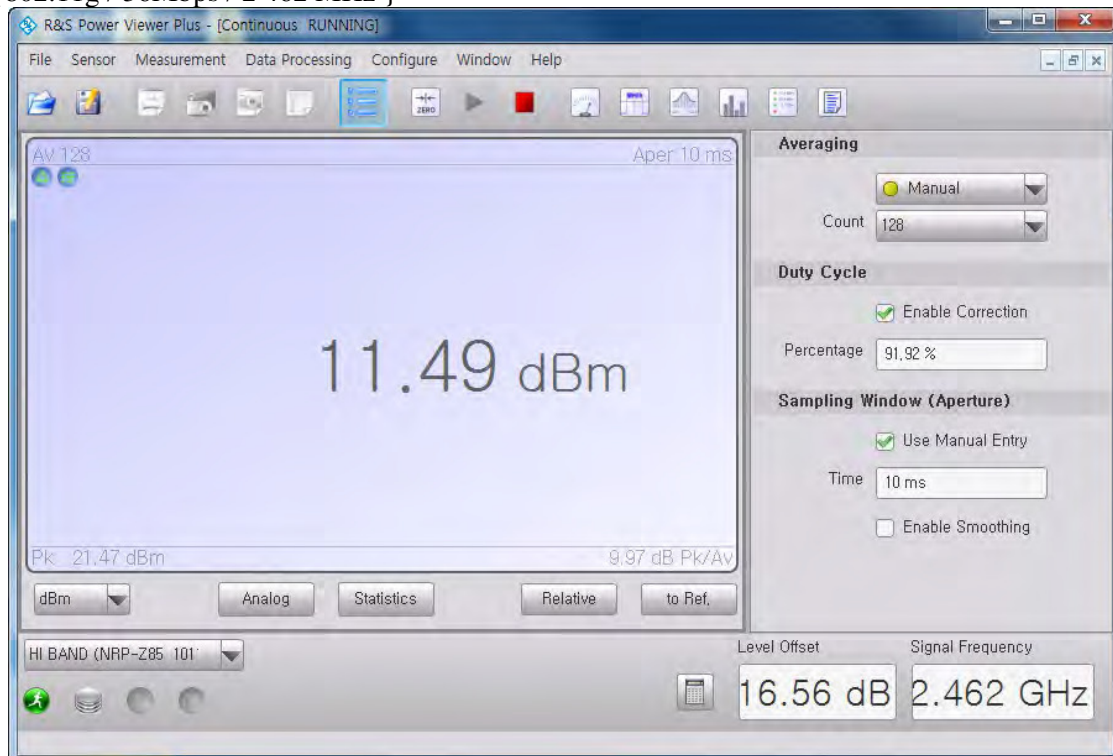

Plot #31 { 802.11g / 48Mbps / 2 412 MHz }

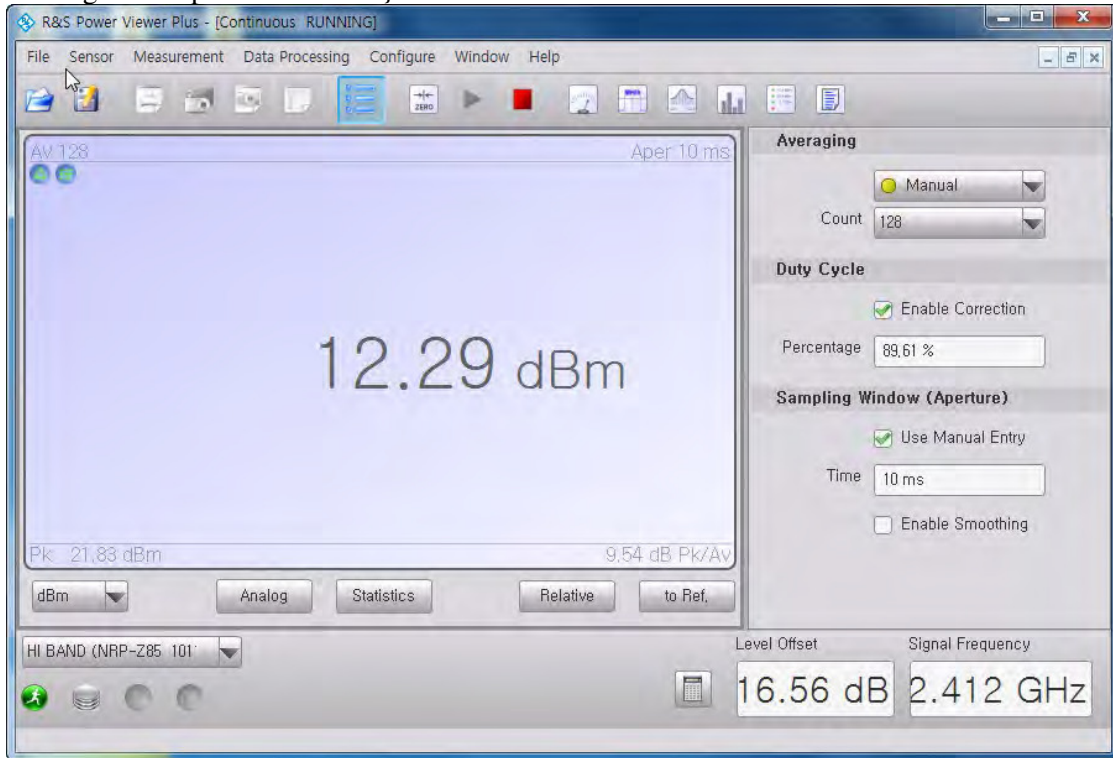

Plot #32 { 802.11g / 48Mbps / 2 437 MHz }

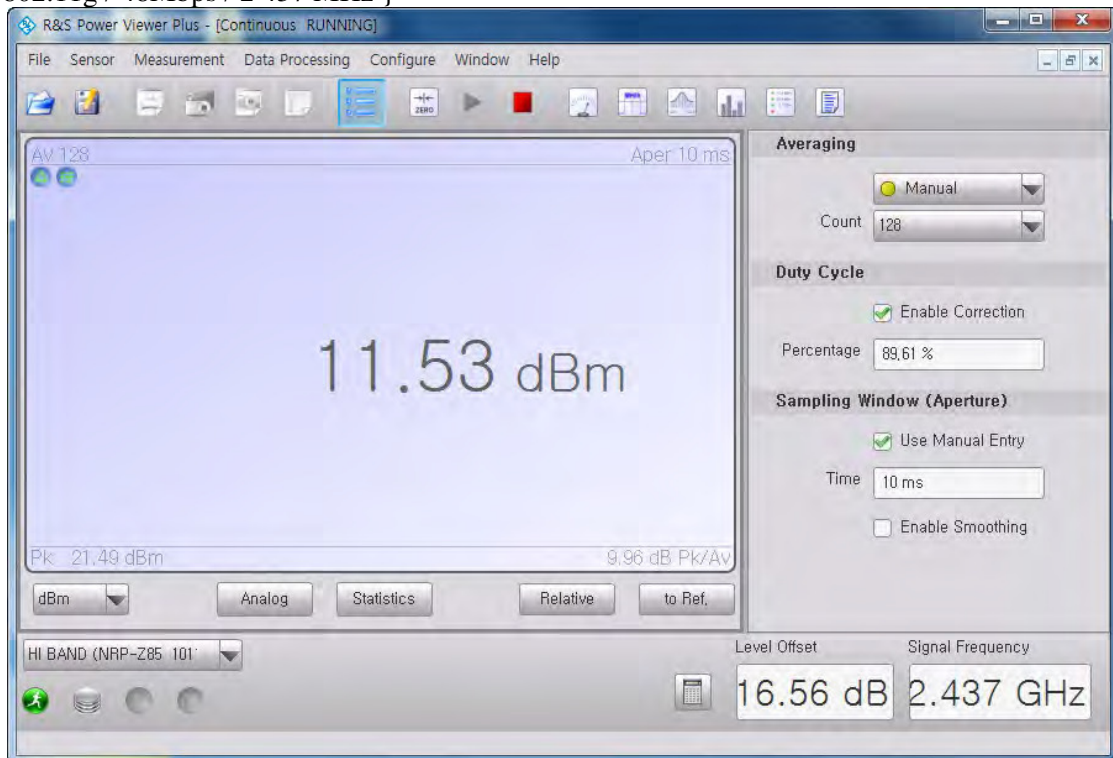

Plot #33{802.11g / 48Mbps / 2 462 MHz }

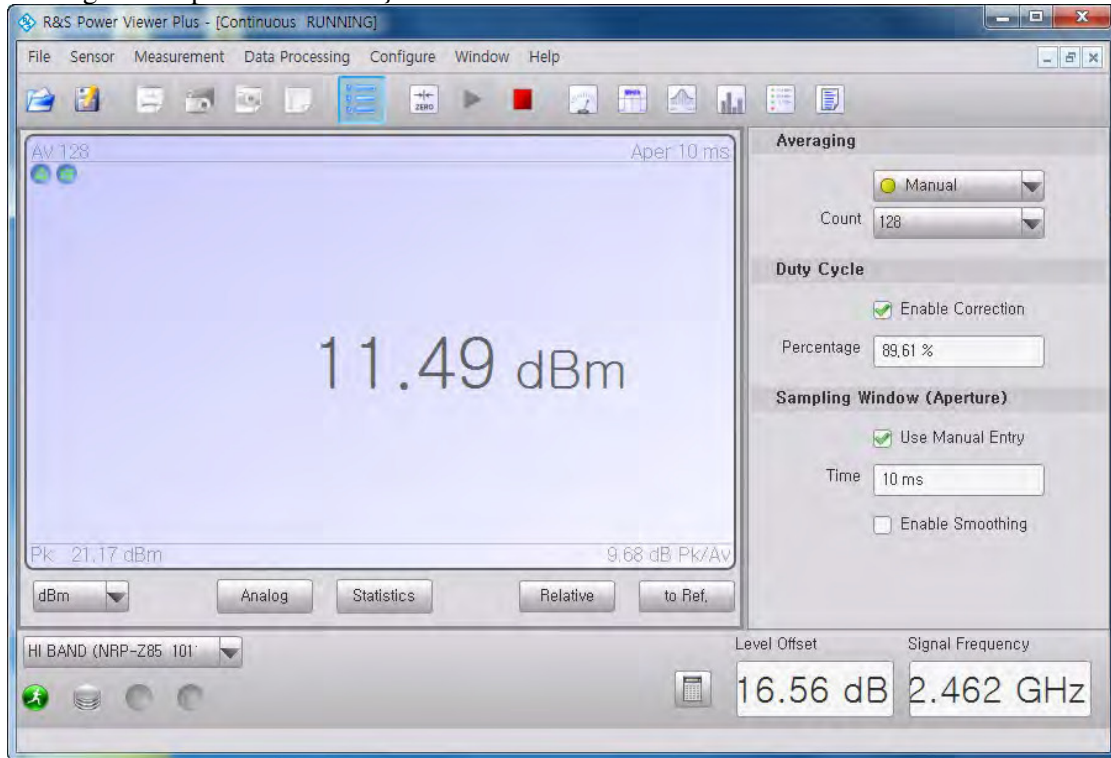

Plot #34{802.11g / 54Mbps / 2 412 MHz }

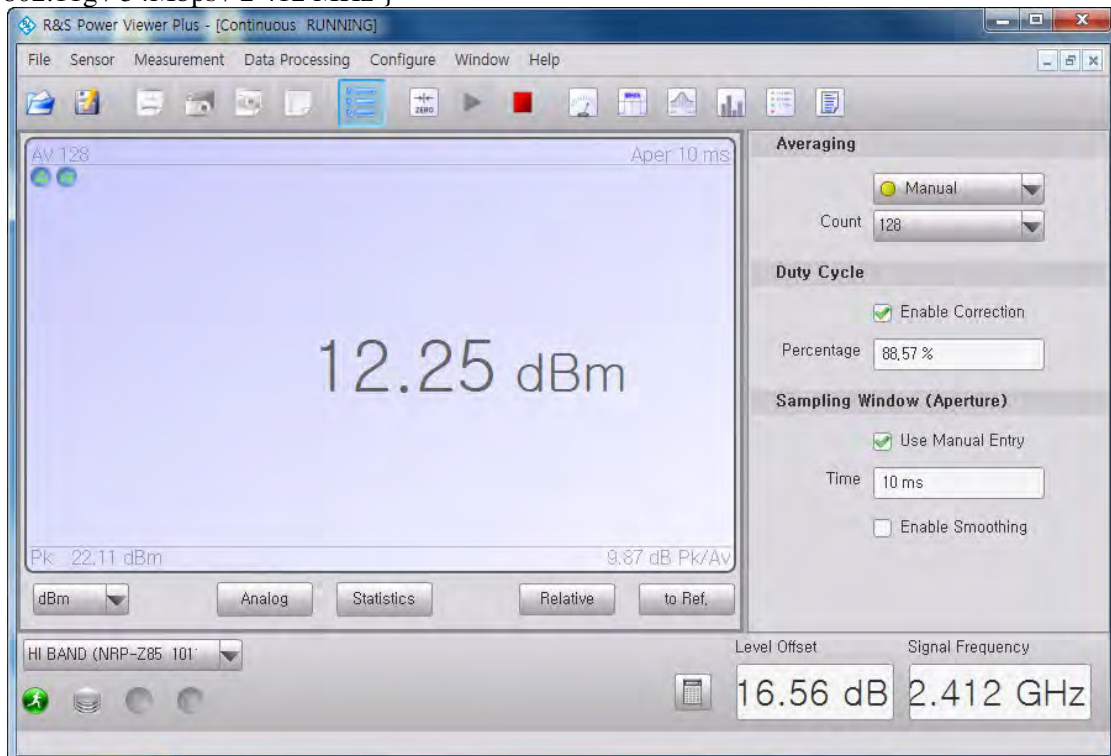

Plot #35{802.11g / 54Mbps / 2 437 MHz }

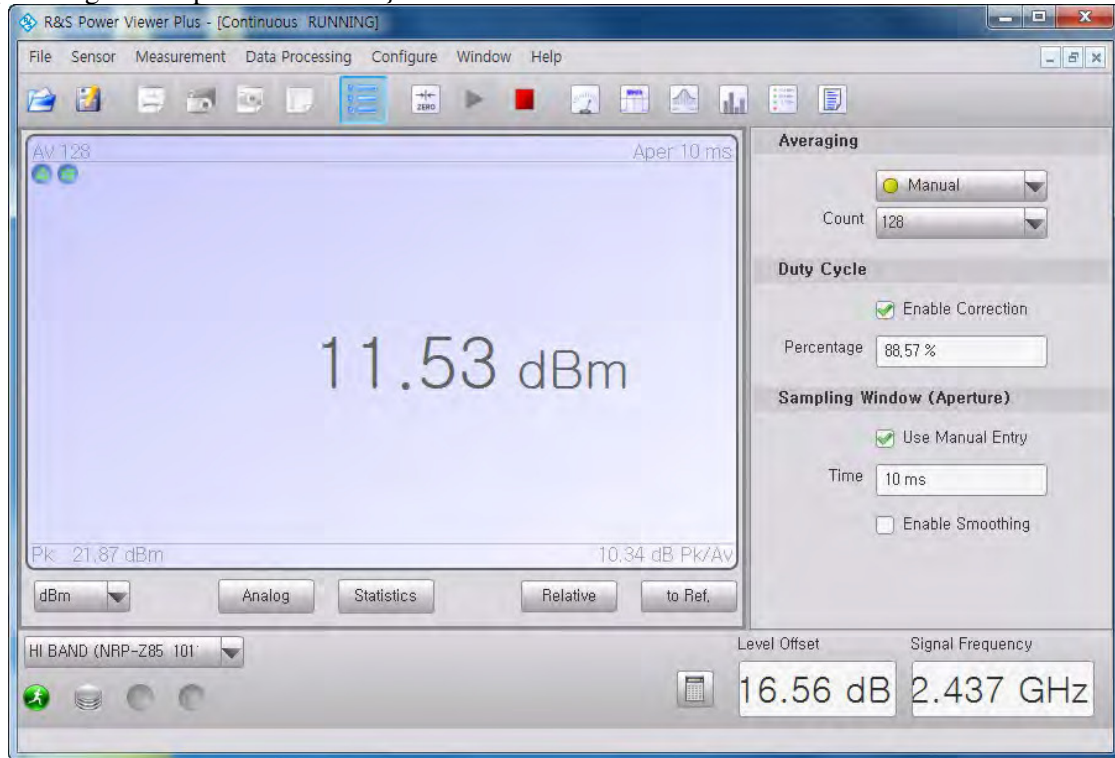

Plot #36{802.11g / 54Mbps / 2 462 MHz }

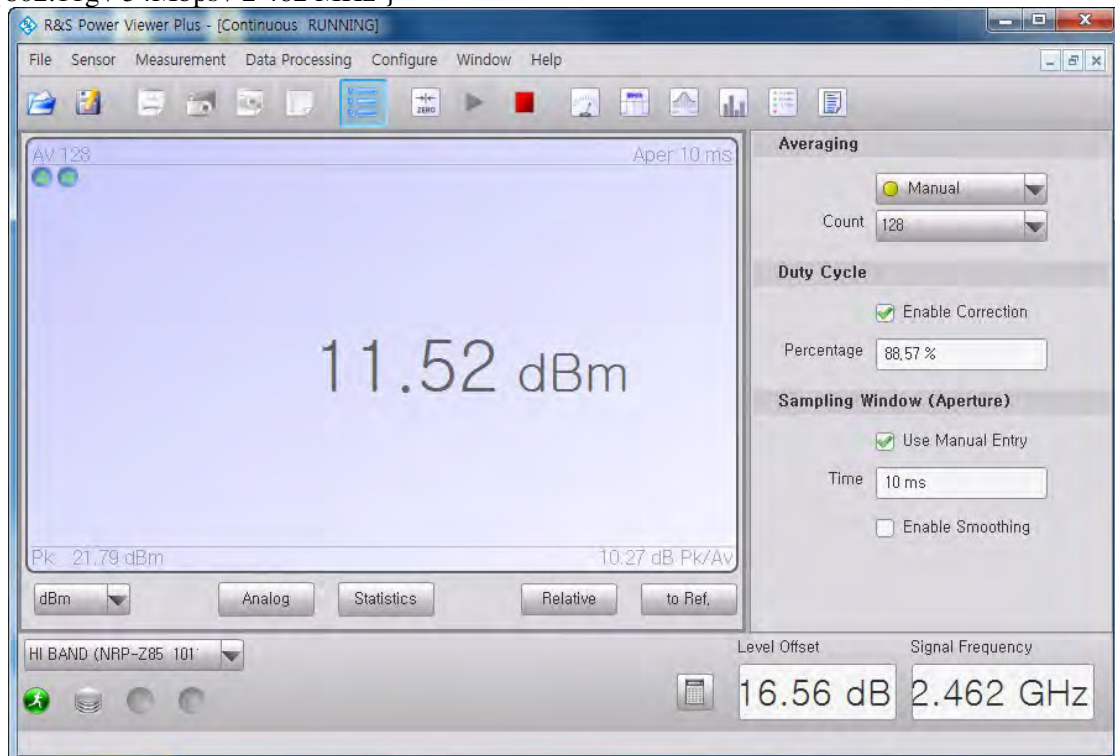

Plot #37{802.11n / MCS0 / 2 412 MHz }

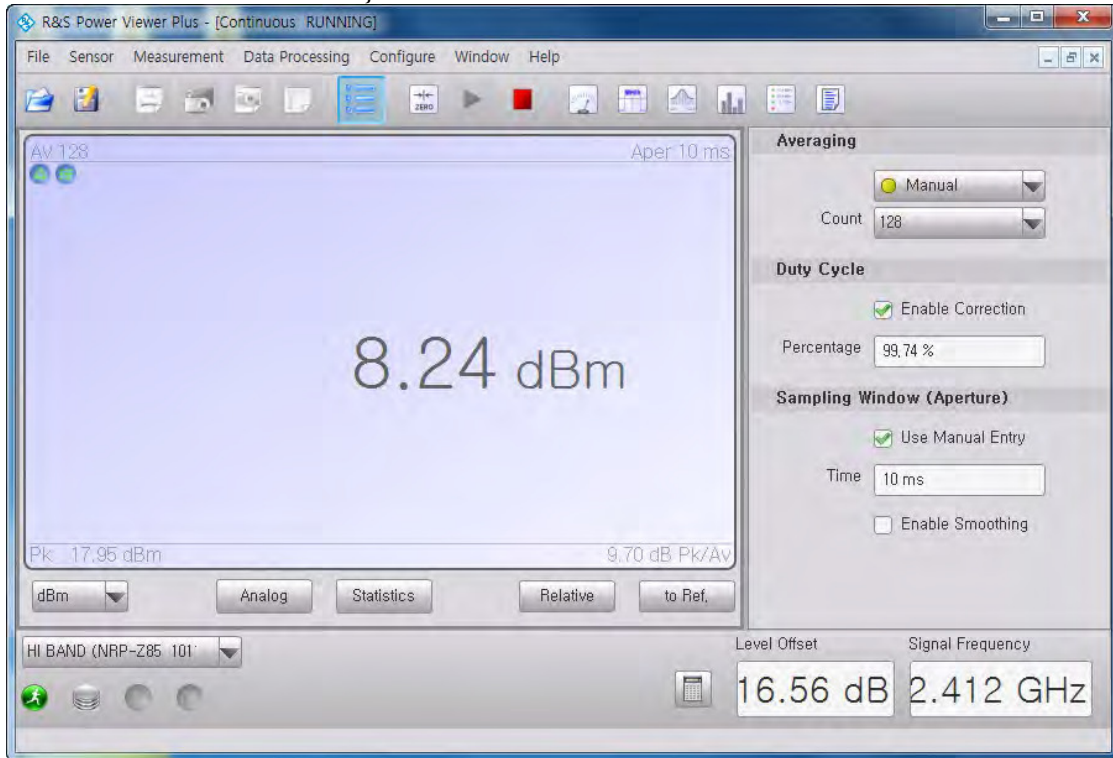

Plot #38{802.11n / MCS0 / 2 437 MHz }

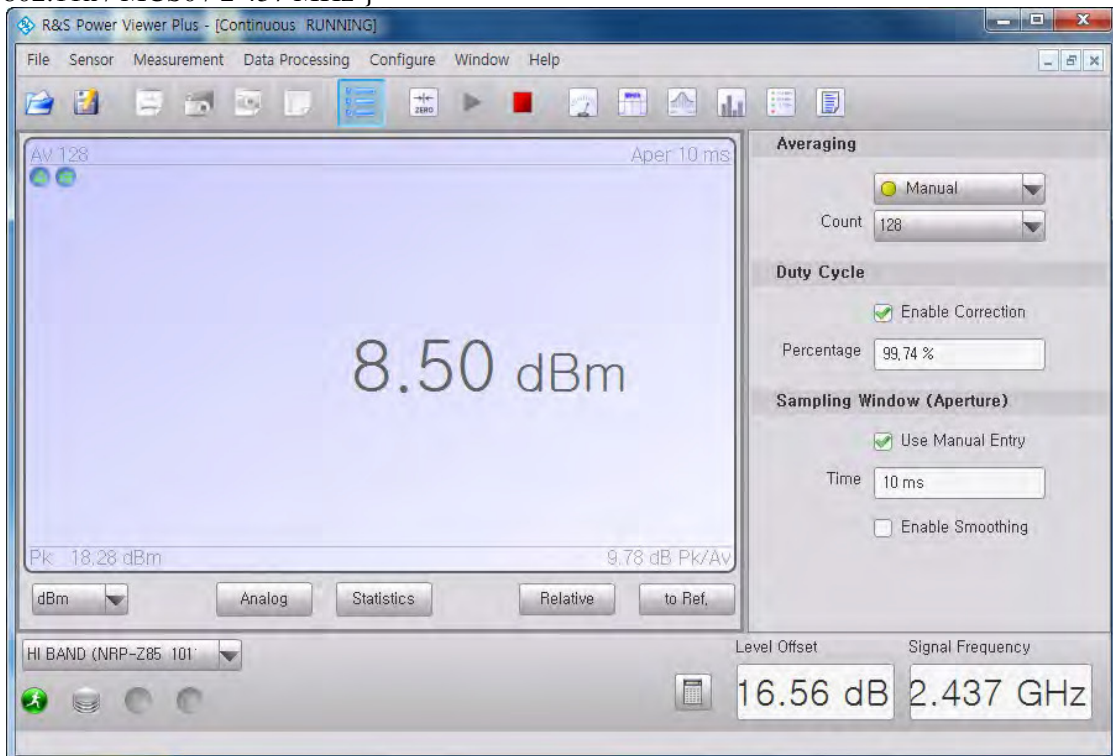

Plot #39{802.11n / MCS0 / 2 462 MHz }

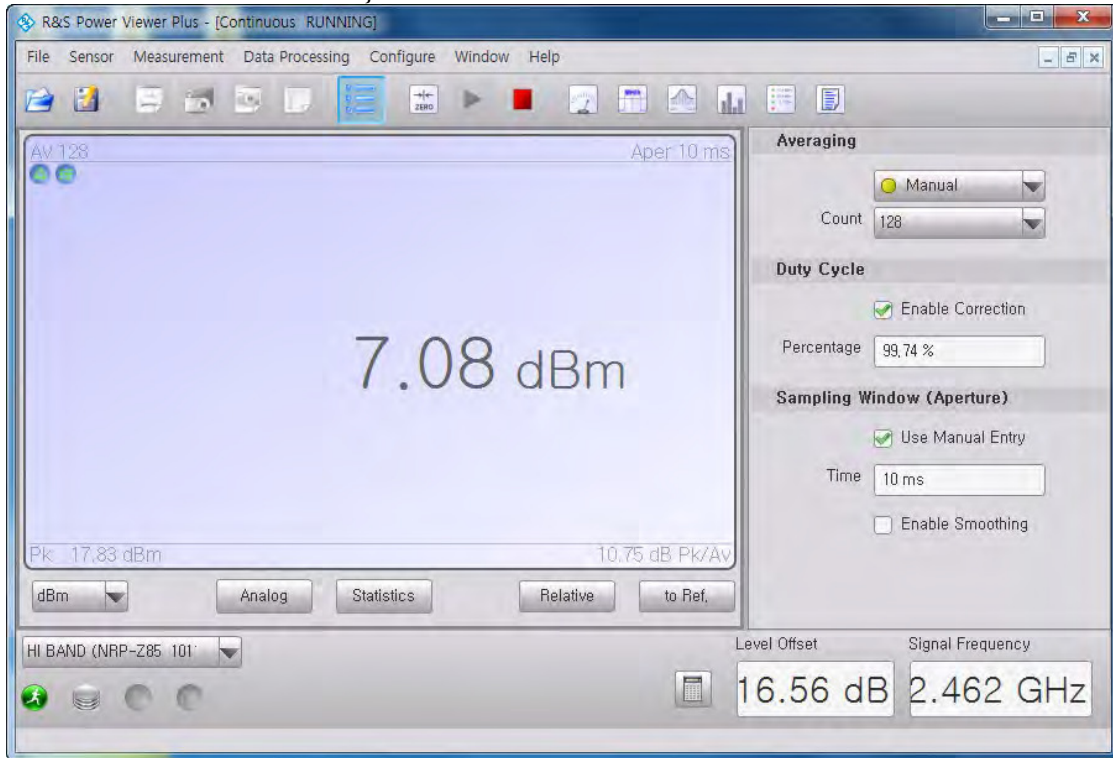

Plot #40{802.11n / MCS1 / 2 412 MHz }

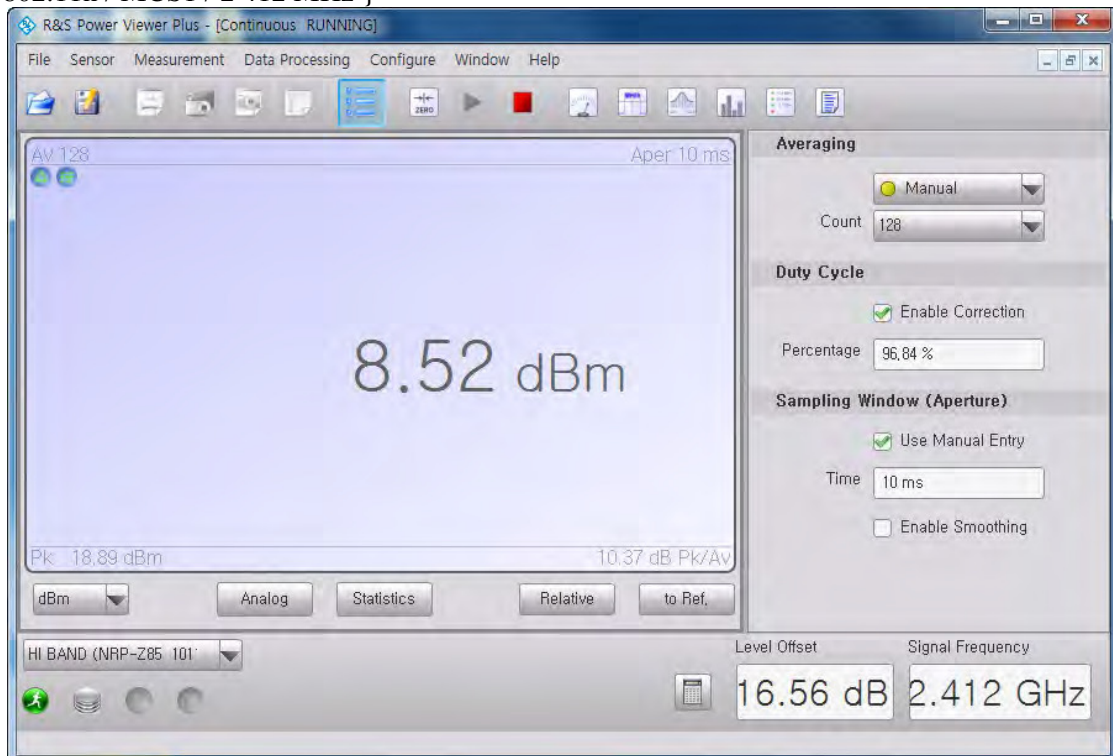

Plot #41 { 802.11n / MCS1 / 2 437 MHz }

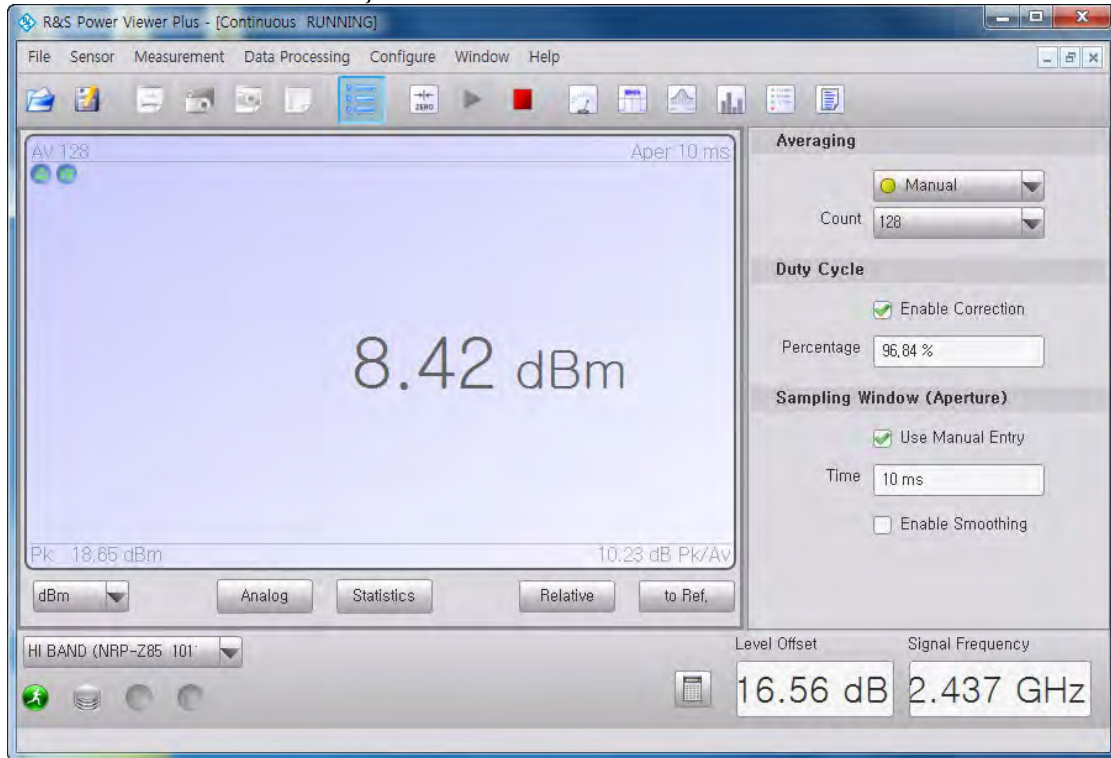

Plot #42 { 802.11n / MCS1 / 2 462 MHz }

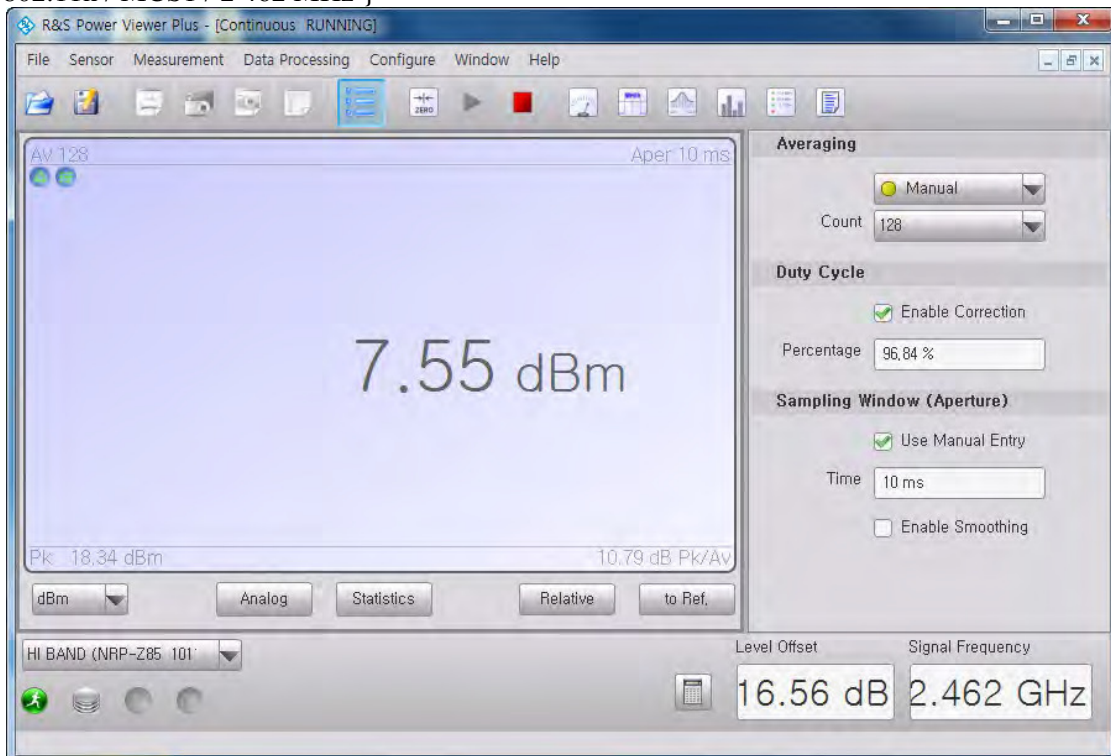

Plot #43 { 802.11n / MCS2 / 2 412 MHz }

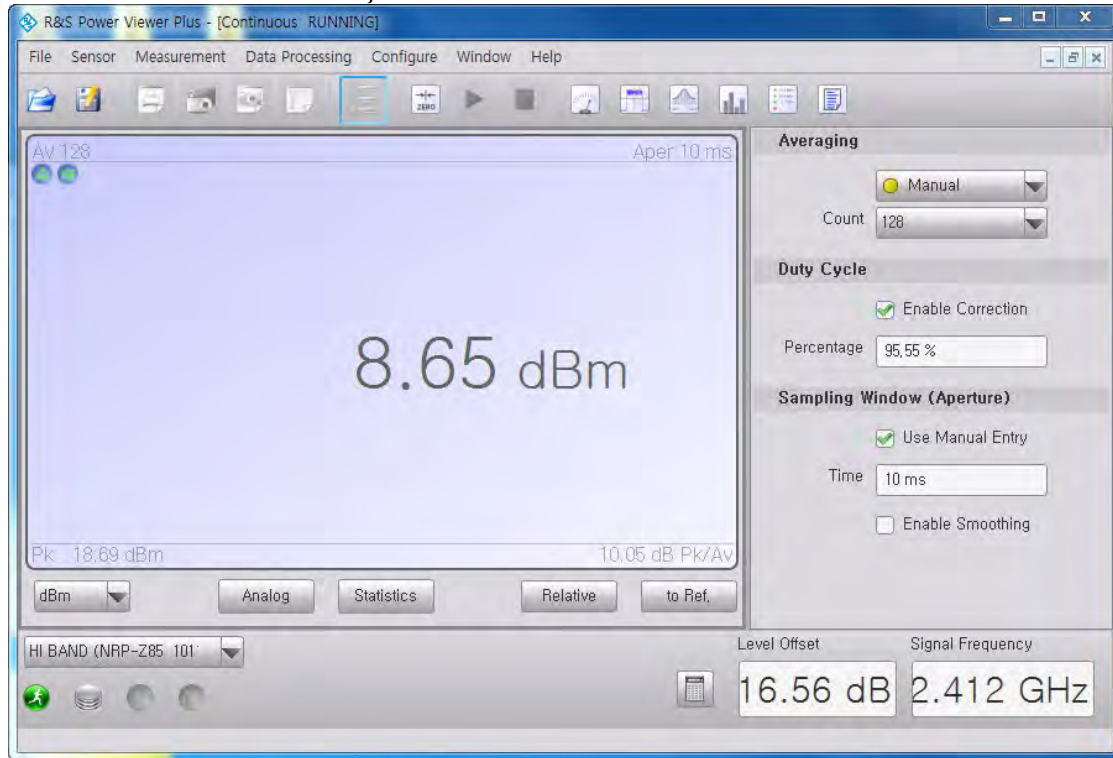

Plot #44 { 802.11n / MCS2 / 2 437 MHz }

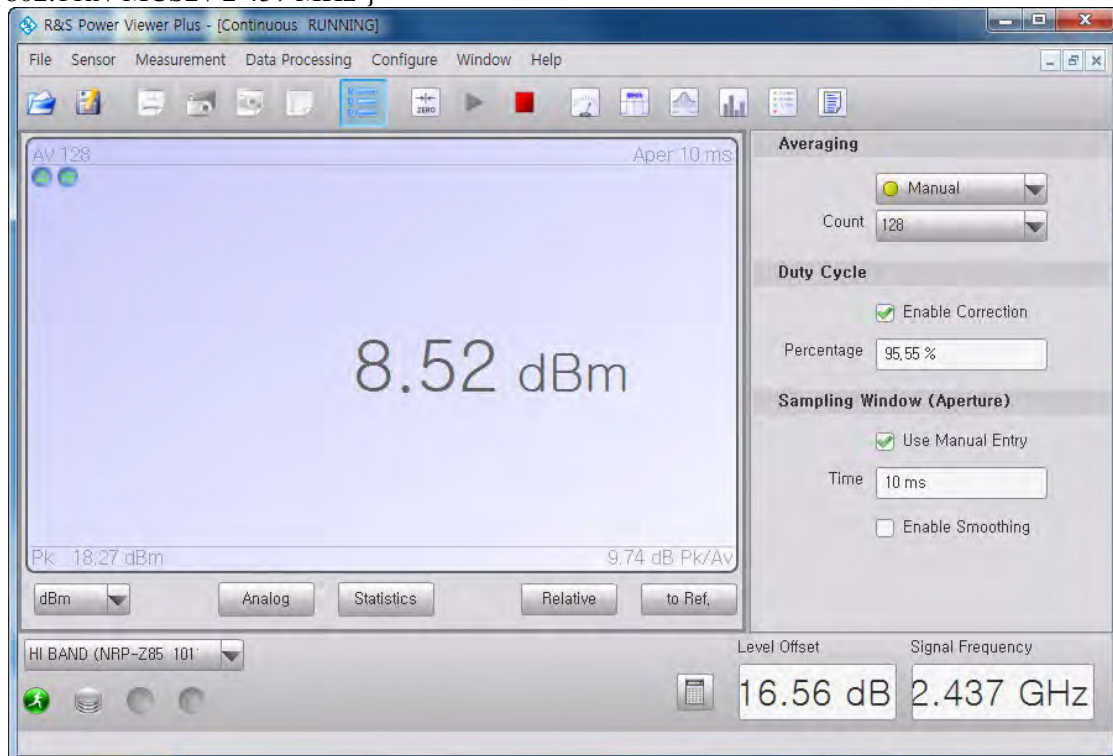

Plot #45{802.11n / MCS2 / 2 462 MHz }

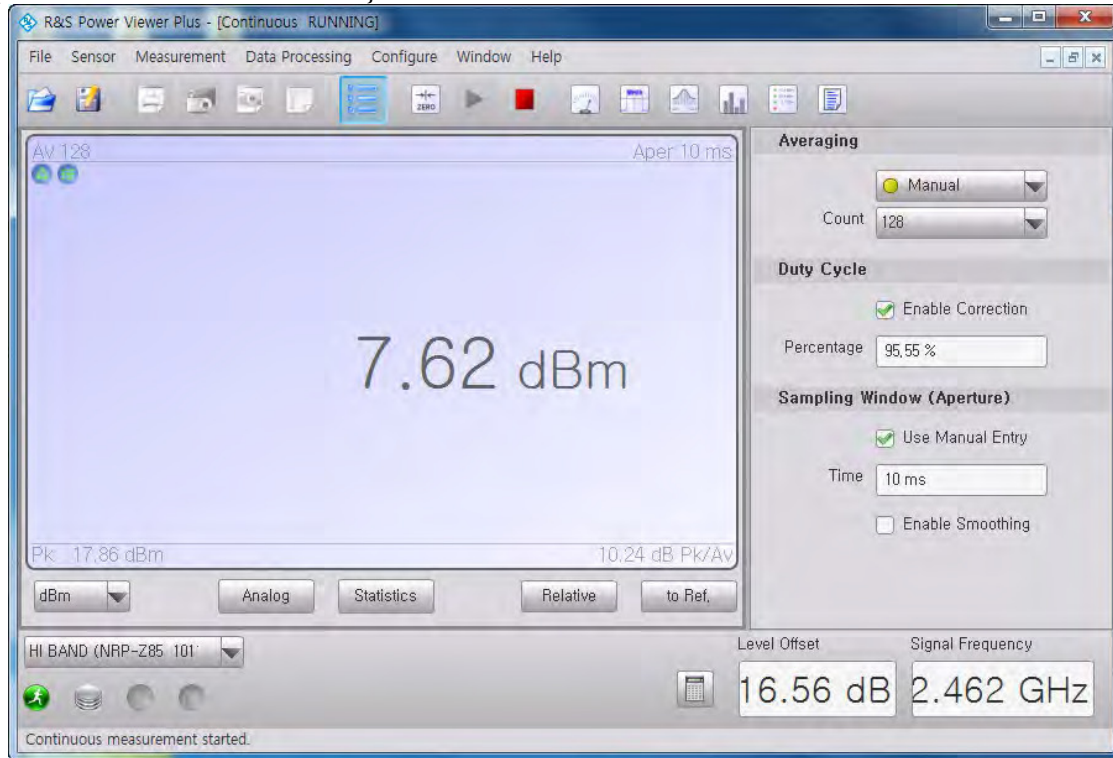

Plot #46{802.11n / MCS3 / 2 412 MHz }

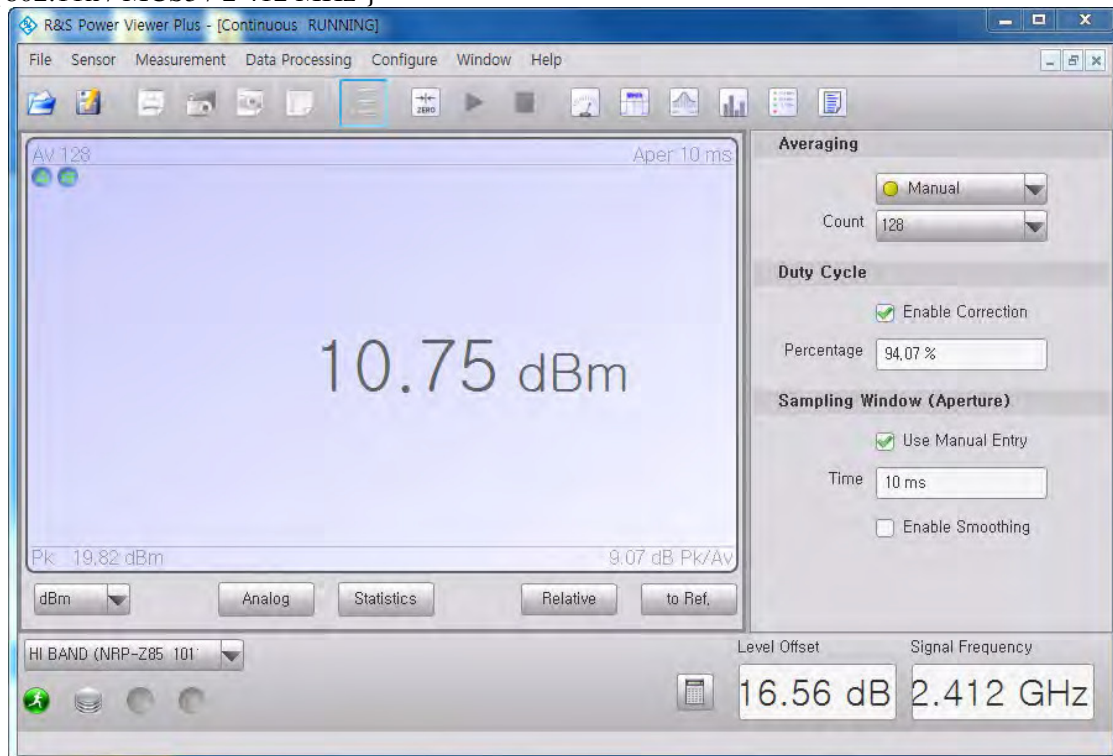

Plot #47{802.11n / MCS3 / 2 437 MHz }

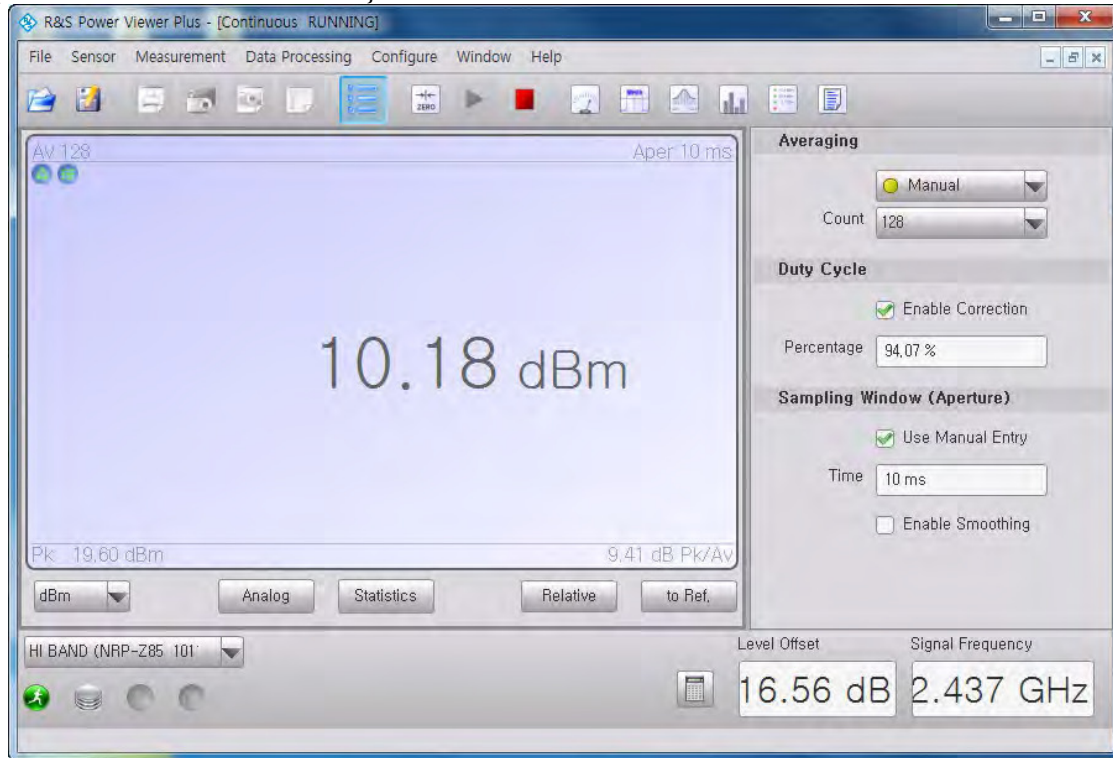

Plot #48{802.11n / MCS3 / 2 462 MHz }

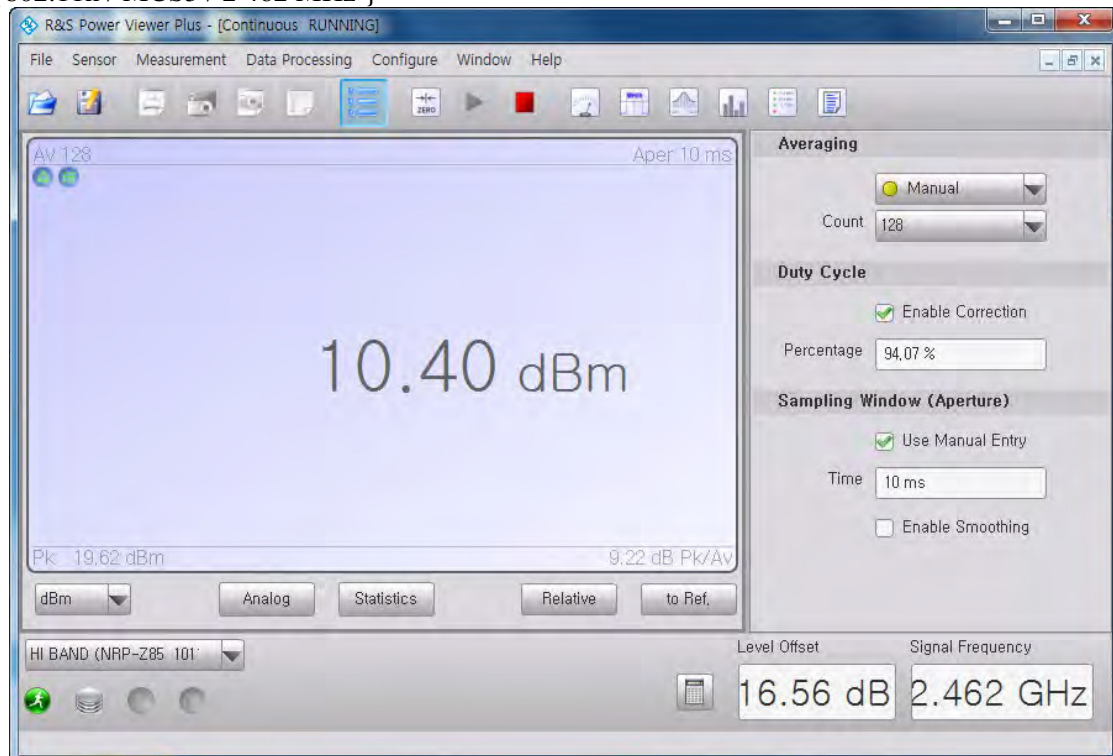

Plot #49{802.11n / MCS4 / 2 412 MHz }

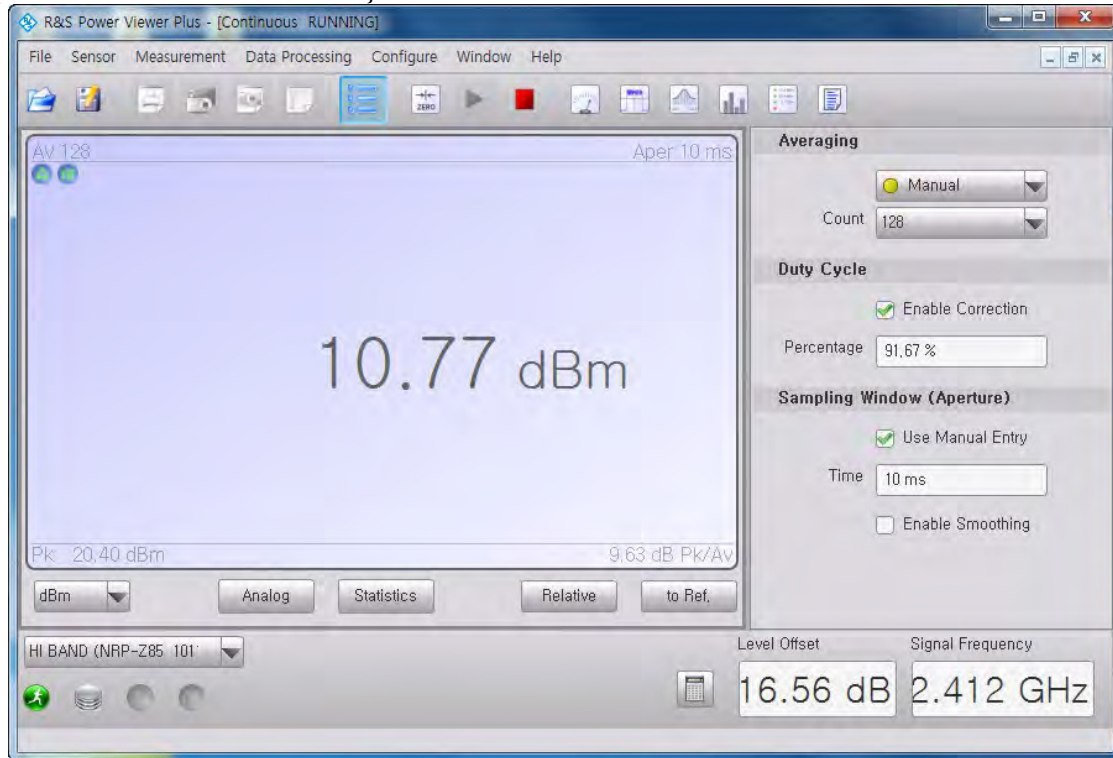

Plot #50{802.11n / MCS4 / 2 437 MHz }

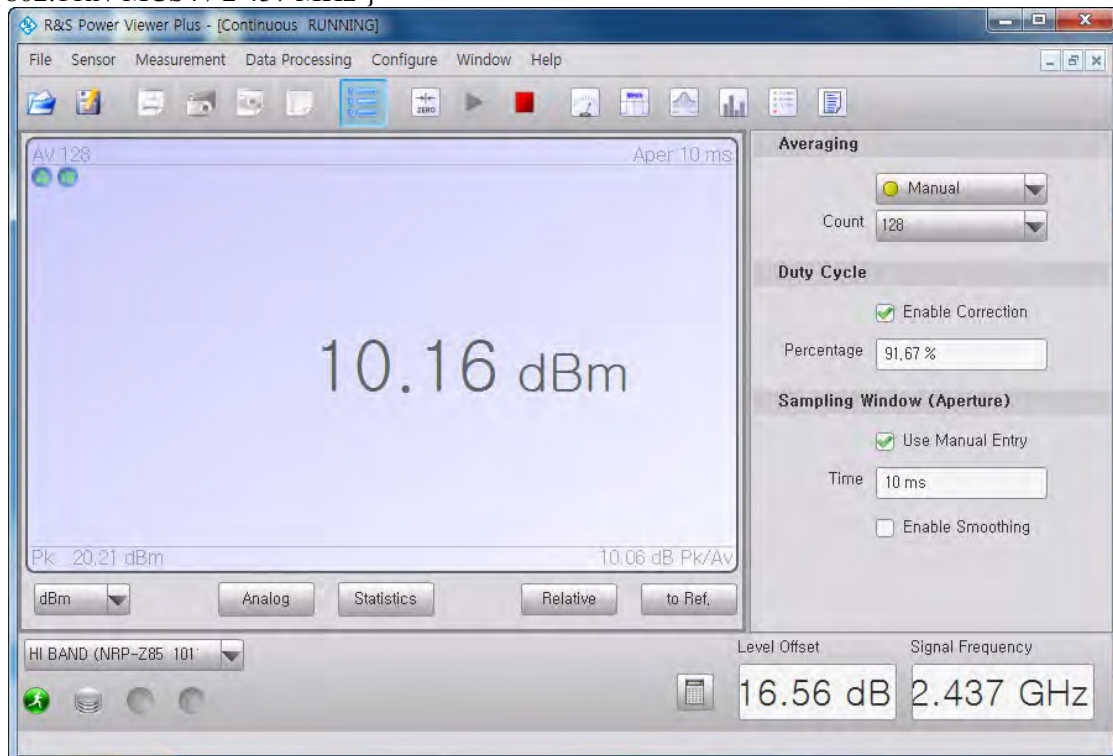

Plot #51 { 802.11n / MCS4 / 2 462 MHz }

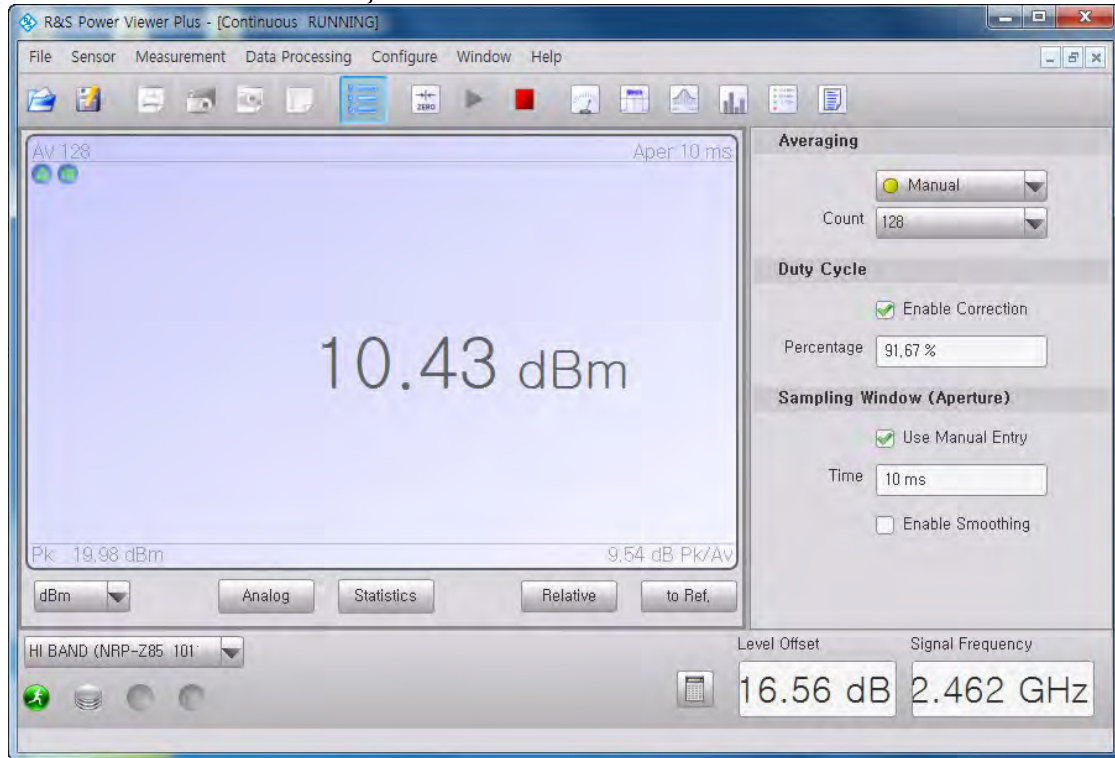

Plot #52 { 802.11n / MCS5 / 2 412 MHz }

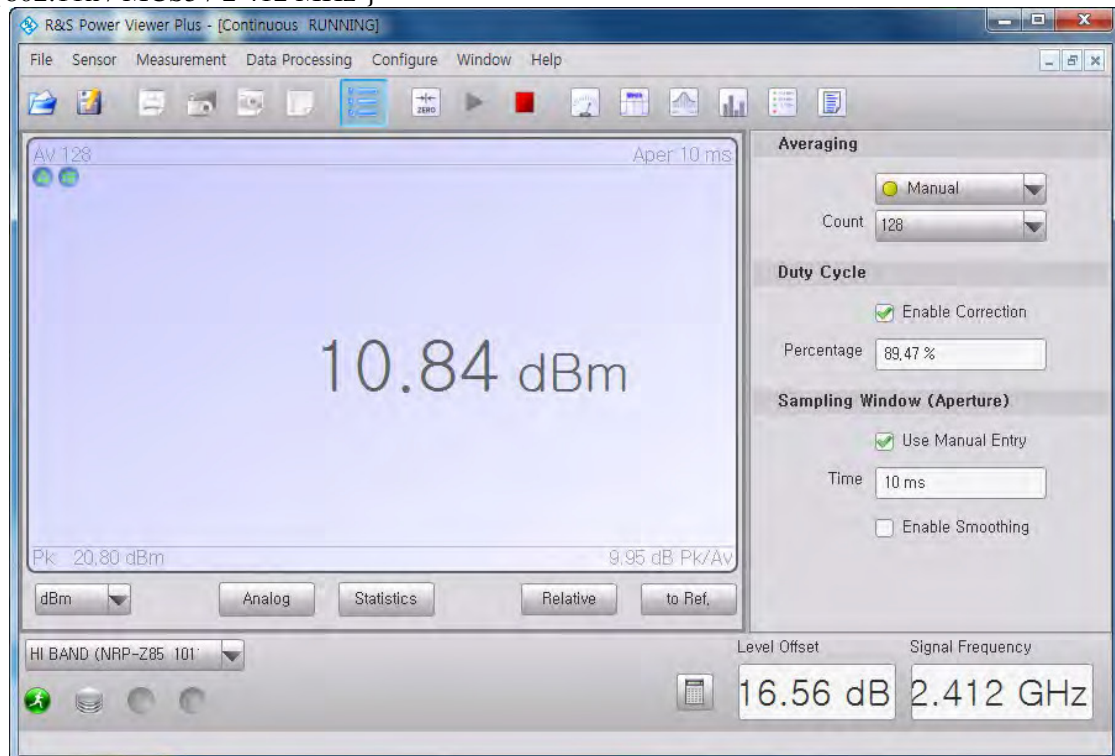

Plot #53{802.11n / MCS5 / 2 437 MHz }

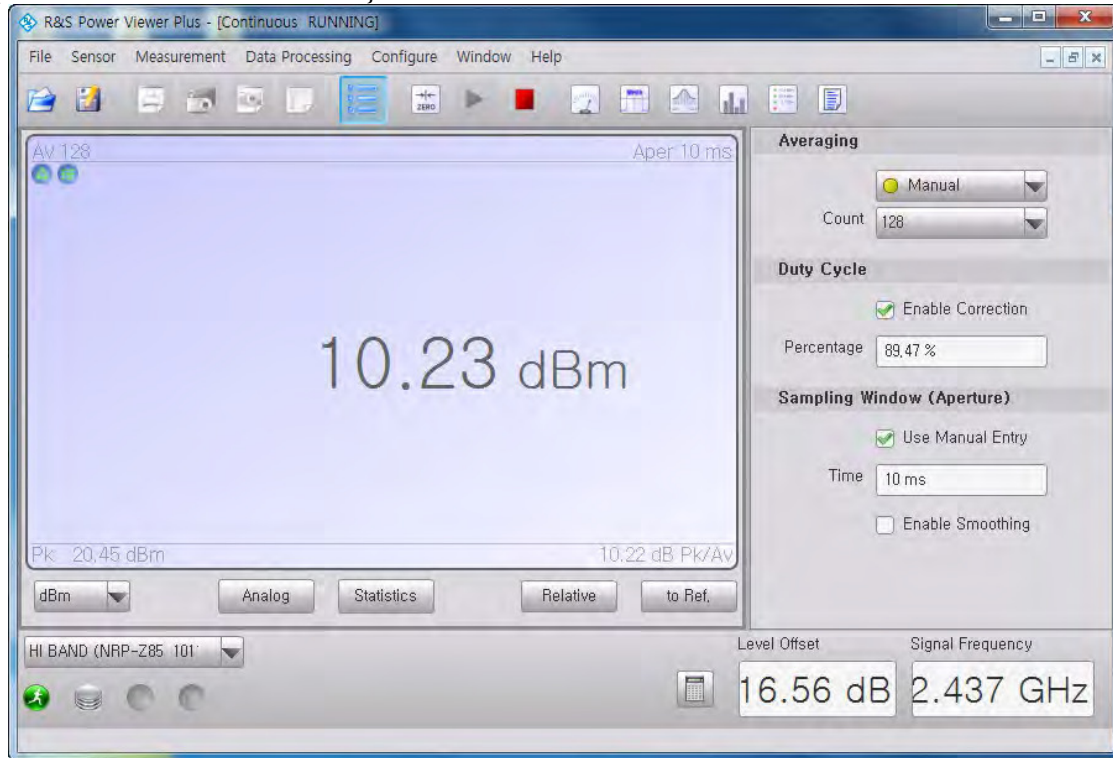

Plot #54{802.11n / MCS5 / 2 462 MHz }

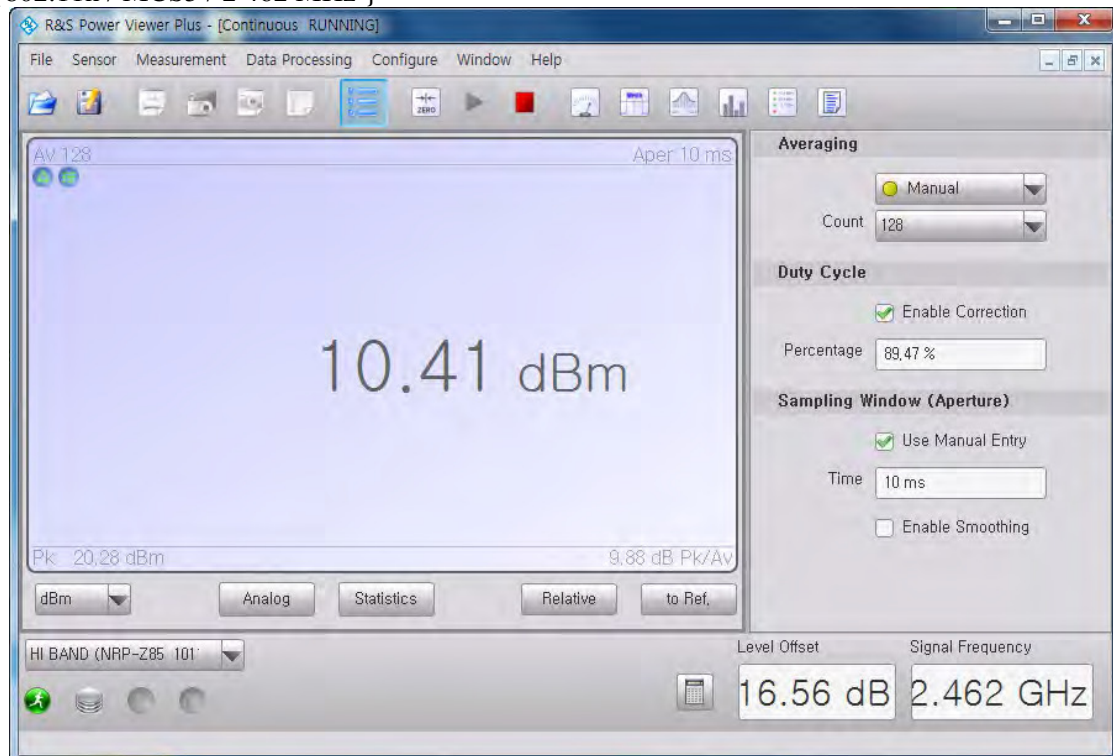

Plot #55{802.11n / MCS6 / 2 412 MHz }

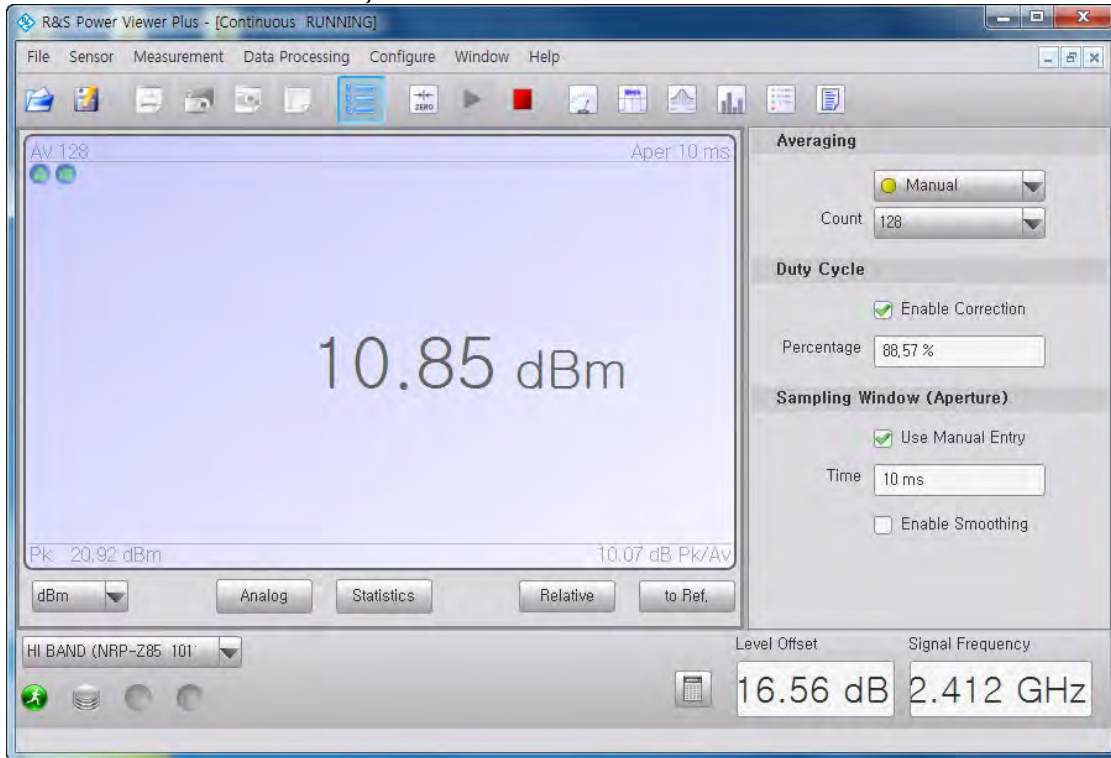

Plot #56{802.11n / MCS6 / 2 437 MHz }

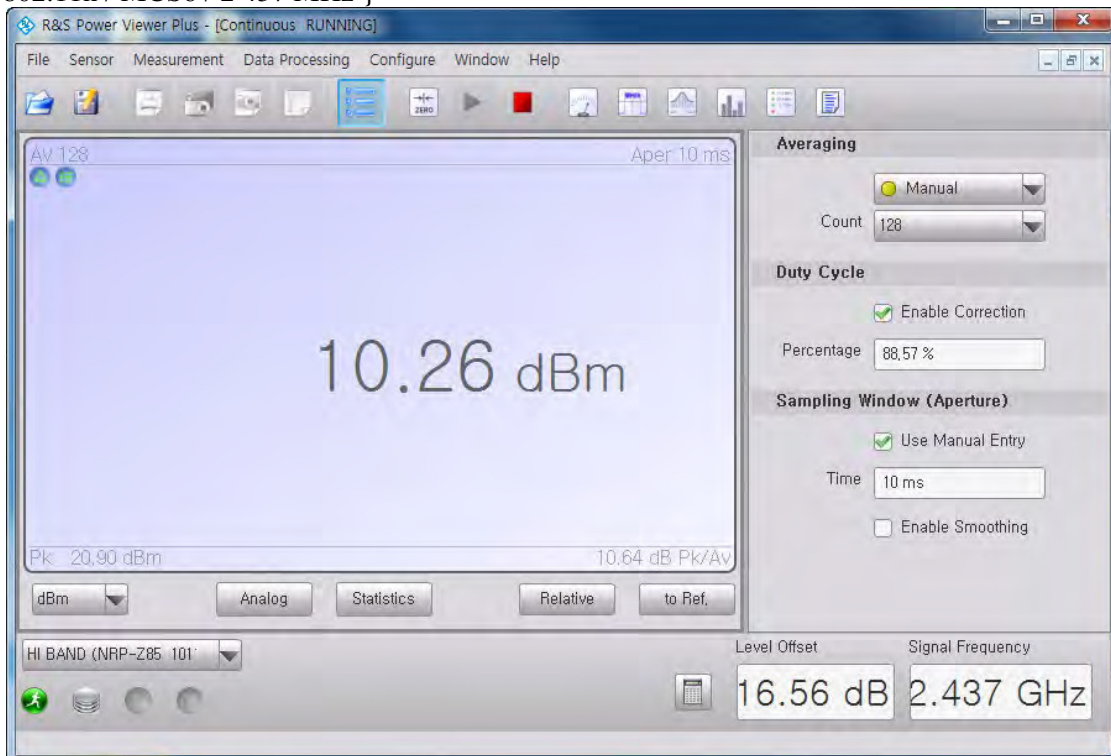

Plot #57{802.11n / MCS6 / 2 462 MHz }

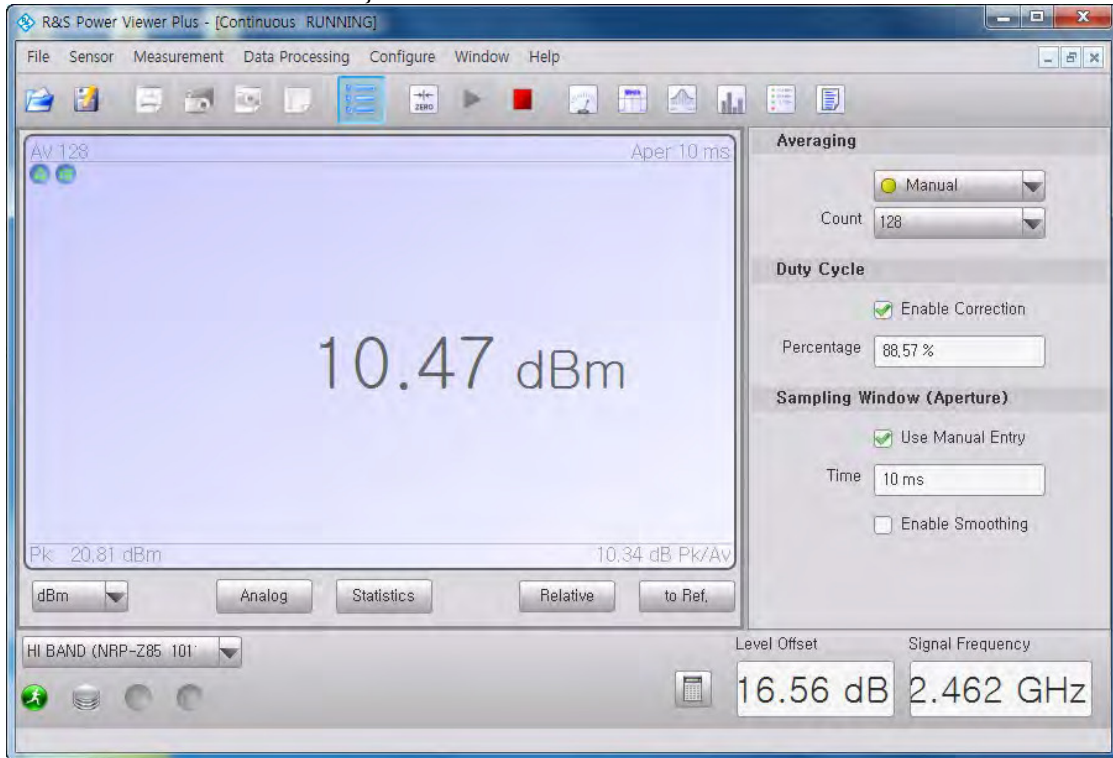

Plot #58{802.11n / MCS7 / 2 412 MHz }

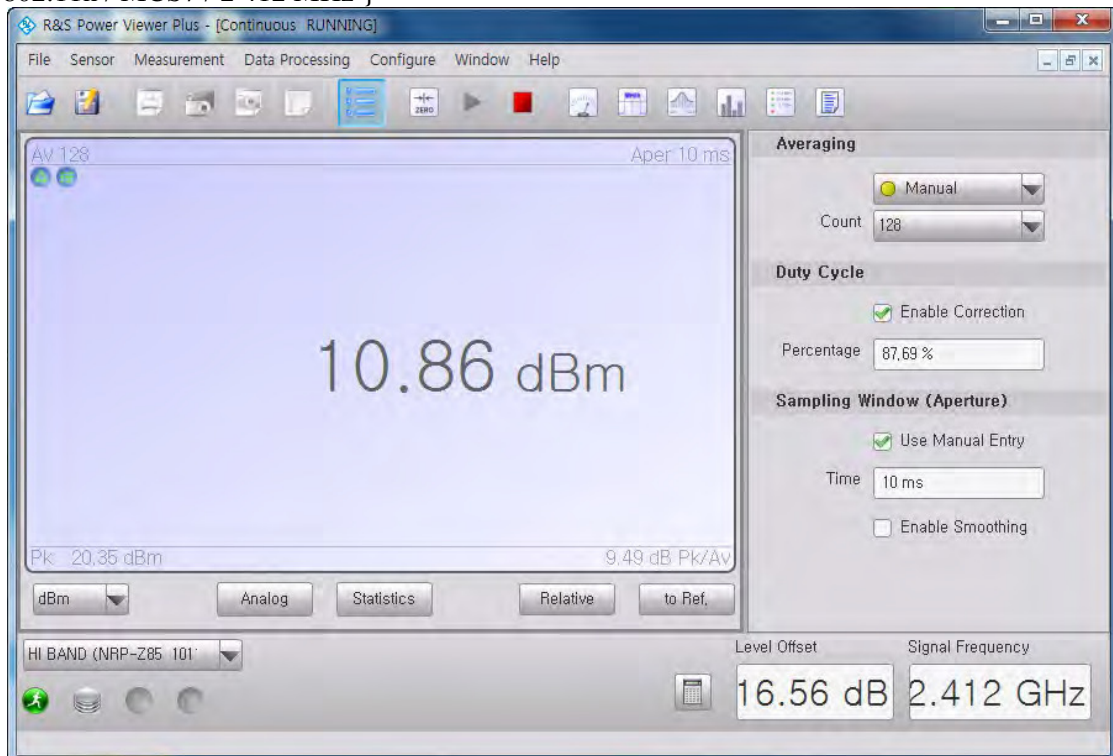

Plot #59{802.11n / MCS7 / 2 437 MHz }

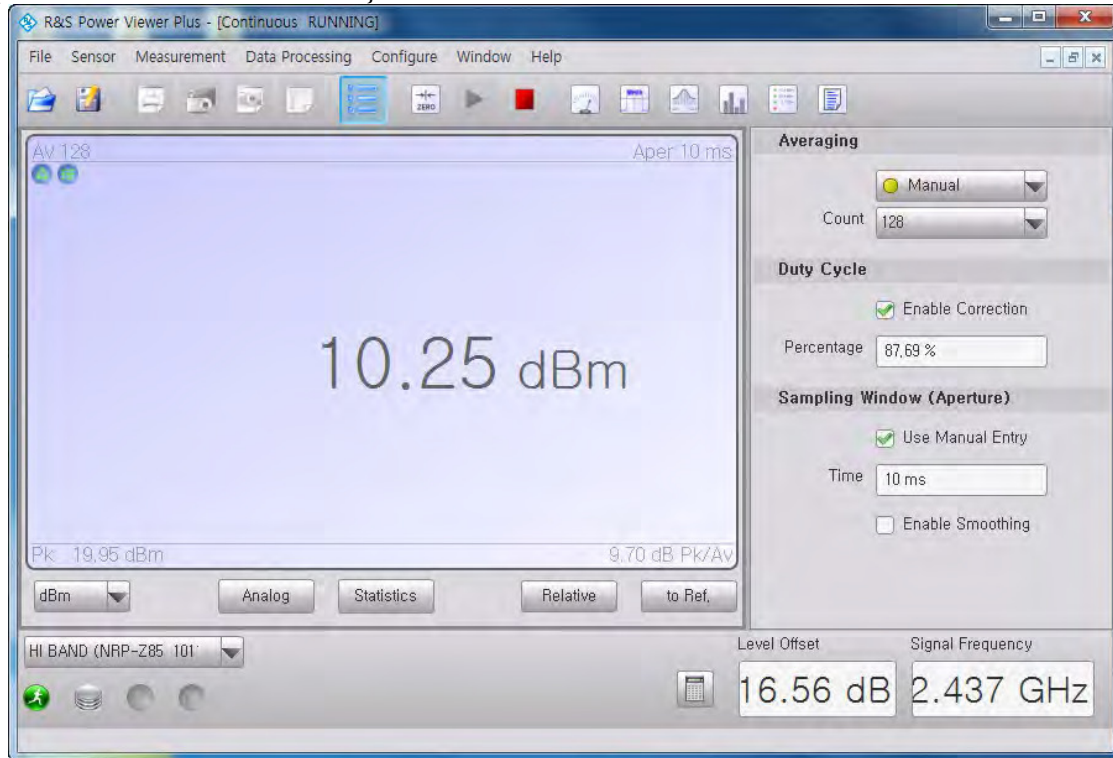

Plot #60{802.11n / MCS7 / 2 462 MHz }

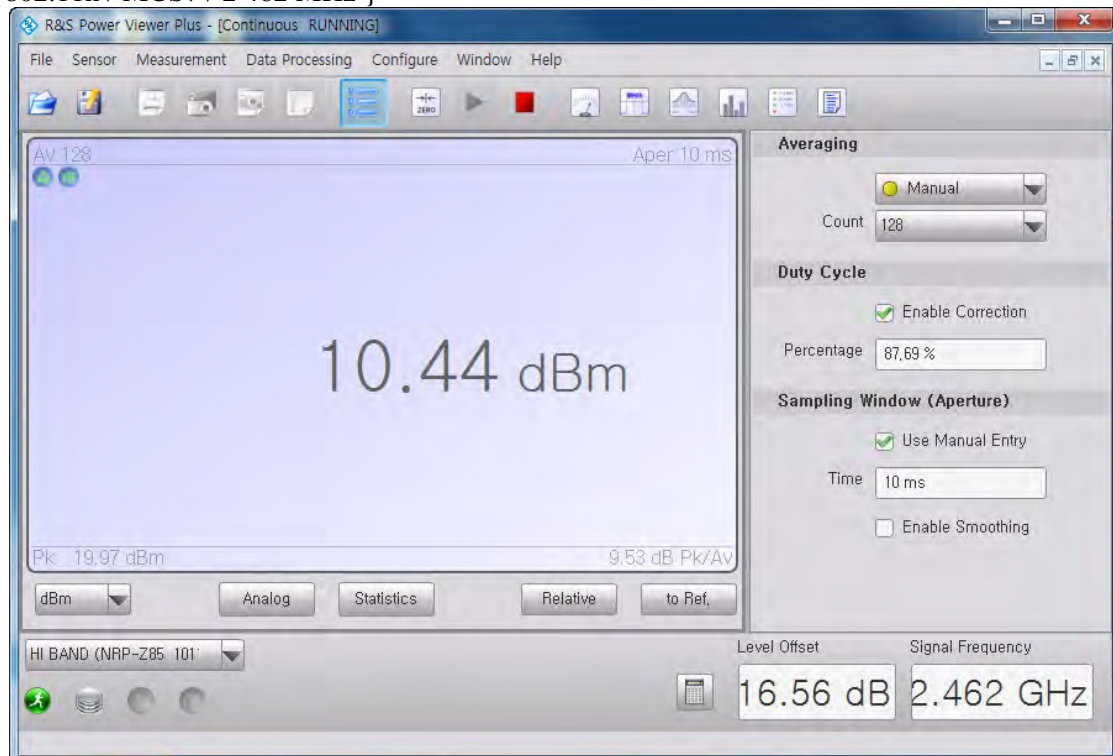

8. Out of Band Emissions / Band Edge

8.1 Definition

specifies that in any 100 kHz bandwidth outside of the authorized frequency band, the power shall be attenuated according to the following conditions:

If the peak output power procedure is used to measure the fundamental emission power to demonstrate compliance to 15.247(b)(3) requirements, then the peak conducted output power measured within any 100 kHz outside the authorized frequency band shall be attenuated by at least 20 dB relative to the maximum measured in-band peak PSD level.

If the average output power procedure is used to measure the fundamental emission power to demonstrate compliance to 15.247(b)(3) requirements, then the power in any 100 kHz outside of the authorized frequency band shall be attenuated by at least 30 dB relative to the maximum measured in-band average PSD level.

In either case, attenuation to levels below the general emission limits specified in §15.209(a) is not required..

8.2 Test Procedure

The transmitter output is connected to the spectrum analyzer. (Procedure 11.0 in of KDB 558074 v03r1)

(1) Reference Level

- a. Set instrument center frequency to DTS channel center frequency.
- b. Set the span to ≥ 1.5 times the DTS bandwidth.
- c. Set RBW = 100 kHz, VBW $\geq 3 \times$ RBW
- d. Detector = peak
- e. Sweep time = auto couple
- f. Trace mode = max hold.
- g. Allow trace to fully stabilize.
- h. Use the peak marker function to determine the maximum PSD level

(2) Unwanted Emissions Level

- a. 9 KHz ~ 30 MHz(Band1), 30MHz ~ 26.5 GHz(Band2) range to be measured.
- b. Set RBW = 100 kHz, VBW $\geq 3 \times$ RBW = 300 KHz
- c. Detector = peak.
- d. Sweep time = auto couple
- e. Trace mode = max hold,
- f. Scan unwanted emissions frequency.
- g. Set the center frequency = worst peak frequency
- h. Set zoom Span ≤ 800 MHz (max sweep point 8192, RBW = 100 KHz)
 - Ensure that the number of measurement points \geq span/RBW
- i. Allow the trace to stabilize (this may take some time, depending on the extent of the span).
- j. Use the peak marker function to determine the maximum amplitude level.

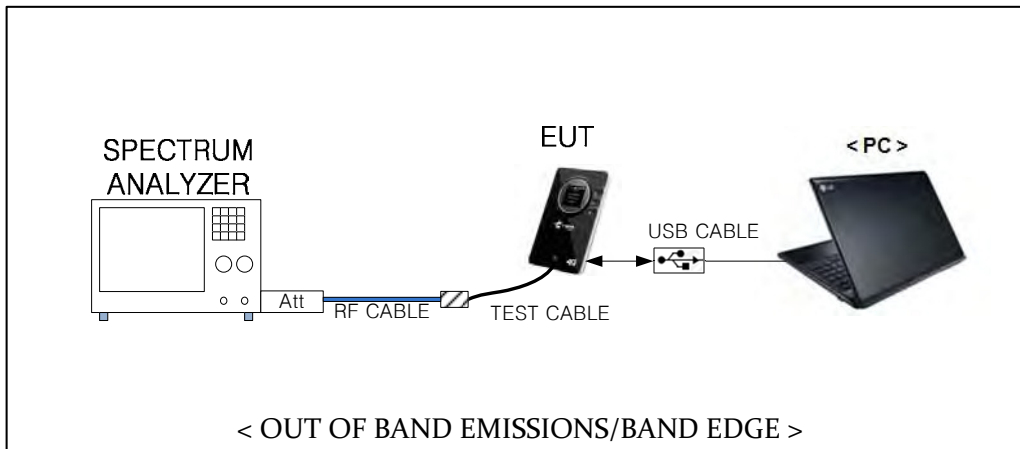

* RF Cable : Radiall / 1800920921500PJ / DC-40 GHz / 1.5m

* Attenuator : 10 dB (Weinshel /56-10/ DC-28 GHz) + 6 dB(Weinshel / 56-6 / DC-28 GHz)

* TEST Cable : Connect WIFI Antenna port (5 cm / SMA connector)

* Path Loss Information

Frequency(MHz)	RF Cable (dB)	10 dB ATT (dB)	6 dB ATT (dB)	Test Cable (dB)	Total Loss (dB)
2 412 ~ 2 462	0.99	9.63	5.64	0.30	16.56

8.3 Test Criteria

At least 20 dB below that in the 100 kHz bandwidth within the band that contains the highest level of the desired power.

8.4 Test Results

8.4.1 mode : 802.11b & 1 Mbps

Mode	Frequency (MHz)	Ref Level(dBm)	Limit(dBm) (Ref - 20 dB)	Measured Freq.(MHz)	Reading (dBm)	Correct (Att, Cable)	Result (dBm)	Margin (dB)
802.11 b	2 412	4.67	-15.33	2 397.00	-40.83	-	-40.83	16.52
				4 824.00	-56.06	+0.49	-55.57	40.24
	2 437	3.82	-16.18	476.34	-60.97	-0.65	-61.62	45.44
	2 612	4.40	-15.60	2 485.84	-67.29	-	-67.29	51.69
				4 924.03	-57.99	+0.50	-57.49	41.89

* Result = Reading + Correct , Margin = Limit – Result

* Plot#1 ~ Plot#14

* Path Loss Information

Frequency (MHz)	RF Cable (dB)	10 dB ATT (dB)	6 dB ATT (dB)	Test Cable (dB)	Total Loss (dB)	Correct (dB) Diff to Offset
476.00	0.45	9.57	5.59	0.30	15.91	-0.65
4 824.00	1.41	9.67	5.67	0.30	17.05	+0.49
4 924.03	1.42	9.67	5.67	0.30	17.06	+0.50

8.4.2 mode : 802.11g & 36 Mbps

Mode	Frequency (MHz)	Ref Level(dBm)	Limit(dBm) (Ref - 20 dB)	Measured Freq.(MHz)	Reading (dBm)	Correct (Att, Cable)	Result (dBm)	Margin (dB)
802.11 g	2 412	1.09	-18.91	2 399.94	-34.21	-	-34.21	15.30
				2 060.22	-61.07	-0.10	-61.17	42.26
	2 437	0.68	-19.32	2 059.93	-53.15	-0.10	-54.25	34.93
	2 612	0.13	-19.87	2 483.68	-46.67	-	-46.67	26.80
				2 048.58	-47.18	-0.10	-47.28	27.41

* Result = Reading + Correct , Margin = Limit – Result

* Plot#15 ~ Plot#28

* Path Loss Information

Frequency (MHz)	RF Cable (dB)	10 dB ATT (dB)	6 dB ATT (dB)	Test Cable (dB)	Total Loss (dB)	Correct (dB) Diff to Offset
2 048.58	0.91	9.62	5.63	0.30	16.46	-0.10
2 059.93	0.91	9.62	5.63	0.30	16.46	-0.10
2 060.22	0.91	9.62	5.63	0.30	16.46	-0.10

8.4.3 mode : 802.11n & MCS6

Mode	Frequency (MHz)	Ref Level(dBm)	Limit(dBm) (Ref - 20 dB)	Measured Freq.(MHz)	Reading (dBm)	Correct (Att, Cable)	Result (dBm)	Margin (dB)
802.11 n	2 412	-0.33	-20.33	2 399.52	-32.66	-	-32.66	12.33
				2 049.37	-43.50	-0.10	-43.60	23.27
	2 437	-0.68	-20.68	2 049.27	-43.59	-0.10	-43.69	23.01
	2 612	-0.37	-20.37	2 483.62	-45.64	-	-45.64	25.27
				2 048.68	-45.46	-0.10	-45.56	25.19

* Result = Reading + Correct , Margin = Limit – Result

* Plot#29 ~ Plot#42

* Path Loss Information

Frequency (MHz)	RF Cable (dB)	10 dB ATT (dB)	6 dB ATT (dB)	Test Cable (dB)	Total Loss (dB)	Correct (dB) Diff to Offset
2 048.68	0.91	9.62	5.63	0.30	16.46	-0.10
2 049.27	0.91	9.62	5.63	0.30	16.46	-0.10
2 049.37	0.91	9.62	5.63	0.30	16.46	-0.10

8.5 Test Plots

Plot #1 Reference Level {802.11b / 1 Mbps / 2.412 MHz}

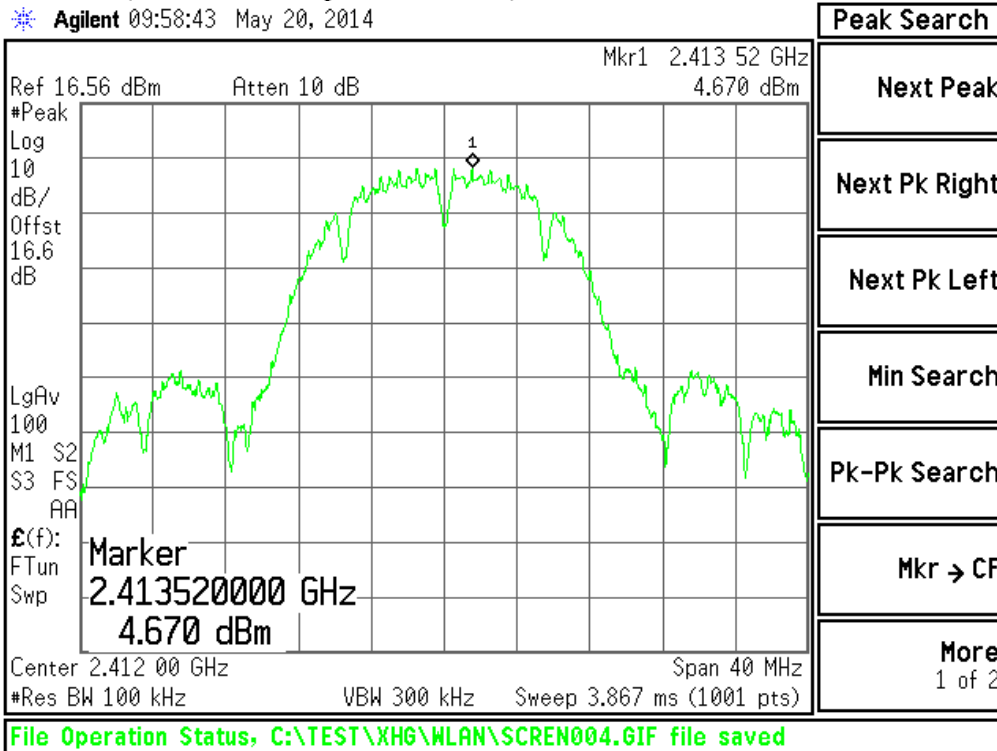

Plot #2 Band Edge {802.11b / 1 Mbps / 2.412 MHz}I

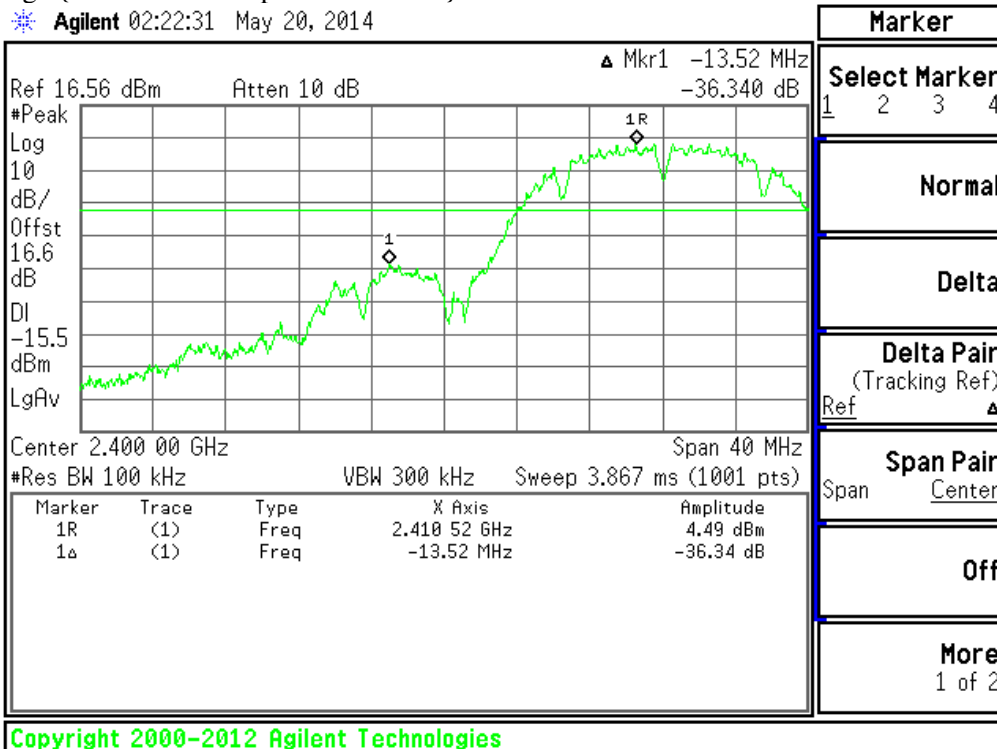

Plot #3 Out of Band 1 {802.11b / 1 Mbps / 2 412 MHz}

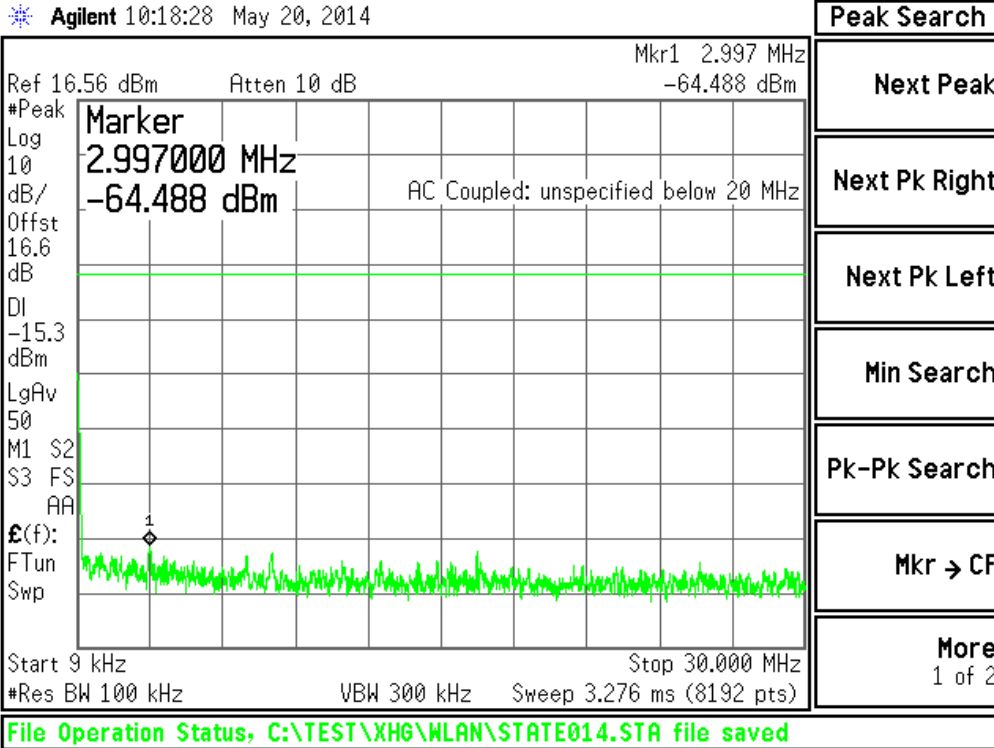

Plot #4 Out of Band 2 {802.11b / 1 Mbps / 2 412 MHz}

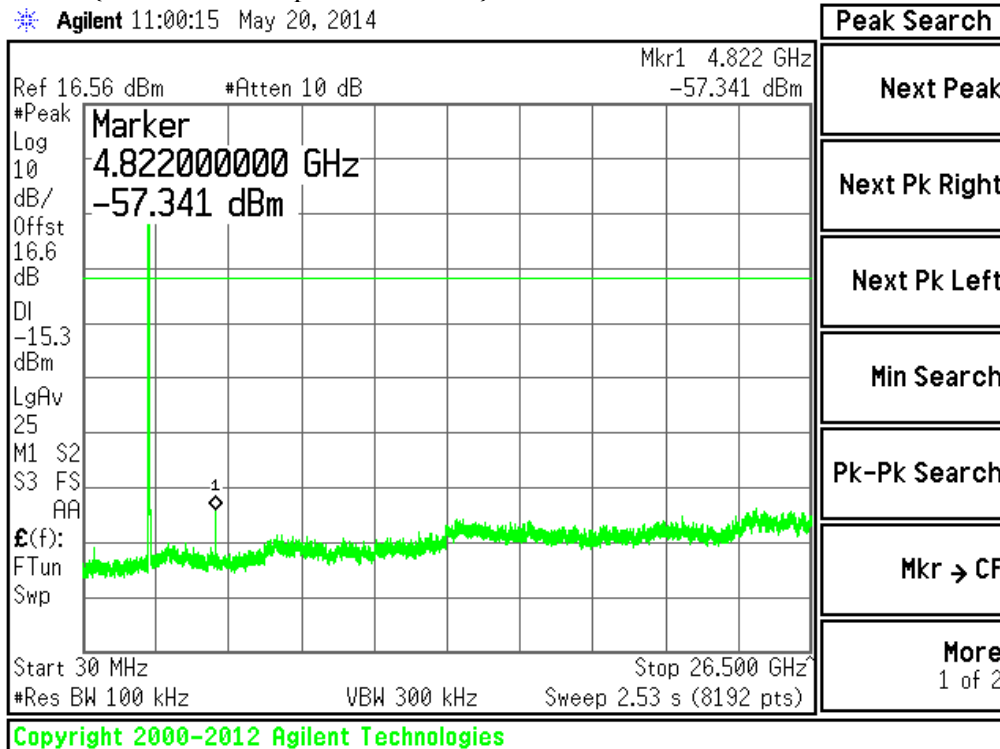

Plot #5 Out of Band Zoom{802.11b / 1 Mbps / 2.412 MHz}

Agilent 11:01:00 May 20, 2014

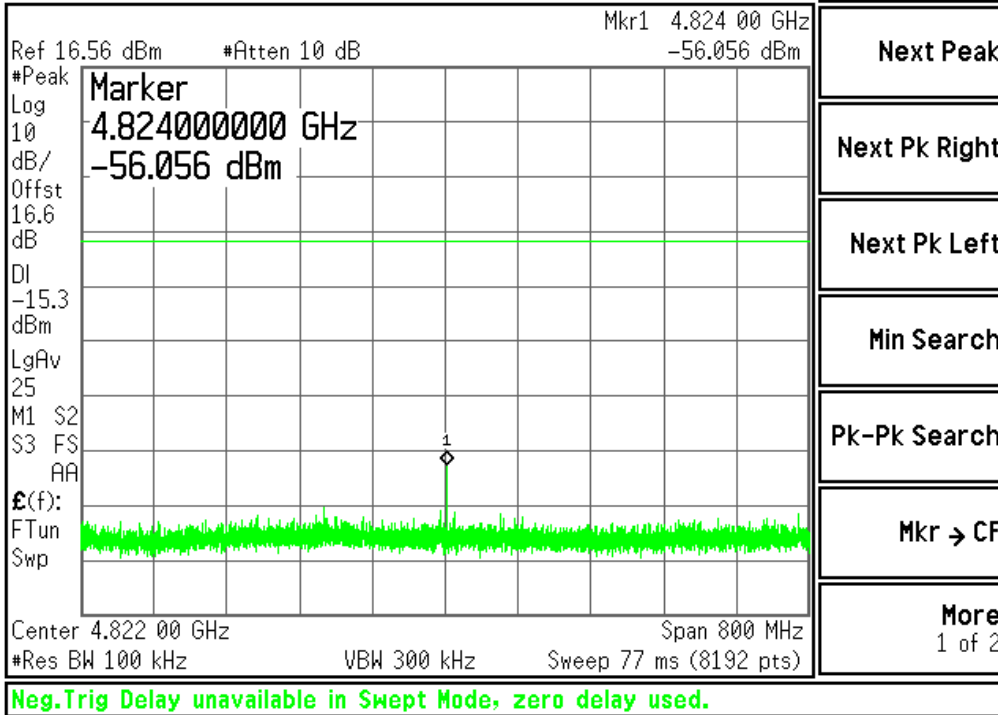

Peak Search
Next Peak
Next Pk Right
Next Pk Left
Min Search
Pk-Pk Search
Mkr → CF
More 1 of 2

Plot #6 Reference Level {802.11b / 1 Mbps / 2 437 MHz}

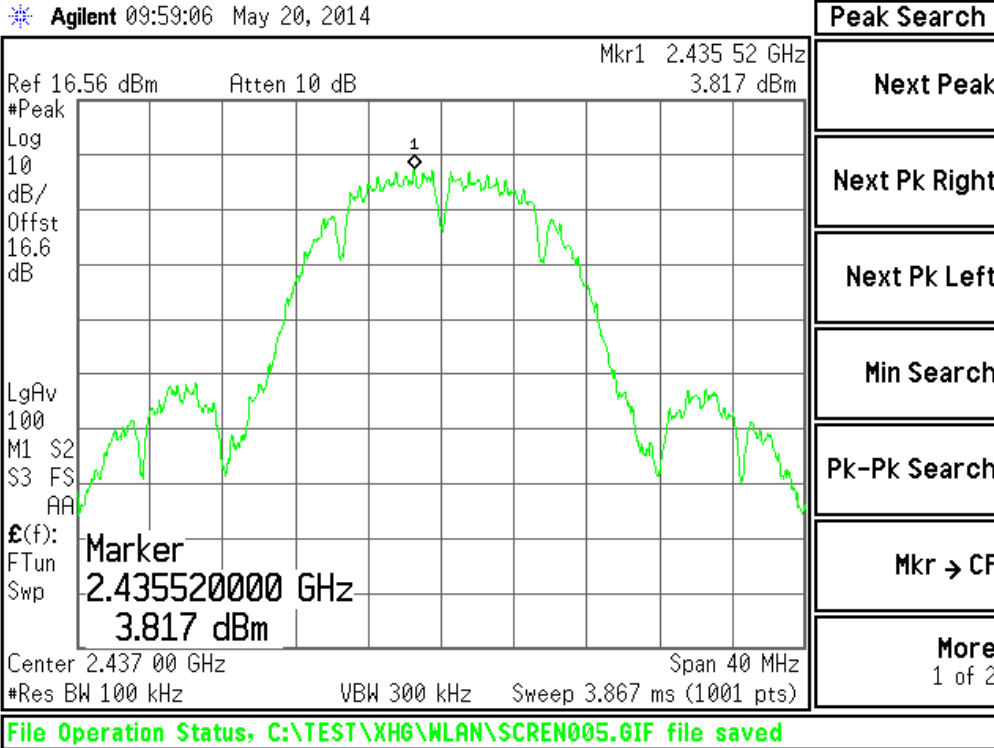

Plot #7 Out of Band 1 {802.11b / 1 Mbps / 2 437 MHz}

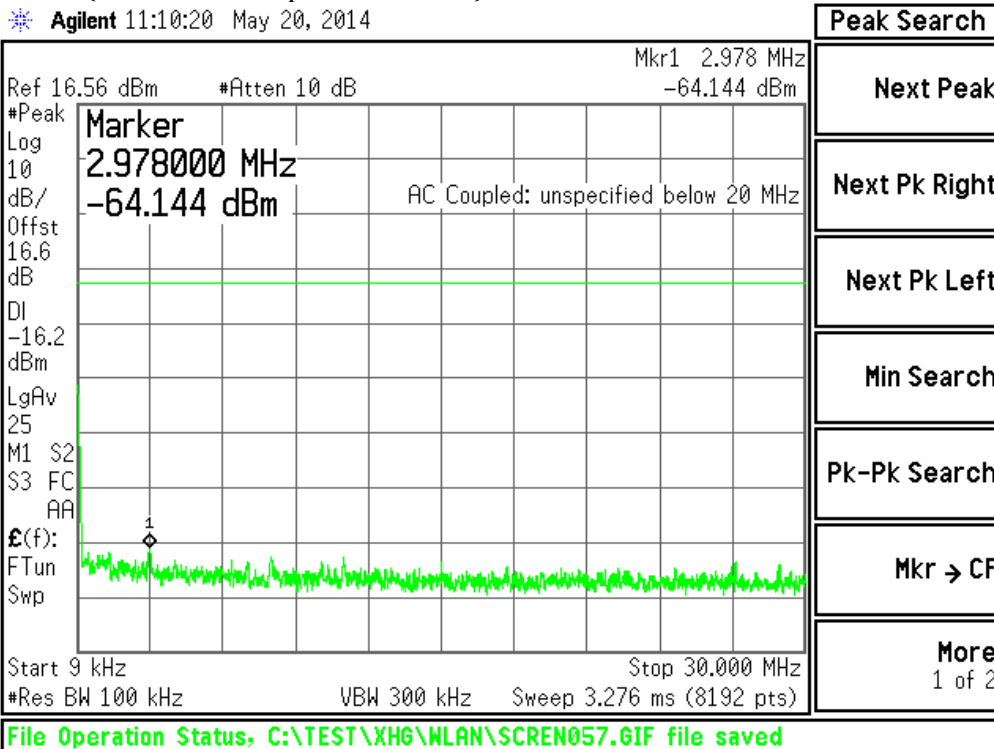

Plot #8 Out of Band 2{802.11b / 1 Mbps / 2 437 MHz}

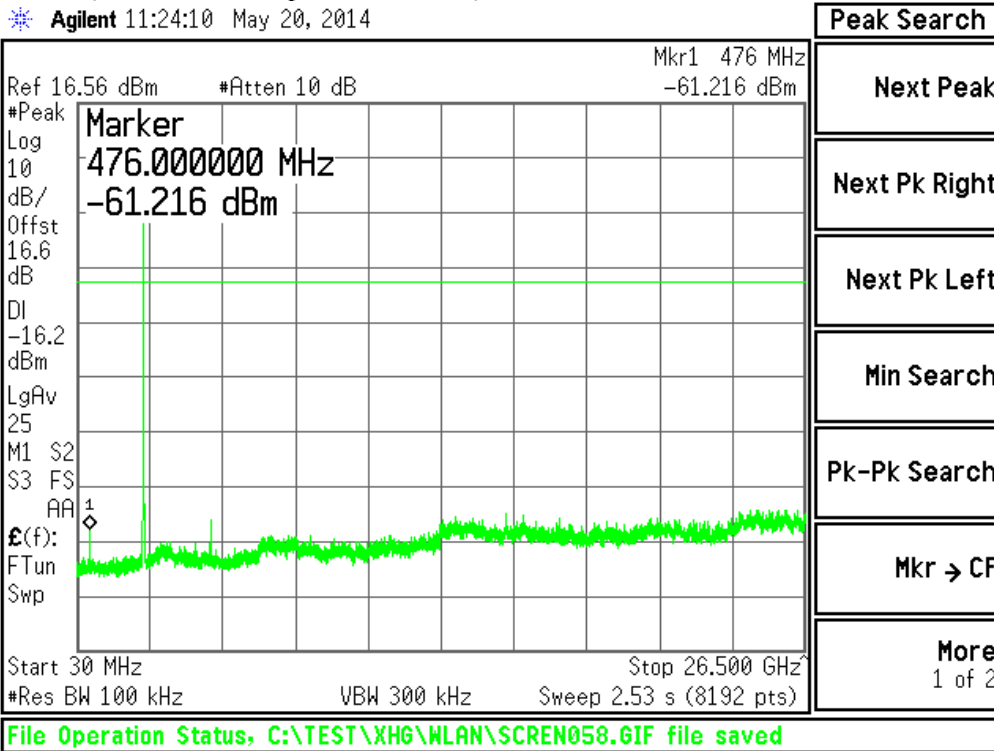

Plot #9 Out of Band Zoom{802.11b / 1 Mbps / 2 437 MHz}

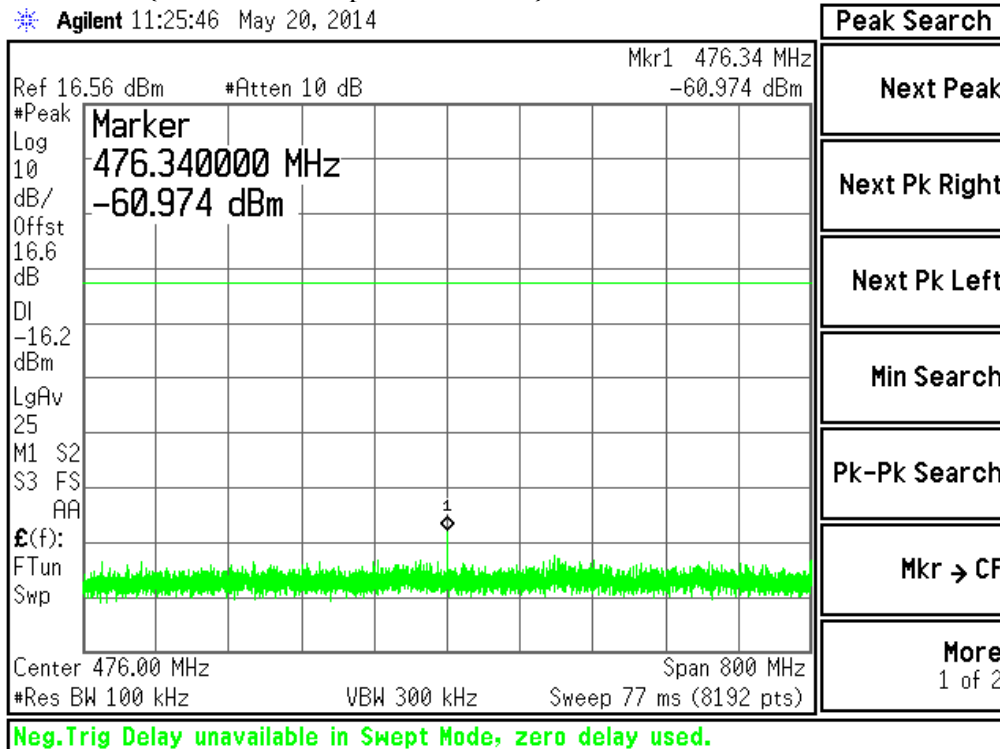

Plot #10 Reference Level {802.11b / 1 Mbps / 2 462 MHz}

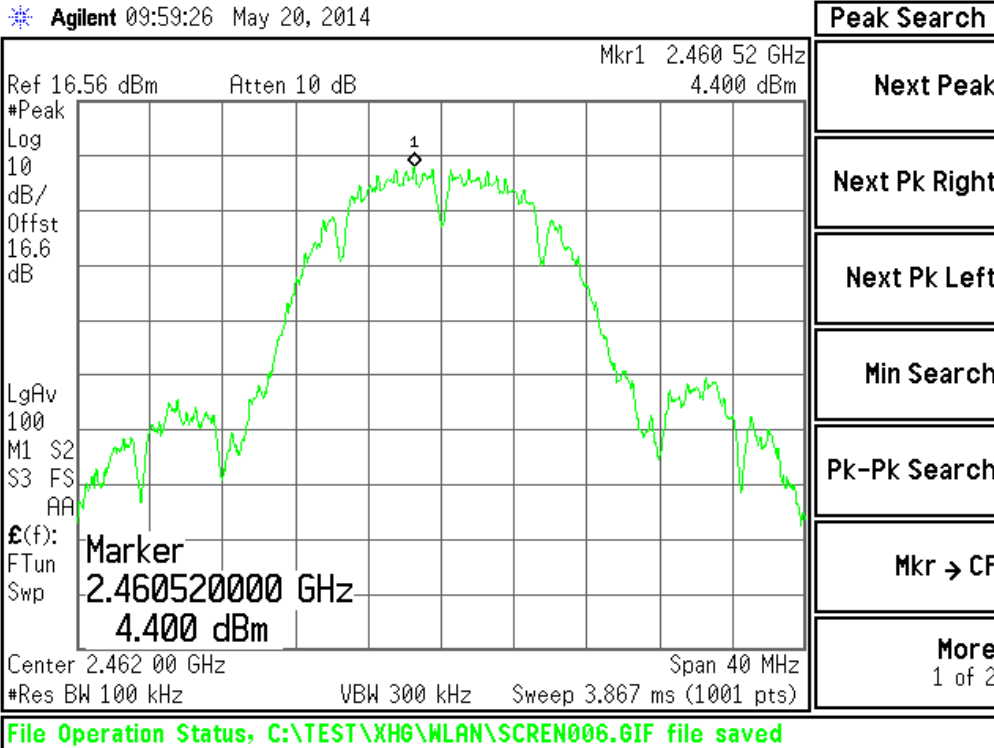

Plot #11 Band Edge {802.11b / 1 Mbps / 2 462 MHz}I

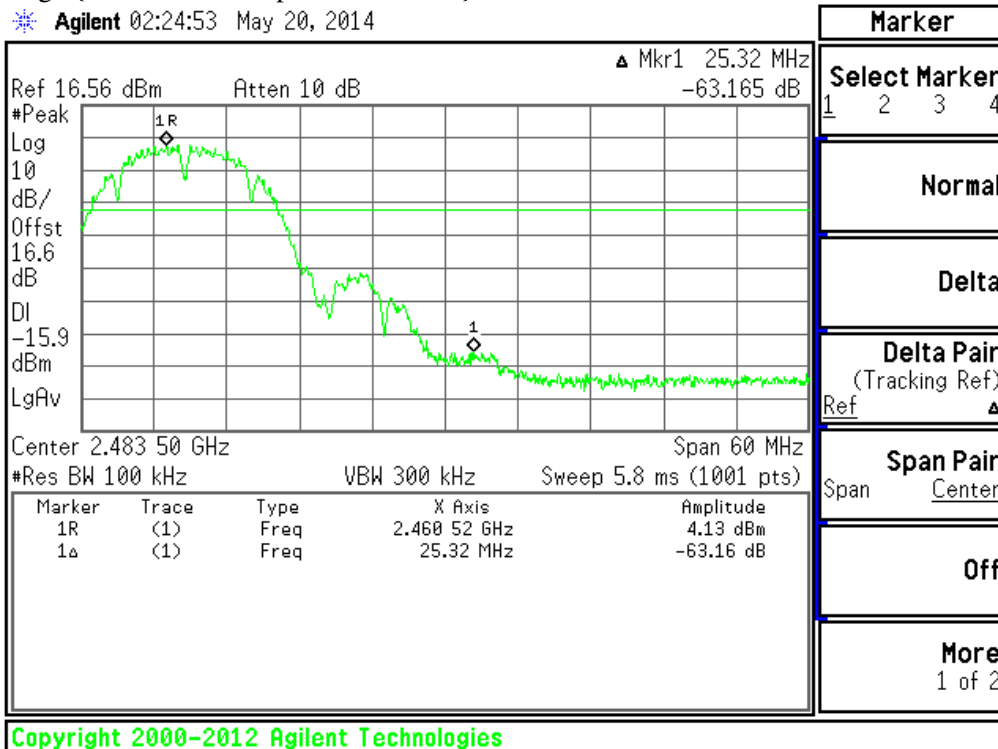

Plot #12 Out of Band 1{802.11b / 1 Mbps / 2 462 MHz}

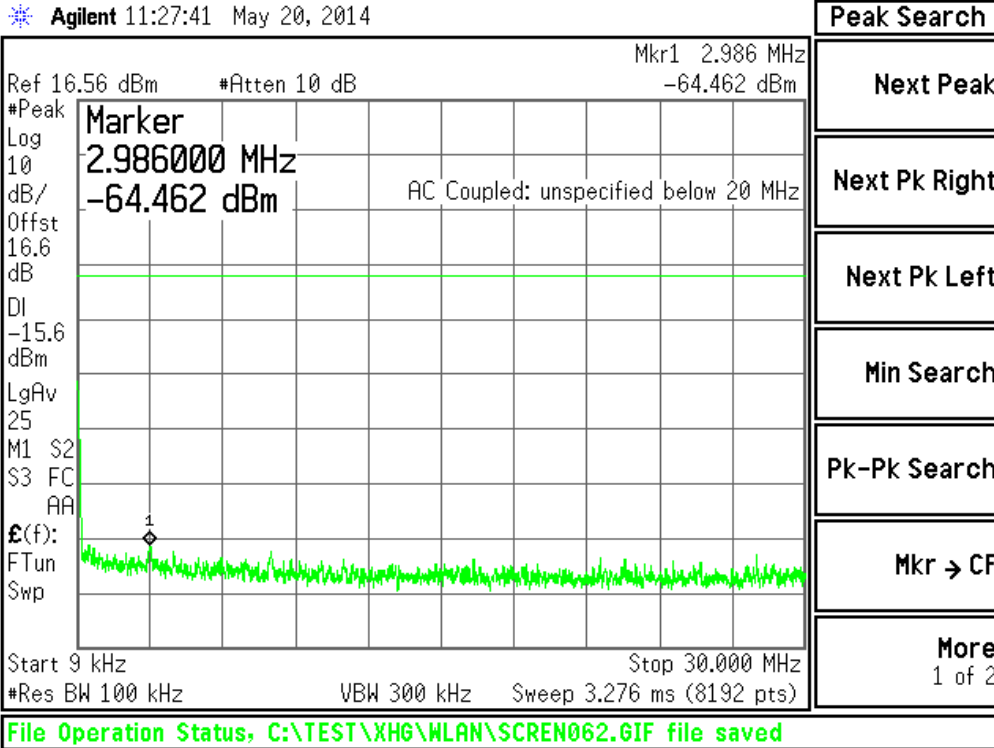

Plot #13 Out of Band 2{802.11b / 1 Mbps / 2 462 MHz}

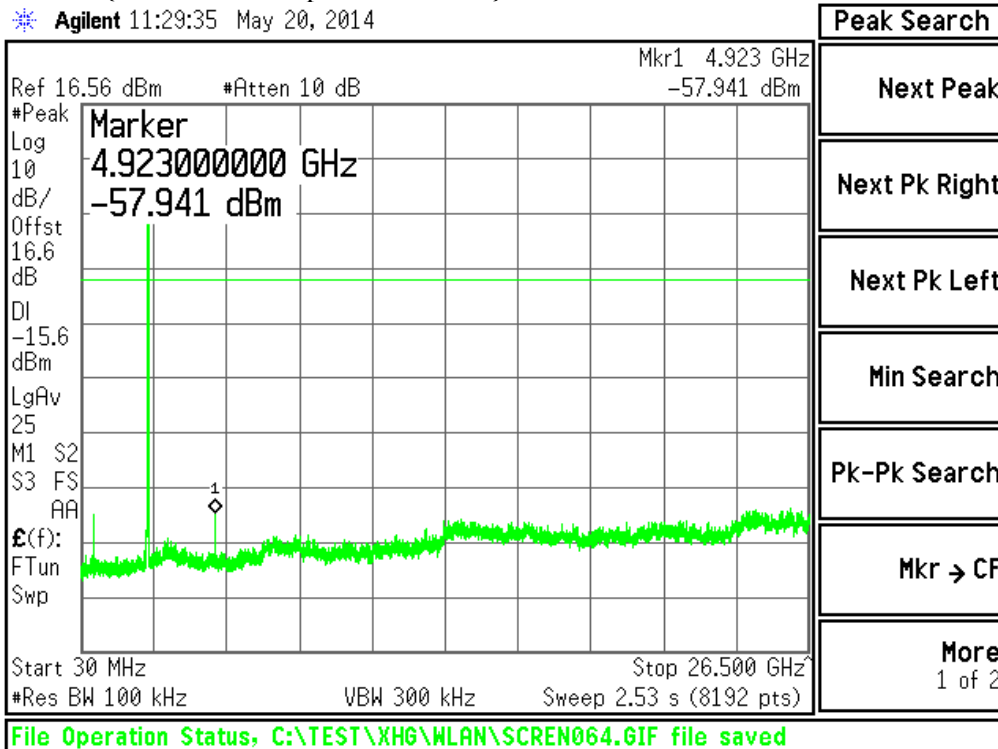

Plot #14 Out of Band Zoom{802.11b / 1 Mbps / 2 462 MHz}

Agilent 11:30:50 May 20, 2014

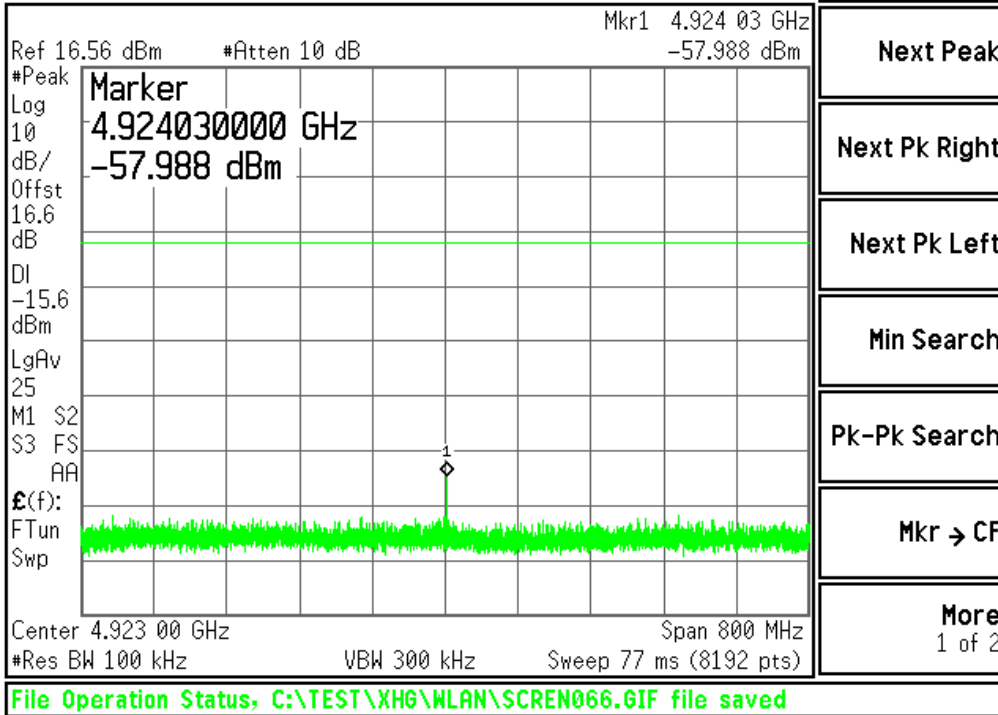

Peak Search
Next Peak
Next Pk Right
Next Pk Left
Min Search
Pk-Pk Search
Mkr → CF
More 1 of 2

Plot #15 Reference Level {802.11g / 36 Mbps / 2 412 MHz}

Agilent 10:00:26 May 20, 2014

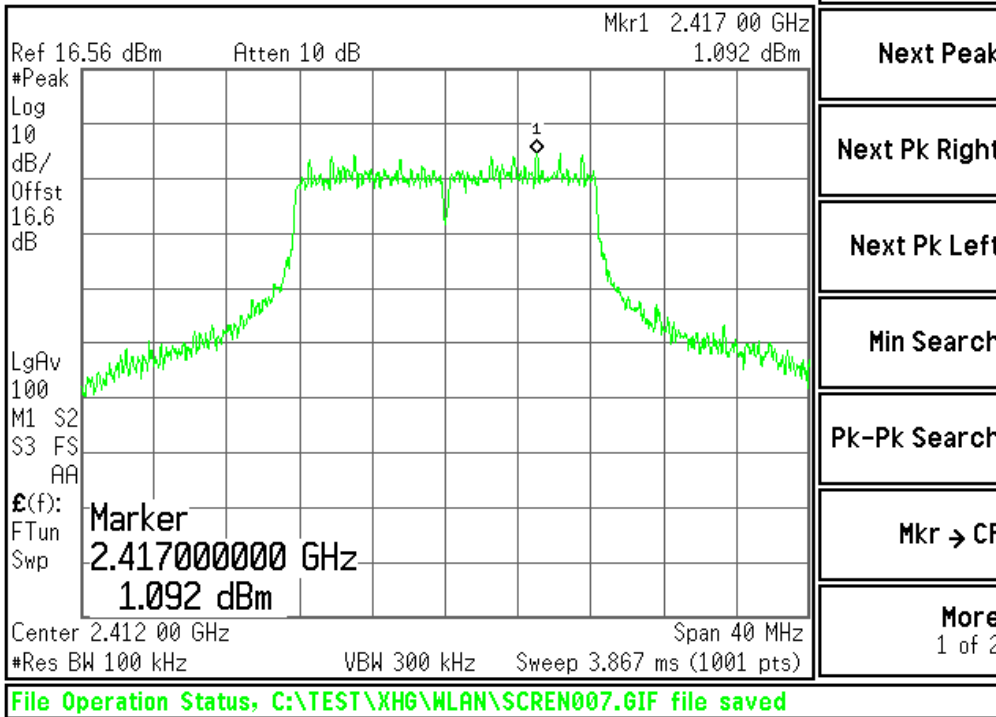

Plot #16 Band Edge {802.11g / 36 Mbps / 2 412 MHz}

Agilent 02:30:41 May 20, 2014

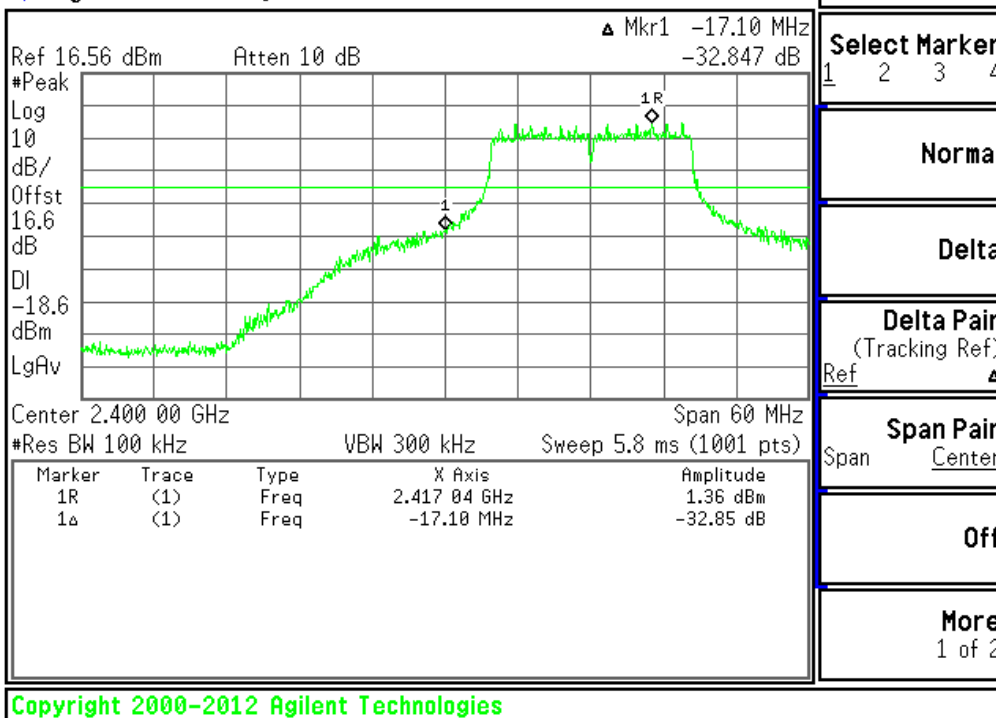

Plot #17 Out of Band 1{802.11g / 36 Mbps / 2 412 MHz}

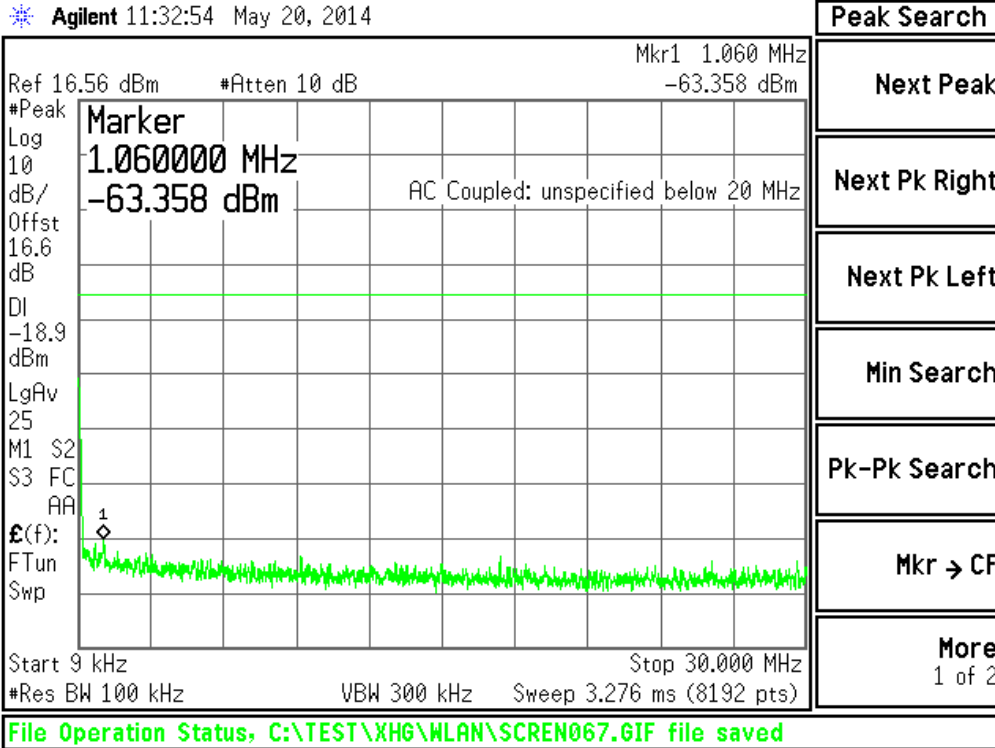

Plot #18 Out of Band 2{802.11g / 36 Mbps / 2 412 MHz}

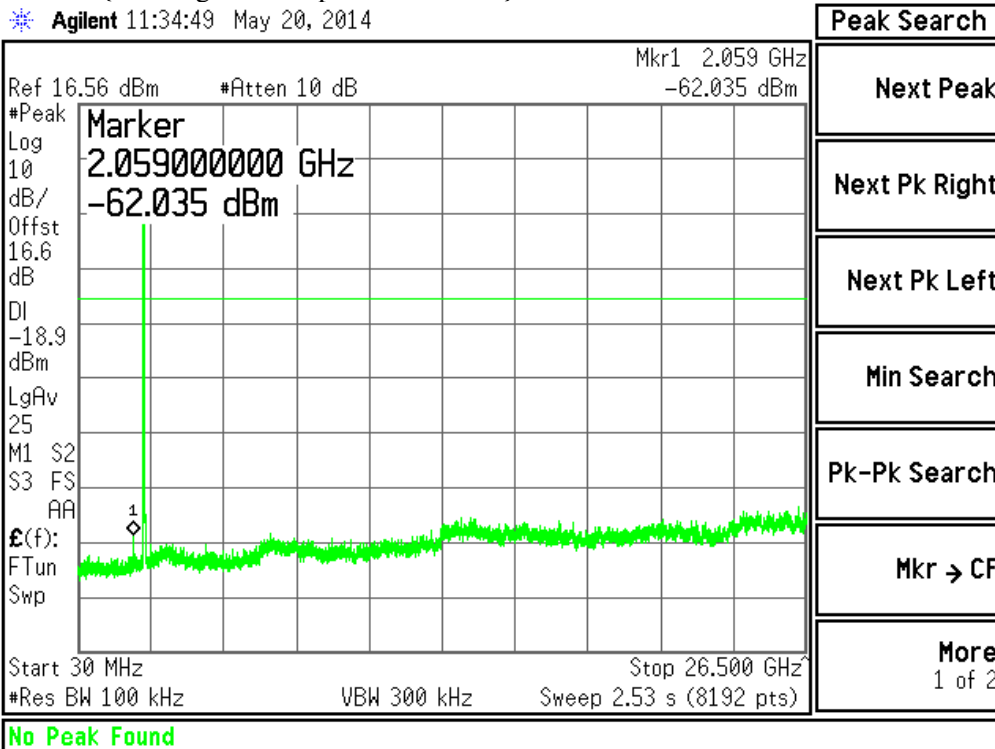

Plot #19 Out of Band Zoom{802.11g / 36 Mbps / 2 412 MHz}

Agilent 11:36:22 May 20, 2014

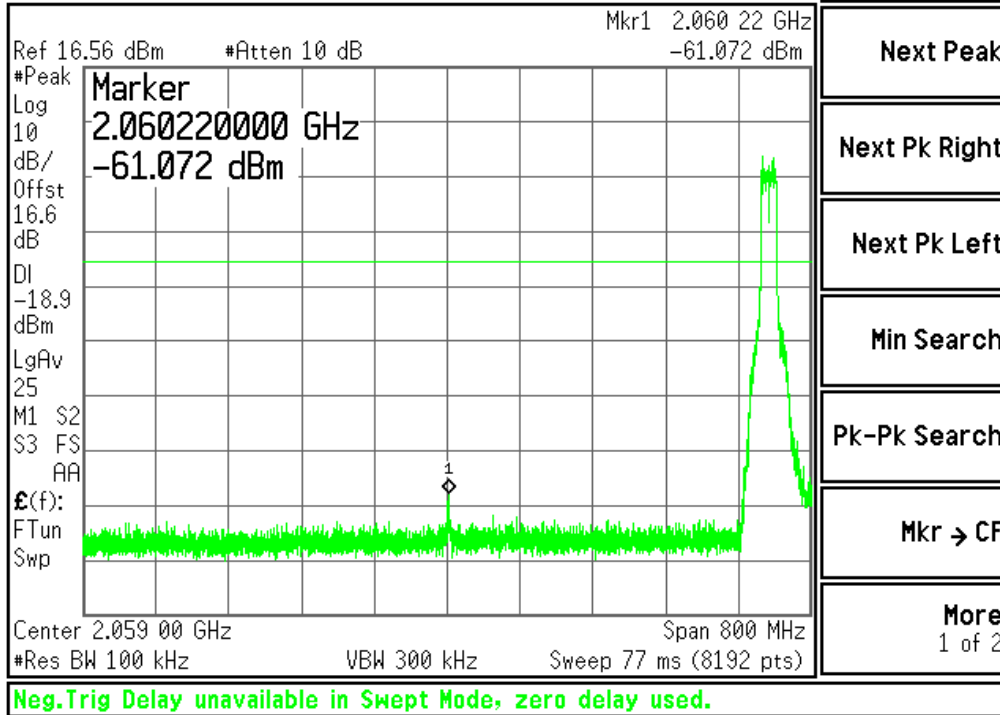

Plot #20 Reference Level {802.11g / 36 Mbps / 2 437 MHz}

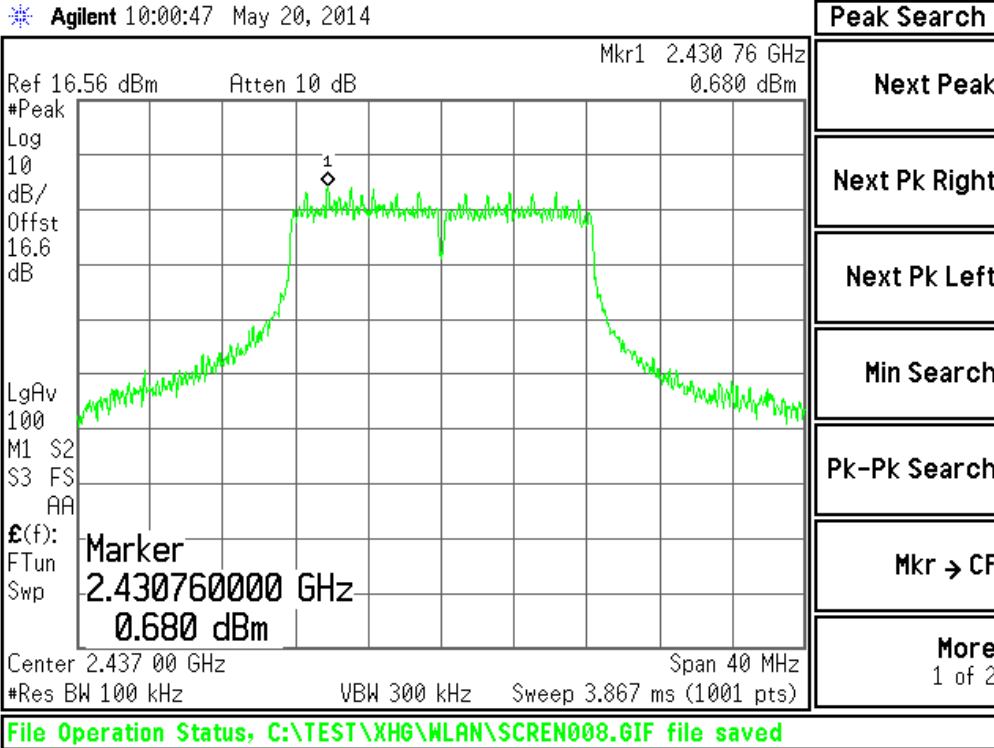

Plot #21 Out of Band 1{802.11g / 36 Mbps / 2 437 MHz}

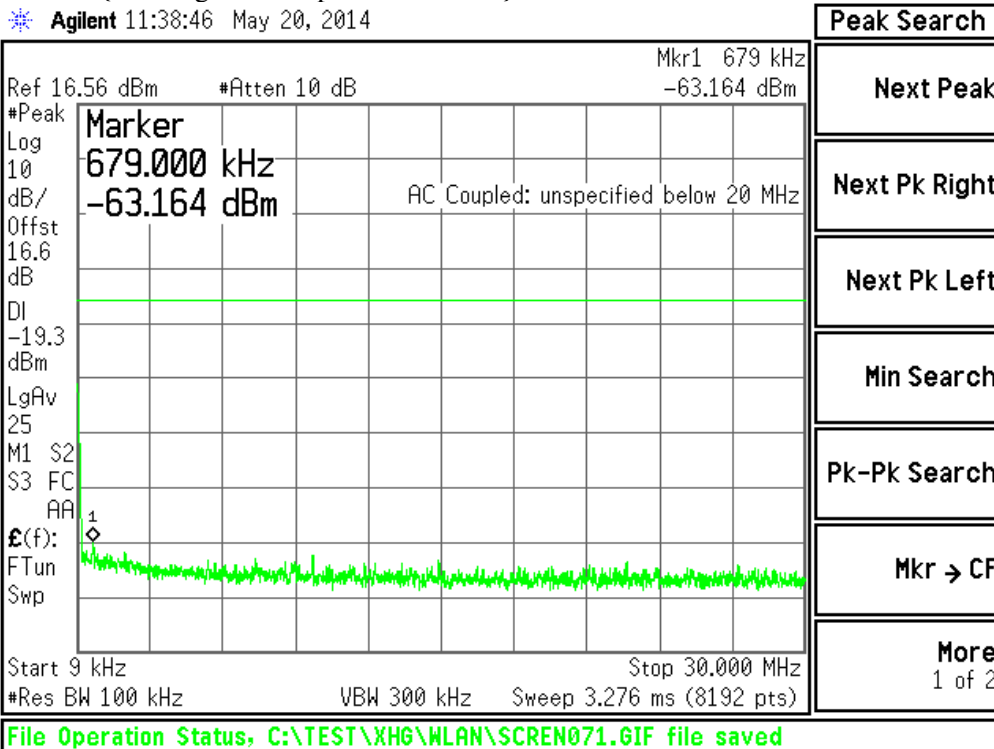

Plot #22 Out of Band 2{802.11g / 36 Mbps / 2 437 MHz}

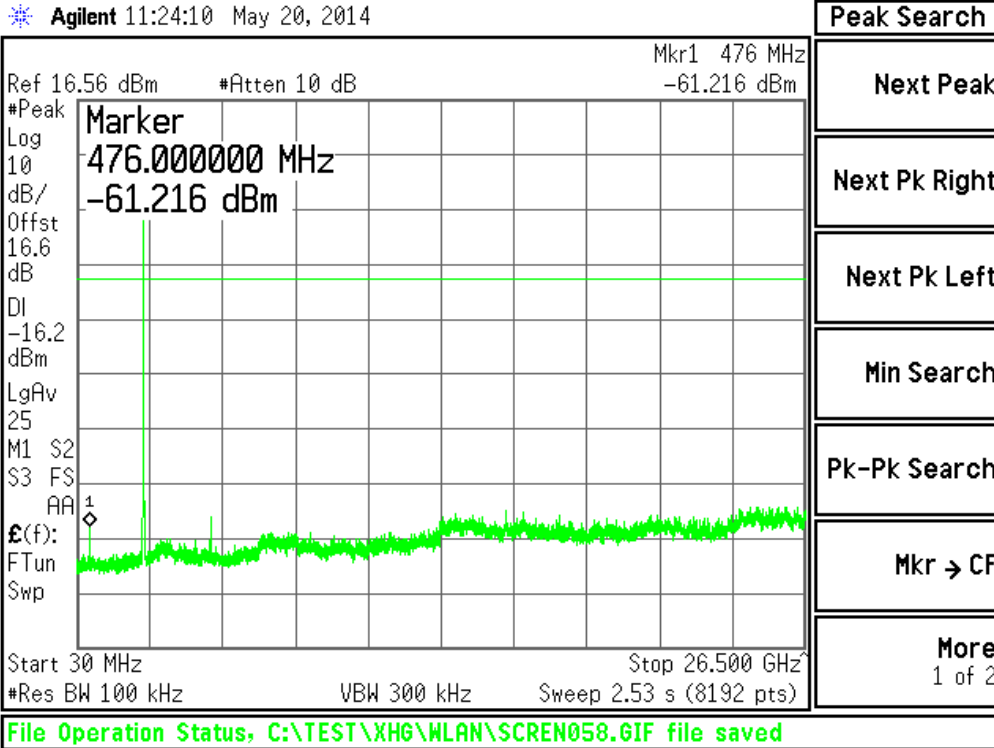

Plot #23 Out of Band Zoom{802.11g / 36 Mbps / 2 437 MHz}

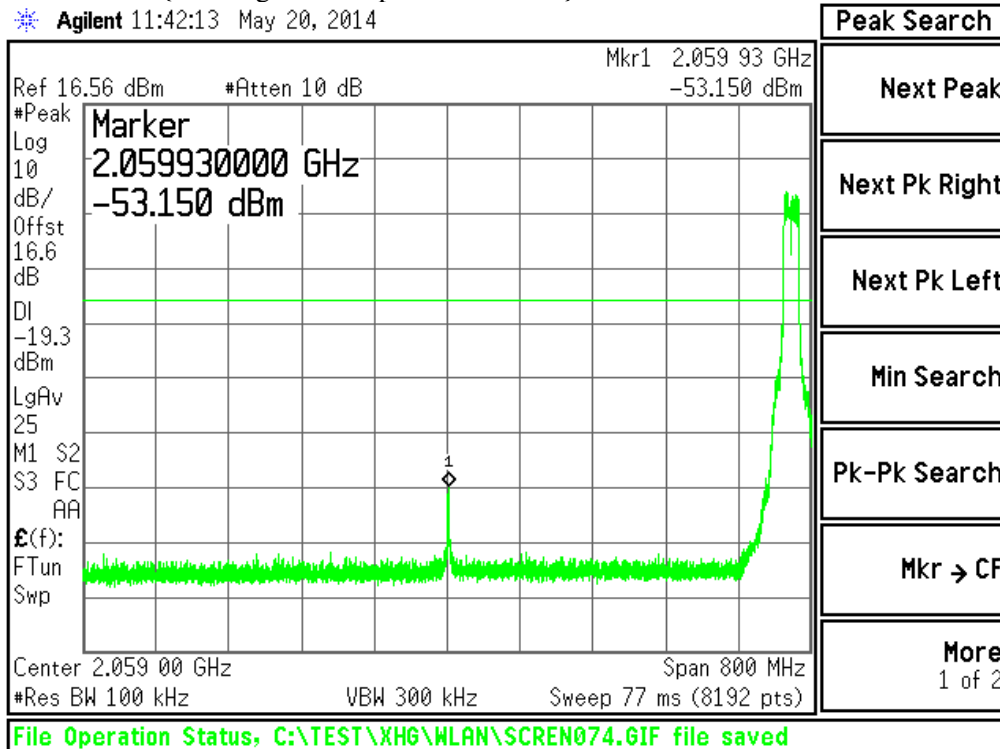

Plot #24 Reference Level {802.11g / 36 Mbps / 2 462 MHz}

Agilent 10:01:09 May 20, 2014

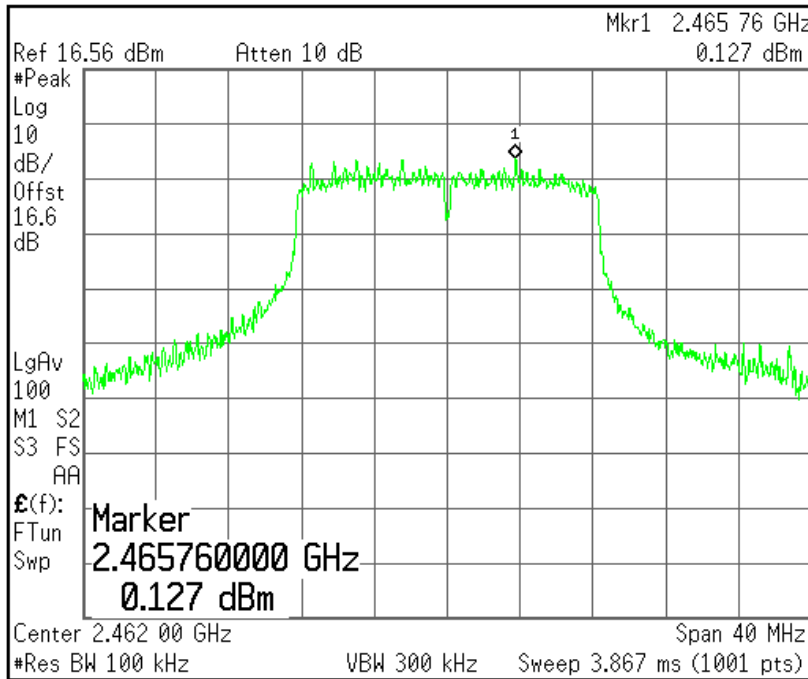

Peak Search

Next Peak

Next Pk Right

Next Pk Left

Min Search

Pk-Pk Search

Mkr → CF

More
1 of 2

File Operation Status, C:\TEST\XHG\WLAN\SCREN009.GIF file saved

Plot #25 Band Edge {802.11g / 36 Mbps / 2 462 MHz}1

Agilent 02:32:23 May 20, 2014

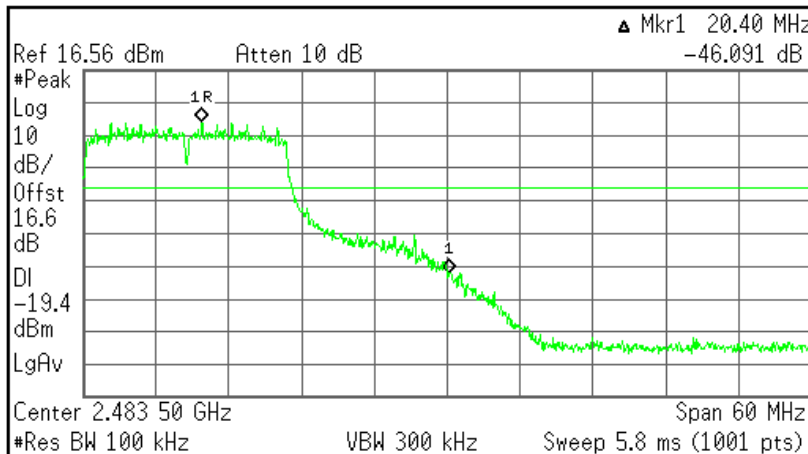

Display

Full Screen

Display Line
-19.42 dBm
On Off

Limits

Active Fctn
Position
Top

Title

Preferences

Copyright 2000-2012 Agilent Technologies

Plot #26 Out of Band 1{802.11g / 36Mbps / 2 462 MHz}

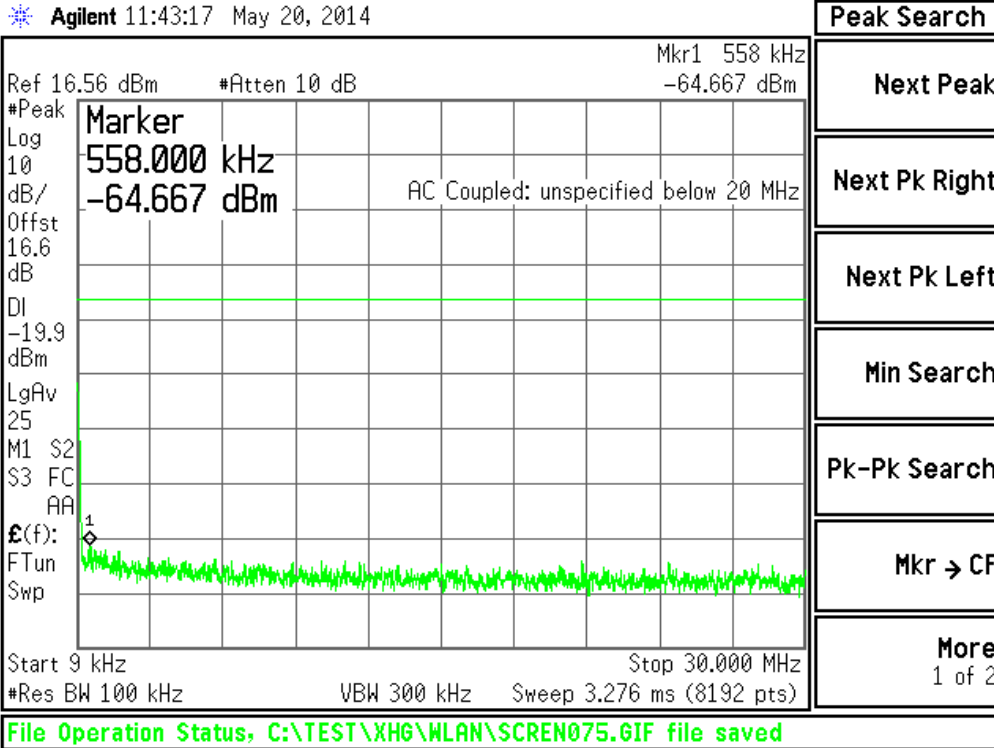

Plot #27 Out of Band 2{802.11g / 36 Mbps / 2 462 MHz}

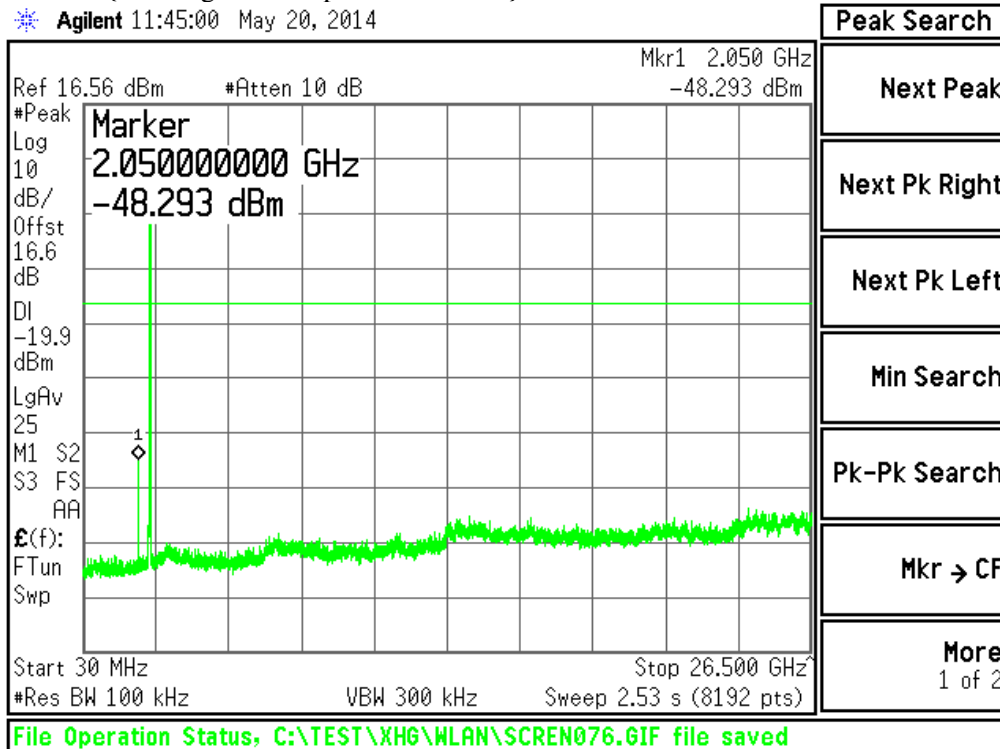

Plot #28 Out of Band Zoom{802.11g / 36 Mbps / 2 462 MHz}

Agilent 11:45:54 May 20, 2014

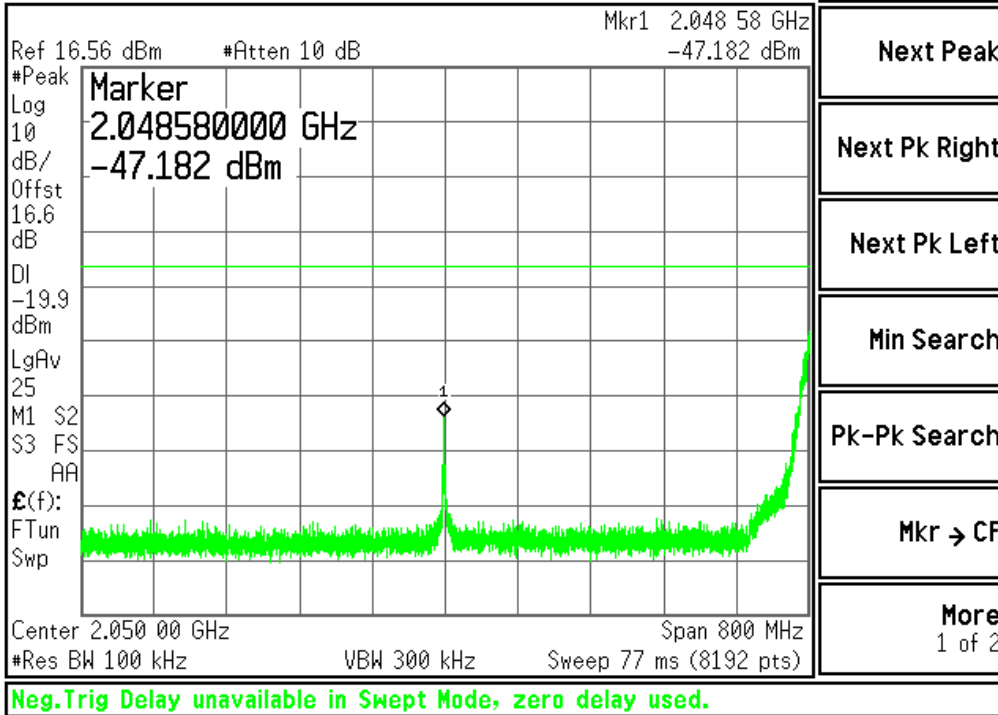

Plot #29 Reference Level {802.11g / 36 Mbps / 2 412 MHz}

Agilent 10:02:39 May 20, 2014

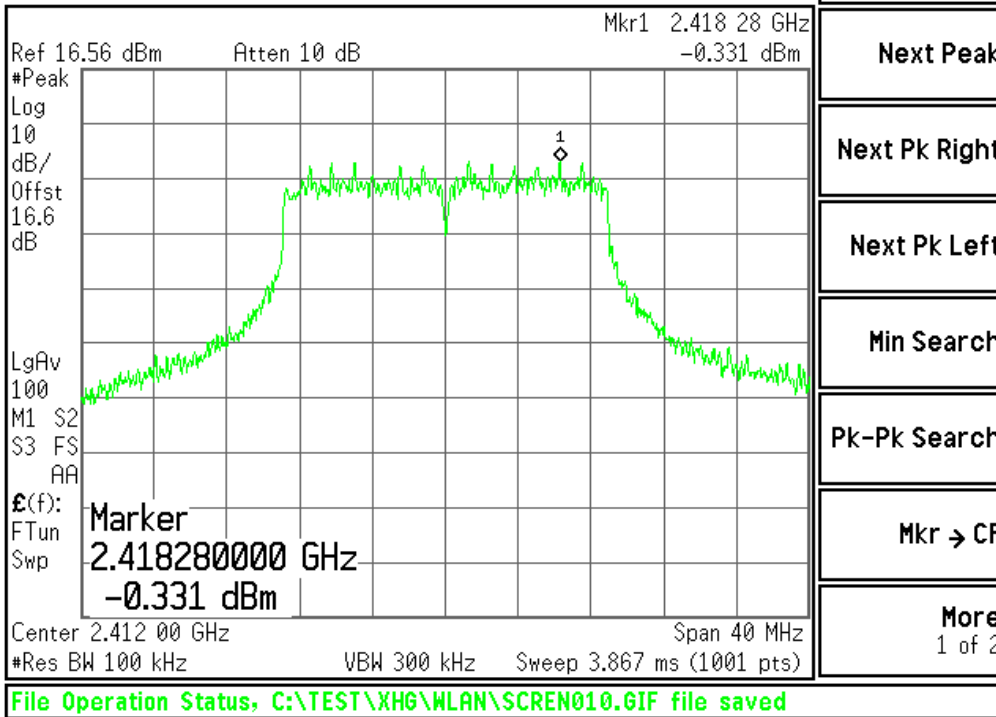

Plot #30 Band Edge {802.11g / 36 Mbps / 2 412 MHz}

Agilent 02:34:42 May 20, 2014

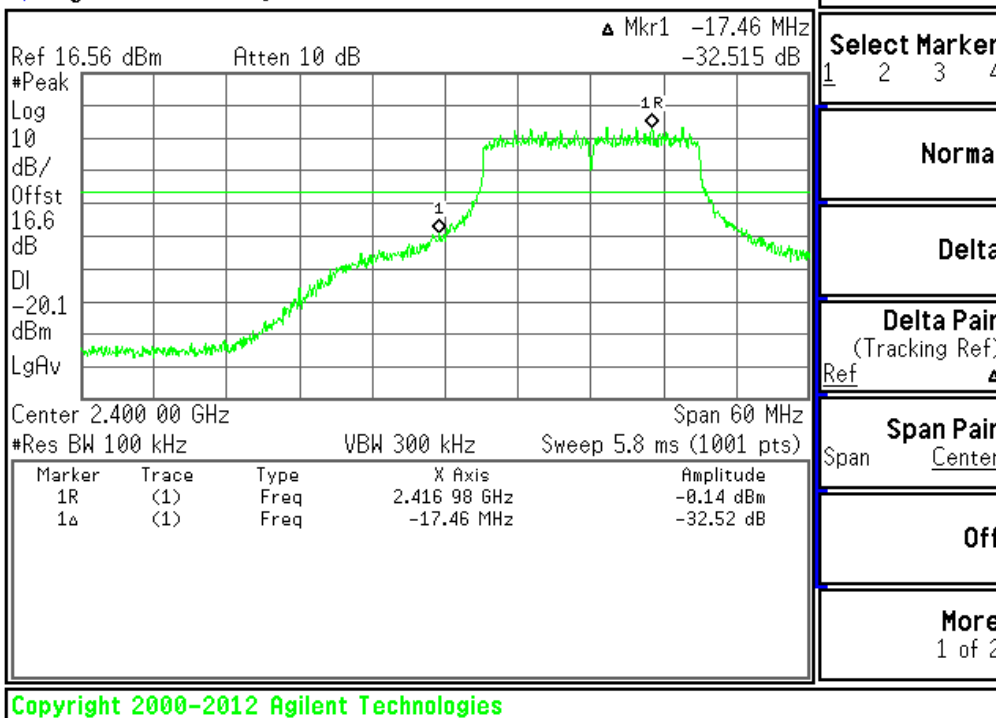

Plot #31 Out of Band 1{802.11g / 36 Mbps / 2 412 MHz}

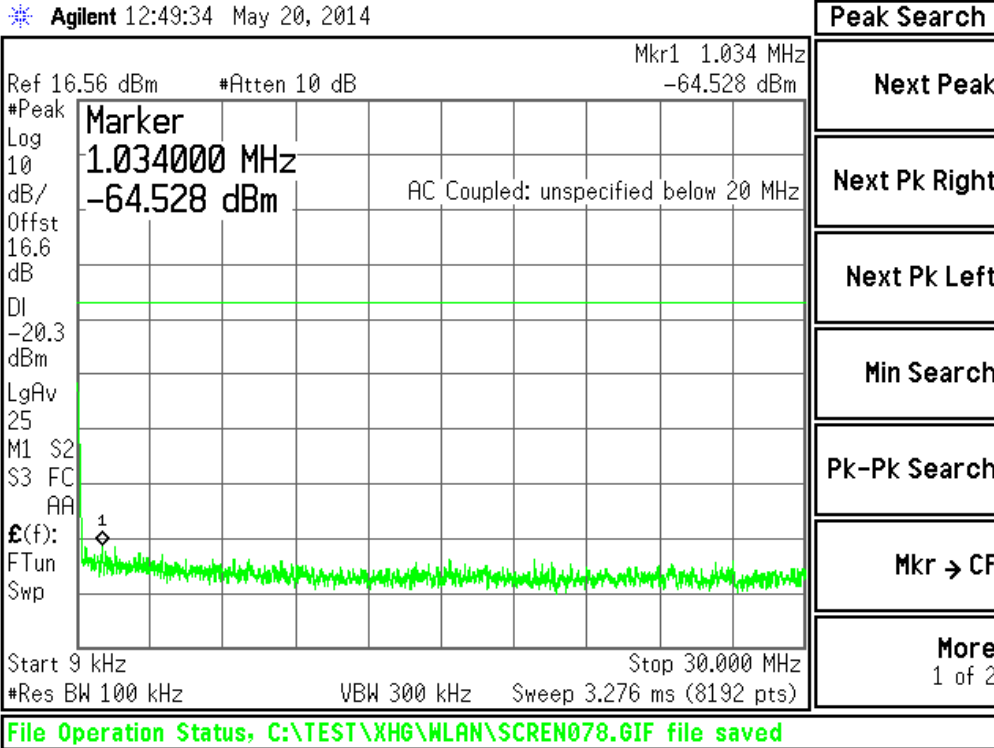

Plot #32 Out of Band 2{802.11g / 36 Mbps / 2 412 MHz}

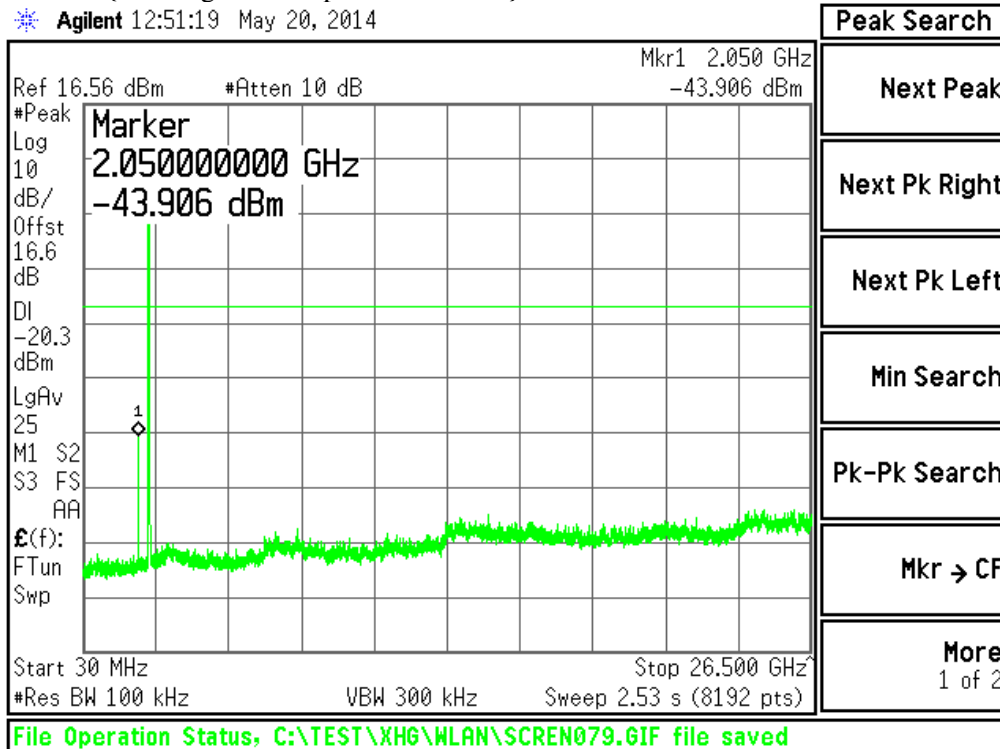

Plot #33 Out of Band Zoom{802.11g / 36 Mbps / 2 412 MHz}

Agilent 12:52:15 May 20, 2014

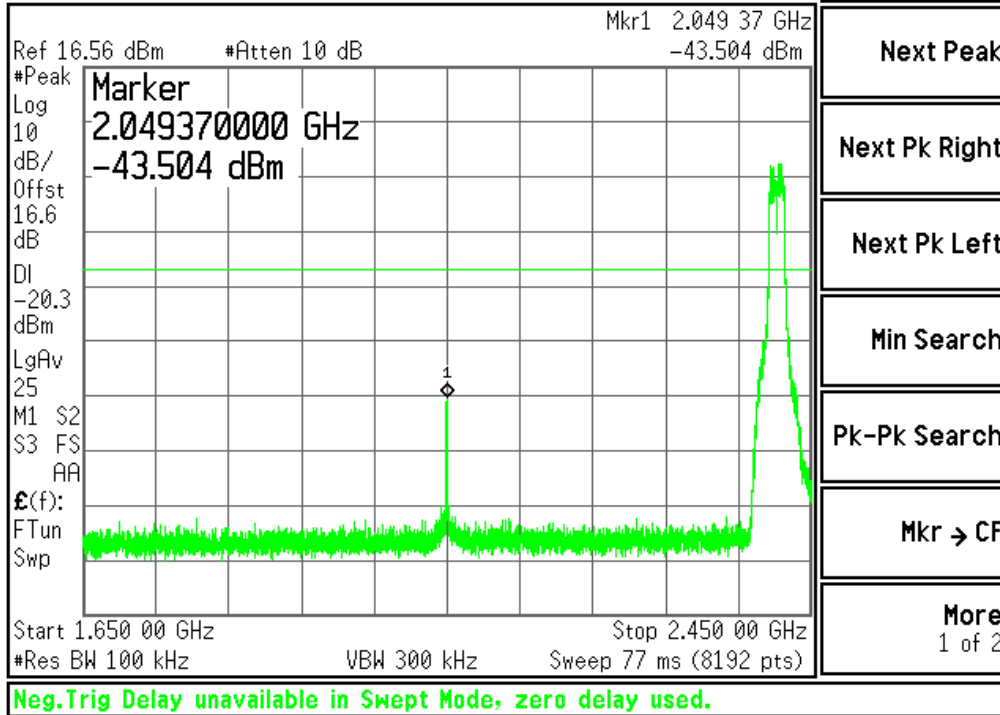

Plot #34 Reference Level {802.11g / 36 Mbps / 2 437 MHz}

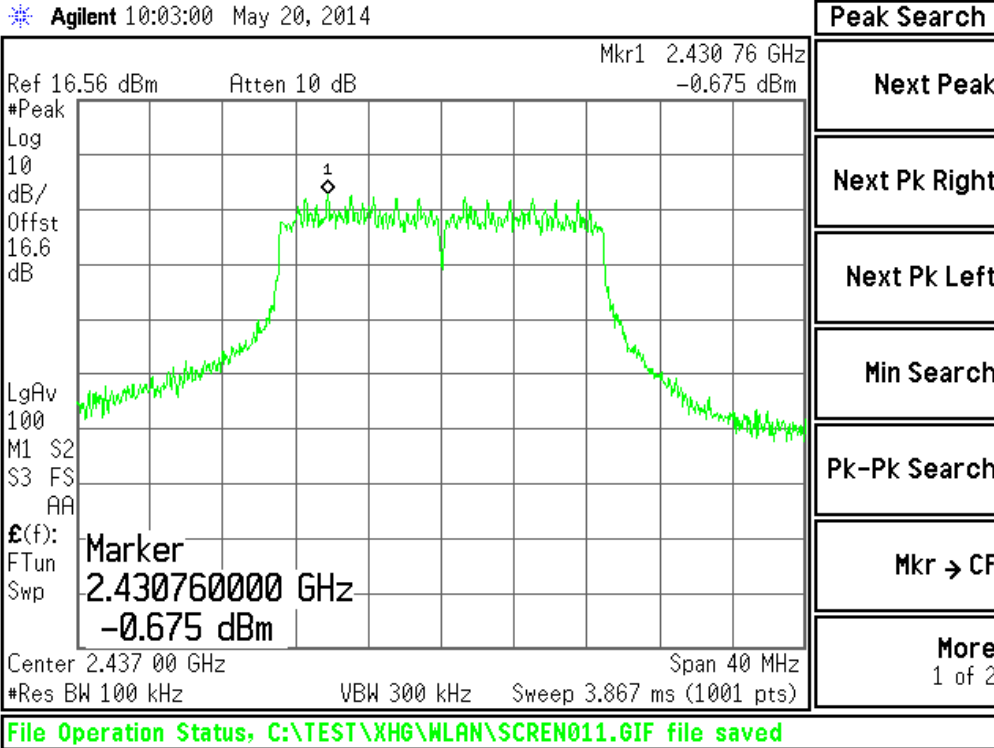

Plot #35 Out of Band 1{802.11g / 36 Mbps / 2 437 MHz}

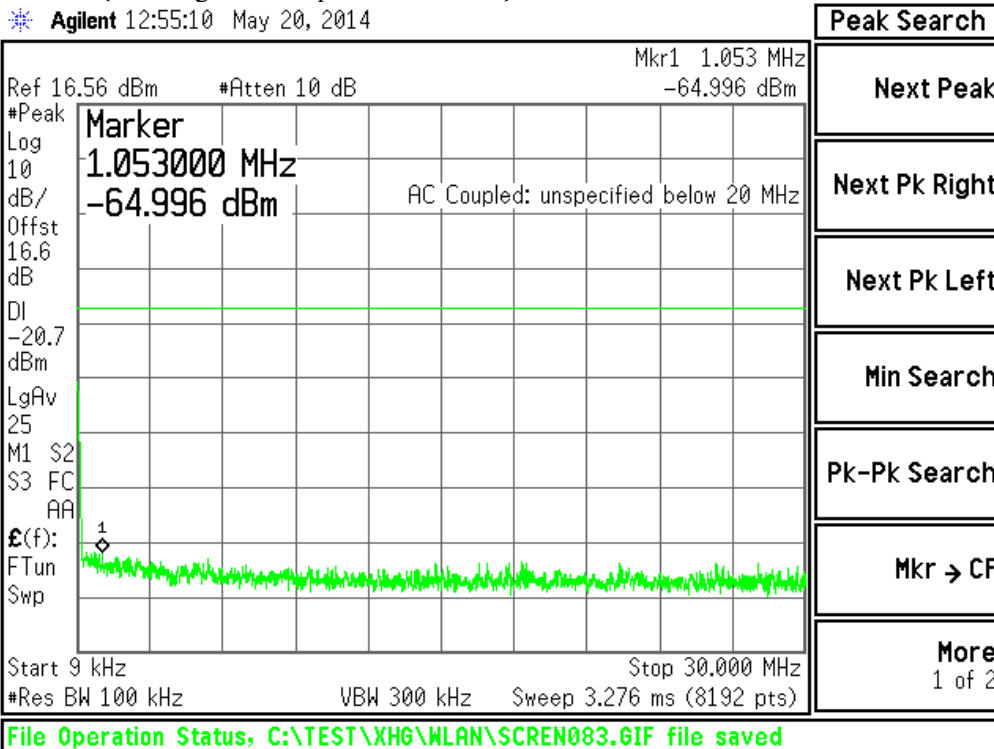

Plot #36 Out of Band 2{802.11g / 36 Mbps / 2 437 MHz}

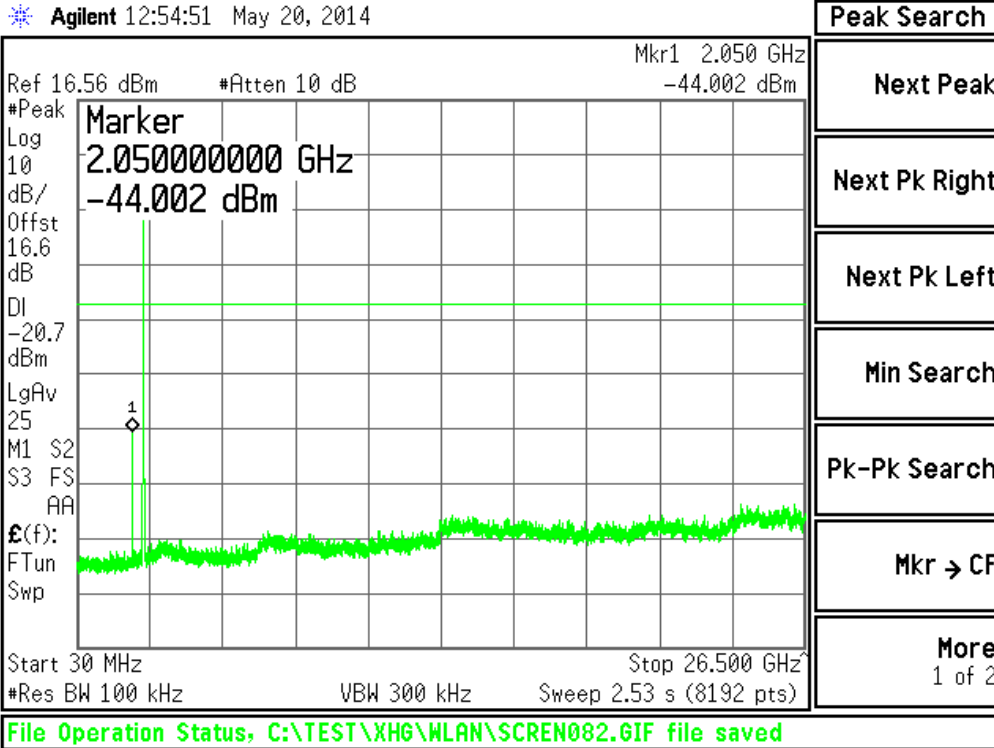

Plot #37 Out of Band Zoom{802.11g / 36 Mbps / 2 437 MHz}

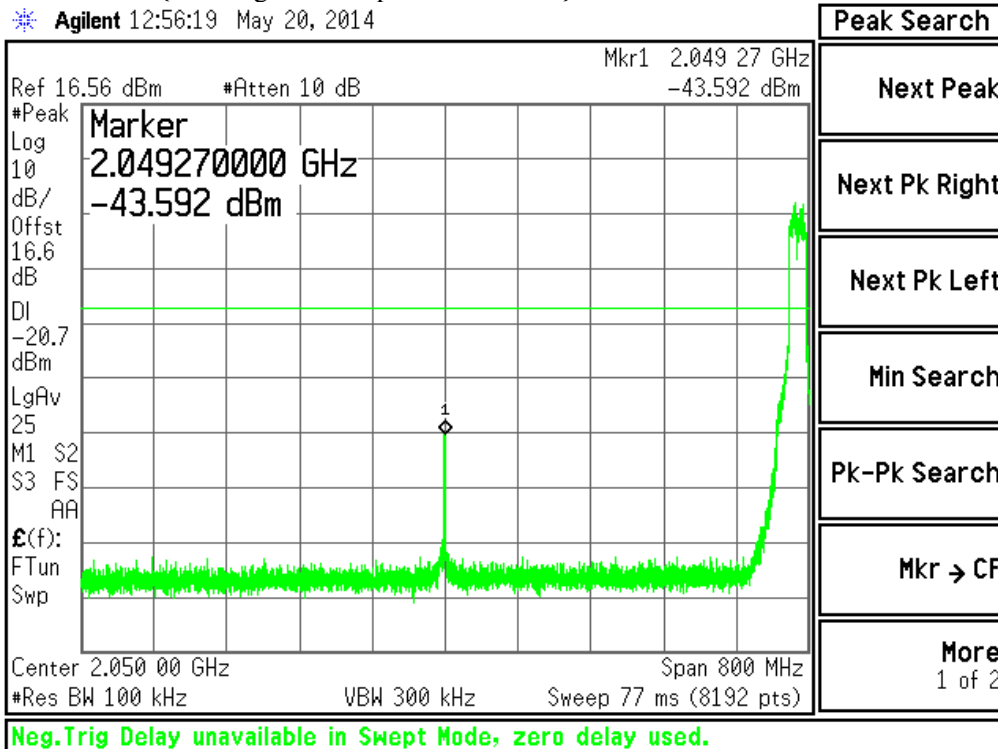

Plot #38 Reference Level {802.11g / 36 Mbps / 2 462 MHz}

Agilent 10:03:21 May 20, 2014

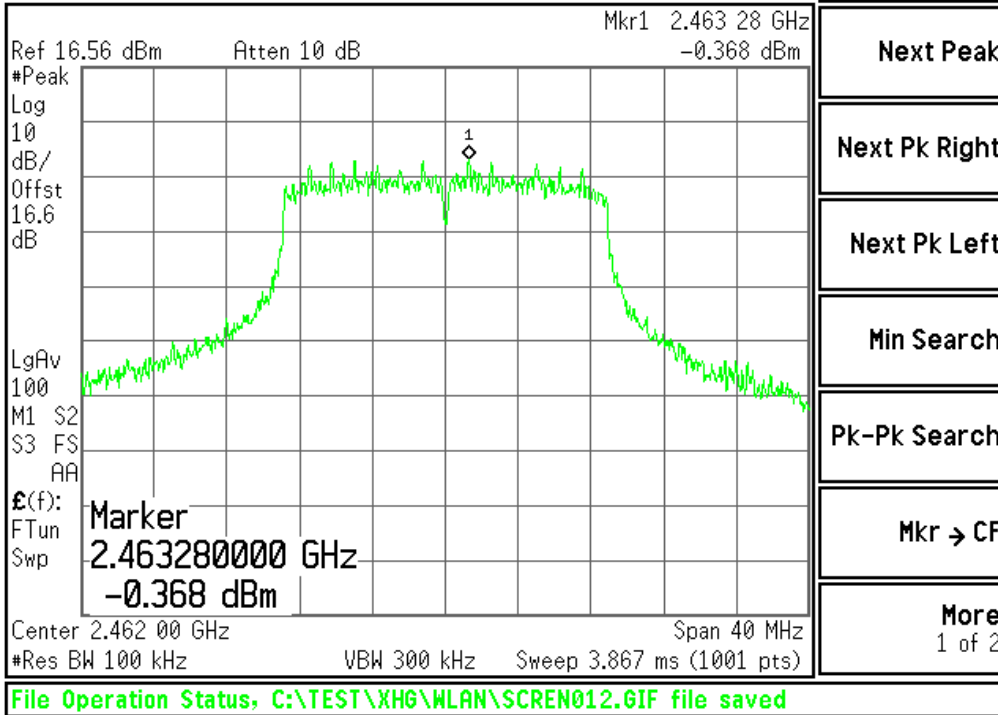

- Peak Search
- Next Peak
- Next Pk Right
- Next Pk Left
- Min Search
- Pk-Pk Search
- Mkr → CF
- More 1 of 2

Plot #39 Band Edge {802.11g / 36 Mbps / 2 462 MHz}l

Agilent 02:35:41 May 20, 2014

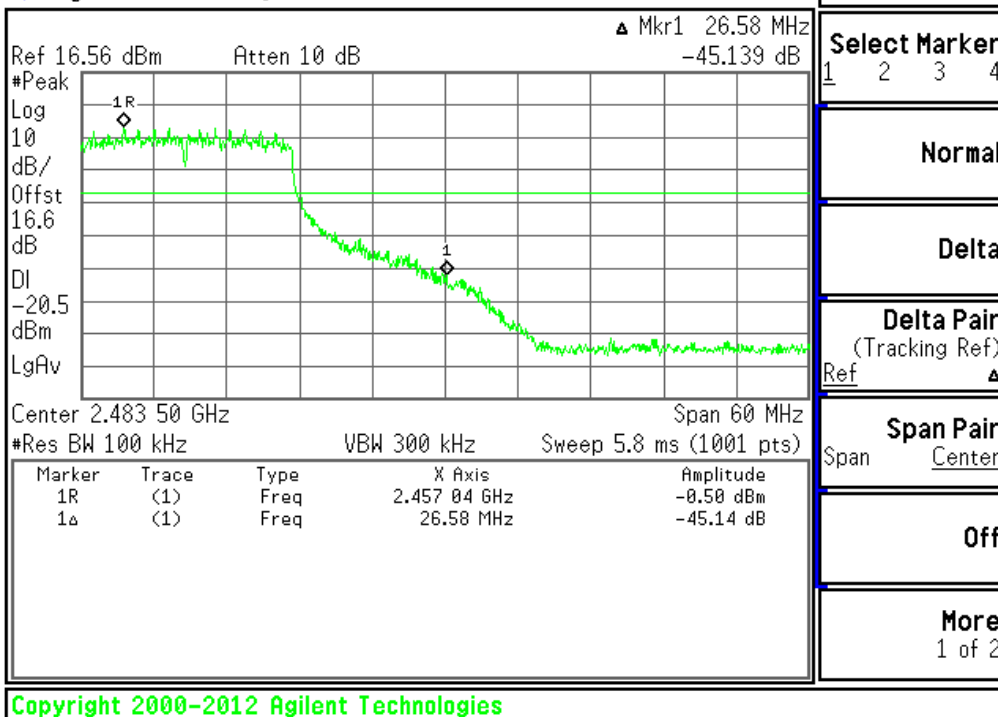

- Marker
- Select Marker 1 2 3 4
- Normal
- Delta
- Delta Pair (Tracking Ref) Ref Δ
- Span Pair Span Center
- Off
- More 1 of 2

Plot #40 Out of Band 1{802.11g / 36Mbps / 2 462 MHz}

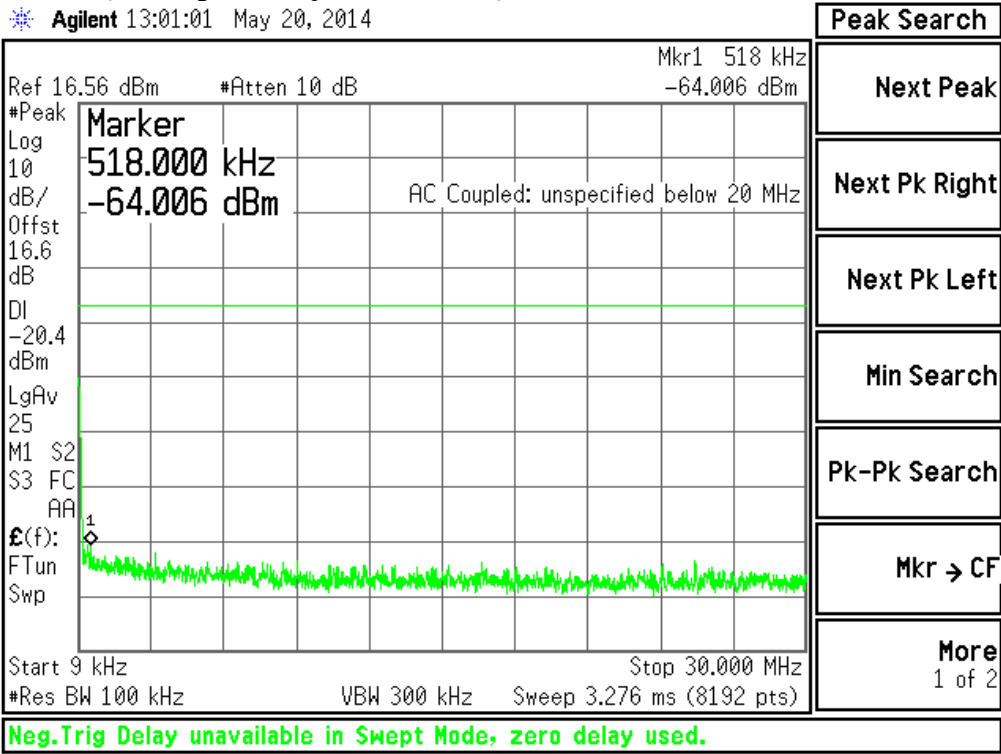

Plot #41 Out of Band 2{802.11g / 36 Mbps / 2 462 MHz}

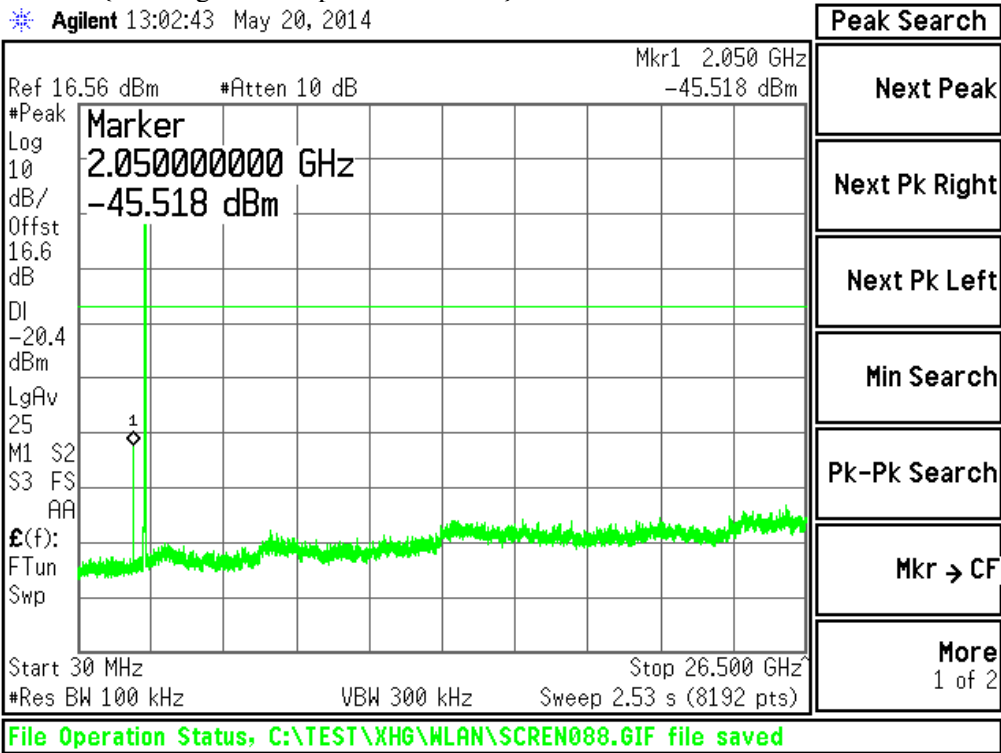

Plot #42 Out of Band Zoom{802.11g / 36 Mbps / 2 462 MHz}

Agilent 13:04:25 May 20, 2014

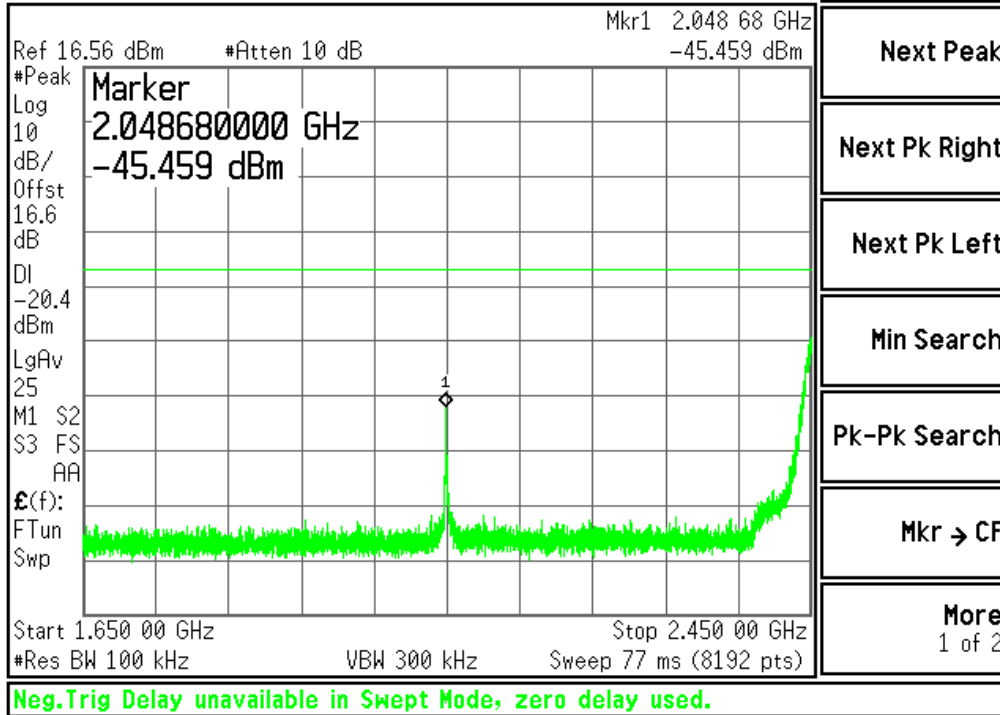

9. Transmitter Power Spectral Density

9.1 Definition

For digitally modulated systems, the power spectral density conducted from the intentional radiator to the antenna shall not be greater than 8 dBm in any 3 kHz band during any time interval of continuous transmission. This power spectral density shall be determined in accordance with the provisions of paragraph 15.247 (b) of this section. The same method of determining the conducted output power shall be used to determine the power spectral density.

9.2 Test Procedure

The Measurement Procedure Method PKPSD of KDB 558074 v03r1 is used.

- a. Set analyzer center frequency to DTS channel center frequency.
- b. Set the span to 1.5 times the DTS bandwidth.
- c. Set the RBW to: $3 \text{ kHz} \leq \text{RBW} \leq 100 \text{ kHz}$.
- d. Set the VBW $\geq 3 \times \text{RBW}$.
- e. Detector = peak.
- f. Sweep time = auto couple.
- g. Trace mode = max hold.
- h. Allow trace to fully stabilize. (50 times sweep)
- i. Use the peak marker function to determine the maximum amplitude level within the RBW.
- j. If measured value exceeds limit, reduce RBW (no less than 3 kHz) and repeat

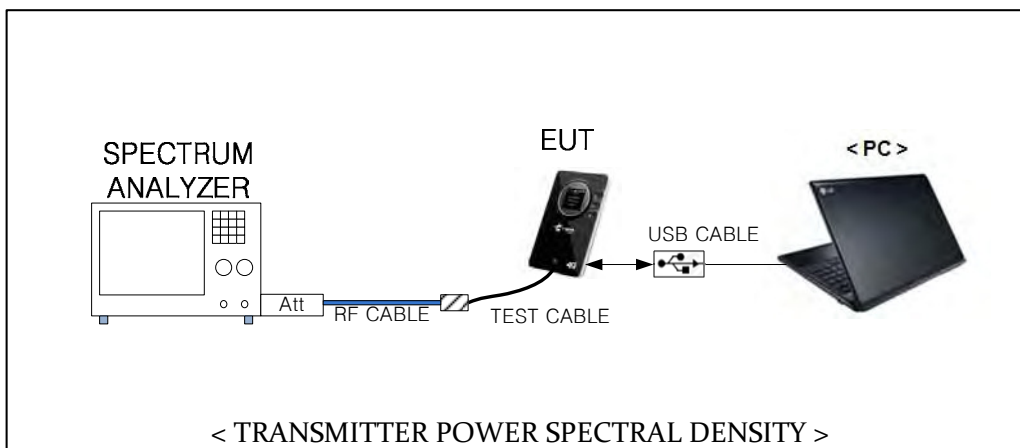

* RF Cable : Radiall / 1800920921500PJ / DC-40 GHz / 1.5m

* Attenuator : 10 dB (Weinshel /56-10/ DC-28 GHz) + 6 dB(Weinshel / 56-6 / DC-28 GHz)

* TEST Cable : Connect WIFI Antenna port (5 cm / SMA connector)

* Path Loss Information

Frequency(MHz)	RF Cable (dB)	10 dB ATT (dB)	6 dB ATT (dB)	Test Cable (dB)	Total Loss (dB)
2 412 ~ 2 462	0.99	9.63	5.64	0.30	16.56

9.3 Test Criteria

the power spectral density conducted from the intentional radiator radiator to the antenna shall not be greater than 8 dBm.

9.4 Test Results

Unit : dBm

Modulation	RATE	Low Channel [1]	Mid Channel [6]	High Channel [11]
		Frequency(MHz) 2412	Frequency(MHz) 2437	Frequency(MHz) 2462
802.11 b	1 Mbps	-9.29	-10.18	-9.18
802.11 g	36 Mbps	-13.28	-13.35	-14.42
802.11 n	MCS6	-13.70	-14.04	-14.14

* RBW = 3 KHz

9.5 Test Plots

Plot #1 {802.11b / 1 Mbps / 2 412 MHz}

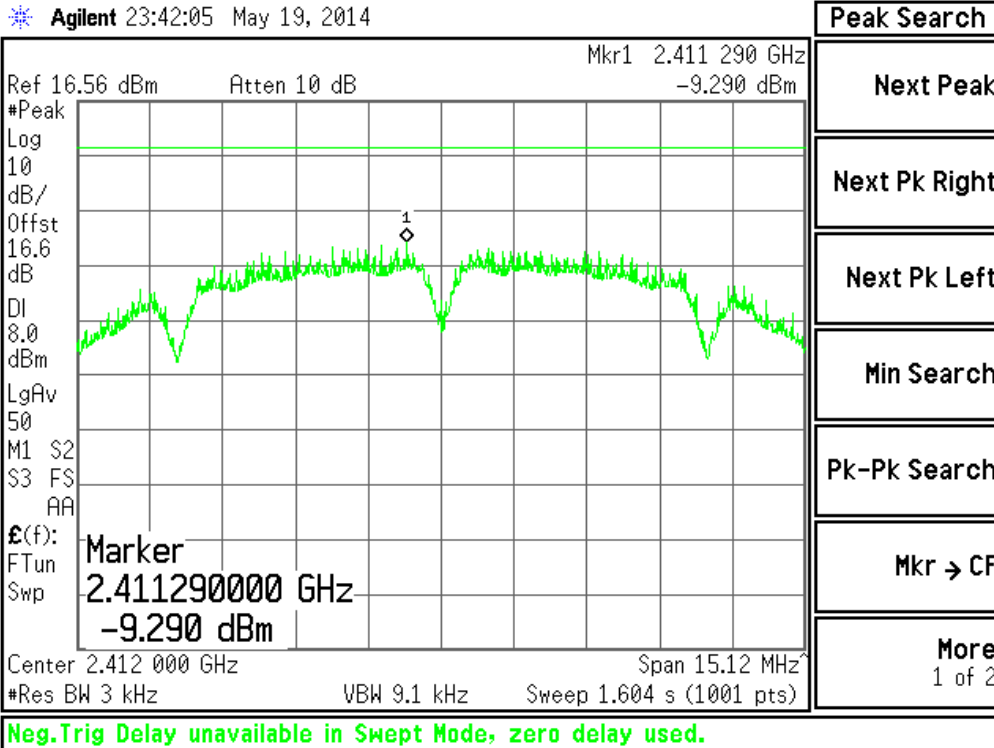

Plot #2 {802.11b / 1 Mbps / 2 437 MHz}

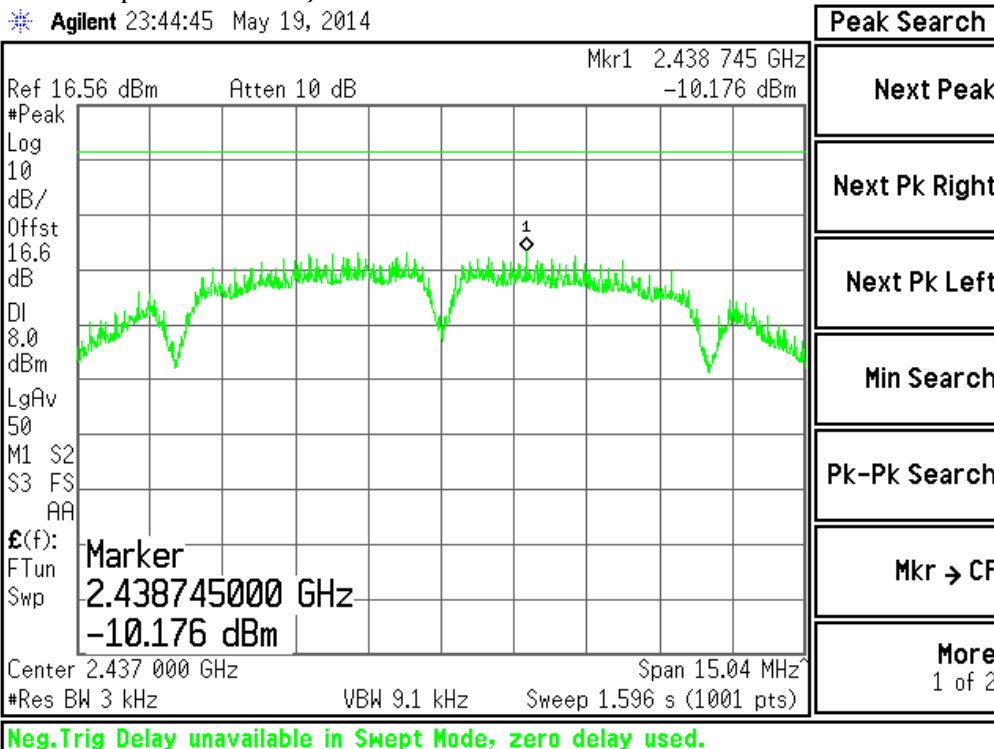

Plot #3 {802.11b / 1 Mbps / 2 462 MHz}

Agilent 23:47:05 May 19, 2014

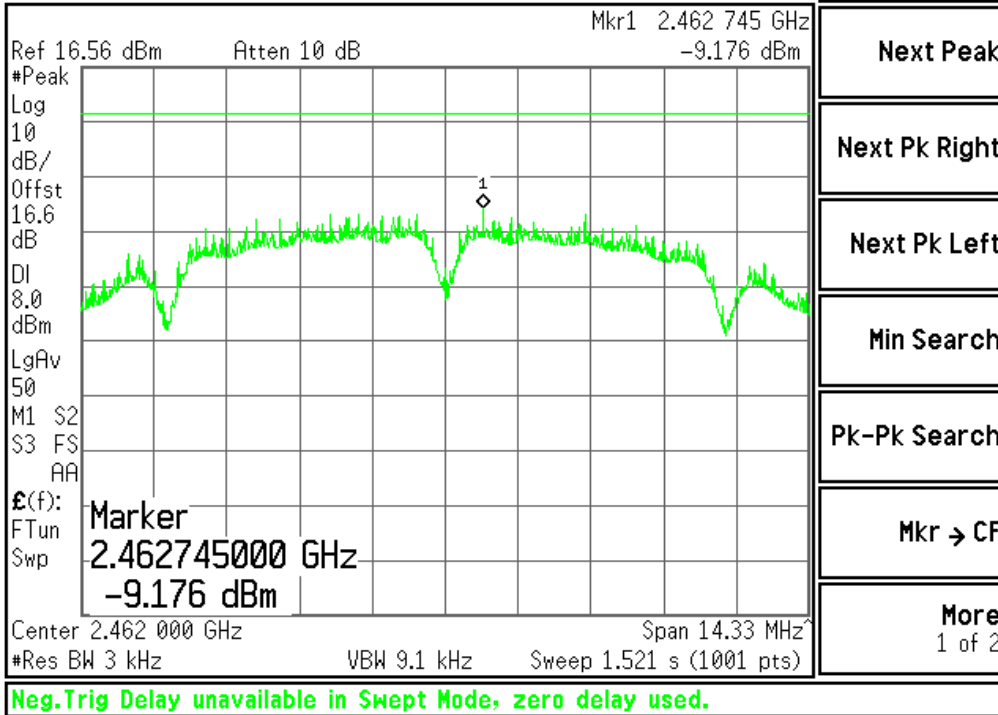

Plot #4 {802.11g / 36 Mbps / 2 412 MHz}

Agilent 23:51:20 May 19, 2014

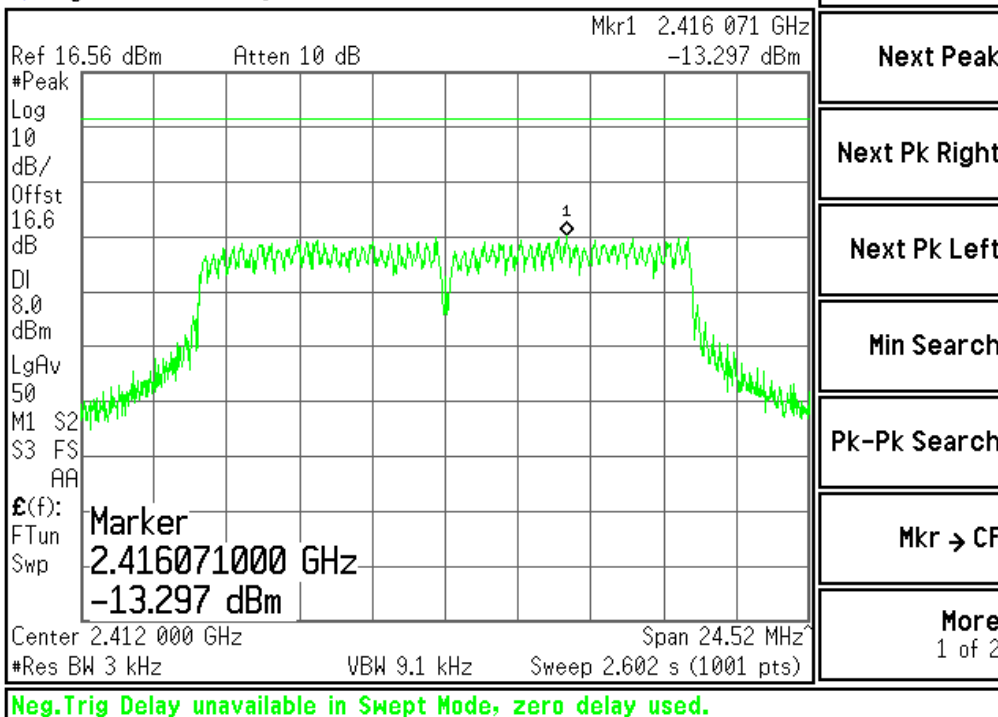

Plot #5 {802.11g / 36 Mbps / 2 437 MHz}

Agilent 23:54:11 May 19, 2014

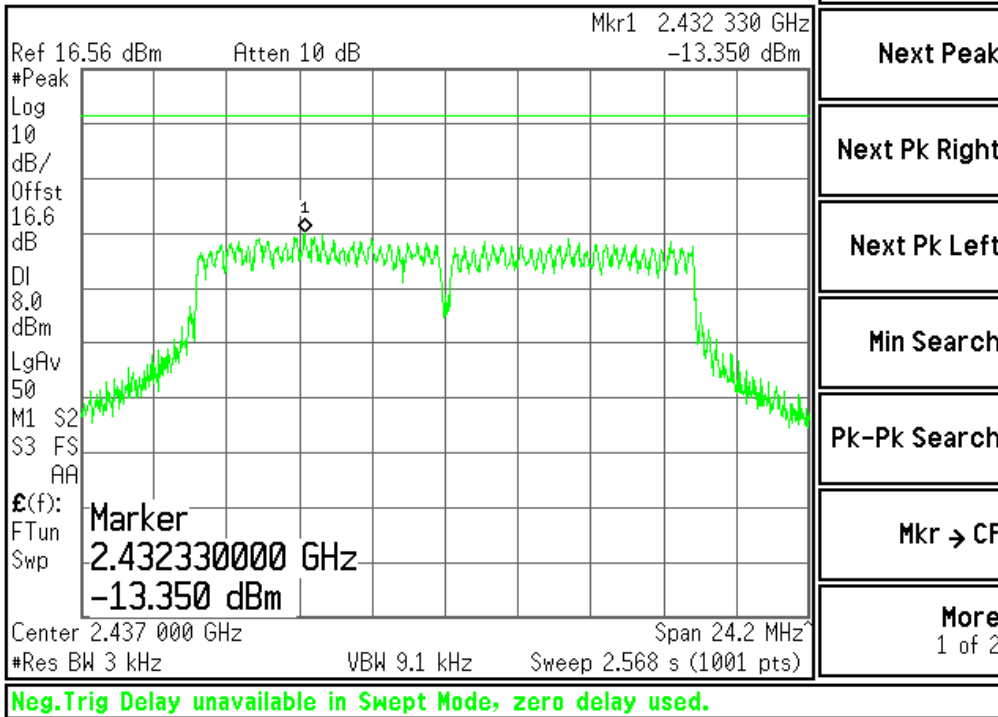

Plot #6 {802.11g / 36 Mbps / 2 462 MHz}

Agilent 23:57:16 May 19, 2014

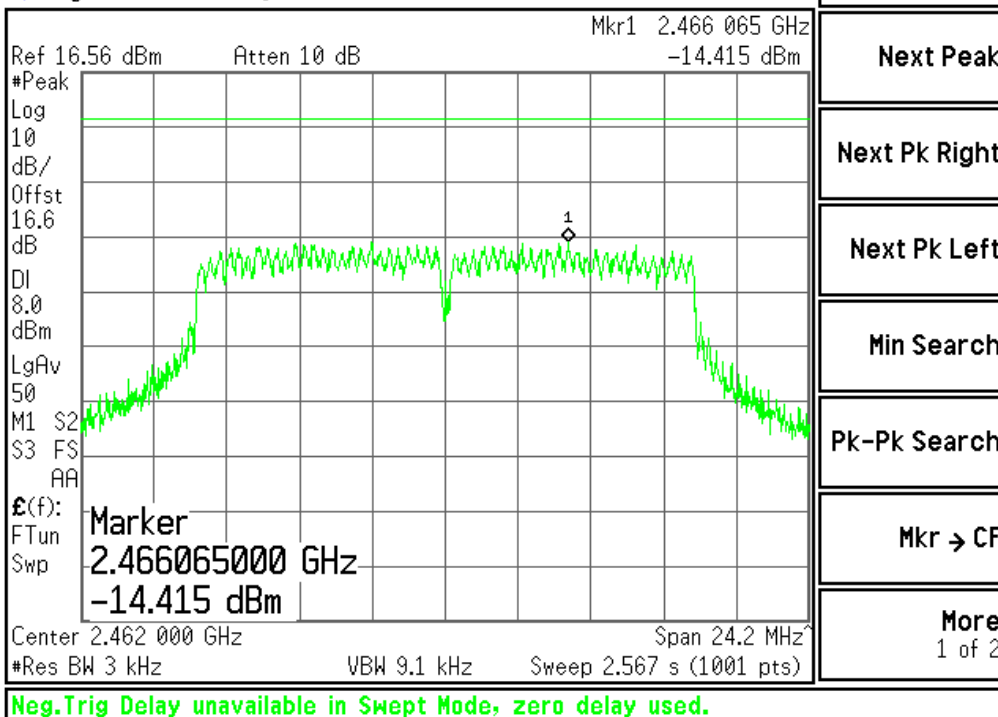

Plot #7 {802.11n / MCS6 / 2 412 MHz}

Agilent 00:09:58 May 20, 2014

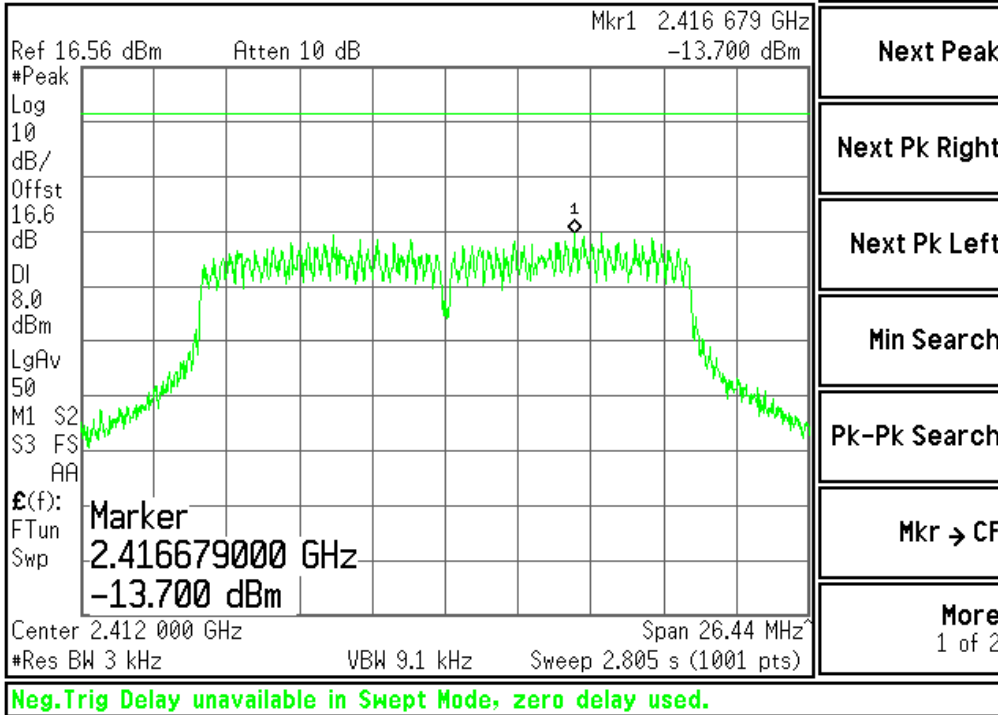

Plot #8 {802.11n / MCS6 / 2 437 MHz}

Agilent 00:14:16 May 20, 2014

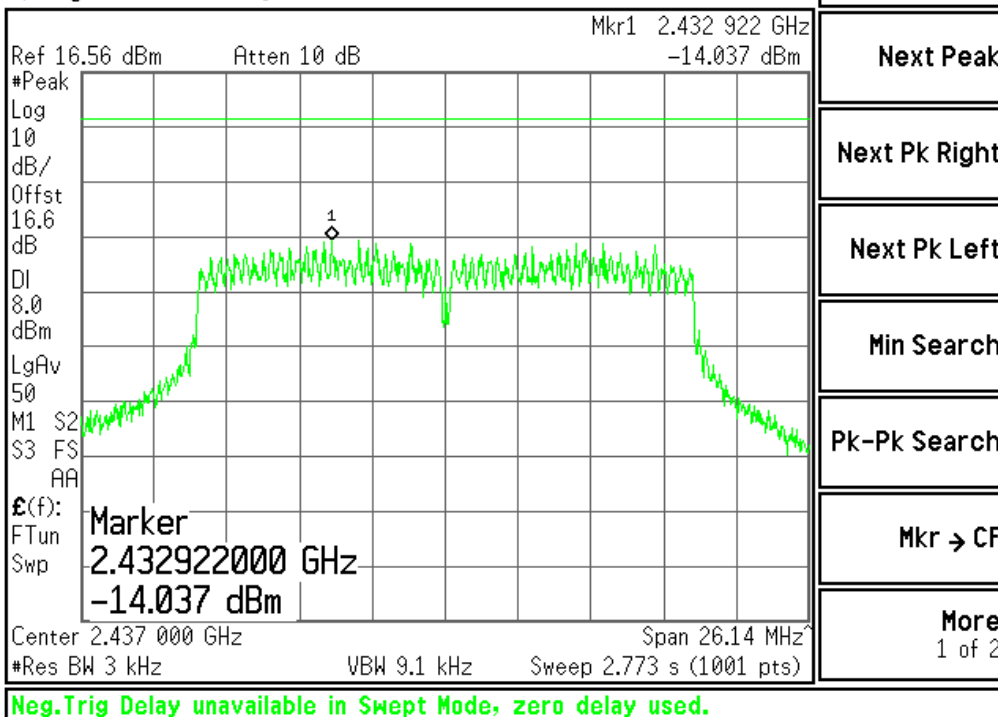

Plot #9 {802.11n / MCS6 / 2 462 MHz}

Agilent 00:28:02 May 20, 2014

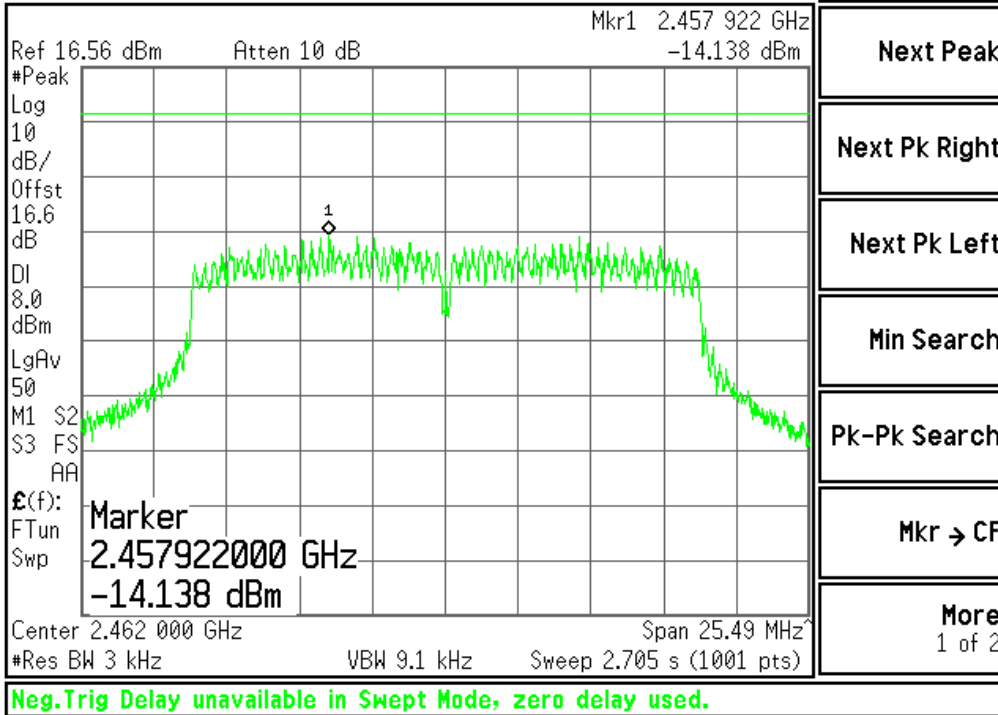



10. General Field Strength Limits(Restricted Bands and Raiated Emission Limits)

10.1 Definition

In any 100kHz bandwidth outside the operating frequency band. In case the emission fall within the restricted band specified on 15.205(a) and (b), then the 15.209(a) limit in the table below has to be followed

FCC part 15.209(a) and (b).Except as provided elsewhere in this subpart, the emissions from an intentional radiator shall not exceed the field strength levels specified in the following table::

Frequency (MHz)	Field strength (microvolts/meter)	Measurement distance (meters)
0.009-0.490	2400/F(kHz)	300
0.490-1.705	24000/F(kHz)	30
1.705-30.0	30	30
30-88	100**	3
88-216	150**	3
216-960	200**	3

**Except as provided in paragraph (g), fundamental emissions from intentional radiators operating under this section shall not be located in the frequency bands 54-72 MHz, 76-88 MHz, 174-216 MHz or 470-806 MHz. However, operation within these frequency bands is permitted under other sections of this part, e.g., §§15.231 and 15.241.

FCC part 15.205(a) : Only spurious emissions are permitted in any of the frequency bands listed below:

MHz	MHz	MHz	GHz
0.090-0.110	16.42-16.423	399.9-410	4.5-5.15
10.495-0.505	16.69475-16.69525	608-614	5.35-5.46
2.1735-2.1905	16.80425-16.80475	960-1240	7.25-7.75
4.125-4.128	25.5-25.67	1300-1427	8.025-8.5
4.17725-4.17775	37.5-38.25	1435-1626.5	9.0-9.2
4.20725-4.20775	73-74.6	1645.5-1646.5	9.3-9.5
6.215-6.218	74.8-75.2	1660-1710	10.6-12.7
6.26775-6.26825	108-121.94	1718.8-1722.2	13.25-13.4
6.31175-6.31225	123-138	2200-2300	14.47-14.5
8.291-8.294	149.9-150.05	2310-2390	15.35-16.2
8.362-8.366	156.52475-156.52525	2483.5-2500	17.7-21.4
8.37625-8.38675	156.7-156.9	2690-2900	22.01-23.12
8.41425-8.41475	162.0125-167.17	3260-3267	23.6-24.0
12.29-12.293	167.72-173.2	3332-3339	31.2-31.8
12.51975-12.52025	240-285	3345.8-3358	36.43-36.5
12.57675-12.57725	322-335.4	3600-4400	(2)
13.36-13.41			

FCC Part 15.205(b): The field strength of emissions appearing within these frequency bands shall not exceed the limits shown in §15.209. At frequencies equal to or less than 1000 MHz, compliance with the limits in §15.209 shall be demonstrated using measurement instrumentation employing a CISPR quasi-peak detector. Above 1000 MHz, compliance with the emission limits in §15.209 shall be demonstrated based on the average value of the measured emissions. The provisions in §15.35 apply to these measurements.

10.2 Test Procedure

The EUT was placed on a non-conductive table 0.8 meters above the ground plane. The table was centered on a rotating turntable at a distance of 3 meters from the measurement antenna.

For spurious emissions below 1 GHz quasi-peak detection is used with a resolution bandwidth of 120 kHz. The emissions were maximized by rotating the EUT and raising and lowering the measurement antenna from 1~4 meters (above 1 GHz, measure antenna from 1 ~ 3.5 meters)

Spurious/harmonic emissions above 1 GHz peak are measured with average and peak detection with a resolution bandwidth of 1 MHz and measured at a distance of 3 meter.

Average detection is used to determine compliance of the EUT if the peak does not meet the average limit. Non-harmonic emissions must satisfy the average limit and the peak limit (20 dB above average).

Further, compliance with the provisions of 15.205 was demonstrated using the measurement instrumentation specified in that section where applicable.

Radiated emissions from the EUT were measured by EMI Receiver according to the dictates of ANSI C63.4:2009. Above 1 GHz, used spectrum analyzer.

Correction factor is a combination of cable loss (CL), microwave amplifier gain (G amp), antenna factor (AF), Duty cycle factor (DCF), Hi-Pass Filter factor (HPF)

Example correction factor calculation: $F/S(\text{Field Strength}) = \text{Measuring Value} + \text{AF} - \text{G amp} + \text{CL} + \text{DCF} + \text{HPF}$

* Total factor = $\text{AF} - \text{G amp} + \text{CL} + \text{DCF} + \text{HPF}$

Mode	RATE	T total (ms)	Ton (ms)	Duty cycle	Duty cycle (%)	Duty Factor(dB)
802.11 b	1 Mbps	12.442	12.416	0.99791	99.79 %	0.009
802.11g	36 Mbps	0.396	0.364	0.91919	91.92%	0.366
802.11n	MCS6	0.28	0.248	0.88571	88.57%	0.527

*Duty cycle Factor

Both vertical and horizontal polarities were tested and the worst case presented. In all cases the vertical polarization resulted in the greatest signal.

10.3 Test Results

10.3.1 mode : 802.11b / 1 Mbps / 2 412 MHz

Freq (MHz)	ANT (H/V)	EUT (X,Y,Z)	Detector	Reading (dBμV)	Total Factor(dB)	DCF (dB)	Result (dBμV/m)	Limit (dB)	Margin (dB)
500.45	V	XY	QP	12.34	19.82	-	32.16	46.00	13.84
500.45	V	YZ	QP	12.30	19.82	-	32.12	46.00	13.88
563.50	V	ZX	QP	10.50	21.12	-	31.62	46.00	14.38
2389.76	V	XY	PK	54.14	-9.73	-	44.41	74.00	29.59
2389.36	V	XY	AV	49.57	-9.73	0.01	39.85	54.00	14.15
2389.52	H	XY	PK	54.50	-9.73	-	44.77	74.00	29.23
2389.36	H	XY	AV	49.23	-9.73	0.01	39.51	54.00	14.49
2389.68	V	ZX	PK	52.14	-9.73	-	42.41	74.00	31.59
2389.52	V	ZX	AV	46.70	-9.73	0.01	36.98	54.00	17.02
4824.00	H	XY	PK	50.40	-3.46	-	46.94	74.00	27.06
4824.00	H	XY	AV	39.99	-3.46	0.01	36.54	54.00	17.46
4820.00	V	XY	PK	56.52	-3.46	-	53.06	74.00	20.94
4820.00	V	XY	AV	40.44	-3.46	0.01	36.99	54.00	17.01

- * QP : Quasi-Peak / PK : peak / AV : average
- * No other spurious and harmonic emissions were found greater than listed emissions on above table.
- * Above listed point data is the worst case data
- * Margin = Limit – Result / Result = Reading + T.F+ DCF

10.3.2 mode : 802.11b / 1 Mbps / 2 432 MHz

Freq (MHz)	ANT (H/V)	EUT (X,Y,Z)	Detector	Reading (dBμV)	Total Factor(dB)	DCF (dB)	Result (dBμV/m)	Limit (dB)	Margin (dB)
500.45	V	XY	QP	11.54	19.82	-	31.36	46.00	14.64
4876.00	H	XY	PK	52.01	-3.34	-	48.67	74.00	25.33
4876.00	H	XY	AV	39.77	-3.34	0.01	36.44	54.00	17.56
4876.00	V	XY	PK	50.00	-3.34	-	46.66	74.00	27.34
4876.00	V	XY	AV	39.84	-3.34	0.01	36.51	54.00	17.49

- * QP : Quasi-Peak / PK : peak / AV : average
- * No other spurious and harmonic emissions were found greater than listed emissions on above table.
- * Above listed point data is the worst case data
- * Margin = Limit – Result / Result = Reading + Total Factor+ DCF

10.3.3 mode : 802.11b / 1 Mbps / 2 462 MHz

Freq (MHz)	ANT (H/V)	EUT (X,Y,Z)	Detector	Reading (dBμV)	Total Factor(dB)	DCF (dB)	Result (dBμV/m)	Limit (dB)	Margin (dB)
500.45	V	XY	QP	11.06	19.82	-	30.88	46.00	15.12
2484.23	V	XY	PK	54.58	-9.31	-	45.27	74.00	28.73
2487.49	V	XY	AV	51.22	-9.28	0.01	41.95	54.00	12.05
2484.42	H	XY	PK	54.93	-9.31	-	45.62	74.00	28.38
2488.01	H	XY	AV	50.58	-9.28	0.01	41.31	54.00	12.69
4920.00	V	XY	PK	50.38	-3.23	-	47.15	74.00	26.85
4920.00	V	XY	AV	39.78	-3.23	0.01	36.56	54.00	17.44
4920.00	H	XY	PK	51.25	-3.23	-	48.02	74.00	25.98
4920.00	H	XY	AV	40.71	-3.23	0.01	37.49	54.00	16.51

* QP : Quasi-Peak / PK : peak / AV : average

* No other spurious and harmonic emissions were found greater than listed emissions on above table.

* Above listed point data is the worst case data

* Margin = Limit – Result / Result = Reading + Total Factor+ DCF

10.3.4 mode : 802.11g / 36 Mbps / 2 412 MHz

Freq (MHz)	ANT (H/V)	EUT (X,Y,Z)	Detector	Reading (dBμV)	Total Factor(dB)	DCF (dB)	Result (dBμV/m)	Limit (dB)	Margin (dB)
500.45	V	XY	QP	12.47	19.82	-	32.29	46.00	13.71
2390.00	H	XY	PK	73.82	-9.73	-	64.09	74.00	9.91
2389.84	H	XY	AV	61.79	-9.73	0.37	52.43	54.00	1.57
2390.00	V	XY	PK	72.58	-9.73	-	62.85	74.00	11.15
2389.68	V	XY	AV	60.29	-9.73	0.37	50.93	54.00	3.07
4824.00	H	XY	PK	52.98	-3.46	-	49.52	74.00	24.48
4824.00	H	XY	AV	40.28	-3.46	0.37	37.19	54.00	16.81
4820.00	V	XY	PK	50.38	-3.46	-	46.92	74.00	27.08
4820.00	V	XY	AV	40.25	-3.46	0.37	37.16	54.00	16.84

- * QP : Quasi-Peak / PK : peak / AV : average
- * No other spurious and harmonic emissions were found greater than listed emissions on above table.
- * Above listed point data is the worst case data
- * Margin = Limit – Result / Result = Reading + Total Factor+ DCF

10.3.5 mode : 802.11g / 36 Mbps / 2 432 MHz

Freq (MHz)	ANT (H/V)	EUT (X,Y,Z)	Detector	Reading (dBμV)	Total Factor(dB)	DCF (dB)	Result (dBμV/m)	Limit (dB)	Margin (dB)
500.45	V	XY	QP	12.22	19.82	-	32.04	46.00	13.96
4876.00	V	XY	PK	52.46	-3.34	-	49.12	74.00	24.88
4876.00	V	XY	AV	40.22	-3.34	0.37	37.25	54.00	16.75
4876.00	H	XY	PK	52.35	-3.34	-	49.01	74.00	24.99
4876.00	H	XY	AV	40.30	-3.34	0.37	37.33	54.00	16.67

- * QP : Quasi-Peak / PK : peak / AV : average
- * No other spurious and harmonic emissions were found greater than listed emissions on above table.
- * Above listed point data is the worst case data
- * Margin = Limit – Result / Result = Reading + Total Factor+ DCF

10.3.6 mode : 802.11g / 36 Mbps / 2 462 MHz

Freq (MHz)	ANT (H/V)	EUT (X,Y,Z)	Detector	Reading (dBμV)	Total Factor(dB)	DCF (dB)	Result (dBμV/m)	Limit (dB)	Margin (dB)
500.45	V	XY	QP	11.76	19.82	-	31.58	46.00	14.42
2483.55	V	XY	PK	74.79	-9.31	-	65.48	74.00	8.52
2483.50	V	XY	AV	60.44	-9.28	0.37	51.53	54.00	2.47
2483.53	H	XY	PK	75.00	-9.31	-	65.69	74.00	8.31
2483.52	H	XY	AV	61.62	-9.28	0.37	52.71	54.00	1.29
4920.00	H	XY	PK	52.59	-3.23	-	49.36	74.00	24.64
4920.00	H	XY	AV	40.70	-3.23	0.37	37.84	54.00	16.16
4920.00	V	XY	PK	53.23	-3.23	-	50.00	74.00	24.00
4920.00	V	XY	AV	40.16	-3.23	0.37	37.30	54.00	16.70

- * QP : Quasi-Peak / PK : peak / AV : average
- * No other spurious and harmonic emissions were found greater than listed emissions on above table.
- * Above listed point data is the worst case data
- * Margin = Limit – Result / Result = Reading + Total Factor+ DCF

10.3.7 mode : 802.11n / MCS6 / 2 412 MHz

Freq (MHz)	ANT (H/V)	EUT (X,Y,Z)	Detector	Reading (dBμV)	Total Factor(dB)	DCF (dB)	Result (dBμV/m)	Limit (dB)	Margin (dB)
500.45	V	XY	QP	12.43	19.82	-	32.25	46.00	13.75
2390.00	H	XY	PK	72.06	-9.73	-	62.33	74.00	11.67
2389.92	H	XY	AV	60.30	-9.73	0.53	51.10	54.00	2.90
2390.00	V	XY	PK	71.68	-9.73	-	61.95	74.00	12.05
2389.76	V	XY	AV	58.92	-9.73	0.53	49.72	54.00	4.28
4824.00	V	XY	PK	52.98	-3.46	-	49.52	74.00	24.48
4824.00	V	XY	AV	40.59	-3.46	0.53	37.66	54.00	16.34
4820.00	H	XY	PK	50.49	-3.46	-	47.03	74.00	26.97
4820.00	H	XY	AV	40.87	-3.46	0.53	37.94	54.00	16.06

* QP : Quasi-Peak / PK : peak / AV : average

* No other spurious and harmonic emissions were found greater than listed emissions on above table.

* Above listed point data is the worst case data

* Margin = Limit – Result / Result = Reading + Total Factor+ DCF

10.3.8 mode : 802.11n / MCS6 / 2 432 MHz

Freq (MHz)	ANT (H/V)	EUT (X,Y,Z)	Detector	Reading (dBμV)	Total Factor(dB)	DCF (dB)	Result (dBμV/m)	Limit (dB)	Margin (dB)
500.45	V	XY	QP	11.81	19.82	-	31.63	46.00	14.37
4876.00	H	XY	PK	51.31	-3.34	-	47.97	74.00	26.03
4876.00	H	XY	AV	40.57	-3.34	0.53	37.76	54.00	16.24
4876.00	V	XY	PK	51.70	-3.34	-	48.36	74.00	25.64
4876.00	V	XY	AV	39.75	-3.34	0.53	36.94	54.00	17.06

* QP : Quasi-Peak / PK : peak / AV : average

* No other spurious and harmonic emissions were found greater than listed emissions on above table.

* Above listed point data is the worst case data

* Margin = Limit – Result / Result = Reading + Total Factor+ DCF

10.3.9 mode : 802.11n / MCS6 / 2 462 MHz

Freq (MHz)	ANT (H/V)	EUT (X,Y,Z)	Detector	Reading (dBμV)	Total Factor(dB)	DCF (dB)	Result (dBμV/m)	Limit (dB)	Margin (dB)
500.45	V	XY	QP	11.70	19.82	-	31.52	46.00	14.48
2483.85	V	XY	PK	74.03	-9.31	-	64.72	74.00	9.28
2483.62	V	XY	AV	60.12	-9.28	0.53	51.37	54.00	2.63
2483.62	H	XY	PK	73.11	-9.31	-	63.80	74.00	10.20
2483.68	H	XY	AV	59.94	-9.28	0.53	51.19	54.00	2.81
4920.00	V	XY	PK	53.04	-3.23	-	49.81	74.00	24.19
4920.00	V	XY	AV	40.76	-3.23	0.53	38.06	54.00	15.94
4920.00	H	XY	PK	52.64	-3.23	-	49.41	74.00	24.59
4920.00	H	XY	AV	40.24	-3.23	0.53	37.54	54.00	16.46

- * QP : Quasi-Peak / PK : peak / AV : average
- * No other spurious and harmonic emissions were found greater than listed emissions on above table.
- * Above listed point data is the worst case data
- * Margin = Limit – Result / Result = Reading + Total Factor+ DCF

11. AC Power Line Conducted Emissions

11.1 Definition

The EUT was evaluated to determine compliance with FCC section 15.207

11.2 Test Procedure

ANSI C63.4 sections 6 and 7 were the guiding documents for this evaluation. Conducted emissions were performed from 150kHz to 30MHz with the EMI Receiver (ESCS30) set to 9kHz. The calculation for the conducted emissions is as follows:

Corrected Reading = EMI Receiver Reading + LISN Factor + Cable Loss

Margin = Corrected Reading - Applicable Limit

11.3 Test Criteria

Except as shown in paragraphs (b) and (c) of this section, for an intentional radiator that is designed to be connected to the public utility (AC) power line, the radio frequency voltage that is conducted back onto the AC power line on any frequency or frequencies, within the band 150 kHz to 30 MHz, shall not exceed the limits in the following table, as measured using a 50 μ H/50 ohms line impedance stabilization network (LISN). Compliance with the provisions of this paragraph shall be based on the measurement of the radio frequency voltage between each power line and ground at the power terminal. The lower limit applies at the boundary between the frequency ranges

Frequency in emission (MHz)	Conducted Limit (dB μ V)	
	Quasi-Peak	Average
0.15 ~ 0.5	66 to 56*	56 to 46*
0.5 ~ 5.0	56	46
5 ~ 30	60	50

* Decreases with the logarithm of the frequency

11.4 Test Results

11.4.1 mode : 802.11b / 1 Mbps / 2.412 MHz

<HOT LINE>

Freq. [MHz]	Corr. Factor [dB]		Phase	Quasi-Peak			Average		
	LISN	Cable		Limit	Level	Margin	Limit	Level	Margin
				[dB(μV)]	[dB(μV)]	[dB(μV)]	[dB(μV)]	[dB(μV)]	[dB(μV)]
0.392	9.89	0.01	H	58.02	39.15	18.87	48.02	31.99	16.03
0.423	9.90	0.01	H	57.38	43.41	13.97	47.38	34.49	12.89
0.748	9.84	0.03	H	56	31.52	24.48	46	24.01	21.99
0.830	9.81	0.03	H		32.80	23.20		22.01	23.99
1.041	9.76	0.03	H		31.83	24.17		23.05	22.95
4.447	9.68	0.07	H		31.35	24.65		24.09	21.91

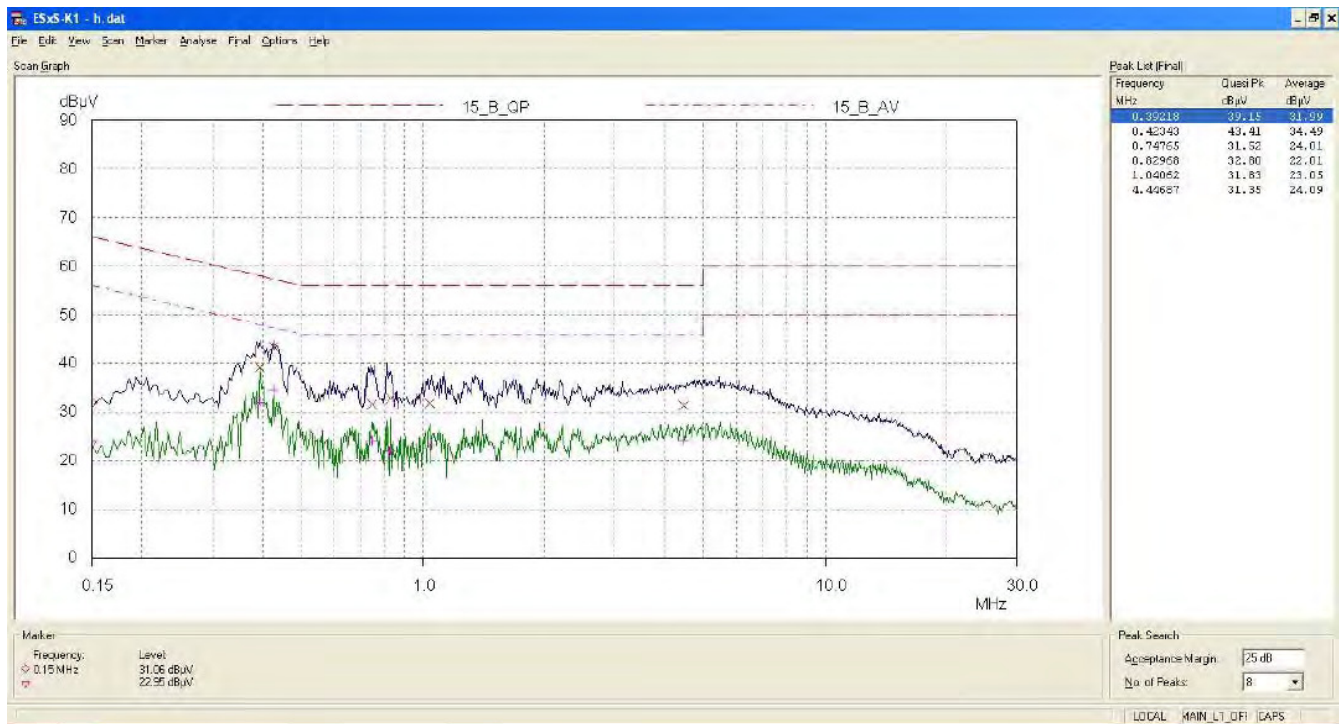

<NETURAL LINE>

Freq. [MHz]	Corr. Factor [dB]		Phase	Quasi-Peak			Average		
	LISN	Cable		Limit	Level	Margin	Limit	Level	Margin
				[dB(μV)]	[dB(μV)]	[dB(μV)]	[dB(μV)]	[dB(μV)]	[dB(μV)]
0.177	9.96	0.01	N	64.61	28.02	36.59	54.61	21.25	33.36
0.404	9.90	0.01	N	57.77	39.33	18.44	47.77	34.19	13.58
0.517	9.91	0.02	N	56	31.09	24.91	46	23.36	22.64
2.201	9.69	0.05	N		25.91	30.09		18.88	27.12
4.302	9.68	0.07	N		28.29	27.71		20.94	25.06
6.326	9.69	0.09	N	60	27.11	32.89	50	19.22	30.78

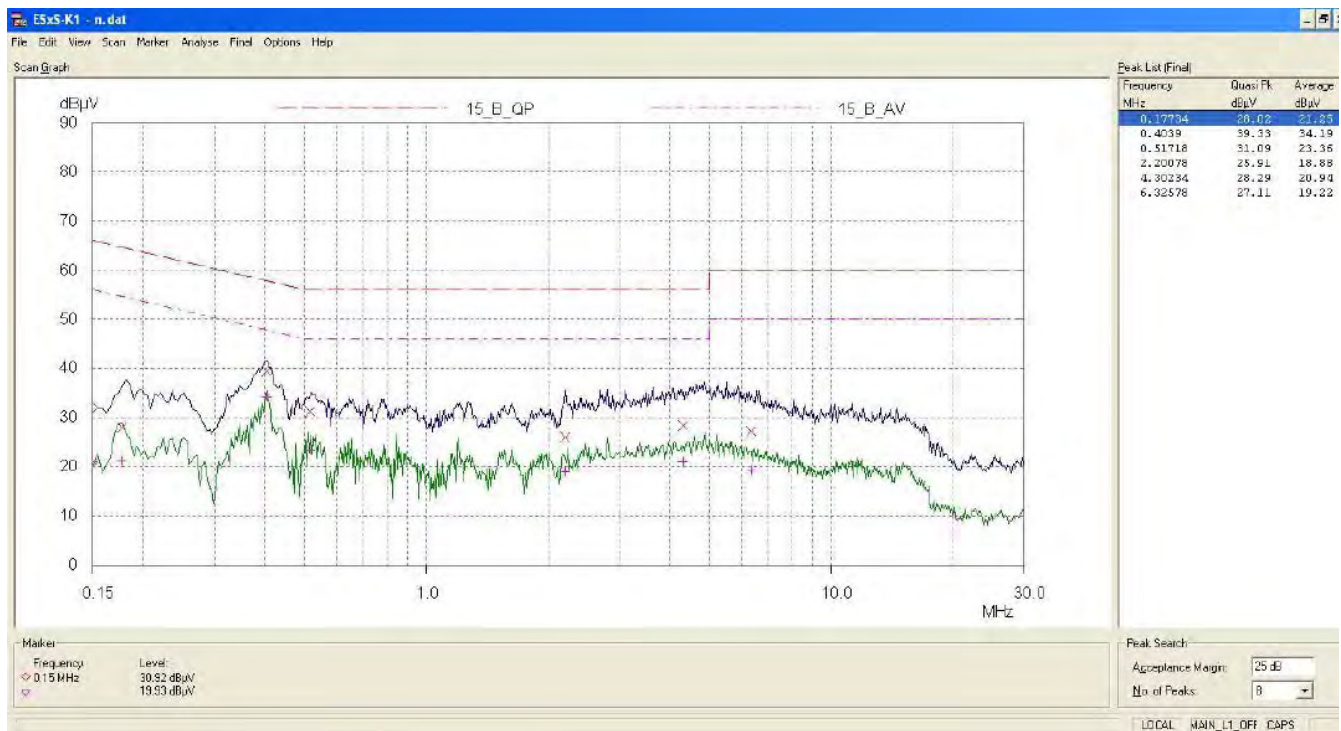

11.4.2 mode : 802.11g / 36 Mbps / 2 412 MHz

<HOT LINE>

Freq. [MHz]	Corr. Factor [dB]		Phase	Quasi-Peak			Average		
	LISN	Cable		Limit	Level	Margin	Limit	Level	Margin
				[dB(μV)]	[dB(μV)]	[dB(μV)]	[dB(μV)]	[dB(μV)]	[dB(μV)]
0.408	9.90	0.01	H	57.69	40.93	16.76	47.69	35.37	12.32
0.541	9.91	0.02	H	56	33.18	22.82	46	23.95	22.05
0.670	9.86	0.03	H		33.84	22.16		24.04	21.96
0.939	9.78	0.03	N		30.65	25.35		20.46	25.54
1.322	9.73	0.04	N		31.25	24.75		21.84	24.16
1.759	9.69	0.05	N		29.60	26.40		21.73	24.27

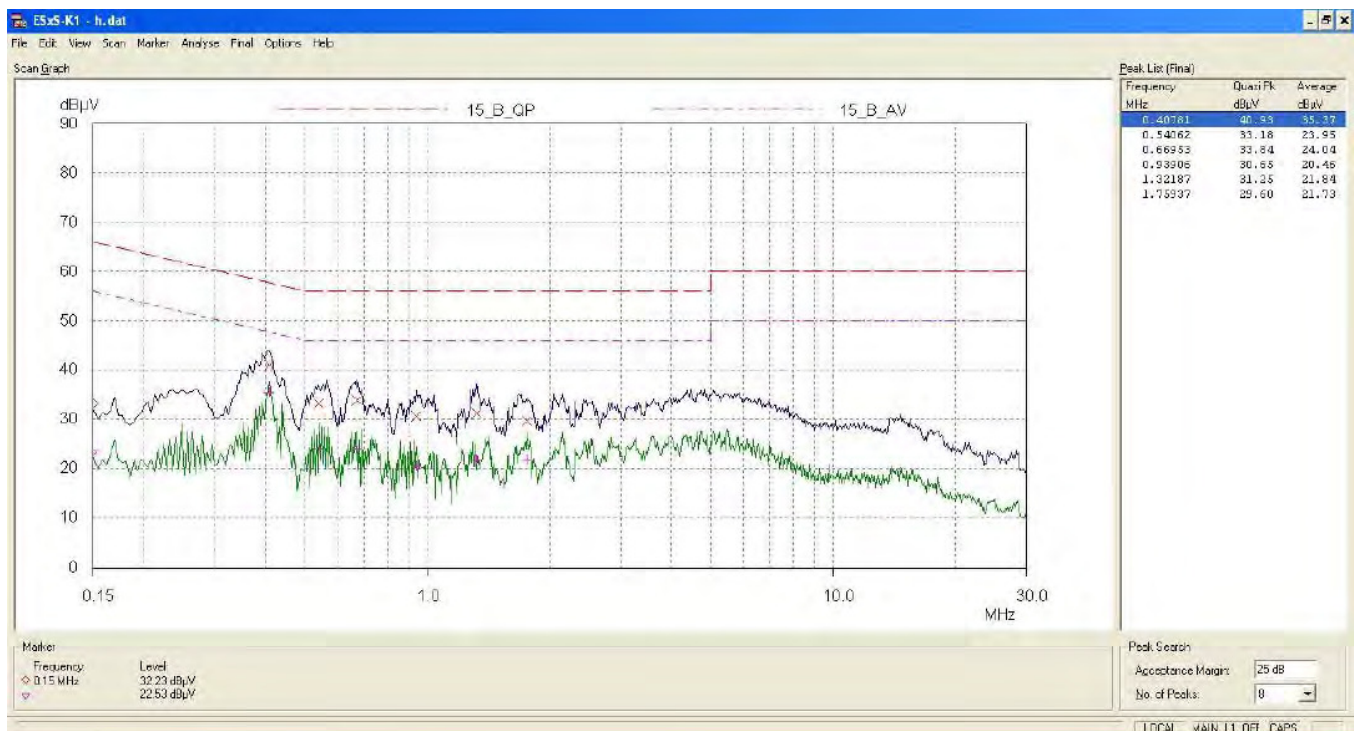

<NETURAL LINE>

Freq. [MHz]	Corr. Factor [dB]		Phase	Quasi-Peak			Average		
	LISN	Cable		Limit	Level	Margin	Limit	Level	Margin
				[dB(μV)]	[dB(μV)]	[dB(μV)]	[dB(μV)]	[dB(μV)]	[dB(μV)]
0.392	9.89	0.01	N	58.02	38.37	19.65	48.02	33.01	15.01
0.416	9.90	0.01	N	57.54	36.56	20.98	47.54	31.01	16.53
0.463	9.91	0.02	N	56.65	31.63	25.02	46.65	21.65	25.00
0.724	9.84	0.03	N	56	32.91	23.09	46	25.47	20.53
1.943	9.69	0.05	N		27.82	28.18		20.64	25.36
4.444	9.68	0.07	N		28.82	27.18		21.61	24.39

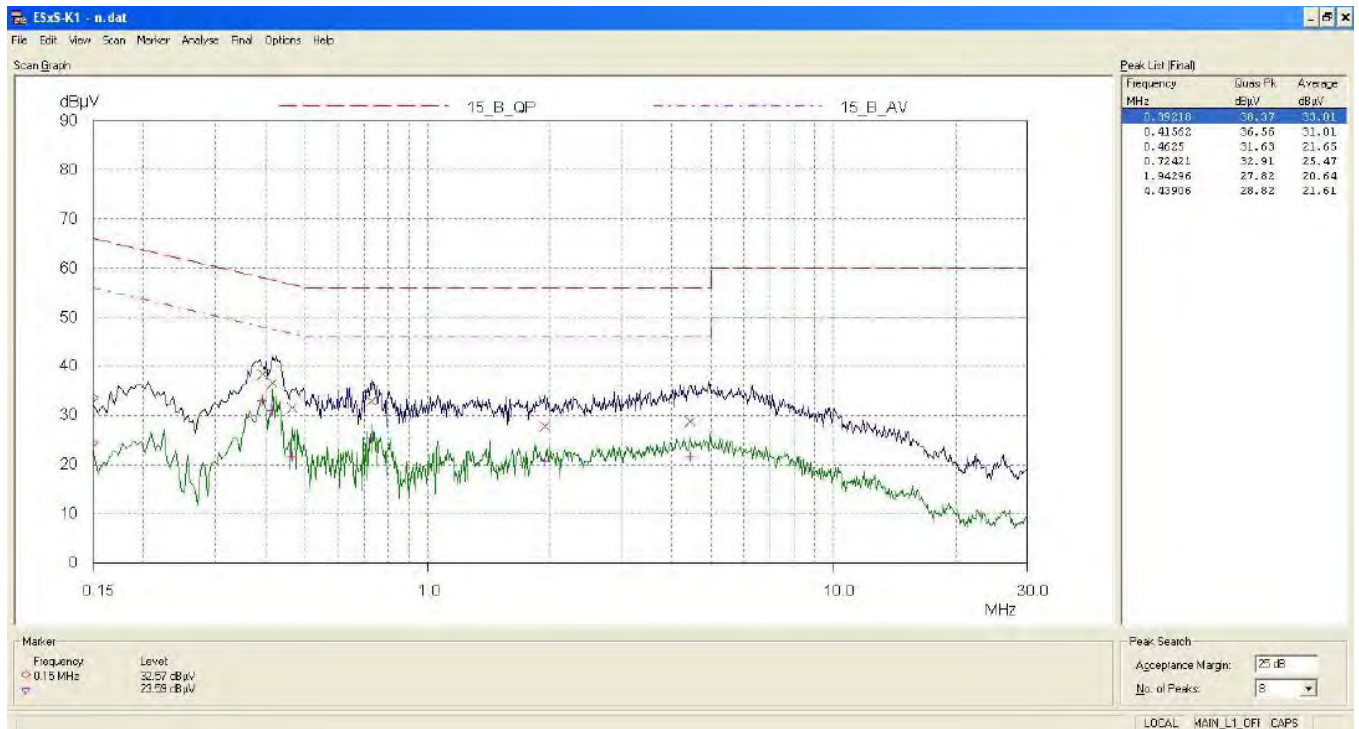

11.4.3 mode : 802.11n / MCS6 / 2 412 MHz

<HOT LINE>

Freq. [MHz]	Corr. Factor [dB]		Phase	Quasi-Peak			Average		
	LISN	Cable		Limit	Level	Margin	Limit	Level	Margin
				[dB(μV)]	[dB(μV)]	[dB(μV)]	[dB(μV)]	[dB(μV)]	[dB(μV)]
0.365	9.86	0.01	H	58.62	37.98	20.64	48.62	31.23	17.39
0.408	9.90	0.01	H	57.69	37.60	20.09	47.69	33.98	13.71
0.439	9.91	0.01	H	57.08	36.64	20.44	47.08	28.87	18.21
0.548	9.91	0.02	H	56	29.28	26.72	46	22.59	23.41
0.658	9.87	0.03	H		31.55	24.45		24.80	21.20
1.017	9.77	0.03	H		30.09	25.91		21.00	25.00

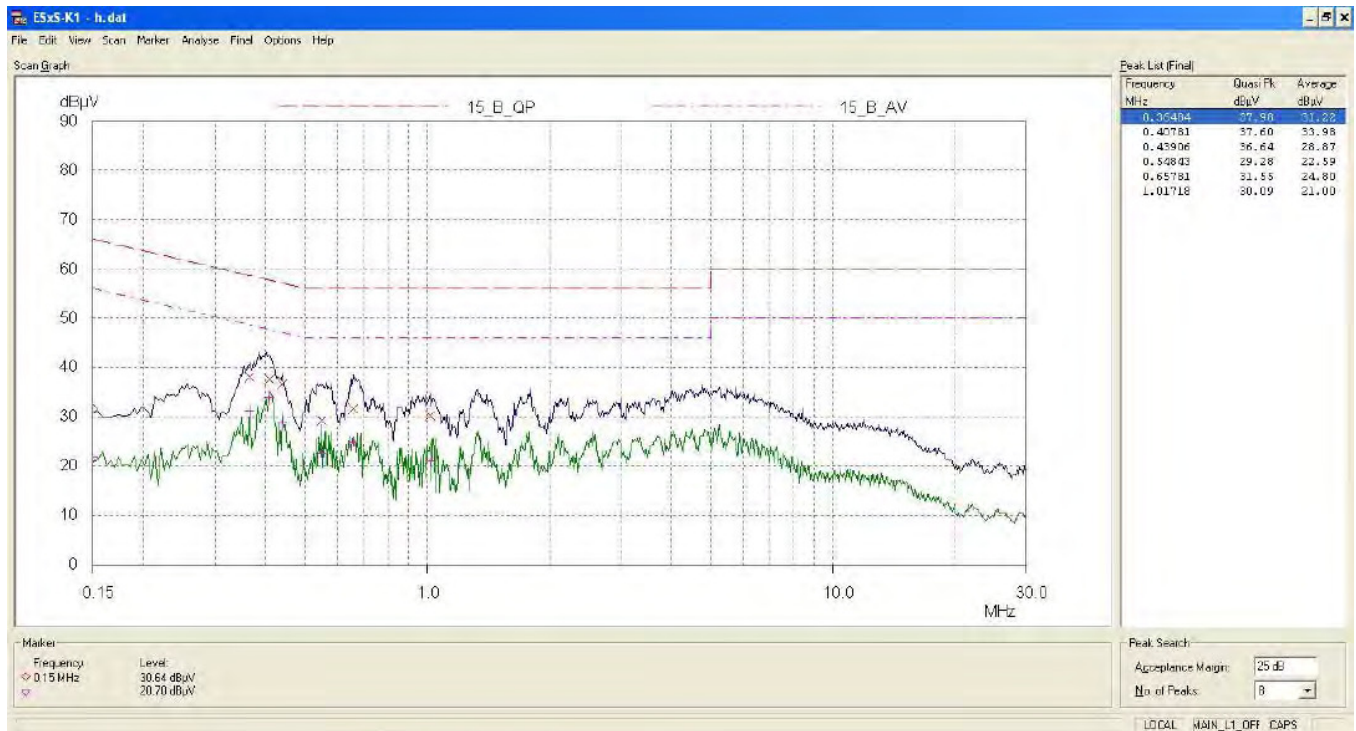

<NETURAL LINE>

Freq. [MHz]	Corr. Factor [dB]		Phase	Quasi-Peak			Average		
	LISN	Cable		Limit	Level	Margin	Limit	Level	Margin
				[dB(μV)]	[dB(μV)]	[dB(μV)]	[dB(μV)]	[dB(μV)]	[dB(μV)]
0.240	9.68	0.01	H	62.10	29.92	32.18	52.10	23.36	28.74
0.365	9.86	0.01	H	58.62	34.03	24.59	48.62	27.60	21.02
0.408	9.90	0.01	H	57.69	37.44	20.25	47.69	32.36	15.33
0.666	9.86	0.03	H	56	31.25	24.75	46	25.02	20.98
0.963	9.78	0.03	H		27.74	28.26		20.19	25.81
4.486	9.68	0.07	H		29.06	26.94		21.52	24.48

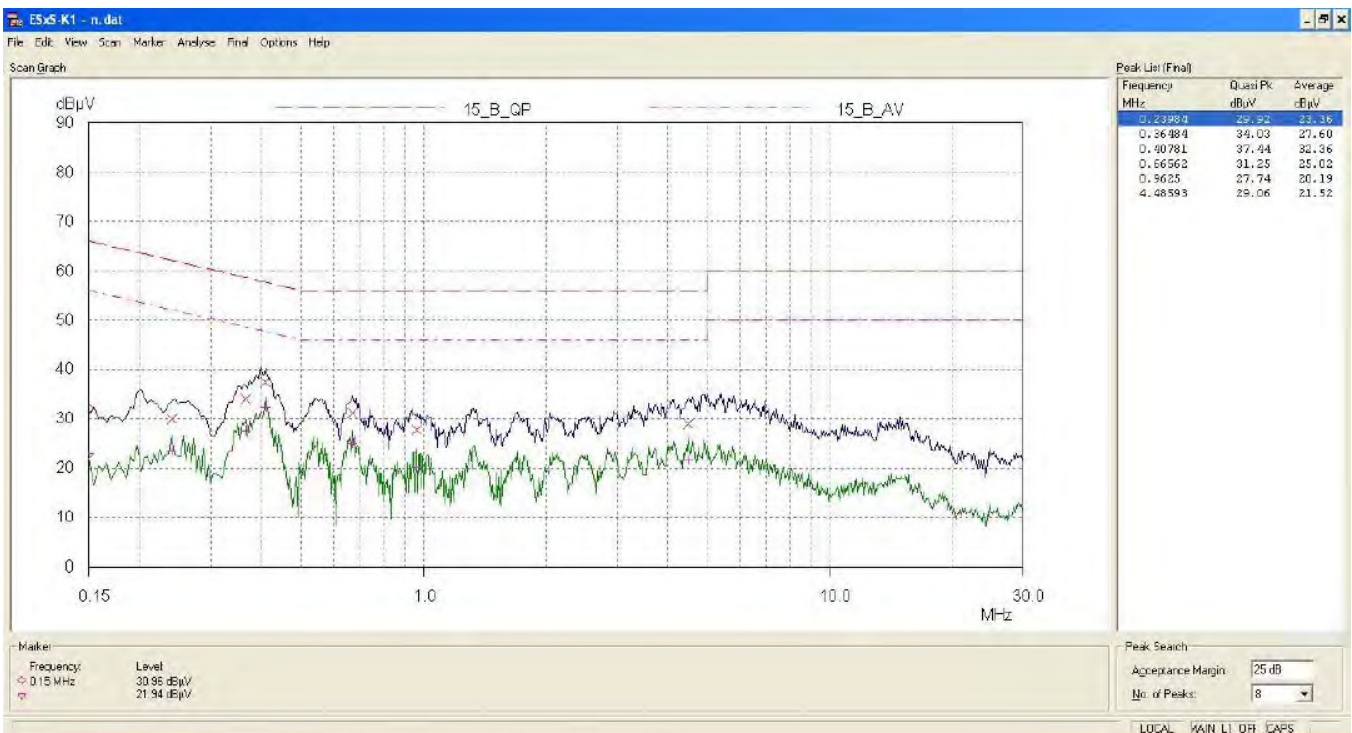

12. Antenna Requirement

12.1 Definition

An intentional radiator shall be designed to ensure that no antenna other than that furnished by the responsible party shall be used with the device.

12.2 Test Criteria

The use of a permanently attached antenna or of an antenna that uses a unique coupling to the intentional radiator shall be considered sufficient to comply with the provisions of this section. The manufacturer may design the unit so that a broken antenna can be replaced by the user, but the use of a standard antenna jack or electrical connector is prohibited. This requirement does not apply to carrier current devices or to devices operated under the provisions of §15.211, §15.213, §15.217, §15.219, or §15.221. Further, this requirement does not apply to intentional radiators that must be professionally installed, such as perimeter protection systems and some field disturbance sensors, or to other intentional radiators which, in accordance with §15.31(d), must be measured at the installation site. However, the installer shall be responsible for ensuring that the proper antenna is employed so that the limits in this part are not exceeded.

12.3 Test Result

The antenna used a PIFA antenna(Intenna). It's gain is 1.3 dBi below (Dip Connection)

