

# SAR EVALUATION REPORT

For

## Franklin Technology Inc.

906 JEI Platz, 459-11, Gasan-Dong, Geumcheon-Gu, Seoul, Korea

**FCC ID: XHG-R774**

<b>Report Type:</b> Original Report	<b>Product Type:</b> LTE/WIFI MOBILE ROUTER
<b>Test Engineer:</b> Wilson Chen	<i>Wilson Chen</i>
<b>Report Number:</b> RSZ140515005-20	
<b>Report Date:</b> 2014-06-02	
<b>Reviewed By:</b> Sandy Wang SAR Engineer	<i>Sandy Wang</i>
<b>Prepared By:</b> Bay Area Compliance Laboratories Corp. (Shenzhen) 6/F, the 3rd Phase of WanLi Industrial Building, ShiHua Road, FuTian Free Trade Zone Shenzhen, Guangdong, China Tel: +86-755-33320018 Fax: +86-755-33320008 <a href="http://www.baclcorp.com.cn">www.baclcorp.com.cn</a>	

]

**Note:** This test report is prepared for the customer shown above and for the equipment described herein. It may not be duplicated or used in part without prior written consent from Bay Area Compliance Laboratories Corp.

Attestation of Test Results		
<b>EUT Information</b>	<b>Company Name</b>	Franklin Technology Inc.
	<b>EUT Description</b>	LTE/WIFI MOBILE ROUTER
	<b>FCC ID</b>	XHG-R774
	<b>Model Number</b>	R774
	<b>Test Date</b>	2014-05-25 and 2014-05-26
<b>Frequency</b>	<b>Max. SAR Level(s) Reported</b>	<b>Limit(W/Kg)</b>
<b>LTE Band 12</b>	0.560 W/kg 1g Body SAR	1.6
<b>LTE Band 25</b>	1.193 W/kg 1g Body SAR	
<b>CDMA BC 0</b>	0.795W/kg 1g Body SAR	
<b>CDMA BC1</b>	1.411 W/kg 1g Body SAR	
<b>Wifi (802.11b)</b>	0.083 W/kg 1g Body SAR	
<b>Simultaneous</b>	1.446 W/kg 1g Body SAR	
<b>Applicable Standards</b>	<b>ANSI / IEEE C95.1 : 2005</b> IEEE Standard for Safety Levels with Respect to Human Exposure to Radio Frequency Electromagnetic Fields,3 kHz to 300 GHz.	
	<b>ANSI / IEEE C95.3 : 2002</b> IEEE Recommended Practice for Measurements and Computations of Radio Frequency Electromagnetic Fields With Respect to Human Exposure to Such Fields,100 kHz—300 GHz.	
	<b>IEEE1528:2003</b> IEEE Recommended Practice for Determining the Peak Spatial-Average Specific Absorption Rate (SAR) in the Human Head from Wireless Communications Devices: Measurement Techniques	
	<b>KDB procedures</b> KDB 447498 D01 Mobile and Portable Devices RF Exposure Procedures and Equipment Authorization Policies. KDB 248227 D01 SAR Measurement Procedures for 802.11a/b/g Transmitters KDB 941225 D01 SAR Measurement Procedures for 3G Devices-CDMA 2000/EV-Do WCDMA/HSDPA/HSUPA KDB 941225 D05 SAR Evaluation Considerations for LTE Devices KDB 941225 D06 SAR Evaluation Procedures for Portable Devices with Wireless Router Capabilities.	
<p><b>Note:</b> This wireless device has been shown to be capable of compliance for localized specific absorption rate (SAR) for General Population/Uncontrolled Exposure limits specified in ANSI/IEEE Standards and has been tested in accordance with the measurement procedures specified in IEEE 1528-2003 and RF exposure KDB procedures.</p> <p><b>The results and statements contained in this report pertain only to the device(s) evaluated.</b></p>		

## TABLE OF CONTENTS

**DOCUMENT REVISION HISTORY .....4**

**EUT DESCRIPTION .....5**

    TECHNICAL SPECIFICATION .....5

**REFERENCE, STANDARDS, AND GUIDELINES .....6**

    SAR LIMITS .....7

**FACILITIES .....8**

**DESCRIPTION OF TEST SYSTEM .....9**

**EQUIPMENT LIST AND CALIBRATION .....16**

    EQUIPMENTS LIST & CALIBRATION INFORMATION .....16

**SAR MEASUREMENT SYSTEM VERIFICATION .....17**

    LIQUID VERIFICATION .....17

    SYSTEM ACCURACY VERIFICATION .....20

    SAR SYSTEM VALIDATION DATA .....21

**EUT TEST STRATEGY AND METHODOLOGY .....29**

    TEST POSITIONS FOR DEVICE OPERATING NEXT TO A PERSON’S EAR .....29

    CHEEK/TOUCH POSITION .....30

    EAR/TILT POSITION .....30

    TEST POSITIONS FOR BODY-WORN AND OTHER CONFIGURATIONS .....31

    SAR EVALUATION PROCEDURE .....32

**CONDUCTED OUTPUT POWER MEASUREMENT .....33**

    PROVISION APPLICABLE .....33

    TEST PROCEDURE .....33

    TEST RESULTS: .....33

    MAXIMUM OUTPUT POWER AMONG PRODUCTION UNITS .....33

**SAR MEASUREMENT RESULTS .....39**

**APPENDIX A MEASUREMENT UNCERTAINTY .....85**

**APPENDIX B – PROBE CALIBRATION CERTIFICATES .....86**

**APPENDIX C DIPOLE CALIBRATION CERTIFICATES .....96**

**APPENDIX E INFORMATIVE REFERENCES .....135**

---

## DOCUMENT REVISION HISTORY

---

Revision Number	Report Number	Description of Revision	Date of Revision
0	RSZ140515005-20	Original Report	2014-06-02

## EUT DESCRIPTION

This report has been prepared on behalf of Franklin Technology Inc. and their product, FCC ID: XHG-R774, Model: R774 or the EUT (Equipment under Test) as referred to in the rest of this report. The EUT is a LTE/WIFI MOBILE ROUTER.

### Technical Specification

<b>Product Type</b>	Portable
<b>Exposure Category:</b>	Population / Uncontrolled
<b>Antenna Type(s):</b>	Internal Antenna
<b>Body-Worn Accessories:</b>	None
<b>Hotspot:</b>	Support
<b>Operation Mode :</b>	WiFi, LTE and CDMA
<b>Frequency Band:</b>	WiFi: 2412MHz-2462MHz LTE Band 12: 698-716 MHz(TX) ; 728-746MHz(RX) LTE Band 25: 1850-1915 MHz(TX) ; 1930-1995 MHz(RX) CDMA BC0 Band : 824-849 MHz(TX) ; 869-894 MHz(RX) CDMA BC1 Band: 1850-1910 MHz(TX) ; 1930-1990 MHz(RX)
<b>Conducted RF Power:</b>	WiFi: 15.30dBm LTE Band 12: 22.58dBm LTE Band 25: 23.46dBm CDMA BC0 :24.08 dBm CDMA BC1 Band: 24.15dBm
<b>Dimensions (L*W*H):</b>	100mm (L) × 60 mm (W) × 16mm (H)
<b>Power Source:</b>	3.7 V <sub>DC</sub> 1800mAh Rechargeable Battery
<b>Normal Operation:</b>	Body-Support

---

## REFERENCE, STANDARDS, AND GUIDELINES

---

### **FCC:**

The Report and Order requires routine SAR evaluation prior to equipment authorization of portable transmitter devices, including portable telephones. For consumer products, the applicable limit is 1.6 mW/g as recommended by the ANSI/IEEE standard C95.1-1992 [6] for an uncontrolled environment (Paragraph 65). According to the Supplement C of OET Bulletin 65 "Evaluating Compliance with FCC Guide-lines for Human Exposure to Radio frequency Electromagnetic Fields", released on Jun 29, 2001 by the FCC, the device should be evaluated at maximum output power (radiated from the antenna) under "worst-case" conditions for normal or intended use, incorporating normal antenna operating positions, device peak performance frequencies and positions for maximum RF energy coupling.

This report describes the methodology and results of experiments performed on wireless data terminal. The objective was to determine if there is RF radiation and if radiation is found, what is the extent of radiation with respect to safety limits. SAR (Specific Absorption Rate) is the measure of RF exposure determined by the amount of RF energy absorbed by human body (or its parts) – to determine how the RF energy couples to the body or head which is a primary health concern for body worn devices. The limit below which the exposure to RF is considered safe by regulatory bodies in North America is 1.6 mW/g average over 1 gram of tissue mass.

### **CE:**

The order requires routine SAR evaluation prior to equipment authorization of portable transmitter devices, including portable telephones. For consumer products, the applicable limit is 2 mW/g as recommended by EN62209-1 for an uncontrolled environment. According to the Standard, the device should be evaluated at maximum output power (radiated from the antenna) under "worst-case" conditions for normal or intended use, incorporating normal antenna operating positions, device peak performance frequencies and positions for maximum RF energy coupling.

This report describes the methodology and results of experiments performed on wireless data terminal. The objective was to determine if there is RF radiation and if radiation is found, what is the extent of radiation with respect to safety limits. SAR (Specific Absorption Rate) is the measure of RF exposure determined by the amount of RF energy absorbed by human body (or its parts) – to determine how the RF energy couples to the body or head which is a primary health concern for body worn devices. The limit below which the exposure to RF is considered safe by regulatory bodies in Europe is 2 mW/g average over 10 gram of tissue mass.

The test configurations were laid out on a specially designed test fixture to ensure the reproducibility of measurements. Each configuration was scanned for SAR. Analysis of each scan was carried out to characterize the above effects in the device.

**SAR Limits**

FCC Limit (1g Tissue)

EXPOSURE LIMITS	SAR (W/kg)	
	(General Population / Uncontrolled Exposure Environment)	(Occupational / Controlled Exposure Environment)
Spatial Average (averaged over the whole body)	0.08	0.4
Spatial Peak (averaged over any 1 g of tissue)	1.60	8.0
Spatial Peak (hands/wrists/feet/ankles averaged over 10 g)	4.0	20.0

CE Limit (10g Tissue)

EXPOSURE LIMITS	SAR (W/kg)	
	(General Population / Uncontrolled Exposure Environment)	(Occupational / Controlled Exposure Environment)
Spatial Average (averaged over the whole body)	0.08	0.4
Spatial Peak (averaged over any 10 g of tissue)	2.0	10
Spatial Peak (hands/wrists/feet/ankles averaged over 10 g)	4.0	20.0

Population/Uncontrolled Environments are defined as locations where there is the exposure of individual who have no knowledge or control of their exposure.

Occupational/Controlled Environments are defined as locations where there is exposure that may be incurred by people who are aware of the potential for exposure (i.e. as a result of employment or occupation).

General Population/Uncontrolled environments Spatial Peak limit 1.6W/kg (FCC) & 2 W/kg (CE) applied to the EUT.

## **FACILITIES**

---

The test site used by Bay Area Compliance Laboratories Corp. (Shenzhen) to collect data is located at 6/F, the 3rd Phase of WanLi Industrial Building, Shi Hua Road, Fu Tian Free Trade Zone, Shenzhen, Guangdong, P.R. of China



## DESCRIPTION OF TEST SYSTEM

These measurements were performed with ALSAS 10 Universal Integrated SAR Measurement system from APREL Laboratories.

### ALSAS-10U System Description

ALSAS-10-U is fully compliant with the technical and scientific requirements of IEEE 1528, IEC 62209, CENELEC, ARIB, ACA, and the Federal Communications Commission. The system comprises of a six axes articulated robot which utilizes a dedicated controller. ALSAS-10U uses the latest methodologies. And FDTD modeling to provide a platform which is repeatable with minimum uncertainty.

### Applications

Predefined measurement procedures compliant with the guidelines of CENELEC, IEEE, IEC, FCC, etc are utilized during the assessment for the device. Automatic detection for all SAR maxima are embedded within the core architecture for the system, ensuring that peak locations used for centering the zoom scan are within a 1mm resolution and a 0.05mm repeatable position. System operation range currently available up-to 6 GHz in simulated tissue.

### Area Scans

Area scans are defined prior to the measurement process being executed with a user defined variable spacing between each measurement point (integral) allowing low uncertainty measurements to be conducted. Scans defined for FCC applications utilize a 10mm<sup>2</sup> step integral, with 1mm interpolation used to locate the peak SAR area used for zoom scan assessments.

Where the system identifies multiple SAR peaks (which are within 25% of peak value) the system will provide the user with the option of assessing each peak location individually for zoom scan averaging.

### Zoom Scan (Cube Scan Averaging)

The averaging zoom scan volume utilized in the ALSAS-10U software is in the shape of a cube and the side dimension of a 1 g or 10 g mass is dependent on the density of the liquid representing the simulated tissue. A density of 1000 kg/m<sup>3</sup> is used to represent the head and body tissue density and not the phantom liquid density, in order to be consistent with the definition of the liquid dielectric properties, i.e. the side length of the 1 g cube is 10mm, with the side length of the 10 g cube 21,5mm.

When the cube intersects with the surface of the phantom, it is oriented so that 3 vertices touch the surface of the shell or the center of a face is tangent to the surface. The face of the cube closest to the surface is modified in order to conform to the tangent surface.

The zoom scan integer steps can be user defined so as to reduce uncertainty, but normal practice for typical test applications (including FCC) utilize a physical step of 5x5x8 (8mmx8mmx5mm) providing a volume of 32mm in the X & Y axis, and 35mm in the Z axis.



### ALSAS-10U Interpolation and Extrapolation Uncertainty

The overall uncertainty for the methodology and algorithms the used during the SAR calculation was evaluated using the data from IEEE 1528 based on the example f3 algorithm:

$$f_3(x, y, z) = A \frac{a^2}{\frac{a^2}{4} + x'^2 + y'^2} \cdot \left( e^{-\frac{2z}{a}} + \frac{a^2}{2(a + 2z)^2} \right)$$

### Isotropic E-Field Probe

The isotropic E-Field probe has been fully calibrated and assessed for isotropicity, and boundary effect within a controlled environment. Depending on the frequency for which the probe is calibrated the method utilized for calibration will change.

The E-Field probe utilizes a triangular sensor arrangement as detailed in the diagram below:

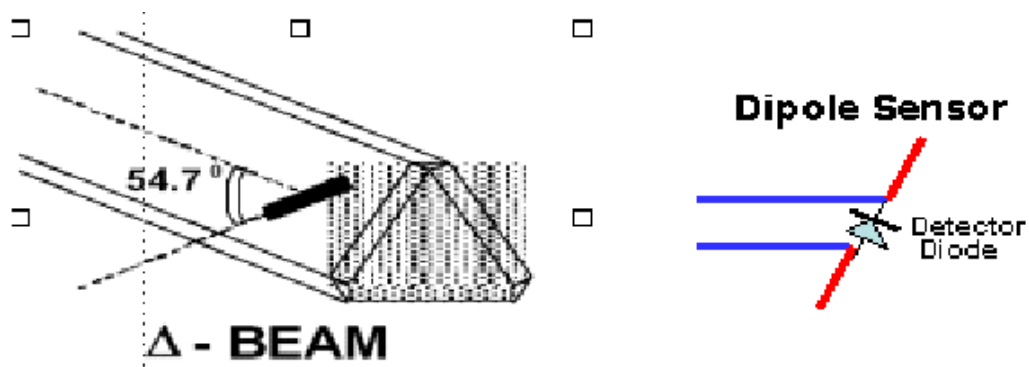

SAR is assessed with a calibrated probe which moves at a default height of 5mm from the center of the diode, which is mounted to the sensor, to the phantom surface (in the Z Axis). The 5mm offset height has been selected so as to minimize any resultant boundary effect due to the probe being in close proximity to the phantom surface.

The following algorithm is an example of the function used by the system for linearization of the output from the probe when measuring complex modulation schemes.

$$V_i = U_i + U_i^2 \cdot \frac{cf}{dcp_i}$$

### Isotropic E-Field Probe Specification

<b>Calibration Method</b>	Frequency Dependent Below 1 GHz Calibration in air performed in a TEM Cell Above 1 GHz Calibration in air performed in waveguide
<b>Sensitivity</b>	0.70 $\mu\text{V}/(\text{V}/\text{m})^2$ to 0.85 $\mu\text{V}/(\text{V}/\text{m})^2$
<b>Dynamic Range</b>	0.0005 W/kg to 100 W/kg
<b>Isotropic Response</b>	Better than 0.1 dB
<b>Diode Compression Point (DCP)</b>	Calibration for Specific Frequency
<b>Probe Tip Diameter</b>	< 2.9 mm
<b>Sensor Offset</b>	1.56 (+/- 0.02 mm)
<b>Probe Length</b>	289 mm
<b>Video Bandwidth</b>	@ 500 Hz: 1 dB @ 1.02 kHz: 3 dB
<b>Boundary Effect</b>	Less than 2.1% for distance greater than 0.58 mm
<b>Spatial Resolution</b>	The spatial resolution uncertainty is less than 1.5% for 4.9mm diameter probe. The spatial resolution uncertainty is less than 1.0% for 2.5mm diameter probe

### Boundary Detection Unit and Probe Mounting Device

ALSAS-10U incorporates a boundary detection unit with a sensitivity of 0.05mm for detecting all types of surfaces. The robust design allows for detection during probe tilt (probe normalize) exercises, and utilizes a second stage emergency stop. The signal electronics are fed directly into the robot controller for high accuracy surface detection in lateral and axial detection modes (X, Y, & Z).

The probe is mounted directly onto the Boundary Detection unit for accurate tooling and displacement calculations controlled by the robot kinematics. The probe is connect to an isolated probe interconnect where the output stage of the probe is fed directly into the amplifier stage of the Daq-Paq.

### Daq-Paq (Analog to Digital Electronics)

ALSAS-10U incorporates a fully calibrated Daq-Paq (analog to digital conversion system) which has a 4 channel input stage, sent via a 2 stage auto-set amplifier module. The input signal is amplified accordingly so as to offer a dynamic range from 5 $\mu\text{V}$  to 800mV. Integration of the fields measured is carried out at board level utilizing a Co-Processor which then sends the measured fields down into the main computational module in digitized form via an RS232 communications port. Probe linearity and duty cycle compensation is carried out within the main Daq-Paq module.

<b>ADC</b>	12 Bit
<b>Amplifier Range</b>	20 mV to 200 mV and 150 mV to 800 mV
<b>Field Integration</b>	Local Co-Processor utilizing proprietary integration algorithms
<b>Number of Input Channels</b>	4 in total 3 dedicated and 1 spare
<b>Communication</b>	Packet data via RS232

**Axis Articulated Robot**

ALSAS-10U utilizes a six axis articulated robot, which is controlled using a Pentium based real-time movement controller. The movement kinematics engine utilizes proprietary (Thermo CRS) interpolation and extrapolation algorithms, which allow full freedom of movement for each of the six joints within the working envelope. Utilization of joint 6 allows for full probe rotation with a tolerance better than 0.05mm around the central axis.



<b>Robot/Controller Manufacturer</b>	Thermo CRS
<b>Number of Axis</b>	Six independently controlled axis
<b>Positioning Repeatability</b>	0.05 mm
<b>Controller Type</b>	Single phase Pentium based C500C
<b>Robot Reach</b>	710 mm
<b>Communication</b>	RS232 and LAN compatible

**ALSAS Universal Workstation**

ALSAS Universal workstation allows for repeatability and fast adaptability. It allows users to do calibration, testing and measurements using different types of phantoms with one set up, which significantly speeds up the measurement process.

**Universal Device Positioner**

The universal device positioner allows complete freedom of movement of the EUT. Developed to hold a EUT in a free-space scenario any additional loading attributable to the material used in the construction of the positioner has been eliminated. Repeatability has been enhanced through the linear scales which form the design used to indicate positioning for any given test scenario in all major axes. A 15° tilt indicator is included for the of aid cheek to tilt movements for head SAR analysis. Overall uncertainty for measurements have been reduced due to the design of the Universal device positioner, which allows positioning of a device in as near to a free-space scenario as possible, and by providing the means for complete repeatability.



**Phantom Types**

The ALSAS-10U allows the integration of multiple phantom types. SAM Phantoms fully compliant with IEEE 1528, Universal Phantom, and Universal Flat.

**APREL SAM Phantoms**

The SAM phantoms developed using the IEEE SAM CAD file. They are fully compliant with the requirements for both IEEE 1528 and FCC Supplement C. Both the left and right SAM phantoms are interchangeable, transparent and include the IEEE 1528 grid with visible NF and MB lines.

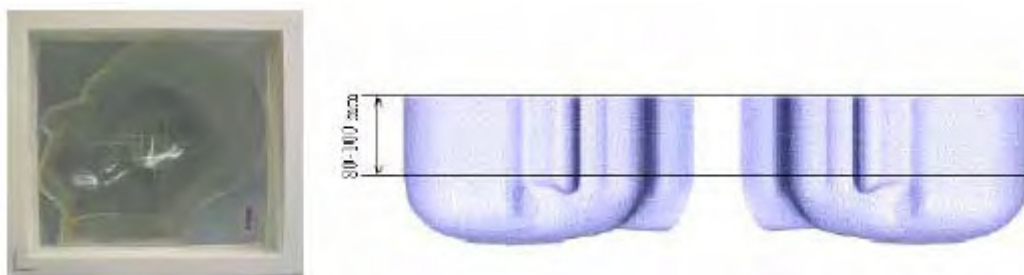

**APREL Laboratories Universal Phantom**

The Universal Phantom is used on the ALSAS-10U as a system validation phantom. The Universal Phantom has been fully validated both experimentally from 800MHz to 6GHz and numerically using XFDTD numerical software.

The shell thickness is 2mm overall, with a 4mm spacer located at the NF/MB intersection providing an overall thickness of 6mm in line with the requirements of IEEE-1528.

The design allows for fast and accurate measurements, of handsets, by allowing the conservative SAR to be evaluated at on frequency for both left and right head experiments in one measurement.



### Tissue Dielectric Parameters for Head and Body Phantoms

The head tissue dielectric parameters recommended by the IEEE SCC-34/SC-2 in P1528 have been incorporated in the following table. These head parameters are derived from planar layer models simulating the highest expected SAR for the dielectric properties and tissue thickness variations in a human head. Other head and body tissue parameters that have not been specified in P1528 are derived from the tissue dielectric parameters computed from the 4-Cole-Cole equations described in Reference [12] and extrapolated according to the head parameters specified in P1528.

Ingredients (% by weight)	Frequency (MHz)									
	450		835		915		1900		2450	
Tissue Type	Head	Body	Head	Body	Head	Body	Head	Body	Head	Body
Water	38.56	51.16	41.45	52.4	41.05	56.0	54.9	40.4	62.7	73.2
Salt (Nacl)	3.95	1.49	1.45	1.4	1.35	0.76	0.18	0.5	0.5	0.04
Sugar	56.32	46.78	56.0	45.0	56.5	41.76	0.0	58.0	0.0	0.0
HEC	0.98	0.52	1.0	1.0	1.0	1.21	0.0	1.0	0.0	0.0
Bactericide	0.19	0.05	0.1	0.1	0.1	0.27	0.0	0.1	0.0	0.0
Triton x-100	0.0	0.0	0.0	0.0	0.0	0.0	0.0	0.0	36.8	0.0
DGBE	0.0	0.0	0.0	0.0	0.0	0.0	44.92	0.0	0.0	26.7
Dielectric Constant	43.42	58.0	42.54	56.1	42.0	56.8	39.9	54.0	39.8	52.5
Conductivity (s/m)	0.85	0.83	0.91	0.95	1.0	1.07	1.42	1.45	1.88	1.78

### Recommended Tissue Dielectric Parameters for Head and Body

Frequency (MHz)	Head Tissue		Body Tissue	
	$\epsilon_r$	$\sigma$ (S/m)	$\epsilon_r$	$\sigma$ (S/m)
150	52.3	0.76	61.9	0.80
300	45.3	0.87	58.2	0.92
450	43.5	0.87	56.7	0.94
835	41.5	0.90	55.2	0.97
900	41.5	0.97	55.0	1.05
915	41.5	0.98	55.0	1.06
1450	40.5	1.20	54.0	1.30
1610	40.3	1.29	53.8	1.40
1800-2000	40.0	1.40	53.3	1.52
2450	39.2	1.80	52.7	1.95
3000	38.5	2.40	52.0	2.73
5800	35.3	5.27	48.2	6.00

## EQUIPMENT LIST AND CALIBRATION

### Equipments List & Calibration Information

Equipment	Model	Calibration Date	S/N
CRS F3 robot	ALS-F3	N/A	RAF0805352
CRS F3 Software	ALS-F3-SW	N/A	N/A
CRS C500C controller	ALS-C500	N/A	RCF0805379
Probe mounting device & Boundary Detection Sensor System	ALS-PMDPS-3	N/A	120-00270
Universal Work Station	ALS-UWS	N/A	100-00157
Data Acquisition Package	ALS-DAQ-PAQ-3	2013-10-08	110-00212
Miniature E-Field Probe	ALS-E-020	2013-10-08	500-00283
Dipole, 750MHz	ALS-D-750-S-2	2013-10-08	177-00505
Dipole, 835MHz	ALS-D-835-S-2	2011-08-25	180-00558
Dipole, 1900MHz	ALS-D-1900-S-2	2011-08-25	200-00659
Dipole, 2450MHz	ALS-D-2450-S-2	2011-08-25	220-00758
Dipole Spacer	ALS-DS-U	N/A	250-00907
Device holder/Positioner	ALS-H-E-SET-2	N/A	170-00510
Left ear SAM phantom	ALS-P-SAM-L	N/A	130-00311
Right ear SAM phantom	ALS-P-SAM-R	N/A	140-00359
UniPhantom	ALS-P-UP-1	N/A	150-00413
Simulated Tissue 705 MHz Body	ALS-TS-750-B	Each Time	265-01056
Simulated Tissue 850 MHz Body	ALS-TS-850-B	Each Time	280-02151
Simulated Tissue 1900 MHz Body	ALS-TS-1900-B	Each Time	290-02201
Simulated Tissue 2450 MHz Body	ALS-TS-2450-B	Each Time	290-01109
Power Amplifier	5S1G4	N/A	71377
Synthesized Sweeper	HP 8341B	2014-05-08	2624A00116
WIDEBAND RADIO COMMUNICATION TESTER	CMW500	2014-04-19	114772
EMI Test Receiver	ESCI	2013-11-12	101120



# SAR MEASUREMENT SYSTEM VERIFICATION

## Liquid Verification

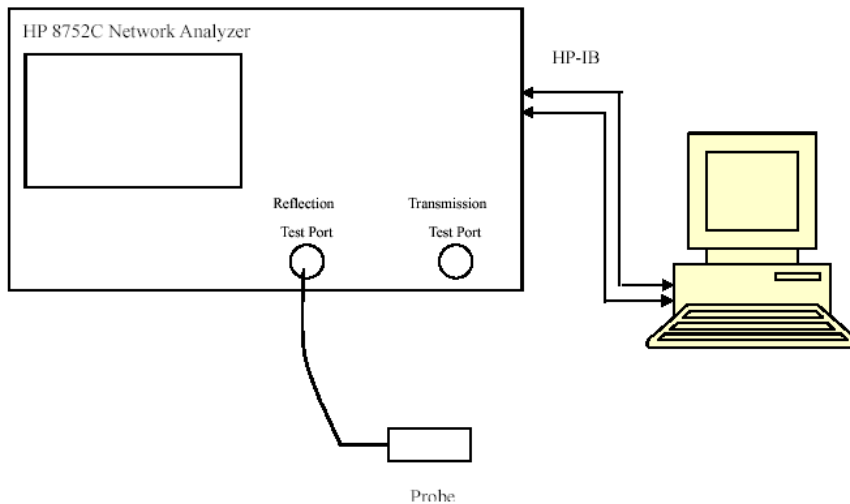

Liquid Verification Setup Block Diagram

## Liquid Verification Result

Frequency	Liquid Type	Liquid Parameter		Target Value		Delta (%)		Tolerance (%)
		$\epsilon_r$	$\sigma$ (S/m)	$\epsilon_r$	$\sigma$ (S/m)	$\Delta \epsilon_r$	$\Delta \sigma$ (S/m)	
701.50	Body	54.13	0.96	55.53	0.96	-2.521	0.000	±5
707.50	Body	54.02	0.96	55.53	0.96	-2.719	0.000	±5
713.50	Body	54.02	0.97	55.53	0.96	-2.719	1.042	±5
824.70	Body	54.63	0.95	55.20	0.97	-1.033	-2.062	±5
836.52	Body	54.70	0.97	55.20	0.97	-0.906	0.000	±5
848.31	Body	54.78	1.00	55.20	0.97	-0.761	3.093	±5
1851.25	Body	54.00	1.51	53.30	1.52	1.313	-0.658	±5
1852.50	Body	54.02	1.51	53.30	1.52	1.351	-0.658	±5
1880.00	Body	53.93	1.55	53.30	1.52	1.182	1.974	±5
1882.50	Body	53.78	1.56	53.30	1.52	0.901	2.632	±5
1908.75	Body	53.86	1.56	53.30	1.52	1.051	2.632	±5
1912.50	Body	53.89	1.57	53.30	1.52	1.107	3.289	±5
2412	Body	52.77	1.96	52.70	1.95	0.133	0.513	±5
2437	Body	52.78	1.95	52.70	1.95	0.152	0.000	±5
2462	Body	52.77	1.99	52.70	1.95	0.133	2.051	±5

\*Liquid Verification was performed on 2014-05-25

Please refer to the following tables.

750 MHz Body				835 MHz Body		
Frequency (MHz)	e'	e''		Frequency (MHz)	e'	e''
700.0	54.0387	24.5766		824.0	54.6222	20.8524
700.3	54.0376	24.5259		824.5	54.6253	20.7519
700.6	54.0760	24.5011		825.0	54.6284	20.7644
700.9	54.0353	24.5012		825.5	54.6316	20.7769
701.2	54.0730	24.4918		826.0	54.6347	20.9119
701.5	54.1345	24.5145		826.5	54.6379	20.9757
701.8	54.0881	24.4738		827.0	54.6410	20.8902
702.1	54.0411	24.4871		827.5	54.6441	20.7683
702.4	54.0191	24.5361		828.0	54.6473	20.8029
702.7	54.0701	24.5037		828.5	54.6504	20.7603
703.0	54.0187	24.4662		829.0	54.6536	20.8644
703.3	53.9819	24.4701		829.5	54.6567	20.8073
703.6	54.0487	24.5137		830.0	54.6598	20.6852
703.9	54.0491	24.4587		830.5	54.6630	20.7496
704.2	54.0040	24.5092		831.0	54.6661	20.7347
704.5	54.0005	24.6079		831.5	54.6692	20.9422
704.8	53.9813	24.5336		832.0	54.6724	20.9198
705.1	53.9732	24.5341		832.5	54.6755	20.6965
705.4	53.9757	24.5332		833.0	54.6787	20.6299
705.7	53.9736	24.5150		833.5	54.6818	20.7414
706.0	53.9992	24.4826		834.0	54.6849	20.8932
706.3	53.9561	24.4364		834.5	54.6881	20.7862
706.6	53.9601	24.4293		835.0	54.6912	20.7296
706.9	54.0137	24.4062		835.5	54.6943	20.9773
707.2	53.9618	24.4272		836.0	54.6975	20.9843
707.5	54.0199	24.4481		836.5	54.7006	20.8421
707.8	53.9493	24.4170		837.0	54.7038	20.6691
708.1	54.0252	24.4447		837.5	54.7069	20.7054
708.4	53.9703	24.3655		838.0	54.7100	20.9897
708.7	53.9797	24.4312		838.5	54.7132	21.0049
709.0	53.9518	24.3747		839.0	54.7163	20.9269
709.3	53.9697	24.3279		839.5	54.7195	20.8619
709.6	54.0066	24.3544		840.0	54.7226	20.9290
709.9	53.9998	24.3324		840.5	54.7257	20.9744
710.2	54.0095	24.3968		841.0	54.7289	20.9295
710.5	53.9958	24.3812		841.5	54.7320	20.8662
710.8	53.9465	24.3653		842.0	54.7351	21.0421
711.1	54.0080	24.3488		842.5	54.7383	21.0106
711.4	53.9958	24.3173		843.0	54.7414	20.9710
711.7	54.0364	24.3709		843.5	54.7446	20.9265
712.0	53.9827	24.4169		844.0	54.7477	20.9442
712.3	54.0081	24.4186		844.5	54.7508	20.9701
712.6	53.9958	24.4178		845.0	54.7540	20.8795
712.9	53.9686	24.3881		845.5	54.7571	20.8259
713.2	54.0003	24.4011		846.0	54.7602	20.9989
713.5	54.0241	24.4416		846.5	54.7634	21.0603
713.8	54.0340	24.4359		847.0	54.7665	21.0091
714.1	54.0272	24.4169		847.5	54.7697	20.9294
714.4	54.0137	24.3851		848.0	54.7728	21.0196
714.7	54.0155	24.3912		848.5	54.7759	21.0977
715.0	54.0156	24.4003		849.0	54.7791	21.0979

1900 MHz Body				2450 MHz Body		
Frequency (MHz)	e'	e''		Frequency (MHz)	e'	e''
1850.00	54.0645	14.7171		2411	52.7543	14.4300
1851.25	53.9964	14.6745		2412	52.7749	14.6178
1852.50	54.0153	14.6756		2413	52.7653	14.3699
1853.75	53.9919	14.6518		2414	52.8115	15.0710
1855.00	53.8947	14.6713		2415	52.7506	14.3797
1856.25	53.9977	14.7078		2416	52.8022	14.7445
1857.50	53.9909	14.7337		2417	52.8108	14.4690
1858.75	53.9729	14.6550		2418	52.8187	14.5250
1860.00	53.9546	14.6493		2419	52.7491	14.9451
1861.25	53.8504	14.7021		2420	52.8048	14.9679
1862.50	53.8780	14.5293		2421	52.7437	14.5002
1863.75	53.8240	14.5421		2422	52.7933	14.8414
1865.00	53.8588	14.5592		2423	52.7863	14.6529
1866.25	53.8652	14.5302		2424	52.7713	14.4931
1867.50	53.9403	14.5208		2425	52.7794	14.9279
1868.75	54.0087	14.5369		2426	52.7555	14.6630
1870.00	54.0178	14.5593		2427	52.8148	14.0701
1871.25	53.9313	14.6107		2428	52.7753	14.1388
1872.50	53.8736	14.6114		2429	52.8206	14.7298
1873.75	53.9121	14.6404		2430	52.7792	14.1539
1875.00	53.8385	14.6487		2431	52.8108	14.5812
1876.25	53.9017	14.7120		2432	52.7443	14.4992
1877.50	53.8048	14.6348		2433	52.8182	14.6240
1878.75	53.9071	14.7148		2434	52.7467	14.7677
1880.00	53.9349	14.8467		2435	52.8059	14.7981
1881.25	53.8172	14.8656		2436	52.8389	14.2040
1882.50	53.7754	14.8627		2437	52.7771	14.4127
1883.75	53.8710	14.8340		2438	52.8231	14.8408
1885.00	53.8365	14.7901		2439	52.7712	14.1989
1886.25	53.8614	14.8128		2440	52.7440	14.7959
1887.50	53.8966	14.7450		2441	52.8024	14.3370
1888.75	53.8774	14.7212		2442	52.7486	14.2155
1890.00	53.9671	14.7555		2443	52.7951	14.0803
1891.25	53.8976	14.7601		2444	52.7671	14.4075
1892.50	53.9433	14.8169		2445	52.7739	14.7509
1893.75	53.9313	14.6131		2446	52.8300	14.5480
1895.00	53.9037	14.5740		2447	52.8052	14.8318
1896.25	53.8764	14.6231		2448	52.8036	14.8043
1897.50	53.8692	14.9569		2449	52.7657	14.2931
1898.75	53.8591	14.9550		2450	52.8108	14.6335
1900.00	53.8594	14.9356		2451	52.7897	14.5439
1901.25	53.9364	14.9360		2452	52.7898	14.1413
1902.50	53.9014	14.8347		2453	52.8364	14.1635
1903.75	53.9048	14.9240		2454	52.8342	14.0640
1905.00	53.8739	14.8840		2455	52.7469	14.1831
1906.25	53.9556	14.8528		2456	52.8337	14.4820
1907.50	53.8674	14.8214		2457	52.7649	14.7938
1908.75	53.8573	14.7463		2458	52.7580	14.5950
1910.00	53.7830	14.8631		2459	52.7540	14.6878
1911.25	53.8673	14.7985		2460	52.7581	14.1694
1912.50	53.8938	14.7621		2461	52.7902	14.1701
1913.75	53.7598	14.7157		2462	52.7677	14.5106

### System Accuracy Verification

Prior to the assessment, the system validation kit was used to test whether the system was operating within its specifications of  $\pm 10\%$ . The validation results are tabulated below. And also the corresponding SAR plot is attached as well in the SAR plots files.

### System Verification Setup Block Diagram

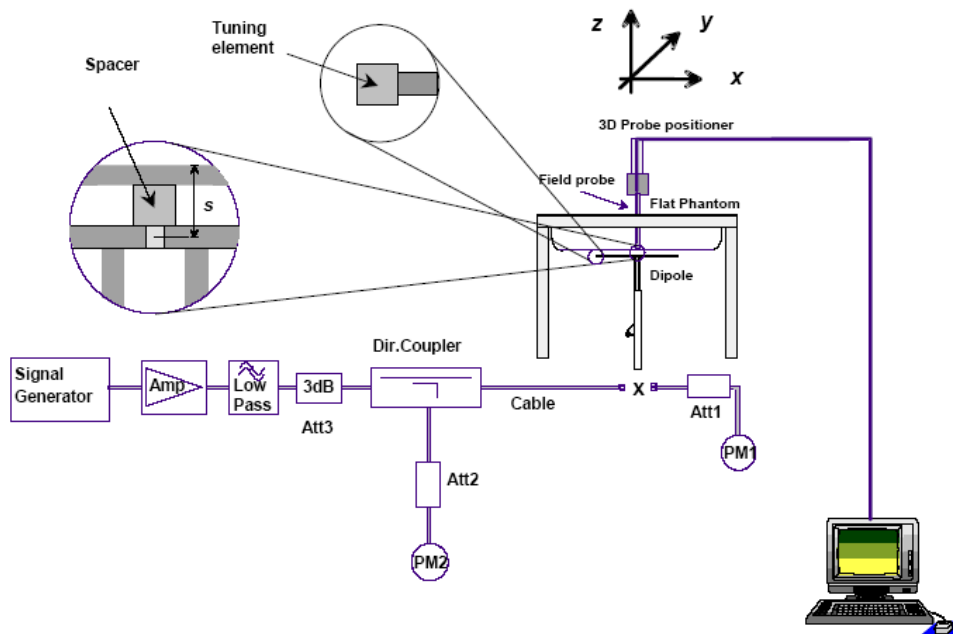

### Probe and dipole antenna List and Detail

Manufa cturer	Description	Model	Serial Number	Calibration Date	Calibration Due Date
APREL	Probe	ALS-E-020	500-00283	2013-10-08	2014-10-07
APREL	Dipole antenna(750MHz)	ALS-D-750-S-2	177-00505	2013-10-08	2016-10-07
APREL	Dipole antenna(850MHz)	ALS-D-835-S-2	180-00558	2011-08-25	2014-08-24
APREL	Dipole antenna(1900MHz)	ALS-D-1900-S-2	200-00659	2011-08-25	2014-08-24
APREL	Dipole antenna(2450MHz)	ALS-D-2450-S-2	220-00758	2011-08-25	2014-08-24

### System Accuracy Check Results

Date	Frequency Band	Liquid Type	Measured SAR (W/Kg)	Target Value (W/Kg)	Delta (%)	Tolerance (%)
2014-05-25	750	Body	1g 9.021	8.540	5.632	$\pm 10$
	835	Body	1g 10.258	9.684	5.927	$\pm 10$
	1900	Body	1g 40.112	39.769	0.862	$\pm 10$
	2450	Body	1g 54.585	52.561	3.851	$\pm 10$

All SAR values are normalized to 1 Watt forward power.

**SAR SYSTEM VALIDATION DATA****Test Laboratory: Bay Area Compliance Lab Corp. (Shenzhen)****System Performance Check 750 MHz Body Liquid****Dipole 750 MHz; Type: ALS-D-750-S-2; S/N: 177-00505**

## Product Data

Device Name : Dipole 750 MHz  
 Serial No. : 177-00505  
 Type : Dipole  
 Model : ALS-D-750-S-2  
 Frequency Band : 750  
 Max. Transmit Pwr : 1 W  
 Drift Time : 3 min(s)  
 Power Drift-Start : 9.120 W/kg  
 Power Drift-Finish : 9.174W/kg  
 Power Drift (%) : 0.635

## Phantom Data

Name : APREL-Uni  
 Type : Uni-Phantom  
 Size (mm) : 280 x 280 x 200  
 Serial No. : System Default  
 Location : Center  
 Description : Default

## Tissue Data

Type : Body  
 Serial No. : 265-01056  
 Frequency : 750.00 MHz  
 Last Calib. Date : 25-May-2014  
 Temperature : 20.00 °C  
 Ambient Temp. : 21.00 °C  
 Humidity : 50.00 RH%  
 Epsilon : 53.74 F/m  
 Sigma : 0.98 S/m  
 Density : 1000.00 kg/cu. M

## Probe Data

Name : E-Field  
 Model : E-020  
 Type : E-Field Triangle  
 Serial No. : 500-00283  
 Last Calib. Date : 08-Oct-2013  
 Frequency Band : 750  
 Duty Cycle Factor : 1  
 Conversion Factor : 5.5  
 Probe Sensitivity : 1.20 1.20 1.20  $\mu\text{V}/(\text{V}/\text{m})^2$   
 Compression Point : 95.00 mV  
 Offset : 1.56 mm

## Measurement Data

Crest Factor : 1  
 Scan Type : Complete  
 Tissue Temp. : 20.00 °C  
 Ambient Temp. : 20.00 °C  
 Area Scan : 7x9x1 : Measurement x=10mm, y=10mm, z=4mm  
 Zoom Scan : 7x7x7 : Measurement x=5mm, y=5mm, z=5mm

1 gram SAR value : 9.021 W/kg  
10 gram SAR value : 6.129 W/kg  
Area Scan Peak SAR : 10.173 W/kg  
Zoom Scan Peak SAR : 16.247 W/kg

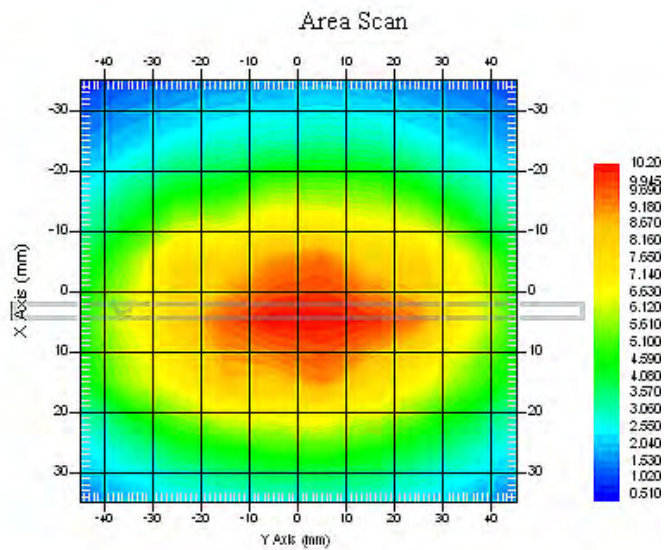

**750 MHz System Validation with Body Tissue**

**Test Laboratory: Bay Area Compliance Lab Corp. (Shenzhen)****System Performance Check 835 MHz Body Liquid****Dipole 835 MHz; Type: ALS-D-835-S-2; S/N: 180-00558**

## Product Data

Device Name : Dipole 835 MHz  
Serial No. : 180-00558  
Type : Dipole  
Model : ALS-D-835-S-2  
Frequency Band : 835  
Max. Transmit Pwr : 1 W  
Drift Time : 3 min(s)  
Power Drift-Start : 10.524 W/kg  
Power Drift-Finish : 10.320W/kg  
Power Drift (%) : -1.986

## Phantom Data

Name : APREL-Uni  
Type : Uni-Phantom  
Size (mm) : 280 x 280 x 200  
Serial No. : System Default  
Location : Center  
Description : Default

## Tissue Data

Type : Body  
Serial No. : 270-02101  
Frequency : 835.00 MHz  
Last Calib. Date : 25-May-2014  
Temperature : 20.00 °C  
Ambient Temp. : 21.00 °C  
Humidity : 50.00 RH%  
Epsilon : 54.69 F/m  
Sigma : 0.96 S/m  
Density : 1000.00 kg/cu. M

## Probe Data

Name : E-Field  
Model : E-020  
Type : E-Field Triangle  
Serial No. : 500-00283  
Last Calib. Date : 08-Oct-2013  
Frequency Band : 835  
Duty Cycle Factor : 1  
Conversion Factor : 5.9  
Probe Sensitivity : 1.20 1.20 1.20  $\mu\text{V}/(\text{V}/\text{m})^2$   
Compression Point : 95.00 mV  
Offset : 1.56 mm

## Measurement Data

Crest Factor : 1  
Scan Type : Complete  
Tissue Temp. : 20.00 °C  
Ambient Temp. : 20.00 °C  
Area Scan : 7x9x1 : Measurement x=10mm, y=10mm, z=4mm  
Zoom Scan : 7x7x7 : Measurement x=5mm, y=5mm, z=5mm

1 gram SAR value : 10.258 W/kg  
10 gram SAR value : 6.712 W/kg  
Area Scan Peak SAR : 11.046 W/kg  
Zoom Scan Peak SAR : 17.603 W/kg

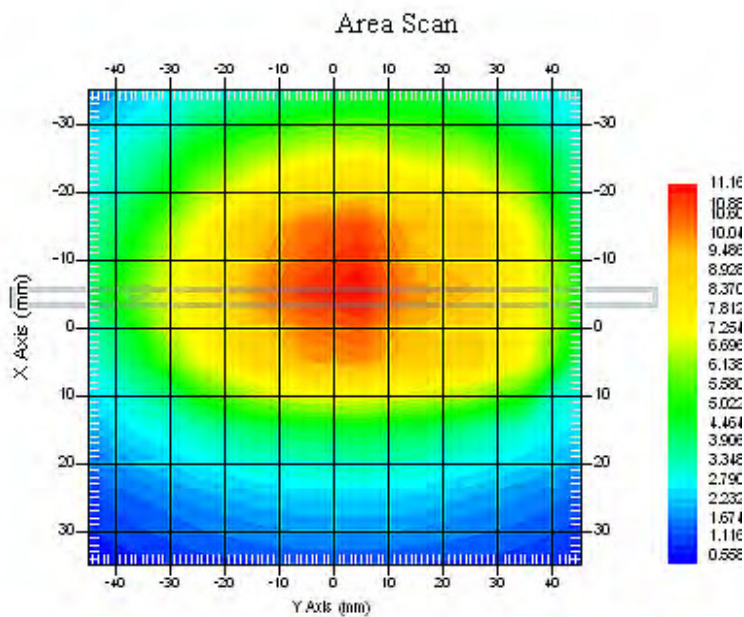

**850 MHz System Validation with Body Tissue**



**Test Laboratory: Bay Area Compliance Lab Corp. (Shenzhen)****System Performance Check 1900 MHz Body Liquid****Dipole 1900 MHz; Type: ALS-D-1900-S-2; S/N: 210-00710**

## Product Data

Device Name : Dipole 1900MHz  
Serial No. : 210-00710  
Type : Dipole  
Model : ALS-D-1900-S-2  
Frequency Band : 1900  
Max. Transmit Pwr : 1 W  
Drift Time : 3 min(s)  
Power Drift-Start : 40.154 W/kg  
Power Drift-Finish : 40.745 W/kg  
Power Drift (%) : 1.479

## Phantom Data

Name : APREL-Uni  
Type : Uni-Phantom  
Size (mm) : 280 x 280 x 200  
Serial No. : System Default  
Location : Center  
Description : Default

## Tissue Data

Type : Body  
Serial No. : 295-02102  
Frequency : 1900.00 MHz  
Last Calib. Date : 25-May-2014  
Temperature : 20.00 °C  
Ambient Temp. : 21.00 °C  
Humidity : 56.00 RH%  
Epsilon : 53.86 F/m  
Sigma : 1.58S/m  
Density : 1000.00 kg/cu. m

## Probe Data

Name : E-Field  
Model : E-020  
Type : E-Field Triangle  
Serial No. : 500-00283  
Last Calib. Date : 08-Oct-2013  
Frequency Band : 1900  
Duty Cycle Factor : 1  
Conversion Factor : 4.5  
Probe Sensitivity : 1.20 1.20 1.20  $\mu\text{V}/(\text{V}/\text{m})^2$   
Compression Point : 95.00 mV  
Offset : 1.56 mm

## Measurement Data

Crest Factor : 1  
Scan Type : Complete  
Tissue Temp. : 20.00 °C  
Ambient Temp. : 21.00 °C  
Area Scan : 8x11x1 : Measurement x=10mm, y=10mm, z=4mm  
Zoom Scan : 7x7x7 : Measurement x=5mm, y=5mm, z=5mm

1 gram SAR value : 40.112 W/kg  
10 gram SAR value : 21.859 W/kg  
Area Scan Peak SAR : 41.029 W/kg  
Zoom Scan Peak SAR : 88.168 W/kg

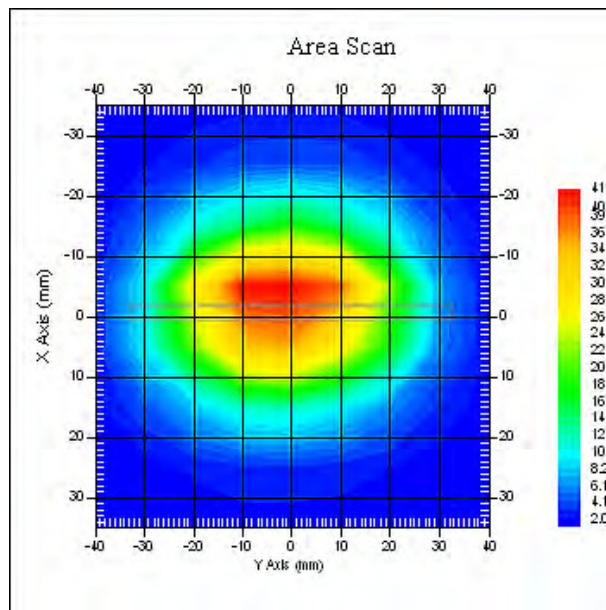

**1900 MHz System Validation with Body Tissue**

**Test Laboratory: Bay Area Compliance Lab Corp. (Shenzhen)****System Performance Check 2450 MHz Body Liquid****Dipole 2450 MHz; Type: ALS-D-2450-S-2; S/N: 220-00758**

## Product Data

Device Name : Dipole 2450MHz  
Serial No. : 220-00758  
Type : Dipole  
Model : ALS-D-2450-S-2  
Frequency : 2450 MHz  
Max. Transmit Pwr : 1 W  
Drift Time : 3 min(s)  
Power Drift-Start : 50.214 W/kg  
Power Drift-Finish : 51.528 W/kg  
Power Drift (%) : 2.618

## Phantom Data

Name : APREL-Uni  
Type : Uni-Phantom  
Size (mm) : 280 x 280 x 200  
Serial No. : System Default  
Location : Center  
Description : Default

## Tissue Data

Type : BODY  
Serial No. : 290-01109  
Frequency : 2450 MHz  
Last Calib. Date : 25-May-2014  
Temperature : 20.00 °C  
Ambient Temp. : 21.00 °C  
Humidity : 50.00 RH%  
Epsilon : 52.81 F/m  
Sigma : 1.95 S/m  
Density : 1000.00 kg/cu. M

## Probe Data

Name : E-Field  
Model : E-020  
Type : E-Field Triangle  
Serial No. : 500-00283  
Last Calib. Date : 08-Oct-2013  
Frequency : 2450 MHz  
Duty Cycle Factor : 1  
Conversion Factor : 4.3  
Probe Sensitivity : 1.20 1.20 1.20  $\mu\text{V}/(\text{V}/\text{m})^2$   
Compression Point : 95.00 mV  
Offset : 1.56 mm

## Measurement Data

Crest Factor : 1  
Scan Type : Complete  
Tissue Temp. : 20.00 °C  
Ambient Temp. : 20.00 °C  
Area Scan : 7x7x1 : Measurement x=10mm, y=10mm, z=4mm  
Zoom Scan : 7x7x7 : Measurement x=5mm, y=5mm, z=5mm

1 gram SAR value : 54.585 W/kg  
10 gram SAR value : 23.963 W/kg  
Area Scan Peak SAR : 61.795 W/kg  
Zoom Scan Peak SAR : 100.121 W/kg

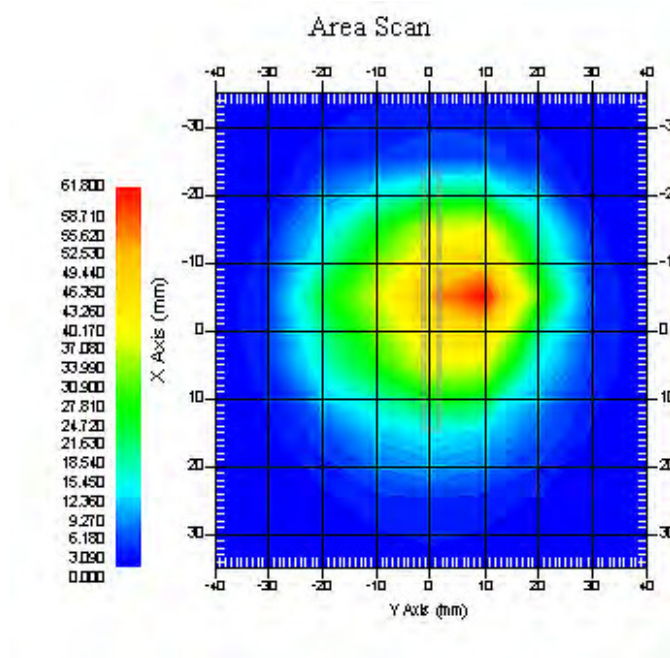

**2450 MHz System Validation**

## EUT TEST STRATEGY AND METHODOLOGY

### Test Positions for Device Operating Next to a Person’s Ear

This category includes most wireless handsets with fixed, retractable or internal antennas located toward the top half of the device, with or without a foldout, sliding or similar keypad cover. The handset should have its earpiece located within the upper ¼ of the device, either along the centerline or off-centered, as perceived by its users. This type of handset should be positioned in a normal operating position with the “test device reference point” located along the “vertical centerline” on the front of the device aligned to the “ear reference point”. The “test device reference point” should be located at the same level as the center of the earpiece region. The “vertical centerline” should bisect the front surface of the handset at its top and bottom edges. A “ear reference point” is located on the outer surface of the head phantom on each ear spacer. It is located 1.5 cm above the center of the ear canal entrance in the “phantom reference plane” defined by the three lines joining the center of each “ear reference point” (left and right) and the tip of the mouth.

A handset should be initially positioned with the earpiece region pressed against the ear spacer of a head phantom. For the SCC-34/SC-2 head phantom, the device should be positioned parallel to the “N-F” line defined along the base of the ear spacer that contains the “ear reference point”. For interim head phantoms, the device should be positioned parallel to the cheek for maximum RF energy coupling. The “test device reference point” is aligned to the “ear reference point” on the head phantom and the “vertical centerline” is aligned to the “phantom reference plane”. This is called the “initial ear position”. While maintaining these three alignments, the body of the handset is gradually adjusted to each of the following positions for evaluating SAR:

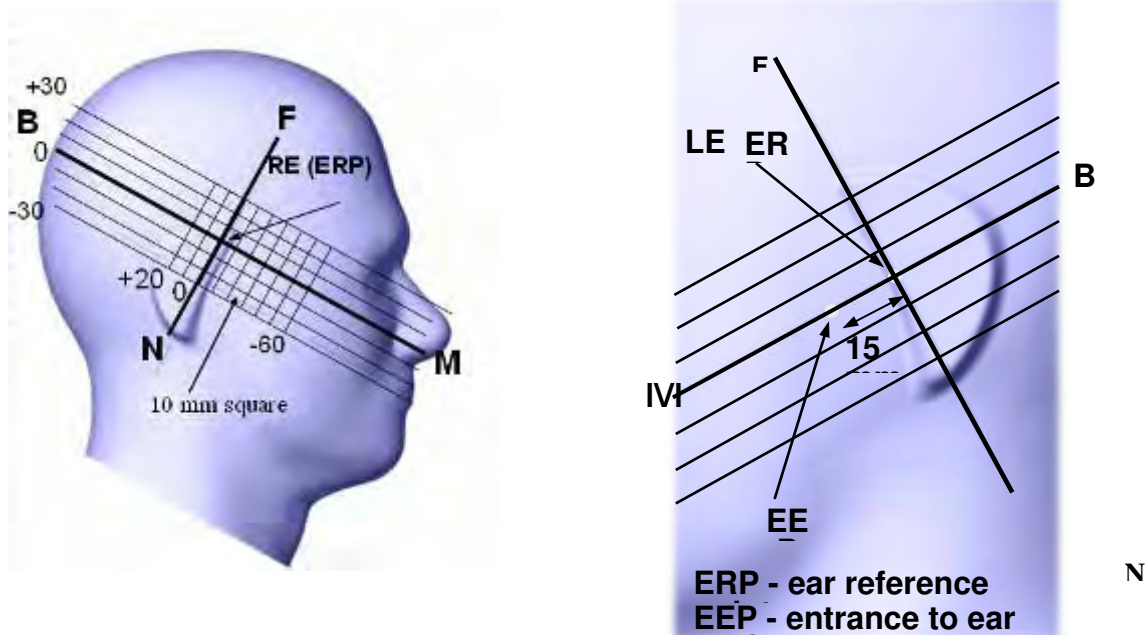

## Cheek/Touch Position

The device is brought toward the mouth of the head phantom by pivoting against the “ear reference point” or along the “N-F” line for the SCC-34/SC-2 head phantom.

This test position is established:

- When any point on the display, keypad or mouthpiece portions of the handset is in contact with the phantom.
- (or) When any portion of a foldout, sliding or similar keypad cover opened to its intended self-adjusting normal use position is in contact with the cheek or mouth of the phantom.

For existing head phantoms – when the handset loses contact with the phantom at the pivoting point, rotation should continue until the device touches the cheek of the phantom or breaks its last contact from the ear spacer.

### Cheek /Touch Position

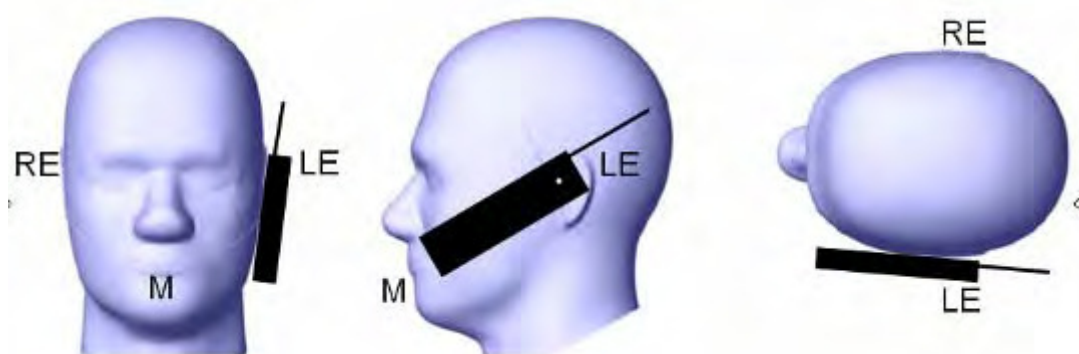

## Ear/Tilt Position

With the handset aligned in the “Cheek/Touch Position”:

1) If the earpiece of the handset is not in full contact with the phantom’s ear spacer (in the “Cheek/Touch position”) and the peak SAR location for the “Cheek/Touch” position is located at the ear spacer region or corresponds to the earpiece region of the handset, the device should be returned to the “initial ear position” by rotating it away from the mouth until the earpiece is in full contact with the ear spacer.

2) (otherwise) The handset should be moved (translated) away from the cheek perpendicular to the line passes through both “ear reference points” (note: one of these ear reference points may not physically exist on a split head model) for approximate 2-3 cm. While it is in this position, the device handset is tilted away from the mouth with respect to the “test device reference point” until the inside angle between the vertical centerline on the front surface of the phone and the horizontal line passing through the ear reference point is by 15°. After the tilt, it is then moved (translated) back toward the head perpendicular to the line passes through both “ear reference points” until the device touches the phantom or the ear spacer. If the antenna touches the head first, the positioning process should be repeated with a tilt angle less than 15° so that the device and its antenna would touch the phantom simultaneously. This test position may require a device holder or positioner to achieve the translation and tilting with acceptable positioning repeatability.

If a device is also designed to transmit with its keypad cover closed for operating in the head position, such positions should also be considered in the SAR evaluation. The device should be tested on the left and right side of the head phantom in the “Cheek/Touch” and “Ear/Tilt” positions. When applicable, each configuration should be tested with the antenna in its fully extended and fully retracted positions. These test configurations should be tested at the high, middle and low frequency channels of each operating mode; for example, AMPS, CDMA, and TDMA. If the SAR measured at the middle channel for each test configuration (left, right, Cheek/Touch, Tile/Ear, extended and retracted) is at least 2.0 dB lower than the SAR limit, testing at the high and low channels is optional for such test configuration(s). If the transmission band of the test device is less than 10 MHz, testing at the high and low frequency channels is optional.

### Ear /Tilt 15° Position

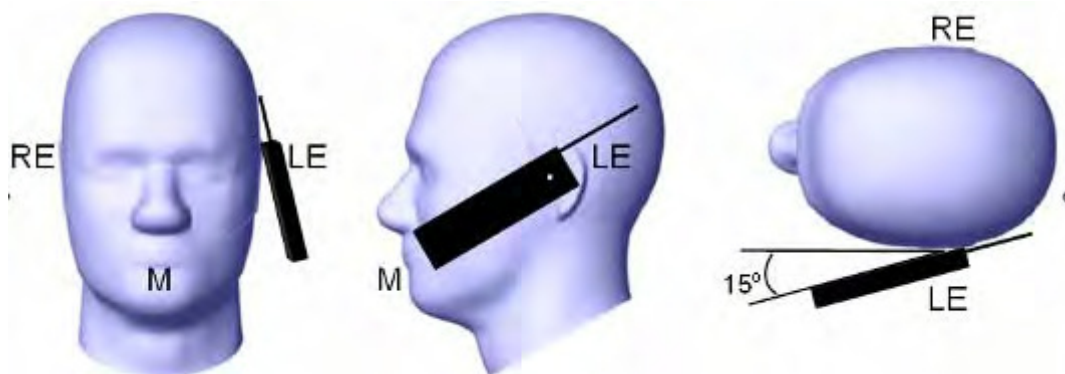

### **Test positions for body-worn and other configurations**

Body-worn operating configurations should be tested with the belt-clips and holsters attached to the device and positioned against a flat phantom in normal use configurations. Devices with a headset output should be tested with a headset connected to the device. When multiple accessories that do not contain metallic components are supplied with the device, the device may be tested with only the accessory that dictates the closest spacing to the body. When multiple accessories that contain metallic components are supplied with the device, the device must be tested with each accessory that contains a unique metallic component. If multiple accessories share an identical metallic component (e.g., the same metallic belt-clip used with different holsters with no other metallic components), only the accessory that dictates the closest spacing to the body must be tested.

Body-worn accessories may not always be supplied or available as options for some devices that are intended to be authorized for body-worn use. A separation distance of 1.5 cm between the back of the device and a flat phantom is recommended for testing body-worn SAR compliance under such circumstances. Other separation distances may be used, but they should not exceed 2.5 cm. In these cases, the device may use body-worn accessories that provide a separation distance greater than that tested for the device provided however that the accessory contains no metallic components.

## SAR Evaluation Procedure

The evaluation was performed with the following procedure:

Step 1: Measurement of the SAR value at a fixed location above the ear point or central position was used as a reference value for assessing the power drop. The SAR at this point is measured at the start of the test and then again at the end of the testing.

Step 2: The SAR distribution at the exposed side of the head was measured at a distance of 4 mm from the inner surface of the shell. The area covered the entire dimension of the head or EUT and the horizontal grid spacing was 10 mm x 10 mm. Based on these data, the area of the maximum absorption was determined by spline interpolation. The first Area Scan covers the entire dimension of the EUT to ensure that the hotspot was correctly identified.

Step 3: Around this point, a volume of 35 mm x 35 mm x 35 mm was assessed by measuring 7x 7 x 7 points. On the basis of this data set, the spatial peak SAR value was evaluated under the following procedure:

- 1) The data at the surface were extrapolated, since the center of the dipoles is 1.2 mm away from the tip of the probe and the distance between the surface and the lowest measuring point is 1.3 mm. The extrapolation was based on a least square algorithm. A polynomial of the fourth order was calculated through the points in z-axes. This polynomial was then used to evaluate the points between the surface and the probe tip.
- 2) The maximum interpolated value was searched with a straightforward algorithm. Around this maximum the SAR values averaged over the spatial volumes (1 g or 10 g) were computed by the 3D-Spline interpolation algorithm. The 3D-Spline is composed of three one dimensional splines with the "Not a knot"-condition (in x, y and z-directions). The volume was integrated with the trapezoidal-algorithm. One thousand points (10 x 10 x 10) were interpolated to calculate the averages.

All neighboring volumes were evaluated until no neighboring volume with a higher average value was found.

Step 4: Re-measurement of the SAR value at the same location as in Step 1. If the value changed by more than 5%, the evaluation was repeated.



## CONDUCTED OUTPUT POWER MEASUREMENT

### Provision Applicable

The measured peak output power should be greater and within 5% than EMI measurement.

### Test Procedure

The RF output of the transmitter was connected to the input of the EMI Receiver through sufficient attenuation.

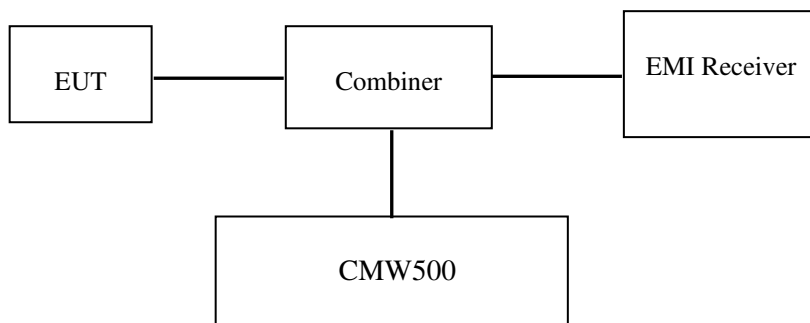

### Test Results:

#### Maximum Output Power among production units

Max Target Power for Production Unit (dBm)			
Mode/Band	Channel		
	Low	Middle	High
LTE Band 12	22.60	22.60	22.60
LTE Band 25	23.50	23.50	23.50
CDMA BC 0	24.00	25.00	25.00
CDMA BC1	24.50	24.00	24.00
Wifi (802.11b)	15.50	14.50	15.00
Wifi (802.11g)	11.50	10.50	10.60
Wifi (802.11n-20)	11.00	10.50	10.50

**LTE Band 12:**

Band/BW	Modulation	Resource Block Size	Resource Block Offset	Channel	Frequency	Ave Tx Power (dBm)	
<b>Band 12/5MHz</b>	<b>QPSK</b>	<b>RB1</b>	0	23035	701.5	22.36	
				23095	707.5	22.34	
				23155	713.5	22.36	
			13	23035	701.5	22.43	
				23095	707.5	22.17	
				23155	713.5	<b>22.58</b>	
			24	23035	701.5	22.24	
				23095	707.5	22.24	
				23155	713.5	22.45	
		<b>RB12</b>	0	23035	701.5	21.38	
				23095	707.5	21.40	
				23155	713.5	21.38	
			6	23035	701.5	21.32	
				23095	707.5	21.33	
				23155	713.5	21.41	
			13	23035	701.5	21.40	
				23095	707.5	21.23	
				23155	713.5	21.40	
		<b>RB25</b>	0	23035	701.5	21.35	
				23095	707.5	21.34	
				23155	713.5	21.49	
		<b>16-QAM</b>	<b>RB1</b>	0	23035	701.5	21.02
					23095	707.5	21.62
					23155	713.5	21.73
	13			23035	701.5	21.02	
				23095	707.5	21.56	
				23155	713.5	21.88	
	24			23035	701.5	21.02	
				23095	707.5	21.51	
				23155	713.5	21.81	
	<b>RB12</b>			0	23035	701.5	20.47
					23095	707.5	20.52
					23155	713.5	20.47
			13	23035	701.5	20.40	
				23095	707.5	20.47	
				23155	713.5	20.54	
			24	23035	701.5	20.38	
				23095	707.5	20.37	
				23155	713.5	20.50	
	<b>RB25</b>		0	23035	701.5	20.51	
				23095	707.5	20.42	
				23155	713.5	20.41	

**LTE Band 12:**

Band/BW	Modulation	Resource Block Size	Resource Block Offset	Channel	Frequency	Ave Tx Power (dBm)	
<b>Band 25/5MHz</b>	<b>QPSK</b>	<b>RB1</b>	0	26065	1852.5	23.43	
				26365	1882.5	23.31	
				26665	1912.5	23.29	
			13	26065	1852.5	<b>23.46</b>	
				26365	1882.5	23.22	
				26665	1912.5	23.42	
			24	26065	1852.5	23.30	
				26365	1882.5	23.27	
				26665	1912.5	23.00	
		<b>RB12</b>	0	26065	1852.5	22.39	
				26365	1882.5	22.28	
				26665	1912.5	22.30	
			6	26065	1852.5	22.46	
				26365	1882.5	22.24	
				26665	1912.5	22.38	
			13	26065	1852.5	22.48	
				26365	1882.5	22.21	
				26665	1912.5	22.26	
		<b>RB25</b>	0	26065	1852.5	22.27	
				26365	1882.5	22.18	
				26665	1912.5	22.07	
		<b>16-QAM</b>	<b>RB1</b>	0	26065	1852.5	21.97
					26365	1882.5	22.45
					26665	1912.5	22.75
				13	26065	1852.5	21.99
					26365	1882.5	22.40
					26665	1912.5	22.71
	24			26065	1852.5	22.02	
				26365	1882.5	22.43	
				26665	1912.5	22.40	
	<b>RB12</b>		0	26065	1852.5	21.34	
				26365	1882.5	21.38	
				26665	1912.5	21.40	
			13	26065	1852.5	21.38	
				26365	1882.5	21.37	
				26665	1912.5	21.35	
			24	26065	1852.5	21.45	
				26365	1882.5	24.34	
				26665	1912.5	21.29	
	<b>RB25</b>		0	26065	1852.5	21.45	
				26365	1882.5	21.27	
				26665	1912.5	21.17	

**CDMA Band BC0**

Modulation	Radio Configuration (RC)	Service Option (SO)	Channel	Frequency	Ave Tx Power (dBm)
QPSK	RC1	SO55	1013	824.70	24.08
			384	836.52	23.87
			777	848.31	23.79
	RC3	SO55	1013	824.70	24.07
			384	836.52	23.78
			777	848.31	23.79
		SO32+F-SCH	1013	824.70	24.07
			384	836.52	23.99
			777	848.31	23.78
		SO32+FCH	1013	824.70	24.08
			384	836.52	23.88
			777	848.31	23.79
8-PSK	FTAP	1228.8 K	1013	824.70	23.53
			384	836.52	24.58
			777	848.31	24.63
		1843.2 K	1013	824.70	23.53
			384	836.52	24.42
			777	848.31	24.60
		2457.6 K	1013	824.70	23.55
			384	836.52	24.53
			777	848.31	24.62
	RTAP	153.6 k	1013	824.70	23.63
			384	836.52	<b>24.85</b>
			777	848.31	24.58
16-QAM	FETAP	1228.8 K	1013	824.70	23.40
			384	836.52	23.38
			777	848.31	24.10
		1843.2 K	1013	824.70	23.58
			384	836.52	23.63
			777	848.31	23.27
		3072K	1013	824.70	23.54
			384	836.52	23.82
			777	848.31	23.42
	RETAP	4096B	1013	824.70	23.52
			384	836.52	23.36
			777	848.31	23.26

**CDMA Band BC1**

Modulation	Radio Configuration (RC)	Service Option (SO)	Channel	Frequency	Ave Tx Power (dBm)
QPSK	RC1	SO55	25	1851.25	24.15
			600	1880.0	23.74
			1175	1908.75	23.76
	RC3	SO55	25	1851.25	23.89
			600	1880.0	23.70
			1175	1908.75	23.69
		SO32+F-SCH	25	1851.25	23.97
			600	1880.0	23.78
			1175	1908.75	23.61
		SO32+FCH	25	1851.25	<b>24.01</b>
			600	1880.0	23.83
			1175	1908.75	23.56
8-PSK	FTAP	1228.8 K	25	1851.25	23.93
			600	1880.0	23.47
			1175	1908.75	23.56
		1843.2 K	25	1851.25	23.77
			600	1880.0	23.52
			1175	1908.75	23.54
	2457.6 K	25	1851.25	23.81	
		600	1880.0	23.68	
		1175	1908.75	23.57	
	RTAP	153.6 k	25	1851.25	23.79
			600	1880.0	23.52
			1175	1908.75	23.58
16-QAM	FETAP	1228.8 K	25	1851.25	22.87
			600	1880.0	22.65
			1175	1908.75	22.75
		1843.2 K	25	1851.25	22.81
			600	1880.0	22.62
			1175	1908.75	22.80
		3072K	25	1851.25	22.88
			600	1880.0	22.92
			1175	1908.75	22.81
		4096B	25	1851.25	22.85
			600	1880.0	22.86
			1175	1908.75	22.88

**Note:**

1. SAR for LTE band exposure configurations is measured according to the procedures of KDB 941225 D05 SAR for LTE Devices v02.
3. The CMW500 Wideband Radio Communication tester is used for LTE output power measurements and SAR testing. Closed loop power control is used to keep the radio transmitters the max output power during the test.
2. KDB941225D05v02- SAR for higher order modulation is required only when the highest maximum output power for the configuration in the higher order modulation is > ½ dB higher than the same configuration in QPSK or when the reported SAR for the QPSK configuration is > 1.45 W/kg
4. KDB941225D01-SAR for SO55 RC1 was not required when the average output power is not more than 0.25dB higher than the SO55 RC3 power.
5. KDB941225D01-Body SAR tests for Ev-Do and TDSO/SO32 FCH+SCH are not required when the average output power is not more than 0.25dB higher than the SO55 RC3 TDSO/SO32 FCH only power.

**WiFi**

Band	Frequency (MHz)	Conducted Output Power	
		(dBm)	(mw)
802.11b	2412	15.30	33.884
	2437	14.46	27.925
	2462	14.94	31.189
802.11g	2412	11.31	13.521
	2437	10.10	10.233
	2462	10.51	11.246
802.11n-HT20	2412	10.86	12.190
	2437	10.25	10.593
	2462	10.44	11.066

**Note:**

1. The output power was tested under data rate 1Mbps for 802.11b, 6Mbps for 802.11g, MCS7Mbps for 802.11n-HT20.
2. KDB 248227- SAR is not required for 802.11g/n channels when the maximum average output power is less than ¼ dB higher than that measured on the corresponding 802.11b channels.

## SAR MEASUREMENT RESULTS

---

This page summarizes the results of the performed dosimetric evaluation.

### SAR Test Data

#### Environmental Conditions

<b>Temperature:</b>	21-24 °C
<b>Relative Humidity:</b>	50-53 %
<b>ATM Pressure:</b>	1001-1002 mbar

*Testing was performed by Wilson Chen from 2014-05-25 to 2014-05-26.*

**Mobile Hot-Spot Test Result**

The DUT is capable of functioning as a WiFi to Cellular Mobile hotspot. Additional SAR testing was performed according to KDB 941225 D06. Testing was performed with a separation of 1cm between the DUT and the flat phantom. The DUT was positioned for SAR tests with the front and back surfaces facing the phantom, and also with the edges facing the phantom in which the transmitting antenna is <2.5 cm from the edge. Each transmit band was utilized for SAR testing. The tested mode has been selected within each band that exhibits the highest time average output power.

**LTE Band12:**

EUT Position	Frequency (MHz)		Test Mode	Power Drift (%)	Max. Meas. Power (dBm)	Max. Rated Power (dBm)	FCC 1g SAR (W/Kg)		
	Channel	MHz					Scaled Factor	Meas. SAR	Scaled SAR
Body-Front (10mm)	23035	701.5	1RB	/	/	/	/	/	/
	23095	707.5	1RB	/	/	/	/	/	/
	23155	713.5	1RB	-1.325	22.58	22.60	1.005	0.557	<b>0.560</b>
Body-Back (10mm)	23035	701.5	1RB	/	/	/	/	/	/
	23095	707.5	1RB	/	/	/	/	/	/
	23155	713.5	1RB	0.719	22.58	22.60	1.005	0.413	0.415
Body-Left (10mm)	23035	701.5	1RB	/	/	/	/	/	/
	23095	707.5	1RB	/	/	/	/	/	/
	23155	713.5	1RB	-0.357	22.58	22.60	1.005	0.089	0.089
Body- Right (10mm)	23035	701.5	1RB	/	/	/	/	/	/
	23095	707.5	1RB	/	/	/	/	/	/
	23155	713.5	1RB	1.393	22.58	22.60	1.005	0.300	0.302
Body- Top (10mm)	23035	701.5	1RB	/	/	/	/	/	/
	23095	707.5	1RB	/	/	/	/	/	/
	23155	713.5	1RB	0.287	22.58	22.60	1.005	0.049	0.049
Body-Front (10mm)	23035	701.5	50% RB	/	/	/	/	/	/
	23095	707.5	50% RB	/	/	/	/	/	/
	23155	713.5	50% RB	-2.355	21.41	21.50	1.021	0.475	0.485
Body-Back (10mm)	23035	701.5	50% RB	/	/	/	/	/	/
	23095	707.5	50% RB	/	/	/	/	/	/
	23155	713.5	50% RB	1.309	21.41	21.50	1.021	0.365	0.373
Body-Left (10mm)	23035	701.5	50% RB	/	/	/	/	/	/
	23095	707.5	50% RB	/	/	/	/	/	/
	23155	713.5	50% RB	-1.027	21.41	21.50	1.021	0.069	0.070
Body- Right (10mm)	23035	701.5	50% RB	/	/	/	/	/	/
	23095	707.5	50% RB	/	/	/	/	/	/
	23155	713.5	50% RB	0.612	21.41	21.50	1.021	0.239	0.244
Body- Top (10mm)	23035	701.5	50% RB	/	/	/	/	/	/
	23095	707.5	50% RB	/	/	/	/	/	/
	23155	713.5	50% RB	-1.685	21.41	21.50	1.021	0.071	0.072



**LTE Band 25:**

EUT Position	Frequency (MHz)		Test Mode	Power Drift (%)	Max. Meas. Power (dBm)	Max. Rated Power (dBm)	FCC 1g SAR (W/Kg)		
	Channel	MHz					Scaled Factor	Meas. SAR	Scaled SAR
Body-Front (10mm)	26065	1852.5	1RB	-0.402	23.46	23.50	1.009	0.990	0.999
	26365	1882.5	1RB	0.842	23.22	23.50	1.067	1.118	<b>1.193</b>
	26665	1912.5	1RB	1.419	23.42	23.50	1.019	1.012	1.031
Body-Back (10mm)	26065	1852.5	1RB	1.629	23.46	23.50	1.009	0.391	0.395
	26365	1882.5	1RB	/	/	/	/	/	/
	26665	1912.5	1RB	/	/	/	/	/	/
Body-Left (10mm)	26065	1852.5	1RB	-0.776	23.46	23.50	1.009	0.302	0.305
	26365	1882.5	1RB	/	/	/	/	/	/
	26665	1912.5	1RB	/	/	/	/	/	/
Body- Right (10mm)	26065	1852.5	1RB	2.237	23.46	23.50	1.009	0.115	0.116
	26365	1882.5	1RB	/	/	/	/	/	/
	26665	1912.5	1RB	/	/	/	/	/	/
Body- Top (10mm)	26065	1852.5	1RB	1.324	23.46	23.50	1.009	0.594	0.599
	26365	1882.5	1RB	/	/	/	/	/	/
	26665	1912.5	1RB	/	/	/	/	/	/
Body-Front (10mm)	26065	1852.5	50% RB	0.750	22.48	22.50	1.005	0.693	0.696
	26365	1882.5	50% RB	/	/	/	/	/	/
	26665	1912.5	50% RB	/	/	/	/	/	/
Body-Back (10mm)	26065	1852.5	50% RB	-1.608	22.48	22.50	1.005	0.168	0.169
	26365	1882.5	50% RB	/	/	/	/	/	/
	26665	1912.5	50% RB	/	/	/	/	/	/
Body-Left (10mm)	26065	1852.5	50% RB	1.746	22.48	22.50	1.005	0.159	0.160
	26365	1882.5	50% RB	/	/	/	/	/	/
	26665	1912.5	50% RB	/	/	/	/	/	/
Body- Right (10mm)	26065	1852.5	50% RB	-0.554	22.48	22.50	1.005	0.068	0.068
	26365	1882.5	50% RB	/	/	/	/	/	/
	26665	1912.5	50% RB	/	/	/	/	/	/
Body- Top (10mm)	26065	1852.5	50% RB	1.648	22.48	22.50	1.005	0.391	0.393
	26365	1882.5	50% RB	/	/	/	/	/	/
	26665	1912.5	50% RB	/	/	/	/	/	/
Body-Front (10mm)	26065	1852.5	100% RB	-0.816	22.48	22.50	1.005	0.902	0.907
	26365	1882.5	100% RB	/	/	/	/	/	/
	26665	1912.5	100% RB	/	/	/	/	/	/

**Note:**

1. When the 1-g SAR is  $\leq 0.8$ W/Kg, testing for other channels are optional.
2. SAR for LTE band exposure configurations is measured according to the procedures of KDB 941225 D05 SAR for LTE Devices v02.
3. KDB941225D05- SAR for higher order modulation is required only when the highest maximum output power for the configuration in the higher order modulation is  $> \frac{1}{2}$  dB higher than the same configuration in QPSK or when the reported SAR for the QPSK configuration is  $> 1.45$  W/kg
4. KDB941225D05- For QPSK with 100% RB allocation, when the reported SAR measured for the highest output power channel is  $< 1.45$  W/kg, tests for the remaining required test channels are optional.
5. KDB941225D05- For QPSK with 100% RB allocation, SAR is not required when the highest maximum output power for 100 % RB allocation is less than the highest maximum output power in 50% and 1 RB allocations and the highest *reported* SAR for 1 RB and 50% RB allocation are  $\leq 0.8$  W/kg.

**CDMA BC0:**

EUT Position	Frequency (MHz)		Service	Power Drift (%)	Max. Meas. Power (dBm)	Max. Rated Power (dBm)	FCC 1g SAR (W/Kg)		
	Channel	MHz					Scaled Factor	Meas. SAR	Scaled SAR
Body-Front (10mm)	1013	824.70	EvDo Rev0						
	384	836.52	EvDo Rev0	-1.367	24.85	25.00	1.035	0.768	<b>0.795</b>
	777	848.31	EvDo Rev0	/	/	/	/	/	/
Body-Back (10mm)	1013	824.70	EvDo Rev0	/	/	/	/	/	/
	384	836.52	EvDo Rev0	-1.174	24.85	25.00	1.035	0.635	0.657
	777	848.31	EvDo Rev0	/	/	/	/	/	/
Body-Left (10mm)	1013	824.70	EvDo Rev0	/	/	/	/	/	/
	384	836.52	EvDo Rev0	0.598	24.85	25.00	1.035	0.482	0.499
	777	848.31	EvDo Rev0	/	/	/	/	/	/
Body- Right (10mm)	1013	824.70	EvDo Rev0	/	/	/	/	/	/
	384	836.52	EvDo Rev0	2.428	24.85	25.00	1.035	0.386	0.400
	777	848.31	EvDo Rev0	/	/	/	/	/	/
Body- Top (10mm)	1013	824.70	EvDo Rev0	/	/	/	/	/	/
	384	836.52	EvDo Rev0	-0.915	24.85	25.00	1.035	0.159	0.165
	777	848.31	EvDo Rev0	/	/	/	/	/	/

**CDMA BC1:**

EUT Position	Frequency (MHz)		Service	Power Drift (%)	Max. Meas. Power (dBm)	Max. Rated Power (dBm)	FCC 1g SAR (W/Kg)		
	Channel	MHz					Scaled Factor	Meas. SAR	Scaled SAR
Body-Front (10mm)	25	1851.25	TDSO/SO32	-1.647	24.01	24.50	1.119	1.260	<b>1.411</b>
	600	1880.0	TDSO/SO32	/	23.83	24.00	1.040	0.983	1.022
	1175	1908.75	TDSO/SO32	/	23.65	24.00	1.084	0.833	0.903
Body-Back (10mm)	25	1851.25	TDSO/SO32	-1.627	24.01	24.50	1.119	0.526	0.589
	600	1880.0	TDSO/SO32	/	/	/	/	/	/
	1175	1908.75	TDSO/SO32	/	/	/	/	/	/
Body-Left (10mm)	25	1851.25	TDSO/SO32	-1.857	24.01	24.50	1.119	0.247	0.276
	600	1880.0	TDSO/SO32	/	/	/	/	/	/
	1175	1908.75	TDSO/SO32	/	/	/	/	/	/
Body- Right (10mm)	25	1851.25	TDSO/SO32	1.154	24.01	24.50	1.119	0.058	0.065
	600	1880.0	TDSO/SO32	/	/	/	/	/	/
	1175	1908.75	TDSO/SO32	/	/	/	/	/	/
Body- Top (10mm)	25	1851.25	TDSO/SO32	2.495	24.01	24.50	1.119	0.414	0.463
	600	1880.0	TDSO/SO32	/	/	/	/	/	/
	1175	1908.75	TDSO/SO32	/	/	/	/	/	/

**Note:**

1. When the 1-g SAR is  $\leq 0.8W/Kg$ , testing for other channels are optional.
2. KDB941225D01-SAR for SO55 R1 was not required when the average output power is not more than 0.25dB higher than the SO55 RC3 power.
3. KDB941225D01-Body SAR tests for Ev-Do and TDSO/SO32 FCH+SCH are not required when the average output power is not more than 0.25dB higher than the SO55 RC3 TDSO/SO32 FCH only power.

**WiFi (802.11b)**

EUT Position	Frequency (MHz)		Test Mode	Power Drift (%)	Max. Meas. Power (dBm)	Max. Rated Power (dBm)	FCC 1g SAR (W/Kg)		
	Channel	MHz					Scaled Factor	Meas. SAR	Scaled SAR
Body-Back	1	2412	802.11b		15.30	15.50	1.047	0.033	0.035
	6	2437	802.11b	/	/	/	/	/	/
	11	2462	802.11b	/	/	/	/	/	/
Body-Front	1	2412	802.11b		15.30	15.50	1.047	0.079	0.083
	6	2437	802.11b	/	/	/	/	/	/
	11	2462	802.11b	/	/	/	/	/	/
Body-Left	1	2412	802.11b		15.30	15.50	1.047	0.011	0.012
	6	2437	802.11b	/	/	/	/	/	/
	11	2462	802.11b	/	/	/	/	/	/
Body-Bottom	1	2412	802.11b		15.30	15.50	1.047	0.012	0.013
	6	2437	802.11b	/	/	/	/	/	/
	11	2462	802.11b	/	/	/	/	/	/

**Note:**

1. When the 1-g SAR is  $\leq 0.8\text{W/Kg}$ , testing for other channels are optional.
2. KDB 248227- SAR is not required for 802.11g/n channels when the maximum average output power is less than  $\frac{1}{4}$  dB higher than that measured on the corresponding 802.11b channels.
3. When SAR or MPE is not measured at the maximum power level allowed for production units, the results must be scaled to the maximum tune-up tolerance limit according to the power applied to the individual channels tested to determine compliance.

## SAR SIMULTANEOUS TRANSMISSION DESCRIPTION

### KDB 447498D01 General RF Exposure Guidance v05r02

Stand-alone and simultaneous SAR evaluation for a cell phone with multiple transmitters is based on the antennas distance of each radio.

**WiFi, LTE&CDMA Antenna Location:**

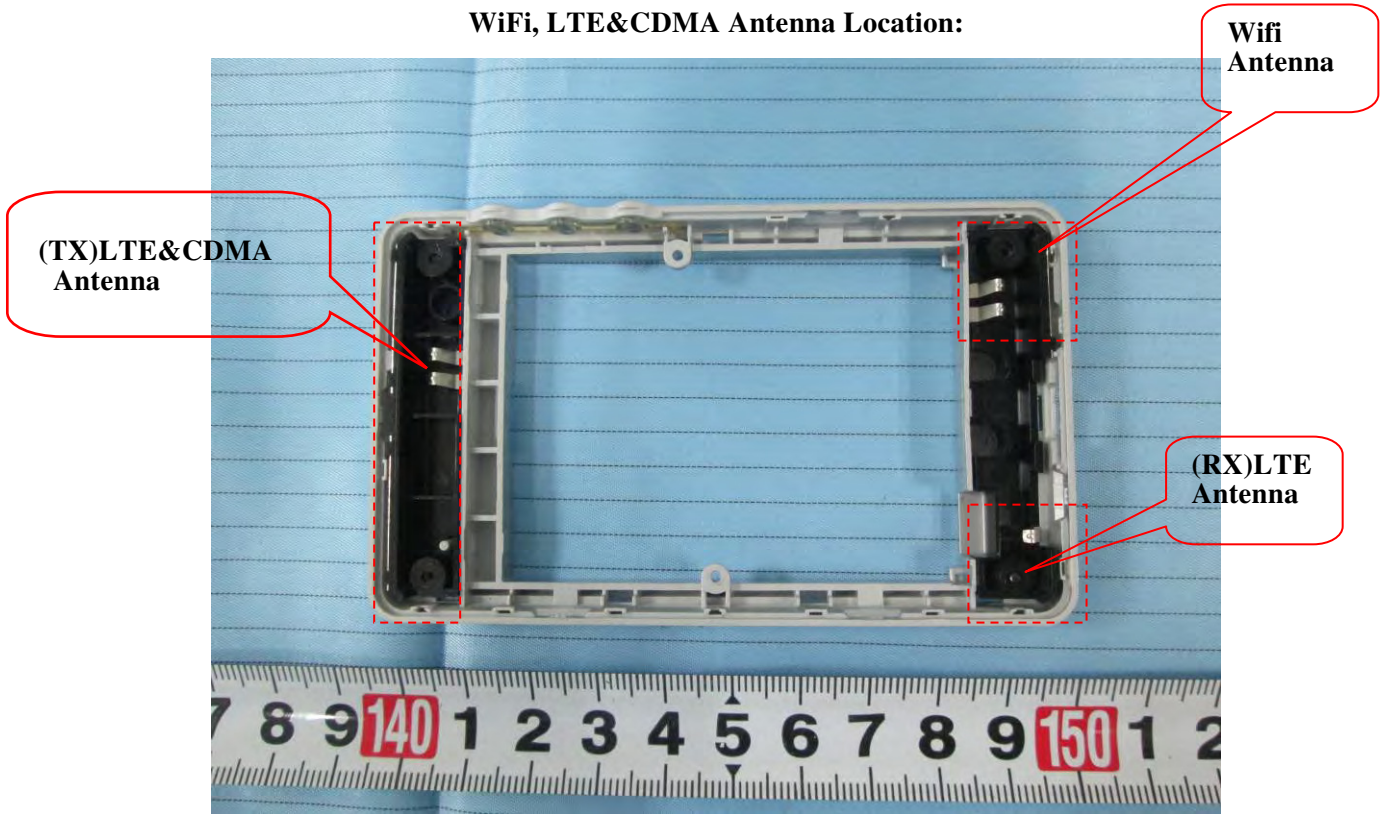

### Antenna Information:

Description of Simultaneous Transmit Capabilities		Antennas Distance (mm)
Transmitter Combination	Simultaneous?	
CDMA + WIFI	yes	74
LTE+ WIFI	yes	74
LTE+ CDMA	No	0

### Standalone SAR test exclusion considerations

Body Position:

Mode	Frequency (MHz)	P <sub>avg</sub> (dBm)	P <sub>avg</sub> (mW)	Distance (mm)	Calculated value	Threshold (1-g)	SAR Test Exclusion
LTE Band 12	750	22.60	181.97	10.00	15.76	3.0	No
LTE Band 25	1900	23.50	223.87	10.00	30.86	3.0	No
CDMA-Cellular	850	25.00	316.23	10.00	29.15	3.0	No
CDMA-US PCS	1900	24.50	281.84	10.00	38.85	3.0	No
Wifi	2450	15.30	33.88	10.00	5.30	3.0	No

The 1-g and 10-g SAR test exclusion thresholds for 100 MHz to 6 GHz at *test separation distances* ≤ 50 mm are determined by:

$$[(\text{max. power of channel, including tune-up tolerance, mW})/(\text{min. test separation distance, mm})] \cdot [\sqrt{f(\text{GHz})}] \leq 3.0 \text{ for 1-g SAR and } \leq 7.5 \text{ for 10-g extremity SAR, where}$$

1. f(GHz) is the RF channel transmit frequency in GHz.
2. Power and distance are rounded to the nearest mW and mm before calculation.
3. The result is rounded to one decimal place for comparison.
4. When the minimum test separation distance is < 5 mm, a distance of 5 mm is applied to determine SAR test Exclusion.

**Hotspot:**

Evaluations for Simultaneous SAR, Mobile Hot Spot Positions						
Test Position	Body-Front (1.0cm)	Body-Back (1.0cm)	Body-Left (1.0cm)	Body-Right (1.0cm)	Body-Bottom (1.0cm)	Body-Top (1.0cm)
Mode	Stand Alone 1-g SAR (W/Kg)					
LTE Band 12	0.560	0.415	0.089	0.302	/	0.049
LTE Band 25	1.193	0.395	0.305	0.116	/	0.599
CDMA-Cellular	0.795	0.657	0.499	0.400	/	0.165
CDMA-US PCS	1.411	0.589	0.276	0.065	/	0.463
WiFi	0.035	0.083	0.012	/	0.013	/
	∑ 1-g SAR(W/Kg)					
LTE Band 12 + WiFi	0.595	0.498	0.101	/	/	/
LTE Band 25 + WiFi	1.228	0.478	0.317	/	/	/
CDMA-Cellular + WiFi	0.830	0.740	0.511	/	/	/
CDMA-US PCS + WiFi	<b>1.446</b>	0.672	0.288	/	/	/

**Note:**

If the sum of the 1g SAR measured for the simultaneously transmitting antennas is less than the SAR limit, SAR measurement for simultaneous transmission is not required.

**EUT SCAN RESULTS**

**Test Laboratory: Bay Area Compliance Lab Corp. (Shenzhen)**

**Body-Front (713.5 MHz High Channel); Resource Block Size: 1 RB; Resource Block offset: 13;**

Measurement Data

Test mode : RB1  
 Crest Factor : 1  
 Scan Type : Complete  
 Area Scan : 8x11x1 : Measurement x=10mm, y=10mm, z=4mm  
 Zoom Scan : 7x7x7 : Measurement x=5mm, y=5mm, z=5mm  
 Power Drift-Start : 0.458 W/kg  
 Power Drift-Finish : 0.452 W/kg  
 Power Drift (%) : -1.325

Tissue Data

Type : Body  
 Frequency : 713.5 MHz  
 Epsilon : 54.02 F/m  
 Sigma : 0.97 S/m  
 Density : 1000.00 kg/cu. m

Probe Data

Serial No. : 500-00283  
 Frequency Band : 750  
 Duty Cycle Factor : 1  
 Conversion Factor : 5.9  
 Probe Sensitivity : 1.20 1.20 1.20  $\mu\text{V}/(\text{V}/\text{m})^2$   
 Compression Point : 95.00 mV  
 Offset : 1.56 mm

1 gram SAR value : 0.557 W/kg  
 10 gram SAR value : 0.253 W/kg  
 Area Scan Peak SAR : 0.555 W/kg  
 Zoom Scan Peak SAR : 1.200 W/kg

**Plot 1#**

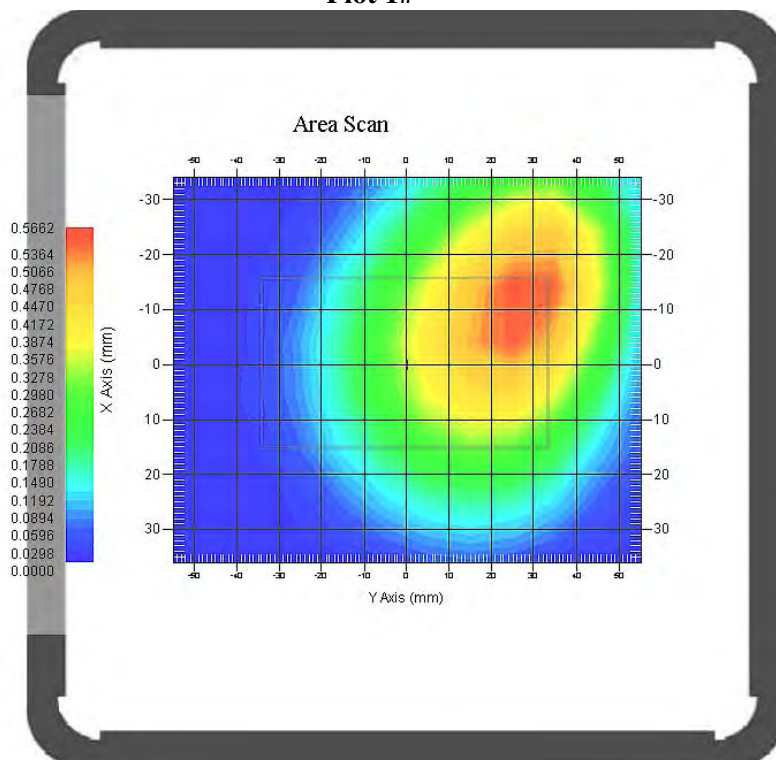

**Test Laboratory: Bay Area Compliance Lab Corp. (Shenzhen)**

**Body-Back (713.5 MHz High Channel); Resource Block Size: 1 RB; Resource Block offset: 13;**

Measurement Data

Test mode : RB1  
 Crest Factor : 1  
 Scan Type : Complete  
 Area Scan : 8x11x1 : Measurement x=10mm, y=10mm, z=4mm  
 Zoom Scan : 7x7x7 : Measurement x=5mm, y=5mm, z=5mm  
 Power Drift-Start : 0.358 W/kg  
 Power Drift-Finish : 0.360 W/kg  
 Power Drift (%) : 0.719

Tissue Data

Type : Body  
 Frequency : 713.5 MHz  
 Epsilon : 54.02 F/m  
 Sigma : 0.97 S/m  
 Density : 1000.00 kg/cu. m

Probe Data

Serial No. : 500-00283  
 Frequency Band : 750  
 Duty Cycle Factor : 1  
 Conversion Factor : 5.9  
 Probe Sensitivity : 1.20 1.20 1.20  $\mu\text{V}/(\text{V}/\text{m})^2$   
 Compression Point : 95.00 mV  
 Offset : 1.56 mm

1 gram SAR value : 0.413 W/kg  
 10 gram SAR value : 0.209 W/kg  
 Area Scan Peak SAR : 0.451 W/kg  
 Zoom Scan Peak SAR : 0.757 W/kg

**Plot 2#**

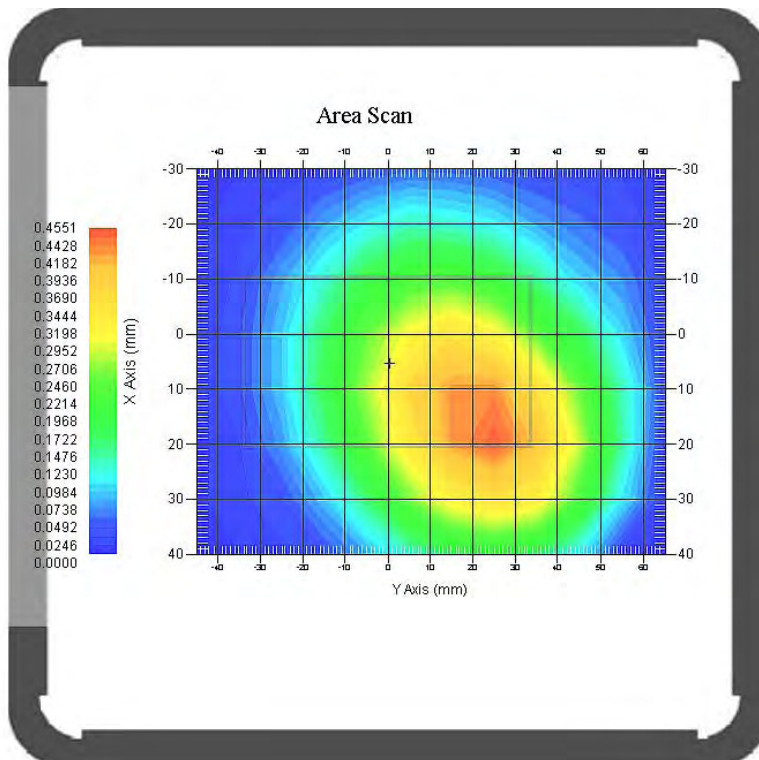

**Test Laboratory: Bay Area Compliance Lab Corp. (Shenzhen)**

**Body-Left (713.5 MHz High Channel); Resource Block Size: 1 RB; Resource Block offset: 13;**

Measurement Data

Test mode : RB1  
 Crest Factor : 1  
 Scan Type : Complete  
 Area Scan : 8x11x1 : Measurement x=10mm, y=10mm, z=4mm  
 Zoom Scan : 7x7x7 : Measurement x=5mm, y=5mm, z=5mm  
 Power Drift-Start : 0.052 W/kg  
 Power Drift-Finish : 0.052 W/kg  
 Power Drift (%) : -0.357

Tissue Data

Type : Body  
 Frequency : 713.5 MHz  
 Epsilon : 54.02 F/m  
 Sigma : 0.97 S/m  
 Density : 1000.00 kg/cu. m

Probe Data

Serial No. : 500-00283  
 Frequency Band : 750  
 Duty Cycle Factor : 1  
 Conversion Factor : 5.9  
 Probe Sensitivity : 1.20 1.20 1.20  $\mu\text{V}/(\text{V}/\text{m})^2$   
 Compression Point : 95.00 mV  
 Offset : 1.56 mm

1 gram SAR value : 0.089 W/kg  
 10 gram SAR value : 0.051 W/kg  
 Area Scan Peak SAR : 0.089 W/kg  
 Zoom Scan Peak SAR : 0.140 W/kg

**Plot 3#**

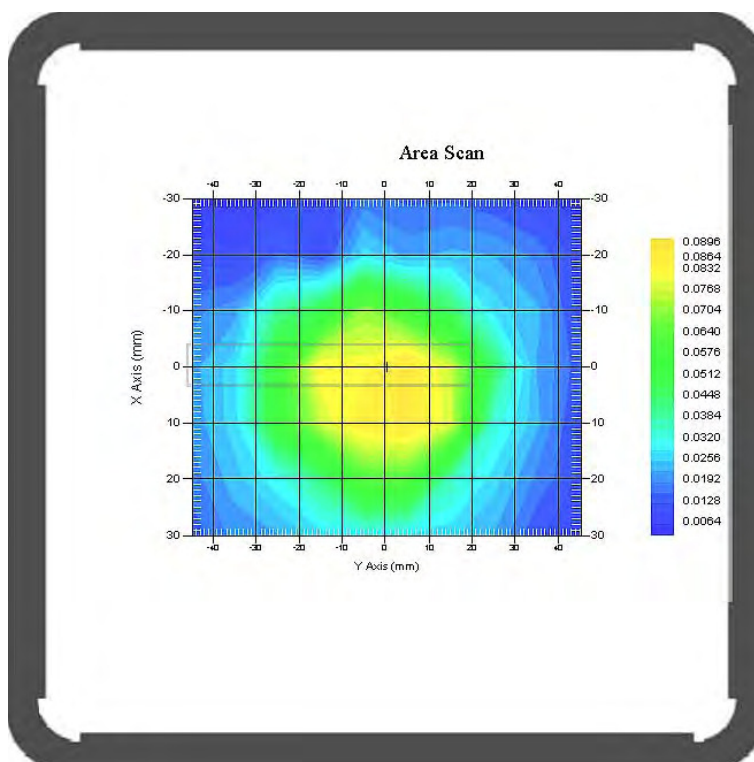



**Test Laboratory: Bay Area Compliance Lab Corp. (Shenzhen)**

**Body-Right (713.5 MHz High Channel) ; Resource Block Size: 1 RB; Resource Block offset: 13;**

Measurement Data

Test mode : RB1  
 Crest Factor : 1  
 Scan Type : Complete  
 Area Scan : 8x11x1 : Measurement x=10mm, y=10mm, z=4mm  
 Zoom Scan : 7x7x7 : Measurement x=5mm, y=5mm, z=5mm  
 Power Drift-Start : 0.204 W/kg  
 Power Drift-Finish: 0.207 W/kg  
 Power Drift (%) : 1.393

Tissue Data

Type : Body  
 Frequency : 713.5 MHz  
 Epsilon : 54.02 F/m  
 Sigma : 0.97 S/m  
 Density : 1000.00 kg/cu. m

Probe Data

Serial No. : 500-00283  
 Frequency Band : 750  
 Duty Cycle Factor : 1  
 Conversion Factor : 5.9  
 Probe Sensitivity : 1.20 1.20 1.20  $\mu\text{V}/(\text{V}/\text{m})^2$   
 Compression Point : 95.00 mV  
 Offset : 1.56 mm

1 gram SAR value : 0.300 W/kg  
 10 gram SAR value : 0.152 W/kg  
 Area Scan Peak SAR : 0.308 W/kg  
 Zoom Scan Peak SAR : 0.459 W/kg

**Plot 4#**

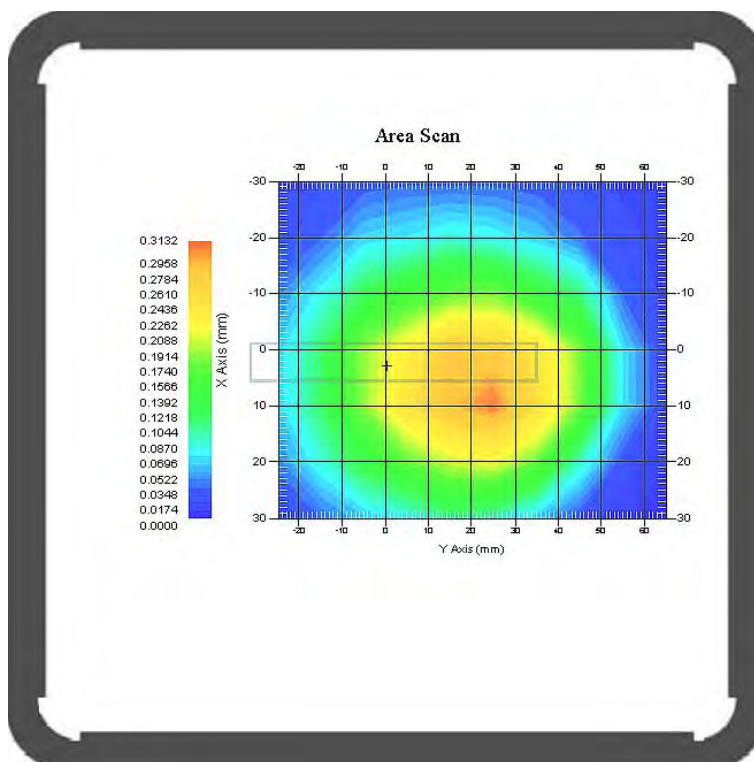

**Test Laboratory: Bay Area Compliance Lab Corp. (Shenzhen)**

**Body- Top (713.5 MHz High Channel); Resource Block Size: 1 RB; Resource Block offset: 13;**

Measurement Data

Test mode : RB1  
 Crest Factor : 1  
 Scan Type : Complete  
 Area Scan : 8x11x1 : Measurement x=10mm, y=10mm, z=4mm  
 Zoom Scan : 7x7x7 : Measurement x=5mm, y=5mm, z=5mm  
 Power Drift-Start : 0.035 W/kg  
 Power Drift-Finish: 0.035 W/kg  
 Power Drift (%) : 0.287

Tissue Data

Type : Body  
 Frequency : 713.5 MHz  
 Epsilon : 54.02 F/m  
 Sigma : 0.97 S/m  
 Density : 1000.00 kg/cu. m

Probe Data

Serial No. : 500-00283  
 Frequency Band : 750  
 Duty Cycle Factor : 1  
 Conversion Factor : 5.9  
 Probe Sensitivity : 1.20 1.20 1.20  $\mu\text{V}/(\text{V}/\text{m})^2$   
 Compression Point : 95.00 mV  
 Offset : 1.56 mm

1 gram SAR value : 0.049 W/kg  
 10 gram SAR value : 0.032 W/kg  
 Area Scan Peak SAR : 0.057 W/kg  
 Zoom Scan Peak SAR : 0.060 W/kg

**Plot 5#**

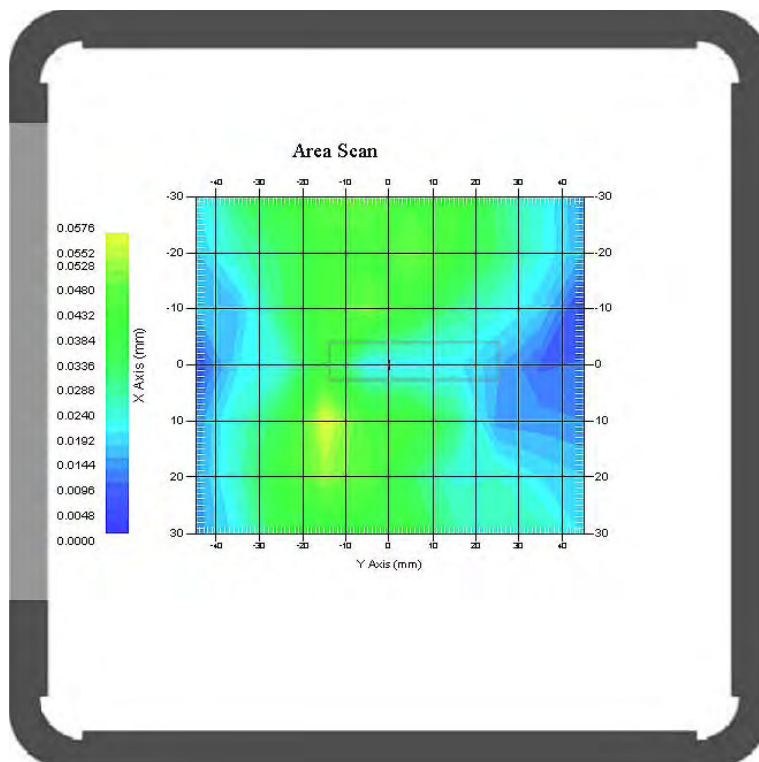

**Test Laboratory: Bay Area Compliance Lab Corp. (Shenzhen)**

**Body-Front (713.5 MHz High Channel); Resource Block Size: 50% RB; Resource Block offset: 6;**

Measurement Data

Test mode : 50%RB  
 Crest Factor : 1  
 Scan Type : Complete  
 Area Scan : 8x11x1 : Measurement x=10mm, y=10mm, z=4mm  
 Zoom Scan : 7x7x7 : Measurement x=5mm, y=5mm, z=5mm  
 Power Drift-Start : 0.377 W/kg  
 Power Drift-Finish : 0.369 W/kg  
 Power Drift (%) : -2.355

Tissue Data

Type : Body  
 Frequency : 713.5 MHz  
 Epsilon : 54.02 F/m  
 Sigma : 0.97 S/m  
 Density : 1000.00 kg/cu. m

Probe Data

Serial No. : 500-00283  
 Frequency Band : 750  
 Duty Cycle Factor : 1  
 Conversion Factor : 5.9  
 Probe Sensitivity : 1.20 1.20 1.20  $\mu\text{V}/(\text{V}/\text{m})^2$   
 Compression Point : 95.00 mV  
 Offset : 1.56 mm

1 gram SAR value : 0.475 W/kg  
 10 gram SAR value : 0.397 W/kg  
 Area Scan Peak SAR : 0.486 W/kg  
 Zoom Scan Peak SAR : 0.670 W/kg

**Plot 6#**

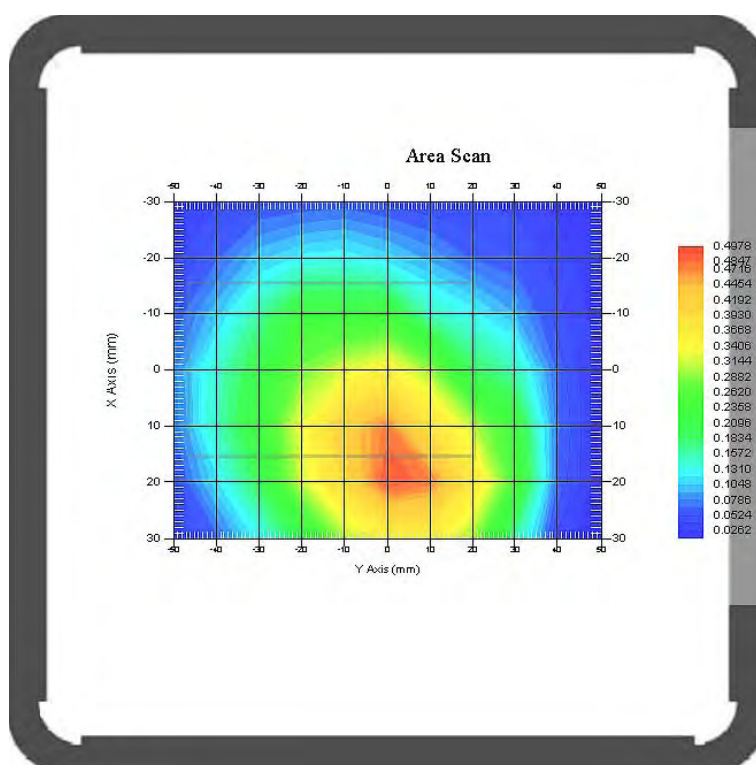

**Test Laboratory: Bay Area Compliance Lab Corp. (Shenzhen)**

**Body-Back (713.5 MHz High Channel); Resource Block Size: 50% RB; Resource Block offset: 6;**

Measurement Data

Test mode : 50%RB  
 Crest Factor : 1  
 Scan Type : Complete  
 Area Scan : 8x11x1 : Measurement x=10mm, y=10mm, z=4mm  
 Zoom Scan : 7x7x7 : Measurement x=5mm, y=5mm, z=5mm  
 Power Drift-Start : 0.296 W/kg  
 Power Drift-Finish : 0.300 W/kg  
 Power Drift (%) : 1.309

Tissue Data

Type : Body  
 Frequency : 713.5 MHz  
 Epsilon : 54.02 F/m  
 Sigma : 0.97 S/m  
 Density : 1000.00 kg/cu. m

Probe Data

Serial No. : 500-00283  
 Frequency Band : 750  
 Duty Cycle Factor : 1  
 Conversion Factor : 5.9  
 Probe Sensitivity : 1.20 1.20 1.20  $\mu\text{V}/(\text{V}/\text{m})^2$   
 Compression Point : 95.00 mV  
 Offset : 1.56 mm

1 gram SAR value : 0.365 W/kg  
 10 gram SAR value : 0.233 W/kg  
 Area Scan Peak SAR : 0.389 W/kg  
 Zoom Scan Peak SAR : 0.758 W/kg

**Plot 7#**

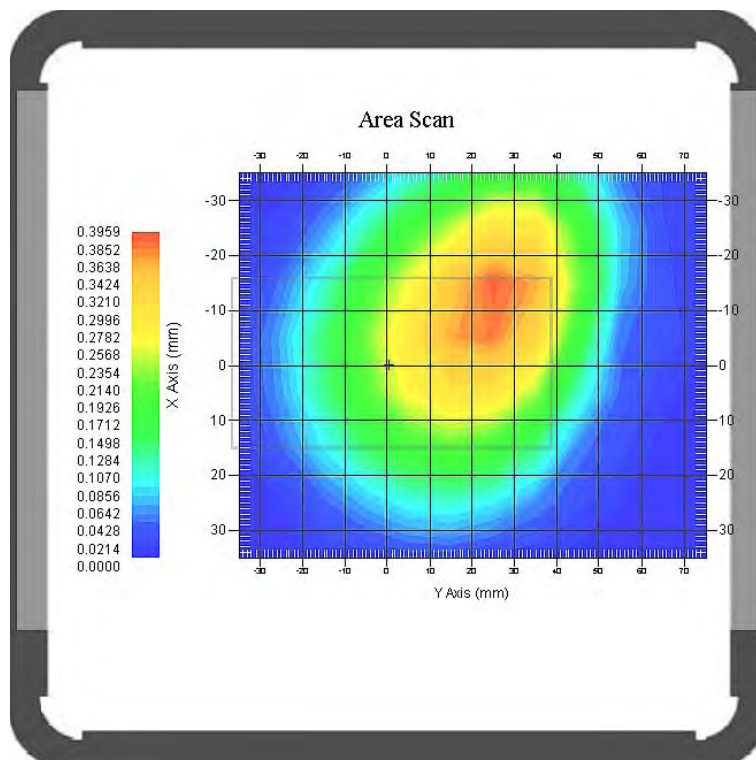

**Test Laboratory: Bay Area Compliance Lab Corp. (Shenzhen)**

**Body-Left (713.5 MHz High Channel); Resource Block Size: 50% RB; Resource Block offset: 6;**

Measurement Data

Test mode : 50%RB  
 Crest Factor : 1  
 Scan Type : Complete  
 Area Scan : 8x11x1 : Measurement x=10mm, y=10mm, z=4mm  
 Zoom Scan : 7x7x7 : Measurement x=5mm, y=5mm, z=5mm  
 Power Drift-Start : 0.044 W/kg  
 Power Drift-Finish : 0.044 W/kg  
 Power Drift (%) : -1.027

Tissue Data

Type : Body  
 Frequency : 713.5 MHz  
 Epsilon : 54.02 F/m  
 Sigma : 0.97 S/m  
 Density : 1000.00 kg/cu. m

Probe Data

Serial No. : 500-00283  
 Frequency Band : 750  
 Duty Cycle Factor : 1  
 Conversion Factor : 5.9  
 Probe Sensitivity : 1.20 1.20 1.20  $\mu\text{V}/(\text{V}/\text{m})^2$   
 Compression Point : 95.00 mV  
 Offset : 1.56 mm

1 gram SAR value : 0.069 W/kg  
 10 gram SAR value : 0.039 W/kg  
 Area Scan Peak SAR : 0.061 W/kg  
 Zoom Scan Peak SAR : 0.130 W/kg

**Plot 8#**

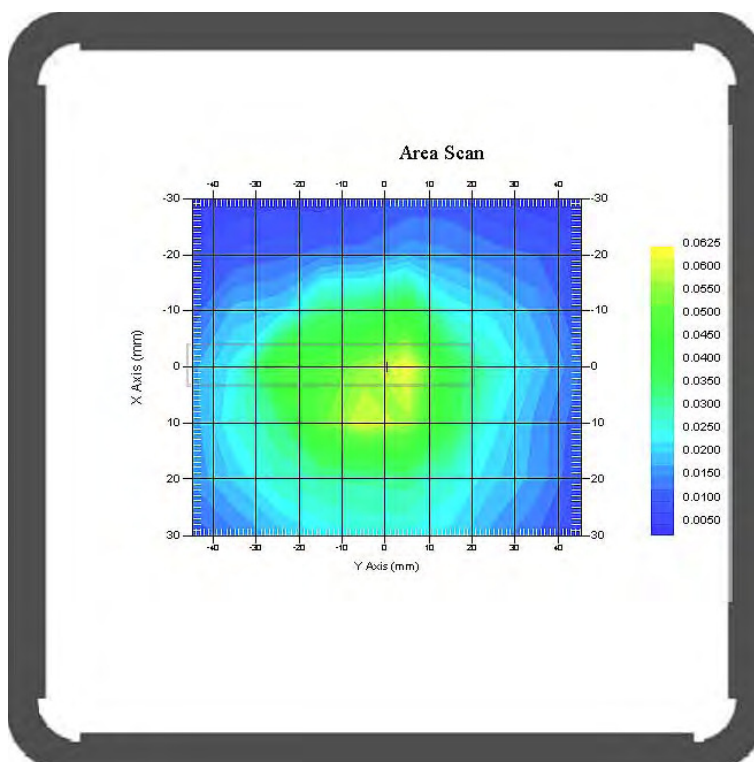

**Test Laboratory: Bay Area Compliance Lab Corp. (Shenzhen)**

**Body-Right (713.5 MHz High Channel); Resource Block Size: 50% RB; Resource Block offset: 6;**

Measurement Data

Test mode : 50%RB  
 Crest Factor : 1  
 Scan Type : Complete  
 Area Scan : 8x11x1 : Measurement x=10mm, y=10mm, z=4mm  
 Zoom Scan : 7x7x7 : Measurement x=5mm, y=5mm, z=5mm  
 Power Drift-Start : 0.186 W/kg  
 Power Drift-Finish: 0.187 W/kg  
 Power Drift (%) : 0.612

Tissue Data

Type : Body  
 Frequency : 713.5 MHz  
 Epsilon : 54.02 F/m  
 Sigma : 0.97 S/m  
 Density : 1000.00 kg/cu. m

Probe Data

Serial No. : 500-00283  
 Frequency Band : 750  
 Duty Cycle Factor : 1  
 Conversion Factor : 5.9  
 Probe Sensitivity : 1.20 1.20 1.20  $\mu\text{V}/(\text{V}/\text{m})^2$   
 Compression Point : 95.00 mV  
 Offset : 1.56 mm

1 gram SAR value : 0.239 W/kg  
 10 gram SAR value : 0.142 W/kg  
 Area Scan Peak SAR : 0.278 W/kg  
 Zoom Scan Peak SAR : 0.370 W/kg

**Plot 9#**

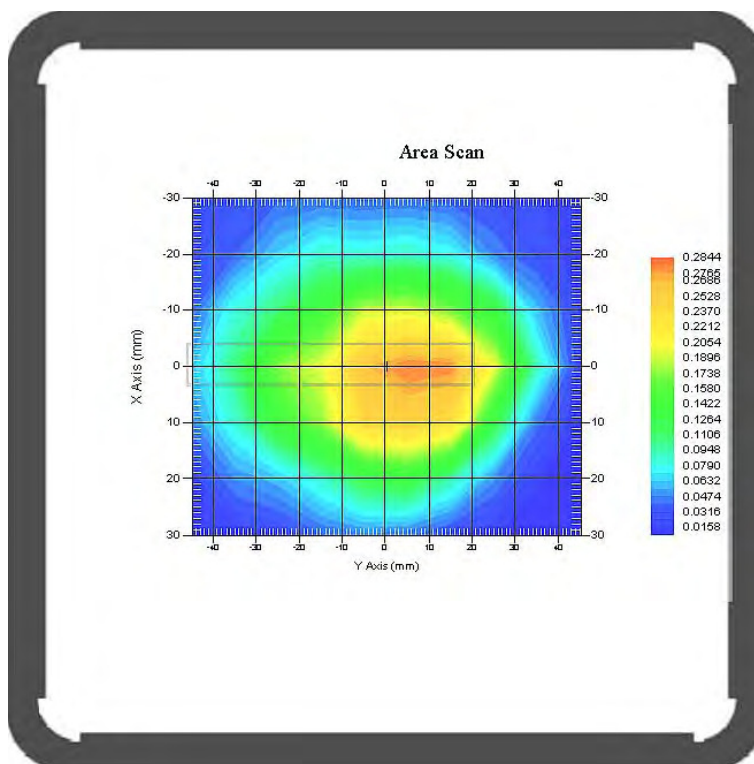

**Test Laboratory: Bay Area Compliance Lab Corp. (Shenzhen)**

**Body-Top (713.5 MHz High Channel); Resource Block Size: 50% RB; Resource Block offset: 6;**

Measurement Data

Test mode : 50%RB  
 Crest Factor : 1  
 Scan Type : Complete  
 Area Scan : 8x11x1 : Measurement x=10mm, y=10mm, z=4mm  
 Zoom Scan : 7x7x7 : Measurement x=5mm, y=5mm, z=5mm  
 Power Drift-Start : 0.065 W/kg  
 Power Drift-Finish: 0.064 W/kg  
 Power Drift (%) : -1.685

Tissue Data

Type : Body  
 Frequency : 713.5 MHz  
 Epsilon : 54.02 F/m  
 Sigma : 0.97 S/m  
 Density : 1000.00 kg/cu. m

Probe Data

Serial No. : 500-00283  
 Frequency Band : 750  
 Duty Cycle Factor : 1  
 Conversion Factor : 5.9  
 Probe Sensitivity : 1.20 1.20 1.20  $\mu\text{V}/(\text{V}/\text{m})^2$   
 Compression Point : 95.00 mV  
 Offset : 1.56 mm

1 gram SAR value : 0.071 W/kg  
 10 gram SAR value : 0.039 W/kg  
 Area Scan Peak SAR : 0.073 W/kg  
 Zoom Scan Peak SAR : 0.110 W/kg

**Plot 10#**

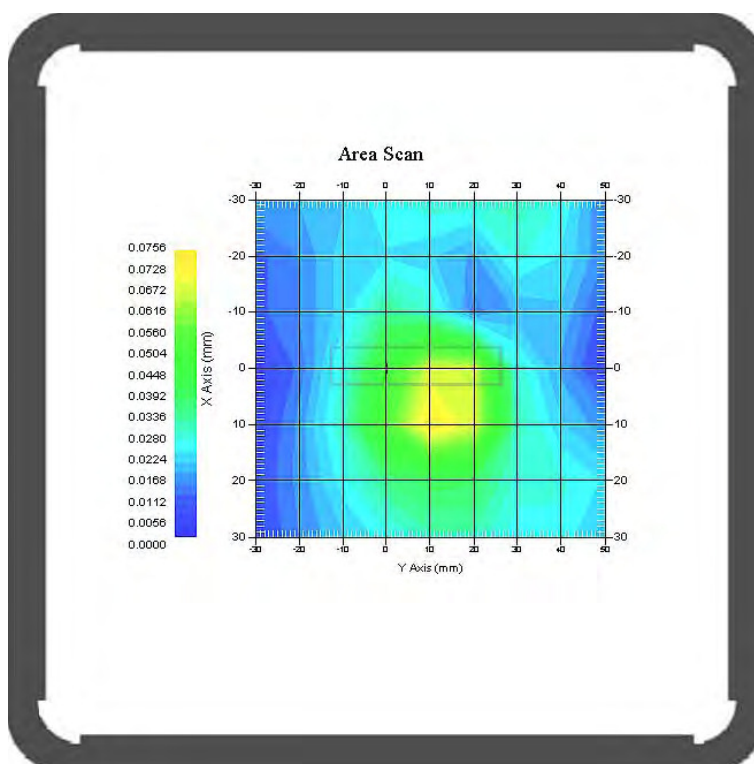

**Test Laboratory: Bay Area Compliance Lab Corp. (Shenzhen)**

**Body-Front (1852.5 MHz Low Channel); Resource Block Size: 1RB; Resource Block offset: 13;**

Measurement Data

Test mode : RB1  
 Crest Factor : 1  
 Scan Type : Complete  
 Area Scan : 8x11x1 : Measurement x=10mm, y=10mm, z=4mm  
 Zoom Scan : 7x7x7 : Measurement x=5mm, y=5mm, z=5mm  
 Power Drift-Start : 0.758 W/kg  
 Power Drift-Finish: 0.755 W/kg  
 Power Drift (%) : -0.402

Tissue Data

Type : Body  
 Frequency : 1852.5 MHz  
 Epsilon : 54.02F/m  
 Sigma : 1.51 S/m  
 Density : 1000.00 kg/cu. m

Probe Data

Serial No. : 500-00283  
 Frequency Band : 1900  
 Duty Cycle Factor : 1  
 Conversion Factor : 4.5  
 Probe Sensitivity : 1.20 1.20 1.20  $\mu\text{V}/(\text{V}/\text{m})^2$   
 Compression Point : 95.00 mV  
 Offset : 1.56 mm

1 gram SAR value : 0.990 W/kg  
 10 gram SAR value : 0.482 W/kg  
 Area Scan Peak SAR : 1.358 W/kg  
 Zoom Scan Peak SAR : 1.921 W/kg

**Plot 11#**

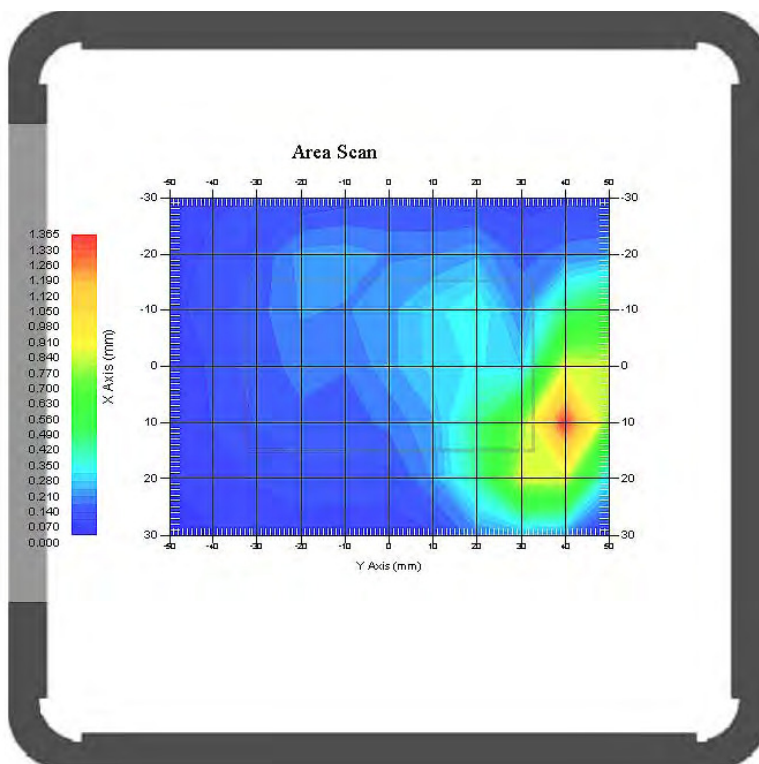



**Test Laboratory: Bay Area Compliance Lab Corp. (Shenzhen)**

**Body-Front (1882.5 MHz Middle Channel); Resource Block Size: 1RB; Resource Block offset: 13;**

Measurement Data

Test mode : RB1  
 Crest Factor : 1  
 Scan Type : Complete  
 Area Scan : 8x11x1 : Measurement x=10mm, y=10mm, z=4mm  
 Zoom Scan : 7x7x7 : Measurement x=5mm, y=5mm, z=5mm  
 Power Drift-Start : 0.669 W/kg  
 Power Drift-Finish: 0.675 W/kg  
 Power Drift (%) : 0.842

Tissue Data

Type : Body  
 Frequency : 1882.5 MHz  
 Epsilon : 53.78F/m  
 Sigma : 1.56 S/m  
 Density : 1000.00 kg/cu. m

Probe Data

Serial No. : 500-00283  
 Frequency Band : 1900  
 Duty Cycle Factor : 1  
 Conversion Factor : 4.5  
 Probe Sensitivity : 1.20 1.20 1.20  $\mu\text{V}/(\text{V}/\text{m})^2$   
 Compression Point : 95.00 mV  
 Offset : 1.56 mm

1 gram SAR value : 1.118 W/kg  
 10 gram SAR value : 0.520 W/kg  
 Area Scan Peak SAR : 1.516 W/kg  
 Zoom Scan Peak SAR : 2.432 W/kg

**Plot 12#**

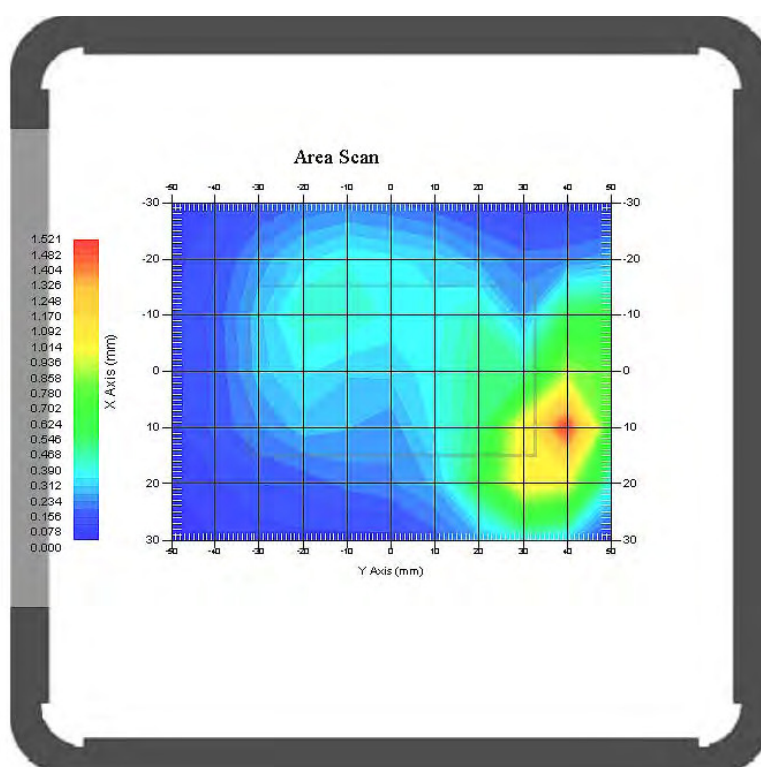

**Test Laboratory: Bay Area Compliance Lab Corp. (Shenzhen)**

**Body-Front (1912.5 MHz High Channel); Resource Block Size: 1RB; Resource Block offset: 13;**

Measurement Data

Test mode : RB1  
 Crest Factor : 1  
 Scan Type : Complete  
 Area Scan : 8x11x1 : Measurement x=10mm, y=10mm, z=4mm  
 Zoom Scan : 7x7x7 : Measurement x=5mm, y=5mm, z=5mm  
 Power Drift-Start : 0.789 W/kg  
 Power Drift-Finish: 0.800 W/kg  
 Power Drift (%) : 1.419

Tissue Data

Type : Body  
 Frequency : 1912.5 MHz  
 Epsilon : 53.89F/m  
 Sigma : 1.57 S/m  
 Density : 1000.00 kg/cu. m

Probe Data

Serial No. : 500-00283  
 Frequency Band : 1900  
 Duty Cycle Factor : 1  
 Conversion Factor : 4.5  
 Probe Sensitivity : 1.20 1.20 1.20  $\mu\text{V}/(\text{V}/\text{m})^2$   
 Compression Point : 95.00 mV  
 Offset : 1.56 mm

1 gram SAR value : 1.012 W/kg  
 10 gram SAR value : 0.501 W/kg  
 Area Scan Peak SAR : 1.309 W/kg  
 Zoom Scan Peak SAR : 1.901 W/kg

**Plot 13#**

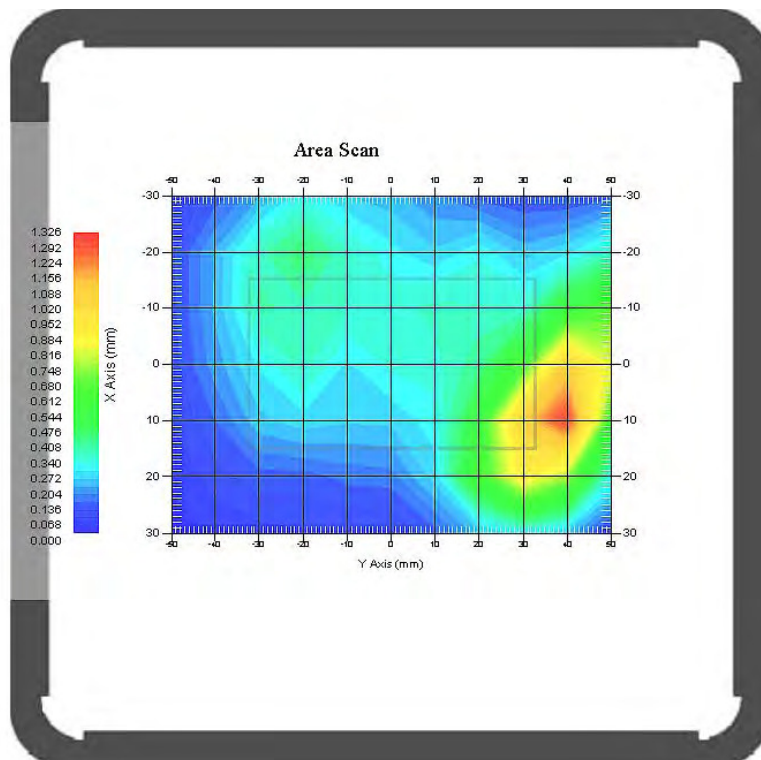

**Test Laboratory: Bay Area Compliance Lab Corp. (Shenzhen)**

**Body-Back (1852.5 MHz Low Channel); Resource Block Size: 1RB; Resource Block offset: 13;**

Measurement Data

Test mode : RB1  
 Crest Factor : 1  
 Scan Type : Complete  
 Area Scan : 8x11x1 : Measurement x=10mm, y=10mm, z=4mm  
 Zoom Scan : 7x7x7 : Measurement x=5mm, y=5mm, z=5mm  
 Power Drift-Start : 0.269 W/kg  
 Power Drift-Finish: 0.273 W/kg  
 Power Drift (%) : 1.629

Tissue Data

Type : Body  
 Frequency : 1852.5 MHz  
 Epsilon : 54.02F/m  
 Sigma : 1.51 S/m  
 Density : 1000.00 kg/cu. m

Probe Data

Serial No. : 500-00283  
 Frequency Band : 1900  
 Duty Cycle Factor : 1  
 Conversion Factor : 4.5  
 Probe Sensitivity : 1.20 1.20 1.20  $\mu\text{V}/(\text{V}/\text{m})^2$   
 Compression Point : 95.00 mV  
 Offset : 1.56 mm

1 gram SAR value : 0.391 W/kg  
 10 gram SAR value : 0.192 W/kg  
 Area Scan Peak SAR : 0.415 W/kg  
 Zoom Scan Peak SAR : 0.840 W/kg

**Plot 14#**

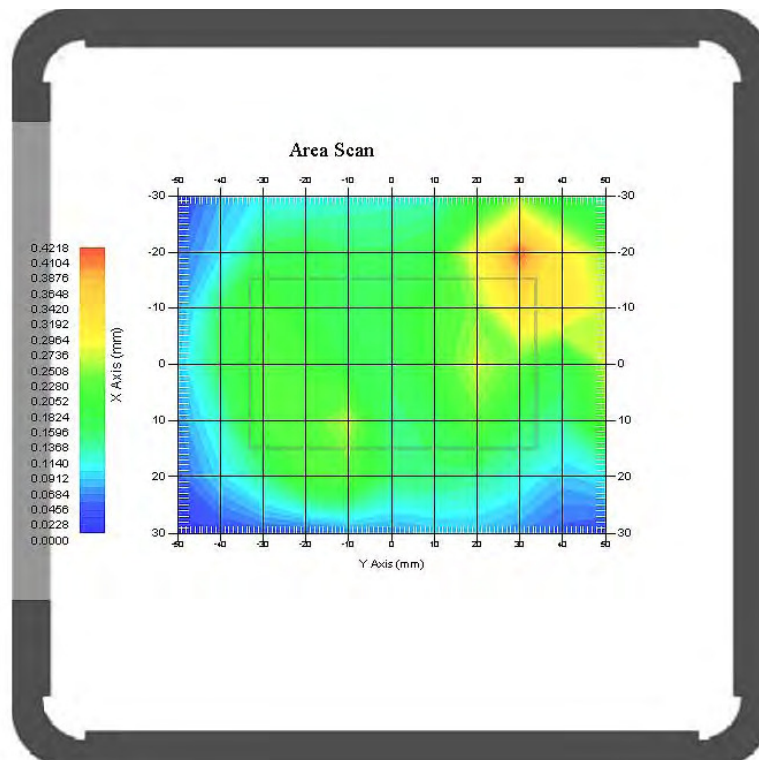

**Test Laboratory: Bay Area Compliance Lab Corp. (Shenzhen)**

**Body-Left (1852.5 MHz Low Channel); Resource Block Size: 1RB; Resource Block offset: 13;**

Measurement Data

Test mode : RB1  
 Crest Factor : 1  
 Scan Type : Complete  
 Area Scan : 8x11x1 : Measurement x=10mm, y=10mm, z=4mm  
 Zoom Scan : 7x7x7 : Measurement x=5mm, y=5mm, z=5mm  
 Power Drift-Start : 0.252 W/kg  
 Power Drift-Finish: 0.250 W/kg  
 Power Drift (%) : -0.776

Tissue Data

Type : Body  
 Frequency : 1852.5 MHz  
 Epsilon : 54.02F/m  
 Sigma : 1.51 S/m  
 Density : 1000.00 kg/cu. m

Probe Data

Serial No. : 500-00283  
 Frequency Band : 1900  
 Duty Cycle Factor : 1  
 Conversion Factor : 4.5  
 Probe Sensitivity : 1.20 1.20 1.20  $\mu\text{V}/(\text{V}/\text{m})^2$   
 Compression Point : 95.00 mV  
 Offset : 1.56 mm

1 gram SAR value : 0.302 W/kg  
 10 gram SAR value : 0.203 W/kg  
 Area Scan Peak SAR : 0.335 W/kg  
 Zoom Scan Peak SAR : 0.600 W/kg

**Plot 15#**

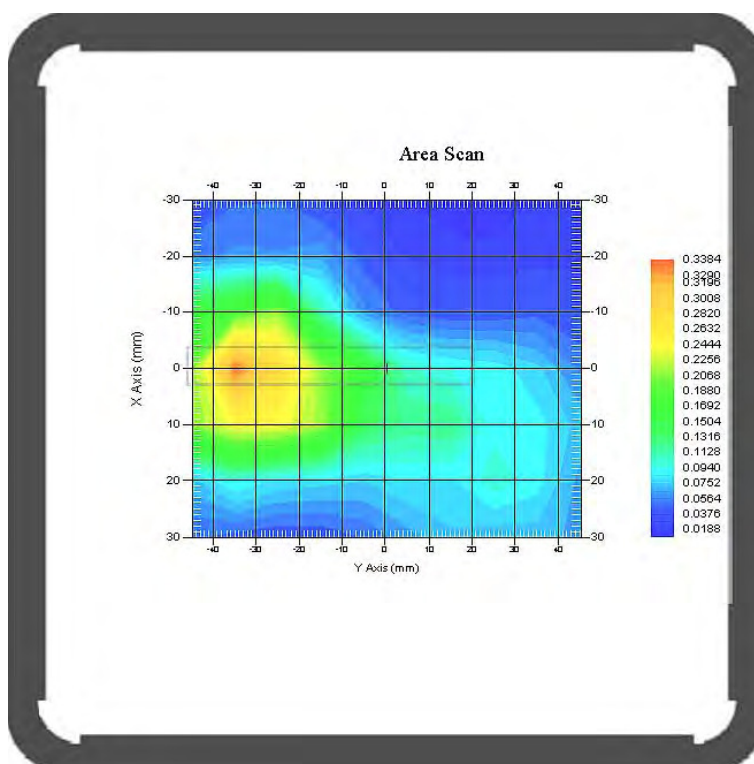

**Test Laboratory: Bay Area Compliance Lab Corp. (Shenzhen)**

**Body-Right (1852.5 MHz Low Channel); Resource Block Size: 1RB; Resource Block offset: 13;**

Measurement Data

Test mode : RB1  
 Crest Factor : 1  
 Scan Type : Complete  
 Area Scan : 8x11x1 : Measurement x=10mm, y=10mm, z=4mm  
 Zoom Scan : 7x7x7 : Measurement x=5mm, y=5mm, z=5mm  
 Power Drift-Start : 0.095 W/kg  
 Power Drift-Finish: 0.097 W/kg  
 Power Drift (%) : 2.237

Tissue Data

Type : Body  
 Frequency : 1852.5 MHz  
 Epsilon : 54.02F/m  
 Sigma : 1.51 S/m  
 Density : 1000.00 kg/cu. m

Probe Data

Serial No. : 500-00283  
 Frequency Band : 1900  
 Duty Cycle Factor : 1  
 Conversion Factor : 4.5  
 Probe Sensitivity : 1.20 1.20 1.20  $\mu\text{V}/(\text{V}/\text{m})^2$   
 Compression Point : 95.00 mV  
 Offset : 1.56 mm

1 gram SAR value : 0.115 W/kg  
 10 gram SAR value : 0.050 W/kg  
 Area Scan Peak SAR : 0.153 W/kg  
 Zoom Scan Peak SAR : 0.340 W/kg

**Plot 16#**

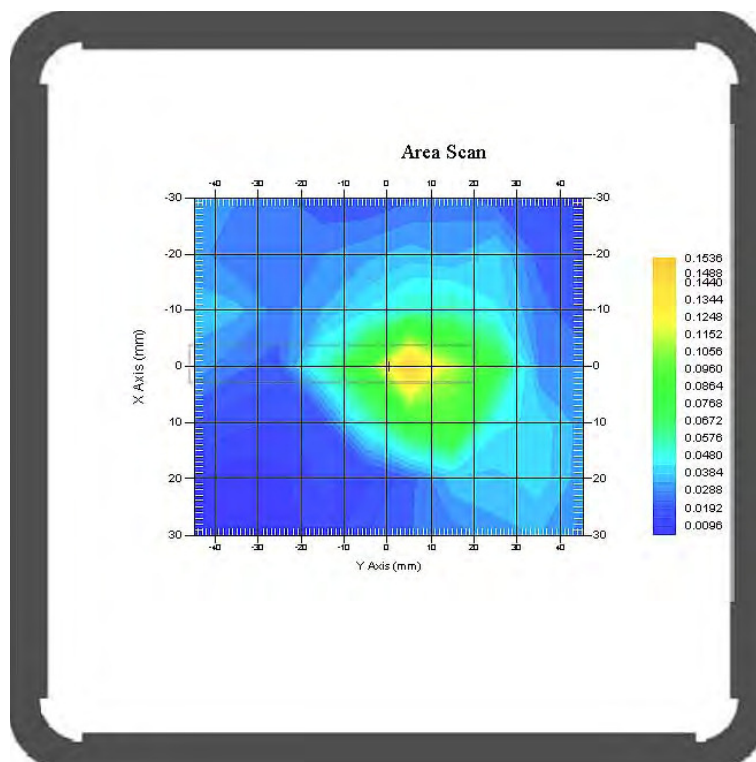

**Test Laboratory: Bay Area Compliance Lab Corp. (Shenzhen)**

**Body-Top (1852.5 MHz Low Channel); Resource Block Size: 1RB; Resource Block offset: 13;**

Measurement Data

Test mode : RB1  
 Crest Factor : 1  
 Scan Type : Complete  
 Area Scan : 8x11x1 : Measurement x=10mm, y=10mm, z=4mm  
 Zoom Scan : 7x7x7 : Measurement x=5mm, y=5mm, z=5mm  
 Power Drift-Start : 0.475 W/kg  
 Power Drift-Finish: 0.481 W/kg  
 Power Drift (%) : 1.324

Tissue Data

Type : Body  
 Frequency : 1852.5 MHz  
 Epsilon : 54.02F/m  
 Sigma : 1.51 S/m  
 Density : 1000.00 kg/cu. m

Probe Data

Serial No. : 500-00283  
 Frequency Band : 1900  
 Duty Cycle Factor : 1  
 Conversion Factor : 4.5  
 Probe Sensitivity : 1.20 1.20 1.20  $\mu\text{V}/(\text{V}/\text{m})^2$   
 Compression Point : 95.00 mV  
 Offset : 1.56 mm

1 gram SAR value : 0.594 W/kg  
 10 gram SAR value : 0.299 W/kg  
 Area Scan Peak SAR : 0.701 W/kg  
 Zoom Scan Peak SAR : 1.080 W/kg

**Plot 17#**

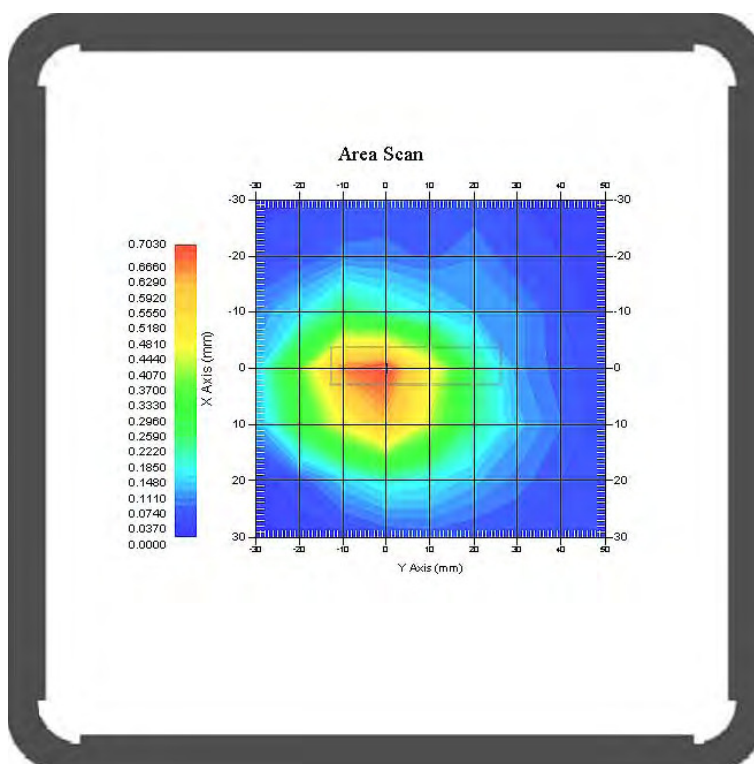

**Test Laboratory: Bay Area Compliance Lab Corp. (Shenzhen)**

**Body-Front (1852.5 MHz Low Channel); Resource Block Size: 50%RB; Resource Block offset: 13;**

Measurement Data

Test mode : 50%RB  
 Crest Factor : 1  
 Scan Type : Complete  
 Area Scan : 8x11x1 : Measurement x=10mm, y=10mm, z=4mm  
 Zoom Scan : 7x7x7 : Measurement x=5mm, y=5mm, z=5mm  
 Power Drift-Start : 0.598 W/kg  
 Power Drift-Finish: 0.602 W/kg  
 Power Drift (%) : 0.750

Tissue Data

Type : Body  
 Frequency : 1852.5 MHz  
 Epsilon : 54.02F/m  
 Sigma : 1.51 S/m  
 Density : 1000.00 kg/cu. m

Probe Data

Serial No. : 500-00283  
 Frequency Band : 1900  
 Duty Cycle Factor : 1  
 Conversion Factor : 4.5  
 Probe Sensitivity : 1.20 1.20 1.20  $\mu\text{V}/(\text{V}/\text{m})^2$   
 Compression Point : 95.00 mV  
 Offset : 1.56 mm

1 gram SAR value : 0.693 W/kg  
 10 gram SAR value : 0.347 W/kg  
 Area Scan Peak SAR : 0.764 W/kg  
 Zoom Scan Peak SAR : 1.281 W/kg

**Plot 18#**

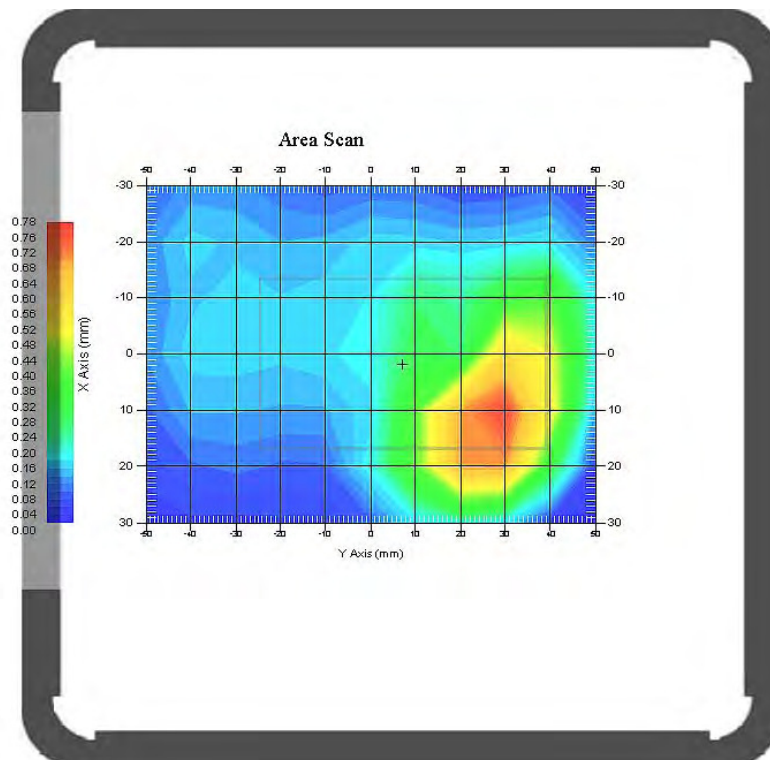

**Test Laboratory: Bay Area Compliance Lab Corp. (Shenzhen)**

**Body-Back (1852.5 MHz Low Channel); Resource Block Size: 50%RB; Resource Block offset: 13;**

Measurement Data

Test mode : 50%RB  
 Crest Factor : 1  
 Scan Type : Complete  
 Area Scan : 8x11x1 : Measurement x=10mm, y=10mm, z=4mm  
 Zoom Scan : 7x7x7 : Measurement x=5mm, y=5mm, z=5mm  
 Power Drift-Start : 0.144 W/kg  
 Power Drift-Finish: 0.142 W/kg  
 Power Drift (%) : -1.608

Tissue Data

Type : Body  
 Frequency : 1852.5 MHz  
 Epsilon : 54.02F/m  
 Sigma : 1.51 S/m  
 Density : 1000.00 kg/cu. m

Probe Data

Serial No. : 500-00283  
 Frequency Band : 1900  
 Duty Cycle Factor : 1  
 Conversion Factor : 4.5  
 Probe Sensitivity : 1.20 1.20 1.20  $\mu\text{V}/(\text{V}/\text{m})^2$   
 Compression Point : 95.00 mV  
 Offset : 1.56 mm

1 gram SAR value : 0.168 W/kg  
 10 gram SAR value : 0.085 W/kg  
 Area Scan Peak SAR : 0.198 W/kg  
 Zoom Scan Peak SAR : 0.320 W/kg

**Plot 19#**

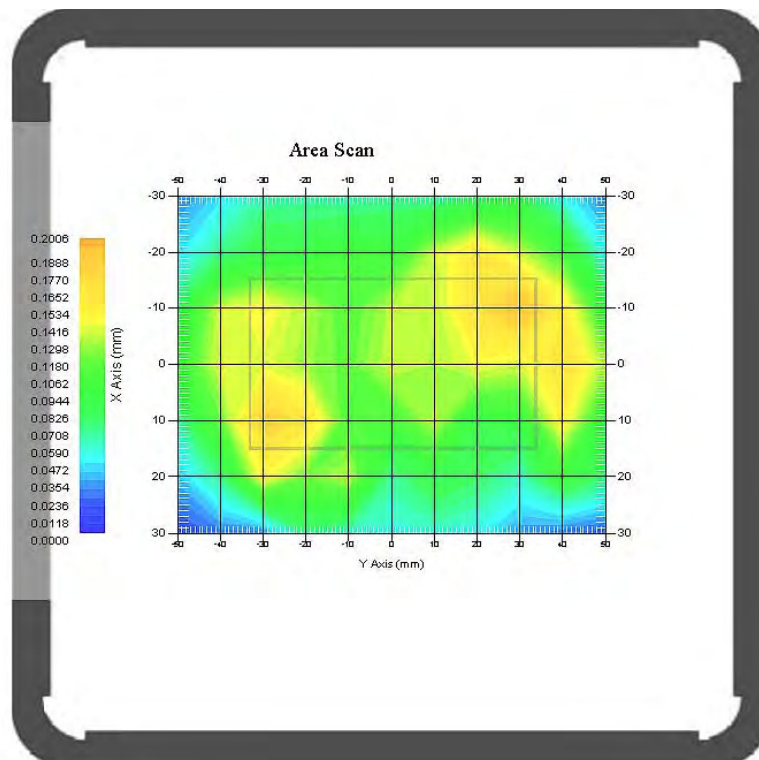



**Test Laboratory: Bay Area Compliance Lab Corp. (Shenzhen)**

**Body-Left (1852.5 MHz Low Channel); Resource Block Size: 50%RB; Resource Block offset: 13;**

Measurement Data

Test mode : 50%RB  
 Crest Factor : 1  
 Scan Type : Complete  
 Area Scan : 8x11x1 : Measurement x=10mm, y=10mm, z=4mm  
 Zoom Scan : 7x7x7 : Measurement x=5mm, y=5mm, z=5mm  
 Power Drift-Start : 0.115 W/kg  
 Power Drift-Finish: 0.117 W/kg  
 Power Drift (%) : 1.746

Tissue Data

Type : Body  
 Frequency : 1852.5 MHz  
 Epsilon : 54.02F/m  
 Sigma : 1.51 S/m  
 Density : 1000.00 kg/cu. m

Probe Data

Serial No. : 500-00283  
 Frequency Band : 1900  
 Duty Cycle Factor : 1  
 Conversion Factor : 4.5  
 Probe Sensitivity : 1.20 1.20 1.20  $\mu\text{V}/(\text{V}/\text{m})^2$   
 Compression Point : 95.00 mV  
 Offset : 1.56 mm

1 gram SAR value : 0.159 W/kg  
 10 gram SAR value : 0.077 W/kg  
 Area Scan Peak SAR : 0.152 W/kg  
 Zoom Scan Peak SAR : 0.370 W/kg

**Plot 20#**

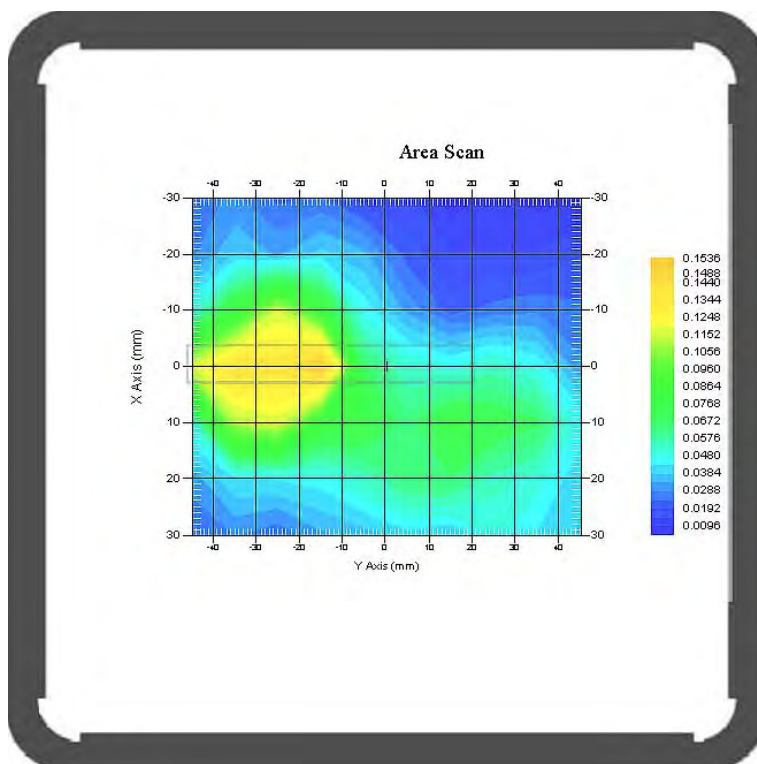

**Test Laboratory: Bay Area Compliance Lab Corp. (Shenzhen)**

**Body-Right (1852.5 MHz Low Channel); Resource Block Size: 50%RB; Resource Block offset: 13;**

Measurement Data

Test mode : 50%RB  
 Crest Factor : 1  
 Scan Type : Complete  
 Area Scan : 8x11x1 : Measurement x=10mm, y=10mm, z=4mm  
 Zoom Scan : 7x7x7 : Measurement x=5mm, y=5mm, z=5mm  
 Power Drift-Start : 0.046 W/kg  
 Power Drift-Finish: 0.046 W/kg  
 Power Drift (%) : -0.554

Tissue Data

Type : Body  
 Frequency : 1852.5 MHz  
 Epsilon : 54.02F/m  
 Sigma : 1.51 S/m  
 Density : 1000.00 kg/cu. m

Probe Data

Serial No. : 500-00283  
 Frequency Band : 1900  
 Duty Cycle Factor : 1  
 Conversion Factor : 4.5  
 Probe Sensitivity : 1.20 1.20 1.20  $\mu\text{V}/(\text{V}/\text{m})^2$   
 Compression Point : 95.00 mV  
 Offset : 1.56 mm

1 gram SAR value : 0.068 W/kg  
 10 gram SAR value : 0.032 W/kg  
 Area Scan Peak SAR : 0.076 W/kg  
 Zoom Scan Peak SAR : 0.160 W/kg

**Plot 21#**

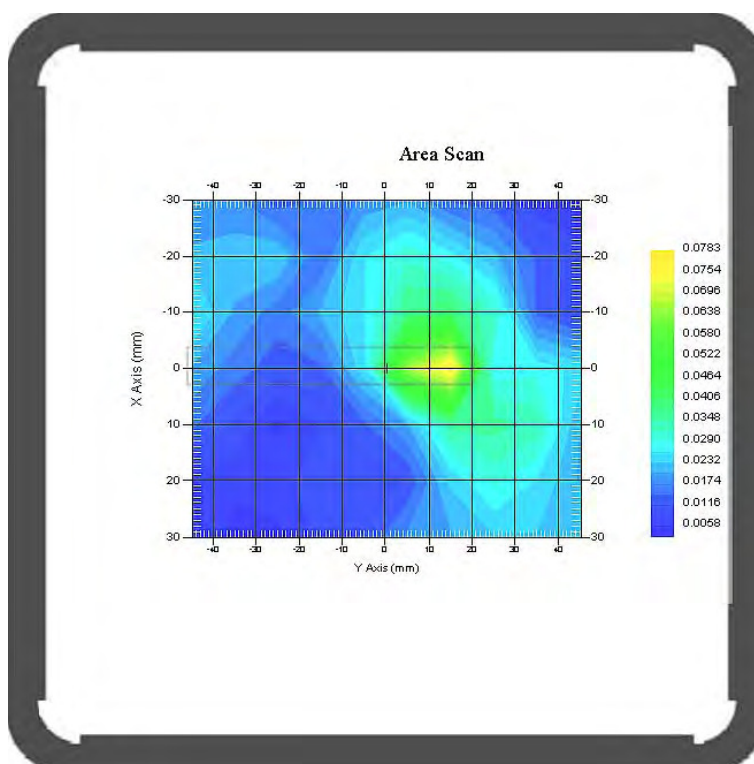

**Test Laboratory: Bay Area Compliance Lab Corp. (Shenzhen)**

**Body-Top (1852.5 MHz Low Channel); Resource Block Size: 50%RB; Resource Block offset: 13;**

Measurement Data

Test mode : 50%RB  
 Crest Factor : 1  
 Scan Type : Complete  
 Area Scan : 8x11x1 : Measurement x=10mm, y=10mm, z=4mm  
 Zoom Scan : 7x7x7 : Measurement x=5mm, y=5mm, z=5mm  
 Power Drift-Start : 0.226 W/kg  
 Power Drift-Finish: 0.230 W/kg  
 Power Drift (%) : 1.648

Tissue Data

Type : Body  
 Frequency : 1852.5 MHz  
 Epsilon : 54.02F/m  
 Sigma : 1.51 S/m  
 Density : 1000.00 kg/cu. m

Probe Data

Serial No. : 500-00283  
 Frequency Band : 1900  
 Duty Cycle Factor : 1  
 Conversion Factor : 4.5  
 Probe Sensitivity : 1.20 1.20 1.20  $\mu\text{V}/(\text{V}/\text{m})^2$   
 Compression Point : 95.00 mV  
 Offset : 1.56 mm

1 gram SAR value : 0.391 W/kg  
 10 gram SAR value : 0.164 W/kg  
 Area Scan Peak SAR : 0.393 W/kg  
 Zoom Scan Peak SAR : 0.500 W/kg

**Plot 22#**

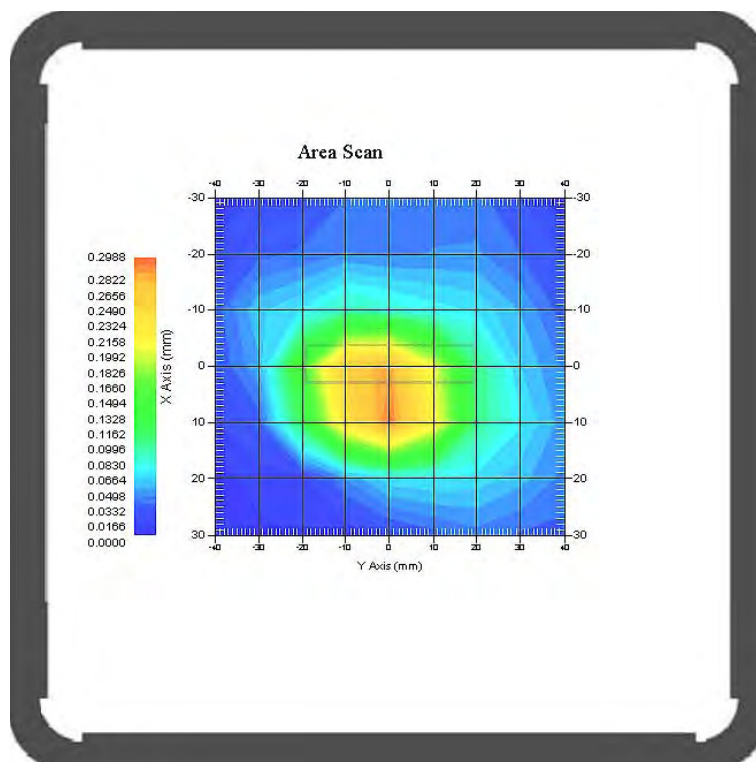

**Test Laboratory: Bay Area Compliance Lab Corp. (Shenzhen)**

**Body-Front (1852.5 MHz Low Channel); Resource Block Size: 100%RB; Resource Block offset: 0;**

Measurement Data

Test mode : 100%RB  
 Crest Factor : 1  
 Scan Type : Complete  
 Area Scan : 8x11x1 : Measurement x=10mm, y=10mm, z=4mm  
 Zoom Scan : 7x7x7 : Measurement x=5mm, y=5mm, z=5mm  
 Power Drift-Start : 0.745 W/kg  
 Power Drift-Finish: 0.739 W/kg  
 Power Drift (%) : -0.816

Tissue Data

Type : Body  
 Frequency : 1852.5 MHz  
 Epsilon : 54.02F/m  
 Sigma : 1.51 S/m  
 Density : 1000.00 kg/cu. m

Probe Data

Serial No. : 500-00283  
 Frequency Band : 1900  
 Duty Cycle Factor : 1  
 Conversion Factor : 4.5  
 Probe Sensitivity : 1.20 1.20 1.20  $\mu\text{V}/(\text{V}/\text{m})^2$   
 Compression Point : 95.00 mV  
 Offset : 1.56 mm

1 gram SAR value : 0.902 W/kg  
 10 gram SAR value : 0.412 W/kg  
 Area Scan Peak SAR : 0.914 W/kg  
 Zoom Scan Peak SAR : 1.600 W/kg

**Plot 23#**

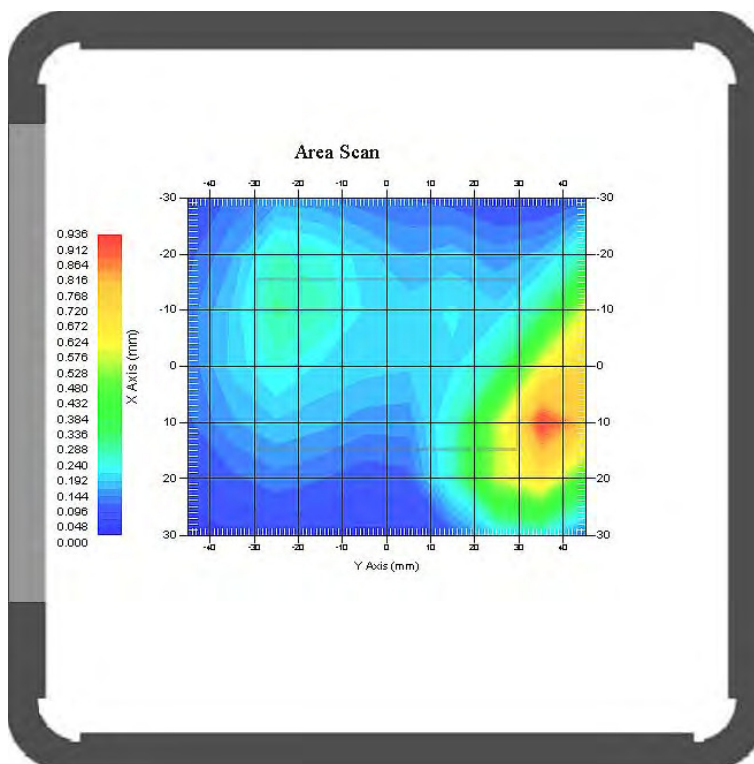

**Test Laboratory: Bay Area Compliance Lab Corp. (Shenzhen)**

**Body-Front (836.52 MHz Middle Channel) ; 1x Ev-Do Rev0**

Measurement Data

Test mode : CDMA-Cellular  
 Crest Factor : 1  
 Scan Type : Complete  
 Area Scan : 8x11x1 : Measurement x=10mm, y=10mm, z=4mm  
 Zoom Scan : 7x7x7 : Measurement x=5mm, y=5mm, z=5mm  
 Power Drift-Start : 0.528 W/kg  
 Power Drift-Finish : 0.521 W/kg  
 Power Drift (%) : -1.367

Tissue Data

Type : Body  
 Frequency : 836.52 MHz  
 Epsilon : 54.70 F/m  
 Sigma : 0.97 S/m  
 Density : 1000.00 kg/cu. m

Probe Data

Serial No. : 500-00283  
 Frequency Band : 835  
 Duty Cycle Factor : 1  
 Conversion Factor : 5.9  
 Probe Sensitivity : 1.20 1.20 1.20  $\mu\text{V}/(\text{V}/\text{m})^2$   
 Compression Point : 95.00 mV  
 Offset : 1.56 mm

1 gram SAR value : 0.768W/kg  
 10 gram SAR value : 0.461 W/kg  
 Area Scan Peak SAR : 0.757 W/kg  
 Zoom Scan Peak SAR : 1.471 W/kg

**Plot 24#**

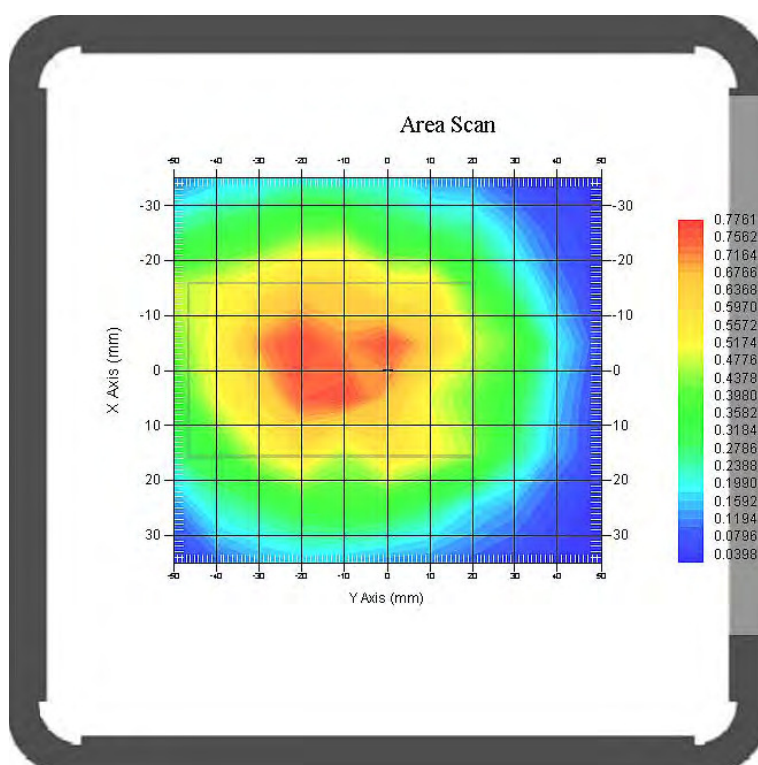

**Test Laboratory: Bay Area Compliance Lab Corp. (Shenzhen)**

**Body-Back (836.52 MHz Middle Channel) ; 1x Ev-Do Rev0**

Measurement Data

Test mode : CDMA-Cellular  
 Crest Factor : 1  
 Scan Type : Complete  
 Area Scan : 8x11x1 : Measurement x=10mm, y=10mm, z=4mm  
 Zoom Scan : 7x7x7 : Measurement x=5mm, y=5mm, z=5mm  
 Power Drift-Start : 0.475 W/kg  
 Power Drift-Finish : 0.470 W/kg  
 Power Drift (%) : -1.174

Tissue Data

Type : Body  
 Frequency : 836.52 MHz  
 Epsilon : 54.70 F/m  
 Sigma : 0.97 S/m  
 Density : 1000.00 kg/cu. m

Probe Data

Serial No. : 500-00283  
 Frequency Band : 835  
 Duty Cycle Factor : 1  
 Conversion Factor : 5.9  
 Probe Sensitivity : 1.20 1.20 1.20  $\mu\text{V}/(\text{V}/\text{m})^2$   
 Compression Point : 95.00 mV  
 Offset : 1.56 mm

1 gram SAR value : 0.635 W/kg  
 10 gram SAR value : 0.389 W/kg  
 Area Scan Peak SAR : 0.639 W/kg  
 Zoom Scan Peak SAR : 1.191 W/kg

**Plot 25#**

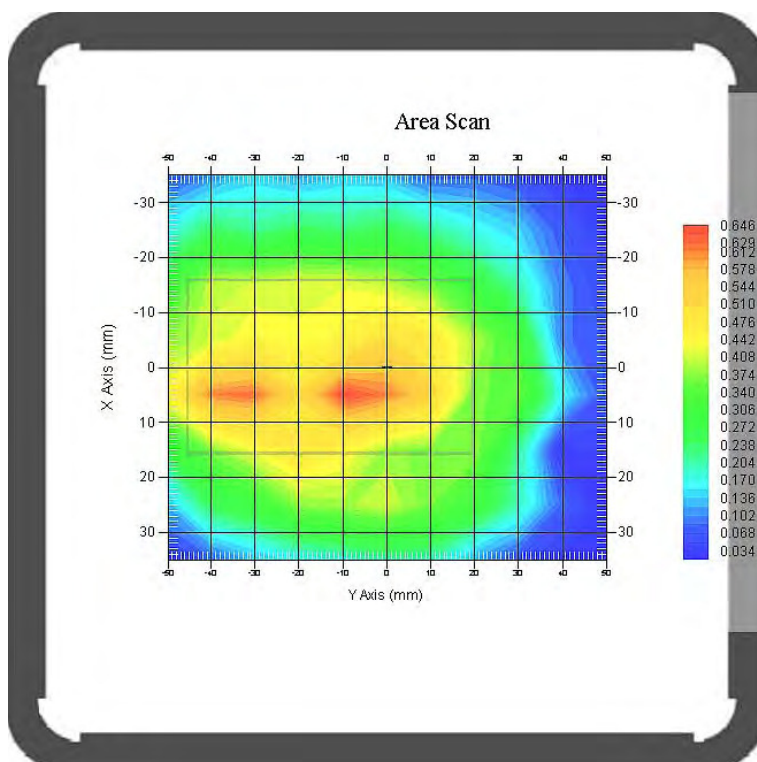

**Test Laboratory: Bay Area Compliance Lab Corp. (Shenzhen)**

**Body-Left Body-Front (836.52 MHz Middle Channel) ; 1x Ev-Do Rev0**

Measurement Data

Test mode : CDMA-Cellular  
 Crest Factor : 1  
 Scan Type : Complete  
 Area Scan : 8x11x1 : Measurement x=10mm, y=10mm, z=4mm  
 Zoom Scan : 7x7x7 : Measurement x=5mm, y=5mm, z=5mm  
 Power Drift-Start : 0.375 W/kg  
 Power Drift-Finish : 0.377 W/kg  
 Power Drift (%) : 0.598

Tissue Data

Type : Body  
 Frequency : 836.52MHz  
 Epsilon : 54.70 F/m  
 Sigma : 0.97 S/m  
 Density : 1000.00 kg/cu. m

Probe Data

Serial No. : 500-00283  
 Frequency Band : 835  
 Duty Cycle Factor : 1  
 Conversion Factor : 5.9  
 Probe Sensitivity : 1.20 1.20 1.20  $\mu\text{V}/(\text{V}/\text{m})^2$   
 Compression Point : 95.00 mV  
 Offset : 1.56 mm

1 gram SAR value : 0.482 W/kg  
 10 gram SAR value : 0.326 W/kg  
 Area Scan Peak SAR : 0.539 W/kg  
 Zoom Scan Peak SAR : 0.710 W/kg

**Plot 26#**

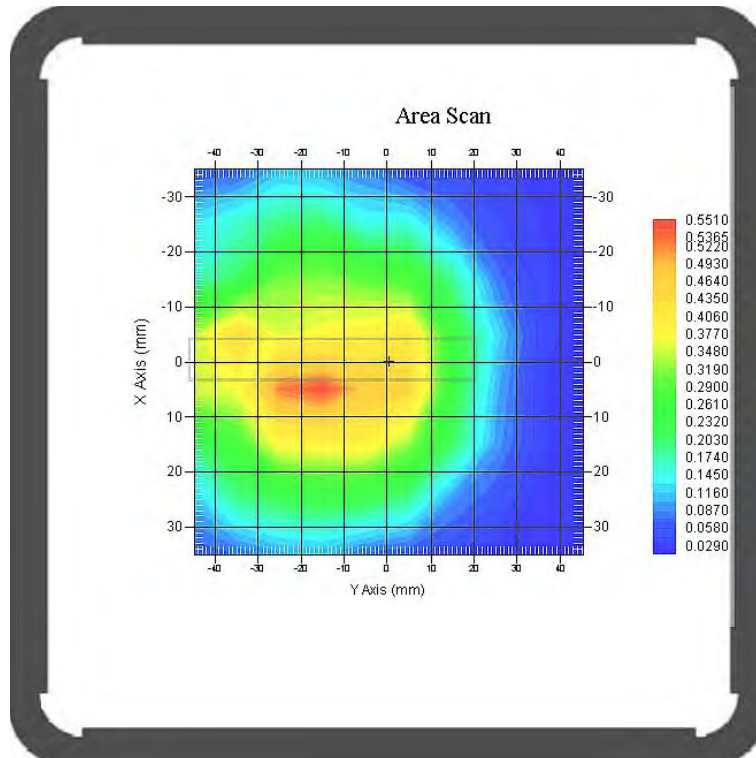

**Test Laboratory: Bay Area Compliance Lab Corp. (Shenzhen)**

**Body-Right Body-Front (836.52 MHz Middle Channel) ; 1x Ev-Do Rev0**

Measurement Data

Test mode : CDMA-Cellular  
 Crest Factor : 1  
 Scan Type : Complete  
 Area Scan : 8x11x1 : Measurement x=10mm, y=10mm, z=4mm  
 Zoom Scan : 7x7x7 : Measurement x=5mm, y=5mm, z=5mm  
 Power Drift-Start : 0.305 W/kg  
 Power Drift-Finish : 0.313 W/kg  
 Power Drift (%) : 2.428

Tissue Data

Type : Body  
 Frequency : 836.52 MHz  
 Epsilon : 54.70 F/m  
 Sigma : 0.97 S/m  
 Density : 1000.00 kg/cu. m

Probe Data

Serial No. : 500-00283  
 Frequency Band : 835  
 Duty Cycle Factor : 1  
 Conversion Factor : 5.9  
 Probe Sensitivity : 1.20 1.20 1.20  $\mu\text{V}/(\text{V}/\text{m})^2$   
 Compression Point : 95.00 mV  
 Offset : 1.56 mm

1 gram SAR value : 0.386W/kg  
 10 gram SAR value : 0.161 W/kg  
 Area Scan Peak SAR : 0.397 W/kg  
 Zoom Scan Peak SAR : 0.410 W/kg

**Plot 27#**

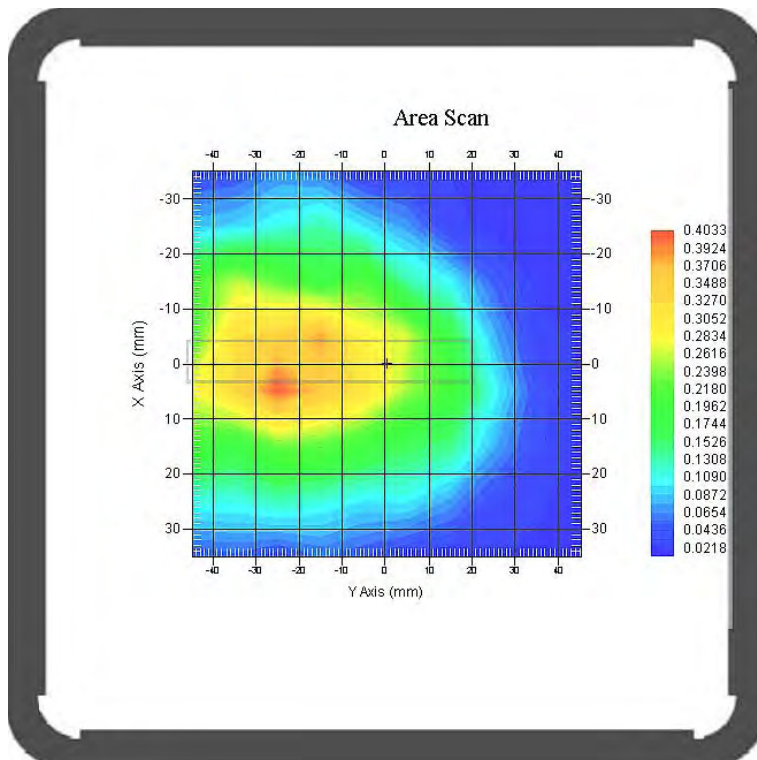



**Test Laboratory: Bay Area Compliance Lab Corp. (Shenzhen)**

**Body-Top Body-Front (836.52 MHz Middle Channel) ; 1x Ev-Do Rev0**

Measurement Data

Test mode : CDMA-Cellular  
 Crest Factor : 1  
 Scan Type : Complete  
 Area Scan : 8x11x1 : Measurement x=10mm, y=10mm, z=4mm  
 Zoom Scan : 7x7x7 : Measurement x=5mm, y=5mm, z=5mm  
 Power Drift-Start : 0.102 W/kg  
 Power Drift-Finish : 0.101 W/kg  
 Power Drift (%) : -0.915

Tissue Data

Type : Body  
 Frequency : 836.52 MHz  
 Epsilon : 54.70 F/m  
 Sigma : 0.97 S/m  
 Density : 1000.00 kg/cu. m

Probe Data

Serial No. : 500-00283  
 Frequency Band : 835  
 Duty Cycle Factor : 1  
 Conversion Factor : 5.9  
 Probe Sensitivity : 1.20 1.20 1.20  $\mu\text{V}/(\text{V}/\text{m})^2$   
 Compression Point : 95.00 mV  
 Offset : 1.56 mm

1 gram SAR value : 0.159 W/kg  
 10 gram SAR value : 0.065 W/kg  
 Area Scan Peak SAR : 0.166 W/kg  
 Zoom Scan Peak SAR : 0.410 W/kg

**Plot 28#**

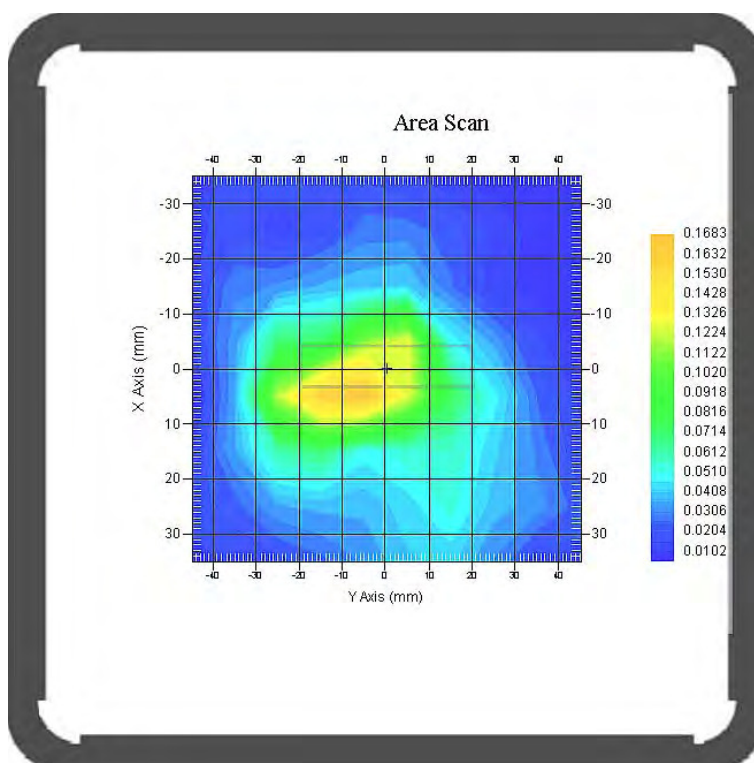

**Test Laboratory: Bay Area Compliance Lab Corp. (Shenzhen)**

**Body-Front (1851.25 MHz Low Channel);SO32+FCH**

Measurement Data

Test mode : CDMA-PCS  
 Crest Factor : 1  
 Scan Type : Complete  
 Area Scan : 8x11x1 : Measurement x=10mm, y=10mm, z=4mm  
 Zoom Scan : 7x7x7 : Measurement x=5mm, y=5mm, z=5mm  
 Power Drift-Start : 0.952 W/kg  
 Power Drift-Finish : 0.963 W/kg  
 Power Drift (%) : 1.185

Tissue Data

Type : Body  
 Frequency : 1851.25 MHz  
 Epsilon : 54.00 F/m  
 Sigma : 1.51 S/m  
 Density : 1000.00 kg/cu. m

Probe Data

Serial No. : 500-00283  
 Frequency Band : 1900  
 Duty Cycle Factor : 1  
 Conversion Factor : 4.5  
 Probe Sensitivity : 1.20 1.20 1.20  $\mu\text{V}/(\text{V}/\text{m})^2$   
 Compression Point : 95.00 mV  
 Offset : 1.56 mm

1 gram SAR value : 1.260 W/kg  
 10 gram SAR value : 0.715 W/kg  
 Area Scan Peak SAR : 1.433 W/kg  
 Zoom Scan Peak SAR : 1.914 W/kg

**Plot 29#**

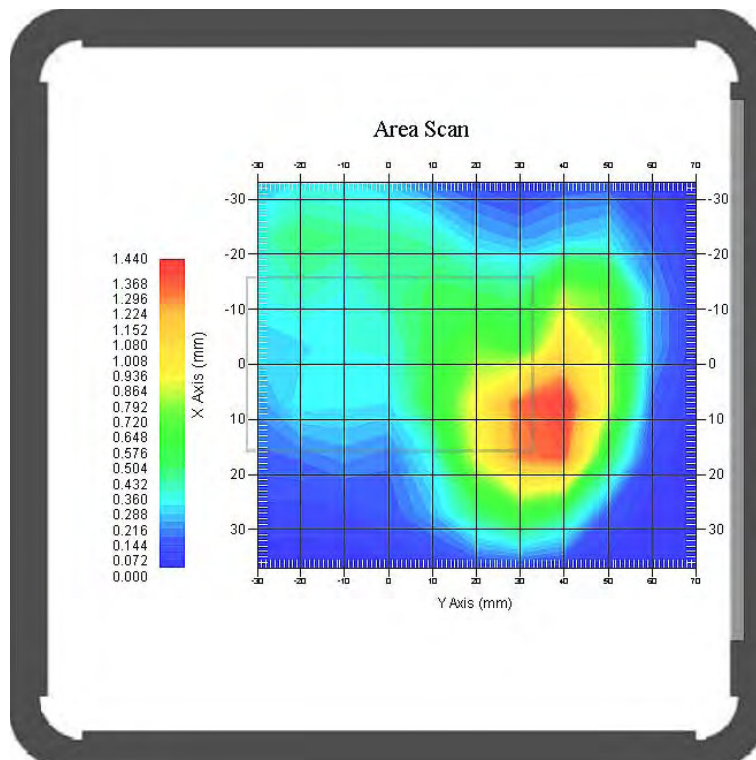

**Test Laboratory: Bay Area Compliance Lab Corp. (Shenzhen)**

**Body-Front (1880 MHz Middle Channel) ;SO32+FCH**

Measurement Data

Test mode : CDMA-PCS  
 Crest Factor : 1  
 Scan Type : Complete  
 Area Scan : 8x11x1 : Measurement x=10mm, y=10mm, z=4mm  
 Zoom Scan : 7x7x7 : Measurement x=5mm, y=5mm, z=5mm  
 Power Drift-Start : 0.749 W/kg  
 Power Drift-Finish : 0.755 W/kg  
 Power Drift (%) : 0.794

Tissue Data

Type : Body  
 Frequency : 1880 MHz  
 Epsilon : 53.93F/m  
 Sigma : 1.55 S/m  
 Density : 1000.00 kg/cu. m

Probe Data

Serial No. : 500-00283  
 Frequency Band : 1900  
 Duty Cycle Factor : 1  
 Conversion Factor : 4.5  
 Probe Sensitivity : 1.20 1.20 1.20  $\mu\text{V}/(\text{V}/\text{m})^2$   
 Compression Point : 95.00 mV  
 Offset : 1.56 mm

1 gram SAR value : 0.983 W/kg  
 10 gram SAR value : 0.418 W/kg  
 Area Scan Peak SAR : 0.995 W/kg  
 Zoom Scan Peak SAR : 1.521 W/kg

**Plot 30#**

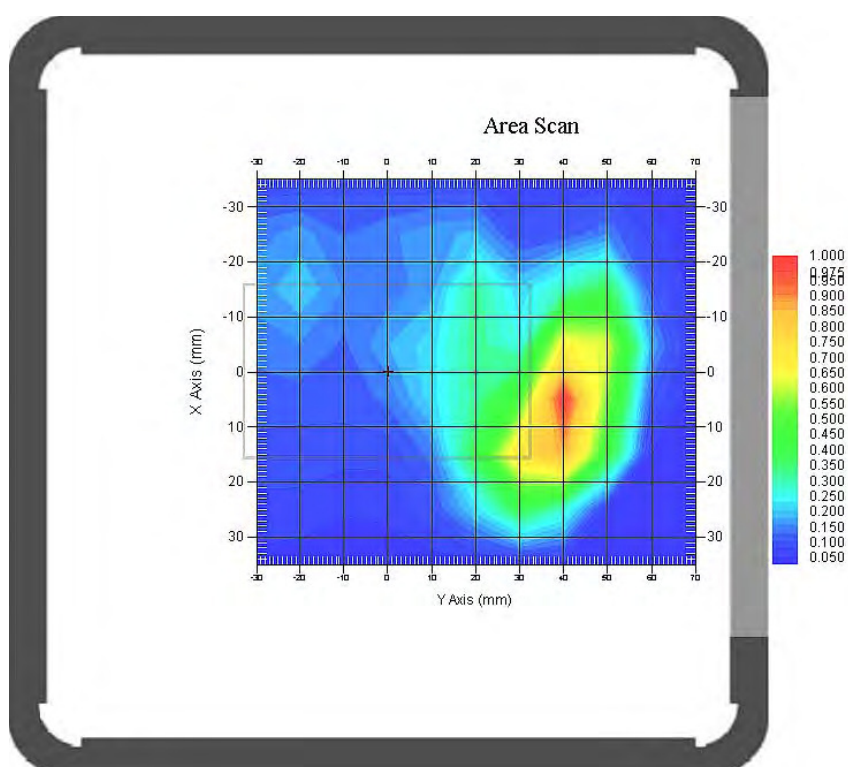

**Test Laboratory: Bay Area Compliance Lab Corp. (Shenzhen)**

**Body-Front (1908.75 MHz High Channel) ;SO32+FCH**

Measurement Data

Test mode : CDMA-PCS  
 Crest Factor : 1  
 Scan Type : Complete  
 Area Scan : 8x11x1 : Measurement x=10mm, y=10mm, z=4mm  
 Zoom Scan : 7x7x7 : Measurement x=5mm, y=5mm, z=5mm  
 Power Drift-Start : 0.558 W/kg  
 Power Drift-Finish : 0.571 W/kg  
 Power Drift (%) : 2.198

Tissue Data

Type : Body  
 Frequency : 1908.75 MHz  
 Epsilon : 53.86 F/m  
 Sigma : 1.56 S/m  
 Density : 1000.00 kg/cu. m

Probe Data

Serial No. : 500-00283  
 Frequency Band : 1900  
 Duty Cycle Factor : 1  
 Conversion Factor : 4.5  
 Probe Sensitivity : 1.20 1.20 1.20  $\mu\text{V}/(\text{V}/\text{m})^2$   
 Compression Point : 95.00 mV  
 Offset : 1.56 mm

1 gram SAR value : 0.833 W/kg  
 10 gram SAR value : 0.395 W/kg  
 Area Scan Peak SAR : 0.931 W/kg  
 Zoom Scan Peak SAR : 1.428 W/kg

**Plot 31#**

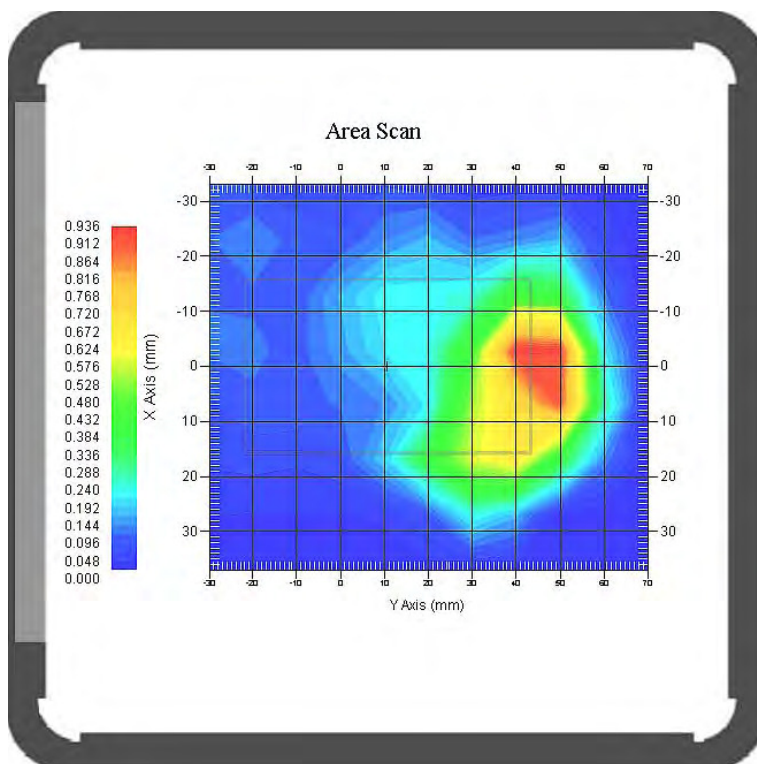

**Test Laboratory: Bay Area Compliance Lab Corp. (Shenzhen)**

**Body-Back (1851.25 MHz Low Channel) ;SO32+FCH**

Measurement Data

Test mode : CDMA-PCS  
 Crest Factor : 1  
 Scan Type : Complete  
 Area Scan : 8x11x1 : Measurement x=10mm, y=10mm, z=4mm  
 Zoom Scan : 7x7x7 : Measurement x=5mm, y=5mm, z=5mm  
 Power Drift-Start : 0.457 W/kg  
 Power Drift-Finish : 0.450 W/kg  
 Power Drift (%) : -1.647

Tissue Data

Type : Body  
 Frequency : 1851.25 MHz  
 Epsilon : 54.00 F/m  
 Sigma : 1.51 S/m  
 Density : 1000.00 kg/cu. m

Probe Data

Serial No. : 500-00283  
 Frequency Band : 1900  
 Duty Cycle Factor : 1  
 Conversion Factor : 4.5  
 Probe Sensitivity : 1.20 1.20 1.20  $\mu\text{V}/(\text{V}/\text{m})^2$   
 Compression Point : 95.00 mV  
 Offset : 1.56 mm

1 gram SAR value : 0.526 W/kg  
 10 gram SAR value : 0.178 W/kg  
 Area Scan Peak SAR : 0.704 W/kg  
 Zoom Scan Peak SAR : 1.661 W/kg

**Plot 32#**

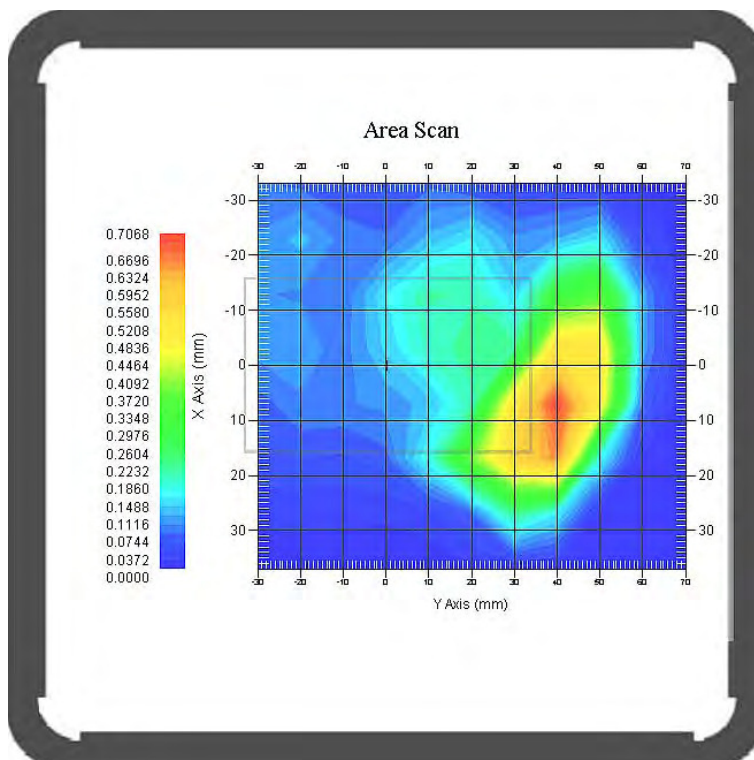

**Test Laboratory: Bay Area Compliance Lab Corp. (Shenzhen)**

**Body-Left (1851.25 MHz Low Channel) ;SO32+FCH**

Measurement Data

Test mode : CDMA-PCS  
 Crest Factor : 1  
 Scan Type : Complete  
 Area Scan : 8x11x1 : Measurement x=10mm, y=10mm, z=4mm  
 Zoom Scan : 7x7x7 : Measurement x=5mm, y=5mm, z=5mm  
 Power Drift-Start : 0.158 W/kg  
 Power Drift-Finish : 0.155 W/kg  
 Power Drift (%) : -1.857

Tissue Data

Type : Body  
 Frequency : 1851.25 MHz  
 Epsilon : 54.00 F/m  
 Sigma : 1.51 S/m  
 Density : 1000.00 kg/cu. m

Probe Data

Serial No. : 500-00283  
 Frequency Band : 1900  
 Duty Cycle Factor : 1  
 Conversion Factor : 4.5  
 Probe Sensitivity : 1.20 1.20 1.20  $\mu\text{V}/(\text{V}/\text{m})^2$   
 Compression Point : 95.00 mV  
 Offset : 1.56 mm

1 gram SAR value : 0.247 W/kg  
 10 gram SAR value : 0.129 W/kg  
 Area Scan Peak SAR : 0.274 W/kg  
 Zoom Scan Peak SAR : 0.600 W/kg

**Plot 33#**

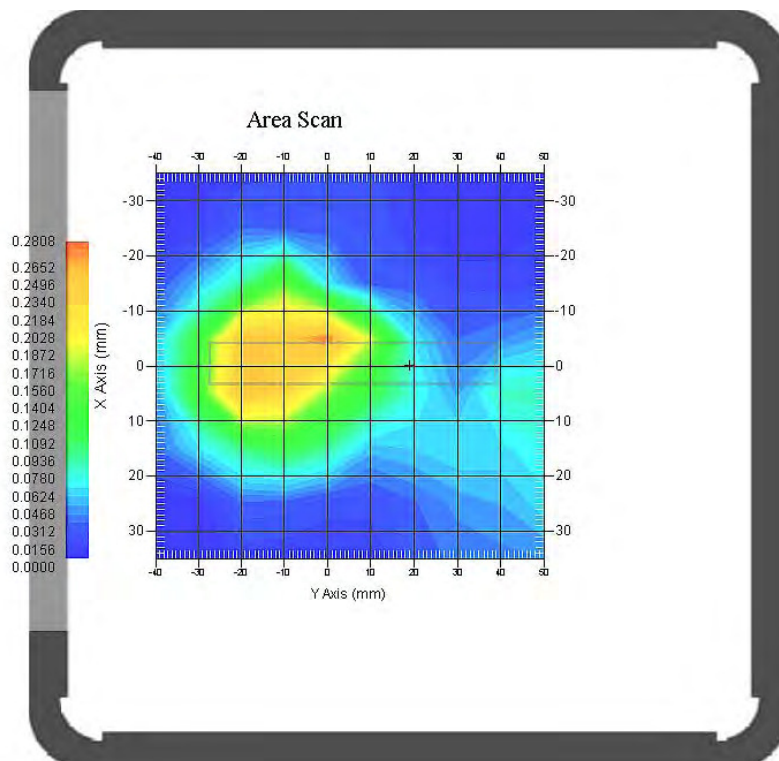

**Test Laboratory: Bay Area Compliance Lab Corp. (Shenzhen)**

**Body-Right (1851.25 MHz Low Channel) ;SO32+FCH**

Measurement Data

Test mode : CDMA-PCS  
 Crest Factor : 1  
 Scan Type : Complete  
 Area Scan : 8x11x1 : Measurement x=10mm, y=10mm, z=4mm  
 Zoom Scan : 7x7x7 : Measurement x=5mm, y=5mm, z=5mm  
 Power Drift-Start : 0.029 W/kg  
 Power Drift-Finish : 0.029 W/kg  
 Power Drift (%) : 1.154

Tissue Data

Type : Body  
 Frequency : 1851.25 MHz  
 Epsilon : 54.00 F/m  
 Sigma : 1.51 S/m  
 Density : 1000.00 kg/cu. m

Probe Data

Serial No. : 500-00283  
 Frequency Band : 1900  
 Duty Cycle Factor : 1  
 Conversion Factor : 4.5  
 Probe Sensitivity : 1.20 1.20 1.20  $\mu\text{V}/(\text{V}/\text{m})^2$   
 Compression Point : 95.00 mV  
 Offset : 1.56 mm

1 gram SAR value : 0.058 W/kg  
 10 gram SAR value : 0.033 W/kg  
 Area Scan Peak SAR : 0.066 W/kg  
 Zoom Scan Peak SAR : 0.250 W/kg

**Plot 34#**

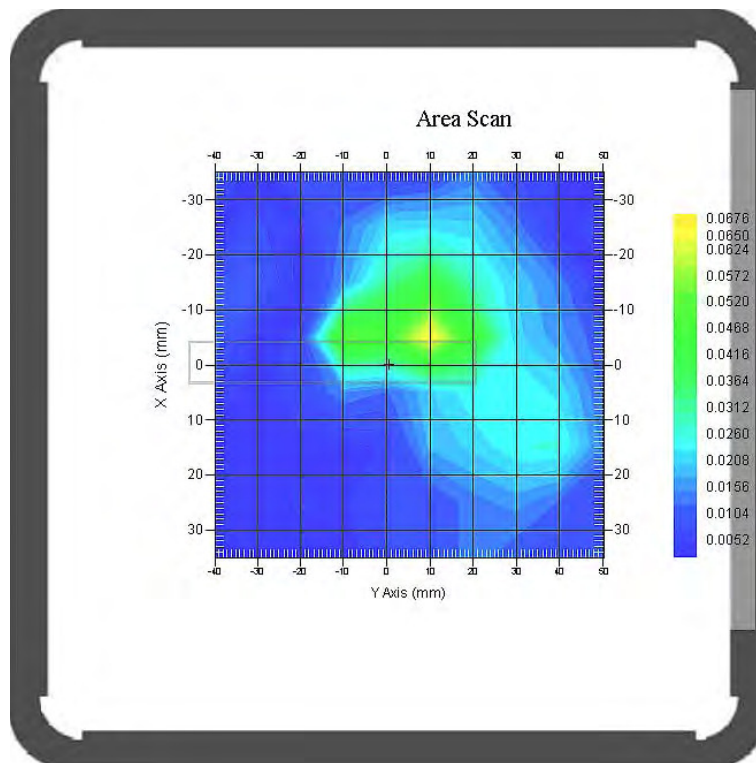

**Test Laboratory: Bay Area Compliance Lab Corp. (Shenzhen)**

**Body-Top (1851.25 MHz Low Channel) ;SO32+FCH**

Measurement Data

Test mode : CDMA-PCS  
 Crest Factor : 1  
 Scan Type : Complete  
 Area Scan : 8x11x1 : Measurement x=10mm, y=10mm, z=4mm  
 Zoom Scan : 7x7x7 : Measurement x=5mm, y=5mm, z=5mm  
 Power Drift-Start : 0.298 W/kg  
 Power Drift-Finish : 0.305 W/kg  
 Power Drift (%) : 2.495

Tissue Data

Type : Body  
 Frequency : 1851.25 MHz  
 Epsilon : 54.00 F/m  
 Sigma : 1.51 S/m  
 Density : 1000.00 kg/cu. m

Probe Data

Serial No. : 500-00283  
 Frequency Band : 1900  
 Duty Cycle Factor : 1  
 Conversion Factor : 4.5  
 Probe Sensitivity : 1.20 1.20 1.20  $\mu\text{V}/(\text{V}/\text{m})^2$   
 Compression Point : 95.00 mV  
 Offset : 1.56 mm

1 gram SAR value : 0.414 W/kg  
 10 gram SAR value : 0.171 W/kg  
 Area Scan Peak SAR : 0.432 W/kg  
 Zoom Scan Peak SAR : 0.790 W/kg

**Plot 35#**

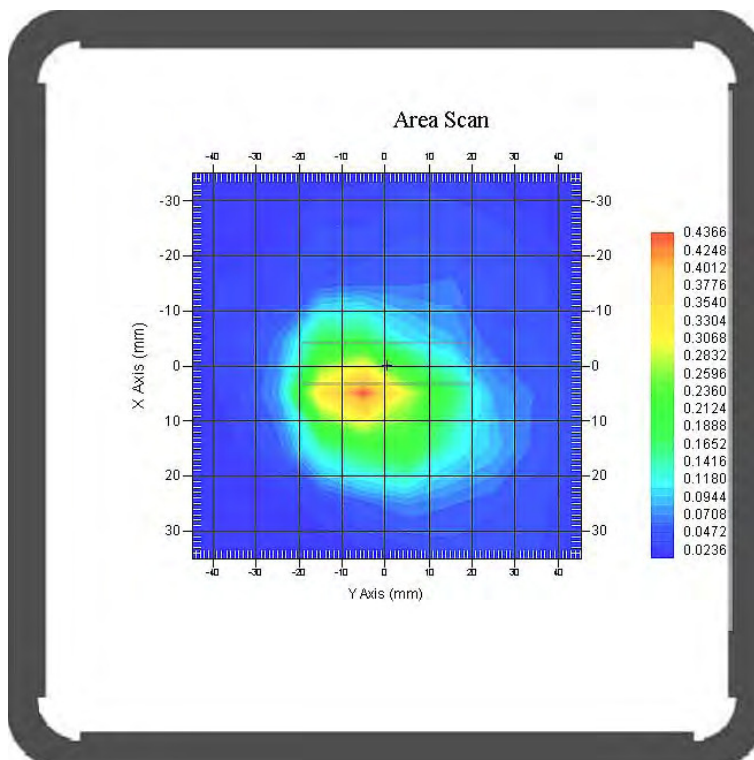



**Test Laboratory: Bay Area Compliance Lab Corp. (Shenzhen)**

**Body-Front (2412 MHz Channel 1) ;802.11b**

Measurement Data

Crest Factor : 1  
 Scan Type : Complete  
 Area Scan : 8x11x1 : Measurement x=10mm, y=10mm, z=4mm  
 Zoom Scan : 7x7x7 : Measurement x=5mm, y=5mm, z=5mm  
 Power Drift-Start : 0.025 W/kg  
 Power Drift-Finish : 0.025 W/kg  
 Power Drift (%) : -1.073

Tissue Data

Type : Body  
 Frequency : 2412.0 MHz  
 Epsilon : 52.77 F/m  
 Sigma : 1.96 S/m  
 Density : 1000.00 kg/cu. m

Probe Data

Serial No. : 500-00283  
 Frequency Band : 2450 MHz  
 Duty Cycle Factor : 1  
 Conversion Factor : 4.3  
 Probe Sensitivity : 1.20 1.20 1.20  $\mu\text{V}/(\text{V}/\text{m})^2$   
 Compression Point : 95.00 mV  
 Offset : 1.56 mm

1 gram SAR value : 0.033 W/kg  
 10 gram SAR value : 0.014 W/kg  
 Area Scan Peak SAR : 0.036 W/kg  
 Zoom Scan Peak SAR : 0.070 W/kg

**Plot 36#**

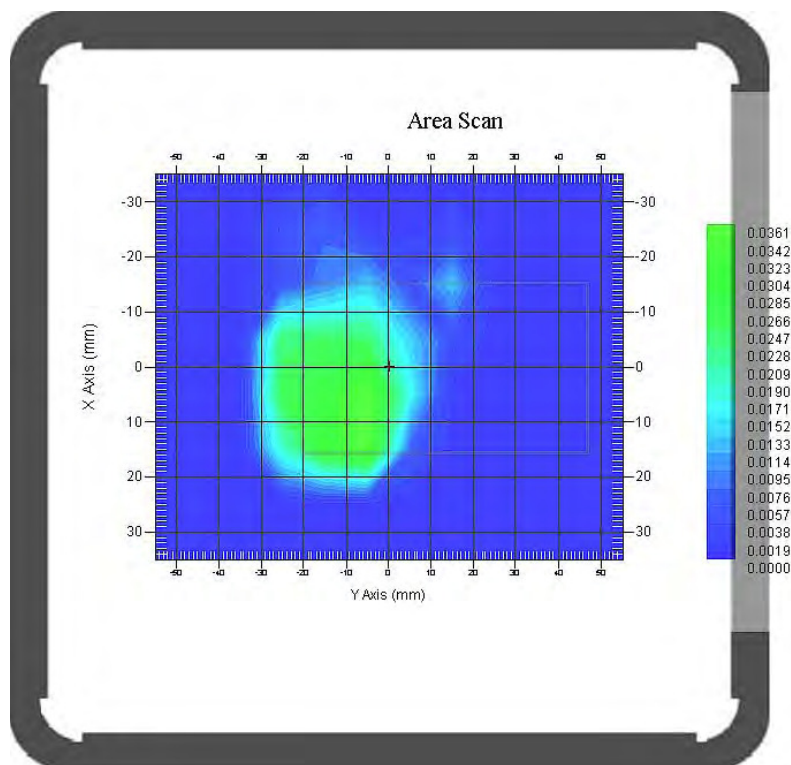

**Test Laboratory: Bay Area Compliance Lab Corp. (Shenzhen)**

**802.11b; Body-Back (2412 MHz Channel 1) ;802.11b**

Measurement Data

Crest Factor : 1  
 Scan Type : Complete  
 Area Scan : 8x11x1 : Measurement x=10mm, y=10mm, z=4mm  
 Zoom Scan : 7x7x7 : Measurement x=5mm, y=5mm, z=5mm  
 Power Drift-Start : 0.065 W/kg  
 Power Drift-Finish : 0.063 W/kg  
 Power Drift (%) : -2.958

Tissue Data

Type : Body  
 Frequency : 2412.0 MHz  
 Epsilon : 52.77 F/m  
 Sigma : 1.96 S/m  
 Density : 1000.00 kg/cu. m

Probe Data

Serial No. : 500-00283  
 Frequency Band : 2450 MHz  
 Duty Cycle Factor : 1  
 Conversion Factor : 4.3  
 Probe Sensitivity : 1.20 1.20 1.20  $\mu\text{V}/(\text{V}/\text{m})^2$   
 Compression Point : 95.00 mV  
 Offset : 1.56 mm

1 gram SAR value : 0.079 W/kg  
 10 gram SAR value : 0.043 W/kg  
 Area Scan Peak SAR : 0.087 W/kg  
 Zoom Scan Peak SAR : 0.150 W/kg

**Plot 37#**

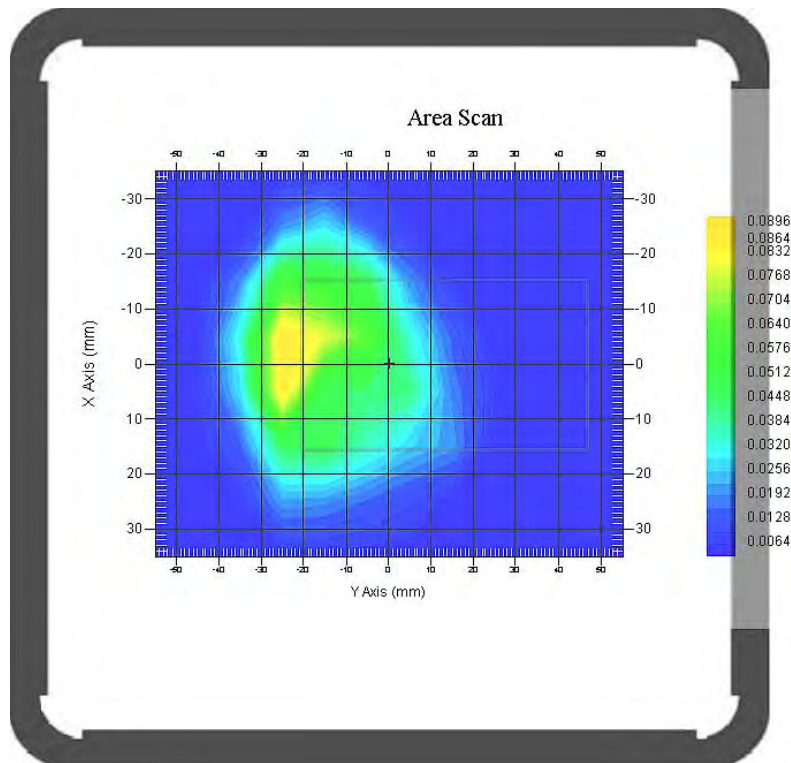

**Test Laboratory: Bay Area Compliance Lab Corp. (Shenzhen)**

**802.11b; Body-Left (2412 MHz Channel 1) ;802.11b**

Measurement Data

Crest Factor : 1  
 Scan Type : Complete  
 Area Scan : 8x11x1 : Measurement x=10mm, y=10mm, z=4mm  
 Zoom Scan : 7x7x7 : Measurement x=5mm, y=5mm, z=5mm  
 Power Drift-Start : 0.002 W/kg  
 Power Drift-Finish : 0.002 W/kg  
 Power Drift (%) : -1.817

Tissue Data

Type : Body  
 Frequency : 2412.0 MHz  
 Epsilon : 52.77 F/m  
 Sigma : 1.96 S/m  
 Density : 1000.00 kg/cu. m

Probe Data

Serial No. : 500-00283  
 Frequency Band : 2450 MHz  
 Duty Cycle Factor : 1  
 Conversion Factor : 4.3  
 Probe Sensitivity : 1.20 1.20 1.20  $\mu\text{V}/(\text{V}/\text{m})^2$   
 Compression Point : 95.00 mV  
 Offset : 1.56 mm

1 gram SAR value : 0.011 W/kg  
 10 gram SAR value : 0.004 W/kg  
 Area Scan Peak SAR : 0.018 W/kg  
 Zoom Scan Peak SAR : 0.030 W/kg

**Plot 38#**

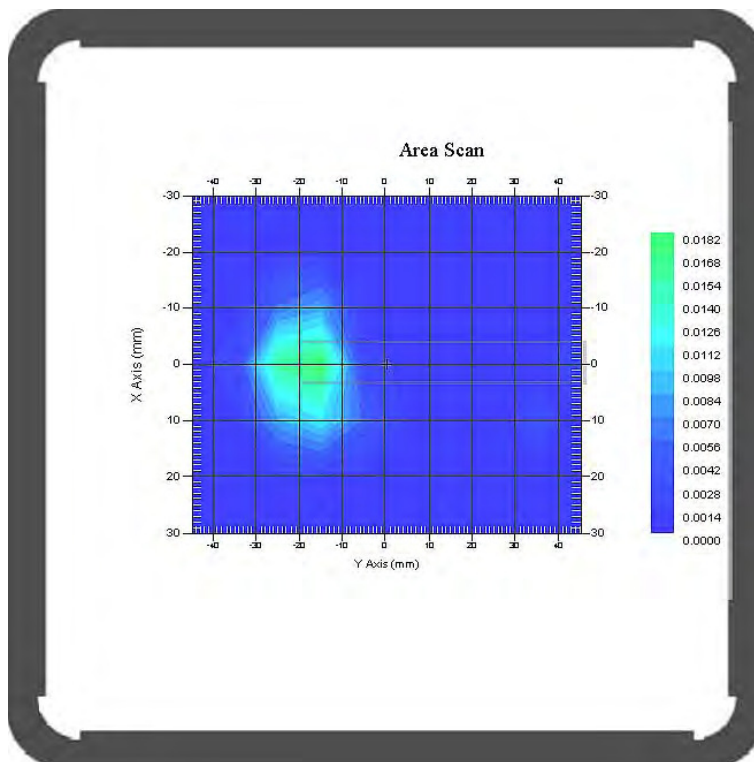

**Test Laboratory: Bay Area Compliance Lab Corp. (Shenzhen)**

**802.11b; Body-Left (2412 MHz Channel 1) ;802.11b**

Measurement Data

Crest Factor : 1  
 Scan Type : Complete  
 Area Scan : 8x11x1 : Measurement x=10mm, y=10mm, z=4mm  
 Zoom Scan : 7x7x7 : Measurement x=5mm, y=5mm, z=5mm  
 Power Drift-Start : 0.001 W/kg  
 Power Drift-Finish : 0.001 W/kg  
 Power Drift (%) : 2.418

Tissue Data

Type : Body  
 Frequency : 2412.0 MHz  
 Epsilon : 52.77 F/m  
 Sigma : 1.96 S/m  
 Density : 1000.00 kg/cu. m

Probe Data

Serial No. : 500-00283  
 Frequency Band : 2450 MHz  
 Duty Cycle Factor : 1  
 Conversion Factor : 4.3  
 Probe Sensitivity : 1.20 1.20 1.20  $\mu\text{V}/(\text{V}/\text{m})^2$   
 Compression Point : 95.00 mV  
 Offset : 1.56 mm

1 gram SAR value : 0.012 W/kg  
 10 gram SAR value : 0.005 W/kg  
 Area Scan Peak SAR : 0.016 W/kg  
 Zoom Scan Peak SAR : 0.030 W/kg

**Plot 39#**

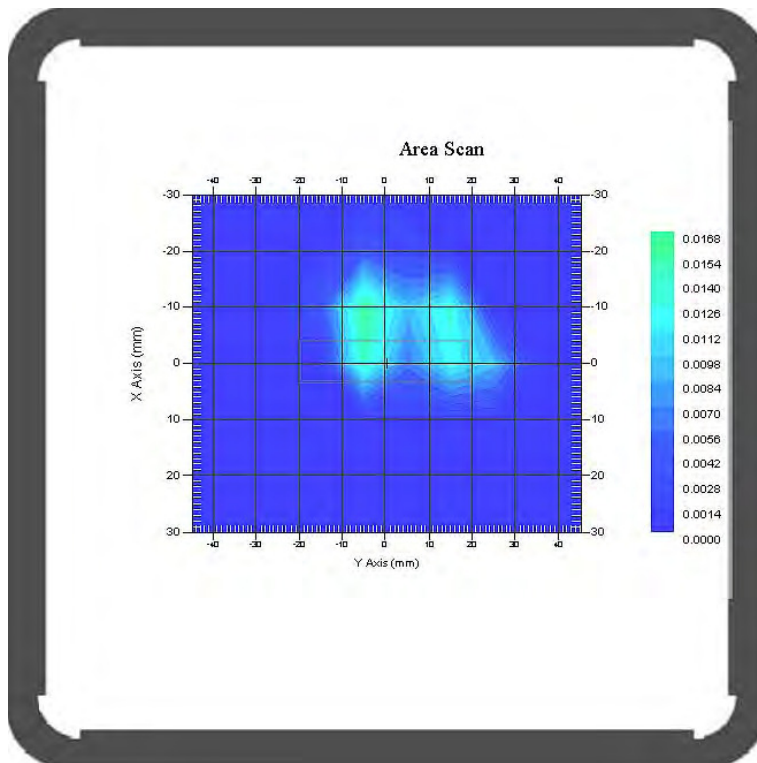

## APPENDIX A MEASUREMENT UNCERTAINTY

The uncertainty budget has been determined for the measurement system and is given in the following Table.

**Measurement Uncertainty for 300MHz to 3GHz**

Source of Uncertainty	Tolerance Value	Probability Distribution	Divisor	$c_i^1$ (1-g)	$c_i^1$ (10-g)	Standard Uncertainty (1-g) %	Standard Uncertainty (10-g) %
<b>Measurement System</b>							
Probe Calibration	3.5	normal	1	1	1	3.5	3.5
Axial Isotropy	3.7	rectangular	$\sqrt{3}$	$(1-cp)^{1/2}$	$(1-cp)^{1/2}$	1.5	1.5
Hemispherical Isotropy	10.9	rectangular	$\sqrt{3}$	$\sqrt{cp}$	$\sqrt{cp}$	4.4	4.4
Boundary Effect	1.0	rectangular	$\sqrt{3}$	1	1	0.6	0.6
Linearity	4.7	rectangular	$\sqrt{3}$	1	1	2.7	2.7
Detection Limit	1.0	rectangular	$\sqrt{3}$	1	1	0.6	0.6
Readout Electronics	1.0	normal	1	1	1	1.0	1.0
Response Time	0.8	rectangular	$\sqrt{3}$	1	1	0.5	0.5
Integration Time	1.7	rectangular	$\sqrt{3}$	1	1	1.0	1.0
RF Ambient Condition -Noise	0.006	rectangular	$\sqrt{3}$	1	1	0.003	0.003
RF Ambient Condition - Reflections	3.0	rectangular	$\sqrt{3}$	1	1	1.7	1.7
Probe Positioner Mech. Restrictions	0.4	rectangular	$\sqrt{3}$	1	1	0.2	0.2
<b>Restriction</b>							
Probe Positioning with respect to Phantom Shell	2.9	rectangular	$\sqrt{3}$	1	1	1.7	1.7
Extrapolation and Integration	3.7	rectangular	$\sqrt{3}$	1	1	2.1	2.1
Test Sample Positioning	0.023	normal	1	1	1	0.023	0.023
Device Holder Uncertainty	6.215	normal	1	1	1	6.215	6.215
Drift of Output Power	4.627	rectangular	$\sqrt{3}$	1	1	2.67	2.67
<b>Phantom and Setup</b>							
Phantom Uncertainty(shape & thickness tolerance)	3.4	rectangular	$\sqrt{3}$	1	1	2.0	2.0
Liquid Conductivity(target)	5.0	rectangular	$\sqrt{3}$	0.7	0.5	2.0	1.4
Liquid Conductivity(meas.)	1.938	normal	1	0.7	0.5	1.36	0.97
Liquid Permittivity(target)	5.0	rectangular	$\sqrt{3}$	0.6	0.5	1.7	1.4
Liquid Permittivity(meas.)	3.093	normal	1	0.6	0.5	1.86	1.55
Combined Uncertainty		RSS				10.78	10.55
Expanded uncertainty (coverage factor=2)		Normal(k=2)				21.56	21.10

## APPENDIX B – PROBE CALIBRATION CERTIFICATES

### NCL CALIBRATION LABORATORIES

Calibration File No.: PC-1537

Task No: BACL-5745

## CERTIFICATE OF CALIBRATION

It is certified that the equipment identified below has been calibrated in the **NCL CALIBRATION LABORATORIES** by qualified personnel following recognized procedures and using transfer standards traceable to NRC/NIST.

Equipment: Miniature Isotropic RF Probe

Record of Calibration

Head and Body

Manufacturer: APREL Laboratories

Model No.: E-020

Serial No.: 500-00283

Calibration Procedure: D01-032-E020-V2, D22-012-Tissue, D28-002-Dipole  
Project No: BACL-5745

Calibrated: 8<sup>th</sup> October 2013

Released on: 8<sup>th</sup> October 2013

This Calibration Certificate is Incomplete Unless Accompanied with the Calibration Results Summary

Released By: \_\_\_\_\_



Art Brennan, Quality Manager

### **NCL** CALIBRATION LABORATORIES

Suite 102, 303 Terry Fox Dr,  
OTTAWA, ONTARIO  
CANADA K2K 3J1

Division of APREL Lab.  
TEL: (613) 435-8300  
FAX: (613) 435-8306

**NCL Calibration Laboratories**

Division of APREL Inc.

**Introduction**

This Calibration Report reproduces the results of the calibration performed in line with the references listed below. Calibration is performed using accepted methodologies as per the references listed below. Probes are calibrated for air, and tissue and the values reported are the results from the physical quantification of the probe through meteorological practices.

**Calibration Method**

Probes are calibrated using the following methods.

&lt;1000MHz

TEM Cell for sensitivity in air

Standard phantom using temperature transfer method for sensitivity in tissue

&gt;1000MHz

Waveguide\* method to determine sensitivity in air and tissue

\*Waveguide is numerically (simulation) assessed to determine the field distribution and power

The boundary effect for the probe is assessed using a standard flat phantom where the probe output is compared against a numerically simulated series of data points

**References**

- IEEE Standard 1528  
IEEE Recommended Practice for Determining the Peak Spatial-Average Specific Absorption Rate (SAR) in the Human Head from Wireless Communications Devices: Measurement Techniques
- EN 62209-1  
Human Exposure to RF Fields from hand-held and body-mounted wireless communication devices - Human models, instrumentation, and procedures-Part 1: Procedure to measure the Specific Absorption Rate (SAR) for hand-held mobile wireless devices
- IEC 62209-2  
Human exposure to RF fields from hand-held and body-mounted wireless devices - Human models, instrumentation, and procedures - Part 2: specific absorption rate (SAR) for wireless communication devices (30 MHz - 6 GHz)
- TP-D01-032-E020-V2 E-Field probe calibration procedure
- D22-012-Tissue dielectric tissue calibration procedure
- D28-002-Dipole procedure for validation of SAR system using a dipole
- IEEE 1309 Standard for Calibration of Electromagnetic Field Sensors and Probes, Excluding Antennas, from 9kHz to 40GHz

---

Page 2 of 10

This page has been reviewed for content and attested to on Page 2 of this document.

**NCL Calibration Laboratories**

Division of APREL Inc.

**Conditions**

Probe 500-00283 was a recalibration.

**Ambient Temperature of the Laboratory:** 22 °C +/- 1.5°C  
**Temperature of the Tissue:** 21 °C +/- 1.5°C  
**Relative Humidity:** < 60%

**Primary Measurement Standards**

<b>Instrument</b>	<b>Serial Number</b>	<b>Cal due date</b>
Tektronix USB Power Meter	11C940	May 14, 2015
Signal Generator HP 83640B	3844A00689	Feb 12, 2015

**Secondary Measurement Standards**

Network Analyzer Anritsu 37347C	002106	Feb. 20, 2015
---------------------------------	--------	---------------

**Attestation**

The below named signatories have conducted the calibration and review of the data which is presented in this calibration report.

**We the undersigned attest that to the best of our knowledge the calibration of this subject has been accurately conducted and that all information contained within the results pages have been reviewed for accuracy.**

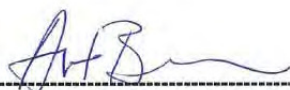

Art Brennan, Quality Manager



Dan Brooks, Test Engineer

Page 3 of 10

This page has been reviewed for content and attested to on Page 2 of this document.



**NCL Calibration Laboratories**

Division of APREL Inc.

**Probe Summary**

<b>Probe Type:</b>	E-Field Probe E020
<b>Serial Number:</b>	500-00283
<b>Frequency:</b>	As presented on page 5
<b>Sensor Offset:</b>	1.56
<b>Sensor Length:</b>	2.5
<b>Tip Enclosure:</b>	Composite*
<b>Tip Diameter:</b>	< 2.9 mm
<b>Tip Length:</b>	55 mm
<b>Total Length:</b>	289 mm

\*Resistive to recommended tissue recipes per IEEE-1528

**Sensitivity in Air**

<b>Channel X:</b>	1.2 $\mu\text{V}/(\text{V}/\text{m})^2$
<b>Channel Y:</b>	1.2 $\mu\text{V}/(\text{V}/\text{m})^2$
<b>Channel Z:</b>	1.2 $\mu\text{V}/(\text{V}/\text{m})^2$
<b>Diode Compression Point:</b>	95 mV

**NCL Calibration Laboratories**

Division of APREL Inc.

Calibration for Tissue (Head H, Body B)

Frequency	Tissue Type	Measured Epsilon	Measured Sigma	Standard Uncertainty (%)	Calibration Frequency Range (MHz)	Conversion Factor
450 H	Head	44.29	0.86	3.5	±50	5.7
450 B	Body	56.6	0.94	3.5	±50	5.8
750 H	Head	42.7	0.85	3.5	±50	5.6
750 B	Body	56.6	0.94	3.5	±50	5.5
835 H	Head	42.35	0.938	3.5	±50	5.9
835 B	Body	56.65	1.018	3.5	±50	5.9
900 H	Head	X	X	X	X	X
900 B	Body	X	X	X	X	X
1450 H	Head	X	X	X	X	X
1450 B	Body	X	X	X	X	X
1500 H	Head	X	X	X	X	X
1500 B	Body	X	X	X	X	X
1640 H	Head	X	X	X	X	X
1640 B	Body	X	X	X	X	X
1750 H	Head	38.51	1.36	3.5	±75	5.4
1750 B	Body	51.79	1.53	3.5	±75	5.3
1800 H	Head	38.26	1.41	3.5	±75	5.0
1800 B	Body	51.61	1.58	3.5	±75	5.0
1900 H	Head	38.03	1.36	3.5	±75	4.8
1900 B	Body	53.13	1.58	3.5	±75	4.5
2000 H	Head	X	X	X	X	X
2000 B	Body	X	X	X	X	X
2100 H	Head	X	X	X	X	X
2100 B	Body	X	X	X	X	X
2300 H	Head	X	X	X	X	X
2300 B	Body	X	X	X	X	X
2450 H	Head	37.64	1.88	3.5	±75	4.9
2450 B	Body	50.7	2.03	3.5	±75	4.3
2600 H	Head	X	X	X	X	X
2600 B	Body	X	X	X	X	X
3000 H	Head	X	X	X	X	X
3000 B	Body	X	X	X	X	X
3600 H	Head	X	X	X	X	X
3600 B	Body	X	X	X	X	X
5250 H	Head	34.65	4.8	3.5	±100	2.7
5250 B	Body	47.6	5.3	3.5	±100	2.6
5600 H	Head	33.2	5.15	3.5	±100	2.5
5600 B	Body	45.21	5.57	3.5	±100	2.2
5800 H	Head	32.72	5.38	3.5	±100	3.2
5800 B	Body	44.28	6.04	3.5	±100	2.5

Page 5 of 10

This page has been reviewed for content and attested to on Page 2 of this document.

**NCL Calibration Laboratories**

---

Division of APREL Inc.

**Boundary Effect:**

Uncertainty resulting from the boundary effect is less than 2.1% for the distance between the tip of the probe and the tissue boundary, when less than 0.58mm.

**Spatial Resolution:**

The spatial resolution uncertainty is less than 1.5% for 4.9mm diameter probe.  
The spatial resolution uncertainty is less than 1.0% for 2.5mm diameter probe.

**DAQ-PAQ Contribution**

To minimize the uncertainty calculation all tissue sensitivity values were calculated using a load impedance of 5 MΩ.

---

Page 6 of 10

This page has been reviewed for content and attested to on Page 2 of this document.

**NCL Calibration Laboratories**

Division of APREL Inc.

**Receiving Pattern Air**

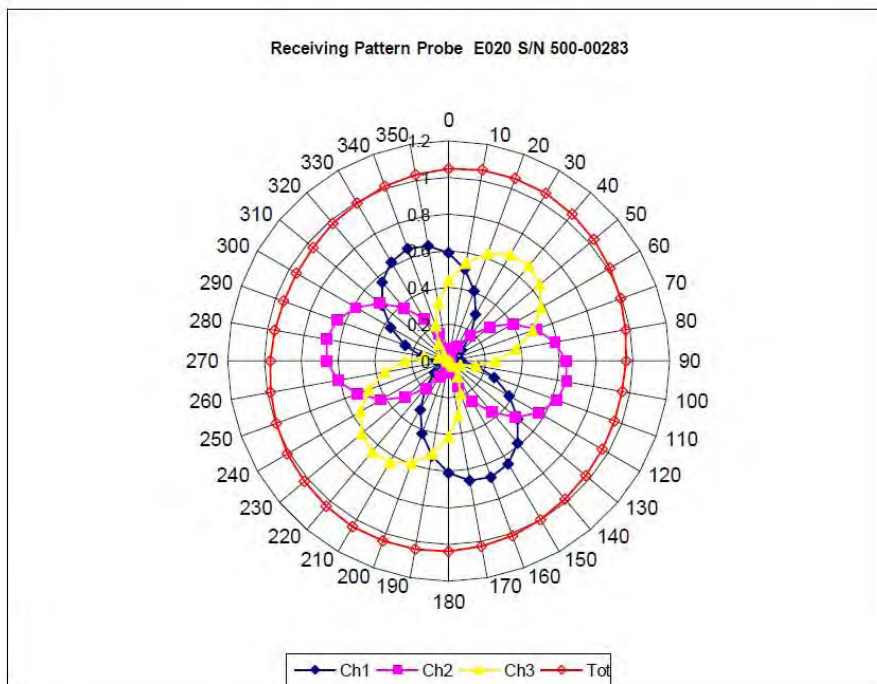

Page 7 of 10

This page has been reviewed for content and attested to on Page 2 of this document.

**NCL Calibration Laboratories**

Division of APREL Inc.

**Isotropy Error Air**

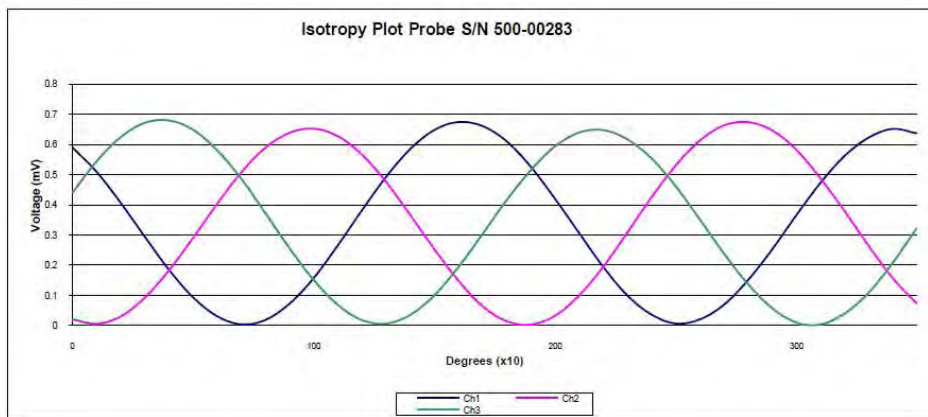
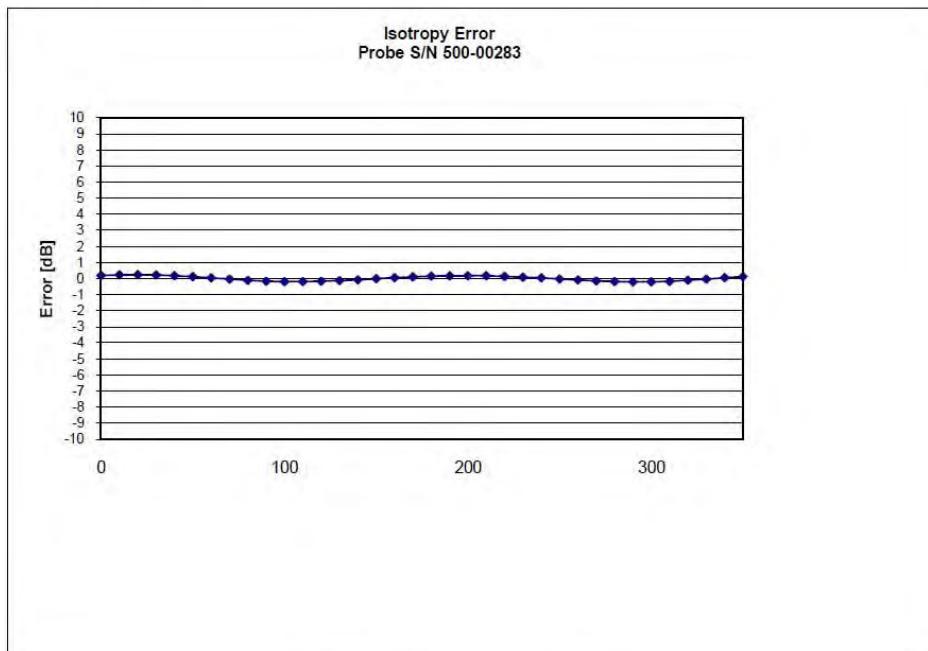

**Isotropicity Tissue:** 0.10 dB

**NCL Calibration Laboratories**

Division of APREL Inc.

**Dynamic Range**

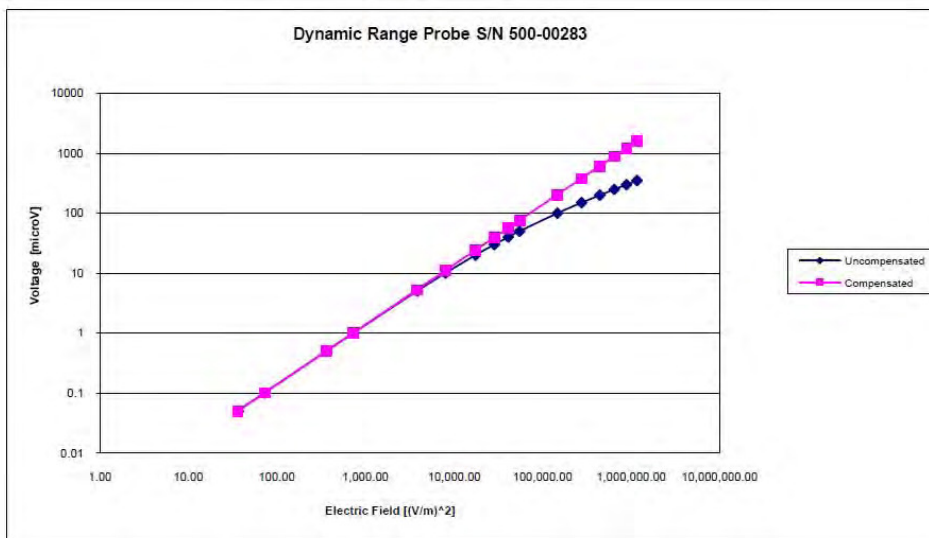

**NCL Calibration Laboratories**

Division of APREL Inc.

**Video Bandwidth**

Probe Frequency Characteristics

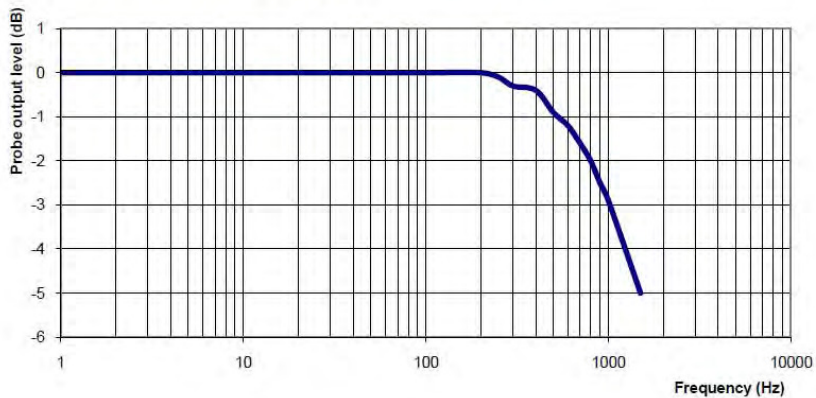

Video Bandwidth at 500 Hz                    1 dB  
Video Bandwidth at 1.02 KHz:                3 dB

**Test Equipment**

The test equipment used during Probe Calibration, manufacturer, model number and, current calibration status are listed and located on the main APREL server R:\NCL\Calibration Equipment\Instrument List May 2013.

---

Page 10 of 10  
This page has been reviewed for content and attested to on Page 2 of this document.

## APPENDIX C DIPOLE CALIBRATION CERTIFICATES

---

### NCL CALIBRATION LABORATORIES

Calibration File No: DC-1532  
Project Number: BACL-5745

## CERTIFICATE OF CALIBRATION

It is certified that the equipment identified below has been calibrated in the  
**NCL CALIBRATION LABORATORIES** by qualified personnel following recognized  
procedures and using transfer standards traceable to NRC/NIST.

Validation Dipole

Manufacturer: APREL Laboratories

Part number: ALS-D-750-S-2

Frequency: 750 MHz

Serial No: 177-00505

Customer: BACL

Calibrated: 8<sup>th</sup> of October 2013  
Released on: 8<sup>th</sup> of October 2013

This Calibration Certificate is Incomplete Unless Accompanied with the Calibration Results Summary

Released By: \_\_\_\_\_

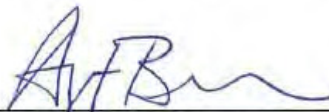

Art Brennan, Quality Manager

### **NCL** CALIBRATION LABORATORIES

303 Terry Fox Drive, Suite 102  
Kanata, Ontario  
CANADA K2K 3J1

Division of APREL  
TEL: (613) 435-8300  
FAX: (613) 435-8306



**NCL Calibration Laboratories**

Division of APREL Laboratories.

**Conditions**

Dipole 177-00505 was a new calibration, removed from stock.

**Ambient Temperature of the Laboratory:** 22 °C +/- 0.5°C

**Temperature of the Tissue:** 21 °C +/- 0.5°C

**We the undersigned attest that to the best of our knowledge the calibration of this device has been accurately conducted and that all information contained within this report has been reviewed for accuracy.**

**We the undersigned attest that to the best of our knowledge the calibration of this subject has been accurately conducted and that all information contained within the results pages have been reviewed for accuracy.**



Art Brennan, Quality Manager



Dan Brooks, Test Engineer

This page has been reviewed for content and attested to by signature within this document.

**NCL Calibration Laboratories**

Division of APREL Laboratories.

**Calibration Results Summary**

The following results relate the Calibrated Dipole and should be used as a quick reference for the user.

**Mechanical Dimensions**

Length: 180.2 mm  
 Height: 97.0 mm

**Electrical Calibration**

Test	Result Head	Result Body
S11 R/L	-27.621 dB	-21.672 dB
SWR	1.106 U	1.201 U
Impedance	52.505 Ω	55.933 Ω

**System Validation Results**

Frequency	1 Gram	10 Gram
750 MHz		
Head	8.5	54.0
Body	8.54	5.42

**Head**

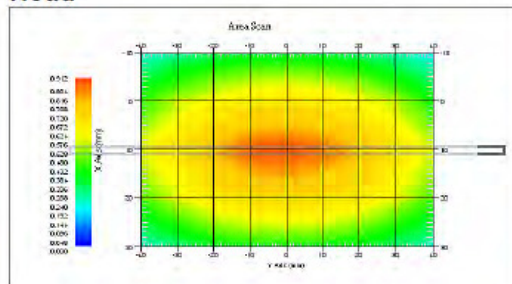

**Body**

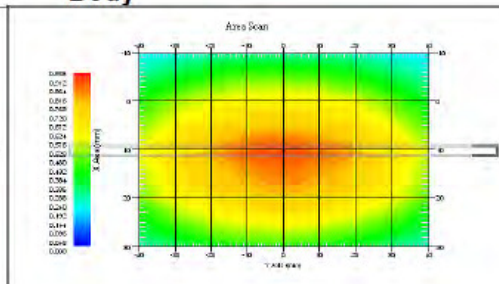

This page has been reviewed for content and attested to by signature within this document.

## **NCL Calibration Laboratories**

Division of APREL Laboratories.

### **Introduction**

This Calibration Report has been produced in line with the SSI Dipole Calibration Procedure SSI-TP-018-ALSAS. The results contained within this report are for Validation Dipole 177-00505. The calibration routine consisted of a three-step process. Step 1 was a mechanical verification of the dipole to ensure that it meets the mechanical specifications. Step 2 was an Electrical Calibration for the Validation Dipole, where the SWR, Impedance, and the Return loss were assessed. Step 3 involved a System Validation using the ALSAS-10U, along with APREL E-020 130 MHz to 26 GHz E-Field Probe Serial Number 2225.

### **References**

- SSI-TP-018-ALSAS Dipole Calibration Procedure
- SSI-TP-016 Tissue Calibration Procedure
- IEEE 1528 "Recommended Practice for Determining the Peak Spatial-Average Specific Absorption Rate (SAR) in the Human Body Due to Wireless Communications Devices: Experimental Techniques"
- IEC-62209 "Human exposure to radio frequency fields from hand-held and body-mounted wireless communication devices – Human models, instrumentation, and procedures"
- Part 1: "Procedure to determine the Specific Absorption Rate (SAR) for hand-held devices used in close proximity of the ear (frequency range of 300 MHz to 3 GHz)"
- IEC-62209 "Human exposure to radio frequency fields from hand-held and body-mounted wireless communication devices – Human models, instrumentation, and procedures"
- Part 2: "Procedure to determine the Specific Absorption Rate (SAR) for hand-held devices used in close proximity of the ear (frequency range of 30 MHz to 6 GHz)"
- TP-D01-032-E020-V2 E-Field probe calibration procedure
- D22-012-Tissue dielectric tissue calibration procedure
- D28-002-Dipole procedure for validation of SAR system using a dipole
- IEEE 1309 Draft Standard for Calibration of Electromagnetic Field Sensors and Probes, Excluding Antennas, from 9kHz to 40GHz

### **Conditions**

Dipole 177-00505 was a new calibration.

**Ambient Temperature of the Laboratory:** 22 °C +/- 0.5°C

**Temperature of the Tissue:** 20 °C +/- 0.5°C

This page has been reviewed for content and attested to by signature within this document.

4

**NCL Calibration Laboratories**

Division of APREL Laboratories.

**Dipole Calibration Results**

**Mechanical Verification**

APREL Length	APREL Height	Measured Length	Measured Height
180.0 mm	97.8 mm	180.2 mm	97.0 mm

**Tissue Validation**

Tissue 750MHz	Measured Head	Measured Body
Dielectric constant, $\epsilon_r$	42.7	56.6
Conductivity, $\sigma$ [S/m]	0.85	0.94

**Dipole Calibration uncertainty**

The calibration uncertainty for the dipole is made up of various parameters presented below.

<b>Mechanical</b>	1%
<b>Positioning Error</b>	1.22%
<b>Electrical</b>	1.7%
<b>Tissue</b>	2.2%
<b>Dipole Validation</b>	2.2%
<b>TOTAL</b>	<b>8.32% (16.64% K=2)</b>

This page has been reviewed for content and attested to by signature within this document.

**NCL Calibration Laboratories**

Division of APREL Laboratories.

**Electrical Calibration**

Test	Result Head	Result Body
S11 R/L	-27.621 dB	-21.672 dB
SWR	1.106 U	1.201 U
Impedance	52.505 $\Omega$	55.933 $\Omega$

The Following Graphs are the results as displayed on the Vector Network Analyzer.

**S11 Parameter Return Loss**

**HEAD**

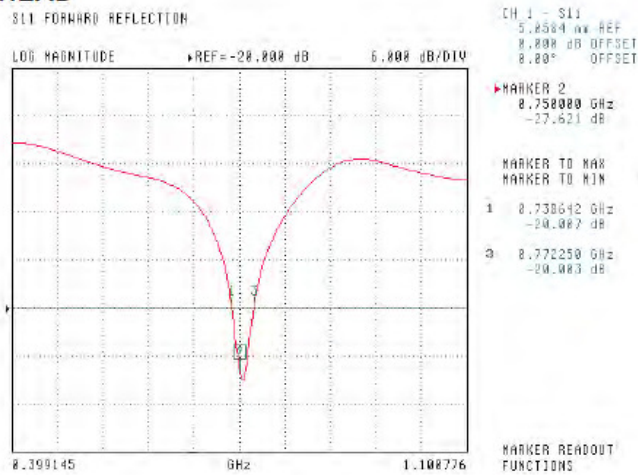

Frequency Range 738 MHz to 772 MHz

**BODY**



Frequency Range 740 MHz to 784 MHz

This page has been reviewed for content and attested to by signature within this document.

### NCL Calibration Laboratories

Division of APREL Laboratories.

## SWR

### Head

S11 FORWARD REFLECTION

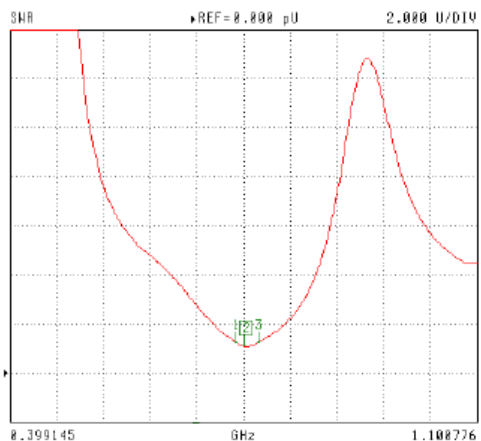

CH 1 - S11  
5.8584 nV REF  
0.000 dB OFFSET  
0.00° OFFSET

MARKER 2  
0.750000 GHz  
1.105 U

MARKER TO MAX  
MARKER TO MIN

- 1 0.730642 GHz  
1.255 U
- 3 0.772250 GHz  
1.248 U

MARKER READOUT  
FUNCTIONS

### Body

S11 FORWARD REFLECTION

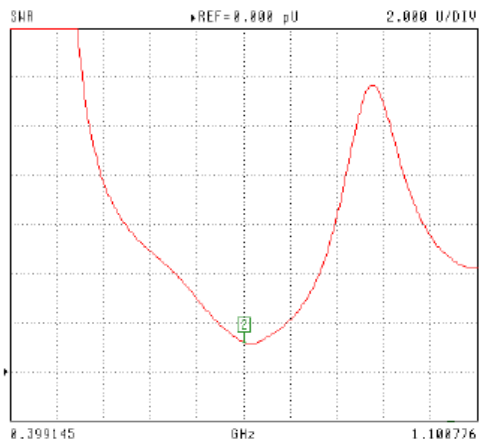

CH 1 - S11  
5.8584 nV REF  
0.000 dB OFFSET  
0.00° OFFSET

MARKER 2  
0.750000 GHz  
1.281 U

MARKER TO MAX  
MARKER TO MIN

MARKER READOUT  
FUNCTIONS

This page has been reviewed for content and attested to by signature within this document.

**NCL Calibration Laboratories**

Division of APREL Laboratories.

**Smith Chart Dipole Impedance**

**Head**

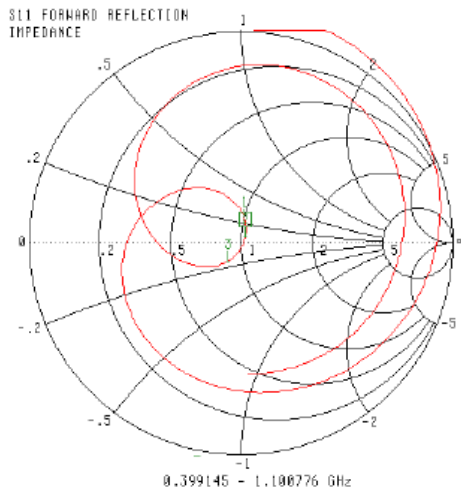

CH 1 - S11  
 5.8584  $\omega$  REF  
 0.000 dB OFFSET  
 0.00° OFFSET

▶ MARKER 2  
 0.750000 GHz  
 52.585  $\Omega$   
 2.731 j $\Omega$

MARKER TO MAX  
 MARKER TO MIN

1 0.730642 GHz  
 50.918  $\Omega$   
 11.112 j $\Omega$

3 0.772250 GHz  
 43.762  $\Omega$   
 -0.112 j $\Omega$

MARKER READOUT FUNCTIONS

**Body**

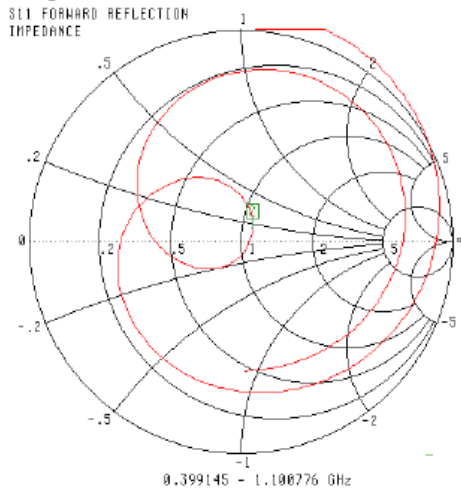

CH 1 - S11  
 5.8584  $\omega$  REF  
 0.000 dB OFFSET  
 0.00° OFFSET

▶ MARKER 2  
 0.750000 GHz  
 55.933  $\Omega$   
 6.574 j $\Omega$

MARKER TO MAX  
 MARKER TO MIN

MARKER READOUT FUNCTIONS

This page has been reviewed for content and attested to by signature within this document.

**NCL Calibration Laboratories**

---

Division of APREL Laboratories.

**Test Equipment**

The test equipment used during Probe Calibration, manufacturer, model number and, current calibration status are listed and located on the main APREL server R:\NCL\Calibration Equipment\Instrument List May 2013.

This page has been reviewed for content and attested to by signature within this document.

9



**NCL CALIBRATION LABORATORIES**

Calibration File No: DC-1327  
Project Number: BAC-dipole-cal-5618

**CERTIFICATE OF CALIBRATION**

It is certified that the equipment identified below has been calibrated in the  
**NCL CALIBRATION LABORATORIES** by qualified personnel following recognized  
procedures and using transfer standards traceable to NRC/NIST.

Validation Dipole(Head and Body)

Manufacturer: APREL Laboratories

Part number: ALS-D-835-S-2

Frequency: 835 MHz

Serial No: 180-00558

Customer: Bay Area Compliance Laboratory

Calibrated: 25<sup>th</sup> August 2011  
Released on: 25<sup>th</sup> August 2011

This Calibration Certificate is Incomplete Unless Accompanied with the Calibration Results Summary

Released By: \_\_\_\_\_

**NCL CALIBRATION LABORATORIES**

Suite 102, 303 Terry Fox Dr.  
Kanata, ONTARIO  
CANADA K2K 3J1

Division of APREL Lab.  
TEL: (613) 435-8300  
FAX: (613)435-8306

**NCL Calibration Laboratories**

Division of APREL Laboratories.

**Conditions**

Dipole 180-00558 was received in good condition and a re-calibration.

**Ambient Temperature of the Laboratory:** 22 °C +/- 0.5°C

**Temperature of the Tissue:** 21 °C +/- 0.5°C

We the undersigned attest that to the best of our knowledge the calibration of this device has been accurately conducted and that all information contained within this report has been reviewed for accuracy.



-----  
**Stuart Nicol**



-----  
**C. Teodorian**

<b>Primary Measurement Standards Instrument</b>	<b>Serial Number</b>	<b>Cal due date</b>
Power meter Anritsu MA2408A	245025437	Nov.4, 2011
Power Sensor Anritsu MA2481D	103555	Nov 4, 2011
Attenuator HP 8495A (70dB) 1	944A10711	Aug.8, 2012
Network Analyzer Agilent E5071C	1334746J	Feb. 8, 2012
<b>Secondary Measurement Standards</b>		
Signal Generator Agilent E4438C	-506 MY55182336	June 7, 2012

This page has been reviewed for content and attested to by signature within this document.

**NCL Calibration Laboratories**

Division of APREL Laboratories.

**Calibration Results Summary**

The following results relate the Calibrated Dipole and should be used as a quick reference for the user.

**Mechanical Dimensions**

**Length:** 162.2 mm  
**Height:** 89.4 mm

**Electrical Specification**

Tissue	Frequency	SWR:	Return Loss	Impedance
Head	835 MHz	1.0417 U	-35.395dB	49.020 Ω
Body	835 MHz	1.1177 U	-25.424dB	55.435 Ω

**System Validation Results**

Tissue	Frequency	1 Gram	10 Gram	Peak
Head	835 MHz	9.590	6.003	15.013
Body	835 MHz	9.684	6.263	14.23

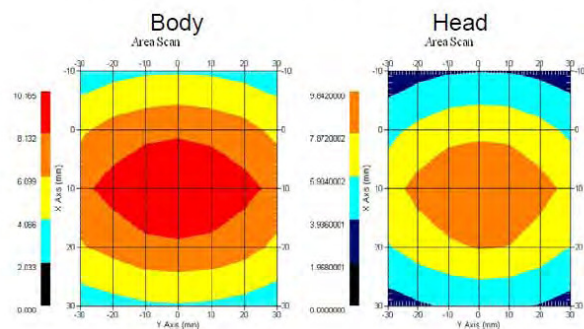

This page has been reviewed for content and attested to by signature within this document.

**NCL Calibration Laboratories**

Division of APREL Laboratories.

**Introduction**

This Calibration Report has been produced in line with the SSI Dipole Calibration Procedure SSI-TP-018-ALSAS. The results contained within this report are for Validation Dipole 180-00558. The calibration routine consisted of a three-step process. Step 1 was a mechanical verification of the dipole to ensure that it meets the mechanical specifications. Step 2 was an Electrical Calibration for the Validation Dipole, where the SWR, Impedance, and the Return loss were assessed. Step 3 involved a System Validation using the ALSAS-10U, along with APREL E-020 130 MHz to 26 GHz E-Field Probe Serial Number 212.

**References**

SSI-TP-018-ALSAS Dipole Calibration Procedure  
 SSI-TP-016 Tissue Calibration Procedure  
 IEEE 1528 "Recommended Practice for Determining the Peak Spatial-Average Specific Absorption Rate (SAR) in the Human Body Due to Wireless Communications Devices: Experimental Techniques"

**Conditions**

Dipole 180-00558 was new taken from stock.

**Ambient Temperature of the Laboratory:** 22 °C +/- 0.5°C  
**Temperature of the Tissue:** 20 °C +/- 0.5°C

**Dipole Calibration uncertainty**

The calibration uncertainty for the dipole is made up of various parameters presented below.

<b>Mechanical</b>	1%
<b>Positioning Error</b>	1.22%
<b>Electrical</b>	1.7%
<b>Tissue</b>	2.2%
<b>Dipole Validation</b>	2.2%
<b>TOTAL</b>	<b>8.32% (16.64% K=2)</b>

This page has been reviewed for content and attested to by signature within this document.

**NCL Calibration Laboratories**

Division of APREL Laboratories.

**Dipole Calibration Results**

**Mechanical Verification**

APREL Length	APREL Height	Measured Length	Measured Height
161.0 mm	89.8 mm	162.2 mm	89.4 mm

Tissue Type	Return Loss:	SWR:	Impedance:
Head	-35.395 dB	1.0417 U	49.020Ω
Body	-25.454 dB	1.1177 U	55.435Ω

**Tissue Validation**

	Dielectric constant, $\epsilon_r$	Conductivity, $\sigma$ [S/m]
<b>Head Tissue 835MHz</b>	41.78	0.92
<b>Body Tissue 835MHz</b>	56.37	0.95

This page has been reviewed for content and attested to by signature within this document.

**NCL Calibration Laboratories**

Division of APREL Laboratories.

The Following Graphs are the results as displayed on the Vector Network Analyzer.

**S11 Parameter Return Loss**

**Head Tissue**

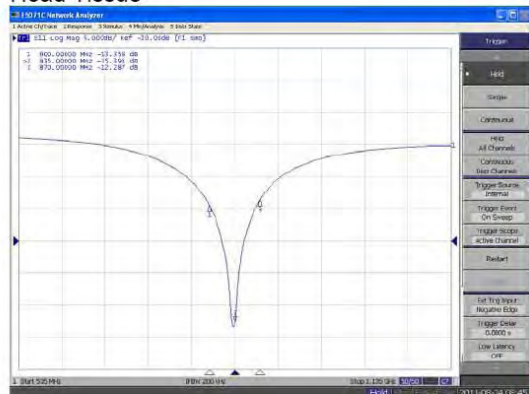

**Body Tissue**

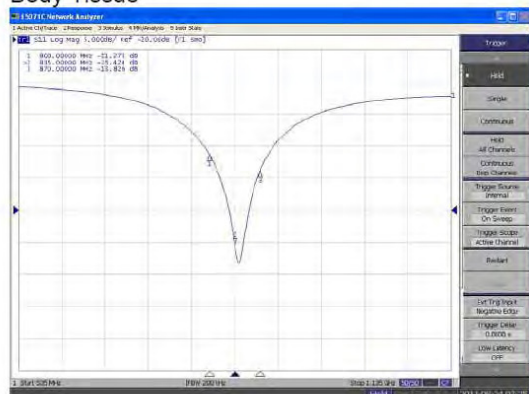

This page has been reviewed for content and attested to by signature within this document.

**NCL Calibration Laboratories**

Division of APREL Laboratories.

**SWR  
Head**

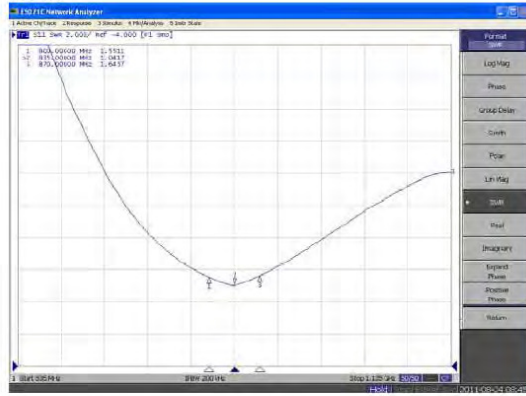

**Body**

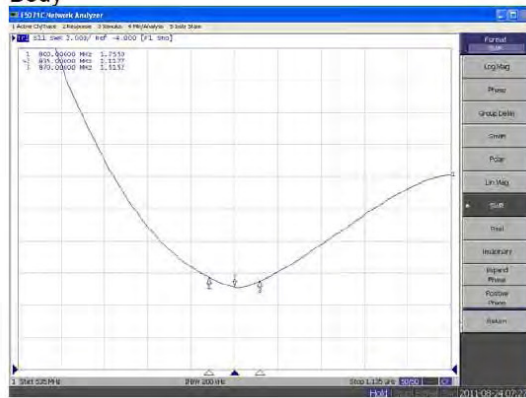

This page has been reviewed for content and attested to by signature within this document.

**NCL Calibration Laboratories**

Division of APREL Laboratories.

**Smith Chart Dipole Impedance**

**Head**

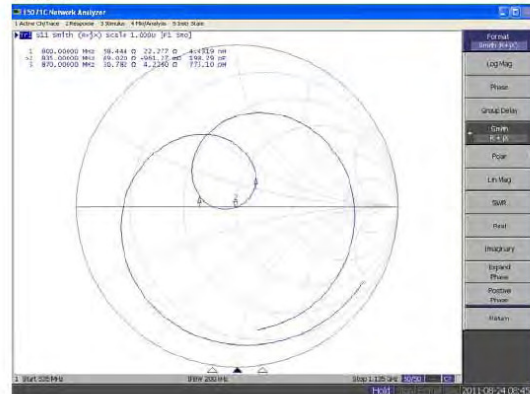

**Body**

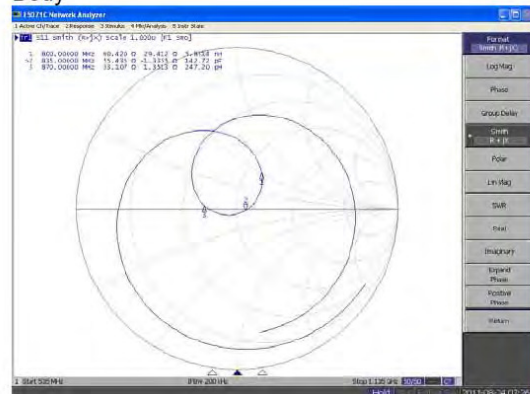

This page has been reviewed for content and attested to by signature within this document.



**NCL Calibration Laboratories**

Division of APREL Laboratories.

**Test Equipment**

The test equipment used during Probe Calibration, manufacturer, model number and, current calibration status are listed and located on the main APREL server R:\NCL\Calibration Equipment\Instrument List 2011.

This page has been reviewed for content and attested to by signature within this document.

9

**Mechanical Verification**

APREL Length	APREL Height	Measured Length	Measured Height
161.0 mm	89.8 mm	161.1 mm	89.7 mm

Tissue Type	Measured Return Loss	Measured Impedance
Head	-33.135 dB	51.898 Ω
Body	-25.362 dB	50.604 Ω

**Test Graphs:**

Head Tissue

Return Loss :

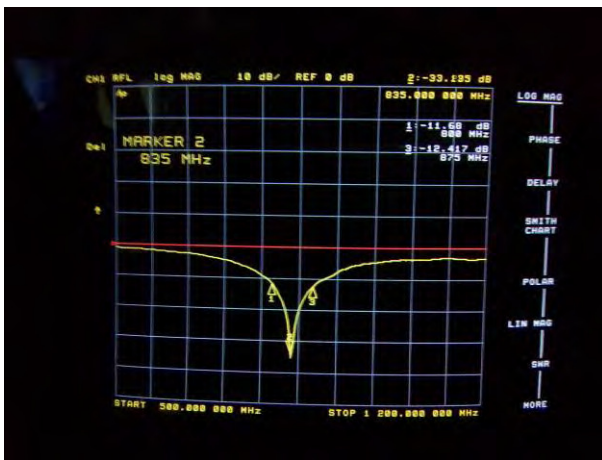

Impedance :



Body Tissue

Return Loss :

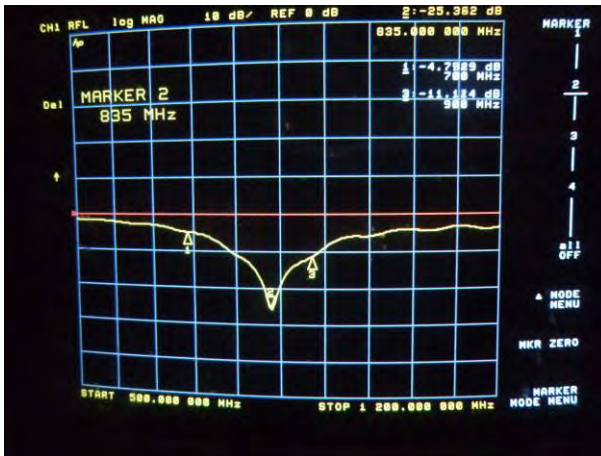

Impedance :

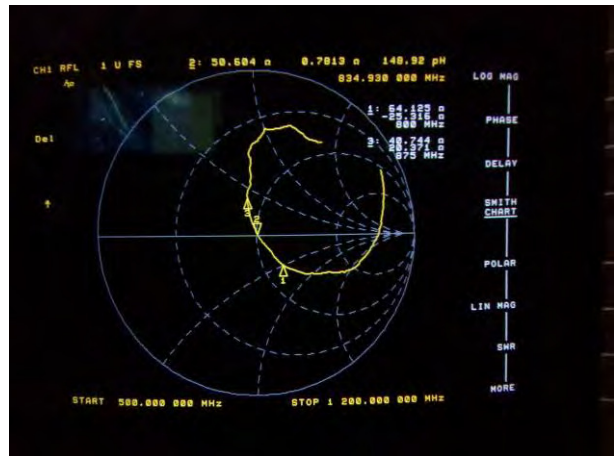

**NCL CALIBRATION LABORATORIES**

Calibration File No: DC-1331  
Project Number: BAC-dipole –cal-5615

**CERTIFICATE OF CALIBRATION**

It is certified that the equipment identified below has been calibrated in the **NCL CALIBRATION LABORATORIES** by qualified personnel following recognized procedures and using transfer standards traceable to NRC/NIST.

Validation Dipole (Head & Body)

Manufacturer: APREL Laboratories  
Part number: ALS-D-1900-S-2  
Frequency: 1900 MHz  
Serial No: 210-00710

Customer: Bay Area Compliance Laboratory

Calibrated: 25<sup>th</sup> August, 2011  
Released on: 25<sup>th</sup> August, 2011

This Calibration Certificate is Incomplete Unless Accompanied with the Calibration Results Summary

Released By: \_\_\_\_\_

**NCL CALIBRATION LABORATORIES**

Suite 102, 303 Terry Fox Dr.  
Kanata, ONTARIO  
CANADA K2K 3J1

Division of APREL Lab.  
TEL: (613) 435-8300  
FAX: (613)435-8306

**NCL Calibration Laboratories**

Division of APREL Laboratories.

**Conditions**

Dipole 210-00710 was received in good condition and was a re-calibration.

**Ambient Temperature of the Laboratory:** 22 °C +/- 0.5°C

**Temperature of the Tissue:** 21 °C +/- 0.5°C

We the undersigned attest that to the best of our knowledge the calibration of this device has been accurately conducted and that all information contained within this report has been reviewed for accuracy.

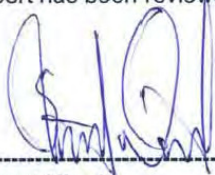

-----  
**Stuart Nicol**



-----  
**C. Teodorian**

**Primary Measurement Standards**

<b>Instrument</b>	<b>Serial Number</b>	<b>Cal due date</b>
Power meter Anritsu MA2408A	245025437	Nov.4, 2011
Power Sensor Anritsu MA2481D	103555	Nov 4, 2011
Attenuator HP 8495A (70dB) 1	944A10711	Aug.8, 2012
Network Analyzer Agilent E5071C	1334746J	Feb. 8, 2012

**Secondary Measurement Standards**

Signal Generator Agilent E4438C	-506 MY55182336	June 7, 2012
---------------------------------	-----------------	--------------

This page has been reviewed for content and attested to by signature within this document.

**NCL Calibration Laboratories**

Division of APREL Laboratories.

**Calibration Results Summary**

The following results relate the Calibrated Dipole and should be used as a quick reference for the user.

**Mechanical Dimensions**

**Length:** 67.1 mm  
**Height:** 38.9 mm

**Electrical Specification**

Tissue	Frequency	SWR:	Return Loss	Impedance
Head	1900MHz	1.0417 U	-35.395dB	49.020 Ω
Body	1900MHz	1.1177 U	-25.424dB	55.435 Ω

**System Validation Results**

Tissue	Frequency	1 Gram	10 Gram	Peak
Head	1900 MHz	39.648	20.311	73.365
Body	1900 MHz	39.769	20.176	75.866

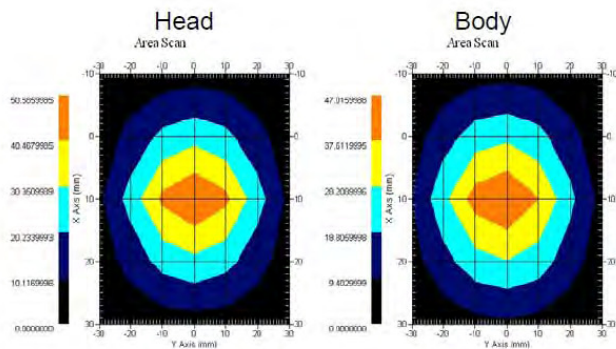

This page has been reviewed for content and attested to by signature within this document.

**NCL Calibration Laboratories**

Division of APREL Laboratories.

**Introduction**

This Calibration Report has been produced in line with the SSI Dipole Calibration Procedure SSI-TP-018-ALSAS. The results contained within this report are for Validation Dipole 210-00710. The calibration routine consisted of a three-step process. Step 1 was a mechanical verification of the dipole to ensure that it meets the mechanical specifications. Step 2 was an Electrical Calibration for the Validation Dipole, where the SWR, Impedance, and the Return loss were assessed. Step 3 involved a System Validation using the ALSAS-10U, along with APREL E-020 130 MHz to 26 GHz E-Field Probe Serial Number 212.

**References**

SSI-TP-018-ALSAS Dipole Calibration Procedure  
 SSI-TP-016 Tissue Calibration Procedure  
 IEEE 1528 "Recommended Practice for Determining the Peak Spatial-Average Specific Absorption Rate (SAR) in the Human Body Due to Wireless Communications Devices: Experimental Techniques"

**Conditions**

Dipole 210-00710 was new taken from stock.

**Ambient Temperature of the Laboratory:** 22 °C +/- 0.5°C  
**Temperature of the Tissue:** 20 °C +/- 0.5°C

**Dipole Calibration uncertainty**

The calibration uncertainty for the dipole is made up of various parameters presented below.

<b>Mechanical</b>	1%
<b>Positioning Error</b>	1.22%
<b>Electrical</b>	1.7%
<b>Tissue</b>	2.2%
<b>Dipole Validation</b>	2.2%
<b>TOTAL</b>	<b>8.32% (16.64% K=2)</b>

This page has been reviewed for content and attested to by signature within this document.

**NCL Calibration Laboratories**

Division of APREL Laboratories.

**Dipole Calibration Results**

**Mechanical Verification**

APREL Length	APREL Height	Measured Length	Measured Height
68.0 mm	39.5 mm	67.1mm	38.9 mm

**Electrical Validation**

Tissue Type	Return Loss:	SWR:	Impedance:
Head	-29.360 dB	1.0732 U	47.869 Ω
Body	-22.799 dB	1.1566 U	48.022 Ω

**Tissue Validation**

	Dielectric constant, $\epsilon_r$	Conductivity, $\sigma$ [S/m]
Head Tissue 1900MHz	38.4	1.43
Body Tissue 1900MHz	51.87	1.59

This page has been reviewed for content and attested to by signature within this document.

**NCL Calibration Laboratories**

Division of APREL Laboratories.

The Following Graphs are the results as displayed on the Vector Network Analyzer.

**S11 Parameter Return Loss**

Head

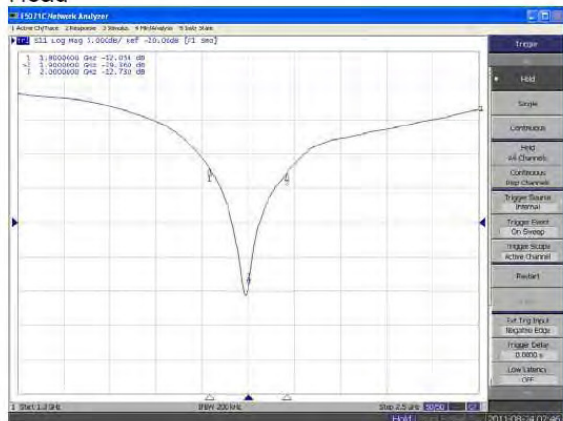

Body

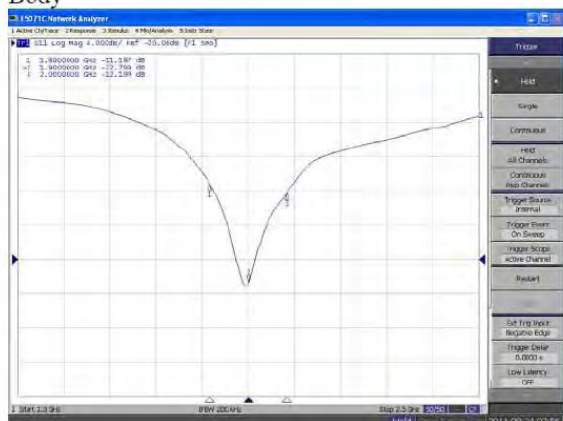

This page has been reviewed for content and attested to by signature within this document.



### NCL Calibration Laboratories

Division of APREL Laboratories.

### SWR

#### Head

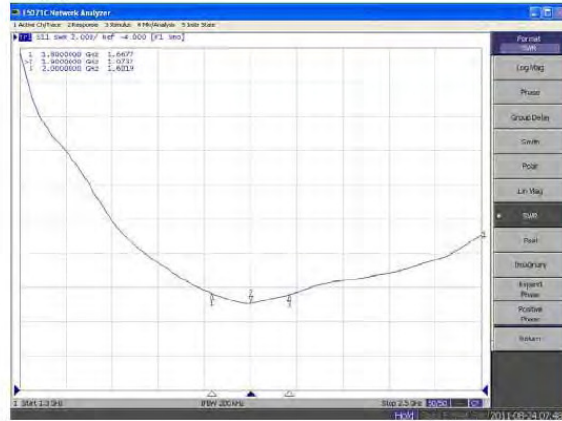

#### Body

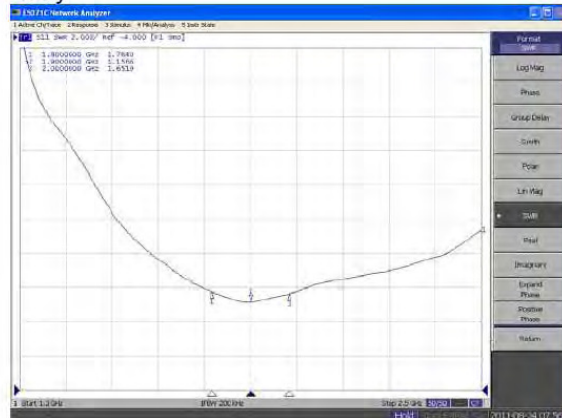

This page has been reviewed for content and attested to by signature within this document.

### NCL Calibration Laboratories

Division of APREL Laboratories.

## Smith Chart Dipole Impedance

Head

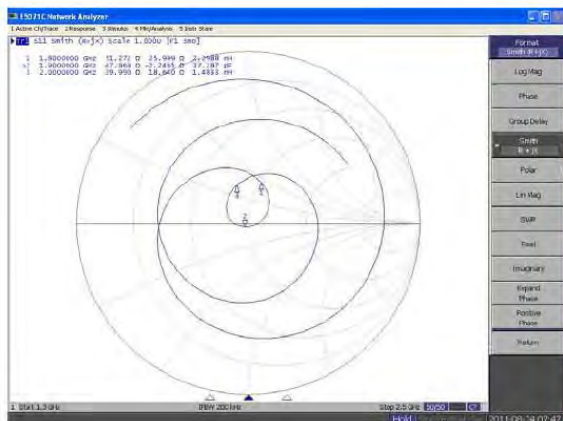

Body

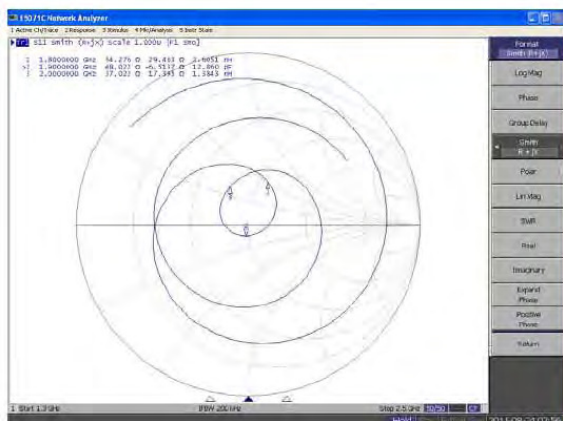

This page has been reviewed for content and attested to by signature within this document.

**NCL Calibration Laboratories**

Division of APREL Laboratories.

**Test Equipment**

The test equipment used during Probe Calibration, manufacturer, model number and, current calibration status are listed and located on the main APREL server R:\NCL\Calibration Equipment\Instrument List 2011

This page has been reviewed for content and attested to by signature within this document.

9

**Mechanical Verification**

APREL Length	APREL Height	Measured Length	Measured Height
68.0 mm	39.4 mm	68.3 mm	39.2 mm

Tissue Type	Measured Return Loss	Measured Impedance
Head	-28.083 dB	47.477 Ω
Body	-22.022 dB	48.076 Ω

**Test Graphs:**

Head Tissue

Return Loss :

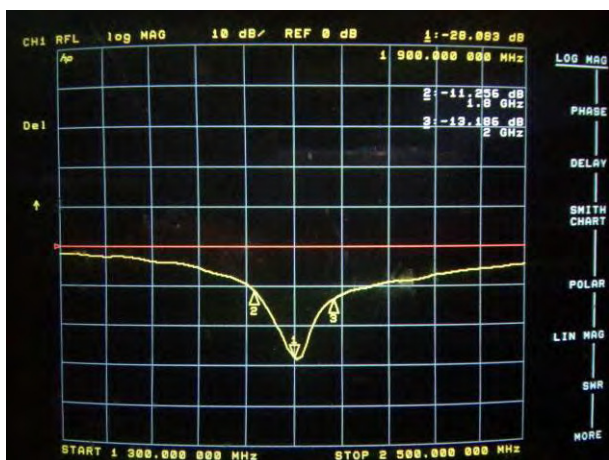

Impedance :



Body Tissue

Return Loss :

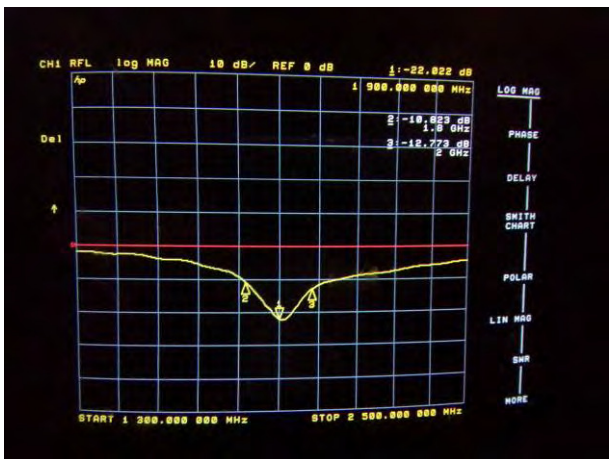

Impedance :



**NCL CALIBRATION LABORATORIES**

Calibration File No: DC-1330  
Project Number: BAC-dipole-cal-5619

**CERTIFICATE OF CALIBRATION**

It is certified that the equipment identified below has been calibrated in the **NCL CALIBRATION LABORATORIES** by qualified personnel following recognized procedures and using transfer standards traceable to NRC/NIST.

Validation Dipole (Head & Body)

Manufacturer: APREL Laboratories  
Part number: ALS-D-2450-S-2  
Frequency: 2450 MHz  
Serial No: 220-00758

Customer: Bay Area Compliance Laboratory

Calibrated: 25<sup>th</sup> August, 2011  
Released on: 25<sup>th</sup> August, 2011

This Calibration Certificate is Incomplete Unless Accompanied with the Calibration Results Summary

Released By: \_\_\_\_\_

**NCL CALIBRATION LABORATORIES**

Suite 102, 303 Terry Fox Dr.  
Kanata, ONTARIO  
CANADA K2K 3J1

Division of APREL Lab.  
TEL: (613) 435-8300  
FAX: (613)435-8306

**NCL Calibration Laboratories**

Division of APREL Laboratories.

**Conditions**

Dipole 220-00758 was received in good condition and was a re-calibration.

**Ambient Temperature of the Laboratory:** 22 °C +/- 0.5°C

**Temperature of the Tissue:** 21 °C +/- 0.5°C

We the undersigned attest that to the best of our knowledge the calibration of this device has been accurately conducted and that all information contained within this report has been reviewed for accuracy.

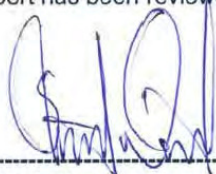

-----  
**Stuart Nicol**



-----  
**C. Teodorian**

**Primary Measurement Standards**

<b>Instrument</b>	<b>Serial Number</b>	<b>Cal due date</b>
Power meter Anritsu MA2408A	245025437	Nov.4, 2011
Power Sensor Anritsu MA2481D	103555	Nov 4, 2011
Attenuator HP 8495A (70dB) 1	944A10711	Aug.8, 2012
Network Analyzer Agilent E5071C	1334746J	Feb. 8, 2012
<b>Secondary Measurement Standards</b>		
Signal Generator Agilent E4438C	-506 MY55182336	June 7, 2012

This page has been reviewed for content and attested to by signature within this document.

**NCL Calibration Laboratories**

Division of APREL Laboratories.

**Calibration Results Summary**

The following results relate the Calibrated Dipole and should be used as a quick reference for the user.

**Mechanical Dimensions**

**Length:** 52.4 mm  
**Height:** 30.3 mm

**Electrical Specification**

Tissue	Frequency	SWR:	Return Loss	Impedance
Head	2450 MHz	1.0459 U	-33.024 dB	48.533 Ω
Body	2450 MHz	1.1159 U	-25.235 dB	46.676 Ω

**System Validation Results**

Tissue	Frequency	1 Gram	10 Gram	Peak
Head	2450 MHz	52.667	24.518	105.920
Body	2450 MHz	52.561	24.104	108.940

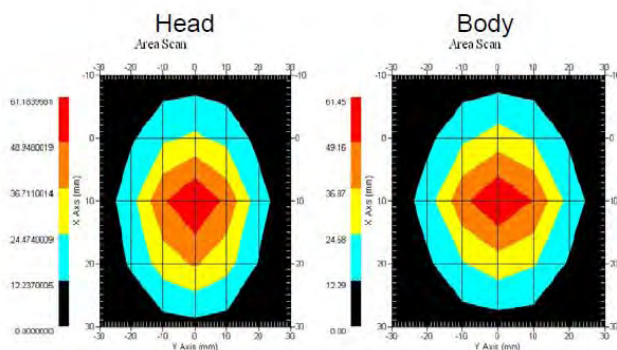

This page has been reviewed for content and attested to by signature within this document.

**NCL Calibration Laboratories**

Division of APREL Laboratories.

**Introduction**

This Calibration Report has been produced in line with the SSI Dipole Calibration Procedure SSI-TP-018-ALSAS. The results contained within this report are for Validation Dipole 220-00758. The calibration routine consisted of a three-step process. Step 1 was a mechanical verification of the dipole to ensure that it meets the mechanical specifications. Step 2 was an Electrical Calibration for the Validation Dipole, where the SWR, Impedance, and the Return loss were assessed. Step 3 involved a System Validation using the ALSAS-10U, along with APREL E-020 130 MHz to 26 GHz E-Field Probe Serial Number 212.

**References**

- SSI-TP-018-ALSAS Dipole Calibration Procedure
- SSI-TP-016 Tissue Calibration Procedure
- IEEE 1528 "Recommended Practice for Determining the Peak Spatial-Average Specific Absorption Rate (SAR) in the Human Body Due to Wireless Communications Devices: Experimental Techniques"
- IEC-62209 "Human exposure to radio frequency fields from hand-held and body-mounted wireless communication devices – Human models, instrumentation, and procedures"
- Part 1: "Procedure to determine the Specific Absorption Rate (SAR) for hand-held devices used in close proximity of the ear (frequency range of 300 MHz to 3 GHz)"
- IEC-62209 "Human exposure to radio frequency fields from hand-held and body-mounted wireless communication devices – Human models, instrumentation, and procedures"
- Part 2 *Draft*: "Procedure to determine the Specific Absorption Rate (SAR) for hand-held devices used in close proximity of the ear (frequency range of 30 MHz to 6 GHz)"

**Conditions**

Dipole 220-00758 was a re-calibration.

**Ambient Temperature of the Laboratory:** 22 °C +/- 0.5°C  
**Temperature of the Tissue:** 20 °C +/- 0.5°C

**Dipole Calibration uncertainty**

The calibration uncertainty for the dipole is made up of various parameters presented below.

<b>Mechanical</b>	1%
<b>Positioning Error</b>	1.22%
<b>Electrical</b>	1.7%
<b>Tissue</b>	2.2%
<b>Dipole Validation</b>	2.2%
<b>TOTAL</b>	<b>8.32% (16.64% K=2)</b>

This page has been reviewed for content and attested to by signature within this document.



**NCL Calibration Laboratories**

Division of APREL Laboratories.

**Dipole Calibration Results**

**Mechanical Verification**

APREL Length	APREL Height	Measured Length	Measured Height
51.5 mm	30.4 mm	52.4 mm	30.3 mm

**Electrical Calibration**

Tissue Type	Return Loss:	SWR:	Impedance:
Head	-33.024 dB	1.0459 U	48.533 Ω
Body	-25.235 dB	1.1159 U	46.676 Ω

**Tissue Validation**

	Dielectric constant, $\epsilon_r$	Conductivity, $\sigma$ [S/m]
Head Tissue 2450MHz	38.2	1.82
Body Tissue 2450MHz	51.74	1.96

This page has been reviewed for content and attested to by signature within this document.

**NCL Calibration Laboratories**

Division of APREL Laboratories.

The Following Graphs are the results as displayed on the Vector Network Analyzer.

**S11 Parameter Return Loss**

Head

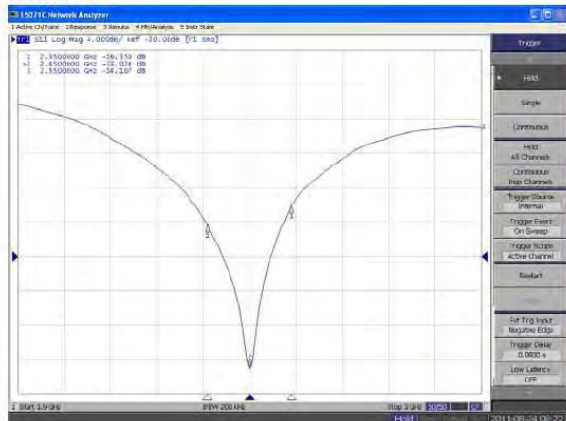

Body

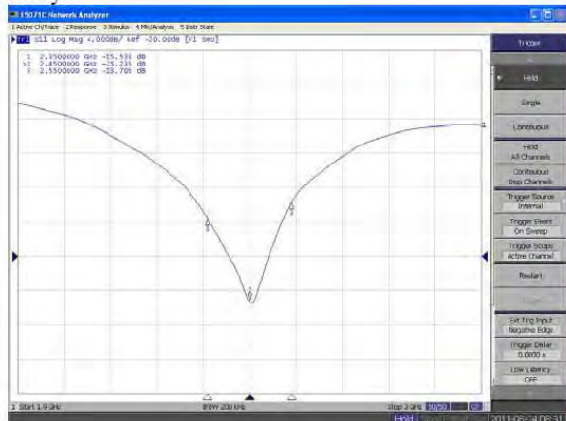

This page has been reviewed for content and attested to by signature within this document.

**NCL Calibration Laboratories**

Division of APREL Laboratories.

**SWR**

**Head**

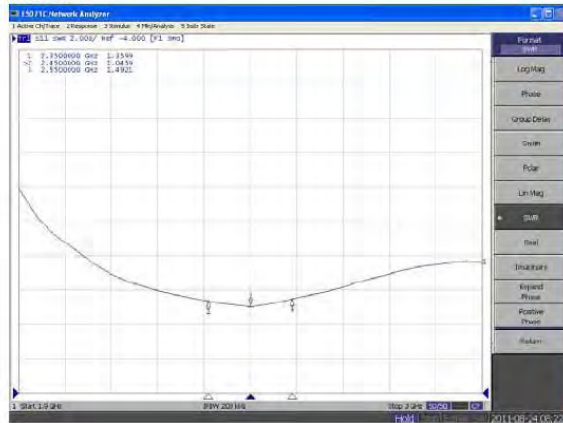

**Body**

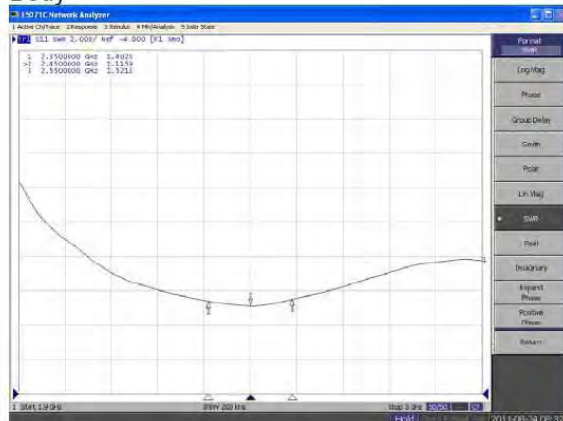

This page has been reviewed for content and attested to by signature within this document.

**NCL Calibration Laboratories**

Division of APREL Laboratories.

**Smith Chart Dipole Impedance**

**Head**

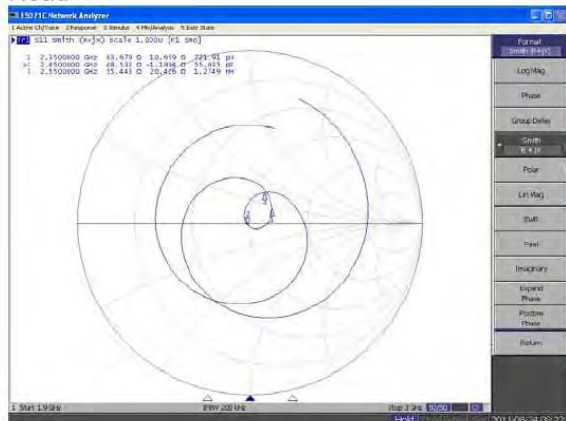

**Body**

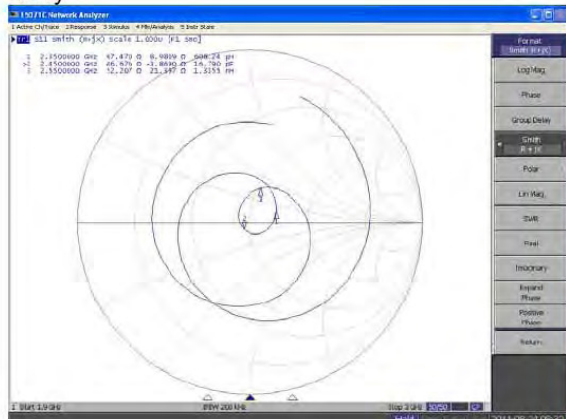

This page has been reviewed for content and attested to by signature within this document.

**NCL Calibration Laboratories**

Division of APREL Laboratories.

**Test Equipment**

The test equipment used during Probe Calibration, manufacturer, model number and, current calibration status are listed and located on the main APREL server R:\NCL\Calibration Equipment\Instrument List May 2011.

This page has been reviewed for content and attested to by signature within this document.

9

**2450MHz Dipole Calibration By BACL at 2013-12-20**

**Mechanical Verification**

APREL Length	APREL Height	Measured Length	Measured Height
51.5mm	30.4 mm	51.5 mm	30.4 mm

Tissue Type	Measured Return Loss	Measured Impedance
Head	-36.595 dB	51.203 $\Omega$
Body	-27.599 dB	49.186 $\Omega$

**Test Graphs:**

Head Tissue

Return Loss :

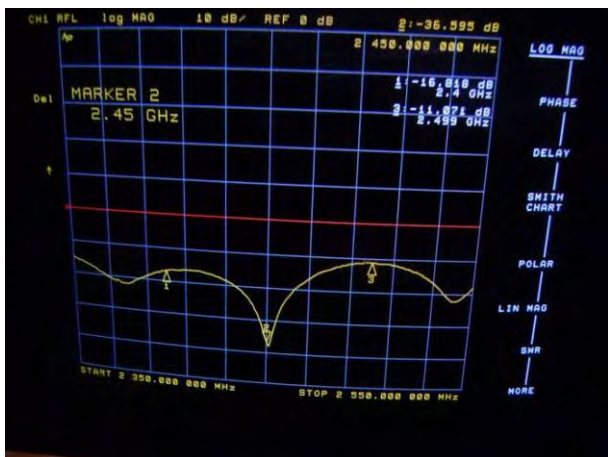

Impedance :



Body Tissue

Return Loss :

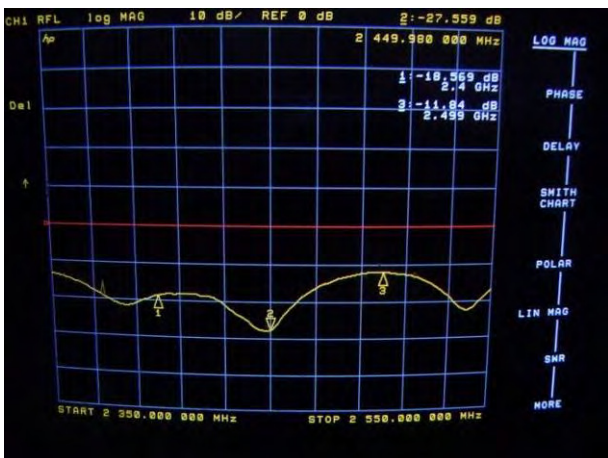

Impedance :



---

## APPENDIX E INFORMATIVE REFERENCES

---

- [1] Federal Communications Commission, "Report and order: Guidelines for evaluating the environmental effects of radiofrequency radiation", Tech. Rep. FCC 96-326, FCC, Washington, D.C. 20554, 1996.
- [2] David L. Means Kwok Chan, Robert F. Cleveland, "Evaluating compliance with FCC guidelines for human exposure to radiofrequency electromagnetic fields", Tech. Rep., Federal Communication Commission, Office of Engineering & Technology, Washington, DC, 1997.
- [3] Thomas Schmid, Oliver Egger, and Niels Kuster, "Automated E-field scanning system for dosimetric assessments", IEEE Transactions on Microwave Theory and Techniques, vol. 44, pp. 105-113, Jan. 1996.
- [4] Niels Kuster, Ralph Kastle, and Thomas Schmid, "Dosimetric evaluation of mobile communications equipment with known precision", IEEE Transactions on Communications, vol. E80-B, no. 5, pp. 645-652, May 1997.
- [5] CENELEC, "Considerations for evaluating of human exposure to electromagnetic fields (EMFs) from mobile telecommunication equipment (MTE) in the frequency range 30MHz - 6GHz", Tech. Rep., CENELEC, European Committee for Electrotechnical Standardization, Brussels, 1997.
- [6] ANSI, ANSI/IEEE C95.1-1992: IEEE Standard for Safety Levels with Respect to Human Exposure to Radio Frequency Electromagnetic Fields, 3 kHz to 300 GHz, The Institute of Electrical and Electronics Engineers, Inc., New York, NY 10017, 1992.
- [7] Katja Pokovic, Thomas Schmid, and Niels Kuster, "Robust setup for precise calibration of E-field probes in tissue simulating liquids at mobile communications frequencies", in ICECOM '97, Dubrovnik, October 15-17, 1997, pp. 120-24.
- [8] Katja Pokovic, Thomas Schmid, and Niels Kuster, "E-field probe with improved isotropy in brain simulating liquids", in Proceedings of the ELMAR, Zadar, Croatia, 23-25 June, 1996, pp. 172-175.
- [9] Volker Hombach, Klaus Meier, Michael Burkhardt, Eberhard Kuhn, and Niels Kuster, "The dependence of EM energy absorption upon human head modeling at 900 MHz", IEEE Transactions on Microwave Theory and Techniques, vol. 44, no. 10, pp. 1865-1873, Oct. 1996.
- [10] Klaus Meier, Ralf Kastle, Volker Hombach, Roger Tay, and Niels Kuster, "The dependence of EM energy absorption upon human head modeling at 1800 MHz", IEEE Transactions on Microwave Theory and Techniques, Oct. 1997, in press.
- [11] W. Gander, Computermathematik, Birkhaeuser, Basel, 1992.
- [12] W. H. Press, S. A. Teukolsky, W. T. Vetterling, and B. P. Flannery, Numerical Recipes in C, The Art of Scientific Computing, Second Edition, Cambridge University Press, 1992. Dosimetric Evaluation of Sample device, month 1998 9
- [13] NIS81 NAMAS, "The treatment of uncertainty in EMC measurement", Tech. Rep., NAMAS Executive, National Physical Laboratory, Teddington, Middlesex, England, 1994.
- [14] Barry N. Taylor and Christ E. Kuyatt, "Guidelines for evaluating and expressing the uncertainty of NIST measurement results", Tech. Rep., National Institute of Standards and Technology, 1994. Dosimetric Evaluation of Sample device, month 1998 10.

\*\*\*\*\* END OF REPORT \*\*\*\*\*