

CONFORMANCE TEST REPORT**FOR****Subpart C Part 27**

Report No. : JNDL-NU-14R-0004

Client: Franklin Technology Inc.
Product: LTE/WIFI MOBILE ROUTER
Model: R774
Manufacture/supplier: Franklin Technology Inc.



Date test item received: 2014/04/18
Date test campaign completed: 2014/05/29
Date of issue: 2014/06/02

ATTESTATION STATEMENT

This equipment has been tested in accordance with the standards identified in the referenced test report. To the best of my knowledge and belief, these tests were performed using the measurement procedures described in this report and demonstrate that the equipment complies with the appropriate standards.

All JNDL Laboratory. CO., LTD instrumentation and accessories used to test products for compliance to the indicated standards are calibrated regularly in accordance with ISO 17025 requirements.

Total number of pages of this test report : 46 pages

Test engineer	Report reviewed by
 2014. 6. 2	 2014. 6. 2
Sang-hun kang	Kyoung-Pil, Yeom

REPORT SUMMARY

Purpose of Test :	To demonstrate the EUT in compliance with Part 27 Subpart C of the FCC's
Disclaimer :	The test results relate only to the items tested.
Applicable Standards :	Pt 27 & Pt 2, ANSI 63.4:2009, TIA-603-D-2010

TEST ENVIRONMENT AND TEST SETUP

Test Facilities :	Test Firm Registration # : 748649 3m & 10m Open Site : 386-1, Ho-dong, Cheoin-gu, Yongin-si, Gyeonggi-do, Korea 3m semi-Anechoic chamber : B 114~115, 810 Kwanyang-Dong, dongan-Gu, Anyang-Si, Kyunggi-Do, 431-060, Korea
Laboratory Test Conditions :	Open Site : Temperature 25 °C, Humidity : 58 % 3m anechoic chamber : Temperature 26 °C, Humidity : 55 %
Test Exercise :	The EUT was set in continuous transmit mode of operation unless stated otherwise.
Modification to the EUT :	No modification was made.
Supporting Accessories :	None

REVISION HISTORY

Revision	Date	Descriptions
0	2014.06.02	Original release

Table of Contents

<i>1. General Remarks</i>	4
<i>2. Test Site</i>	4
2.1 Location	4
2.2 List of Test equipment used for tests	4
2.3 Test Date	4
<i>3. Description of the Equipment Under Test</i>	5
<i>4. List of Measurements</i>	6
<i>5. Description of Tests</i>	7
<i>6. Conducted Output power</i>	10
<i>7. Effective Radiated Power</i>	20
<i>8. Peak to Average Ratio</i>	23
<i>9. Modulation Characteristics</i>	25
<i>10. Occupied Bandwidth</i>	26
<i>11. Band Edge Compliance</i>	28
<i>12. Spurious Emission at Antenna Terminals</i>	32
<i>13. Field Strength of Spurious Radiation</i>	35
<i>14. Frequency Stability</i>	42

1. General Remarks

The test results in this report apply to the particular Equipment Under Test (EUT) as declared in this report.

The test results presented in this report relate only to the item tested.

2. Test Site

2.1 Location

JNDL Laboratory. CO., LTD. (Test Firm Registration # : 748649)

3m anechoic chamber : B 114~115, 810 Kwanyang-Dong, dongan-Gu, Anyang-Si, Kyunggi-Do, Korea

3m & 10m Open site : 386-1, Ho-dong, Cheoin-gu, Yongin-si, Gyeonggi-do, Korea

2.2 List of Test equipment used for tests

No.	Instrument	Model No.	Due to Calibration	Manufactor	Serial No.
<input checked="" type="checkbox"/>	PSA SPECTRUM ANALYZER (3 Hz ~ 26.5 GHz)	E4440A	2014-10-15	Agilent Technologies	MY46185375
<input checked="" type="checkbox"/>	SPECTRUM ANALYZER (20 Hz ~ 40.0 GHz)	FSP40	2015-01-08	Rohde & Schwarz	100308
<input checked="" type="checkbox"/>	SIGNAL GENERATOR (10 MHz ~ 40 GHz)	MG3694B	2014-10-15	Anritsu Corp	062513
<input checked="" type="checkbox"/>	POWER METER (DC ~ 67 GHz)	NRP2	2014-10-15	Rohde & Schwarz	100973
<input checked="" type="checkbox"/>	POWER SENSOR (50 MHz ~ 40 GHz)	NRP-Z85	2014-10-15	Rohde & Schwarz	101121
<input checked="" type="checkbox"/>	POWER SENSOR (9 KHz ~ 6 GHz)	NRP-Z92	2014-10-15	Rohde & Schwarz	100093
<input checked="" type="checkbox"/>	EMI TEST RECEIVER (20 MHz ~ 1000 MHz)	ESVS30	2014-10-15	Rohde & Schwarz	828525/005
<input type="checkbox"/>	COMMUNICATION TEST SET (WCDMA/CDMA/EVDO/PCS)	E5515C	2014-07-31	Agilent Technologies	MY50260242
<input checked="" type="checkbox"/>	COMMUNICATION TEST SET (LTE)	CMW500	2014-07-31	Rohde & Schwarz	140388
<input checked="" type="checkbox"/>	POWER DIVIDER (DC-18GHz)	1506A	2014-10-15	WEINSCHTEL	KW957
<input checked="" type="checkbox"/>	BILOG ANTENNA (30 MHz ~ 1000 MHz)	VULB 9168	2015-02-17	Schwarzbeck	9168-505
<input checked="" type="checkbox"/>	DIPOLE ANTENNA (30 MHz ~ 1 GHz)	UHAP	2016-04-01	Schwarzbeck	950
<input checked="" type="checkbox"/>	HORN ANTENNA (1 GHz ~ 18 GHz)	BBHA 9120D	2014-12-12	Schwarzbeck	568
<input type="checkbox"/>	HORN ANTENNA (1 GHz ~ 18 GHz)	3117	2014-10-24	ETS-Lindgren	00135889
<input checked="" type="checkbox"/>	Microwave Amplifier (1 GHz ~ 18 GHz)	TK-PA18	2014-09-05	TESTEK	1200020
<input checked="" type="checkbox"/>	Low Noise Amplifier (18 GHz ~ 40 GHz)	AMF-6F-18004000-37-8P	2015-05-06	MITEQ	1814914
<input checked="" type="checkbox"/>	High Power Amplifier (0.7 GHz ~ 2.5 GHz)	ZHL-30W-252-S+	N/A	Mini Circuit	804501219
<input checked="" type="checkbox"/>	High Pass Filter (1.5 GHz ~ 15 GHz)	WHKX1.5/15G-6SS	2015-03-17	WAINWRIGHT	4
<input type="checkbox"/>	High Pass Filter (3 GHz ~ 18 GHz)	WHK3.0/18G-10SS	2014-06-07	WAINWRIGHT	344

→ All equipment is calibrated with traceable calibrations.

2.3 Test Date

Date of Application: 2014- 04 - 18

Date of Test: 2014- 04 - 22 ~ 2014 - 05 - 29

3. Description of the Equipment Under Test

Manufacturer :	Franklin Technology Inc.
Product Description :	LTE/WIFI MOBILE ROUTER consists of LTE Band 12, LTE Band 25, Cellular CDMA, PCS CDMA, 1xRTT and EVDO Rev. 0 & Rev. A, WIFI(2.4 GHz)
FCC ID :	XHG-R774
Model Name :	R774
Multiple Model Name :	None
Operating Frequency :	TX : 701.50 MHz ~ 713.50 MHz RX : 731.50 MHz ~ 743.50 MHz
Modulation Type :	QPSK, 16QAM
Max. RF Output Power	• 0.241 W ERP LTE Band 12(23.82 dBm)
Emission Designator	• 4M51G7D LTE Band 12 (Channel Bandwidth : 5 MHz)
EUT Power Source :	Primary power – 3.7 Vdc Battery
	Secondary Power – Via AC Mains Powered DC 5V adapter
Test Item :	Prototype
Type of Equipment :	Mobile
Antennas :	PIFA Internal Antenna Max peak gain : -2.4 dBi
Antenna Connector :	DIP Connection(INTENNA)

- ➔ All the testing were performed according to the procedures in FCC Parts 27 & Parts 2
The EUT was operation with Communication Simulator (CMW500)
- ➔ EUT not support the additional bandwidth 1.4 MHz, 3 MHz, 10 MHz system.
- ➔ EUT only support 5 MHz bandwidth system.

4. List of Measurements

Guide Lines	FCC Rules Part	Test Conditon	Result
Conducted Output Power	2.1046	Conducted	PASS
Effective Radiated Power	27.50(c)(10)	Radiated	PASS
Peak to Average Ratio	-	Conducted	PASS
Modulation Characteristics	2.1047	Conducted	PASS
Occupied Bandwidth	2.1049	Conducted	PASS
Band Edges Compliance	27.53(f) / 2.1051	Conducted	PASS
Spurious Emission at Antenna Terminals	27.53(f) / 2.1051	Conducted	PASS
Field Strength of Spurious Radiation	27.53(f) / 2.1053	Radiated	PASS
Frequency Stability	27.54 / 2.1055	Conducted	PASS

5. Description of Tests

5.1 Conducted power / Modulation Characteristics

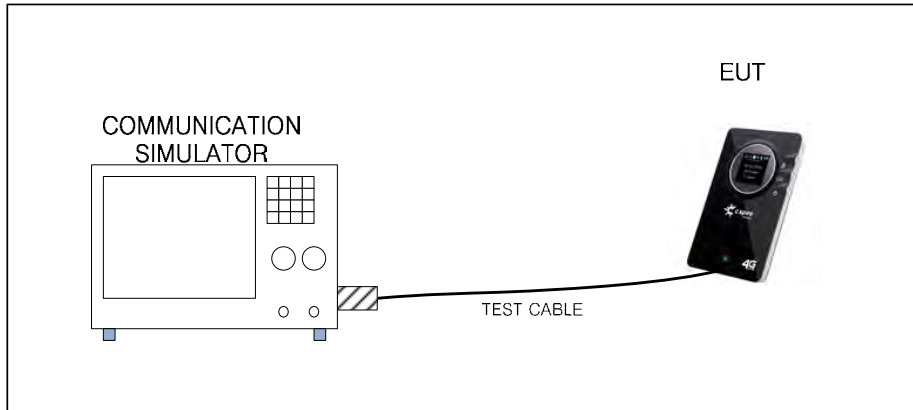

5.2 Peak to Average Ratio / Occupied Bandwidth / Band Edges Compliance / Spurious Emission at Antenna Terminals

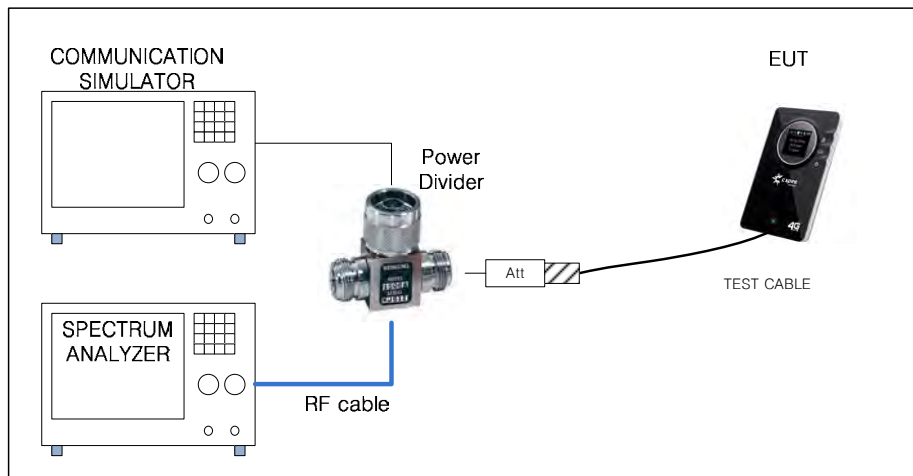

5.3 Effective Radiated Power / Field Strength of Spurious radiation

5.3.1 Test setup for 30 MHz ~ 1 GHz

The diagram below shows the test setup that is utilized to make the measurements for emission from 30 MHz to 1 GHz emissions

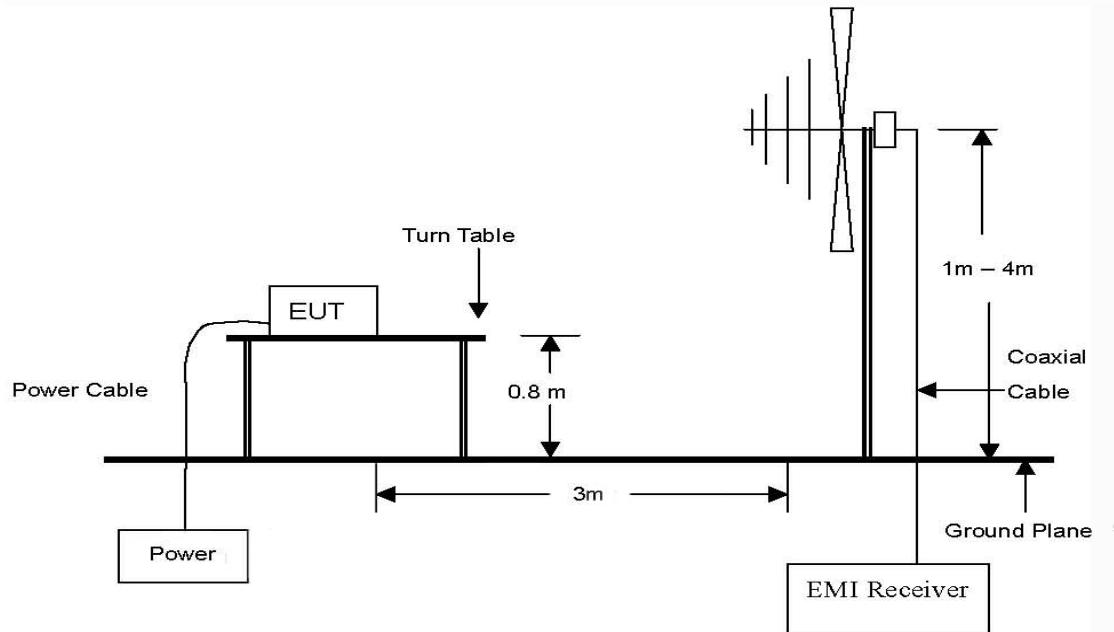

5.3.2 Test setup for 1 GHz ~ 20 GHz

The diagram below shows the test setup that is utilized to make the measurements for emission from 1 GHz to 20 GHz emissions. As required by subpart 15.33 emissions were measured to .20 GHz.(10th carrier frequency)

*** ERP measurement not use filter, it only use Field Strength of Spurious emissions.**

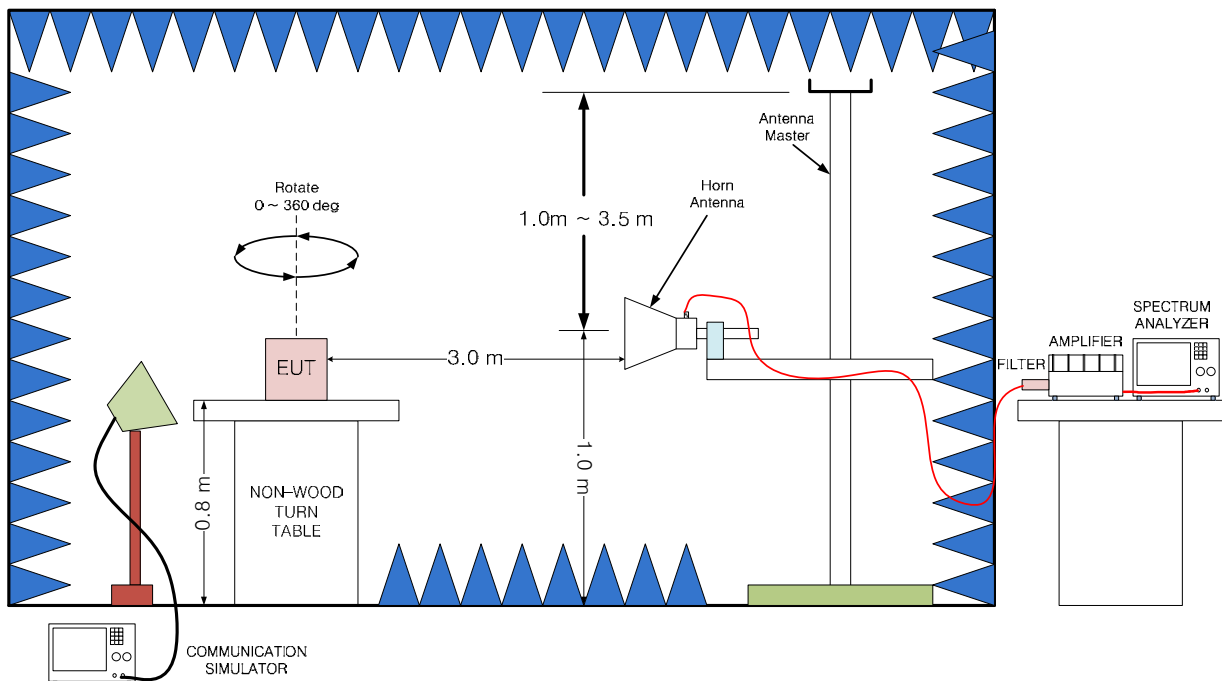

5.4 Frequency Stability

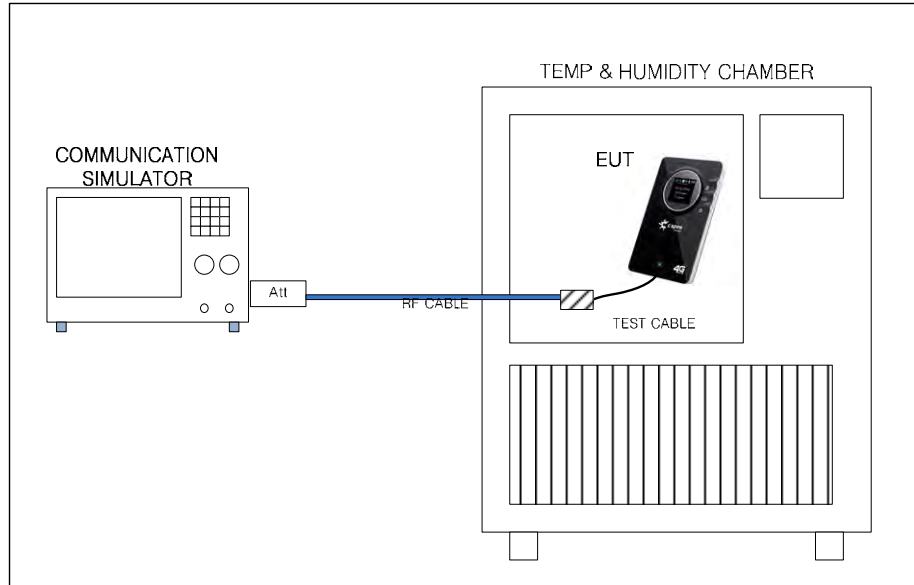

5.5 Worst-case Configuration and mode

Radiated emission and conducted emission were performed with the EUT set to transmit at the channel with highest output power as worst-case scenario.

The fundamental of the EUT was investigated in three orthogonal orientations XY, YZ, ZX, it was determined that XY orientation was worst-case orientation

Based on the baseline scan, the worst-case were:

QPSK Modulation : RB 1#0 (Resource Block Size / Resource Block Offset)

16QAM Modulation : RB 1#0 (Resource Block Size / Resource Block Offset)

5.6 EUT operating conditions

The Eut makes a call to the communication simulator. The communication simulator station system controlled a EUT to export maximum output power under transmittision mode and specific channel frequency.

5.7 Methods and Procedure

Reference :	47 FCC PART 27 subpart C
Title :	MISCELLANEOUS WIRELESS COMMUNICATIONS SERVICES
Reference :	47 FCC PART 2
Title :	FREQUENCY ALLOCATIONS AND RADIO TREATY MATTERS; GENERAL RULES AND REGULATIONS
Reference :	ANSI / TIA-603-D-2010
Title :	Land mobile fm or pm communications equipment measurement and performance standards
Reference :	FCC KDB 971168 D01 v02r01, 7 June 2013
Title:	Measurement Guidance for Certification of Licensed Digital Transmitters

6. Conducted Output power

6.1 Test Procedure

A base station simulator was used to establish communication with The EUT. The base station simulator parameters were set to produce the maximum power from the EUT. This device was tested under all configurations and the highest power is reported. Conducted Output Powers of EUT are reported below.

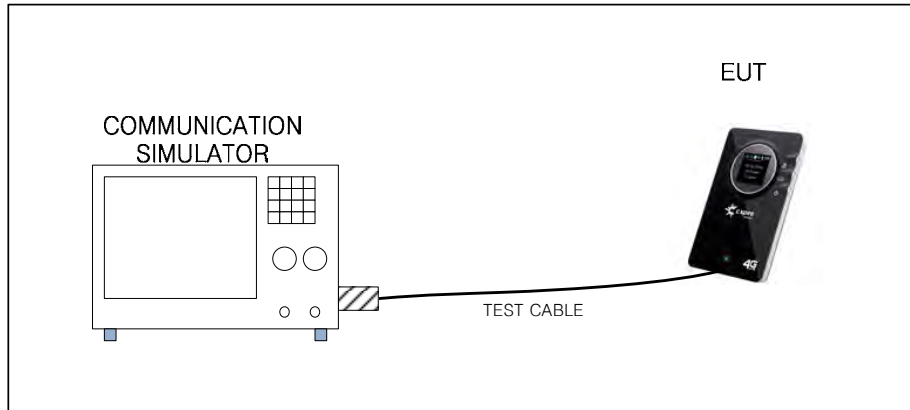

* Simulator call mode : all bit up (MAX Power mode)

* TEST Cable : Connect PCS Antenna PORT (0.3dB loss / 30 cm / MCX to SMA Cable)

6.2 Test Result

Unit : dBm

Modulation	Resource Block Size	Resource Block Offset	Low ch : 23035	Mid ch : 23095	High ch : 23155
			Freq(MHz) : 701.50	Freq(MHz) : 707.50	Freq(MHz) : 713.50
QPSK	1	0	22.36	22.34	22.36
	1	13	22.43	22.17	22.58
	1	24	22.24	22.24	22.45
	12	0	21.38	21.40	21.38
	12	6	21.32	21.33	21.41
	12	13	21.40	21.23	21.40
	25	0	21.35	21.34	21.49
16QAM	1	0	21.02	21.62	21.73
	1	13	21.02	21.56	21.88
	1	24	21.02	21.51	21.81
	12	0	20.47	20.52	20.47
	12	6	20.40	20.47	20.54
	12	13	20.38	20.37	20.50
	25	0	20.51	20.42	20.41

* Average power

6.3 Test Plots

* CH:23035(701.50 MHz)

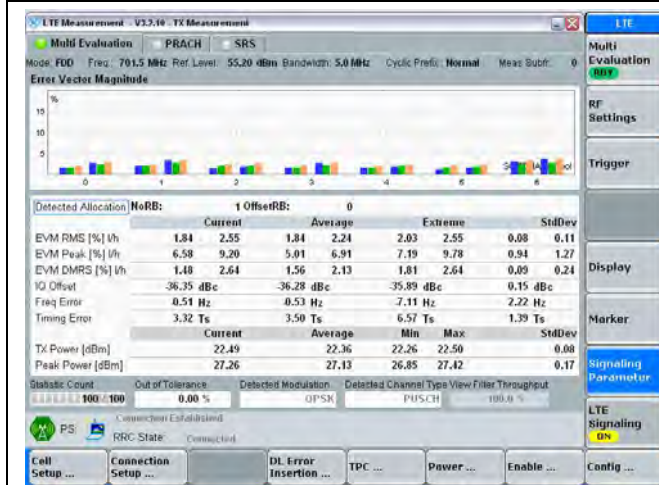

QPSK/RB1#0

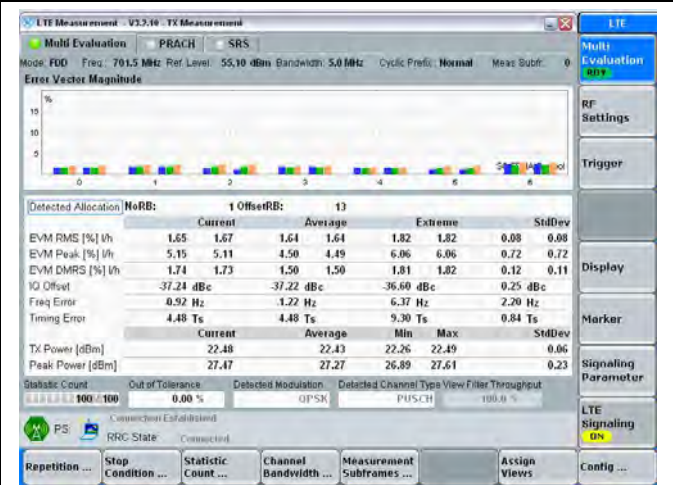

QPSK/RB1#13

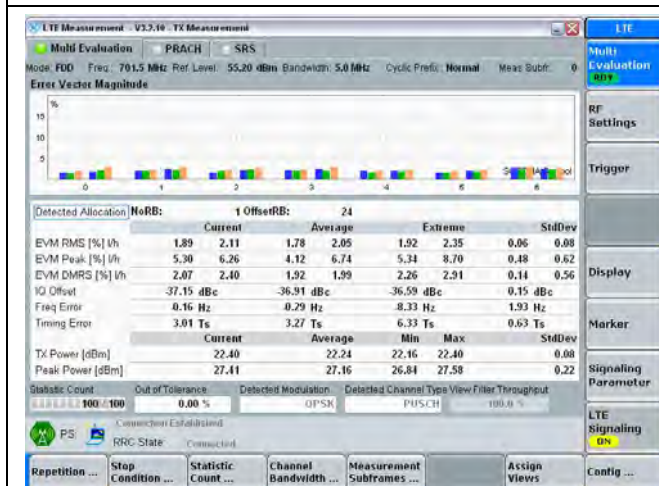

QPSK/RB1#24

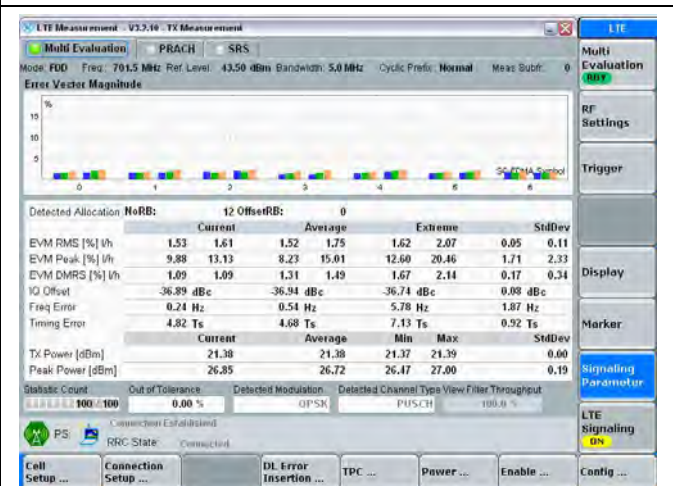

QPSK/RB12#0

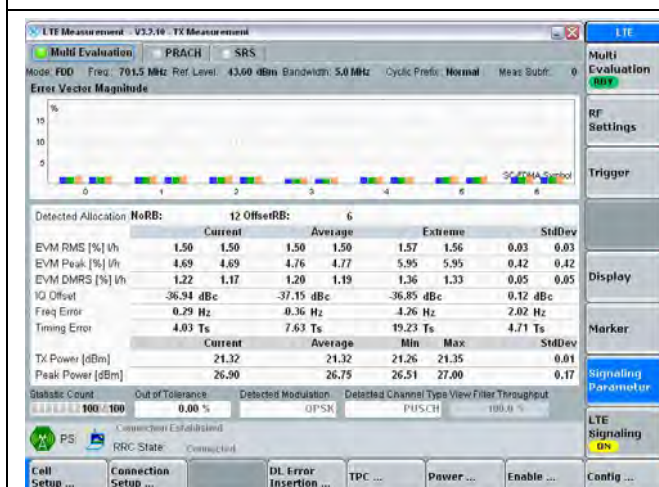

QPSK/RB12#6

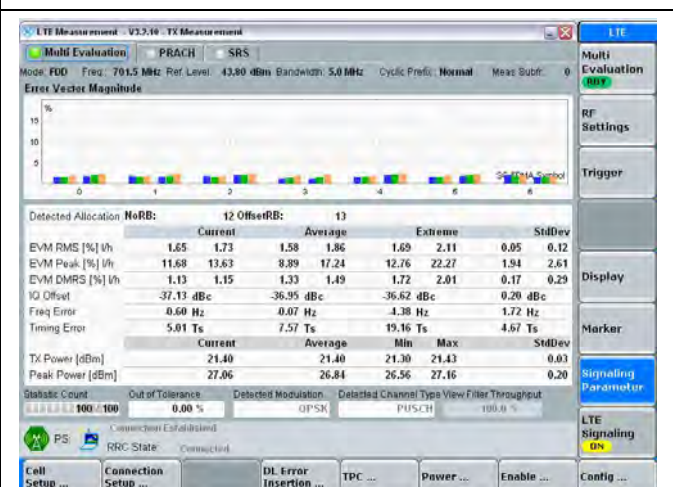

QPSK/RB12#13

* CH:23035(701.50 MHz)

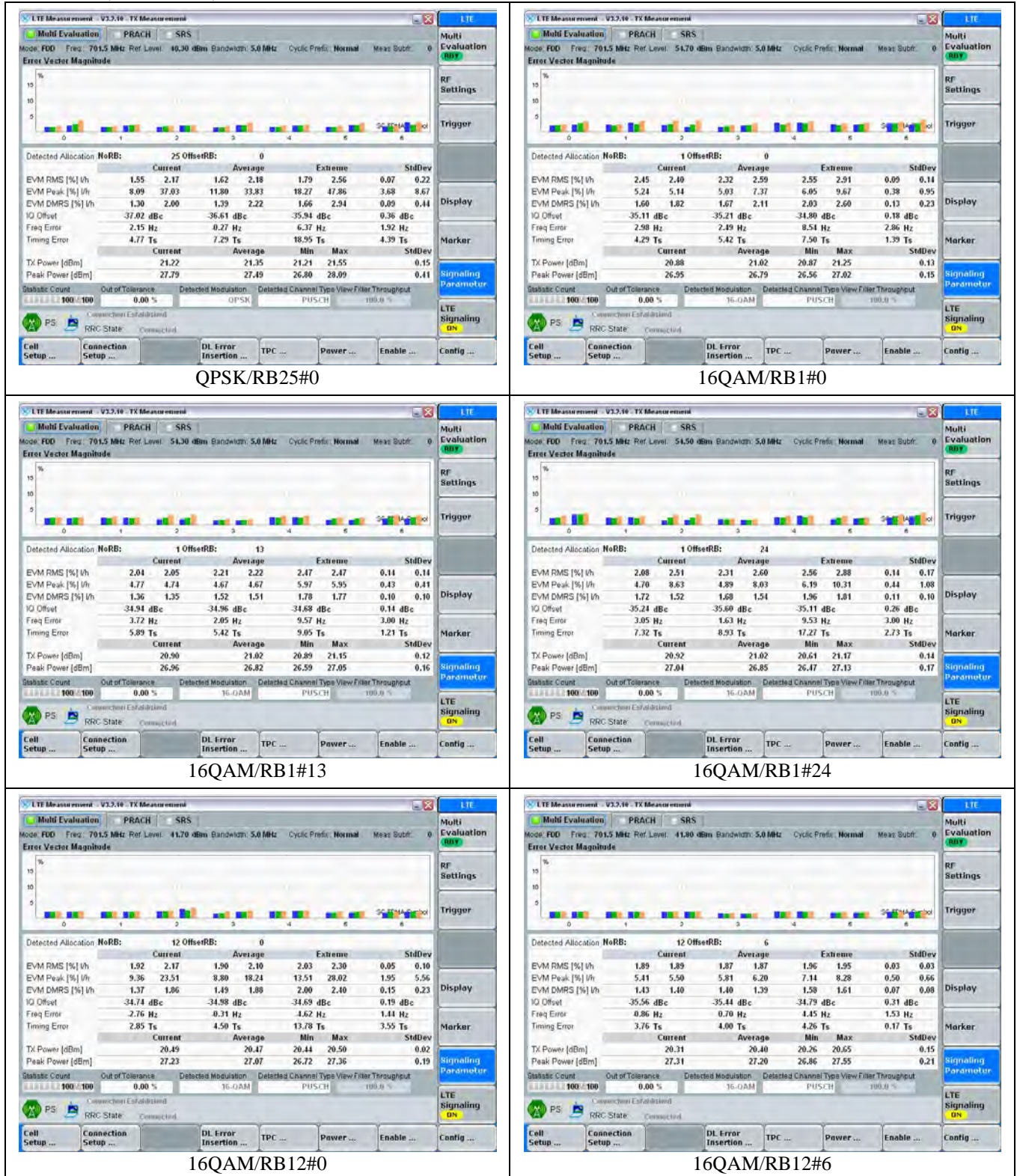

* CH:23035(701.50 MHz)

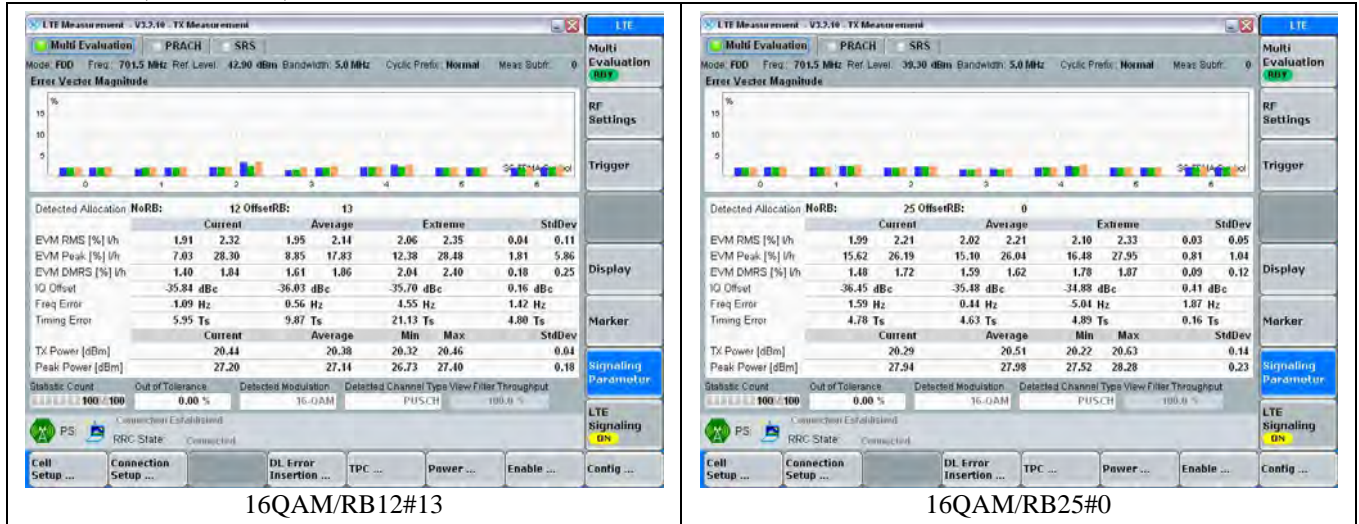

* CH:23095(707.50 MHz)

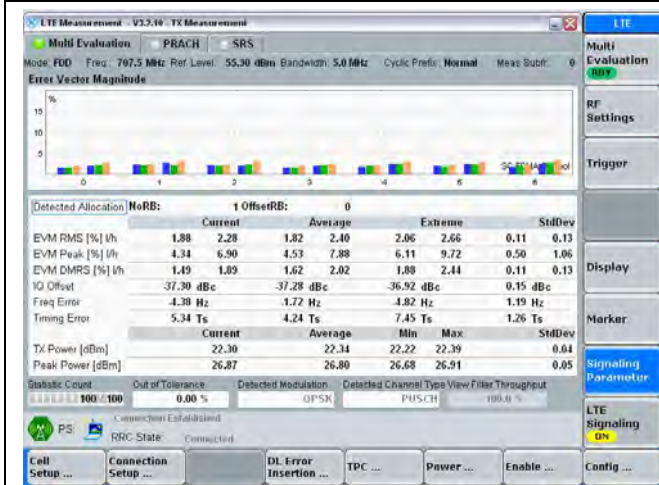

QPSK/RB1#0

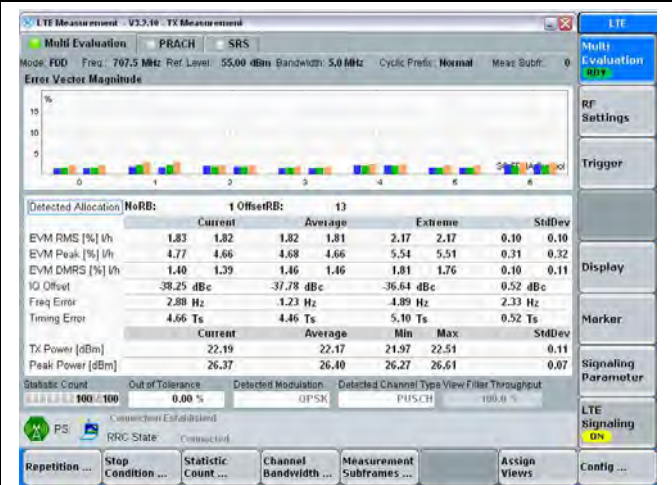

QPSK/RB1#13

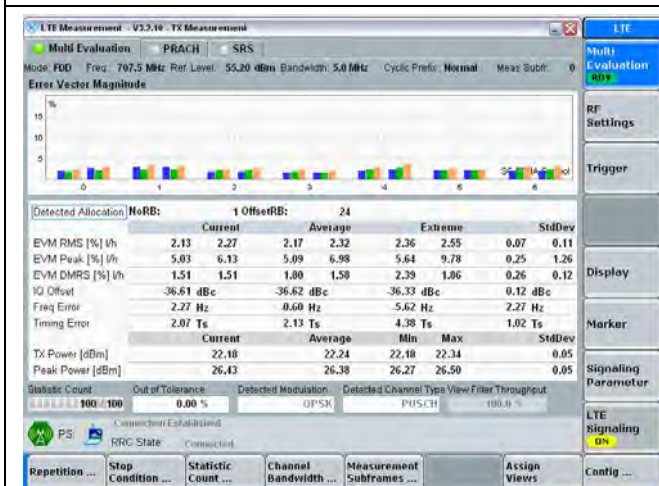

QPSK/RB1#24

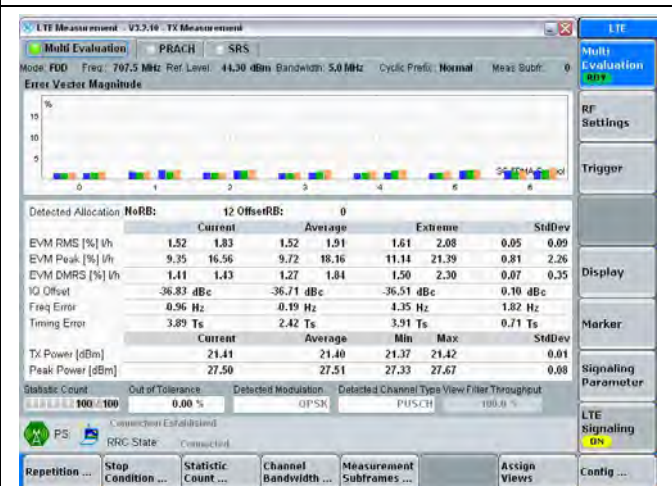

QPSK/RB12#0

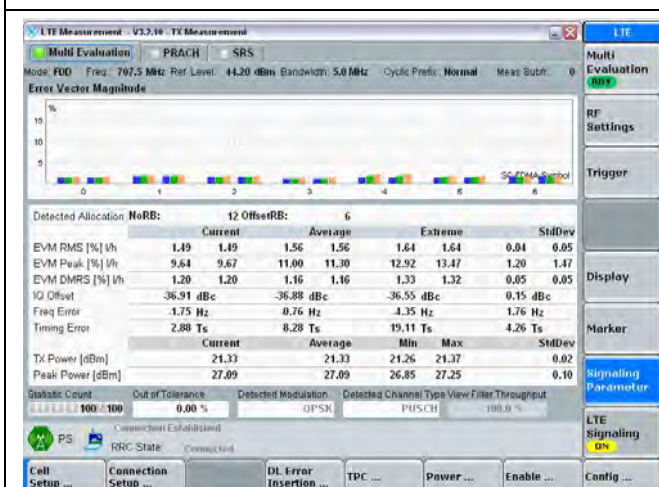

QPSK/RB12#6

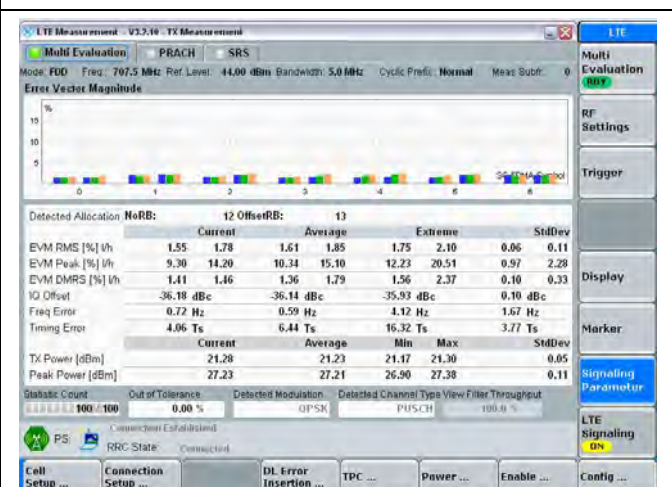

QPSK/RB12#13

* CH:23095(707.50 MHz)

<p>QPSK/RB25#0</p>	<p>16QAM/RB1#0</p>
<p>16QAM/RB1#13</p>	<p>16QAM/RB1#24</p>
<p>16QAM/RB12#0</p>	<p>16QAM/RB12#6</p>

* CH:23095(707.50 MHz)

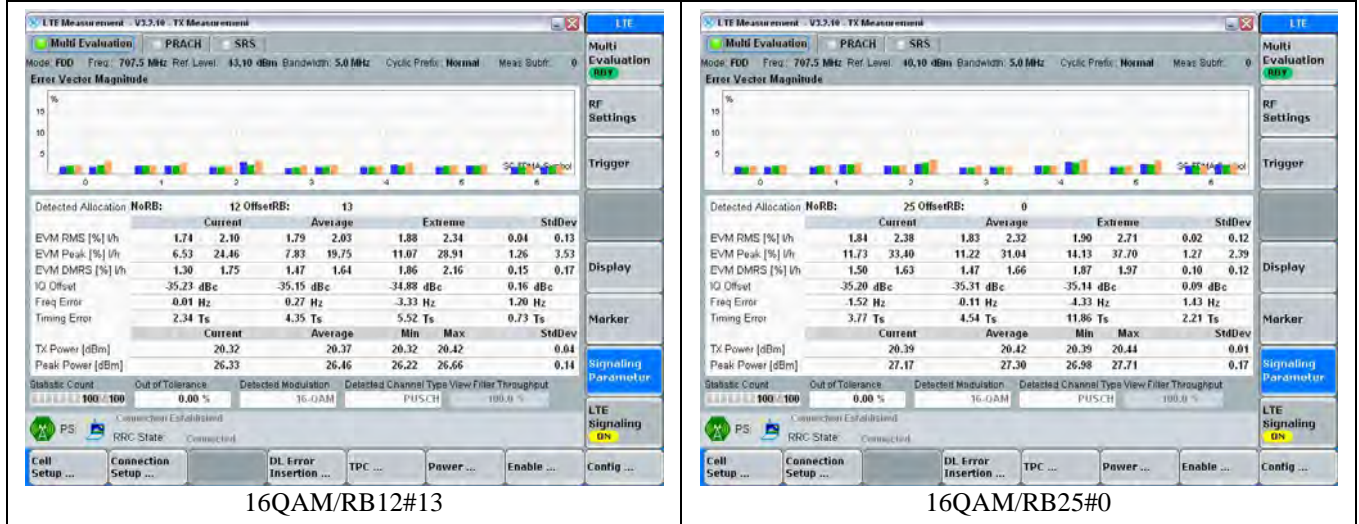

* CH:23155(713.50 MHz)

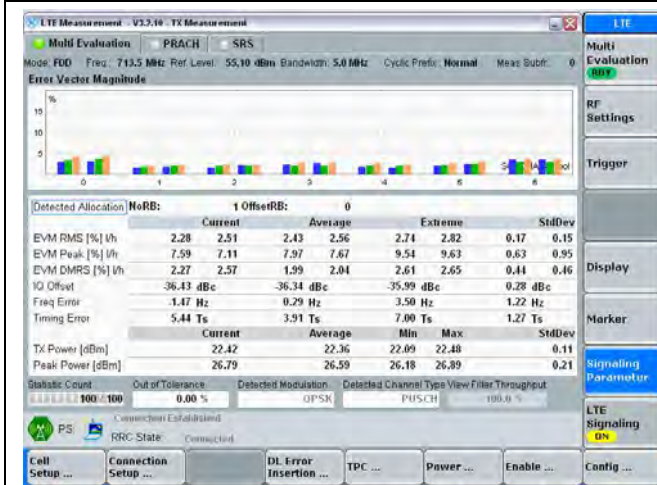

QPSK/RB1#0

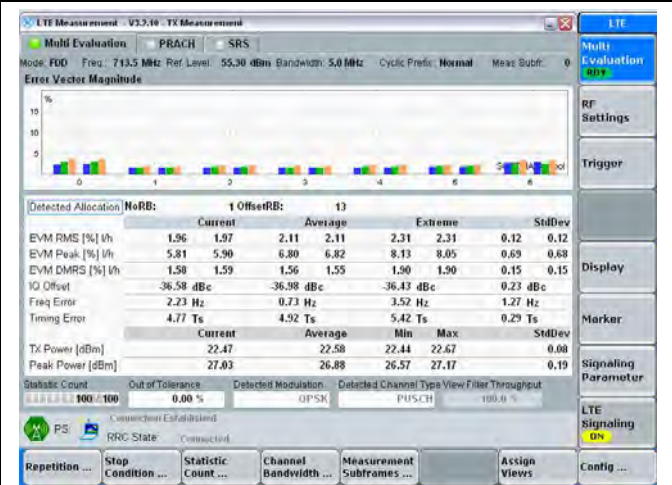

QPSK/RB1#13

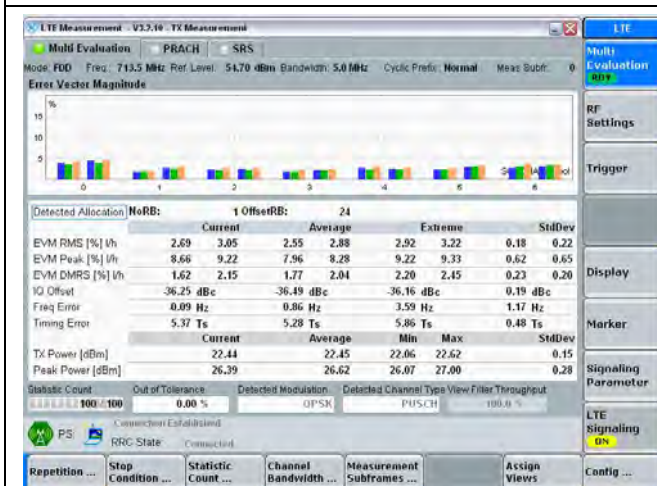

QPSK/RB1#24

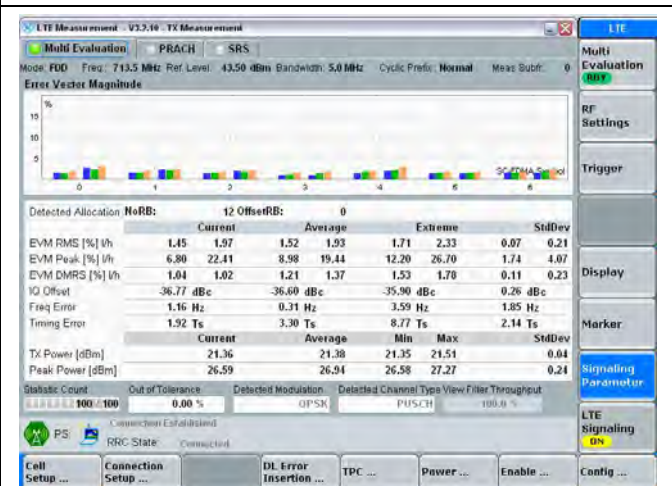

QPSK/RB12#0

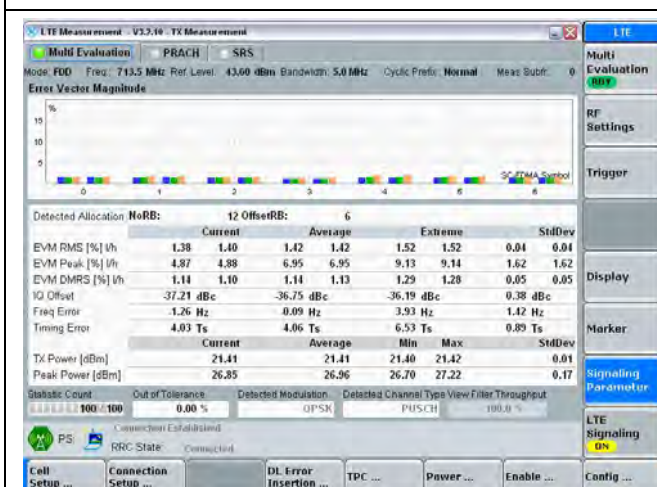

QPSK/RB12#6

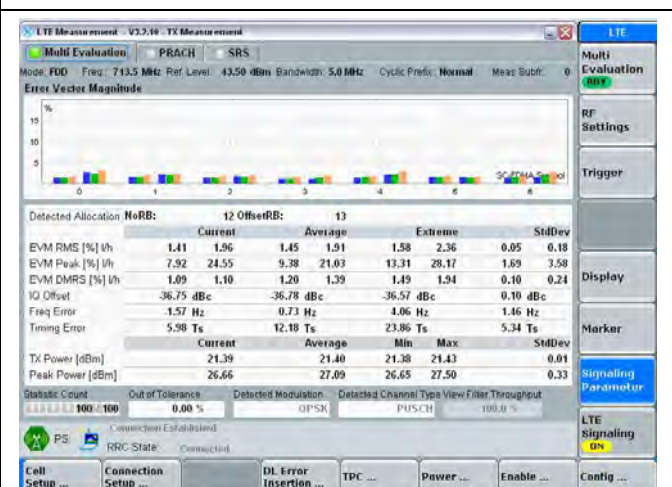

QPSK/RB12#13

* CH:23155(713.50 MHz)

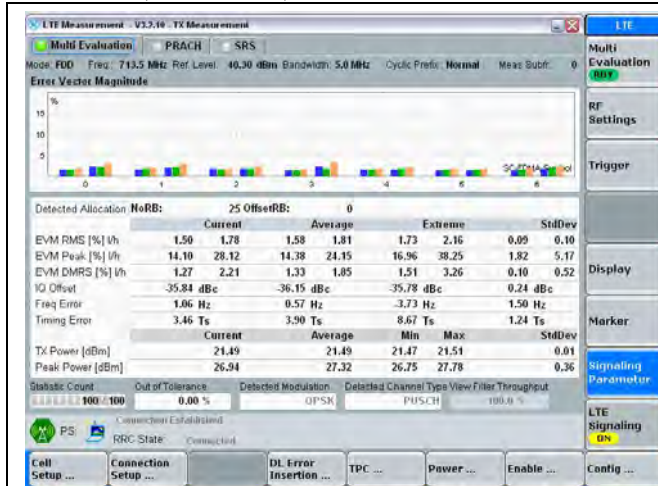

QPSK/RB25#0

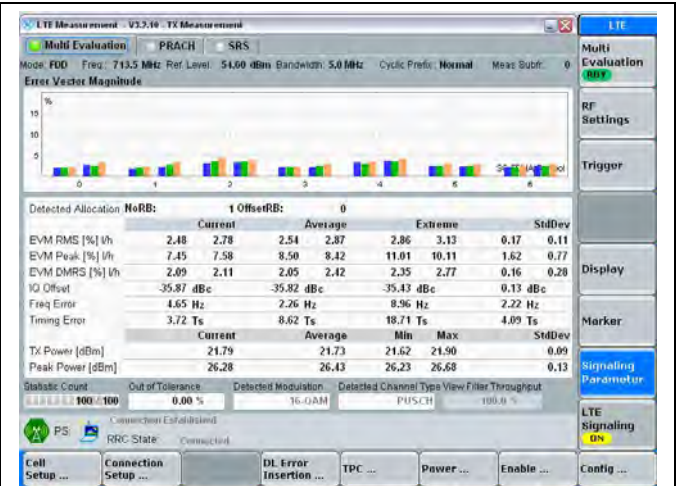

16QAM/RB1#0

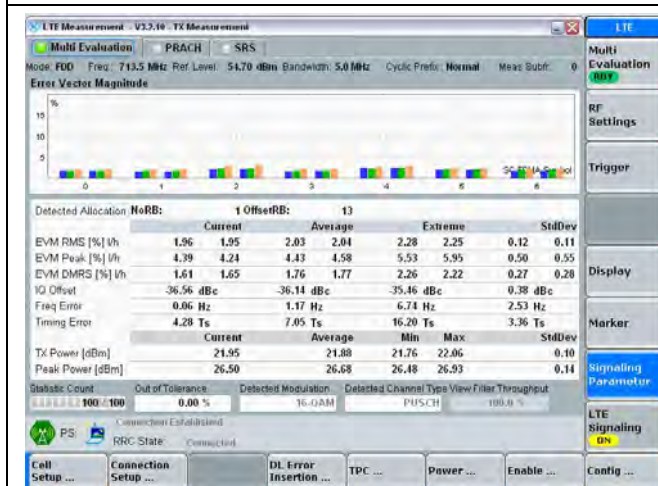

16QAM/RB1#13

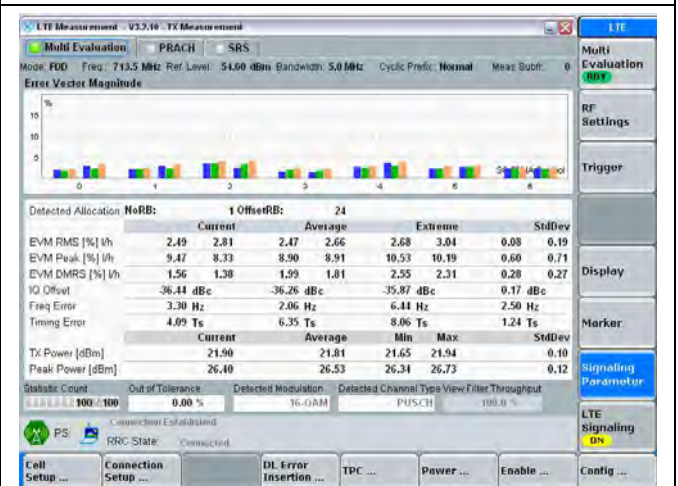

16QAM/RB1#24



16QAM/RB12#0

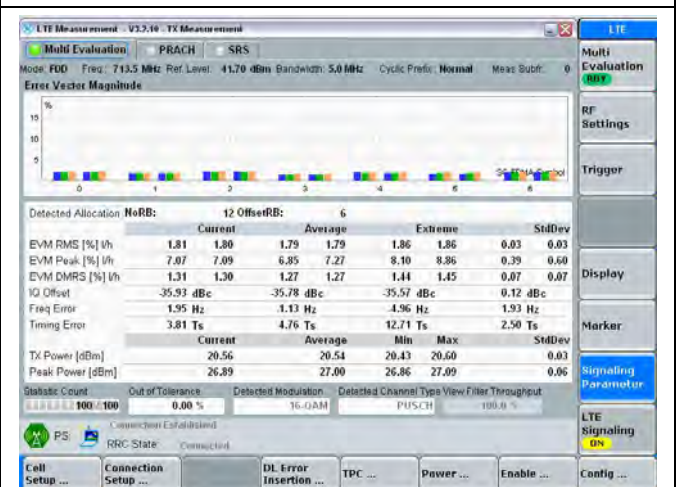

16QAM/RB12#6

* CH:23155(713.50 MHz)

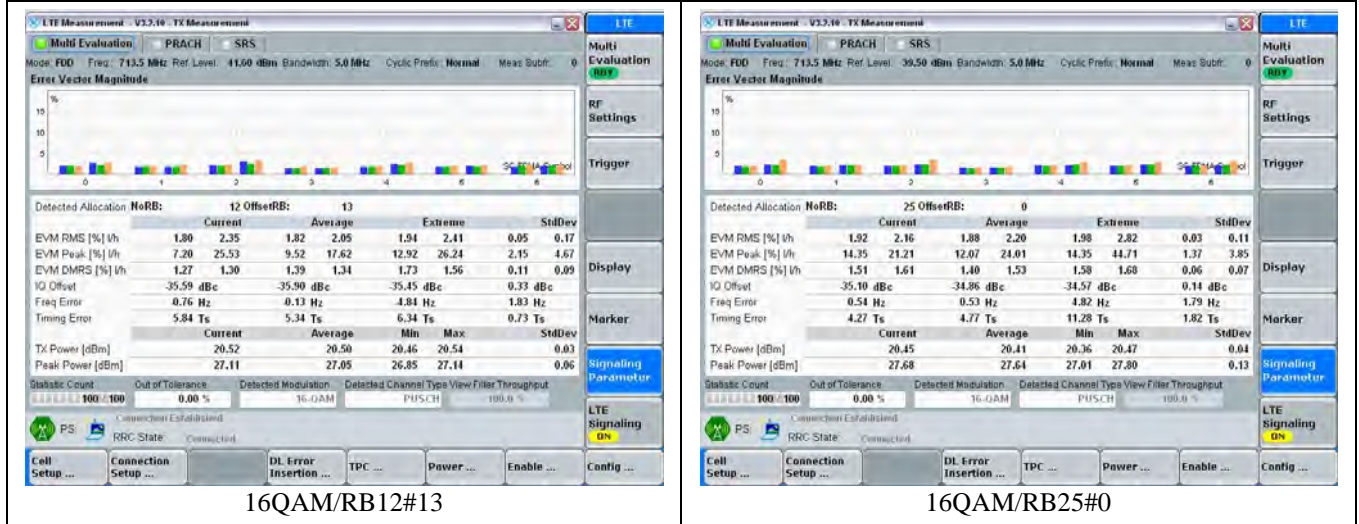

7. Effective Radiated Power

7.1 Test Procedure

- a. All measurements were done at low, middle and high operational frequency range. RBW and VBW is 10MHz for LTE Band 12.(Spectrum analyzer not support 5 MHz, so used RBW=VBW=10 MHz)
- b. Substitution method is used for ERP measurement. In the open-site chamber, EUT placed on the 0.8m height of Turn Table, rotated the table around 360 degrees to search the maximum radiation power and receiver antenna shall be rotated vertical and horizontal polarization and moved height from 1m to 4m to find the maximum polar radiated power. The “Read Value” is the spectrum reading the maximum power value.
- c. The substitution Dipole antenna is substituted for EUT at the same position and signals generator export the CW signal to the substitution antenna via a tx cable. Rotated the Turn Table and moved receiving antenna to find the maximum radiation power. Adjust output power level of S.G to get a Value of spectrum reading equal to “Read Value” of step b. Record the power level of S.G
- d. ERP = Output power level of S.G – TX cable loss + Antenna gain of substitution Dipole

* This device was tested under all configurations and the highest power is reported. Also, we have done XY, YZ, ZX planes in EUT and horizontal and vertical polarization in detecting antenna.

* The worst case of LTE Band 12 is

QPSK Modulation : RB1#0

16QAM Modulation : RB1#0

* Configuration : refer to 5.3 chapter.

* Simulator call mode : all bit up(Max Power)

7.2 Test Result

Modulation	Resource Block Size	Resource Block Offset	Low ch :	Mid ch :	High ch :
			23035	23095	23155
			Freq(MHz) :	Freq(MHz) :	Freq(MHz) :
			701.50	707.50	713.50
QPSK	1	0	0.241 W (23.82dBm)	0.224 W (23.50 dBm)	0.220 W (23.42 dBm)
16QAM	1	0	0.201 W (23.03 dBm)	0.213 W (23.29 dBm)	0.195 W (22.90 dBm)

7.3 Test Criteria

The ERP of mobile transmitters and auxiliary test transmitters must not exceed 3 Watts.

7.3 Test Result

7.3.1 XY SCAN

MODE	CH /FREQ		Polar	SCAN	Measured Level	Measured Level	Substitute Level	ANT Gain	Cable Loss	ERP	
	CHANNEL	FREQ (MHz)								Hor/Ver	X,Y,Z
QPSK / RB 1#0	23035	701.50	V	XY	97.31	-9.69	35.42	-9.99	1.77	0.233	23.66
	23095	707.50		XY	96.81	-10.19	35.04	-9.98	1.78	0.213	23.29
	23155	713.50		XY	95.46	-11.54	33.67	-9.97	1.78	0.156	21.92
QPSK / RB 1#0	23035	701.50	H	XY	85.01	-21.99	22.14	-9.99	1.77	0.011	10.38
	23095	707.50		XY	84.96	-22.04	22.55	-9.98	1.78	0.012	10.80
	23155	713.50		XY	84.54	-22.46	22.57	-9.97	1.78	0.012	10.82
16-QAM / RB 1#0	23035	701.50	V	XY	96.84	-10.16	34.95	-9.99	1.77	0.209	23.19
	23095	707.50		XY	96.59	-10.41	34.82	-9.98	1.78	0.203	23.07
	23155	713.50		XY	95.01	-11.99	33.22	-9.97	1.78	0.140	21.47
16-QAM / RB 1#0	23035	701.50	H	XY	84.45	-22.55	21.58	-9.99	1.77	0.010	9.82
	23095	707.50		XY	84.26	-22.74	21.85	-9.98	1.78	0.010	10.10
	23155	713.50		XY	84.23	-22.77	22.26	-9.97	1.78	0.011	10.51

7.3.2 YZ SCAN

MODE	CH /FREQ		Polar	SCAN	Measured Level	Measured Level	Substitute Level	ANT Gain	Cable Loss	ERP	
	CHANNEL	FREQ (MHz)								Hor/Ver	X,Y,Z
QPSK / RB 1#0	23035	701.50	V	YZ	89.21	-17.79	27.32	-9.99	1.77	0.036	15.56
	23095	707.50		YZ	88.84	-18.16	27.07	-9.98	1.78	0.034	15.32
	23155	713.50		YZ	88.26	-18.74	26.47	-9.97	1.78	0.030	14.72
QPSK / RB 1#0	23035	701.50	H	YZ	96.59	-10.41	33.72	-9.99	1.77	0.157	21.96
	23095	707.50		YZ	96.56	-10.44	34.15	-9.98	1.78	0.174	22.40
	23155	713.50		YZ	95.40	-11.60	33.43	-9.97	1.78	0.147	21.68
16-QAM / RB 1#0	23035	701.50	V	YZ	76.97	-30.03	15.08	-9.99	1.77	0.002	3.32
	23095	707.50		YZ	79.84	-27.16	18.07	-9.98	1.78	0.004	6.32
	23155	713.50		YZ	76.08	-30.92	14.29	-9.97	1.78	0.002	2.54
16-QAM / RB 1#0	23035	701.50	H	YZ	96.04	-10.96	33.17	-9.99	1.77	0.139	21.41
	23095	707.50		YZ	96.47	-10.53	34.06	-9.98	1.78	0.170	22.31
	23155	713.50		YZ	95.31	-11.69	33.34	-9.97	1.78	0.144	21.59

7.3.3 ZX SCAN

MODE	CH /FREQ		Polar	SCAN	Measured Level	Measured Level	Substitute Level	ANT Gain	Cable Loss	ERP	
	CHANNEL	FREQ (MHz)	Hor/Ver	X,Y,Z	(dBuV)	(dBm)	(dBm)	(dB)	(dB)	W	dBm
QPSK / RB 1#0	23035	701.50	V	ZX	91.13	-15.87	29.24	-9.99	1.77	0.056	17.48
	23095	707.50		ZX	90.00	-17.00	28.23	-9.98	1.78	0.044	16.48
	23155	713.50		ZX	89.97	-17.03	28.18	-9.97	1.78	0.044	16.43
QPSK / RB 1#0	23035	701.50	H	ZX	98.45	-8.55	35.58	-9.99	1.77	0.241	23.82
	23095	707.50		ZX	97.66	-9.34	35.25	-9.98	1.78	0.224	23.50
	23155	713.50		ZX	97.14	-9.86	35.17	-9.97	1.78	0.220	23.42
16-QAM / RB 1#0	23035	701.50	V	ZX	90.55	-16.45	28.66	-9.99	1.77	0.049	16.90
	23095	707.50		ZX	90.00	-17.00	28.23	-9.98	1.78	0.044	16.48
	23155	713.50		ZX	90.00	-17.00	28.21	-9.97	1.78	0.044	16.46
16-QAM / RB 1#0	23035	701.50	H	ZX	97.66	-9.34	34.79	-9.99	1.77	0.201	23.03
	23095	707.50		ZX	97.45	-9.55	35.04	-9.98	1.78	0.213	23.29
	23155	713.50		ZX	96.62	-10.38	34.65	-9.97	1.78	0.195	22.90

8. Peak to Average Ratio

8.1 Test Procedure

A peak to average ratio measurement is performed at the conducted port of the EUT. For CDMA and WCDMA signals, the spectrum analyzers Complementary Cumulative Distribution Function (CCDF) measurement profile is used to determine the largest deviation between the average and the peak power of the EUT in a given bandwidth. The CCDF curve shows how much time the peak waveform spends at or above a given average power level. The percent of time the signal spends at or above the level defines the probability for that particular power level.

- a. Set resolution/measurement bandwidth \geq signal's occupied bandwidth
- b. Set the number of counts to a value that stabilizes the measured CCDF curve

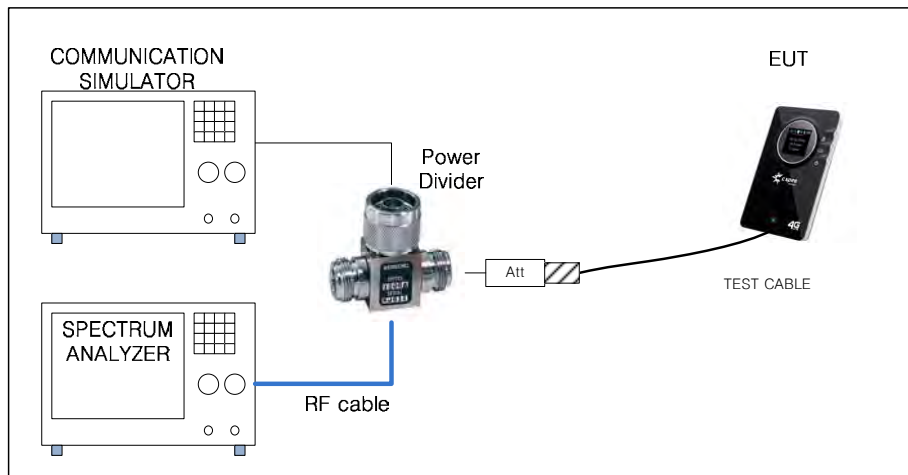

* Simulator call mode : all bit up

* TEST Cable : Connect LTE Antenna PORT (0.3dB loss / 30 cm / MCX to SMA Cable)

* RF Cable : HUBER+SHUNER / SUCOFLEX 104 / DC-18 GHz / 1.0 m

* Attenuator : 10 dB (Weinshel /56-10/ DC-28 GHz) + 10 dB(Weinshel / 56-10 / DC-28 GHz)

* Power Divider : WEINSCHEL / 1506A / DC-18 GHz / 3 Port

* Path Loss Information

Frequency (MHz)	RF Cable (dB)	10 dB ATT (dB)	10 dB ATT (dB)	Power Diver (dB)	Test Cable (dB)	Total Loss (dB)
707.50	0.26	9.58	9.58	5.77	0.30	25.49

8.2 Test Result

Unit : dB

Modulation	Resource Block Size	Resource Block Offset	Low ch :	Mid ch :	High ch :
			23035	23095	23155
			Freq(MHz) :	Freq(MHz) :	Freq(MHz) :
			701.50	707.50	713.50
QPSK	1	0	4.93	4.88	4.49
16QAM	1	0	6.14	5.77	5.60

8.3 Test Criteria

In measuring transmissions in this band using an average power technique, the peak to average ratio of the transmission may not exceed 13 dB (associated with a probability of 0.1%)

8.4 Test Plots



9. Modulation Characteristics

9.1 Definition

Other types of equipment. A curve or equivalent data which shows that the equipment will meet the modulation requirements of the rules under which the equipment is to be licensed.

9.2 Test Procedure

The measurement frequency is center channel(23095)

It measured RB 25#0 both QPSK and 16QAM Modulation(worst case)

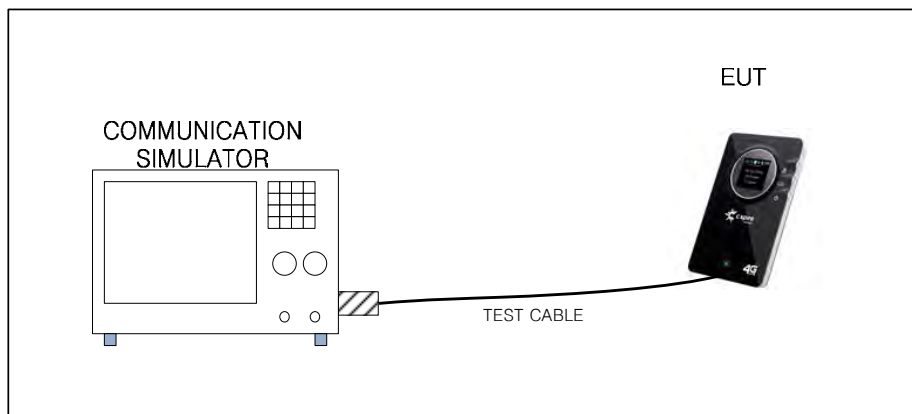

9.4 Test Plots

* CH:23095 (707.50 MHz)

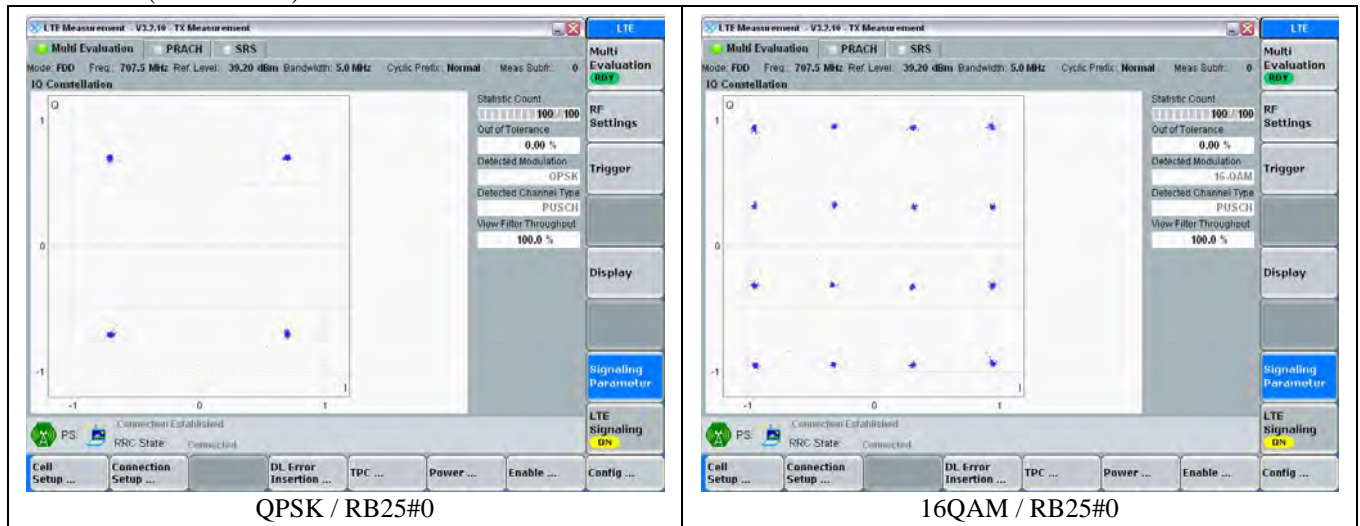

10. Occupied Bandwidth

10.1 Definition

The occupied bandwidth, that is the frequency bandwidth such that, below its lower and above its upper frequency limits, the mean powers radiated are each equal to 0.5 percent of the total mean power radiated by a given emission shall be measured under the following conditions as applicable:

10.2 Test Procedure

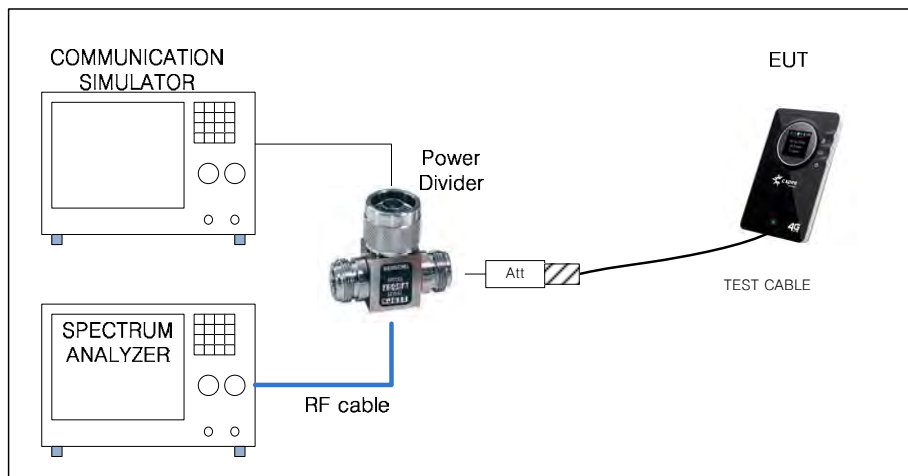

* Simulator call mode : all bit up

* TEST Cable : Connect LTE Antenna PORT (0.3dB loss / 30 cm / MCX to SMA Cable)

* RF Cable : HUBER+SHUNER / SUCOFLEX 104 / DC-18 GHz / 1.0 m

* Attenuator : 10 dB (Weinshel / 56-10/ DC-28 GHz) + 10 dB(Weinshel / 56-10 / DC-28 GHz)

* Power Divider : WEINSCHEL / 1506A / DC-18 GHz / 3 Port

* Path Loss Information

Frequency (MHz)	RF Cable (dB)	10 dB ATT (dB)	10 dB ATT (dB)	Power Diver (dB)	Test Cable (dB)	Total Loss (dB)
707.50	0.26	9.58	9.58	5.77	0.30	25.49

10.3 Test Result

Unit : MHz

Modulation	Resource Block Size	Resource Block Offset	Low ch :	Mid ch :	High ch :
			23035	23095	23155
			Freq(MHz) :	Freq(MHz) :	Freq(MHz) :
			701.50	707.50	713.50
QPSK	25	0	4.486	4.507	4.494
16QAM	25	0	4.504	4.502	4.512

10.4 Test Plots

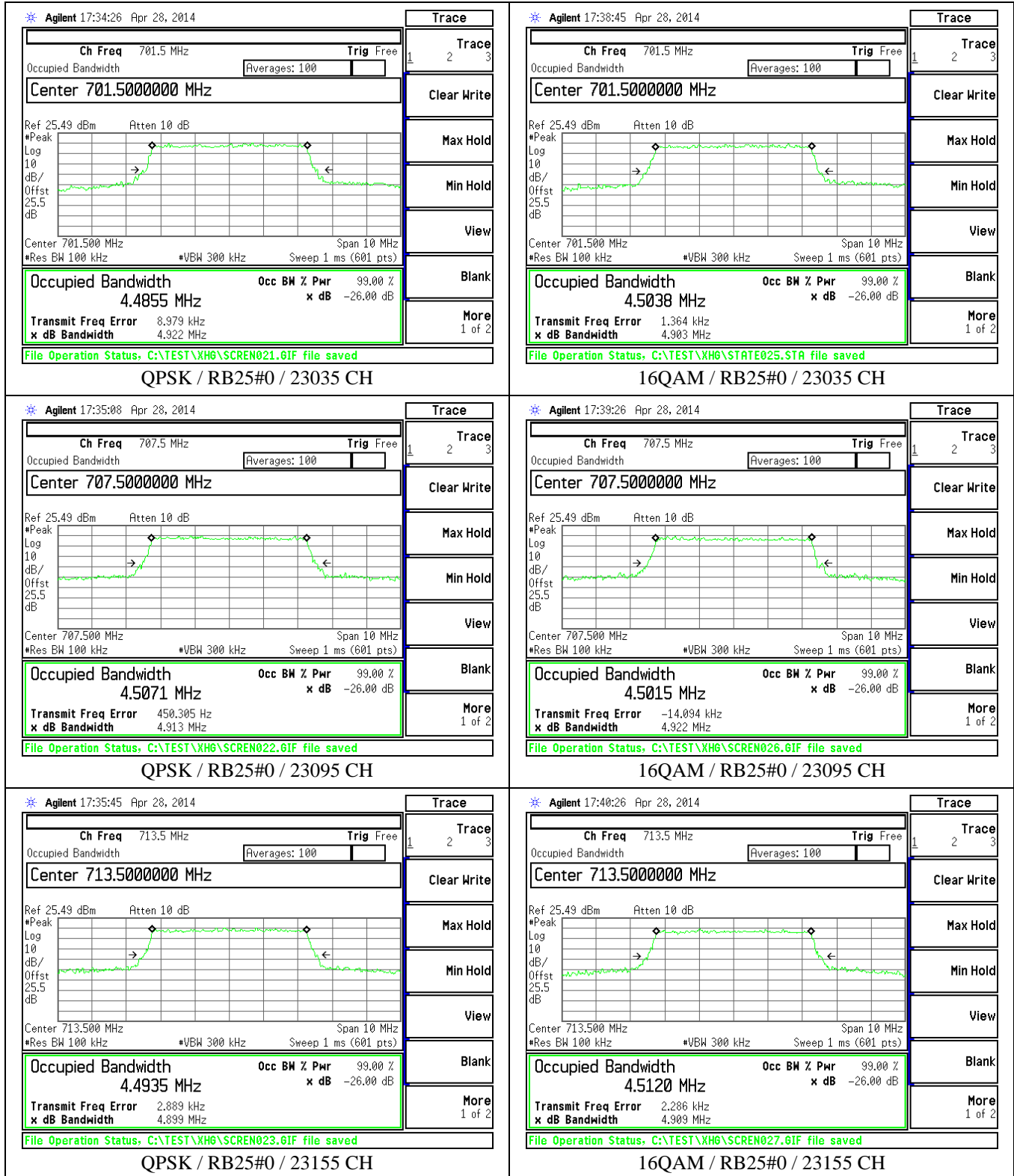

11. Band Edge Compliance

11.1 Definition

Power of any emission outside of the authorized operating frequency ranges must be attenuated below the transmitting power (P) by a factor of at least $43 + 10 \log(P)$ dB. In the 1 MHz bands immediately outside and adjacent to the frequency block a resolution bandwidth of at least one percent of the emission bandwidth of the fundamental emission of the transmitter may be employed. The emission limit equal to -13dBm .

11.2 Test Procedure

- All measurements were done at low and high operational frequency range.
- The center frequency of spectrum is the band edge frequency and span is 1 MHz. The RBW of the spectrum is 100 KHz and the VBW of the spectrum is 300 KHz.
- Record the max trace plot into the test report.

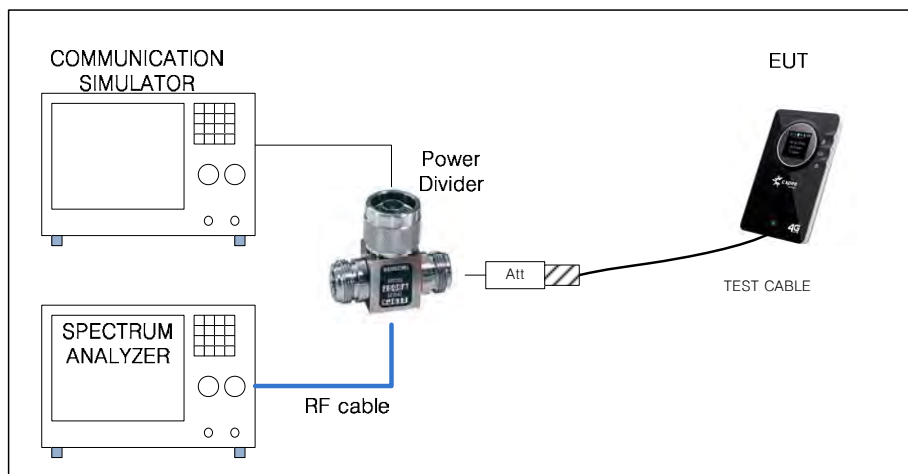

* Simulator call mode : all bit up(Max Power)

* TEST Cable : Connect LTE Antenna PORT (0.3dB loss / 30 cm / MCX to SMA Cable)

* RF Cable : HUBER+SHUNER / SUCOFLEX 104 / DC-18 GHz / 1.0 m

* Attenuator : 10 dB (Weinshel /56-10/ DC-28 GHz) + 10 dB(Weinshel / 56-10 / DC-28 GHz)

* Power Divider : WEINSCHTEL / 1506A / DC-18 GHz / 3 Port

* Path Loss Information

Frequency (MHz)	RF Cable (dB)	10 dB ATT (dB)	10 dB ATT (dB)	Power Diver (dB)	Test Cable (dB)	Total Loss (dB)
707.50	0.26	9.58	9.58	5.77	0.30	25.49

11.3 Test Criteria

At least -13 dBm below.

11.4 Test Result

Unit :dBm

Modulation	Resource Block Size	Resource Block Offset	Low ch : 23035	RBW / VBW / SPAN	High ch : 23155
			Freq(MHz) : 701.50		Freq(MHz) : 713.50
QPSK	CENTER FREQUENCY		699 MHz	-	716 MHz
	1	0	-15.92	100K/ 300K/ 6M	-54.85
	1	24	-55.06	100K/ 300K/ 6M	-15.43
	25	0	-23.13	100K/ 300K/ 6M	-23.67
16QAM	CENTER FREQUENCY		699 MHz	-	716 MHz
	1	0	-15.99	100K/ 300K/ 6M	-55.03
	1	24	-55.36	100K/ 300K/ 6M	-15.84
	25	0	-23.51	100K/ 300K/ 6M	-23.55

11.5 Test Plots

* QPSK Modulation

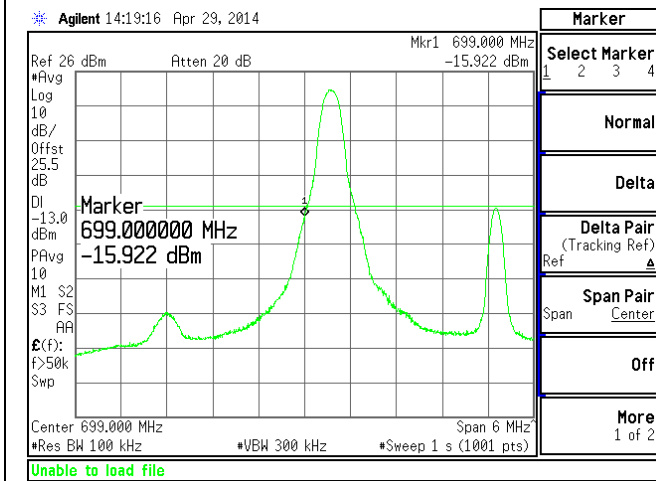

RB1#0 / 23035 CH

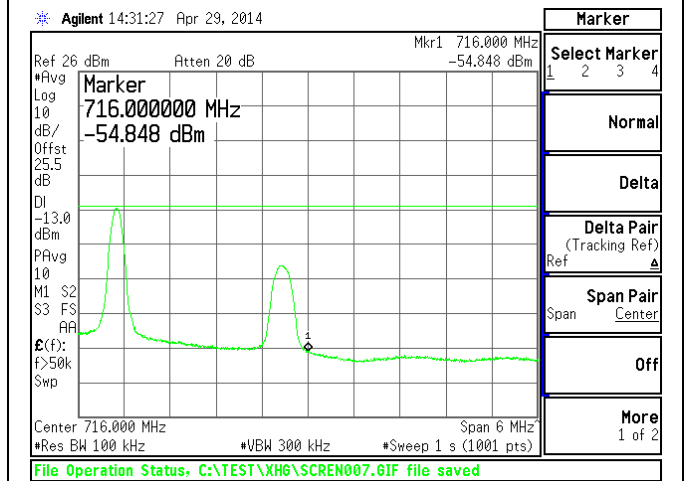

RB1#0 / 23155 CH

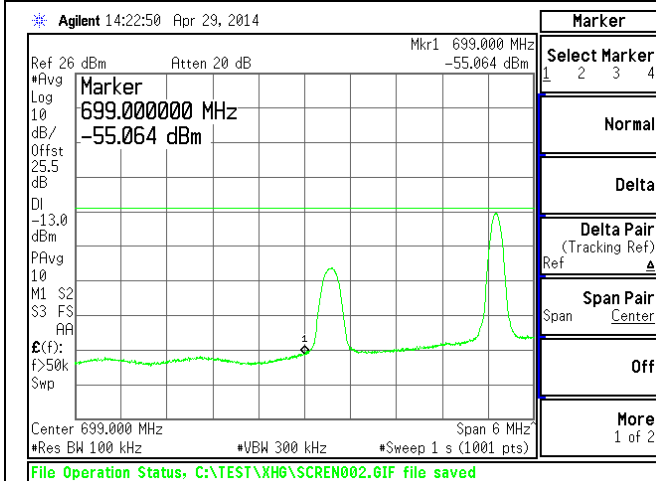

RB1#24 / 23035 CH

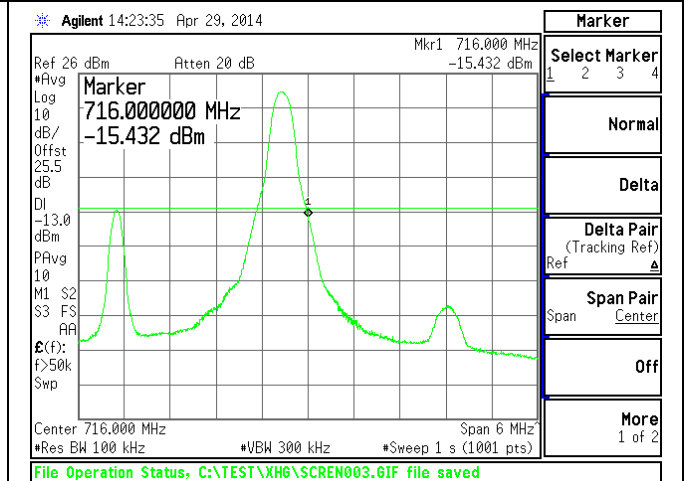

RB1#24 / 23155 CH

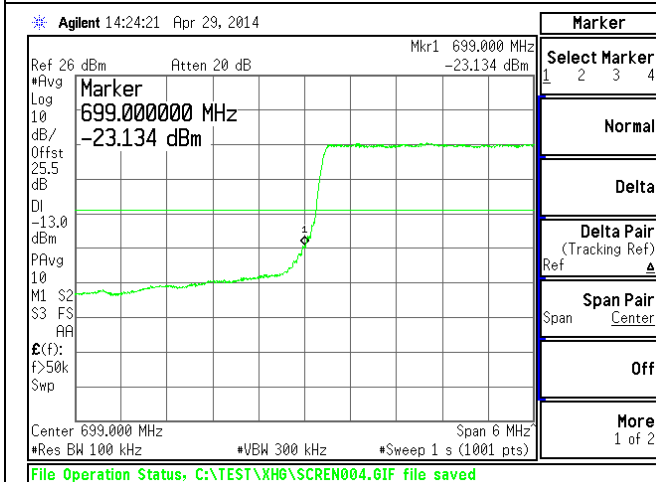

RB25#0 / 23035 CH

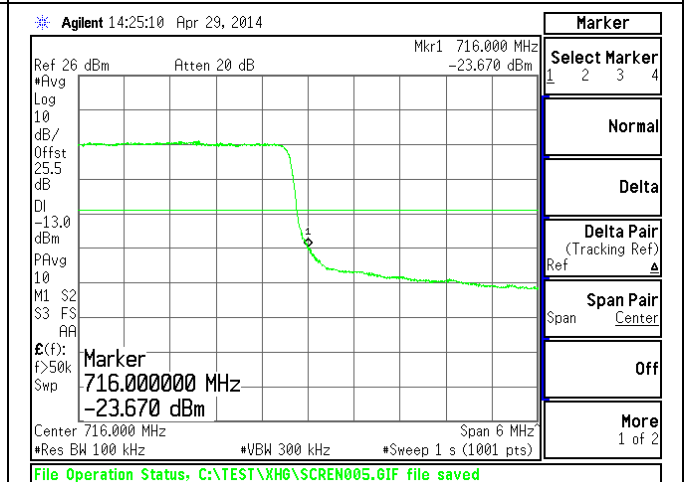

RB25#0 / 23155 CH

* 16QAM Modulation

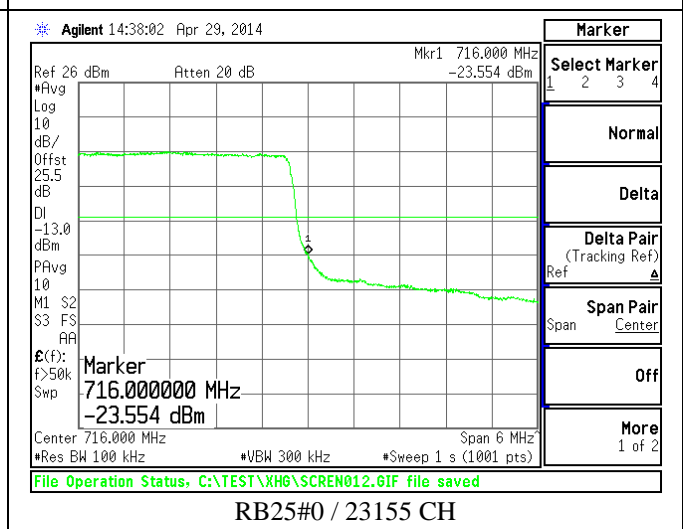
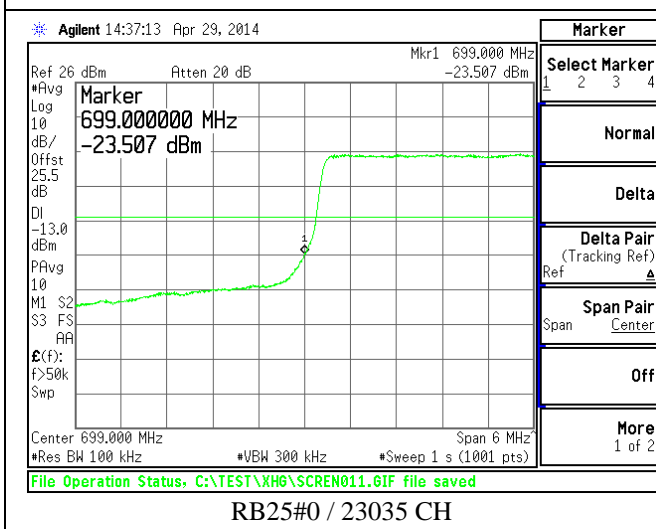
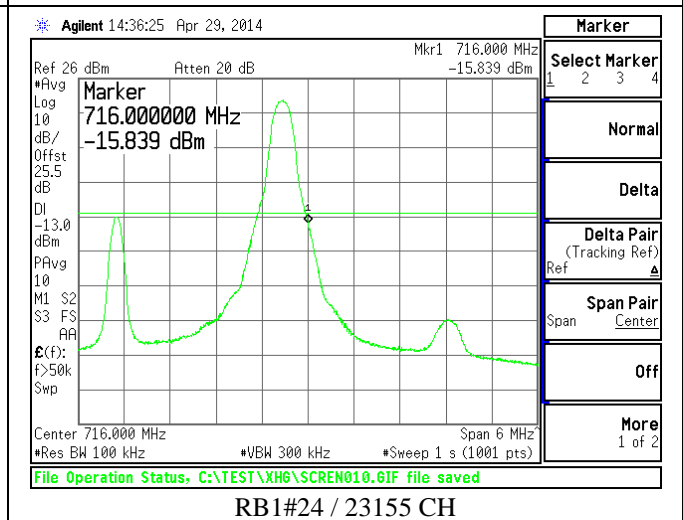
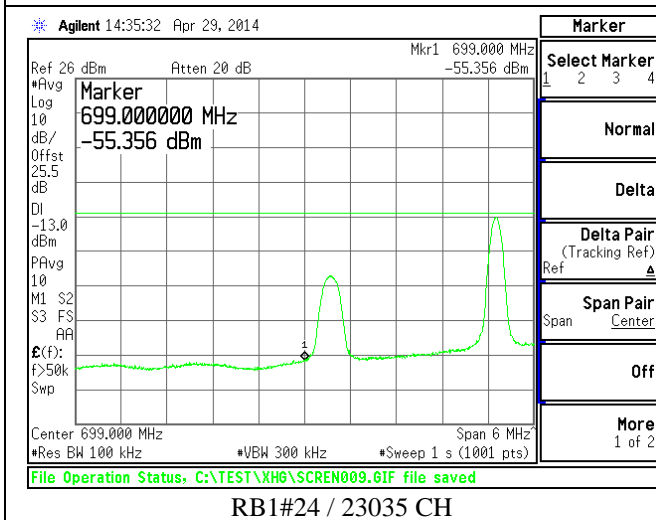
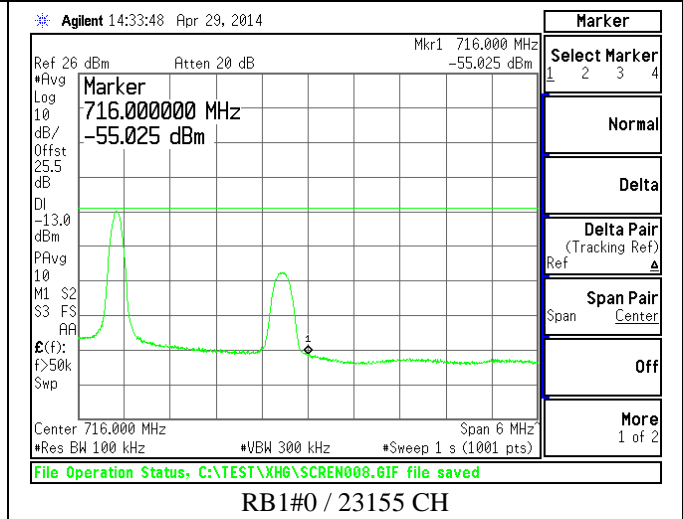
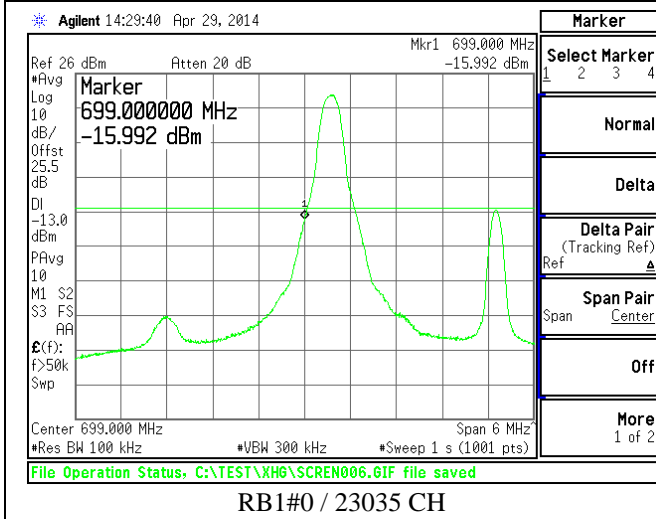

12. Spurious Emission at Antenna Terminals

12.1 Definition

The power of any emission outside of the authorized operating frequency ranges must be attenuated below the transmitting power (P) by a factor of at least $43 + 10 \log(P)$ dB. The emission limit equal to -13 dBm.

12.2 Test Procedure

- The EUT makes a phone call to the communication simulator. All measurements were done at middle frequency range.
- Measuring frequency range is from 30 MHz to 20GHz. The RBW=1MHz and VBW=3MHz is used for conducted emission measurement.(correct frequency attenuation level)
- Record the max trace plot into the test report.

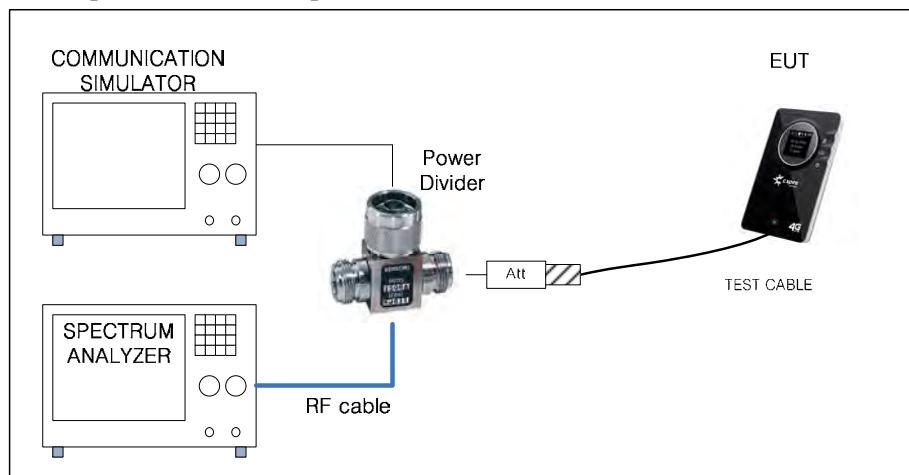

* Simulator call mode : all bit up(Max Power)

* TEST Cable : Connect LTE Antenna PORT (0.3dB loss / 30 cm / MCX to SMA Cable)

* RF Cable : HUBER+SHUNER / SUCOFLEX 104 / DC-18 GHz / 1.0 m

* Attenuator : 10 dB (Weinshel /56-10/ DC-28 GHz) + 10 dB(Weinshel / 56-10 / DC-28 GHz)

* Power Divider : WEINSCHTEL / 1506A / DC-18 GHz / 3 Port

* Path Loss Information

Frequency (MHz)	RF Cable (dB)	10 dB ATT (dB)	10 dB ATT (dB)	Power Diver (dB)	Test Cable (dB)	Total Loss (dB)
707.50	0.26	9.58	9.58	5.77	0.30	25.49
1 409.90	0.39	9.61	9.60	5.78	0.30	25.68
1 412.40	0.39	9.61	9.60	5.78	0.30	25.68
1 419.70	0.39	9.61	9.60	5.78	0.30	25.68
1 422.10	0.39	9.61	9.60	5.78	0.30	25.68

12.3 Test Result

Unit : dBm

CH : 23095			FREQUENCY : 707.50 MHz			
Modulation	Resource Block Size	Resource Block Offset	Reading (dBm)	Measured Freq.(MHz)	Correct (Att, cable)	Result
QPSK	1	0	-53.94	1 409.90	0.19	-53.75
	1	24	-53.29	1 419.70	0.19	-53.10
	25	0	-57.35	1 422.10	0.19	-57.16
16QAM	1	0	-54.16	1 409.90	0.19	-53.97
	1	24	-53.57	1 419.70	0.19	-53.38
	25	0	-57.10	1 412.40	0.19	-56.91

12.4 Test Plots

* CH: 23095 (707.50 MHz)

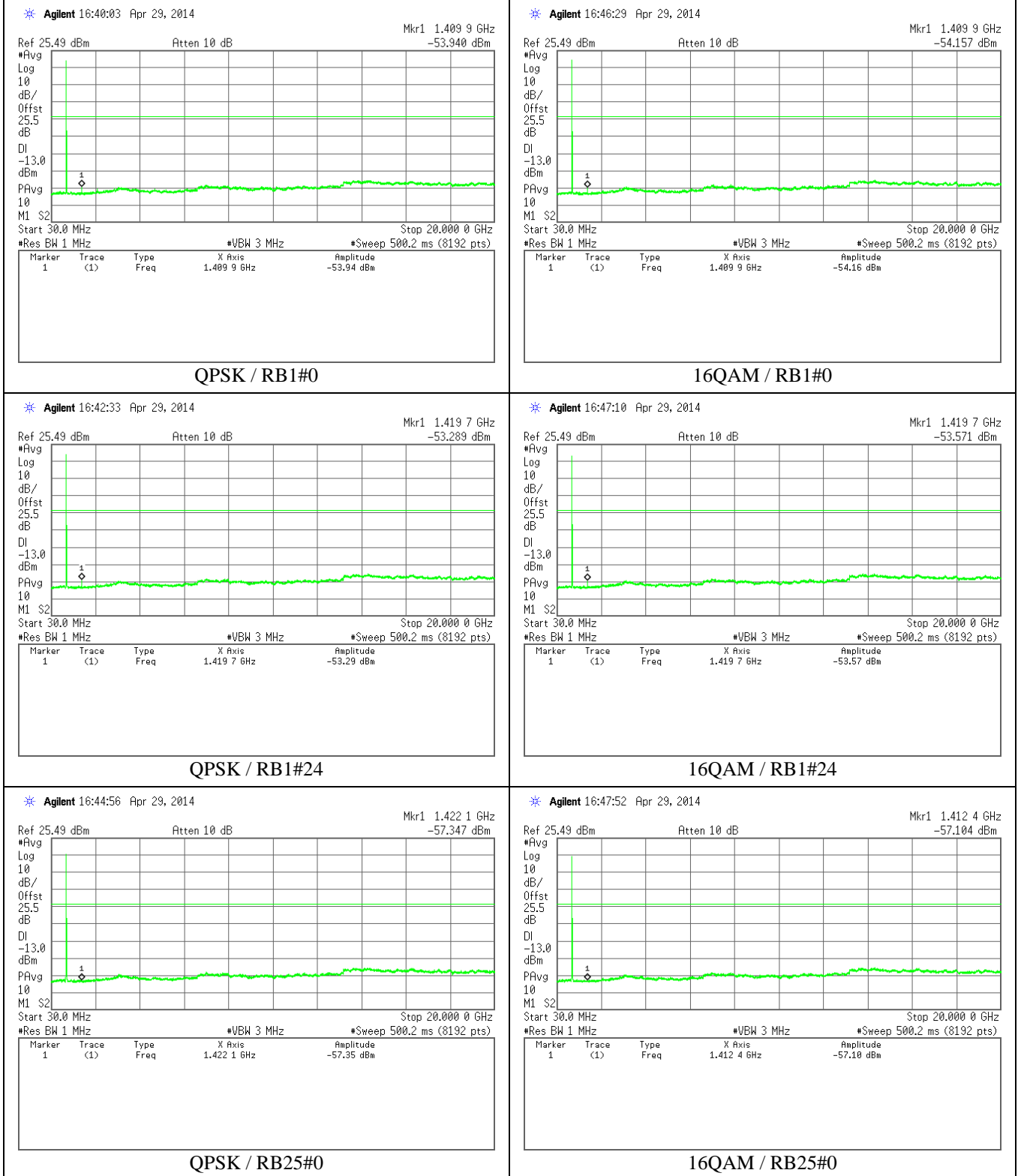

13. Field Strength of Spurious Radiation

13.1 Definition

The power of any emission outside of the authorized operating frequency ranges must be attenuated below the transmitting power (P) by a factor of at least $43 + 10 \log(P)$ dB. The emission limit equal to -13 dBm

13.2 Test Procedure

The EUT was placed on a non-conductive table 0.8 meters above the ground plane. The table was centered on a rotating turntable at a distance of 3 meters from the measurement antenna.

For spurious emissions below 1 GHz quasi-peak detection is used with a resolution bandwidth of 120 kHz. The emissions were maximized by rotating the EUT and raising and lowering the measurement antenna from 1~4 meters (above 1 GHz, measure antenna from 1 ~ 3.5 meters)

Spurious/harmonic emissions above 1 GHz peak are measured with average and peak detection with a resolution bandwidth of 1 MHz (VBW = 3 MHz) and measured at a distance of 3 meter.

Average detection is used to determine compliance of the EUT if the peak does not meet the average limit. Non-harmonic emissions must satisfy the average limit and the peak limit (20 dB above average).

Correction factor is a combination of cable loss (CL), microwave amplifier gain (G amp), antenna factor (AF), hi-pass filter factor (HPF)

Example correction factor calculation: $F/S(\text{Field Strength}) = \text{Measuring Value} + \text{AF} - \text{G amp} + \text{CL} + \text{HPF}$

* Hi-Pass Filter : WAINWRIGHT / WHK1.5/15G-6SS / 1.5-15 GHz pass filter

The ERP limits in dBm were converted to field strength limits in $\text{dB}\mu\text{V}/\text{m}$ @ 3m.

Example ERP limit conversion: $F/S(\text{Field Strength}) = \text{EIRP} + 95.2 = \text{ERP} + 97.35$ ($\text{ERP} = \text{EIRP} - 2.15$)

It was performed according to the KDB 971168 v02r01 5.8.3. Mathematical conversions.

Both vertical and horizontal polarities were tested and the worst case presented. In all cases the vertical polarization resulted in the greatest signal.

There were no measurable emissions above 18 GHz, up to 40 GHz. The measurement noise floor is well below the specified limit. Measurements in the table above for emissions greater than 18 GHz are of the noise floor.

13.3 Test Results

13.3.1 mode : QPSK Modulation / RB1#0 / XY SCAN

Emission Frequency (MHz)	ANT (H/V)	EUT (X,Y,Z)	Measure Value (dBμV)	Antenna Factor [dB/m]	Amp Gain (dB)	Cable loss (dB)	High Pass Filter (dB)	F/S (dBμV/m)	ERP (dBm)	Limit (dBm)	Margin (dB)
1410.50	V	XY	54.13	25.34	42.54	4.28	3.11	44.32	-53.03	-13.00	40.03
2913.30	V	XY	53.65	28.26	41.98	6.38	0.49	46.80	-50.55	-13.00	37.55
1410.50	H	XY	50.15	25.34	42.54	4.28	3.11	40.34	-57.01	-13.00	44.01

13.3.2 mode : QPSK Modulation / RB1#24 / XY SCAN

Emission Frequency (MHz)	ANT (H/V)	EUT (X,Y,Z)	Measure Value (dBμV)	Antenna Factor [dB/m]	Amp Gain (dB)	Cable loss (dB)	High Pass Filter (dB)	F/S (dBμV/m)	ERP (dBm)	Limit (dBm)	Margin (dB)
1419.00	V	XY	57.52	25.34	42.58	4.30	2.79	47.37	-49.98	-13.00	36.98
2480.20	H	XY	55.84	28.12	42.22	6.29	0.45	48.48	-48.87	-13.00	35.87

13.3.3 mode : QPSK Modulation / RB1#0 / YZ SCAN

Emission Frequency (MHz)	ANT (H/V)	EUT (X,Y,Z)	Measure Value (dBμV)	Antenna Factor [dB/m]	Amp Gain (dB)	Cable loss (dB)	High Pass Filter (dB)	F/S (dBμV/m)	ERP (dBm)	Limit (dBm)	Margin (dB)
1410.50	V	YZ	51.41	25.34	42.54	4.28	3.11	41.60	-55.75	-13.00	42.75
1410.50	H	YZ	52.96	25.34	42.54	4.28	3.11	43.15	-54.20	-13.00	41.20
1772.60	H	YZ	52.20	25.62	42.96	4.84	0.72	40.42	-56.93	-13.00	43.93

13.3.4 mode : QPSK Modulation / RB1#24 / YZ SCAN

Emission Frequency (MHz)	ANT (H/V)	EUT (X,Y,Z)	Measure Value (dBμV)	Antenna Factor [dB/m]	Amp Gain (dB)	Cable loss (dB)	High Pass Filter (dB)	F/S (dBμV/m)	ERP (dBm)	Limit (dBm)	Margin (dB)
1419.00	V	YZ	54.86	25.36	42.58	4.30	2.79	44.73	-52.62	-13.00	39.62
1774.00	V	YZ	51.74	25.62	42.96	4.85	0.72	39.97	-57.38	-13.00	44.38
2838.50	V	YZ	55.41	28.11	42.23	6.28	0.48	48.05	-49.30	-13.00	36.30
1419.00	H	YZ	52.29	25.36	42.58	4.30	2.79	42.16	-55.19	-13.00	42.19
1774.30	H	YZ	61.76	25.62	42.96	4.85	0.72	49.99	-47.36	-13.00	34.36
2840.20	H	YZ	55.88	28.12	42.22	6.29	0.48	48.55	-48.80	-13.00	35.80

13.3.5 mode : QPSK Modulation / RB1#0 / ZX SCAN

Emission Frequency (MHz)	ANT (H/V)	EUT (X,Y,Z)	Measure Value (dBμV)	Antenna Factor [dB/m]	Amp Gain (dB)	Cable loss (dB)	High Pass Filter (dB)	F/S (dBμV/m)	ERP (dBm)	Limit (dBm)	Margin (dB)
1410.50	V	ZX	52.63	25.34	42.54	4.28	3.11	42.82	-54.53	-13.00	41.53
1410.50	H	ZX	56.24	25.34	42.54	4.28	3.11	46.43	-50.92	-13.00	37.92
2821.50	H	ZX	55.91	28.08	42.29	6.26	0.48	48.44	-48.91	-13.00	35.91

13.3.6 mode : QPSK Modulation / RB1#24 / ZX SCAN

Emission Frequency (MHz)	ANT (H/V)	EUT (X,Y,Z)	Measure Value (dBμV)	Antenna Factor [dB/m]	Amp Gain (dB)	Cable loss (dB)	High Pass Filter (dB)	F/S (dBμV/m)	ERP (dBm)	Limit (dBm)	Margin (dB)
1419.00	V	ZX	55.02	25.36	42.58	4.30	2.79	44.89	-52.46	-13.00	39.46
1772.60	V	ZX	51.34	25.62	42.96	4.84	0.72	39.56	-57.79	-13.00	44.79
2840.20	V	ZX	53.86	28.12	42.22	6.29	0.48	46.53	-50.82	-13.00	37.82
1419.00	H	ZX	57.88	25.36	42.58	4.30	2.79	47.75	-49.60	-13.00	36.60
1772.60	H	ZX	57.08	25.62	42.96	4.84	0.72	45.30	-52.05	-13.00	39.05
2129.60	H	ZX	52.80	26.15	43.03	5.35	0.41	41.68	-55.67	-13.00	42.67
2840.20	H	ZX	60.86	28.12	42.22	6.29	0.48	53.53	-43.82	-13.00	30.82

13.3.7 mode : 16QAM Modulation / RB1#0 / XY SCAN

Emission Frequency (MHz)	ANT (H/V)	EUT (X,Y,Z)	Measure Value (dBμV)	Antenna Factor [dB/m]	Amp Gain (dB)	Cable loss (dB)	High Pass Filter (dB)	F/S (dBμV/m)	ERP (dBm)	Limit (dBm)	Margin (dB)
1410.50	V	XY	53.31	25.34	42.54	4.28	3.11	43.50	-53.85	-13.00	40.85

13.3.8 mode : 16QAM Modulation / RB1#24 / XY SCAN

Emission Frequency (MHz)	ANT (H/V)	EUT (X,Y,Z)	Measure Value (dBμV)	Antenna Factor [dB/m]	Amp Gain (dB)	Cable loss (dB)	High Pass Filter (dB)	F/S (dBμV/m)	ERP (dBm)	Limit (dBm)	Margin (dB)
1419.00	V	XY	60.96	25.36	42.58	4.30	2.79	50.83	-46.52	-13.00	33.52
2129.60	V	XY	56.45	26.15	43.03	5.35	0.41	45.33	-52.02	-13.00	39.02
1419.00	H	XY	53.85	25.36	42.58	4.30	2.79	43.72	-53.63	-13.00	40.63
2129.60	H	XY	56.16	26.15	43.03	5.35	0.41	45.04	-52.31	-13.00	39.31

13.3.9 mode : 16QAM Modulation / RB1#0 / YZ SCAN

Emission Frequency (MHz)	ANT (H/V)	EUT (X,Y,Z)	Measure Value (dBμV)	Antenna Factor [dB/m]	Amp Gain (dB)	Cable loss (dB)	High Pass Filter (dB)	F/S (dBμV/m)	ERP (dBm)	Limit (dBm)	Margin (dB)
1410.50	V	YZ	51.38	25.34	42.54	4.28	2.79	41.25	-56.10	-13.00	43.10
1772.60	H	YZ	56.69	25.62	42.96	4.84	0.41	44.60	-52.75	-13.00	39.75

13.3.10 mode : 16QAM Modulation / RB1#24 / YZ SCAN

Emission Frequency (MHz)	ANT (H/V)	EUT (X,Y,Z)	Measure Value (dBμV)	Antenna Factor [dB/m]	Amp Gain (dB)	Cable loss (dB)	High Pass Filter (dB)	F/S (dBμV/m)	ERP (dBm)	Limit (dBm)	Margin (dB)
1419.00	V	YZ	54.31	25.36	42.58	4.30	2.79	44.18	-53.17	-13.00	40.17
2840.20	V	YZ	55.16	28.12	42.22	6.29	0.48	47.83	-49.52	-13.00	36.52
1772.60	H	YZ	52.96	25.62	42.96	4.84	0.72	41.18	-56.17	-13.00	43.17
2838.50	H	YZ	55.34	28.11	42.23	6.28	0.48	47.98	-49.37	-13.00	36.37

13.3.11 mode : 16QAM Modulation / RB1#0 / ZX SCAN

Emission Frequency (MHz)	ANT (H/V)	EUT (X,Y,Z)	Measure Value (dBμV)	Antenna Factor [dB/m]	Amp Gain (dB)	Cable loss (dB)	High Pass Filter (dB)	F/S (dBμV/m)	ERP (dBm)	Limit (dBm)	Margin (dB)
1410.50	V	ZX	50.88	25.34	42.54	4.28	3.11	41.07	-56.28	-13.00	43.28
1410.50	H	ZX	55.59	25.34	42.54	4.28	3.11	45.78	-51.57	-13.00	38.57
2823.50	H	ZX	52.13	28.08	42.28	6.26	0.48	44.67	-52.68	-13.00	39.68

13.3.12 mode : 16QAM Modulation / RB1#24 / ZX SCAN

Emission Frequency (MHz)	ANT (H/V)	EUT (X,Y,Z)	Measure Value (dBμV)	Antenna Factor [dB/m]	Amp Gain (dB)	Cable loss (dB)	High Pass Filter (dB)	F/S (dBμV/m)	ERP (dBm)	Limit (dBm)	Margin (dB)
1419.00	V	ZX	54.82	25.36	42.58	4.30	2.79	44.69	-52.66	-13.00	39.66
2840.20	V	ZX	55.17	28.12	42.22	6.29	0.48	47.84	-49.51	-13.00	36.51
1419.00	H	ZX	54.83	25.36	42.58	4.30	2.79	44.70	-52.65	-13.00	39.65
2129.60	H	ZX	51.54	26.15	43.03	5.35	0.41	40.42	-56.93	-13.00	43.93
2840.20	H	ZX	58.51	28.12	42.22	6.29	0.48	51.18	-46.17	-13.00	33.17

14. Frequency Stability

14.1 Definition

The frequency stability shall be sufficient to ensure that the fundamental emission stays within the authorized frequency block

14.2 Test Procedure

- a. Device is placed at the Temp & Humidity Chamber. Power warm up is at least 15 min and power applied should perform before recording frequency error.
- b. EUT is connected the external power supply to control the DC input power. The test voltage range is from minimum to maximum working voltage. Each step shall be record the frequency error rate.
- c. The temperature range step is 10 degrees in this test items. All temperature levels shall be hold the $\pm 0.5^\circ\text{C}$ during the measurement testing. The each temperature step shall be at least 0.5 hours, consider the EUT could be test under the stability condition

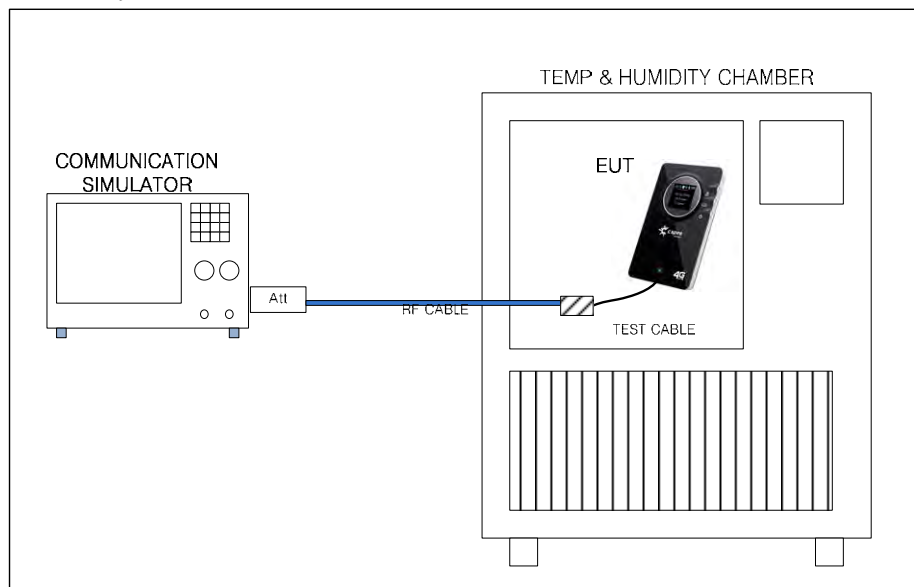

- * EUT test mode : QPSK Modulation / RB1#0 / 23095 CH(707.50 MHz)
- * Temp is change -30 degree to +50 degree (10 degree step)
- * Volt is change DC 3.0V(Cut Off Voltage) to DC 4.3V(Normal Volt : DC 3.7 V +115%)
- * Temp&Humidity chamber : BUMJIN / BJ-THC-667L / 201203-JNDL/ -40°C~+150°C / Due to Cal: 2015-03-24
- * DC Power Supply : Agilent / E3630A / MY40004023 / 0 ~ 24V / 0 ~ 2.5A / Due to Cal: 2014-10-15

14.3 Test Results

14.3.1 Frequency error vs. Temperature

Temp (degree)	Measure (Hz)	Measure (ppm)	Limit (ppm)
-30.0	3.16	0.004	2.5
-20.0	-2.90	-0.004	2.5
-10.0	-4.09	-0.006	2.5
0.0	1.56	0.002	2.5
10.0	-1.67	-0.002	2.5
20.0	-2.70	-0.004	2.5
30.0	-3.33	-0.005	2.5
40.0	-2.26	-0.003	2.5
50.0	-2.56	-0.004	2.5

14.3.2 Frequency error vs. Voltage

Voltage (V)	Measure (Hz)	Measure (ppm)	Limit (ppm)
3.0	3.71	0.005	2.5
3.7	-4.48	-0.006	2.5
4.3	-3.59	-0.005	3.5

* Measure (ppm) = Measure (Hz) ÷ 707.50 MHz

14.4 Test Plots

14.4.1 Frequency error vs. Temperature

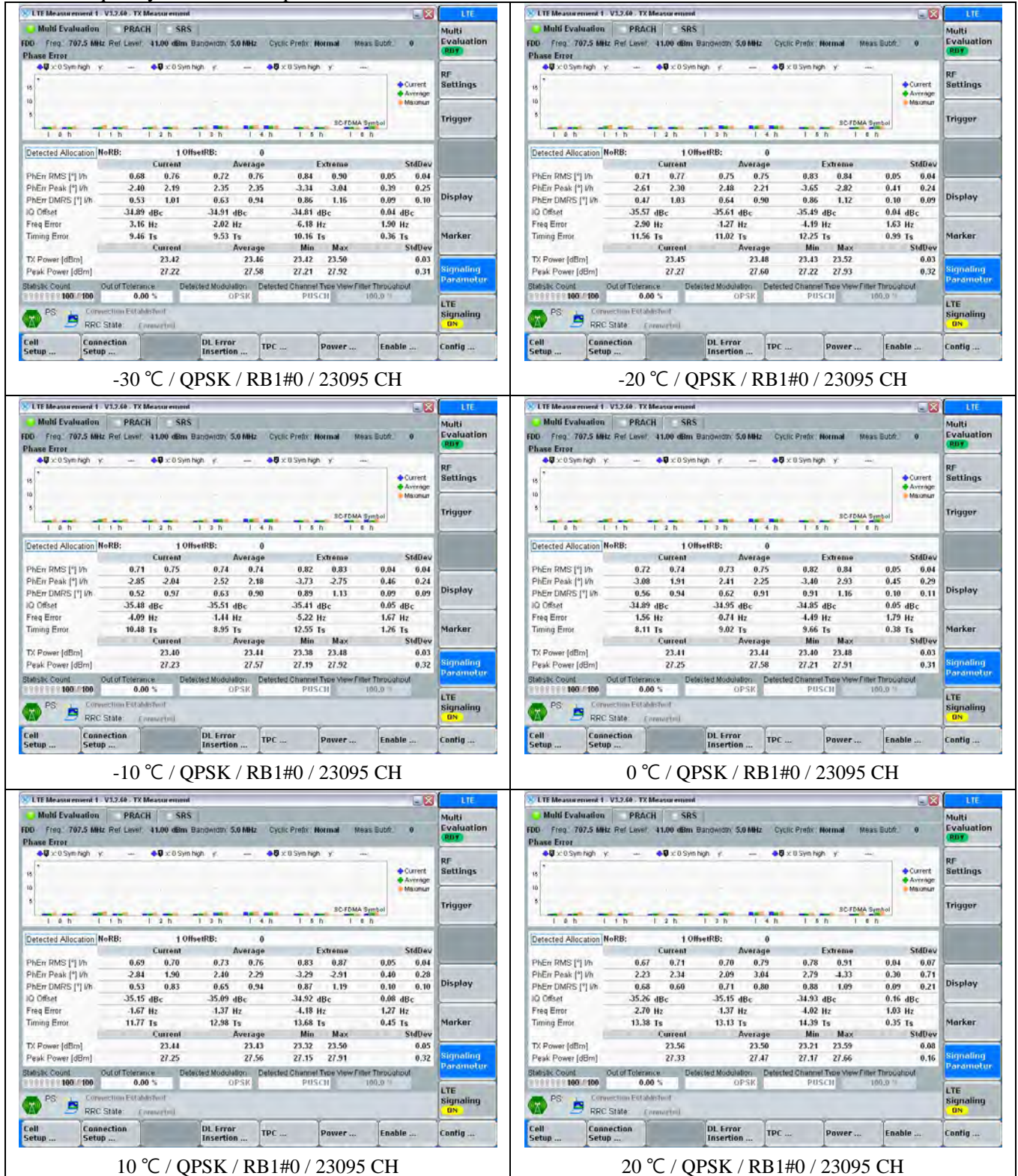

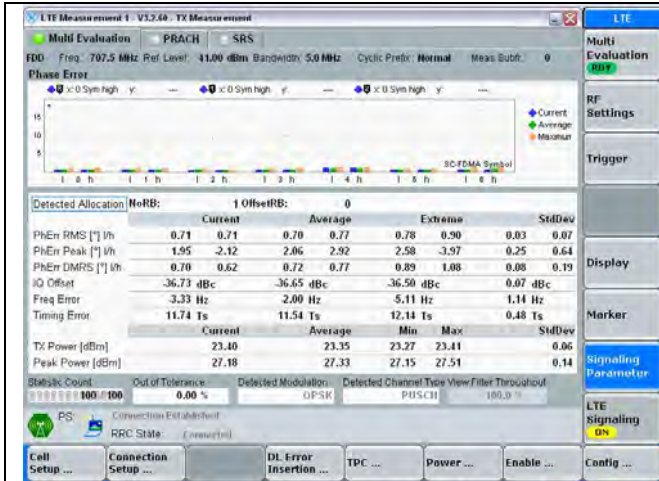

30 °C / QPSK / RB1#0 / 23095 CH

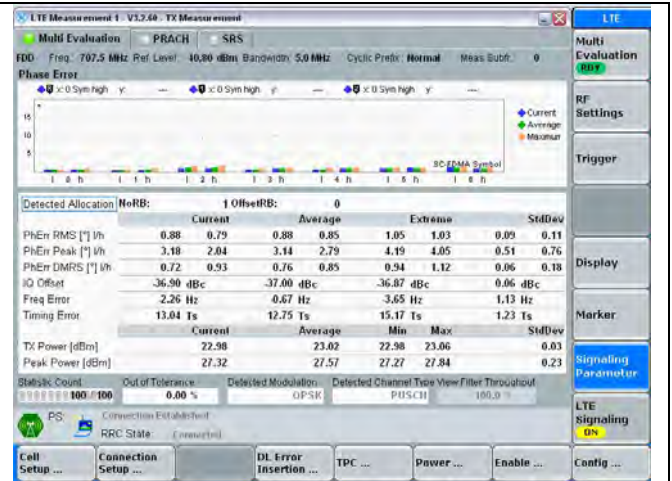

40 °C / QPSK / RB1#0 / 23095 CH

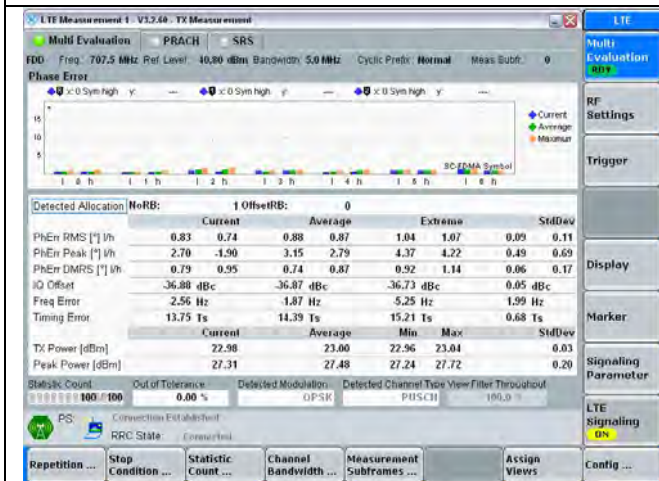

50 °C / QPSK / RB1#0 / 23095 CH

-BLANK-

14.4.2 Frequency error vs. Voltage

