

TEST REPORT

of

FCC Part 2 Subpart J, Part 22 Subpart H, Part 24 Subpart E and
Part 27 Subpart C/L

FCC ID: XHG-R717

Equipment Under Test : Mobile Hotspot
Model Name : T9
Applicant : Franklin Technology Inc.
Manufacturer : Franklin Technology Inc.
Date of Receipt : 2019.05.07
Date of Test(s) : 2019.05.08 ~ 2019.07.10
Date of Issue : 2019.07.22

In the configuration tested, the EUT complied with the standards specified above.

Tested By:



Nancy Park

Date:

2019.07.22

Technical
Manager:



Jungmin Yang

Date:

2019.07.22

The results of this test report are effective only to the items tested. The SGS Korea is not responsible for the sampling, the results of this test report apply to the sample as received. This test report cannot be reproduced, except in full, without prior written permission of the Company. This test report does not assure KOLAS accreditation.

SGS Korea Co., Ltd. (Gunpo Laboratory) 4, LS-ro 182beon-gil, Gunpo-si, Gyeonggi-do, Korea, 15807 <http://www.sgsgroup.kr>

TABLE OF CONTENTS

	Page
1. General Information -----	3
2. RF Radiated Output Power & Spurious Radiated Emission -----	7
3. Occupied Bandwidth -----	15
4. Peak-Average Ratio -----	21
5. Spurious Emissions at Antenna Terminal -----	28
6. Band Edge -----	37
7. Frequency Stability -----	41

The results of this test report are effective only to the items tested. The SGS Korea is not responsible for the sampling, the results of this test report apply to the sample as received. This test report cannot be reproduced, except in full, without prior written permission of the Company. This test report does not assure KOLAS accreditation.

SGS Korea Co., Ltd. (Gunpo Laboratory) 4, LS-ro 182beon-gil, Gunpo-si, Gyeonggi-do, Korea, 15807 <http://www.sgsgroup.kr>

1. General Information

1.1. Testing Laboratory

SGS Korea Co., Ltd. (Gunpo Laboratory)

- 10-2, LS-ro 182beon-gil, Gunpo-si, Gyeonggi-do, Korea, 15807
- 4, LS-ro 182beon-gil, Gunpo-si, Gyeonggi-do, Korea, 15807
- Designation number: KR0150

All SGS services are rendered in accordance with the applicable SGS conditions of service available on request and accessible at <http://www.sgs.com/en/Terms-and-Conditions.aspx>.

Phone No. : +82 31 688 0901

Fax No. : +82 31 688 0921

1.2. Details of Applicant

Applicant : Franklin Technology Inc.

Address : 906 JEI Platz, 186, Gasan digital 1-ro, Gumcheon-Gu, Seoul, South Korea, 08502

Contact Person : Lee, James

Phone No. : +82 70 8228 6445

1.3. Details of Manufacturer

Company : Same as applicant

Address : Same as applicant

1.4. Description of EUT

Kind of Product	Mobile Hotspot
Model Name	T9
Power Supply	DC 3.8 V
Rated Power	WCDMA 2,4,5: 22 dB m
Frequency Range	WCDMA 2: 1 850 MHz ~ 1 910 MHz WCDMA 4: 1 710 MHz ~ 1 755 MHz WCDMA 5: 824 MHz ~ 849 MHz
Emission Designator	WCDMA 2: 4M15F9W WCDMA 4: 4M15F9W WCDMA 5: 4M17F9W
Modulation Technique	QPSK
Antenna Type	FPCB antenna
Antenna gain	1 850 MHz ~ 1 910 MHz: 3.69 dB i 1 710 MHz ~ 1 755 MHz: 3.68 dB i 824 MHz ~ 849 MHz: -0.65 dB i

The results of this test report are effective only to the items tested. The SGS Korea is not responsible for the sampling, the results of this test report apply to the sample as received. This test report cannot be reproduced, except in full, without prior written permission of the Company. This test report does not assure KOLAS accreditation.

SGS Korea Co., Ltd. (Gunpo Laboratory) 4, LS-ro 182beon-gil, Gunpo-si, Gyeonggi-do, Korea, 15807 <http://www.sgsgroup.kr>

1.5. Test Equipment List

Equipment	Manufacturer	Model	S/N	Cal. Date	Cal. Interval	Cal. Due.
Signal Generator	Agilent	E8257D	MY51501169	Jul. 03, 2019	Annual	Jul. 03, 2020
Spectrum Analyzer	R&S	FSV30	103102	Jun. 05, 2019	Annual	Jun. 05, 2020
Mobile Test Unit	R&S	CMW500	144035	Feb. 19, 2019	Annual	Feb. 19, 2020
Power Meter	Anritsu	ML2495A	1223004	Jun. 05, 2019	Annual	Jun. 05, 2020
Power Sensor	Anritsu	MA2411B	1207272	Jun. 05, 2019	Annual	Jun. 05, 2020
Directional Coupler	KRYTAR	152613	140972	Jun. 12, 2019	Annual	Jun. 12, 2020
Temperature Chamber	ESPEC CORP.	PL-1J	15000793	Jun. 10, 2019	Annual	Jun. 10, 2020
High Pass Filter	Wainwright Instrument GmbH	WHKX10-900-1000-1800-40SS	7	Mar. 12, 2019	Annual	Mar. 12, 2020
High Pass Filter	Wainwright Instrument GmbH	WHKX2.2/12.75G-10SS	8	Mar. 12, 2019	Annual	Mar. 12, 2020
High Pass Filter	Wainwright Instrument GmbH	WHK3.0/18G-10SS	344	May 21, 2019	Annual	May 21, 2020
DC Power Supply	R&S	HMP2020	019258024	Nov. 06, 2018	Annual	Nov. 06, 2019
Preamplifier	H.P.	8447F	2944A03909	Aug. 07, 2018	Annual	Aug. 07, 2019
Preamplifier	Agilent	8449B	3008A01932	Feb. 22, 2019	Annual	Feb. 22, 2020
Preamplifier	MITEQ Inc.	JS44-18004000-35-8P	1546891	May 13, 2019	Annual	May 13, 2020
Test Receiver	R&S	ESU26	100109	Jan. 31, 2019	Annual	Jan. 31, 2020
Loop Antenna	SCHWARZBECK MESSELEKTRONIK	FMZB 1519	1519-039	Aug. 23, 2017	Biennial	Aug. 23, 2019
Bilog Antenna	SCHWARZBECK MESSELEKTRONIK	VULB9163	01126	Mar. 26, 2018	Biennial	Mar. 26, 2020
Horn Antenna	R&S	HF906	100326	Feb. 14, 2018	Biennial	Feb. 14, 2020
Horn Antenna	R&S	HF907	100145	Feb. 14, 2018	Biennial	Feb. 14, 2020
Horn Antenna	SCHWARZBECK MESSELEKTRONIK	BBHA9170	BBHA9170223	Sep. 10, 2018	Biennial	Sep. 10, 2020
Antenna Master	Innco systems GmbH	MM4000	N/A	N.C.R.	N/A	N.C.R.
Turn Table	Innco systems GmbH	DS 1200S	N/A	N.C.R.	N/A	N.C.R.
Controller	Innco systems GmbH	CONTROLLER CO3000-4P	CO3000/963/383 30516/L	N.C.R.	N/A	N.C.R.
Anechoic Chamber	SY Corporation	L x W x H (9.6 m x 6.4 m x 6.4 m)	N/A	N.C.R.	N/A	N.C.R.
Coaxial Cable	SUCOFLEX	104 (3 m)	MY3258414	Jul. 04, 2019	Semi-annual	Jan. 04, 2020
Coaxial Cable	SUCOFLEX	104 (10 m)	MY3145814	Jul. 04, 2019	Semi-annual	Jan. 04, 2020
Coaxial Cable	Rosenberger	LA1-C006-1500	131014 04/20	Feb. 28, 2019	Semi-annual	Aug. 28, 2019
Coaxial Cable	Rosenberger	LA1-C006-1500	131014 05/20	Feb. 28, 2019	Semi-annual	Aug. 28, 2019
Coaxial Cable	Rosenberger	LA1-C006-1500	131014 11/20	Feb. 28, 2019	Semi-annual	Aug. 28, 2019

► Support Equipment

Description	Manufacturer	Model	Serial Number
N/A	-	-	-

The results of this test report are effective only to the items tested. The SGS Korea is not responsible for the sampling, the results of this test report apply to the sample as received. This test report cannot be reproduced, except in full, without prior written permission of the Company. This test report does not assure KOLAS accreditation.

1.6. Summary of Test Results

The EUT has been tested according to the following specifications:

APPLIED STANDARD: FCC Part 2, 22, 24 and 27		
Section	Test Item(s)	Result
§2.1046 §22.913(a)(5) §24.232(c) §27.50(d)(4)	RF Radiated Output Power	Complied
§22.917(a) §24.238(a) §27.53(h)(1)	Spurious Radiated Emission	Complied
§2.1046	Conducted Output Power	N/A ¹⁾
§2.1049	Occupied Bandwidth	Complied
§22.913(d) §24.232(d) §27.50(d)(5)	Peak-Average Ratio	Complied
§22.917(a) §24.238(a) §27.53(h)(1)	Spurious Emission at Antenna Terminal	Complied
§22.917(a) §24.238(a) §27.53(h)(1)	Band Edge	Complied
§2.1055 §22.355 §24.235 §27.54	Frequency Stability	Complied

Note;

1) See SAR Report

The results of this test report are effective only to the items tested. The SGS Korea is not responsible for the sampling, the results of this test report apply to the sample as received. This test report cannot be reproduced, except in full, without prior written permission of the Company. This test report does not assure KOLAS accreditation.

1.7. Sample Calculation for Offset

Where relevant, the following sample calculation is provided:

1.7.1. Conducted Test

Offset value (dB) = Directional Coupler (dB) + Cable loss (dB)

1.7.2. Radiation Test

E.R.P. & E.I.R.P. = [S.G level + Amp.] (dB m) - Cable loss (dB) + Ant. gain (dB d/dB i)

1.8. Test Report Revision

Revision	Report Number	Date of Issue	Description
0	F690501/RF-RTL014053	2019.07.11	Initial
1	F690501/RF-RTL014053-1	2019.07.22	Added the coaxial cable in the equipment list.

The results of this test report are effective only to the items tested. The SGS Korea is not responsible for the sampling, the results of this test report apply to the sample as received. This test report cannot be reproduced, except in full, without prior written permission of the Company. This test report does not assure KOLAS accreditation.

SGS Korea Co., Ltd. (Gunpo Laboratory) 4, LS-ro 182beon-gil, Gunpo-si, Gyeonggi-do, Korea, 15807 <http://www.sgsgroup.kr>

2. RF Radiated Output Power & Spurious Radiated Emission

2.1. Test Setup

The diagram below shows the test setup that is utilized to make the measurements for emission from 9 kHz to 30 MHz.

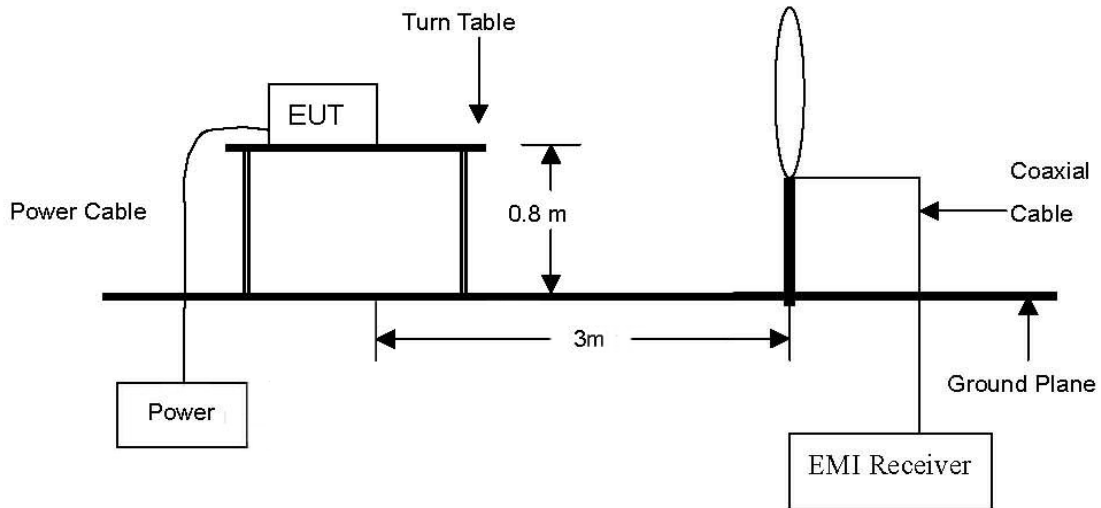

The diagram below shows the test setup that is utilized to make the measurements for emission from 30 MHz to 1 GHz.

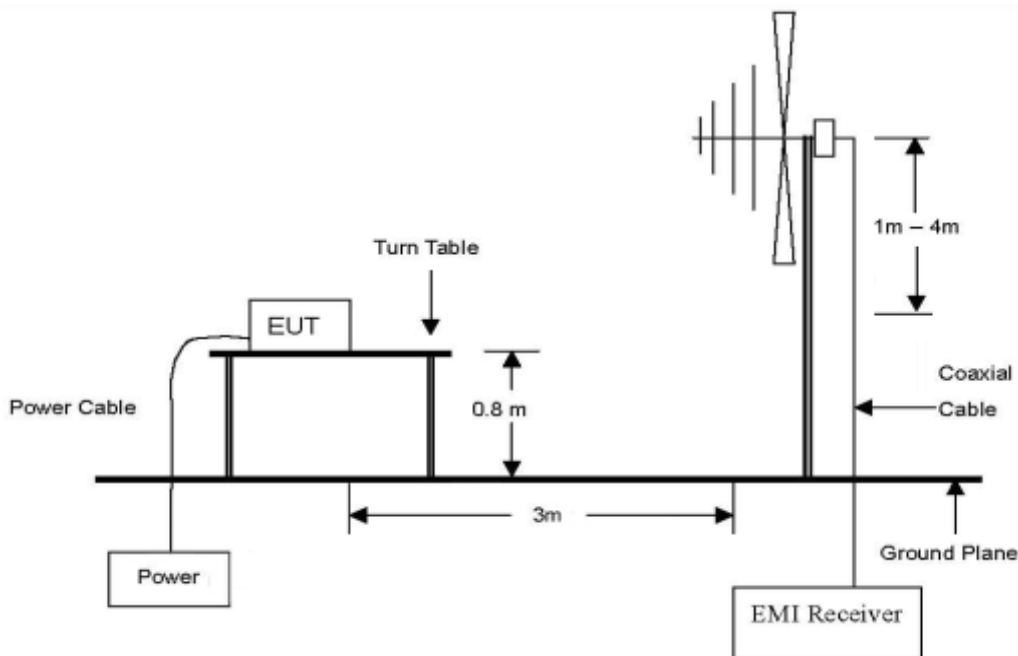

The results of this test report are effective only to the items tested. The SGS Korea is not responsible for the sampling, the results of this test report apply to the sample as received. This test report cannot be reproduced, except in full, without prior written permission of the Company. This test report does not assure KOLAS accreditation.

The diagram below shows the test setup that is utilized to make the measurements for emission from 1 GHz to 20 GHz.

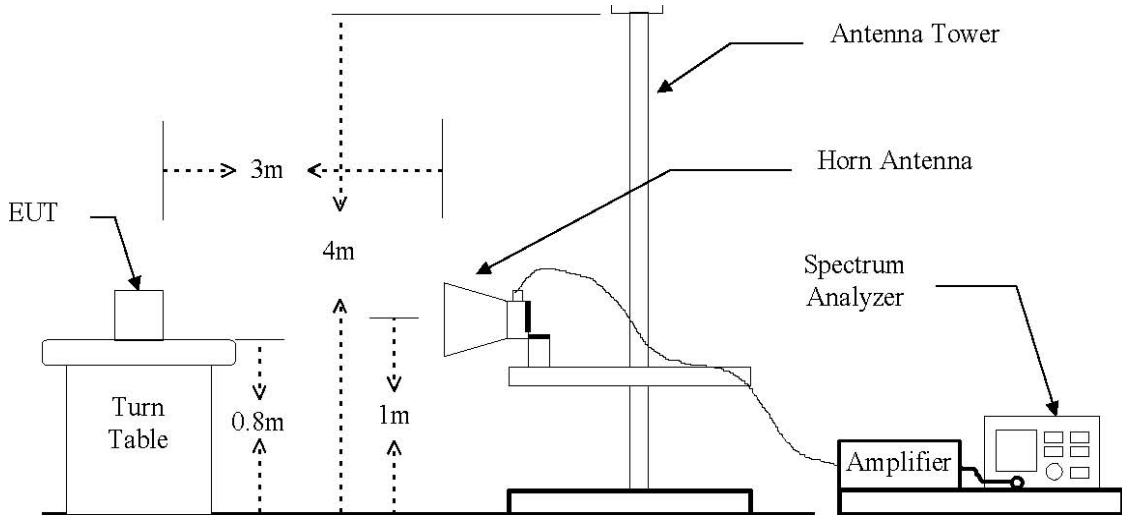

The diagram below shows the test setup for substituted method.

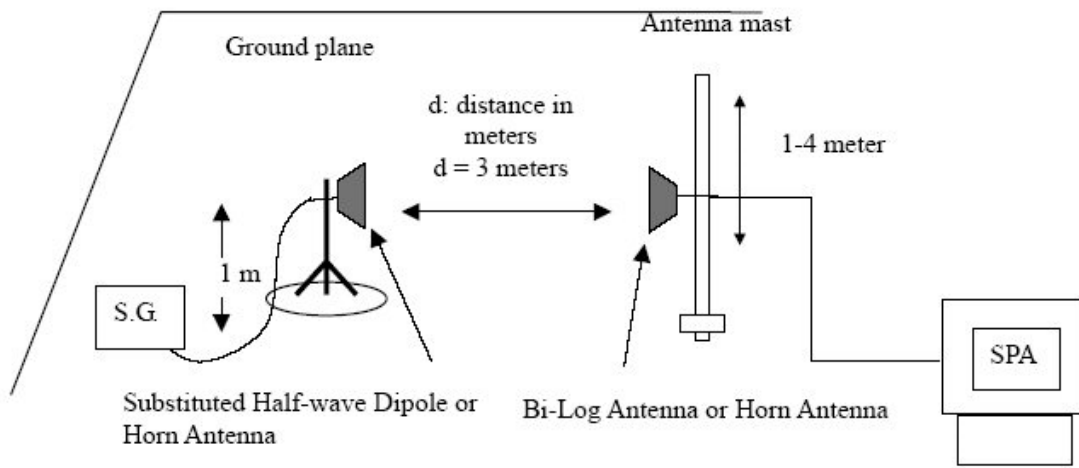

The results of this test report are effective only to the items tested. The SGS Korea is not responsible for the sampling, the results of this test report apply to the sample as received. This test report cannot be reproduced, except in full, without prior written permission of the Company. This test report does not assure KOLAS accreditation.

2.2. Limit

2.2.1. Limit of Radiated Output Power

- §22.913(a)(5), the ERP of mobile transmitters and auxiliary test transmitters must not exceed 7 watts.
- §24.232(c), mobile and portable stations are limited to 2 watts EIRP and the equipment must employ a means to limiting power to the minimum necessary for successful communications.
- §27.50(d)(4), fixed, mobile, and portable (hand-held) stations operating in the 1 710-1 755 MHz band and mobile and portable stations operating in the 1 695-1 710 MHz and 1 755-1 780 MHz bands are limited to 1 watt EIRP.

2.2.2. Limit of Spurious Radiated Emission

- §22.917(a), the power of any emission outside of the authorized operating frequency ranges must be attenuated below the transmitting power (P) by a factor of at least $43 + 10\log(P)$ dB.
- §24.238(a), the power of any emission outside of the authorized operating frequency ranges must be attenuated below the transmitting power (P) by a factor of at least $43 + 10 \log(P)$ dB.
- §27.53(h)(1), for operations in the 1 695-1 710 MHz, 1 710-1 755 MHz, 1 755-1 780 MHz, 1 915-1 920 MHz, 1 995-2 000 MHz, 2 000-2 020 MHz, 2 110-2 155 MHz, 2 155-2 180 MHz, and 2 180-2 200 bands, the power of any emission outside a licensee's frequency block shall be attenuated below the transmitter power (P) in watts by at least $43 + 10 \log_{10}(P)$ dB.

The results of this test report are effective only to the items tested. The SGS Korea is not responsible for the sampling, the results of this test report apply to the sample as received. This test report cannot be reproduced, except in full, without prior written permission of the Company. This test report does not assure KOLAS accreditation.

2.3. Test Procedure: Based on ANSI/TIA 603E: 2016 and ANSI C63.26-2015

1. On a test site, the EUT shall be placed at 80 cm height on a turn table, and in the position close to normal use as declared by the applicant.
2. The test antenna shall be oriented initially for vertical polarization located 3 m from EUT to correspond to the fundamental frequency of the transmitter.
3. The output of the test antenna shall be connected to the measuring receiver and the peak detector is used for the measurement.
4. The maximized power level is recorded using the spectrum analyzer "Channel Power" function with the integration band set to the emissions occupied bandwidth, RBW = 1-5 % of the OBW (not to exceed 1 MHz), VBW $\geq 3 \times$ RBW, Detector = power averaging (rms), sweep time = auto, trace average at least 100 traces in power averaging (rms) mode, per the guidelines of KDB 971168 D01 Power Meas License Digital Systems v03r01.
5. Radiated spurious emissions measurement method was set as follows:
RBW = 100 kHz for emissions below 1 GHz and 1 MHz for emissions above 1 GHz, VBW $\geq 3 \times$ RBW, Detector = Peak, trace mode = max hold, per the guidelines of KDB 971168 D01 Power Meas License Digital Systems v03r01.
6. The transmitter shall be switched on, the measuring receiver shall be tuned to the frequency of the transmitter under test.
7. The test antenna shall be raised and lowered through the specified range of height until the maximum signal level is detected by the measuring receiver.
8. The transmitter shall be rotated through 360° in the horizontal plane, until the maximum signal level is detected by the measuring receiver.
9. The test antenna shall be raised and lowered again through the specified range of height until the maximum signal level is detected by the measuring receiver.
10. The maximum signal level detected by the measuring receiver shall be noted.
11. The EUT was replaced by half-wave dipole (1 GHz below) or horn antenna (1 GHz above) connected to a signal generator.
12. In necessary, the input attenuator setting on the measuring receiver shall be adjusted in order to increase the sensitivity of the measuring receiver.
13. The test antenna shall be raised and lowered through the specified range of height to ensure that the maximum signal is received.
14. The input signal to the substitution antenna shall be adjusted to the level that produces a level detected by the measuring receiver, which is equal to the level noted while the transmitter radiated power was measured, corrected for the change of input attenuator setting of the measuring receiver.
15. The input level to the substitution antenna shall be recorded as power level in dBm, corrected for any change of input attenuator setting of the measuring receiver.
16. The measurement shall be repeated with the test antenna and the substitution antenna orientated for horizontal polarization.

The results of this test report are effective only to the items tested. The SGS Korea is not responsible for the sampling, the results of this test report apply to the sample as received. This test report cannot be reproduced, except in full, without prior written permission of the Company. This test report does not assure KOLAS accreditation.

2.4. Test Result for RF Radiated Output Power

Ambient temperature : (23 ± 1) °C
 Relative humidity : 47 % R.H.

WCDMA 2_RMC

Frequency (MHz)	Ant. Pol. (H/V)	S.G level + Amp. (dB m)	Cable loss (dB)	Ant. gain (dB i)	E.I.R.P.	
					(dB m)	(mW)
1 852.40	H	19.18	4.33	8.54	23.39	218.27
1 852.40	V	20.70	4.33	8.54	24.91	309.74
1 880.00	H	20.82	4.34	8.63	25.11	324.34
1 880.00	V	19.78	4.34	8.63	24.07	255.27
1 907.60	H	19.74	4.36	8.62	24.00	251.19
1 907.60	V	18.48	4.36	8.62	22.74	187.93

WCDMA 4_RMC

Frequency (MHz)	Ant. Pol. (H/V)	S.G level + Amp. (dB m)	Cable loss (dB)	Ant. gain (dB i)	E.I.R.P.	
					(dB m)	(mW)
1 712.40	H	19.88	4.14	8.51	24.25	266.07
1 712.40	V	20.32	4.14	8.51	24.69	294.44
1 732.60	H	20.37	4.18	8.48	24.67	293.09
1 732.60	V	21.03	4.18	8.48	25.33	341.19
1 752.60	H	19.66	4.21	8.44	23.89	244.91
1 752.60	V	22.01	4.21	8.44	26.24	420.73

The results of this test report are effective only to the items tested. The SGS Korea is not responsible for the sampling, the results of this test report apply to the sample as received. This test report cannot be reproduced, except in full, without prior written permission of the Company. This test report does not assure KOLAS accreditation.

WCDMA 5_RMC

Frequency (MHz)	Ant. Pol. (H/V)	S.G level + Amp. (dB m)	Cable loss (dB)	Ant. gain (dB d)	E.R.P.	
					(dB m)	(mW)
826.4	H	19.61	3.31	-5.18	11.12	12.94
826.4	V	20.01	3.31	-5.18	11.52	14.19
836.6	H	19.04	3.45	-5.14	10.45	11.09
836.6	V	18.43	3.45	-5.14	9.84	9.64
846.6	H	19.22	3.51	-4.25	11.46	14.00
846.6	V	17.71	3.51	-4.25	9.95	9.89

Remark;

1. E.R.P. & E.I.R.P. = [S.G level + Amp.] (dB m) - Cable loss (dB) + Ant. gain (dB d/dB i)

The results of this test report are effective only to the items tested. The SGS Korea is not responsible for the sampling, the results of this test report apply to the sample as received. This test report cannot be reproduced, except in full, without prior written permission of the Company. This test report does not assure KOLAS accreditation.

2.5. Spurious Radiated Emission

WCDMA 2_RMC

Frequency (MHz)	Ant. Pol. (H/V)	S.G level + Amp. (dB m)	Cable loss (dB)	Ant. gain (dB i)	E.I.R.P. (dB m)	Limit (dB m)	Margin (dB)
Low Channel (1 852.4 MHz)							
5 555.02	H	-48.17	7.53	10.63	-45.07	-13	32.07
5 559.60	V	-47.85	7.53	10.64	-44.74	-13	31.74
Middle Channel (1 880.0 MHz)							
5 636.18	H	-48.41	7.63	10.88	-45.16	-13	32.16
5 642.06	V	-50.24	7.65	10.92	-46.97	-13	33.97
High Channel (1 907.6 MHz)							
5 719.14	H	-46.93	7.85	11.27	-43.51	-13	30.51
5 719.30	V	-50.64	7.85	11.27	-47.22	-13	34.22

WCDMA 4_RMC

Frequency (MHz)	Ant. Pol. (H/V)	S.G level + Amp. (dB m)	Cable loss (dB)	Ant. gain (dB i)	E.I.R.P. (dB m)	Limit (dB m)	Margin (dB)
Low Channel (1 712.4 MHz)							
5 139.55	H	-52.94	7.63	10.47	-50.10	-13	37.10
5 141.10	V	-55.17	7.63	10.47	-52.33	-13	39.33
Middle Channel (1 732.6 MHz)							
5 195.20	H	-53.05	7.75	10.60	-50.20	-13	37.20
5 201.10	V	-54.26	7.76	10.61	-51.41	-13	38.41
High Channel (1 752.6 MHz)							
5 259.90	H	-53.70	7.68	10.71	-50.67	-13	37.67
5 254.10	V	-51.26	7.69	10.70	-48.25	-13	35.25

The results of this test report are effective only to the items tested. The SGS Korea is not responsible for the sampling, the results of this test report apply to the sample as received. This test report cannot be reproduced, except in full, without prior written permission of the Company. This test report does not assure KOLAS accreditation.

WCDMA 5_RMC

Frequency (MHz)	Ant. Pol. (H/V)	S.G level + Amp. (dB m)	Cable loss (dB)	Ant. gain (dB d)	E.R.P. (dB m)	Limit (dB m)	Margin (dB)
Low Channel (826.4 MHz)							
1 655.14	H	-59.03	4.02	6.04	-57.01	-13	44.01
1 655.30	V	-57.39	4.02	6.04	-55.37	-13	42.37
Middle Channel (836.6 MHz)							
1 675.39	H	-64.34	4.07	6.19	-62.22	-13	49.22
1 675.42	V	-61.30	4.07	6.19	-59.18	-13	46.18
High Channel (846.6 MHz)							
1 696.05	H	-64.91	4.11	6.35	-62.67	-13	49.67
1 695.80	V	-60.29	4.11	6.35	-58.05	-13	45.05

Remark;

1. E.R.P. & E.I.R.P. = S.G level (dB m) - Cable loss (dB) + Ant. gain (dB d/dB i)

The results of this test report are effective only to the items tested. The SGS Korea is not responsible for the sampling, the results of this test report apply to the sample as received. This test report cannot be reproduced, except in full, without prior written permission of the Company. This test report does not assure KOLAS accreditation.

3. Occupied Bandwidth

3.1. Limit

CFR 47, Section FCC §2.1049.

3.2. Test Procedure

The test follows section 4.2 of KDB 971168 D01 Power Meas License Digital Systems v03r01.

- a. The spectrum analyzer center frequency is set to the nominal EUT channel center frequency. The frequency span for the spectrum analyzer shall be set wide enough to capture all modulation products including the emission skirts (typically a span of $1.5 \times \text{OBW}$ is sufficient).
- b. The nominal IF filter 3 dB bandwidth (RBW) shall be in the range of 1 % to 5 % of the anticipated OBW, and the VBW shall be set $\geq 3 \times \text{RBW}$.
- c. Set the reference level of the instrument as required to prevent the signal amplitude from exceeding the maximum spectrum analyzer input mixer level for linear operation. See guidance provided in 4.2.3.
- d. Set the detection mode to peak, and the trace mode to max-hold.
- e. If the instrument does not have a 99 % OBW function, recover the trace data points and sum directly in linear power terms. Place the recovered amplitude data points, beginning at the lowest frequency, in a running sum until 0.5 % of the total is reached. Record that frequency as the lower OBW frequency. Repeat the process until 99.5 % of the total is reached and record that frequency as the upper OBW frequency. The 99 % power OBW can be determined by computing the difference these two frequencies.
- f. The OBW shall be reported and plot(s) of the measuring instrument display shall be provided with the test report. The frequency and amplitude axis and scale shall be clearly labeled. Tabular data can be reported in addition to the plot(s).

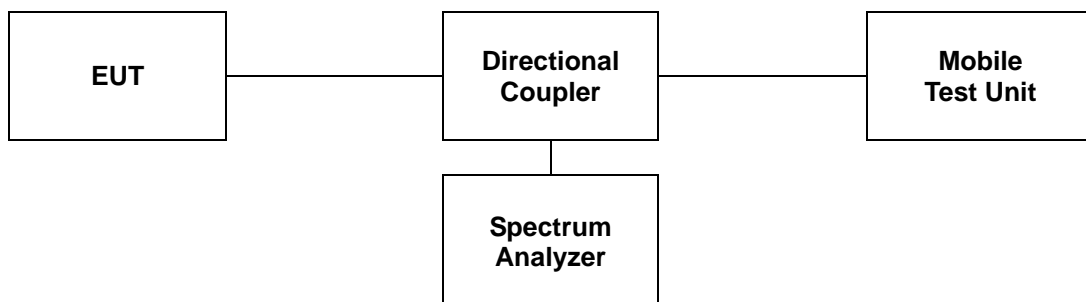

The results of this test report are effective only to the items tested. The SGS Korea is not responsible for the sampling, the results of this test report apply to the sample as received. This test report cannot be reproduced, except in full, without prior written permission of the Company. This test report does not assure KOLAS accreditation.

3.3 Test Results

Ambient temperature : (23 ± 1) °C
 Relative humidity : 47 % R.H.

Band	Mode	Frequency (MHz)	Occupied Bandwidth (MHz)
2	RMC	1 852.4	4.153
		1 880.0	4.153
		1 907.6	4.153
4	RMC	1 712.4	4.153
		1 732.6	4.139
		1 752.6	4.153
5	RMC	826.4	4.153
		836.6	4.168
		846.6	4.168

- Test plots

WCDMA 2 Low Channel

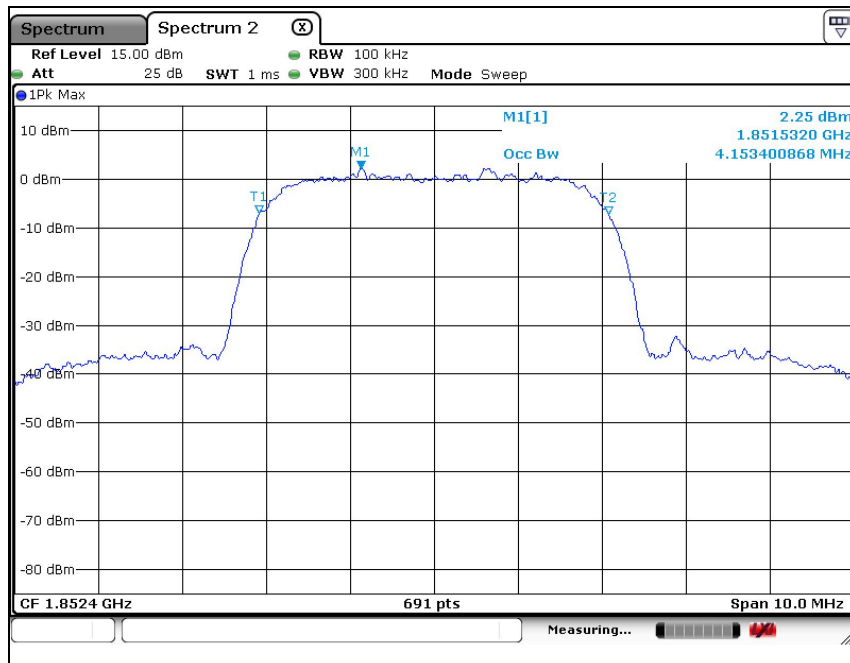

The results of this test report are effective only to the items tested. The SGS Korea is not responsible for the sampling, the results of this test report apply to the sample as received. This test report cannot be reproduced, except in full, without prior written permission of the Company. This test report does not assure KOLAS accreditation.

Middle Channel

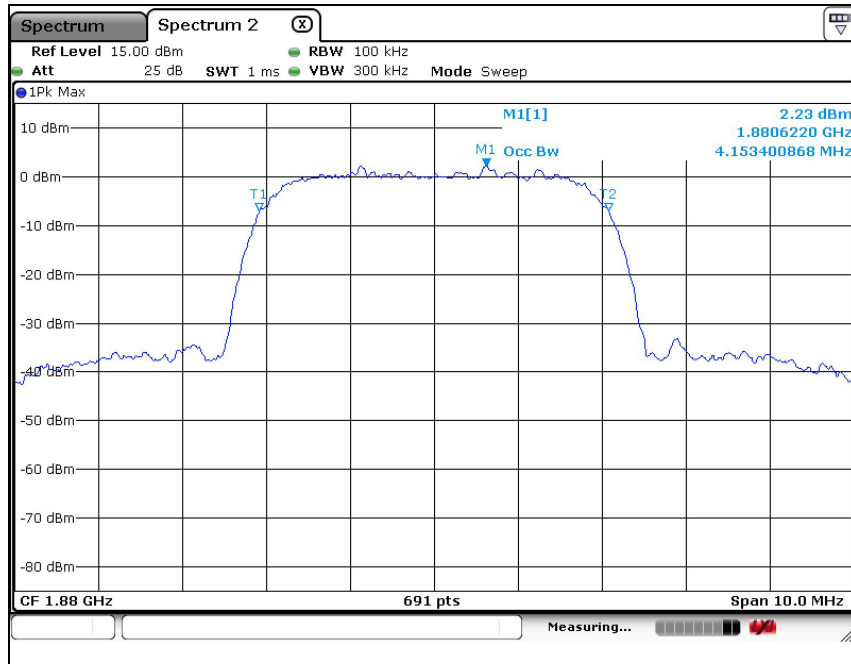

High Channel

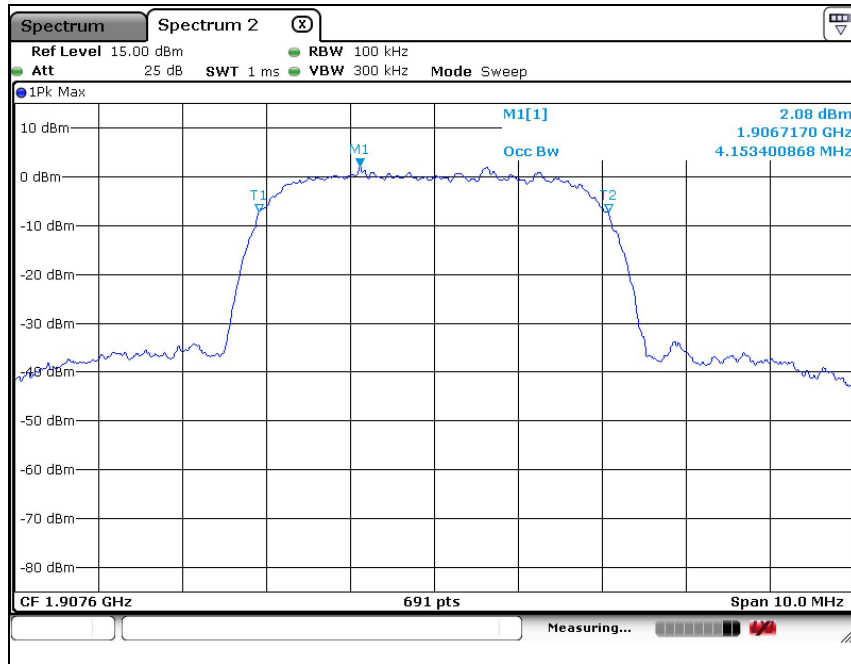

The results of this test report are effective only to the items tested. The SGS Korea is not responsible for the sampling, the results of this test report apply to the sample as received. This test report cannot be reproduced, except in full, without prior written permission of the Company. This test report does not assure KOLAS accreditation.

WCDMA 4 Low Channel

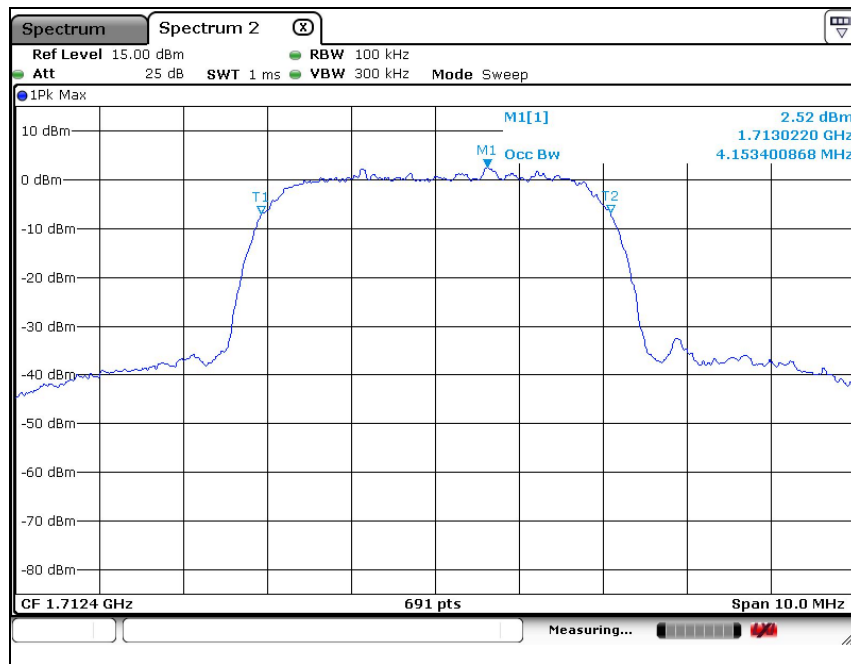

Middle Channel

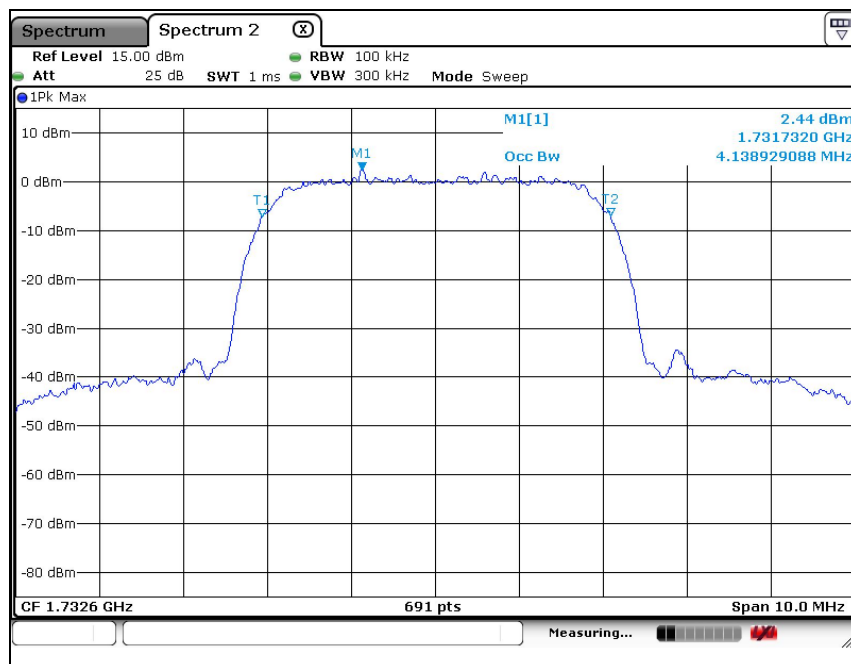

The results of this test report are effective only to the items tested. The SGS Korea is not responsible for the sampling, the results of this test report apply to the sample as received. This test report cannot be reproduced, except in full, without prior written permission of the Company. This test report does not assure KOLAS accreditation.

High Channel

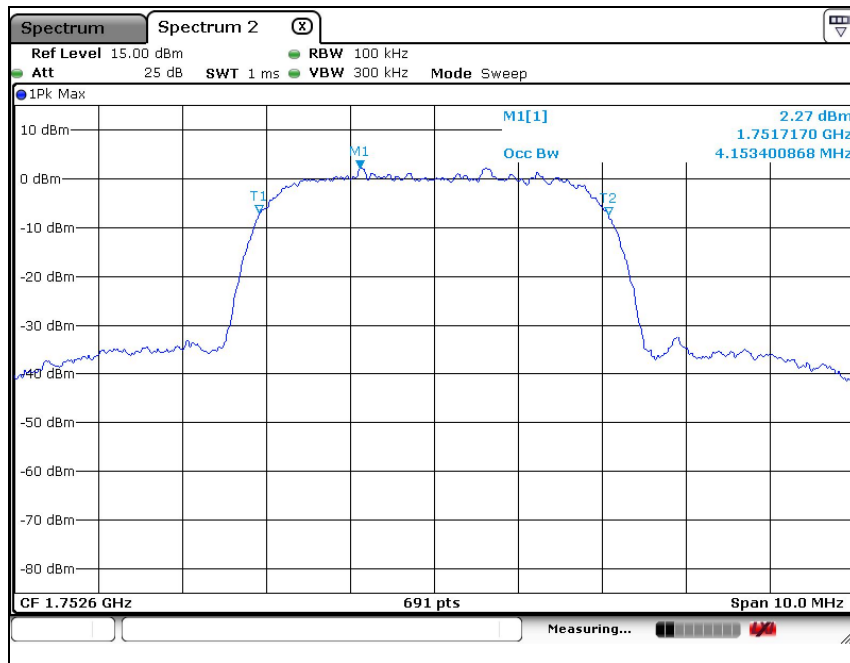

WCDMA 5 Low Channel

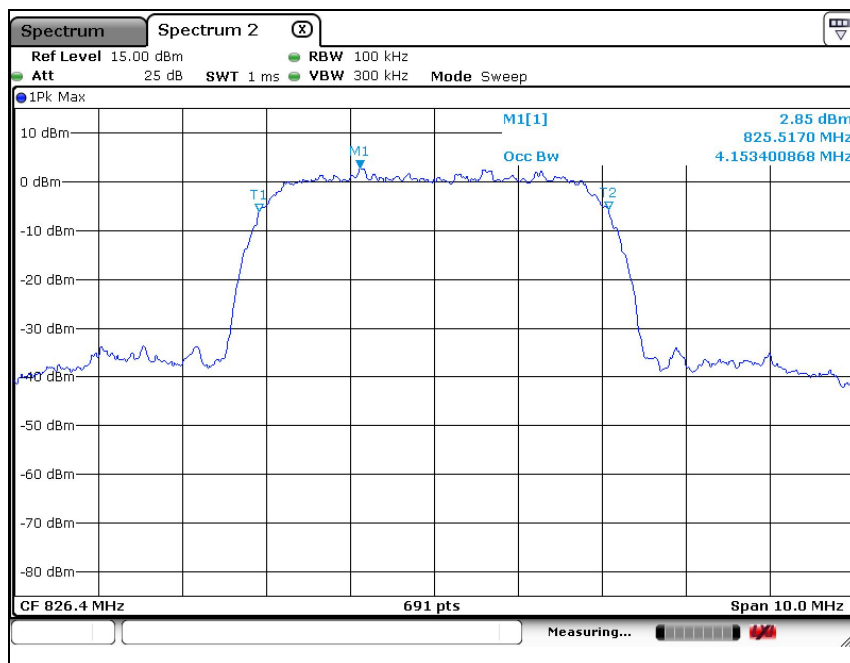

The results of this test report are effective only to the items tested. The SGS Korea is not responsible for the sampling, the results of this test report apply to the sample as received. This test report cannot be reproduced, except in full, without prior written permission of the Company. This test report does not assure KOLAS accreditation.

Middle Channel

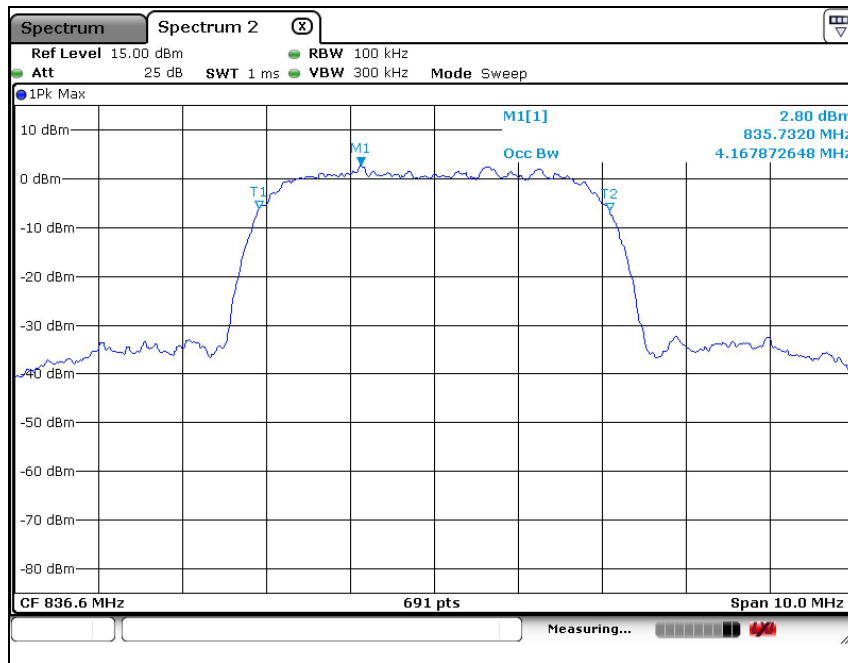

High Channel

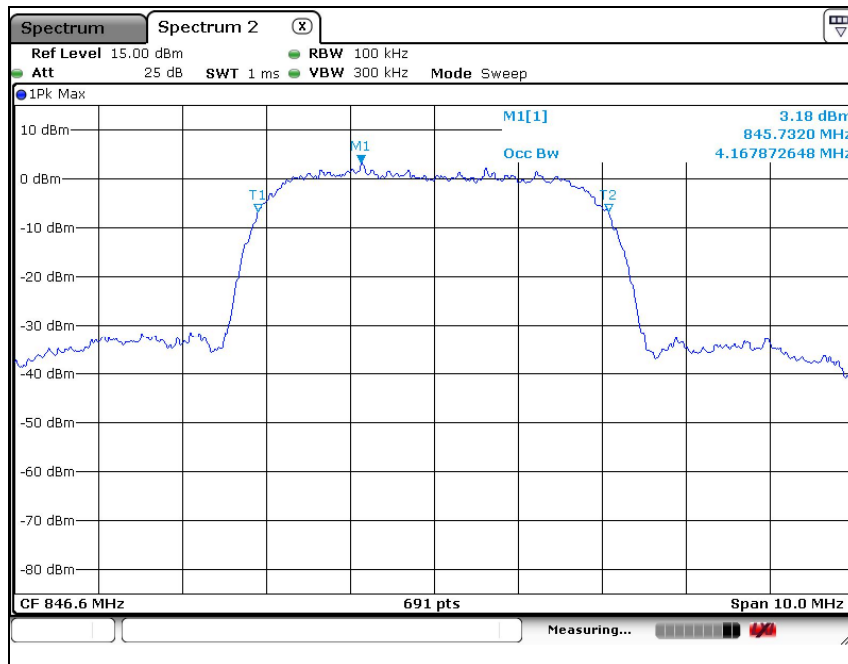

The results of this test report are effective only to the items tested. The SGS Korea is not responsible for the sampling, the results of this test report apply to the sample as received. This test report cannot be reproduced, except in full, without prior written permission of the Company. This test report does not assure KOLAS accreditation.

4. Peak-Average Ratio

4.1. Limit

- §22.913(d) Measurement of the ERP of Cellular base transmitters and repeaters must be made using an average power measurement technique. The peak-to-average ratio (PAR) of the transmission must not exceed 13 dB.

- §24.232(d), power measurements for transmissions by stations authorized under this section may be made either in accordance with a Commission-approved average power technique or in compliance with paragraph (e) of this section. In both instances, equipment employed must be authorized in accordance with the provisions of §24.51. In measuring transmissions in this band using an average power technique, the peak-to-average ratio (PAR) of the transmission may not exceed 13 dB.

- §27.50(d)(5), power measurements for transmissions by stations authorized under this section may be made either in accordance with a Commission-approved average power technique or in compliance with paragraph (d)(6) of this section. In measuring transmissions in this band using an average power technique, the peak-to-average ratio (PAR) of the transmission may not exceed 13 dB.

The results of this test report are effective only to the items tested. The SGS Korea is not responsible for the sampling, the results of this test report apply to the sample as received. This test report cannot be reproduced, except in full, without prior written permission of the Company. This test report does not assure KOLAS accreditation.

SGS Korea Co., Ltd. (Gunpo Laboratory) 4, LS-ro 182beon-gil, Gunpo-si, Gyeonggi-do, Korea, 15807 <http://www.sgsgroup.kr>

RTT5041-19(2019.04.24)(1)

Tel. +82 31 428 5700 / Fax. +82 31 427 2370

A4(210 mm x 297 mm)

4.2. Test Procedure

The test follows section 5.2.3.4 of ANSI C63.26-2015.

See instrumentation-specific application literature for further guidance regarding use of the CCDF capability. The following guidelines are offered for performing a CCDF measurement.

- a. Set resolution/measurement bandwidth \geq OBW or specified reference bandwidth.
- b. Set the number of counts to a value that stabilizes the measured CCDF curve.
- c. Set the measurement interval as follows:
 - 1) For continuous transmissions, set to greater of $[10 \times (\text{number of points in sweep}) \times (\text{transmission symbol period})]$ or 1 ms.
 - 2) For burst transmissions, employ an external trigger that is synchronized with the EUT burst timing sequence, or use the internal burst trigger with a trigger level that allows the burst to stabilize. Set the measurement interval to a time that is less than or equal to the burst duration.
 - 3) If there are several carriers in a single antenna port, the peak power shall be determined for each individual carrier (by disabling the other carriers while measuring the required carrier) and the total peak power calculated from the sum of the individual carrier peak powers.
- d. Record the maximum PAPR level associated with a probability of 0.1 %.
- e. The peak power level is calculated from the sum of the PAPR value from step d) to the measured average power.

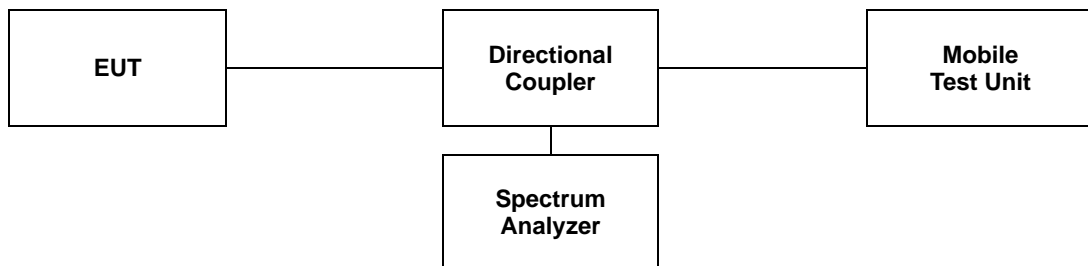

The results of this test report are effective only to the items tested. The SGS Korea is not responsible for the sampling, the results of this test report apply to the sample as received. This test report cannot be reproduced, except in full, without prior written permission of the Company. This test report does not assure KOLAS accreditation.

4.3 Test Results

Ambient temperature : (23 ± 1) °C
 Relative humidity : 47 % R.H.

Band	Mode	Frequency (MHz)	PAR (dB)
2	RMC	1 852.4	2.67
		1 880.0	2.72
		1 907.6	2.75
4	RMC	1 712.4	2.81
		1 732.6	2.84
		1 752.6	2.61
5	RMC	826.4	2.84
		836.6	2.72
		846.6	2.75

- Test plots

WCDMA 2 Low Channel

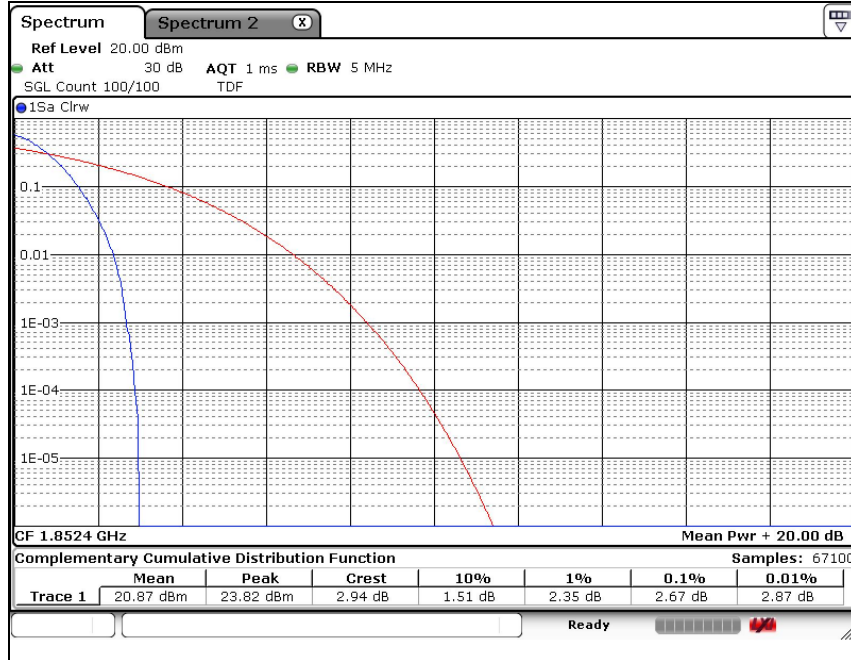

The results of this test report are effective only to the items tested. The SGS Korea is not responsible for the sampling, the results of this test report apply to the sample as received. This test report cannot be reproduced, except in full, without prior written permission of the Company. This test report does not assure KOLAS accreditation.

Middle Channel

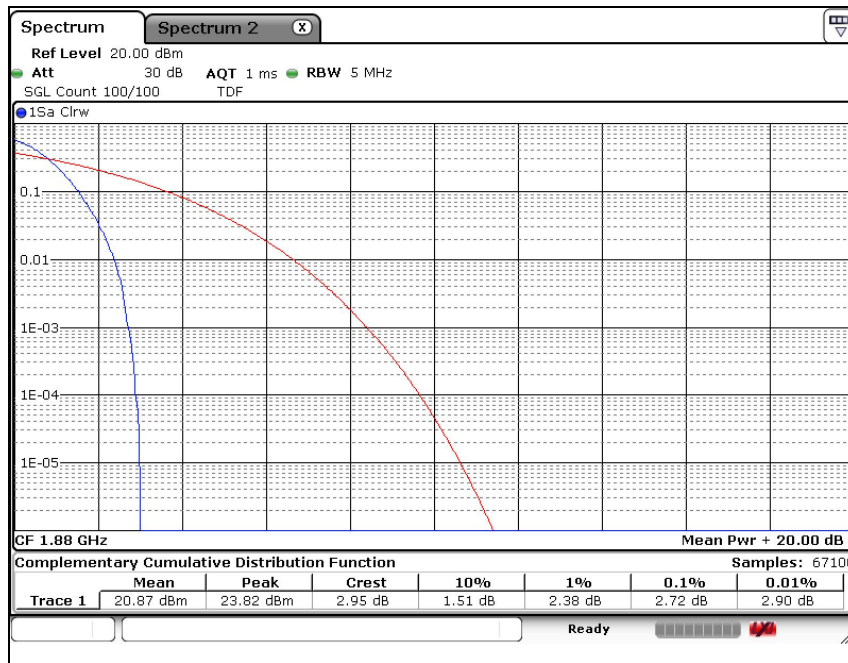

High Channel

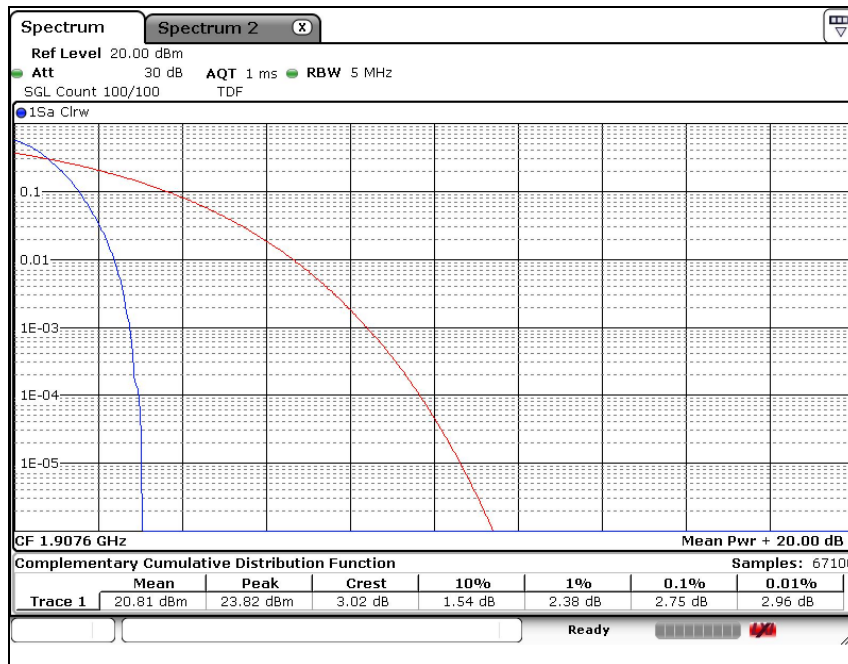

The results of this test report are effective only to the items tested. The SGS Korea is not responsible for the sampling, the results of this test report apply to the sample as received. This test report cannot be reproduced, except in full, without prior written permission of the Company. This test report does not assure KOLAS accreditation.

WCDMA 4
Low Channel

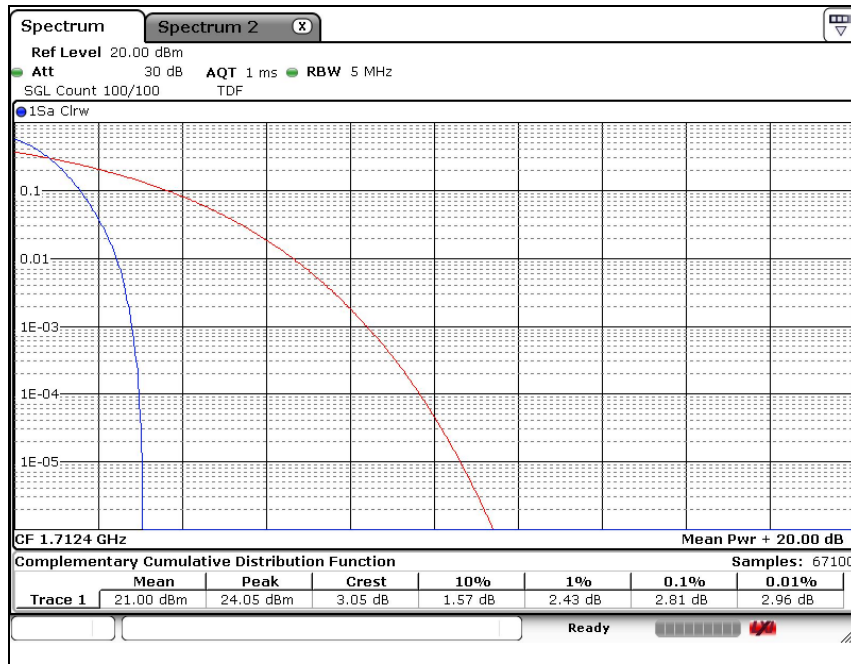

Middle Channel

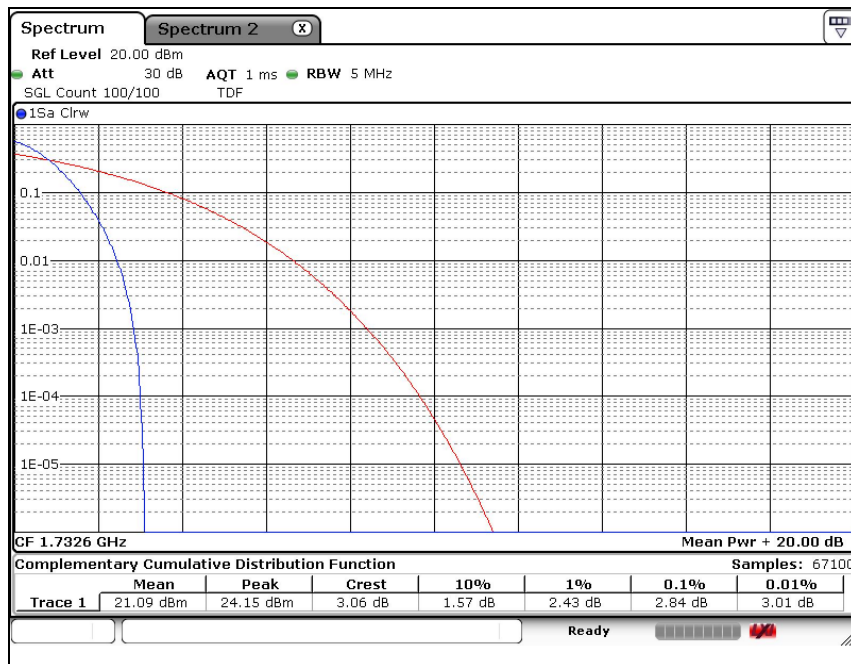

The results of this test report are effective only to the items tested. The SGS Korea is not responsible for the sampling, the results of this test report apply to the sample as received. This test report cannot be reproduced, except in full, without prior written permission of the Company. This test report does not assure KOLAS accreditation.

High Channel

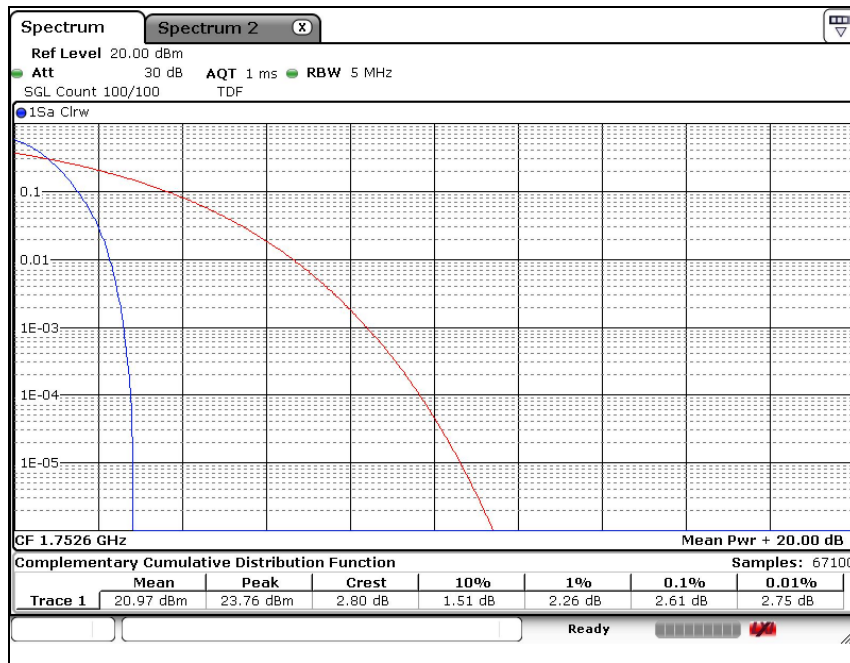

WCDMA 5 Low Channel

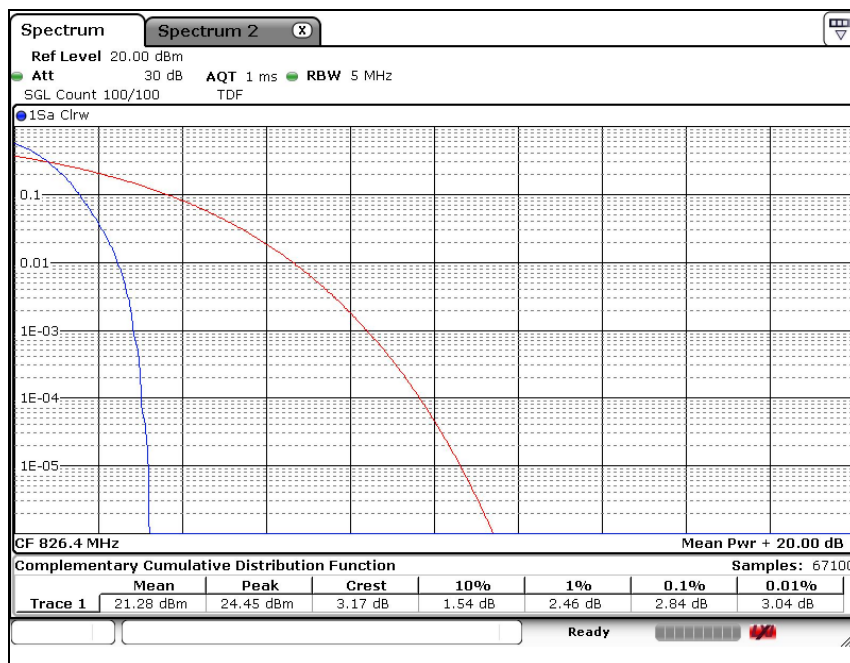

The results of this test report are effective only to the items tested. The SGS Korea is not responsible for the sampling, the results of this test report apply to the sample as received. This test report cannot be reproduced, except in full, without prior written permission of the Company. This test report does not assure KOLAS accreditation.

Middle Channel

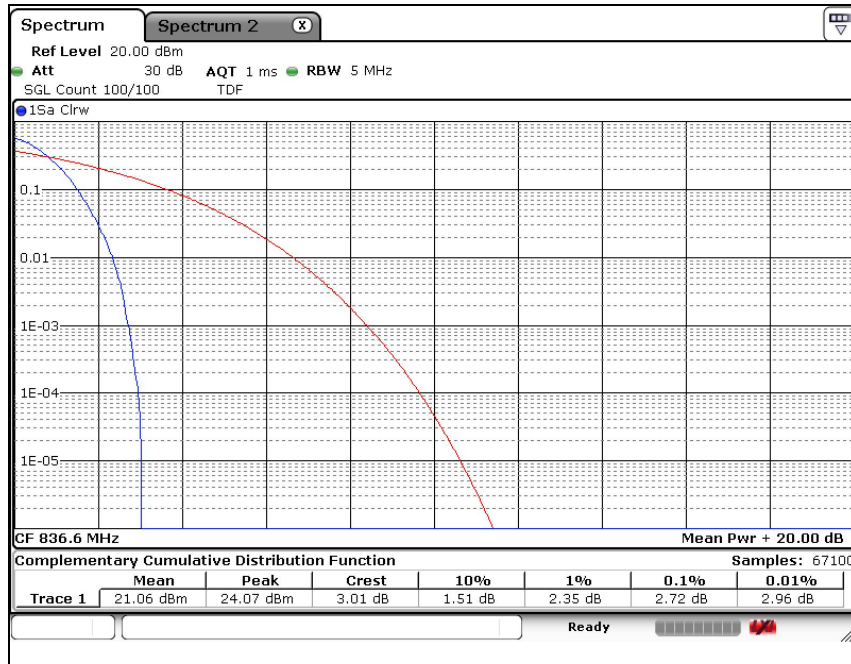

High Channel

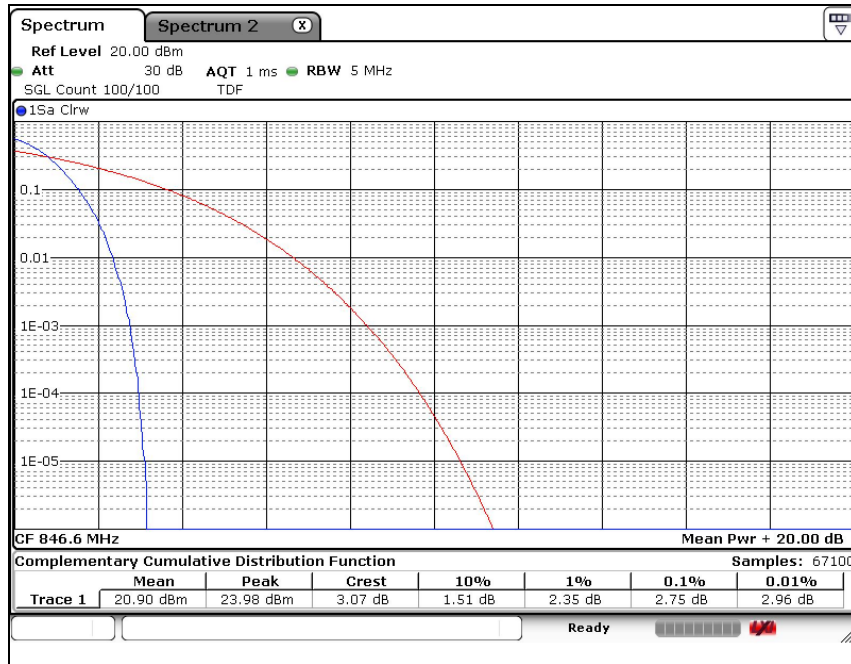

The results of this test report are effective only to the items tested. The SGS Korea is not responsible for the sampling, the results of this test report apply to the sample as received. This test report cannot be reproduced, except in full, without prior written permission of the Company. This test report does not assure KOLAS accreditation.

5. Spurious Emissions at Antenna Terminal

5.1. Limit

- §22.917(a), the power of any emission outside of the authorized operating frequency ranges must be attenuated below the transmitting power (P) by a factor of at least $43 + 10\log(P)$ dB.

- §24.238(a), the power of any emission outside of the authorized operating frequency ranges must be attenuated below the transmitting power (P) by a factor of at least $43 + 10 \log(P)$ dB.

- §27.53(h)(1), for operations in the 1 695-1 710 MHz, 1 710-1 755 MHz, 1 755-1 780 MHz, 1 915-1 920 MHz, 1 995-2 000 MHz, 2 000-2 020 MHz, 2 110-2 155 MHz, 2 155-2 180 MHz, and 2 180-2 200 bands, the power of any emission outside a licensee's frequency block shall be attenuated below the transmitter power (P) in watts by at least $43 + 10 \log_{10}(P)$ dB.

5.2. Test Procedure

The test follows section 5.7 of ANSI C63.26-2015.

1. Start frequency was set to 9 kHz and stop frequency was set to at least 10* the fundamental frequency.
2. Detector = Peak.
3. Trace mode = Max hold.
4. Sweep time = Auto couple.
5. The trace was allowed to stabilize.
6. Please see notes below for RBW and VBW settings.
7. For plots showing conducted spurious emissions from 9 kHz to 20 GHz, all path loss of wide frequency range was investigated and compensated to spectrum analyzer as correction factor.

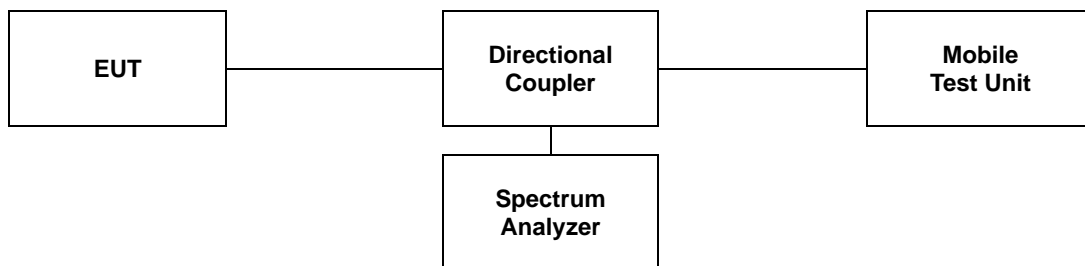

Note;

Compliance with the applicable limits is based on the use of measurement instrumentation employing a resolution bandwidth of 100 kHz or greater for frequencies less than 1 GHz and frequencies greater than 1 GHz. However, in the 1 MHz bands immediately outside and adjacent to the frequency block a resolution bandwidth of at least one percent of the emission bandwidth of the fundamental emission of the transmitter may be employed. The emission bandwidth is defined as the width of the signal between two point, one below the carrier center frequency and one above the carrier center frequency, outside of which all emission are attenuated at least 26 dB below the transmitter power.

The results of this test report are effective only to the items tested. The SGS Korea is not responsible for the sampling, the results of this test report apply to the sample as received. This test report cannot be reproduced, except in full, without prior written permission of the Company. This test report does not assure KOLAS accreditation.

5.3. Test Results

Ambient temperature : (23 ± 1) °C

Relative humidity : 47 % R.H.

- Test plots

WCDMA 2 Low Channel

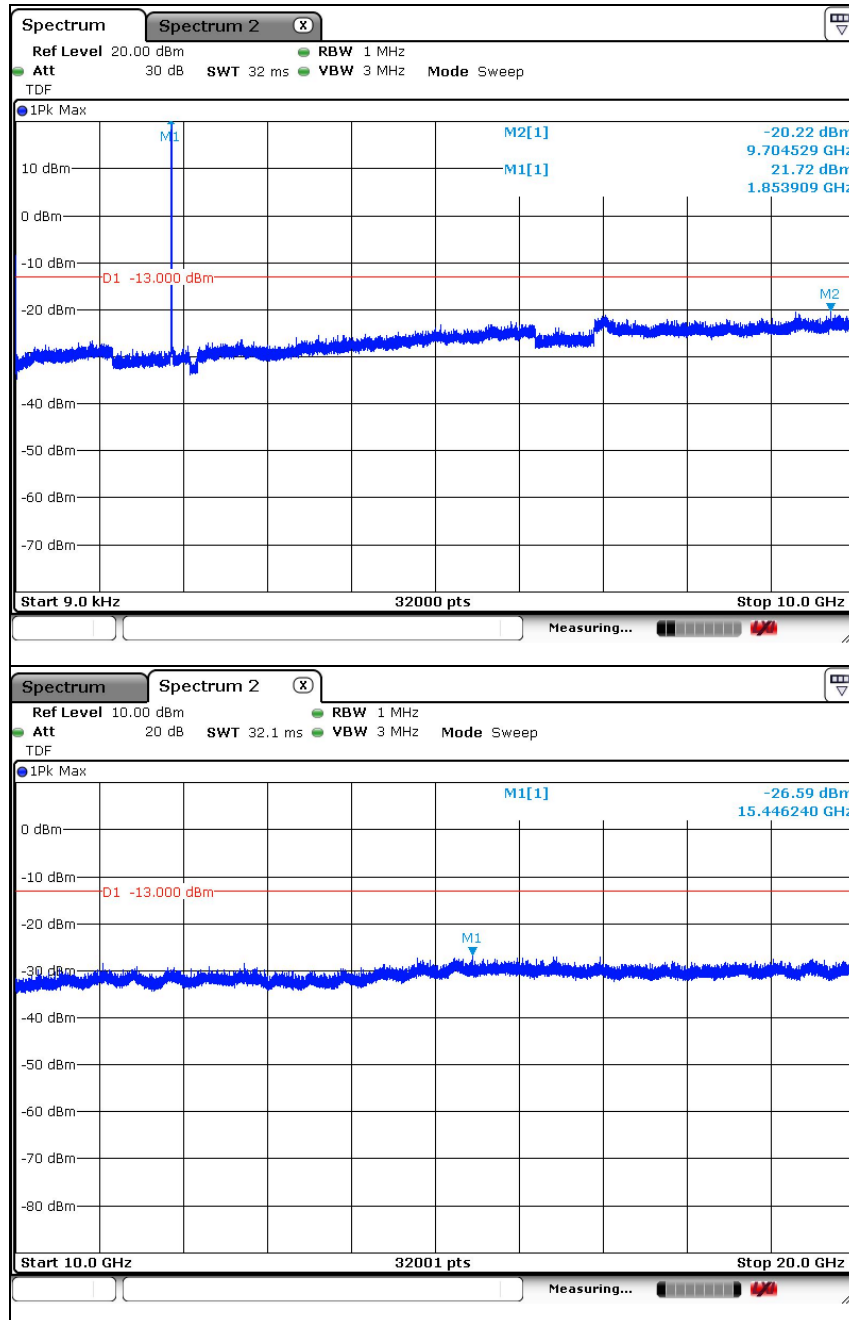

The results of this test report are effective only to the items tested. The SGS Korea is not responsible for the sampling, the results of this test report apply to the sample as received. This test report cannot be reproduced, except in full, without prior written permission of the Company. This test report does not assure KOLAS accreditation.

Middle Channel

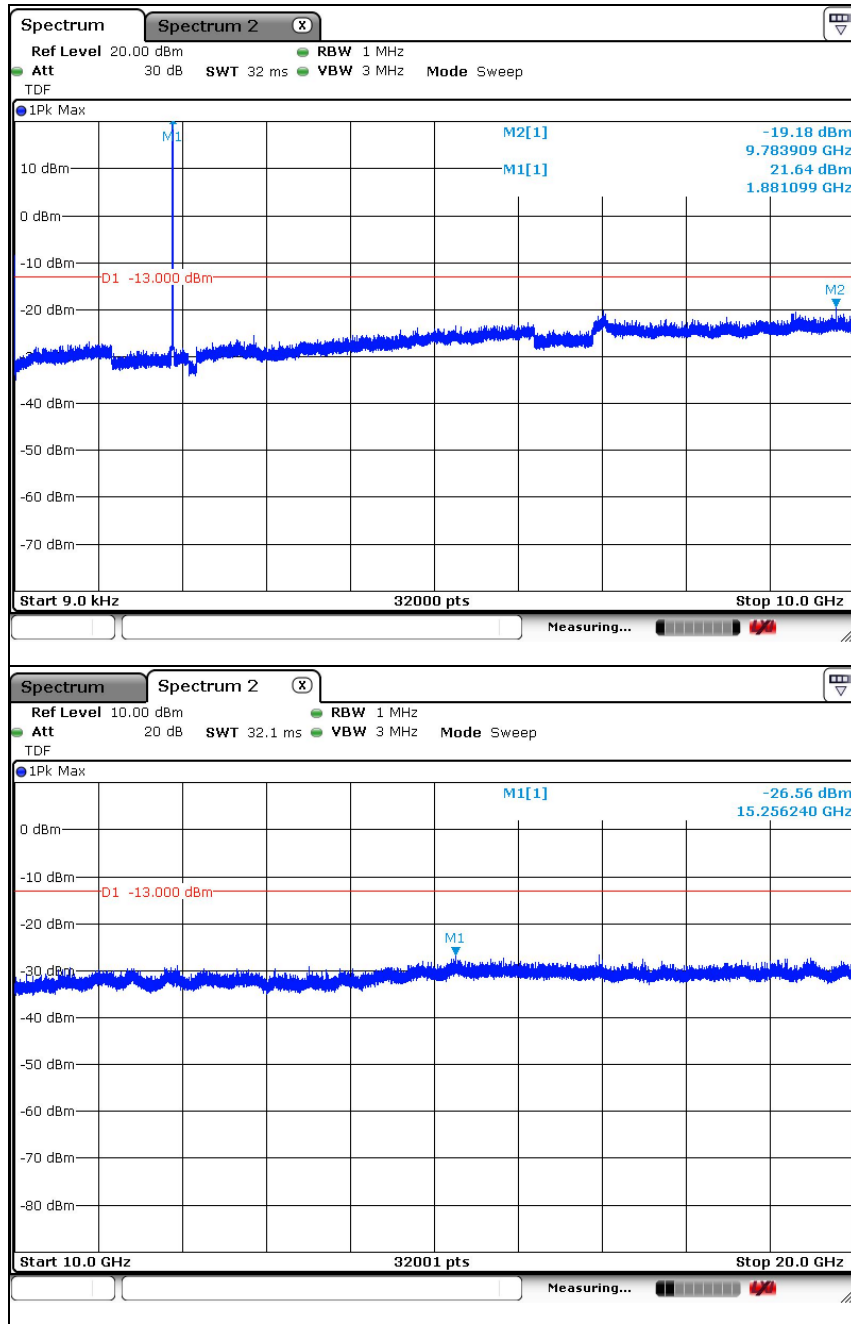

The results of this test report are effective only to the items tested. The SGS Korea is not responsible for the sampling, the results of this test report apply to the sample as received. This test report cannot be reproduced, except in full, without prior written permission of the Company. This test report does not assure KOLAS accreditation.

High Channel

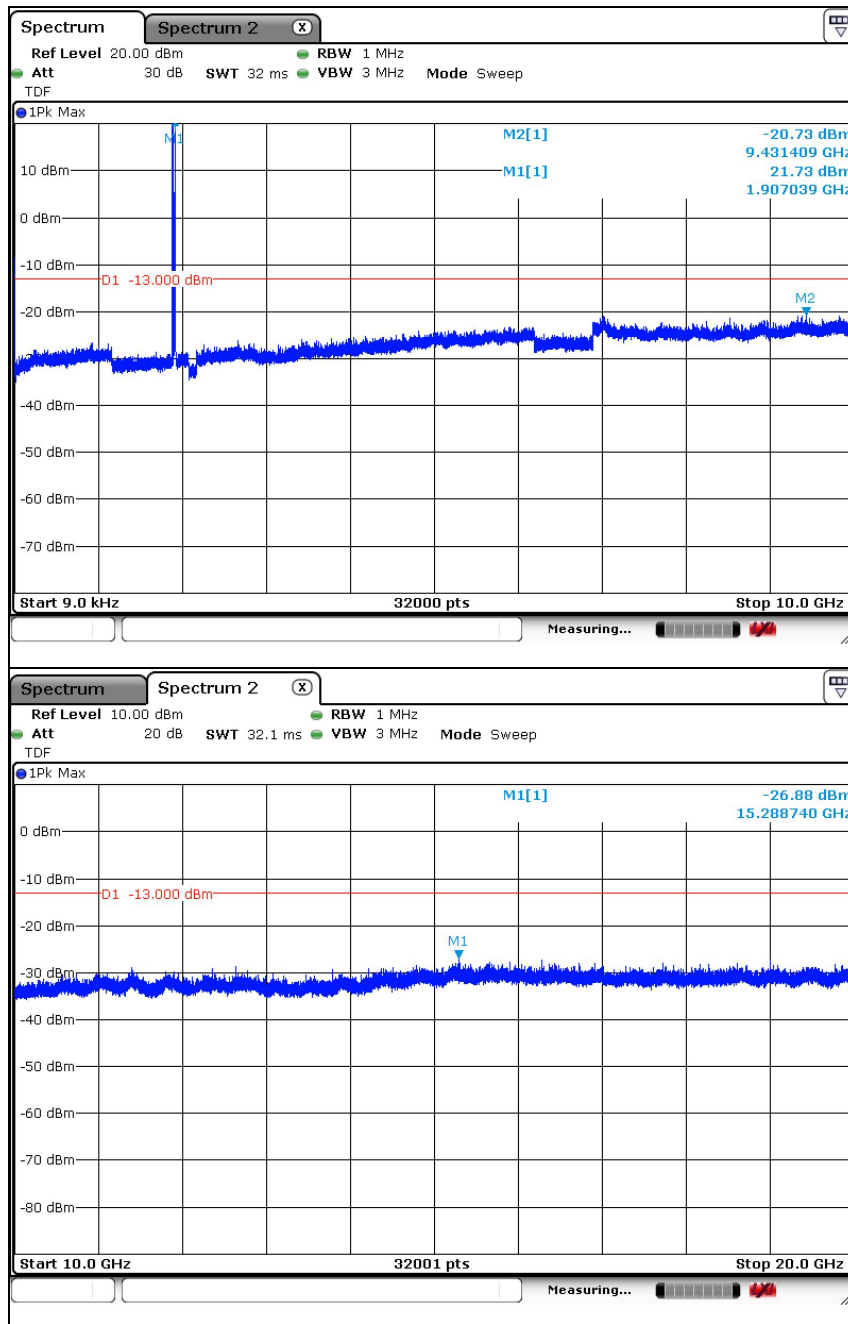

The results of this test report are effective only to the items tested. The SGS Korea is not responsible for the sampling, the results of this test report apply to the sample as received. This test report cannot be reproduced, except in full, without prior written permission of the Company. This test report does not assure KOLAS accreditation.

WCDMA 4
Low Channel

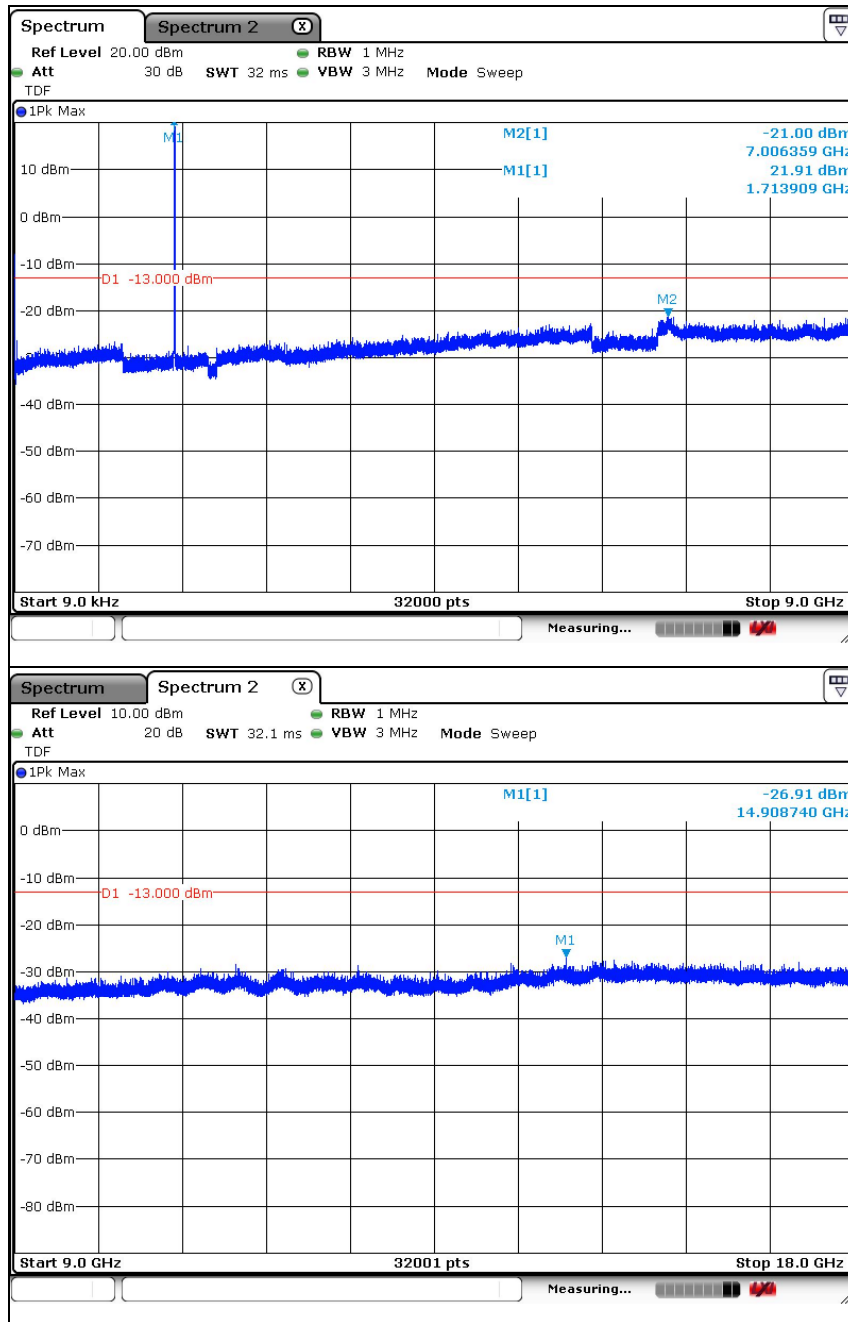

The results of this test report are effective only to the items tested. The SGS Korea is not responsible for the sampling, the results of this test report apply to the sample as received. This test report cannot be reproduced, except in full, without prior written permission of the Company. This test report does not assure KOLAS accreditation.

Middle Channel

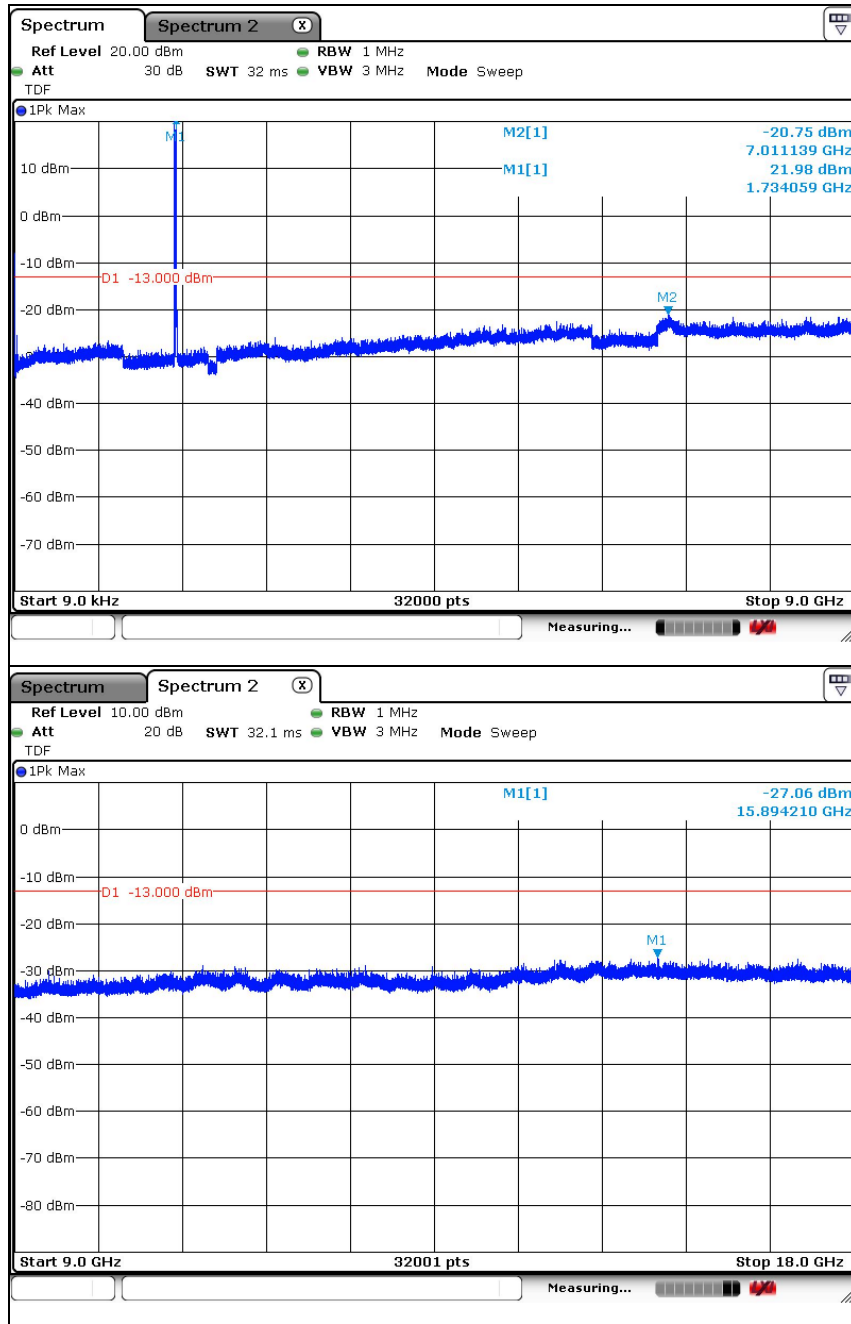

The results of this test report are effective only to the items tested. The SGS Korea is not responsible for the sampling, the results of this test report apply to the sample as received. This test report cannot be reproduced, except in full, without prior written permission of the Company. This test report does not assure KOLAS accreditation.

High Channel

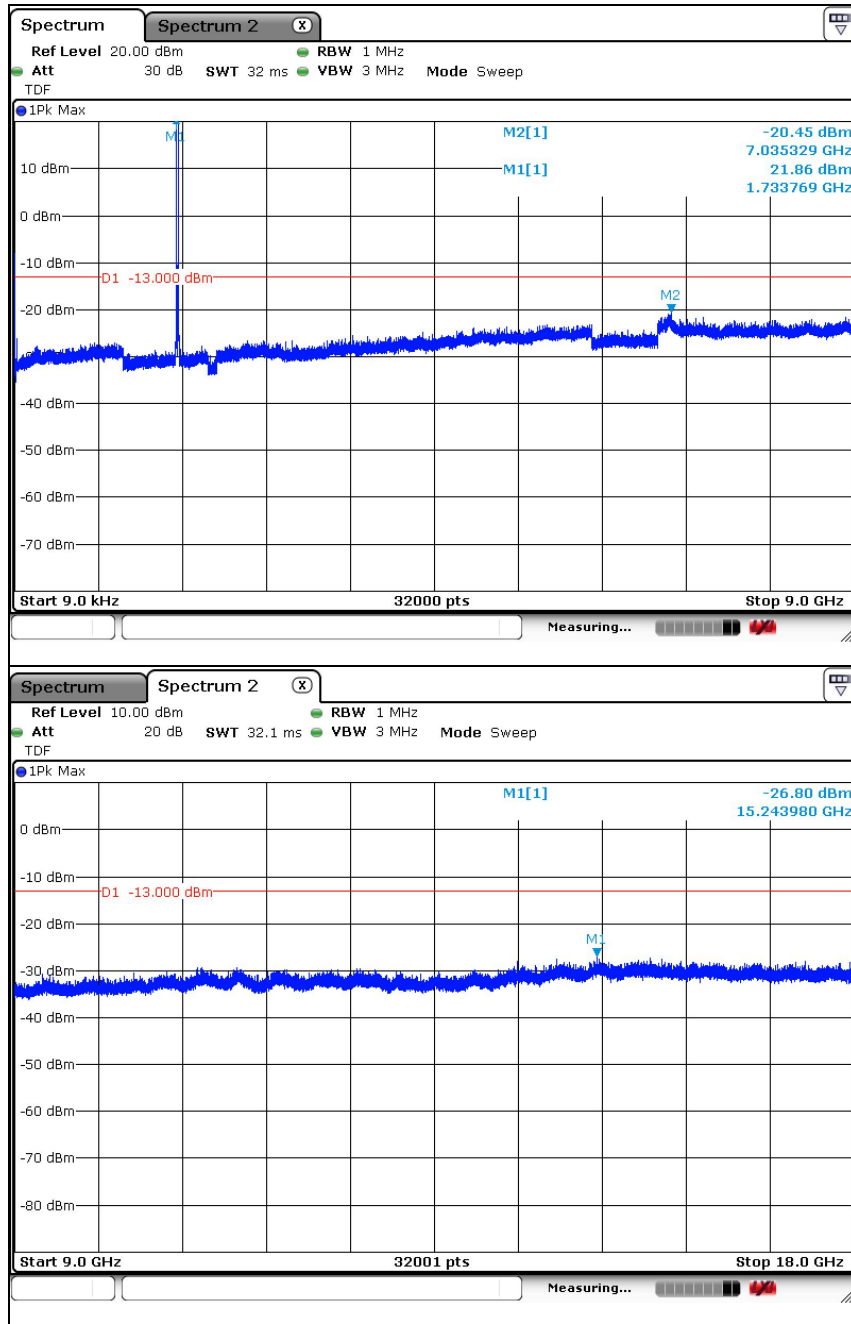

The results of this test report are effective only to the items tested. The SGS Korea is not responsible for the sampling, the results of this test report apply to the sample as received. This test report cannot be reproduced, except in full, without prior written permission of the Company. This test report does not assure KOLAS accreditation.

WCDMA 5 Low Channel

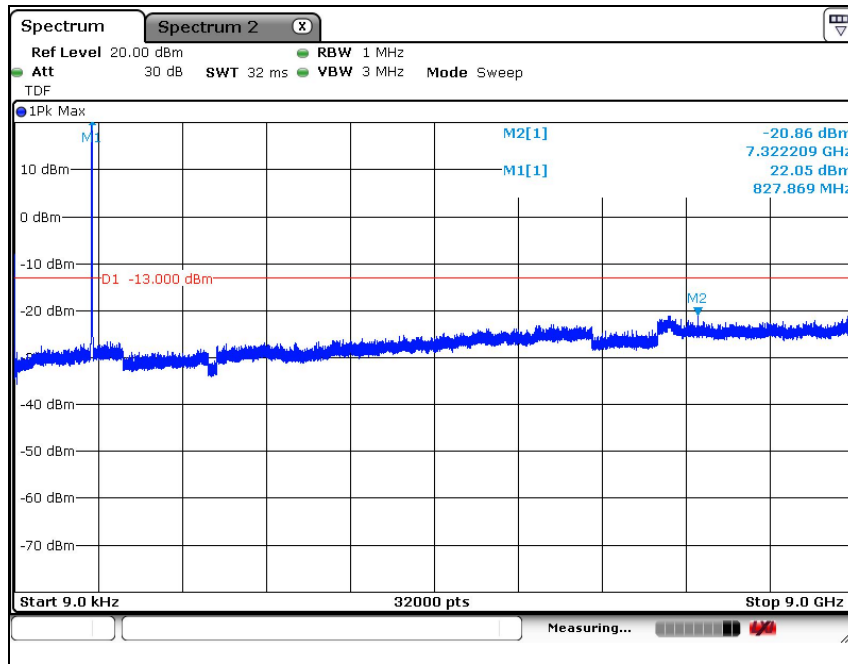

Middle Channel

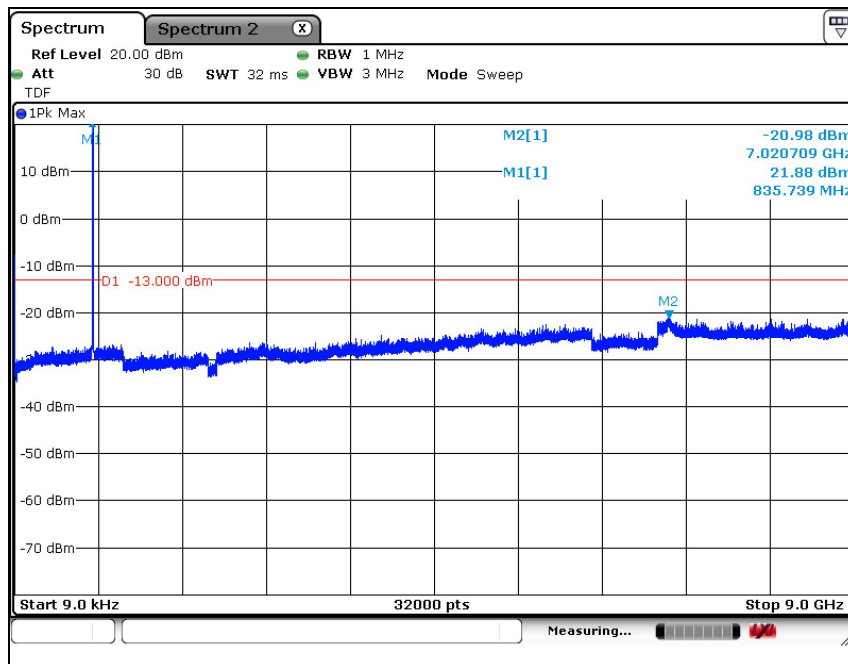

The results of this test report are effective only to the items tested. The SGS Korea is not responsible for the sampling, the results of this test report apply to the sample as received. This test report cannot be reproduced, except in full, without prior written permission of the Company. This test report does not assure KOLAS accreditation.

High Channel

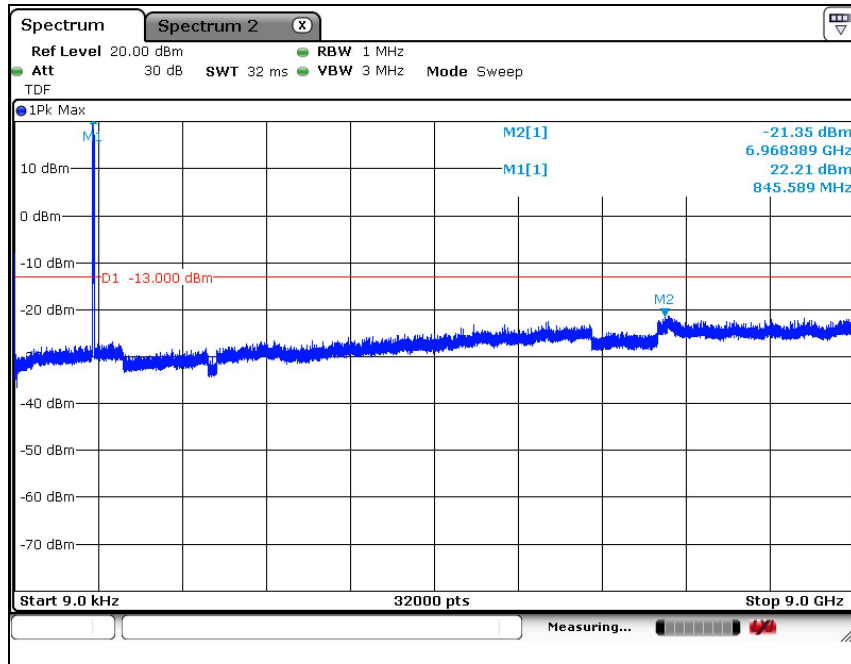

The results of this test report are effective only to the items tested. The SGS Korea is not responsible for the sampling, the results of this test report apply to the sample as received. This test report cannot be reproduced, except in full, without prior written permission of the Company. This test report does not assure KOLAS accreditation.

6. Band Edge

6.1. Limit

- §22.917(a), the power of any emission outside of the authorized operating frequency ranges must be attenuated below the transmitting power (P) by a factor of at least $43 + 10\log(P)$ dB.

- §24.238(a), the power of any emission outside of the authorized operating frequency ranges must be attenuated below the transmitting power (P) by a factor of at least $43 + 10 \log(P)$ dB.

- §27.53(h)(1), for operations in the 1 695-1 710 MHz, 1 710-1 755 MHz, 1 755-1 780 MHz, 1 915-1 920 MHz, 1 995-2 000 MHz, 2 000-2 020 MHz, 2 110-2 155 MHz, 2 155-2 180 MHz, and 2 180-2 200 bands, the power of any emission outside a licensee's frequency block shall be attenuated below the transmitter power (P) in watts by at least $43 + 10 \log_{10}(P)$ dB.

6.2. Test Procedure

The test follows section 5.7.2 of ANSI C63.26-2015.

- a. Span was set large enough so as to capture all out of band emissions near the band edge.
- b. RBW ≥ 1 % of OBW
- c. VBW ≥ 3 x RBW.
- d. Detector = RMS.
- e. Trace mode = Average.
- f. Sweep time = Auto.
- g. The trace was allowed to stabilize.
- h. All path loss of frequency range was investigated and compensated to spectrum analyzer as TDF function.

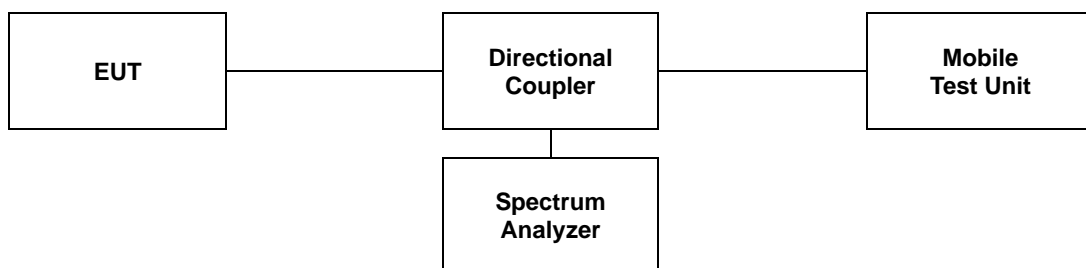

The results of this test report are effective only to the items tested. The SGS Korea is not responsible for the sampling, the results of this test report apply to the sample as received. This test report cannot be reproduced, except in full, without prior written permission of the Company. This test report does not assure KOLAS accreditation.

7.3. Test Results

Ambient temperature : (23 ± 1) °C

Relative humidity : 47 % R.H.

- Test plots

WCDMA 2

Low Channel

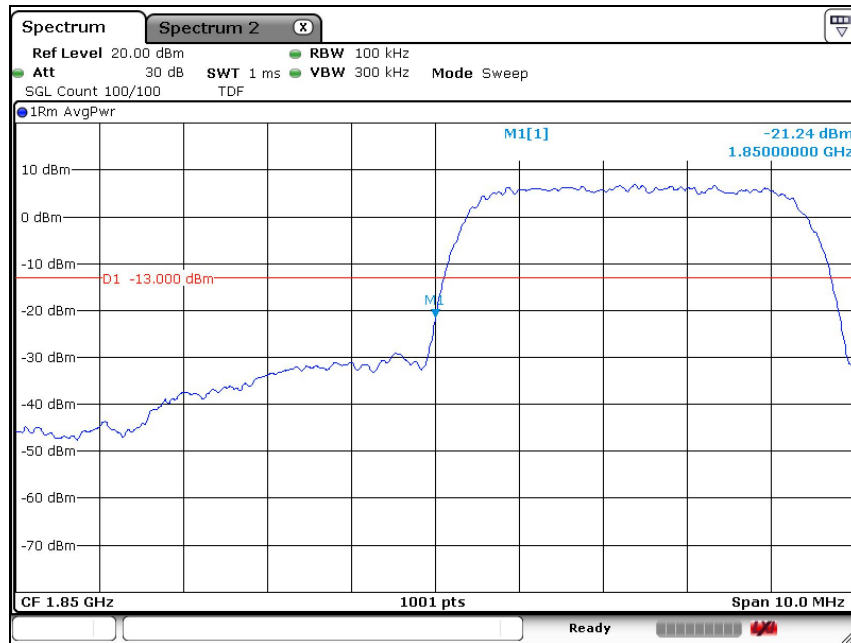

High Channel

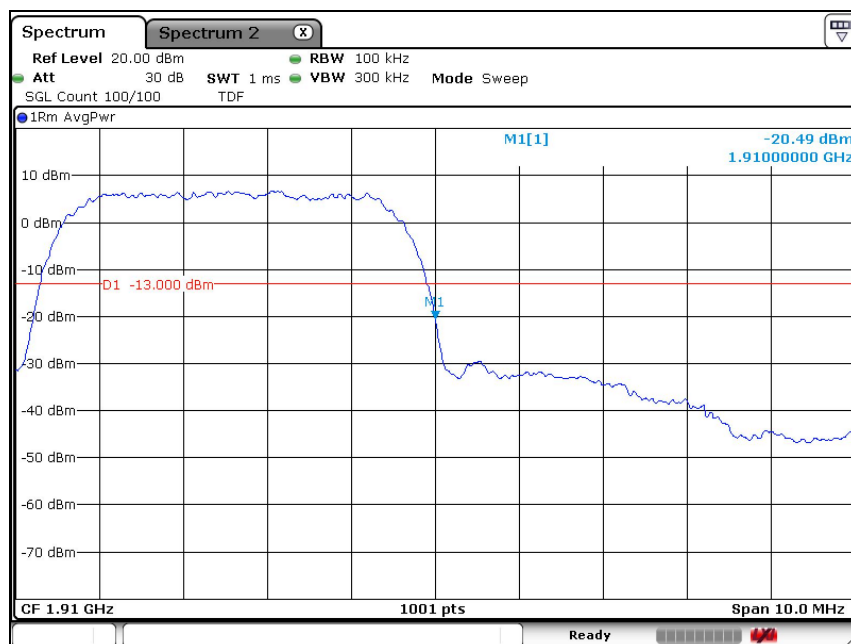

The results of this test report are effective only to the items tested. The SGS Korea is not responsible for the sampling, the results of this test report apply to the sample as received. This test report cannot be reproduced, except in full, without prior written permission of the Company. This test report does not assure KOLAS accreditation.

WCDMA 4 Low Channel

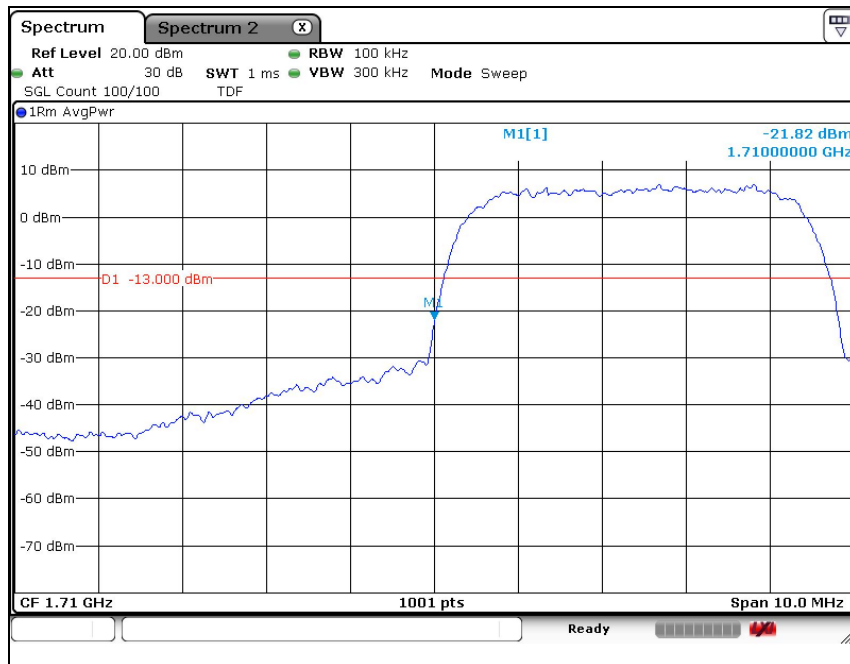

High Channel

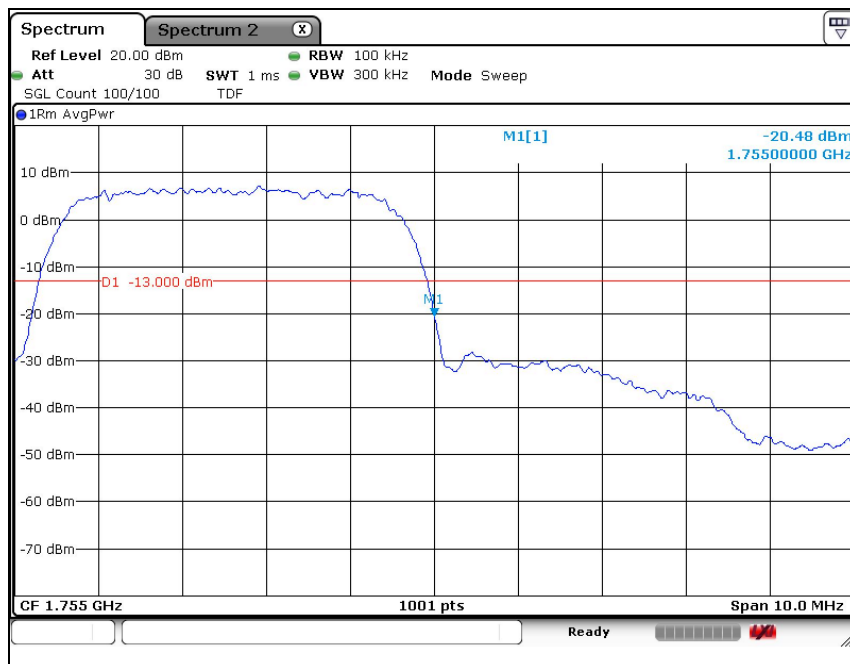

The results of this test report are effective only to the items tested. The SGS Korea is not responsible for the sampling, the results of this test report apply to the sample as received. This test report cannot be reproduced, except in full, without prior written permission of the Company. This test report does not assure KOLAS accreditation.

WCDMA 5
Low Channel

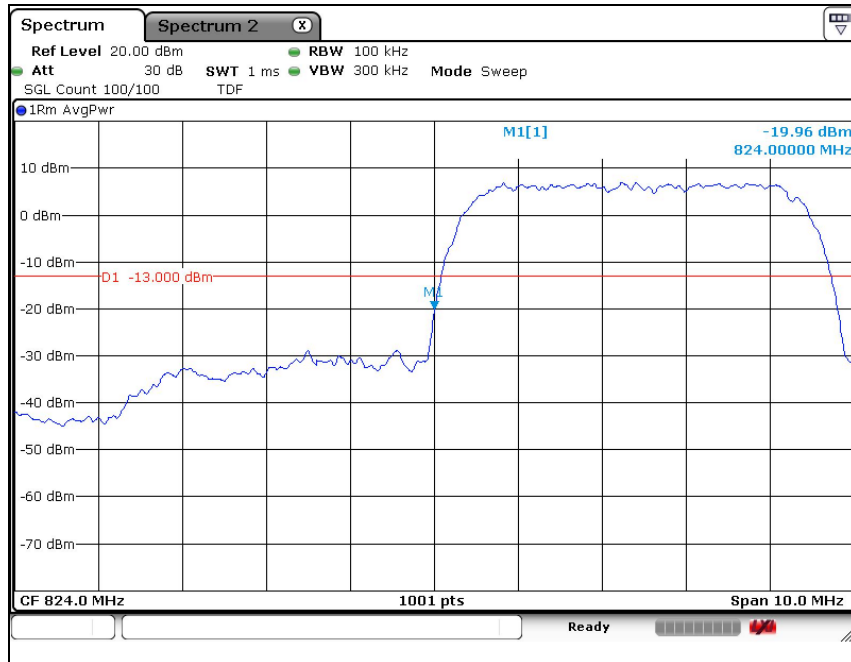

High Channel

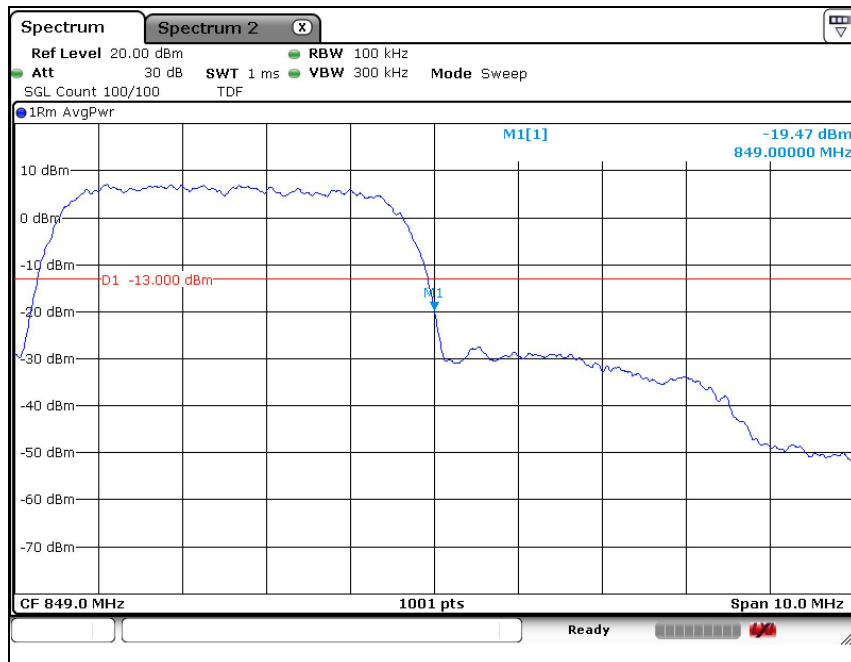

The results of this test report are effective only to the items tested. The SGS Korea is not responsible for the sampling, the results of this test report apply to the sample as received. This test report cannot be reproduced, except in full, without prior written permission of the Company. This test report does not assure KOLAS accreditation.

7. Frequency Stability

7.1. Limit

- § 2.1055(a), § 2.1055(d) & following:

- §22.355, the carrier frequency of each transmitter in the Public Mobile Services must be maintained within the tolerances given in Table of this section.

For Mobile devices operating in the 824 to 849 MHz band at a power level less than or equal to 3 Watts, the limit specified in Table C-1 is +/- 2.5 ppm.

- §24.235, the frequency stability shall be sufficient to ensure that the fundamental emission stays within the authorized frequency block.

- §27.54, the frequency stability shall be sufficient to ensure that the fundamental emissions stay within the authorized bands of operation.

7.2. Test Procedure

1. Frequency Stability vs. Temperature: The equipment under test was connected to an external DC power supply and the RF output was connected to a Mobile Test Unit via feed-through attenuators.
2. The EUT was placed inside the temperature chamber.
3. After the temperature stabilized for approximately 20 minutes, the frequency output was recorded from Mobile Test Unit.

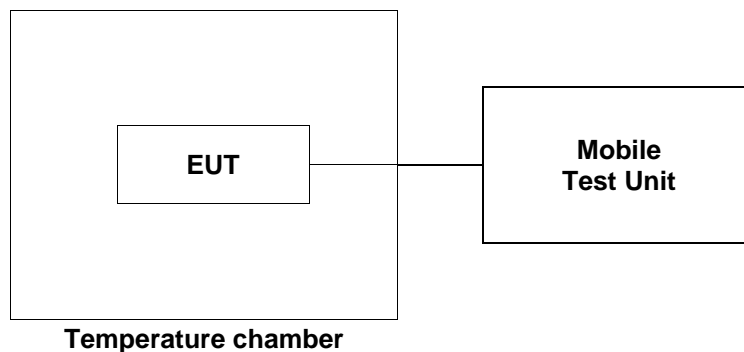

The results of this test report are effective only to the items tested. The SGS Korea is not responsible for the sampling, the results of this test report apply to the sample as received. This test report cannot be reproduced, except in full, without prior written permission of the Company. This test report does not assure KOLAS accreditation.

7.3. Test Results

Ambient temperature : (23 ± 1) °C
 Relative humidity : 47 % R.H.

WCDMA 2 mode at middle channel

Reference Frequency: 1 880.0 MHz			
Frequency Stability versus Temperature			
Environment Temperature (°C)	Power Supplied (V _{d.c.})	Frequency Measure with Time Elapse	
		Frequency Error (Hz)	ppm
50	3.8	3	0.001 6
40		4	0.002 1
30		-2	-0.001 1
23		5	0.002 7
10		-3	-0.001 6
0		1	0.000 5
-10		2	0.001 1
-20		-3	-0.001 6
-30		4	0.002 1
Frequency Stability versus Power Supply			
Environment Temperature (°C)	Power Supplied (V _{d.c.})	Frequency Measure with Time Elapse	
		Frequency Error (Hz)	ppm
23	4.37	5	0.002 7
	3.23	-3	-0.001 6

The results of this test report are effective only to the items tested. The SGS Korea is not responsible for the sampling, the results of this test report apply to the sample as received. This test report cannot be reproduced, except in full, without prior written permission of the Company. This test report does not assure KOLAS accreditation.

WCDMA 4 mode at middle channel

Reference Frequency: 1 732.6 MHz			
Frequency Stability versus Temperature			
Environment Temperature (°C)	Power Supplied (V _{d.c})	Frequency Measure with Time Elapse	
		Frequency Error (Hz)	ppm
50	3.8	5	0.002 9
40		2	0.001 2
30		-1	-0.000 6
23		3	0.001 7
10		-4	-0.002 3
0		-2	-0.001 2
-10		-2	-0.001 2
-20		3	0.001 7
-30		-4	-0.002 3
Frequency Stability versus Power Supply			
Environment Temperature (°C)	Power Supplied (V _{d.c})	Frequency Measure with Time Elapse	
		Frequency Error (Hz)	ppm
23	4.37	-2	-0.001 2
	3.23	-3	-0.001 7

The results of this test report are effective only to the items tested. The SGS Korea is not responsible for the sampling, the results of this test report apply to the sample as received. This test report cannot be reproduced, except in full, without prior written permission of the Company. This test report does not assure KOLAS accreditation.

WCDMA 5 mode at middle channel

Reference Frequency: 836.6 MHz			
Frequency Stability versus Temperature			
Environment Temperature (°C)	Power Supplied (V _{d.c})	Frequency Measure with Time Elapse	
		Frequency Error (Hz)	ppm
50	3.8	-2	-0.001 2
40		4	0.002 3
30		2	0.001 2
23		-4	-0.002 3
10		-2	-0.001 2
0		2	0.001 2
-10		1	0.000 6
-20		1	0.000 6
-30		-5	-0.002 9
Frequency Stability versus Power Supply			
Environment Temperature (°C)	Power Supplied (V _{d.c})	Frequency Measure with Time Elapse	
		Frequency Error (Hz)	ppm
23	4.37	-3	-0.001 7
	3.23	4	0.002 3

- End of the Test Report -

The results of this test report are effective only to the items tested. The SGS Korea is not responsible for the sampling, the results of this test report apply to the sample as received. This test report cannot be reproduced, except in full, without prior written permission of the Company. This test report does not assure KOLAS accreditation.