

# FCC RF Test Report

APPLICANT : Franklin Technology Inc.  
EQUIPMENT : 5G RF module  
MODEL NAME : M2500  
FCC ID : XHG-M2500  
STANDARD : 47 CFR Part 2, 27(O)  
CLASSIFICATION : PCS Licensed Transmitter (PCB)  
TEST DATE(S) : Jul. 08, 2021 ~ Jul. 19, 2021

We, Sporton International Inc. (Kunshan), would like to declare that the tested sample has been evaluated in accordance with the procedures given in ANSI C63.26-2015 and shown compliance with the applicable technical standards.

This report contains data that were produced under subcontract by Sporton International Inc. (Shenzhen).

The test results in this report apply exclusively to the tested model / sample. Without written approval of Sporton International Inc. (Kunshan), the test report shall not be reproduced except in full.

Jason Jia

Approved by: Jason Jia



**Sporton International Inc. (Kunshan)**

**No. 1098, Pengxi North Road, Kunshan Economic Development Zone Jiangsu Province 215300  
People's Republic of China**



TABLE OF CONTENTS

REVISION HISTORY... 3
SUMMARY OF TEST RESULT ... 4
1 GENERAL DESCRIPTION ... 5
1.1 Applicant ... 5
1.2 Manufacturer ... 5
1.3 Product Feature of Equipment Under Test ... 5
1.4 Product Specification of Equipment Under Test ... 5
1.5 Modification of EUT ... 5
1.6 Maximum Conducted Power and Emission Designator ... 6
1.7 Testing Site ... 6
1.8 Test Software ... 7
1.9 Applied Standards ... 7
2 TEST CONFIGURATION OF EQUIPMENT UNDER TEST ... 8
2.1 Test Mode ... 8
2.2 Connection Diagram of Test System ... 9
2.3 Support Unit used in test configuration and system ... 9
2.4 Measurement Results Explanation Example ... 9
2.5 Frequency List of Low/Middle/High Channels ... 10
3 CONDUCTED TEST ITEMS ... 11
3.1 Measuring Instruments ... 11
3.2 Test Setup ... 11
3.3 Test Result of Conducted Test ... 11
3.4 Conducted Output Power and EIRP ... 12
3.5 Peak-to-Average Ratio ... 13
3.6 Occupied Bandwidth ... 14
3.7 Conducted Band Edge ... 15
3.8 Conducted Spurious Emission ... 16
3.9 Frequency Stability ... 17
4 RADIATED TEST ITEMS ... 18
4.1 Measuring Instruments ... 18
4.2 Test Setup ... 18
4.3 Test Result of Radiated Test ... 19
4.4 Radiated Spurious Emission Measurement ... 20
5 LIST OF MEASURING EQUIPMENT ... 21
6 UNCERTAINTY OF EVALUATION ... 22
APPENDIX A. TEST RESULTS OF CONDUCTED TEST
APPENDIX B. TEST RESULTS OF RADIATED TEST
APPENDIX C. TEST SETUP PHOTOGRAPHS



### REVISION HISTORY

REPORT NO.	VERSION	DESCRIPTION	ISSUED DATE
FG262007F	Rev. 01	Initial issue of report	Aug. 23, 2022



### SUMMARY OF TEST RESULT

Report Section	FCC Rule	Description	Limit	Result	Remark
3.4	§2.1046	Conducted Output Power	Reporting Only	PASS	-
	§27.50(j)(3)	Equivalent Isotropic Radiated Power (5G NR n77)	EIRP < 1Watt		
3.5	§27.50(j)(4)	Peak-to-Average Ratio	<13 dB	PASS	-
3.6	§2.1049	Occupied Bandwidth	Reporting Only	PASS	-
3.7	§2.1051 §27.53(l)(2)	Conducted Band Edge Measurement (5G NR n77)	< 43+10log <sub>10</sub> (P[Watts])	PASS	-
3.8	§2.1051 §27.53(l)(2)	Conducted Spurious Emission (5G NR n77)	< 43+10log <sub>10</sub> (P[Watts])	PASS	-
3.9	§27.54	Frequency Stability Temperature & Voltage	Within Authorized Band	PASS	-
4.4	§2.1053 §27.53(l)(2)	Radiated Spurious Emission (5G NR n77)	< 43+10log <sub>10</sub> (P[Watts])	PASS	Under limit 22.81 dB at 7584.000 MHz

**Declaration of Conformity:**

The test results with all measurement uncertainty excluded are presented in accordance with the regulation limits or requirements declared by manufacturers.

**Comments and Explanations:**

The declared of product specification for EUT presented in the report are provided by the manufacturer, and the manufacturer takes all the responsibilities for the accuracy of product specification.

# 1 General Description

## 1.1 Applicant

**Franklin Technology Inc.**

906 JEI Platz, 186, Gasan digital 1-ro, Gumcheon-Gu, Seoul, South Korea, 08502

## 1.2 Manufacturer

**Franklin Technology Inc.**

906 JEI Platz, 186, Gasan digital 1-ro, Gumcheon-Gu, Seoul, South Korea, 08502

## 1.3 Product Feature of Equipment Under Test

Product Feature	
<b>Equipment</b>	5G RF module
<b>Model Name</b>	M2500
<b>FCC ID</b>	XHG-M2500
<b>IMEI Code</b>	Conducted : 358563790001254 Radiation : 358563790000926
<b>HW Version</b>	P1
<b>SW Version</b>	RG2100.TM.1354
<b>EUT Stage</b>	Identical Prototype

## 1.4 Product Specification of Equipment Under Test

Product Feature	
<b>Tx/Rx Frequency</b>	5G NR n77: 3700 MHz ~ 3980 MHz
<b>SCS</b>	30kHz
<b>Bandwidth</b>	n77: 10 / 15 / 20 / 30 / 40 / 50 / 60 / 70 / 80 / 90 / 100 MHz
<b>Maximum Output Power to Antenna</b>	5G NR n77 : 24.79 dBm
<b>Antenna Gain</b>	5G NR n77 : -1.49 dBi
<b>Type of Modulation</b>	CP-OFDM: QPSK / 16QAM / 64QAM / 256QAM DFT-s-OFDM: PI/2 BPSK / QPSK / 16QAM / 64QAM / 256QAM

**Remark:** 5G NR n77 supports HPUE mode and SA mode only.

## 1.5 Modification of EUT

No modifications are made to the EUT during all test items.

### 1.6 Maximum Conducted Power and Emission Designator

5G NR n77		PI/2 BPSK / QPSK		16QAM / 64QAM / 256QAM	
BW (MHz)	Frequency Range (MHz)	Maximum Conducted power (W)	Emission Designator (99%OBW)	Maximum Conducted power (W)	Emission Designator (99%OBW)
10	3705.00 ~ 3975.00	0.2985	8M60G7D	0.2404	8M61W7D
15	3707.52 ~ 3972.48	0.2999	13M6G7D	0.2460	13M6W7D
20	3710.01 ~ 3969.99	0.2884	18M2G7D	0.2466	18M3W7D
30	3715.02 ~ 3964.98	0.2897	27M9G7D	0.2553	27M9W7D
40	3720.00 ~ 3960.00	0.2917	37M9G7D	0.2673	37M8W7D
50	3725.01 ~ 3954.99	0.3006	47M5G7D	0.2477	47M5W7D
60	3730.02 ~ 3949.98	0.2793	58M0G7D	0.2286	57M9W7D
70	3735.00 ~ 3945.00	0.2667	67M5G7D	0.2198	67M5W7D
80	3740.01 ~ 3939.99	0.2600	77M5G7D	0.2138	77M7W7D
90	3745.02 ~ 3934.98	0.2553	87M4G7D	0.2143	87M7W7D
100	3750.00 ~ 3930.00	0.3013	97M7G7D	0.2173	97M7W7D

Note: All modulations have been tested, and only the worst test results of PSK & QAM are shown in the report .

### 1.7 Testing Site

Sporton International Inc. (Kunshan) is accredited to ISO/IEC 17025:2017 by American Association for Laboratory Accreditation with Certificate Number 5145.02.

<b>Test Firm</b>	Sporton International Inc. (Kunshan)		
<b>Test Site Location</b>	No. 1098, Pengxi North Road, Kunshan Economic Development Zone Jiangsu Province 215300 People's Republic of China TEL : +86-512-57900158 FAX : +86-512-57900958		
<b>Test Site No.</b>	<b>Sporton Site No.</b>	<b>FCC Designation No.</b>	<b>FCC Test Firm Registration No.</b>
	03CH04-KS	CN1257	314309



Sporton International Inc. (Shenzhen) is accredited to ISO/IEC 17025:2017 by American Association for Laboratory Accreditation with Certificate Number 5145.01.

<b>Test Firm</b>	Sporton International Inc. (Shenzhen)		
<b>Test Site Location</b>	1/F, 2/F, Bldg 5, Shiling Industrial Zone, Xinwei Village, Xili, Nanshan, Shenzhen, 518055 People's Republic of China TEL: +86-755-86379589 FAX: +86-755-86379595		
<b>Test Site No.</b>	<b>Sporton Site No.</b>	<b>FCC Designation No.</b>	<b>FCC Test Firm Registration No.</b>
	TH01-SZ	CN1256	421272

Note: Test data subcontracted: Conducted test cases in section 3 of this report

### 1.8 Test Software

Item	Site	Manufacturer	Name	Version
1.	03CH04-KS	AUDIX	E3	6.2009-8-24a

### 1.9 Applied Standards

According to the specifications of the manufacturer, the EUT must comply with the requirements of the following standards:

- 47 CFR Part 2, Part 27
- ANSI C63.26-2015
- FCC KDB 971168 D01 Power Meas License Digital Systems v03r01
- FCC KDB 412172 D01 Determining ERP and EIRP v01r01
- 

**Remark:** All test items were verified and recorded according to the standards and without any deviation during the test.

## 2 Test Configuration of Equipment Under Test

### 2.1 Test Mode

Antenna port conducted and radiated test items are performed according to KDB 971168 D01 Power Meas License Digital Systems v03r01 with maximum output power.

For radiated measurement, pre-scanned in three orthogonal panels, X, Y, Z. The worst cases (Z plane) were recorded in this report.

The device is investigated from 30MHz to 10 times of fundamental signal for radiated spurious emission test under different RB size/offset and modulations in exploratory test. Subsequently, only the worst case emissions are reported.

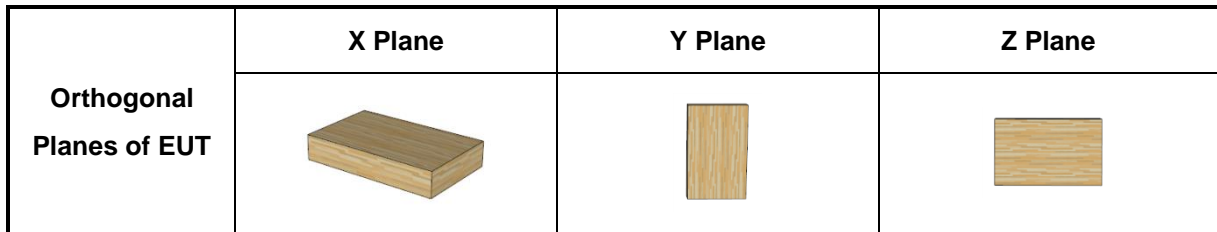

Test Items	5G NR	Bandwidth (MHz)									Modulation					RB #		Test Channel		
		10	15	20	30	40	50	60	70-90	100	PI/2 BPSK	QPSK	16QAM	64QAM	256 QAM	1	Full	L	M	H
Max. Output Power	n77	v	v	v	v	v	v	v	v	v	v	v	v	v	v	v	v	v	v	v
Peak-to-Average Ratio	n77			v							v	v					v		v	
26dB and 99% Bandwidth	n77	v	v	v	v	v	v	v	v	v	v	v	v	v	v		v		v	
Conducted Band Edge	n77	v					v			v	v					v	v	v		v
Conducted Spurious Emission	n77	v					v			v	v					v		v	v	v
Frequency Stability	n77			v								v					v		v	
E.R.P / E.I.R.P	n77	v	v	v	v	v	v	v	v	v	v	v	v	v	v	v	v	v	v	v
Radiated Spurious Emission	n77	Worst Case																	v	
Note	<ol style="list-style-type: none"> <li>The mark "v" means that this configuration is chosen for testing</li> <li>The mark "-" means that this bandwidth is not supported.</li> <li>The device is investigated from 30MHz to 10 times of fundamental signal for radiated spurious emission test under different RB size/offset and modulations in exploratory test. Subsequently, only the worst case emissions are reported.</li> <li>Normal Voltage: 3.8Vdc, Extreme Voltage: 3.6Vdc ~4.2Vdc</li> </ol>																			



## 2.2 Connection Diagram of Test System

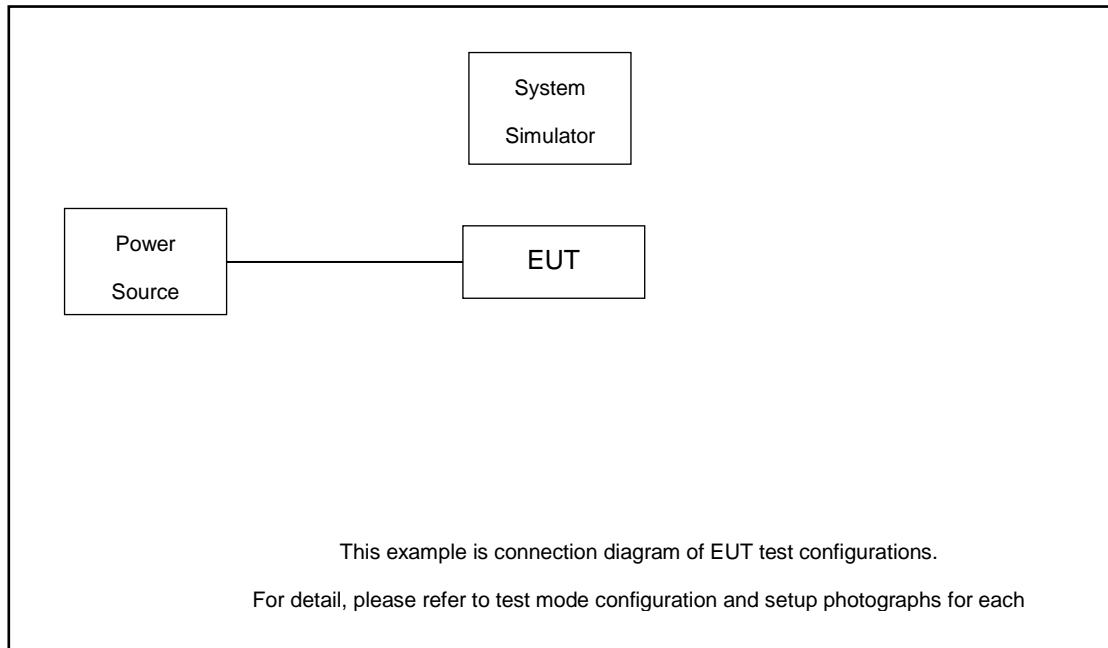

## 2.3 Support Unit used in test configuration and system

Item	Equipment	Trade Name	Model No.	FCC ID	Data Cable	Power Cord
1.	DC Power Supply	GW	GPS-3030D	N/A	N/A	Unshielded, 1.8 m
2.	LTE Base Station	Anritsu	MT8821C	N/A	N/A	Unshielded, 1.8 m
3.	NR Base Station	Anritsu	MT8000A	N/A	N/A	Unshielded, 1.8 m
4.	Adapter	N/A	N/A	N/A	N/A	N/A
5.	Test Jig	N/A	N/A	N/A	N/A	N/A

## 2.4 Measurement Results Explanation Example

### For all conducted test items:

The offset level is set in the spectrum analyzer to compensate the RF cable loss and attenuator factor between EUT conducted output port and spectrum analyzer. With the offset compensation, the spectrum analyzer reading level is exactly the EUT RF output level.

The spectrum analyzer offset is derived from RF cable loss.

$$\text{Offset} = \text{RF cable loss}$$

Following shows an offset computation example with cable loss 7.8 dB.

Example :

$$\begin{aligned} \text{Offset(dB)} &= \text{RF cable loss(dB)}. \\ &= 7.8 \text{ (dB)} \end{aligned}$$

## 2.5 Frequency List of Low/Middle/High Channels

5G n77 Channel and Frequency List				
BW [MHz]	Channel/Frequency(MHz)	Lowest	Middle	Highest
100	Channel	650000	656000	662000
	Frequency	3750	3840	3930
90	Channel	649668	656000	662332
	Frequency	3745.02	3840	3934.98
80	Channel	649334	656000	662666
	Frequency	3740.01	3840	3939.99
70	Channel	649000	656000	663000
	Frequency	3735	3840	3945
60	Channel	648668	656000	663332
	Frequency	3730.02	3840	3949.98
50	Channel	648334	656000	663666
	Frequency	3725.01	3840	3954.99
40	Channel	648000	656000	664000
	Frequency	3720	3840	3960
30	Channel	647668	656000	664332
	Frequency	3715.02	3840	3964.98
20	Channel	647334	656000	664666
	Frequency	3710.01	3840	3969.99
15	Channel	647168	656000	664832
	Frequency	3707.52	3840	3972.48
10	Channel	647000	656000	665000
	Frequency	3705	3840	3975

### 3 Conducted Test Items

#### 3.1 Measuring Instruments

See list of measuring instruments of this test report.

#### 3.2 Test Setup

##### 3.2.1 Conducted Output Power

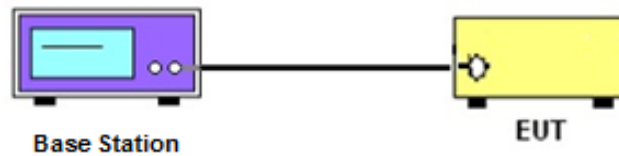

##### 3.2.2 Peak-to-Average Ratio, Occupied / 26dB Bandwidth ,Band-Edge and Conducted Spurious Emission

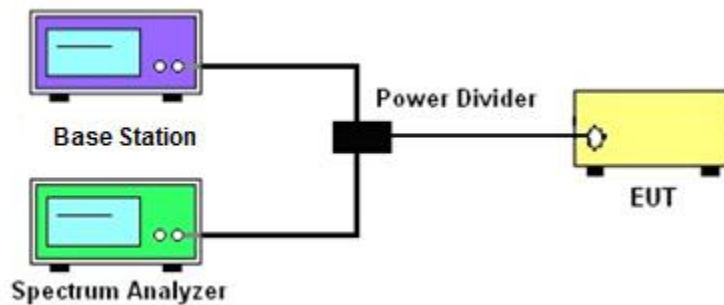

##### 3.2.3 Frequency Stability



### 3.3 Test Result of Conducted Test

Please refer to Appendix A.

### 3.4 Conducted Output Power and EIRP

#### 3.4.1 Description of the Conducted Output Power Measurement and EIRP Measurement

A system simulator was used to establish communication with the EUT. Its parameters were set to force the EUT transmitting at maximum output power. The measured power in the radio frequency on the transmitter output terminals shall be reported.

The EIRP of mobile transmitters must not exceed 1 Watts for 5G NR n77.

According to KDB 412172 D01 Power Approach,

$EIRP = P_T + G_T - L_C$ ,  $ERP = EIRP - 2.15$ , where

$P_T$  = transmitter output power in dBm

$G_T$  = gain of the transmitting antenna in dBi

$L_C$  = signal attenuation in the connecting cable between the transmitter and antenna in dB

#### 3.4.2 Test Procedures

1. The testing follows ANSI C63.26 Section 5.2
2. The transmitter output port was connected to the system simulator.
3. Set EUT at maximum power through the system simulator.
4. Select lowest, middle, and highest channels for each band and different modulation.
5. Measure and record the power level from the system simulator.

## **3.5 Peak-to-Average Ratio**

### **3.5.1 Description of the PAR Measurement**

Power Complementary Cumulative Distribution Function (CCDF) curves provide a means for characterizing the power peaks of a digitally modulated signal on a statistical basis. A CCDF curve depicts the probability of the peak signal amplitude exceeding the average power level. Most contemporary measurement instrumentation include the capability to produce CCDF curves for an input signal provided that the instrument's resolution bandwidth can be set wide enough to accommodate the entire input signal bandwidth. In measuring transmissions in this band using an average power technique, the peak-to-average ratio (PAR) of the transmission may not exceed 13 dB.

### **3.5.2 Test Procedures**

1. The testing follows ANSI C63.26 Section 5.2.3.4 (CCDF).
2. The EUT was connected to spectrum and system simulator via a power divider.
3. Set the CCDF (Complementary Cumulative Distribution Function) option in spectrum analyzer.
4. The highest RF powers were measured and recorded the maximum PAPR level associated with a probability of 0.1 %.
5. Record the deviation as Peak to Average Ratio.

## 3.6 Occupied Bandwidth

### 3.6.1 Description of Occupied Bandwidth Measurement

The occupied bandwidth is the width of a frequency band such that, below the lower and above the upper frequency limits, the mean powers emitted are each equal to a specified percentage 0.5% of the total mean transmitted power.

The 26 dB emission bandwidth is defined as the frequency range between two points, one above and one below the carrier frequency, at which the spectral density of the emission is attenuated 26 dB below the maximum in-band spectral density of the modulated signal. Spectral density (power per unit bandwidth) is to be measured with a detector of resolution bandwidth equal to approximately 1.0% of the emission bandwidth.

### 3.6.2 Test Procedures

1. The testing follows ANSI C63.26 Section 5.4
2. The EUT was connected to spectrum analyzer and system simulator via a power divider.
3. The spectrum analyzer center frequency is set to the nominal EUT channel center frequency. The span range for the spectrum analyzer shall be between two and five times the anticipated OBW.
4. The nominal resolution bandwidth (RBW) shall be in the range of 1 to 5 % of the anticipated OBW, and the VBW shall be at least 3 times the RBW.
5. Set the detection mode to peak, and the trace mode to max hold.
6. Determine the reference value: Set the EUT to transmit a modulated signal. Allow the trace to stabilize. Set the spectrum analyzer marker to the highest level of the displayed trace.  
(this is the reference value)
7. Determine the “-26 dB down amplitude” as equal to (Reference Value – X).
8. Place two markers, one at the lowest and the other at the highest frequency of the envelope of the spectral display such that each marker is at or slightly below the “-X dB down amplitude” determined in step 6. If a marker is below this “-X dB down amplitude” value it shall be placed as close as possible to this value. The OBW is the positive frequency difference between the two markers.
9. Use the 99 % power bandwidth function of the spectrum analyzer and report the measured bandwidth.

## 3.7 Conducted Band Edge

### 3.7.1 Description of Conducted Band Edge Measurement

27.53(l)(2)

For mobile operations in the 3700-3980 MHz band, the conducted power of any emission outside the licensee's authorized bandwidth shall not exceed -13 dBm/MHz. Compliance with this paragraph is based on the use of measurement instrumentation employing a resolution bandwidth of 1 megahertz or greater. However, in the 1 megahertz bands immediately outside and adjacent to the licensee's frequency block, the minimum resolution bandwidth for the measurement shall be either one percent of the emission bandwidth of the fundamental emission of the transmitter or 350 kHz. In the bands between 1 and 5 MHz removed from the licensee's frequency block, the minimum resolution bandwidth for the measurement shall be 500 kHz.

### 3.7.2 Test Procedures

1. The testing follows ANSI C63.26 section 5.7
2. The EUT was connected to spectrum analyzer and system simulator via a power divider.
3. The band edges of low and high channels for the highest RF powers were measured.
4. Set RBW  $\geq$  1% EBW in the 1MHz band immediately outside and adjacent to the band edge.
5. Beyond the 1 MHz band from the band edge, RBW=1MHz was used.
6. Set spectrum analyzer with RMS detector.
7. The RF fundamental frequency should be excluded against the limit line in the operating frequency band.
8. Offset has included the duty factor for Band n77. Duty factor =  $10 \log (1/x)$ , where x is the measured duty cycle
9. Checked that all the results comply with the emission limit line.  
Example:  
The limit line is derived from  $43 + 10\log(P)$  dB below the transmitter power P(Watts)  
 $= P(W) - [43 + 10\log(P)]$  (dB)  
 $= [30 + 10\log(P)]$  (dBm) -  $[43 + 10\log(P)]$  (dB) = -13dBm.
10. When using the integration method, the starting frequency of the integration shall be centered at one-half of the RBW away from the band edge.

## 3.8 Conducted Spurious Emission

### 3.8.1 Description of Conducted Spurious Emission Measurement

The power of any emission outside of the authorized operating frequency ranges must be lower than the transmitter power (P) by a factor of at least  $43 + 10 \log (P)$  dB.

It is measured by means of a calibrated spectrum analyzer and scanned from 30 MHz up to a frequency including its 10<sup>th</sup> harmonic.

### 3.8.2 Test Procedures

1. The testing follows ANSI C63.26 section 5.7
2. The EUT was connected to spectrum analyzer and system simulator via a power divider.
3. The RF output of EUT was connected to the spectrum analyzer by RF cable and attenuator.  
The path loss was compensated to the results for each measurement.
4. The middle channel for the highest RF power within the transmitting frequency was measured.
5. The conducted spurious emission for the whole frequency range was taken.
6. Make the measurement with the spectrum analyzer's RBW = 1MHz, VBW = 3MHz.
7. Set spectrum analyzer with RMS detector.
8. Taking the record of maximum spurious emission.
9. The RF fundamental frequency should be excluded against the limit line in the operating frequency band.
10. The limit line is derived from  $43 + 10\log(P)$ dB below the transmitter power P(Watts)  
 $= P(W) - [43 + 10\log(P)]$  (dB)  
 $= [30 + 10\log(P)]$  (dBm) -  $[43 + 10\log(P)]$  (dB)  
 $= -13$ dBm.



## 3.9 Frequency Stability

### 3.9.1 Description of Frequency Stability Measurement

The frequency stability shall be measured by variation of ambient temperature and variation of primary supply voltage to ensure that the fundamental emission stays within the authorized frequency block.

### 3.9.2 Test Procedures for Temperature Variation

1. The testing follows ANSI C63.26 section 5.6.4
2. The EUT was set up in the thermal chamber and connected with the system simulator.
3. With power OFF, the temperature was decreased to  $-30^{\circ}\text{C}$  and the EUT was stabilized before testing. Power was applied and the maximum change in frequency was recorded within one minute.
4. With power OFF, the temperature was raised in  $10^{\circ}\text{C}$  step up to  $50^{\circ}\text{C}$ . The EUT was stabilized at each step for at least half an hour. Power was applied and the maximum frequency change was recorded within one minute.

### 3.9.3 Test Procedures for Voltage Variation

1. The testing follows ANSI C63.26 section 5.6.5
2. The EUT was placed in a temperature chamber at  $20\pm 5^{\circ}\text{C}$  and connected with the system simulator.
3. The power supply voltage to the EUT was varied from 85% to 115% of the nominal value for other than hand carried battery equipment.
4. For hand carried, battery powered equipment, reduce the primary ac or dc supply voltage to the battery operating end point, which shall be specified by the manufacturer.
5. The variation in frequency was measured for the worst case.

## 4 Radiated Test Items

### 4.1 Measuring Instruments

See list of measuring instruments of this test report.

### 4.2 Test Setup

#### 4.2.1 For radiated test below 30MHz

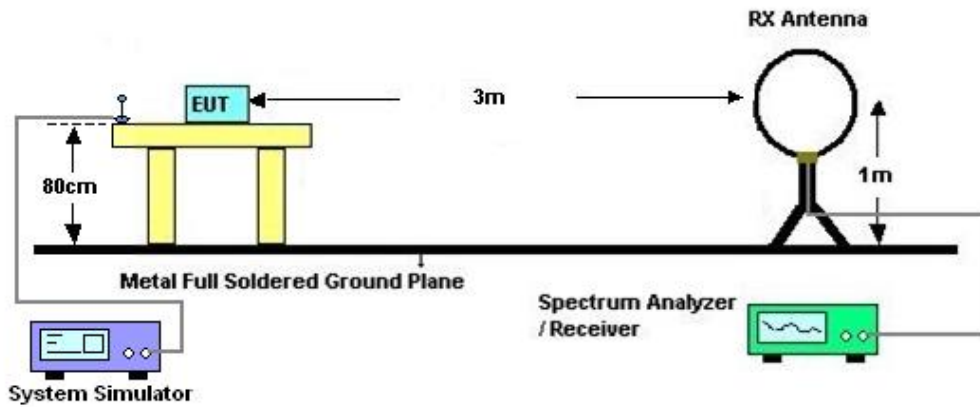

#### 4.2.2 For radiated test from 30MHz to 1GHz

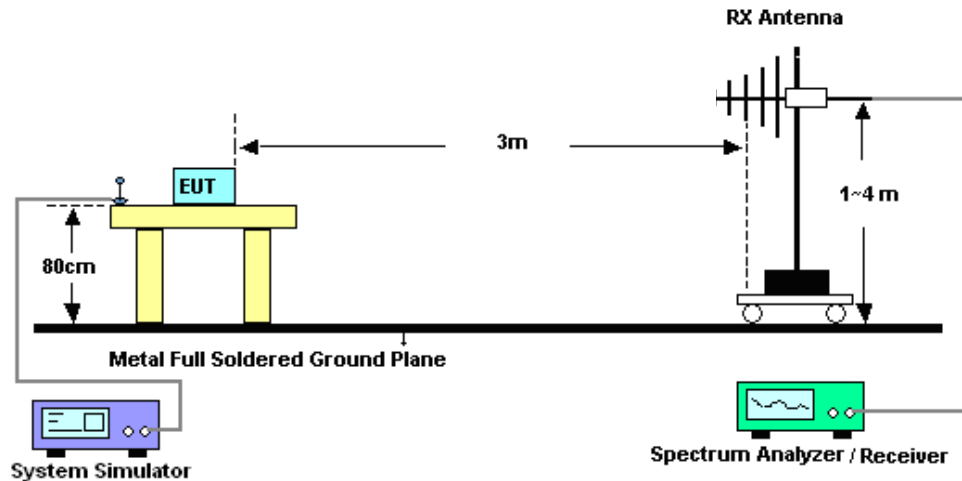

#### 4.2.3 For radiated test above 1GHz

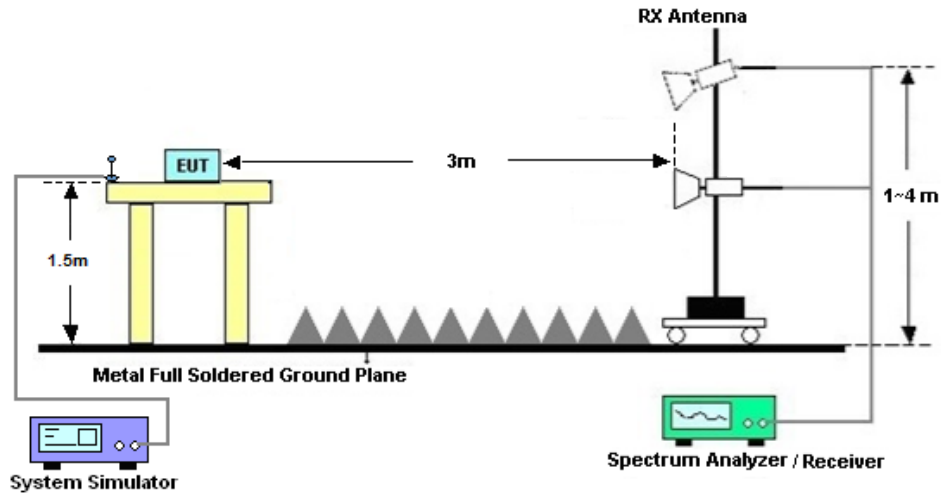

#### 4.3 Test Result of Radiated Test

The low frequency, which started from 9 kHz to 30MHz, was pre-scanned and the result which was 20dB lower than the limit line was not reported.

Please refer to Appendix B.

## 4.4 Radiated Spurious Emission Measurement

### 4.4.1 Description of Radiated Spurious Emission

The radiated spurious emission was measured by substitution method according to ANSI/TIA-603-E. The power of any emission outside of the authorized operating frequency ranges shall not exceed -13 dBm/MHz.

The spectrum is scanned from 30 MHz up to a frequency including its 10th harmonic.

### 4.4.2 Test Procedures

1. The testing follows ANSI C63.26 Section 5.5
2. The EUT was placed on a turntable with 0.8 meter height for frequency below 1GHz and 1.5 meter height for frequency above 1GHz respectively above ground.
3. The EUT was set 3 meters from the receiving antenna mounted on the antenna tower.
4. The table was rotated 360 degrees to determine the position of the highest spurious emission.
5. The height of the receiving antenna is varied between 1m to 4m to search the maximum spurious emission for both horizontal and vertical polarizations.
6. During the measurement, the system simulator parameters were set to force the EUT transmitting at maximum output power.
7. Make the measurement with the spectrum analyzer's RBW = 1MHz, VBW = 3MHz, taking the record of maximum spurious emission.
8. A horn antenna was substituted in place of the EUT and was driven by a signal generator.
9. Tune the output power of signal generator to the same emission level with EUT maximum spurious emission.
10. EIRP (dBm) = S.G. Power – Tx Cable Loss + Tx Antenna Gain
11. ERP (dBm) = EIRP - 2.15
12. The RF fundamental frequency should be excluded against the limit line in the operating frequency band.

The limit line is derived from  $43 + 10\log(P)$ dB below the transmitter power P(Watts)  
= P(W)- [43 + 10log(P)] (dB)  
= [30 + 10log(P)] (dBm) - [43 + 10log(P)] (dB)  
= -13dBm.

## 5 List of Measuring Equipment

Instrument	Manufacturer	Model No.	Serial No.	Characteristics	Calibration Date	Test Date	Due Date	Remark
EMI Test Receiver&SA	Agilent	N9038A	MY52260185	20Hz~26.5GHz	Dec. 27, 2021	Jul. 08, 2022~ Jul. 19, 2022	Dec. 26, 2022	Conducted (TH01-SZ)
Power Divider	TOJOIN	PS-2SM-04 265	60.06.020.007 7	0.4GHz~26.5GHz	Dec. 25, 2021	Jul. 08, 2022~ Jul. 19, 2022	Dec. 24, 2022	Conducted (TH01-SZ)
Thermal Chamber	Ten Billion Hongzhangroup	LP-150U	H2014081803	-40~+150°C	Jul. 14, 2021	Jul. 08, 2022~ Jul. 19, 2022	Jul. 13, 2022	Conducted (TH01-SZ)
Thermal Chamber	Ten Billion Hongzhangroup	LP-150U	H2014081803	-40~+150°C	Jul. 13, 2022		Jul. 12, 2023	Conducted (TH01-SZ)
EXA Spectrum Analyzer	Keysight	N9010B	MY57541079	10Hz-44G,MAX 30dB	Oct. 14, 2021	Jul. 13, 2022	Oct. 13, 2022	Radiation (03CH04-KS)
Loop Antenna	R&S	HFH2-Z2	100321	9kHz~30MHz	Oct. 30, 2021	Jul. 13, 2022	Oct. 29, 2022	Radiation (03CH04-KS)
Bilog Antenna	TeseQ	CBL6111D	49922	30MHz-1GHz	May 30, 2022	Jul. 13, 2022	May 29, 2023	Radiation (03CH04-KS)
Horn Antenna	Schwarzbeck	BBHA9120D	1284	1GHz~18GHz	Oct. 18, 2021	Jul. 13, 2022	Oct. 17, 2022	Radiation (03CH04-KS)
SHF-EHF Horn	Com-power	AH-840	101070	18GHz~40GHz	Jan. 05, 2022	Jul. 13, 2022	Jan. 04, 2023	Radiation (03CH04-KS)
Amplifier	SONOMA	310N	187289	9KHz-1GHz	Jan. 05, 2022	Jul. 13, 2022	Jan. 04, 2023	Radiation (03CH04-KS)
Amplifier	MITEQ	EM18G40G GA	060728	18~40GHz	Jan. 05, 2022	Jul. 13, 2022	Jan. 04, 2023	Radiation (03CH04-KS)
high gain Amplifier	MITEQ	AMF-7D-00 101800-30-1 0P	2025788	1Ghz-18Ghz	Jul. 30, 2021	Jul. 13, 2022	Jul. 29, 2022	Radiation (03CH04-KS)
Amplifier	Keysight	83017A	MY57280106	500MHz~26.5GHz	Oct. 13, 2021	Jul. 13, 2022	Oct. 12, 2022	Radiation (03CH04-KS)
AC Power Source	Chroma	61601	F104090004	N/A	NCR	Jul. 13, 2022	NCR	Radiation (03CH04-KS)
Turn Table	ChamPro	EM 1000-T	060762-T	0~360 degree	NCR	Jul. 13, 2022	NCR	Radiation (03CH04-KS)
Antenna Mast	ChamPro	EM 1000-A	060762-A	1 m~4 m	NCR	Jul. 13, 2022	NCR	Radiation (03CH04-KS)

NCR: No Calibration Required

## 6 Uncertainty of Evaluation

The measurement uncertainties shown below were calculated in accordance with the requirements of ANSI 63.26-2015. All the measurement uncertainty value were shown with a coverage K=2 to indicate 95% level of confidence. The measurement data show herein meets or exceeds the CISPR measurement uncertainty values specified in CISPR 16-4-2 and can be compared directly to specified limit to determine compliance.

### Uncertainty of Conducted Measurement

Test Item	Uncertainty
Conducted Power	1.34 dB
Conducted Emissions	1.34 dB
Occupied Channel Bandwidth	0.012MHz
Conducted Power Spectral Density	1.32 dB
Frequency tolerance	1.30 ppm

### Uncertainty of Radiated Emission Measurement (30 MHz ~ 1000 MHz)

Measuring Uncertainty for a Level of Confidence of 95% (U = 2Uc(y))	3.3dB
---	-------

### Uncertainty of Radiated Emission Measurement (1 GHz ~ 18 GHz)

Measuring Uncertainty for a Level of Confidence of 95% (U = 2Uc(y))	2.8dB
---	-------

### Uncertainty of Radiated Emission Measurement (18 GHz ~ 40 GHz)

Measuring Uncertainty for a Level of Confidence of 95% (U = 2Uc(y))	2.8dB
---	-------

----- THE END -----



## Appendix A. Test Results of Conducted Test

Test Engineer :	Jung Guo	Temperature :	22~23°C
		Relative Humidity :	40~42%

# FR1 N77

NR Band	SCS (kHz)	Bandwidth (MHz)	Arfcn	Freq (MHz)	Modulation	RB	Conducted Power(dBm)	EIRP (dBm)	EIRP (W)
77	30	10	647000	3705	DFT-s-OFDM QPSK	1@1	23.5	22.01	0.1589
77	30	10	647000	3705	DFT-s-OFDM 16 QAM	1@1	22.56	21.07	0.1279
77	30	10	656000	3840	DFT-s-OFDM QPSK	1@1	24.1	22.61	0.1824
77	30	10	656000	3840	DFT-s-OFDM 16 QAM	1@1	23.24	21.75	0.1496
77	30	10	665000	3975	DFT-s-OFDM QPSK	1@1	24.75	23.26	0.2118
77	30	10	665000	3975	DFT-s-OFDM 16 QAM	1@1	23.81	22.32	0.1706
77	30	15	647168	3707.52	DFT-s-OFDM QPSK	1@1	23.63	22.14	0.1637
77	30	15	647168	3707.52	DFT-s-OFDM 16 QAM	1@1	22.77	21.28	0.1343
77	30	15	656000	3840	DFT-s-OFDM QPSK	1@1	24.27	22.78	0.1897
77	30	15	656000	3840	DFT-s-OFDM 16 QAM	1@1	23.4	21.91	0.1552
77	30	15	664832	3972.48	DFT-s-OFDM QPSK	1@1	24.77	23.28	0.2128
77	30	15	664832	3972.48	DFT-s-OFDM 16 QAM	1@1	23.91	22.42	0.1746
77	30	20	647334	3710.01	DFT-s-OFDM QPSK	1@1	23.61	22.12	0.1629
77	30	20	647334	3710.01	DFT-s-OFDM 16 QAM	1@1	22.75	21.26	0.1337
77	30	20	656000	3840	DFT-s-OFDM QPSK	1@1	24.33	22.84	0.1923
77	30	20	656000	3840	DFT-s-OFDM 16 QAM	1@1	23.46	21.97	0.1574
77	30	20	664666	3969.99	DFT-s-OFDM QPSK	1@1	24.6	23.11	0.2046
77	30	20	664666	3969.99	DFT-s-OFDM 16 QAM	1@1	23.92	22.43	0.1750
77	30	30	647668	3715.02	DFT-s-OFDM QPSK	1@1	23.56	22.07	0.1611
77	30	30	647668	3715.02	DFT-s-OFDM 16 QAM	1@1	22.74	21.25	0.1334
77	30	30	656000	3840	DFT-s-OFDM QPSK	1@1	24.23	22.74	0.1879



77	30	30	656000	3840	DFT-s-OFDM 16 QAM	1@1	23.43	21.94	0.1563
77	30	30	664332	3964.98	DFT-s-OFDM QPSK	1@1	24.62	23.13	0.2056
77	30	30	664332	3964.98	DFT-s-OFDM 16 QAM	1@1	24.07	22.58	0.1811
77	30	40	648000	3720	DFT-s-OFDM QPSK	1@1	23.67	22.18	0.1652
77	30	40	648000	3720	DFT-s-OFDM 16 QAM	1@1	22.89	21.4	0.1380
77	30	40	656000	3840	DFT-s-OFDM QPSK	1@1	24.39	22.9	0.1950
77	30	40	656000	3840	DFT-s-OFDM 16 QAM	1@1	23.6	22.11	0.1626
77	30	40	664000	3960	DFT-s-OFDM QPSK	1@1	24.65	23.16	0.2070
77	30	40	664000	3960	DFT-s-OFDM 16 QAM	1@1	24.27	22.78	0.1897
77	30	50	648334	3725.01	DFT-s-OFDM QPSK	1@1	23.43	21.94	0.1563
77	30	50	648334	3725.01	DFT-s-OFDM 16 QAM	1@1	22.53	21.04	0.1271
77	30	50	656000	3840	DFT-s-OFDM QPSK	1@1	24.16	22.67	0.1849
77	30	50	656000	3840	DFT-s-OFDM 16 QAM	1@1	23.33	21.84	0.1528
77	30	50	663666	3954.99	DFT-s-OFDM QPSK	1@1	24.78	23.29	0.2133
77	30	50	663666	3954.99	DFT-s-OFDM 16 QAM	1@1	23.94	22.45	0.1758
77	30	60	648668	3730.02	DFT-s-OFDM QPSK	1@1	23.42	21.93	0.1560
77	30	60	648668	3730.02	DFT-s-OFDM 16 QAM	1@1	22.67	21.18	0.1312
77	30	60	656000	3840	DFT-s-OFDM QPSK	1@1	24.14	22.65	0.1841
77	30	60	656000	3840	DFT-s-OFDM 16 QAM	1@1	23.32	21.83	0.1524
77	30	60	663332	3949.98	DFT-s-OFDM QPSK	1@1	24.46	22.97	0.1982
77	30	60	663332	3949.98	DFT-s-OFDM 16 QAM	1@1	23.59	22.1	0.1622
77	30	70	649000	3735	DFT-s-OFDM QPSK	1@1	23.29	21.8	0.1514
77	30	70	649000	3735	DFT-s-OFDM 16 QAM	1@1	22.49	21	0.1259
77	30	70	656000	3840	DFT-s-OFDM QPSK	1@1	24	22.51	0.1782

77	30	70	656000	3840	DFT-s-OFDM 16 QAM	1@1	23.17	21.68	0.1472
77	30	70	663000	3945	DFT-s-OFDM QPSK	1@1	24.26	22.77	0.1892
77	30	70	663000	3945	DFT-s-OFDM 16 QAM	1@1	23.42	21.93	0.1560
77	30	80	649334	3740.01	DFT-s-OFDM QPSK	1@1	23.22	21.73	0.1489
77	30	80	649334	3740.01	DFT-s-OFDM 16 QAM	1@1	22.47	20.98	0.1253
77	30	80	656000	3840	DFT-s-OFDM QPSK	1@1	24.02	22.53	0.1791
77	30	80	656000	3840	DFT-s-OFDM 16 QAM	1@1	23.23	21.74	0.1493
77	30	80	662666	3939.99	DFT-s-OFDM QPSK	1@1	24.15	22.66	0.1845
77	30	80	662666	3939.99	DFT-s-OFDM 16 QAM	1@1	23.3	21.81	0.1517
77	30	90	649668	3745.02	DFT-s-OFDM QPSK	1@1	23.26	21.77	0.1503
77	30	90	649668	3745.02	DFT-s-OFDM 16 QAM	1@1	22.48	20.99	0.1256
77	30	90	656000	3840	DFT-s-OFDM QPSK	1@1	24.04	22.55	0.1799
77	30	90	656000	3840	DFT-s-OFDM 16 QAM	1@1	23.31	21.82	0.1521
77	30	90	662332	3934.98	DFT-s-OFDM QPSK	1@1	24.07	22.58	0.1811
77	30	90	662332	3934.98	DFT-s-OFDM 16 QAM	1@1	23.24	21.75	0.1496
77	30	100	650000	3750	DFT-s-OFDM PI/2 BPSK	135@67	23.98	22.49	0.1774
77	30	100	650000	3750	DFT-s-OFDM PI/2 BPSK	1@1	23.34	21.85	0.1531
77	30	100	650000	3750	DFT-s-OFDM PI/2 BPSK	1@271	24.28	22.79	0.1901
77	30	100	650000	3750	DFT-s-OFDM QPSK	135@67	23.96	22.47	0.1766
77	30	100	650000	3750	DFT-s-OFDM QPSK	1@1	23.39	21.9	0.1549
77	30	100	650000	3750	DFT-s-OFDM QPSK	1@271	24.19	22.7	0.1862
77	30	100	650000	3750	DFT-s-OFDM 16 QAM	135@67	22.92	21.43	0.1390
77	30	100	650000	3750	DFT-s-OFDM 16 QAM	1@1	22.46	20.97	0.1250
77	30	100	650000	3750	DFT-s-OFDM 16 QAM	1@271	23.37	21.88	0.1542

77	30	100	650000	3750	DFT-s-OFDM 64 QAM	135@67	21.41	19.92	0.0982
77	30	100	650000	3750	DFT-s-OFDM 64 QAM	1@1	20.85	19.36	0.0863
77	30	100	650000	3750	DFT-s-OFDM 64 QAM	1@271	21.8	20.31	0.1074
77	30	100	650000	3750	DFT-s-OFDM 256 QAM	135@67	19.38	17.89	0.0615
77	30	100	650000	3750	DFT-s-OFDM 256 QAM	1@1	18.56	17.07	0.0509
77	30	100	650000	3750	DFT-s-OFDM 256 QAM	1@271	19.63	18.14	0.0652
77	30	100	650000	3750	CP-OFDM QPSK	137@68	22.43	20.94	0.1242
77	30	100	650000	3750	CP-OFDM QPSK	1@1	21.78	20.29	0.1069
77	30	100	650000	3750	CP-OFDM QPSK	1@271	22.77	21.28	0.1343
77	30	100	656000	3840	DFT-s-OFDM PI/2 BPSK	135@67	24.07	22.58	0.1811
77	30	100	656000	3840	DFT-s-OFDM PI/2 BPSK	1@1	24.09	22.6	0.1820
77	30	100	656000	3840	DFT-s-OFDM PI/2 BPSK	1@271	24.17	22.68	0.1854
77	30	100	656000	3840	DFT-s-OFDM QPSK	135@67	24.03	22.54	0.1795
77	30	100	656000	3840	DFT-s-OFDM QPSK	1@1	24.08	22.59	0.1816
77	30	100	656000	3840	DFT-s-OFDM QPSK	1@271	24.15	22.66	0.1845
77	30	100	656000	3840	DFT-s-OFDM 16 QAM	135@67	23.08	21.59	0.1442
77	30	100	656000	3840	DFT-s-OFDM 16 QAM	1@1	23.14	21.65	0.1462
77	30	100	656000	3840	DFT-s-OFDM 16 QAM	1@271	23.32	21.83	0.1524
77	30	100	656000	3840	DFT-s-OFDM 64 QAM	135@67	21.54	20.05	0.1012
77	30	100	656000	3840	DFT-s-OFDM 64 QAM	1@1	21.6	20.11	0.1026
77	30	100	656000	3840	DFT-s-OFDM 64 QAM	1@271	21.75	20.26	0.1062
77	30	100	656000	3840	DFT-s-OFDM 256 QAM	135@67	19.52	18.03	0.0635
77	30	100	656000	3840	DFT-s-OFDM 256 QAM	1@1	19.38	17.89	0.0615
77	30	100	656000	3840	DFT-s-OFDM 256 QAM	1@271	19.62	18.13	0.0650

77	30	100	656000	3840	CP-OFDM QPSK	137@68	22.54	21.05	0.1274
77	30	100	656000	3840	CP-OFDM QPSK	1@1	22.54	21.05	0.1274
77	30	100	656000	3840	CP-OFDM QPSK	1@271	22.7	21.21	0.1321
77	30	100	662000	3930	DFT-s- OFDM PI/2 BPSK	135@67	24.35	22.86	0.1932
77	30	100	662000	3930	DFT-s- OFDM PI/2 BPSK	1@1	24.09	22.6	0.1820
77	30	100	662000	3930	DFT-s- OFDM PI/2 BPSK	1@271	24.3	22.81	0.1910
77	30	100	662000	3930	DFT-s- OFDM QPSK	135@67	24.79	23.3	0.2138
77	30	100	662000	3930	DFT-s- OFDM QPSK	1@1	24.13	22.64	0.1837
77	30	100	662000	3930	DFT-s- OFDM QPSK	1@271	24.2	22.71	0.1866
77	30	100	662000	3930	DFT-s- OFDM 16 QAM	135@67	23.36	21.87	0.1538
77	30	100	662000	3930	DFT-s- OFDM 16 QAM	1@1	23.18	21.69	0.1476
77	30	100	662000	3930	DFT-s- OFDM 16 QAM	1@271	23.33	21.84	0.1528
77	30	100	662000	3930	DFT-s- OFDM 64 QAM	135@67	21.85	20.36	0.1086
77	30	100	662000	3930	DFT-s- OFDM 64 QAM	1@1	21.64	20.15	0.1035
77	30	100	662000	3930	DFT-s- OFDM 64 QAM	1@271	21.82	20.33	0.1079
77	30	100	662000	3930	DFT-s- OFDM 256 QAM	135@67	19.84	18.35	0.0684
77	30	100	662000	3930	DFT-s- OFDM 256 QAM	1@1	19.42	17.93	0.0621
77	30	100	662000	3930	DFT-s- OFDM 256 QAM	1@271	19.71	18.22	0.0664
77	30	100	662000	3930	CP-OFDM QPSK	137@68	22.83	21.34	0.1361
77	30	100	662000	3930	CP-OFDM QPSK	1@1	22.53	21.04	0.1271
77	30	100	662000	3930	CP-OFDM QPSK	1@271	22.79	21.3	0.1349

## Frequency Stability

NR Band	SCS (kHz)	Bandwidth (MHz)	Arfcn	Freq (MHz)	Modulation	RB	Deviation (ppm)	Verdict	Environment
77	30	20	656000	3840.0	DFT-s-OFDM QPSK	50@0	0.0021	PASS	NV
77	30	20	656000	3840.0	DFT-s-OFDM QPSK	50@0	0.0057	PASS	LV
77	30	20	656000	3840.0	DFT-s-OFDM QPSK	50@0	0.0061	PASS	HV
77	30	20	656000	3840.0	DFT-s-OFDM QPSK	50@0	0.0050	PASS	-30°C
77	30	20	656000	3840.0	DFT-s-OFDM QPSK	50@0	0.0024	PASS	-20°C
77	30	20	656000	3840.0	DFT-s-OFDM QPSK	50@0	0.0057	PASS	-10°C
77	30	20	656000	3840.0	DFT-s-OFDM QPSK	50@0	0.0034	PASS	0°C
77	30	20	656000	3840.0	DFT-s-OFDM QPSK	50@0	0.0048	PASS	10°C
77	30	20	656000	3840.0	DFT-s-OFDM QPSK	50@0	0.0021	PASS	20°C
77	30	20	656000	3840.0	DFT-s-OFDM QPSK	50@0	0.0037	PASS	30°C
77	30	20	656000	3840.0	DFT-s-OFDM QPSK	50@0	0.0046	PASS	40°C
77	30	20	656000	3840.0	DFT-s-OFDM QPSK	50@0	0.0030	PASS	50°C

## Peak to Average Ratio

NR Band	SCS (kHz)	Bandwidth (MHz)	Arfcn	Freq (MHz)	Modulation	RB	Result (dB)	Limit (dB)	Verdict
77	30	20	647334	3710.01	DFT-s-OFDM PI/2 BPSK	50@0	6.61	13	PASS
77	30	20	647334	3710.01	DFT-s-OFDM PI/2 BPSK	1@0	7.85	13	PASS
77	30	20	647334	3710.01	DFT-s-OFDM QPSK	50@0	7.41	13	PASS
77	30	20	647334	3710.01	DFT-s-OFDM QPSK	1@0	7.87	13	PASS
77	30	20	656000	3840.0	DFT-s-OFDM PI/2 BPSK	50@0	6.56	13	PASS
77	30	20	656000	3840.0	DFT-s-OFDM PI/2 BPSK	1@0	8.04	13	PASS
77	30	20	656000	3840.0	DFT-s-OFDM QPSK	50@0	7.41	13	PASS
77	30	20	656000	3840.0	DFT-s-OFDM QPSK	1@0	7.74	13	PASS
77	30	20	664666	3969.99	DFT-s-OFDM PI/2 BPSK	50@0	5.89	13	PASS
77	30	20	664666	3969.99	DFT-s-OFDM PI/2 BPSK	1@0	6.78	13	PASS
77	30	20	664666	3969.99	DFT-s-OFDM QPSK	50@0	6.67	13	PASS
77	30	20	664666	3969.99	DFT-s-OFDM QPSK	1@0	6.73	13	PASS

N77(20M)\_DFT-s-OFDM\_PI\_2-BPSK\_Outer\_Full\_Low\_CH

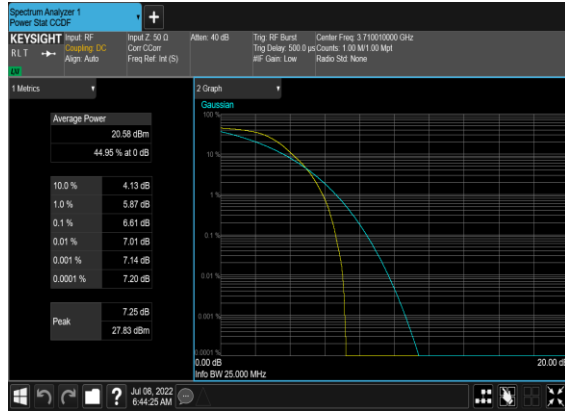

N77(20M)\_DFT-s-OFDM\_PI\_2-BPSK\_Edge\_1RB\_Left\_Low\_CH

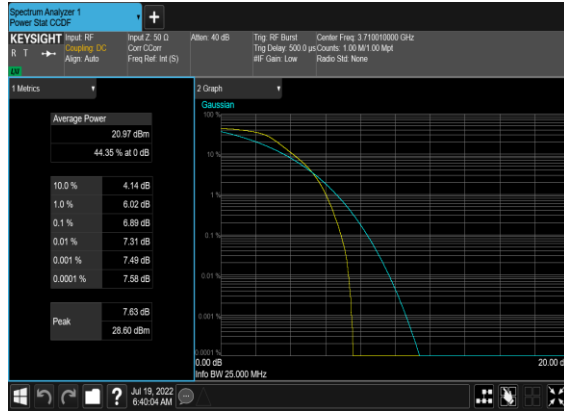

N77(20M)\_DFT-s-OFDM\_QPSK\_Outer\_Full\_Low\_CH



N77(20M)\_DFT-s-OFDM\_QPSK\_Edge\_1RB\_Left\_Low\_CH

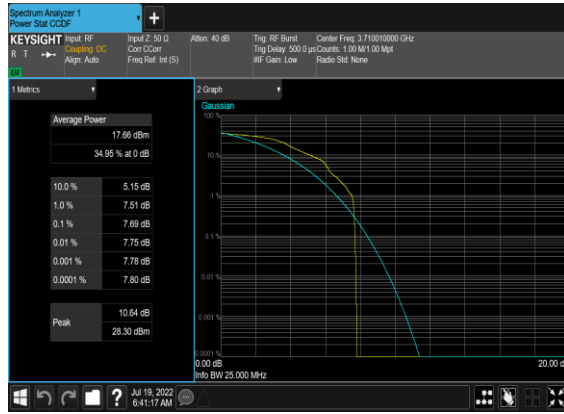

N77(20M)\_DFT-s-OFDM\_PI\_2-BPSK\_Outer\_Full\_Mid\_CH

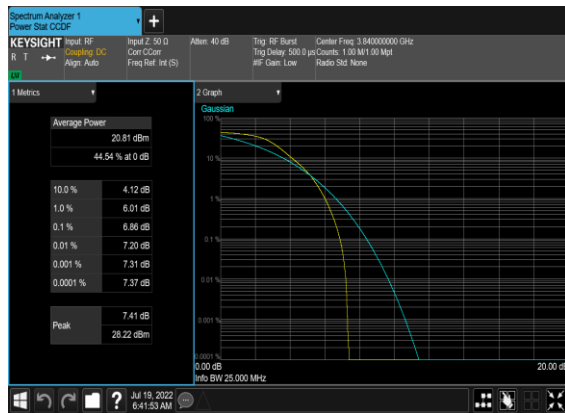

N77(20M)\_DFT-s-OFDM\_PI\_2-BPSK\_Edge\_1RB\_Left\_Mid\_CH

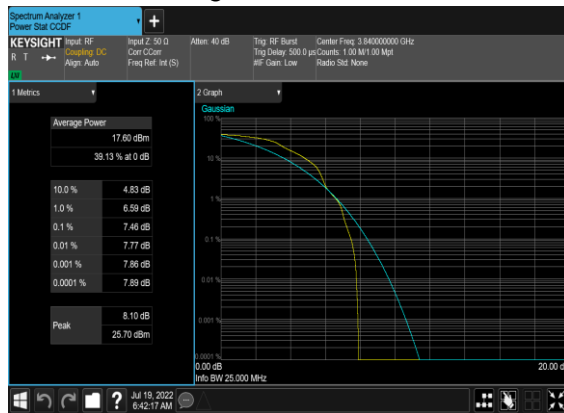

N77(20M)\_DFT-s-OFDM\_QPSK\_Outer\_Full\_Mid\_CH



N77(20M)\_DFT-s-OFDM\_QPSK\_Edge\_1RB\_Left\_Mid\_CH

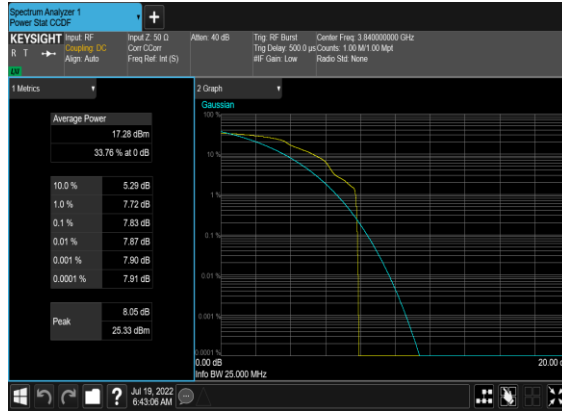

N77(20M)\_DFT-s-OFDM\_PI\_2-BPSK\_Outer\_Full\_High\_CH

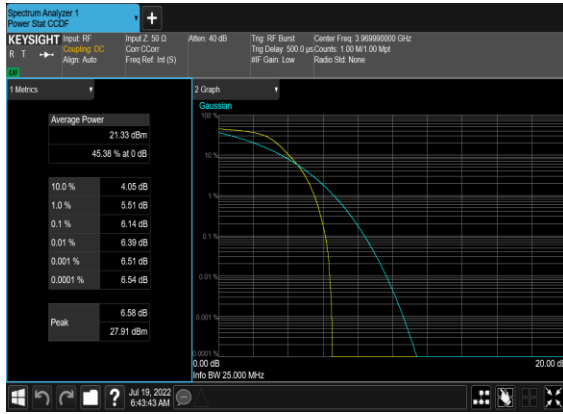

N77(20M)\_DFT-s-OFDM\_PI\_2-BPSK\_Edge\_1RB\_Left\_High\_CH



N77(20M)\_DFT-s-OFDM\_QPSK\_Outer\_Full\_High\_CH

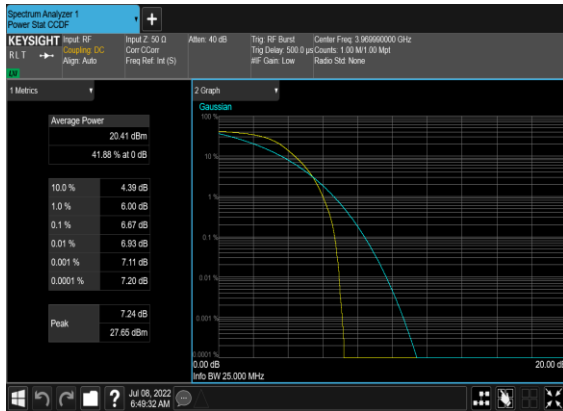

N77(20M)\_DFT-s-OFDM\_QPSK\_Edge\_1RB\_Left\_High\_CH

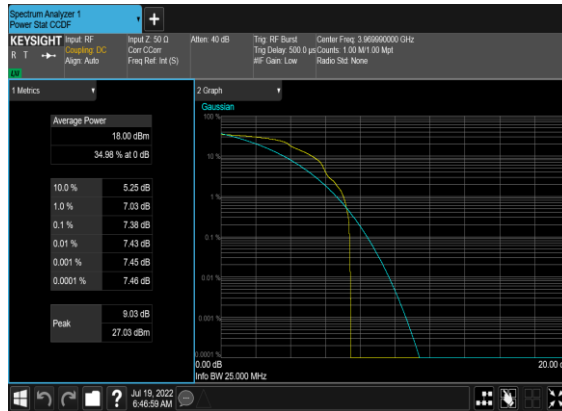



## Occupied Bandwidth

NR Band	SCS (kHz)	Bandwidth (MHz)	Arfcn	Freq (MHz)	Modulation	RB	OBW (MHz)	26dB OBW (MHz)
77	30	10	656000	3840.0	DFT-s-OFDM PI/2 BPSK	24@0	8.5891	9.726
77	30	10	656000	3840.0	DFT-s-OFDM QPSK	24@0	8.6006	9.727
77	30	10	656000	3840.0	CP-OFDM QPSK	24@0	8.5787	10.26
77	30	10	656000	3840.0	CP-OFDM 16 QAM	24@0	8.6071	9.808
77	30	10	656000	3840.0	CP-OFDM 64 QAM	24@0	8.5994	9.82
77	30	10	656000	3840.0	CP-OFDM 256 QAM	24@0	8.584	9.709
77	30	15	656000	3840.0	DFT-s-OFDM PI/2 BPSK	36@0	12.861	14.02
77	30	15	656000	3840.0	DFT-s-OFDM QPSK	36@0	12.845	13.86
77	30	15	656000	3840.0	CP-OFDM QPSK	38@0	13.615	15.17
77	30	15	656000	3840.0	CP-OFDM 16 QAM	38@0	13.586	14.71
77	30	15	656000	3840.0	CP-OFDM 64 QAM	38@0	13.585	15.05
77	30	15	656000	3840.0	CP-OFDM 256 QAM	38@0	13.581	14.76
77	30	20	656000	3840.0	DFT-s-OFDM PI/2 BPSK	50@0	17.804	19.01
77	30	20	656000	3840.0	DFT-s-OFDM QPSK	50@0	17.834	19.08
77	30	20	656000	3840.0	CP-OFDM QPSK	51@0	18.221	19.89
77	30	20	656000	3840.0	CP-OFDM 16 QAM	51@0	18.258	19.77
77	30	20	656000	3840.0	CP-OFDM 64 QAM	51@0	18.208	19.67
77	30	20	656000	3840.0	CP-OFDM 256 QAM	51@0	18.226	19.63
77	30	30	656000	3840.0	DFT-s-OFDM PI/2 BPSK	75@0	26.783	28.3
77	30	30	656000	3840.0	DFT-s-OFDM QPSK	75@0	26.761	27.89
77	30	30	656000	3840.0	CP-OFDM QPSK	78@0	27.886	29.79
77	30	30	656000	3840.0	CP-OFDM 16 QAM	78@0	27.937	29.57
77	30	30	656000	3840.0	CP-OFDM 64 QAM	78@0	27.875	29.51
77	30	30	656000	3840.0	CP-OFDM 256 QAM	78@0	27.869	29.48

77	30	40	656000	3840.0	DFT-s-OFDM PI/2 BPSK	100@0	35.728	37.81
77	30	40	656000	3840.0	DFT-s-OFDM QPSK	100@0	35.798	37.43
77	30	40	656000	3840.0	CP-OFDM QPSK	106@0	37.905	39.75
77	30	40	656000	3840.0	CP-OFDM 16 QAM	106@0	37.834	39.56
77	30	40	656000	3840.0	CP-OFDM 64 QAM	106@0	37.798	39.93
77	30	40	656000	3840.0	CP-OFDM 256 QAM	106@0	37.838	39.68
77	30	50	656000	3840.0	DFT-s-OFDM PI/2 BPSK	128@0	45.789	47.54
77	30	50	656000	3840.0	DFT-s-OFDM QPSK	128@0	45.779	47.88
77	30	50	656000	3840.0	CP-OFDM QPSK	133@0	47.48	49.55
77	30	50	656000	3840.0	CP-OFDM 16 QAM	133@0	47.494	49.43
77	30	50	656000	3840.0	CP-OFDM 64 QAM	133@0	47.515	49.37
77	30	50	656000	3840.0	CP-OFDM 256 QAM	133@0	47.479	49.48
77	30	60	656000	3840.0	DFT-s-OFDM PI/2 BPSK	162@0	57.932	59.95
77	30	60	656000	3840.0	DFT-s-OFDM QPSK	162@0	57.957	60.29
77	30	60	656000	3840.0	CP-OFDM QPSK	162@0	57.84	60.16
77	30	60	656000	3840.0	CP-OFDM 16 QAM	162@0	57.849	60.02
77	30	60	656000	3840.0	CP-OFDM 64 QAM	162@0	57.933	60.23
77	30	60	656000	3840.0	CP-OFDM 256 QAM	162@0	57.813	60.17
77	30	70	656000	3840.0	DFT-s-OFDM PI/2 BPSK	180@0	64.383	66.49
77	30	70	656000	3840.0	DFT-s-OFDM QPSK	180@0	64.351	66.59
77	30	70	656000	3840.0	CP-OFDM QPSK	189@0	67.475	69.92
77	30	70	656000	3840.0	CP-OFDM 16 QAM	189@0	67.494	70.21
77	30	70	656000	3840.0	CP-OFDM 64 QAM	189@0	67.527	69.99
77	30	70	656000	3840.0	CP-OFDM 256 QAM	189@0	67.521	69.99
77	30	80	656000	3840.0	DFT-s-OFDM PI/2 BPSK	216@0	77.278	79.6
77	30	80	656000	3840.0	DFT-s-OFDM	216@0	77.24	79.84

QPSK								
77	30	80	656000	3840.0	CP-OFDM QPSK	217@0	77.525	80.15
77	30	80	656000	3840.0	CP-OFDM 16 QAM	217@0	77.675	80.33
77	30	80	656000	3840.0	CP-OFDM 64 QAM	217@0	77.545	80.05
77	30	80	656000	3840.0	CP-OFDM 256 QAM	217@0	77.47	80.24
77	30	90	656000	3840.0	DFT-s- OFDM PI/2 BPSK	240@0	85.782	88.7
77	30	90	656000	3840.0	DFT-s- OFDM QPSK	240@0	85.783	88.52
77	30	90	656000	3840.0	CP-OFDM QPSK	245@0	87.446	90.39
77	30	90	656000	3840.0	CP-OFDM 16 QAM	245@0	87.449	90.28
77	30	90	656000	3840.0	CP-OFDM 64 QAM	245@0	87.542	90.32
77	30	90	656000	3840.0	CP-OFDM 256 QAM	245@0	87.679	90.35
77	30	100	656000	3840.0	DFT-s- OFDM PI/2 BPSK	270@0	96.414	99.67
77	30	100	656000	3840.0	DFT-s- OFDM QPSK	270@0	96.411	99.56
77	30	100	656000	3840.0	CP-OFDM QPSK	273@0	97.681	100.7
77	30	100	656000	3840.0	CP-OFDM 16 QAM	273@0	97.606	100.5
77	30	100	656000	3840.0	CP-OFDM 64 QAM	273@0	97.464	100.5
77	30	100	656000	3840.0	CP-OFDM 256 QAM	273@0	97.671	100.6

N77(10M)\_DFT-s-OFDM\_PI\_2-  
BPSK\_Outer\_Full\_Mid\_CH



N77(10M)\_DFT-s-  
OFDM\_QPSK\_Outer\_Full\_Mid\_CH

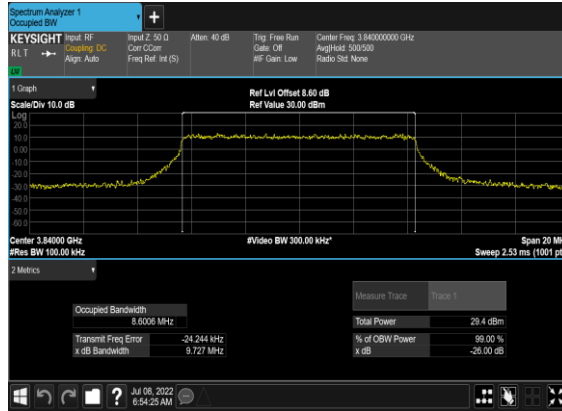

N77(10M)\_CP-  
OFDM\_QPSK\_Outer\_Full\_Mid\_CH

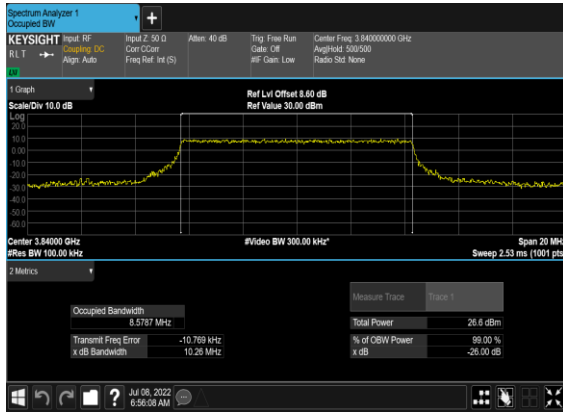

N77(10M)\_CP-OFDM\_16  
QAM\_Outer\_Full\_Mid\_CH



N77(10M)\_CP-OFDM\_64  
QAM\_Outer\_Full\_Mid\_CH

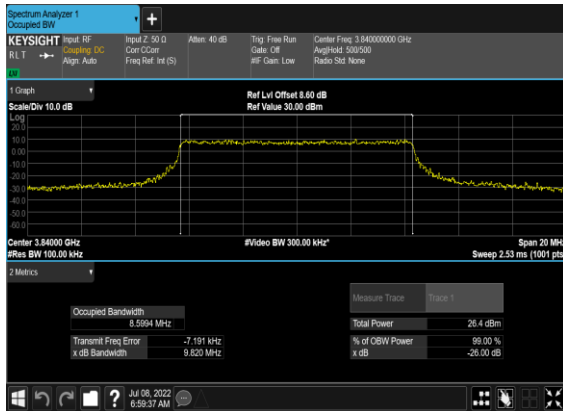

N77(10M)\_CP-OFDM\_256  
QAM\_Outer\_Full\_Mid\_CH

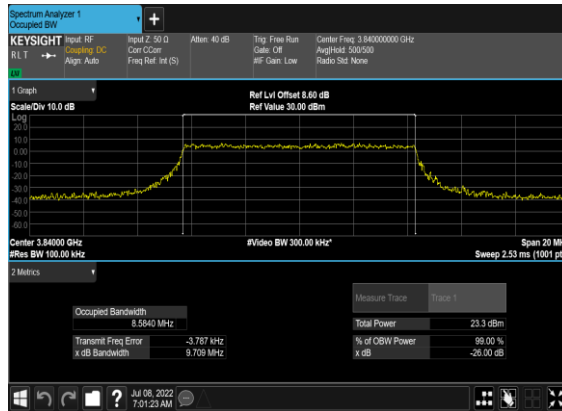

### N77(15M)\_DFT-s-OFDM\_PI\_2- BPSK\_Outer\_Full\_Mid\_CH

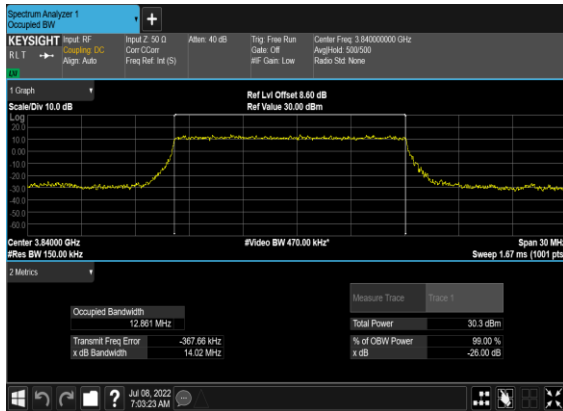

### N77(15M)\_DFT-s- OFDM\_QPSK\_Outer\_Full\_Mid\_CH

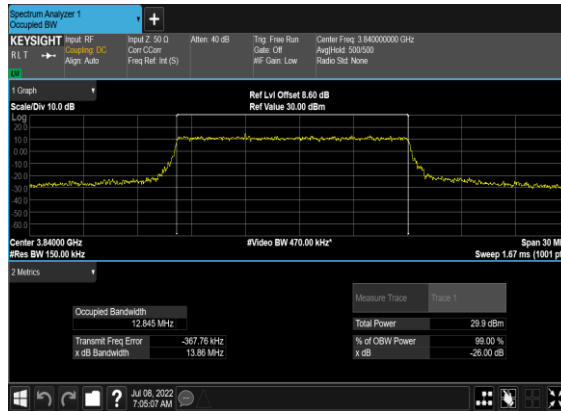

### N77(15M)\_CP- OFDM\_QPSK\_Outer\_Full\_Mid\_CH

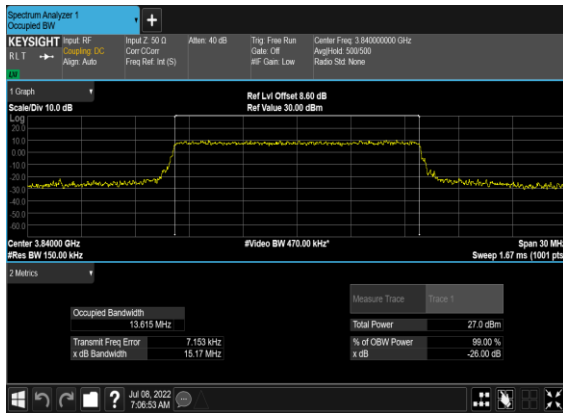

### N77(15M)\_CP-OFDM\_16 QAM\_Outer\_Full\_Mid\_CH

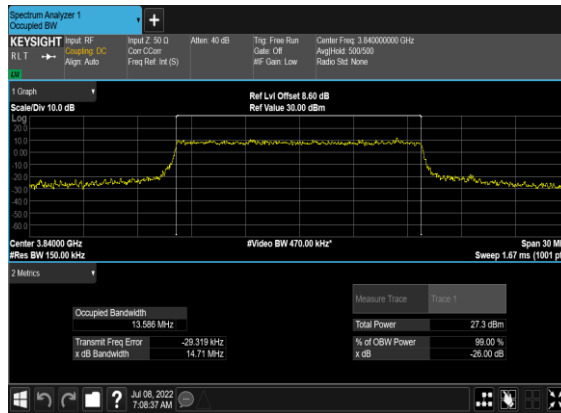

### N77(15M)\_CP-OFDM\_64 QAM\_Outer\_Full\_Mid\_CH

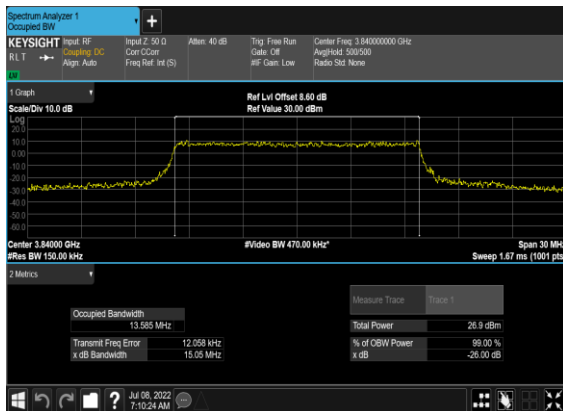

### N77(15M)\_CP-OFDM\_256 QAM\_Outer\_Full\_Mid\_CH

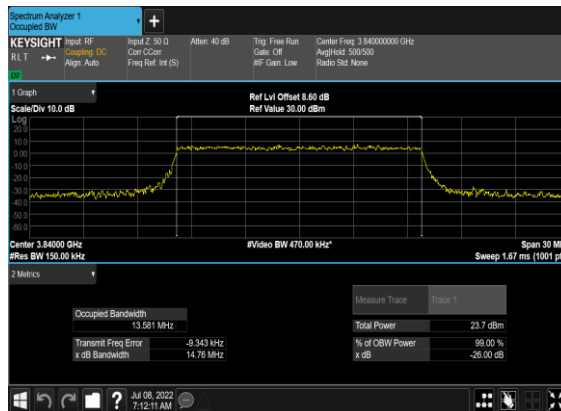

### N77(20M)\_DFT-s-OFDM\_PI\_2- BPSK\_Outer\_Full\_Mid\_CH

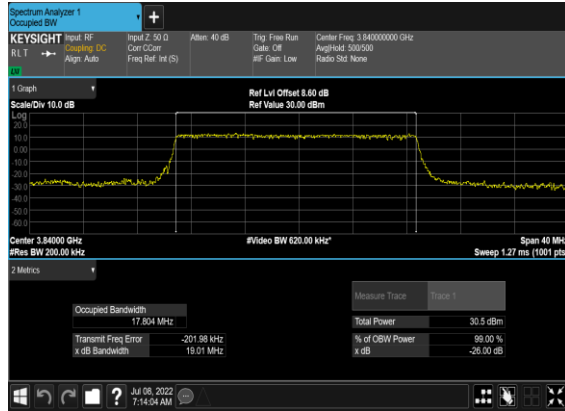

### N77(20M)\_DFT-s- OFDM\_QPSK\_Outer\_Full\_Mid\_CH

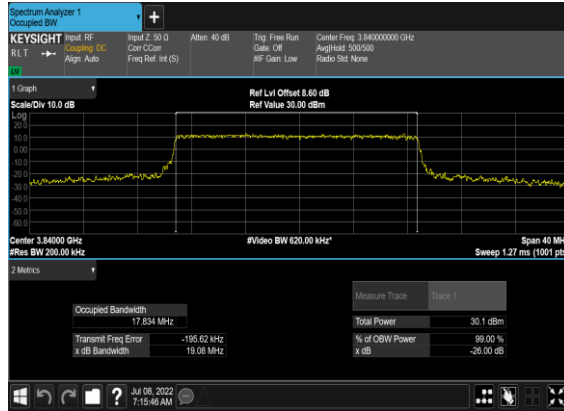

### N77(20M)\_CP- OFDM\_QPSK\_Outer\_Full\_Mid\_CH



### N77(20M)\_CP-OFDM\_16 QAM\_Outer\_Full\_Mid\_CH

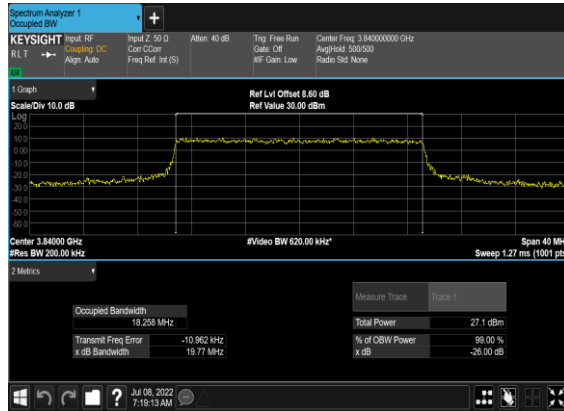

### N77(20M)\_CP-OFDM\_64 QAM\_Outer\_Full\_Mid\_CH

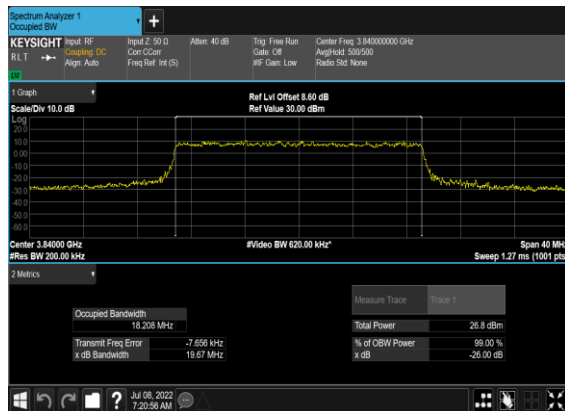

### N77(20M)\_CP-OFDM\_256 QAM\_Outer\_Full\_Mid\_CH

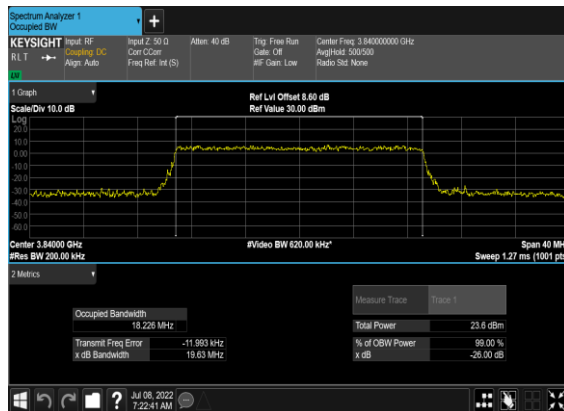

### N77(30M)\_DFT-s-OFDM\_PI\_2- BPSK\_Outer\_Full\_Mid\_CH

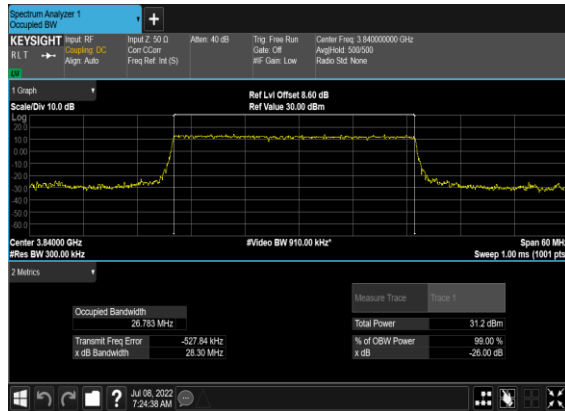

### N77(30M)\_DFT-s- OFDM\_QPSK\_Outer\_Full\_Mid\_CH

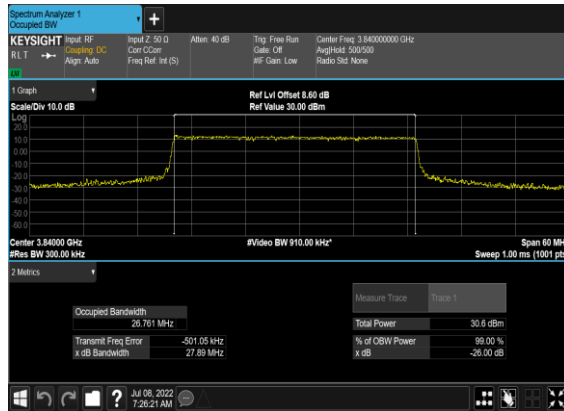

### N77(30M)\_CP- OFDM\_QPSK\_Outer\_Full\_Mid\_CH

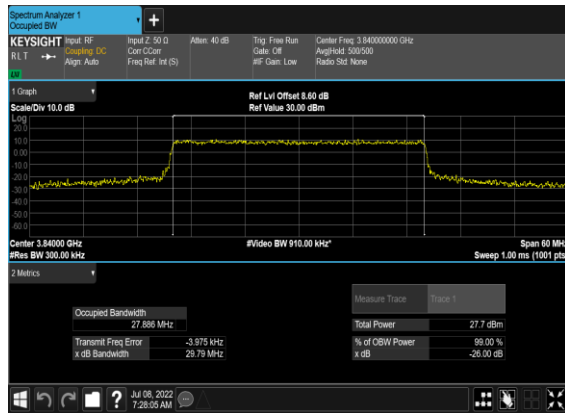

### N77(30M)\_CP-OFDM\_16 QAM\_Outer\_Full\_Mid\_CH

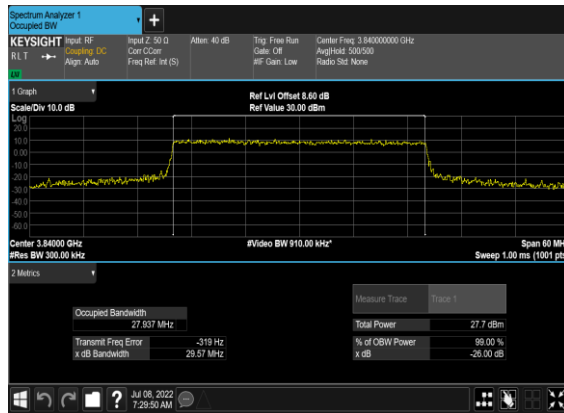

### N77(30M)\_CP-OFDM\_64 QAM\_Outer\_Full\_Mid\_CH

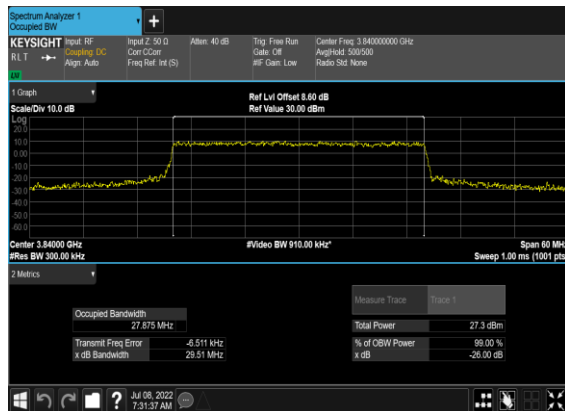

### N77(30M)\_CP-OFDM\_256 QAM\_Outer\_Full\_Mid\_CH

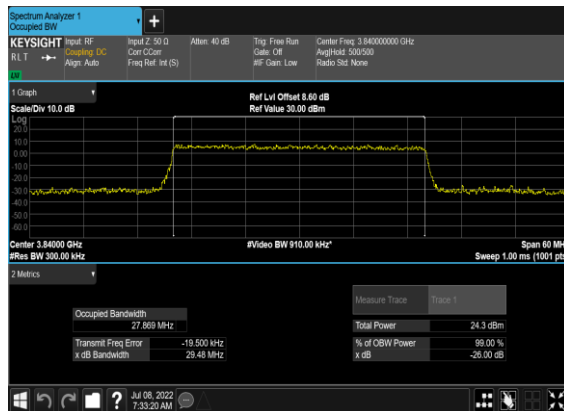

### N77(40M)\_DFT-s-OFDM\_PI\_2- BPSK\_Outer\_Full\_Mid\_CH

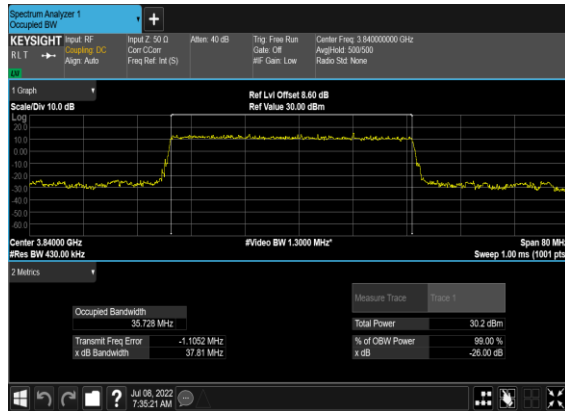

### N77(40M)\_DFT-s- OFDM\_QPSK\_Outer\_Full\_Mid\_CH

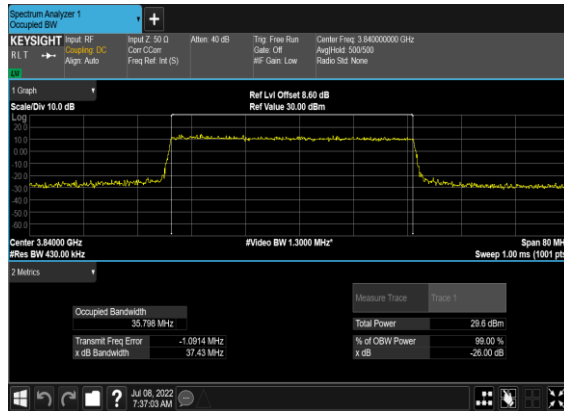

### N77(40M)\_CP- OFDM\_QPSK\_Outer\_Full\_Mid\_CH

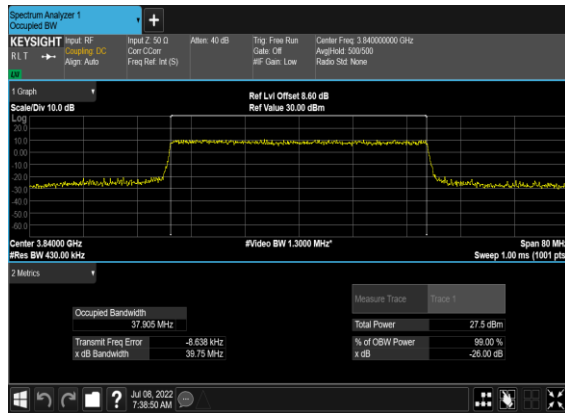

### N77(40M)\_CP-OFDM\_16 QAM\_Outer\_Full\_Mid\_CH

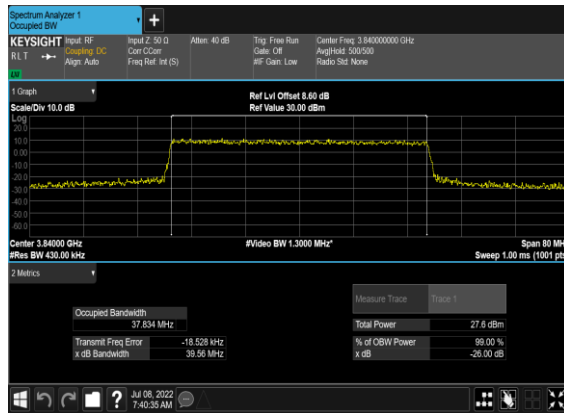

### N77(40M)\_CP-OFDM\_64 QAM\_Outer\_Full\_Mid\_CH

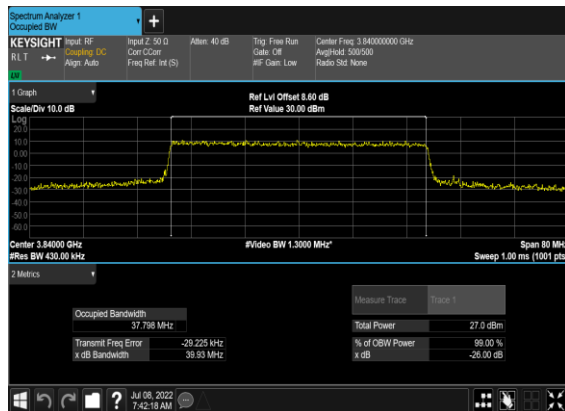

### N77(40M)\_CP-OFDM\_256 QAM\_Outer\_Full\_Mid\_CH

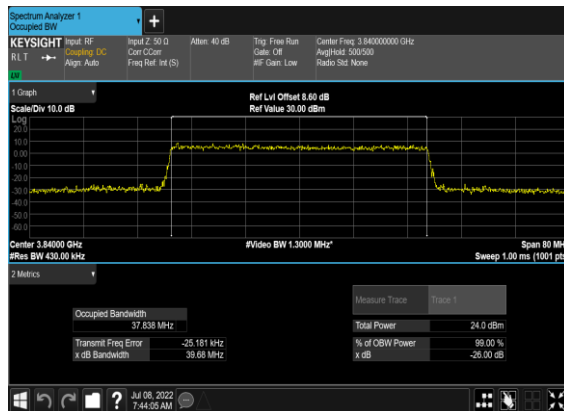



### N77(50M)\_DFT-s-OFDM\_PI\_2- BPSK\_Outer\_Full\_Mid\_CH

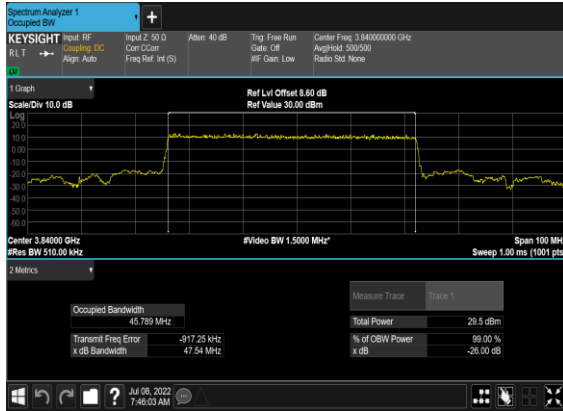

### N77(50M)\_DFT-s- OFDM\_QPSK\_Outer\_Full\_Mid\_CH

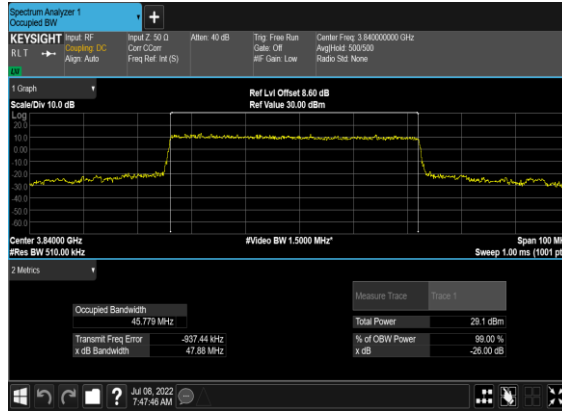

### N77(50M)\_CP- OFDM\_QPSK\_Outer\_Full\_Mid\_CH

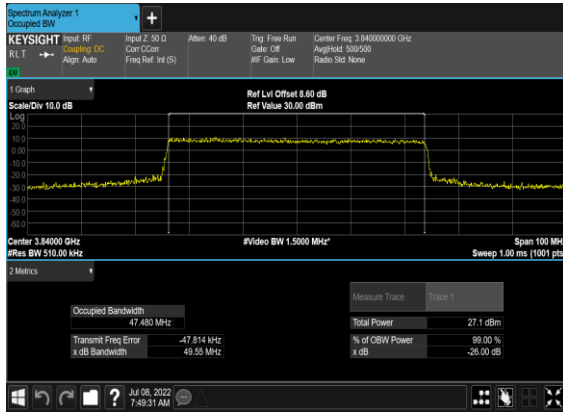

### N77(50M)\_CP-OFDM\_16 QAM\_Outer\_Full\_Mid\_CH

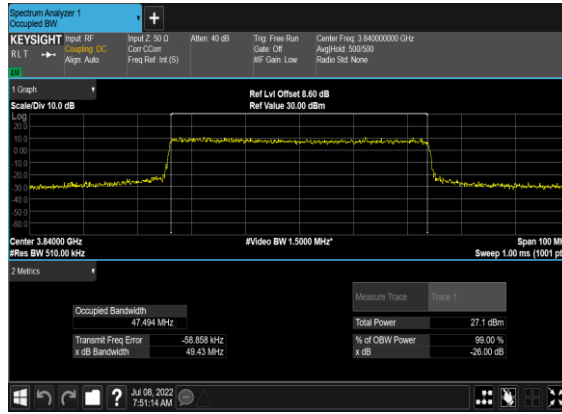

### N77(50M)\_CP-OFDM\_64 QAM\_Outer\_Full\_Mid\_CH

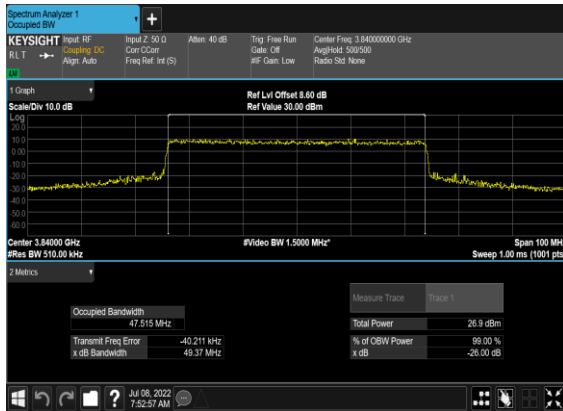

### N77(50M)\_CP-OFDM\_256 QAM\_Outer\_Full\_Mid\_CH

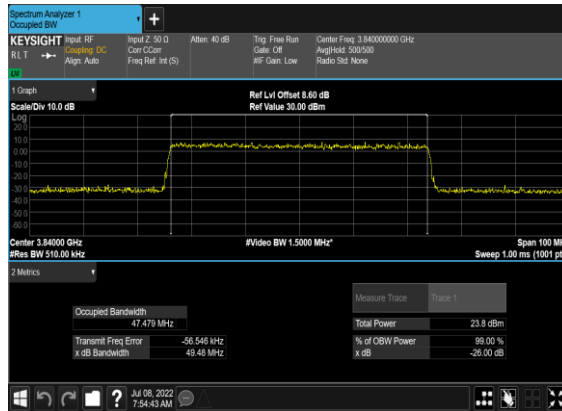

### N77(60M)\_DFT-s-OFDM\_PI\_2- BPSK\_Outer\_Full\_Mid\_CH

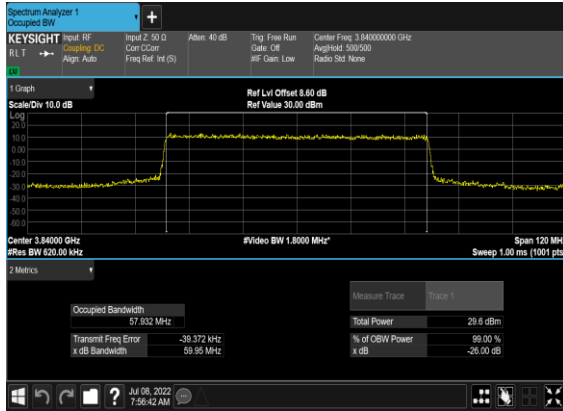

### N77(60M)\_DFT-s- OFDM\_QPSK\_Outer\_Full\_Mid\_CH

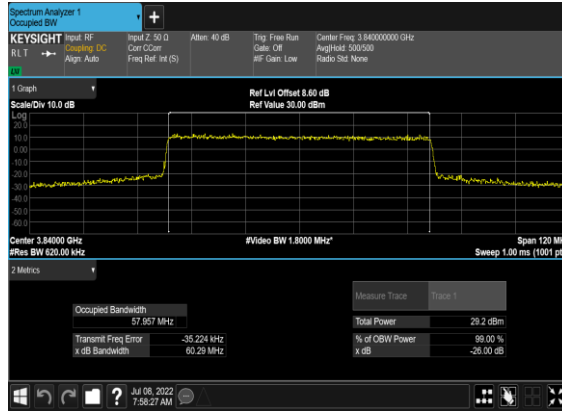

### N77(60M)\_CP- OFDM\_QPSK\_Outer\_Full\_Mid\_CH

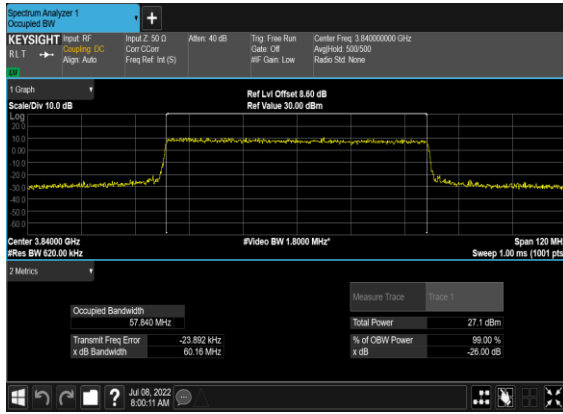

### N77(60M)\_CP-OFDM\_16 QAM\_Outer\_Full\_Mid\_CH

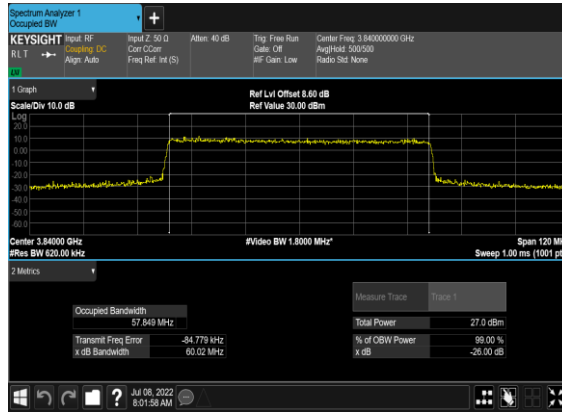

### N77(60M)\_CP-OFDM\_64 QAM\_Outer\_Full\_Mid\_CH

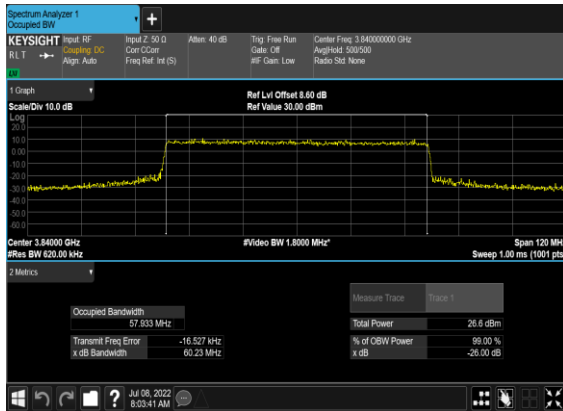

### N77(60M)\_CP-OFDM\_256 QAM\_Outer\_Full\_Mid\_CH

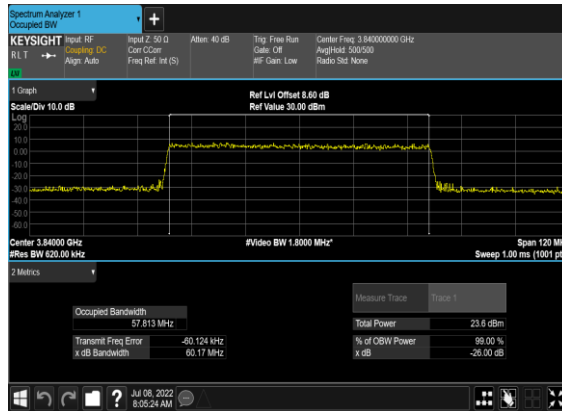

### N77(70M)\_DFT-s-OFDM\_PI\_2- BPSK\_Outer\_Full\_Mid\_CH

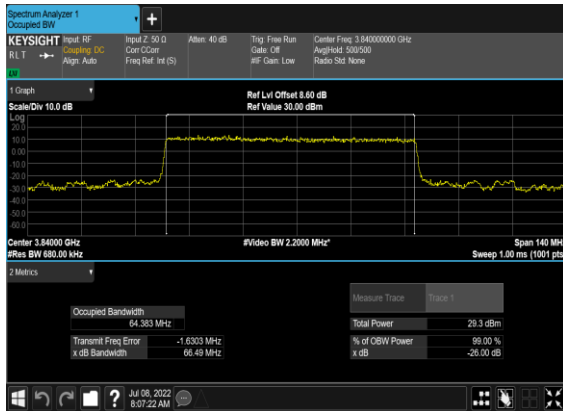

### N77(70M)\_DFT-s- OFDM\_QPSK\_Outer\_Full\_Mid\_CH

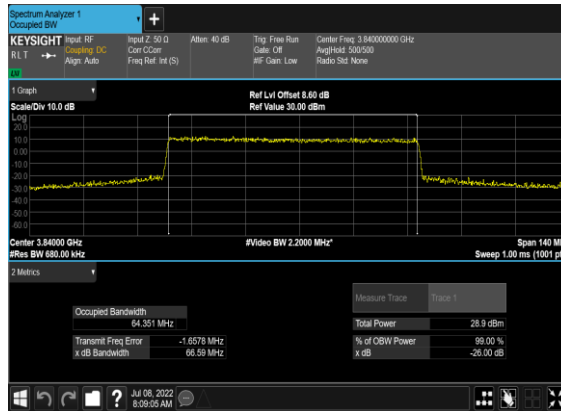

### N77(70M)\_CP- OFDM\_QPSK\_Outer\_Full\_Mid\_CH

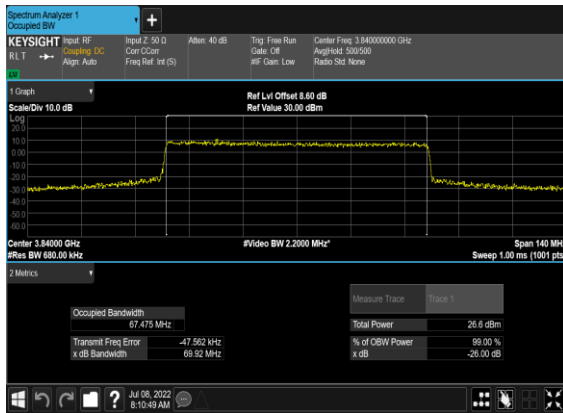

### N77(70M)\_CP-OFDM\_16 QAM\_Outer\_Full\_Mid\_CH

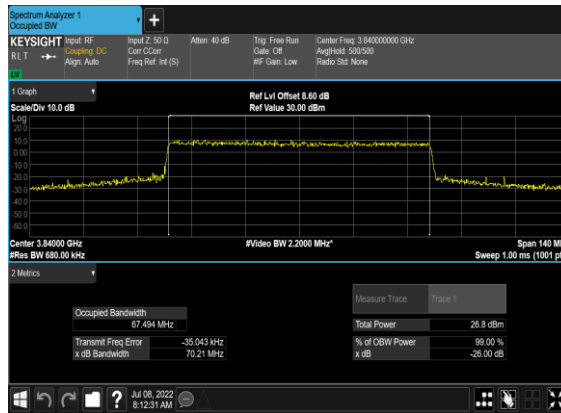

### N77(70M)\_CP-OFDM\_64 QAM\_Outer\_Full\_Mid\_CH

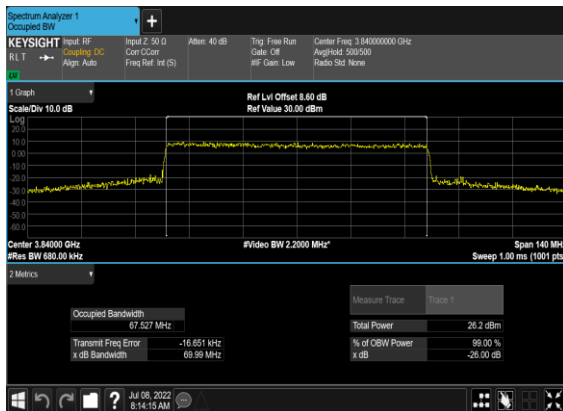

### N77(70M)\_CP-OFDM\_256 QAM\_Outer\_Full\_Mid\_CH

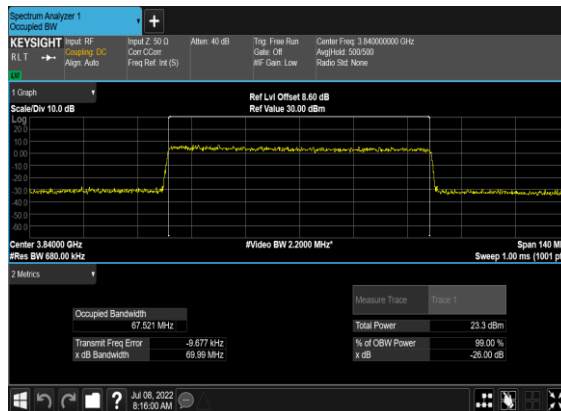

### N77(80M)\_DFT-s-OFDM\_PI\_2- BPSK\_Outer\_Full\_Mid\_CH

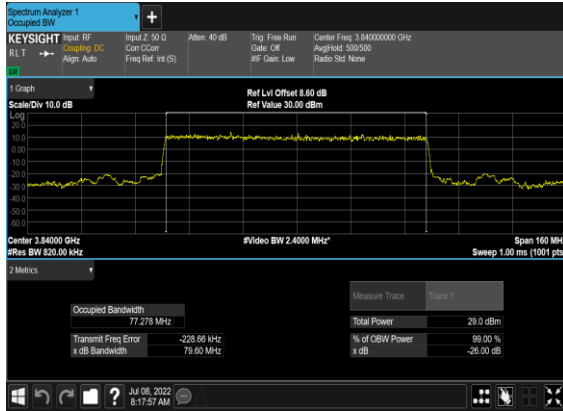

### N77(80M)\_DFT-s- OFDM\_QPSK\_Outer\_Full\_Mid\_CH

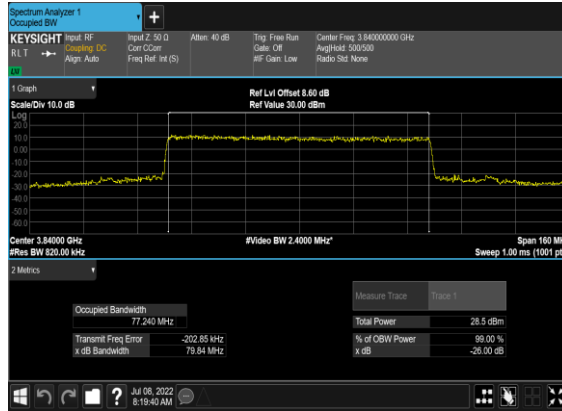

### N77(80M)\_CP- OFDM\_QPSK\_Outer\_Full\_Mid\_CH

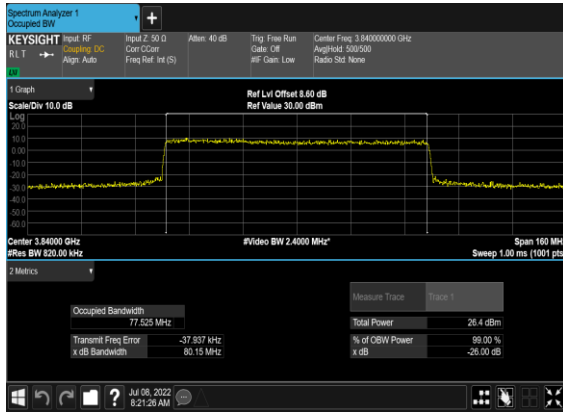

### N77(80M)\_CP-OFDM\_16 QAM\_Outer\_Full\_Mid\_CH

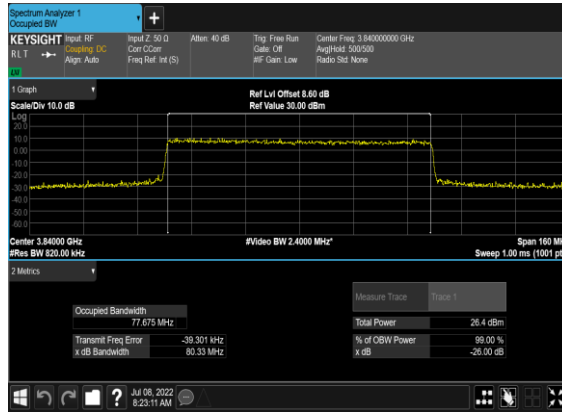

### N77(80M)\_CP-OFDM\_64 QAM\_Outer\_Full\_Mid\_CH

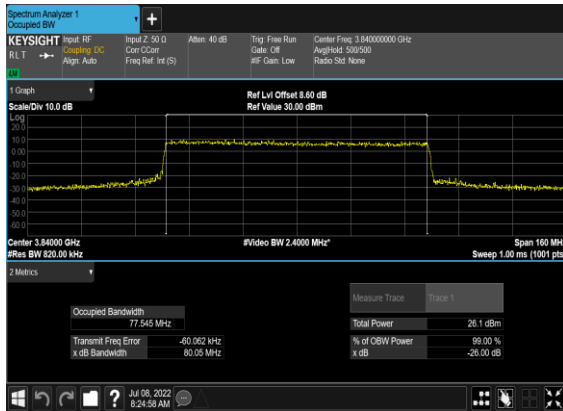

### N77(80M)\_CP-OFDM\_256 QAM\_Outer\_Full\_Mid\_CH

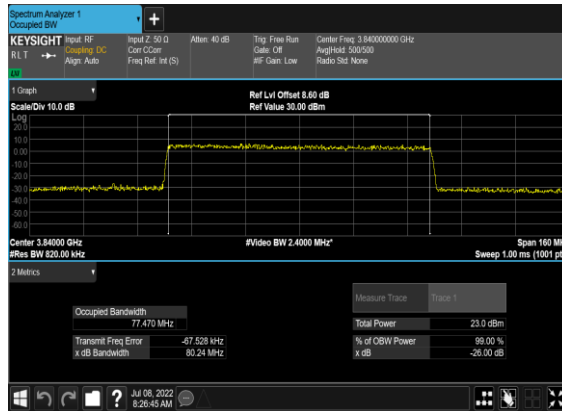

### N77(90M)\_DFT-s-OFDM\_PI\_2- BPSK\_Outer\_Full\_Mid\_CH

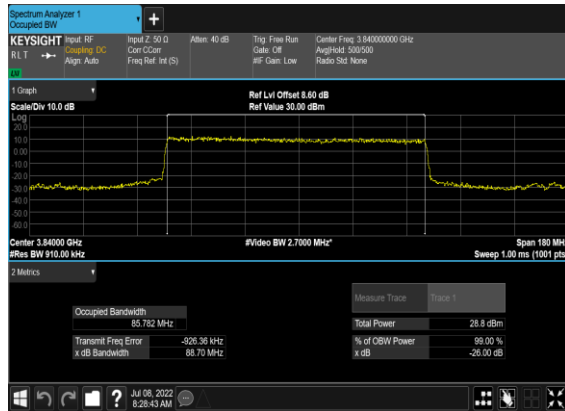

### N77(90M)\_DFT-s- OFDM\_QPSK\_Outer\_Full\_Mid\_CH

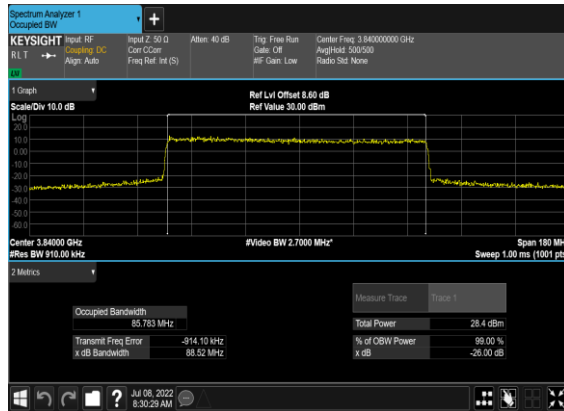

### N77(90M)\_CP- OFDM\_QPSK\_Outer\_Full\_Mid\_CH

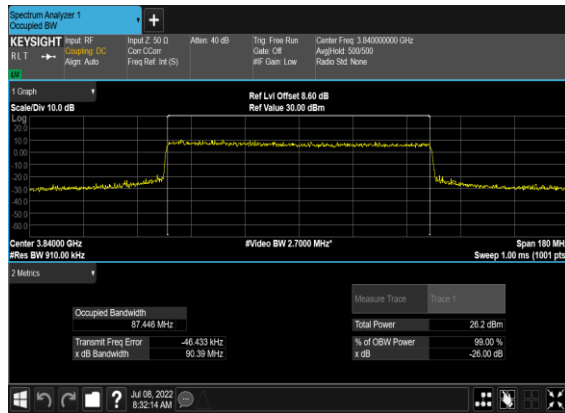

### N77(90M)\_CP-OFDM\_16 QAM\_Outer\_Full\_Mid\_CH

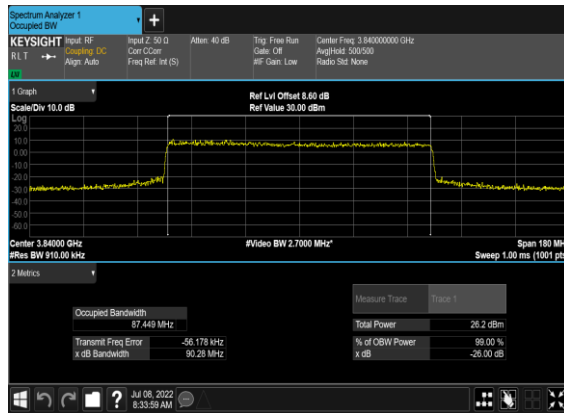

### N77(90M)\_CP-OFDM\_64 QAM\_Outer\_Full\_Mid\_CH

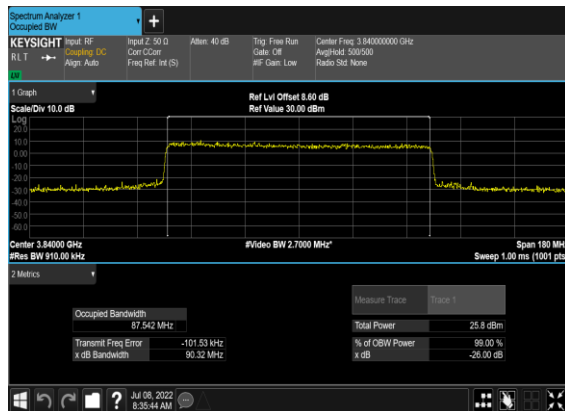

### N77(90M)\_CP-OFDM\_256 QAM\_Outer\_Full\_Mid\_CH

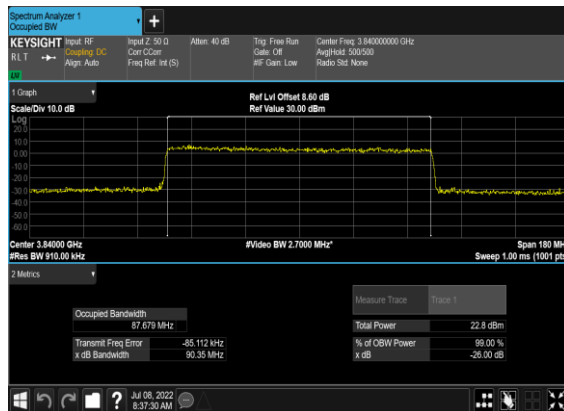

### N77(100M)\_DFT-s-OFDM\_PI\_2-BPSK\_Outer\_Full\_Mid\_CH

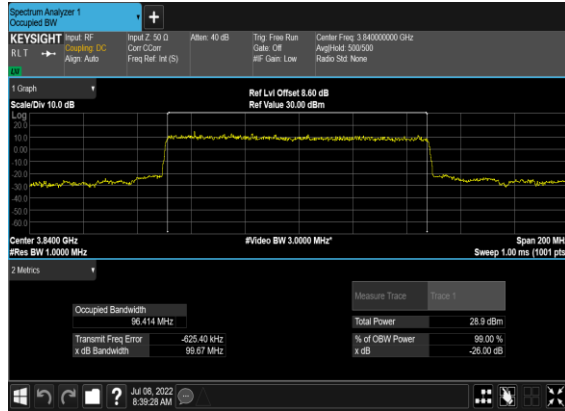

### N77(100M)\_DFT-s-OFDM\_QPSK\_Outer\_Full\_Mid\_CH

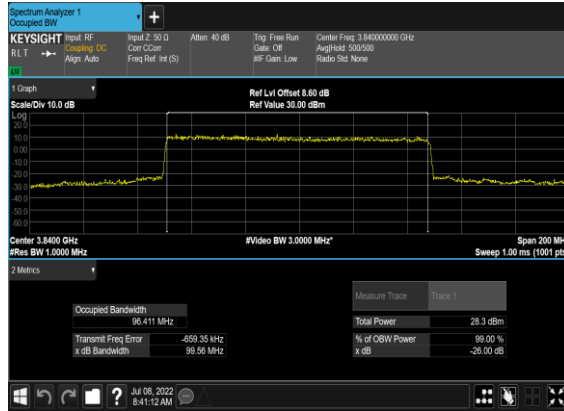

### N77(100M)\_CP-OFDM\_QPSK\_Outer\_Full\_Mid\_CH



### N77(100M)\_CP-OFDM\_16QAM\_Outer\_Full\_Mid\_CH

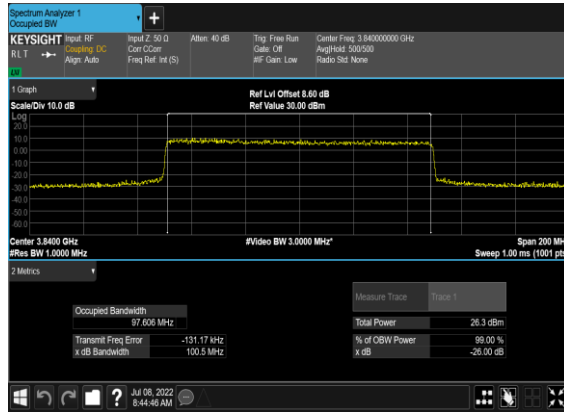

### N77(100M)\_CP-OFDM\_64QAM\_Outer\_Full\_Mid\_CH

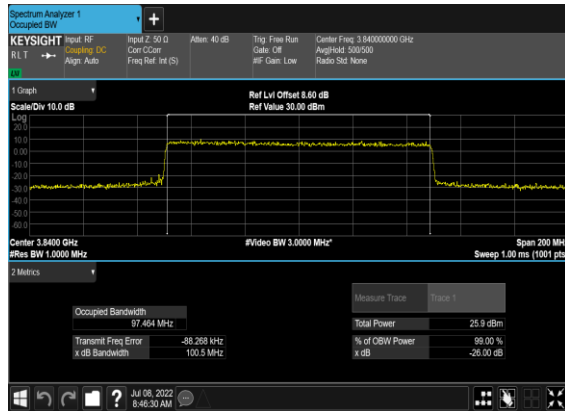

### N77(100M)\_CP-OFDM\_256QAM\_Outer\_Full\_Mid\_CH

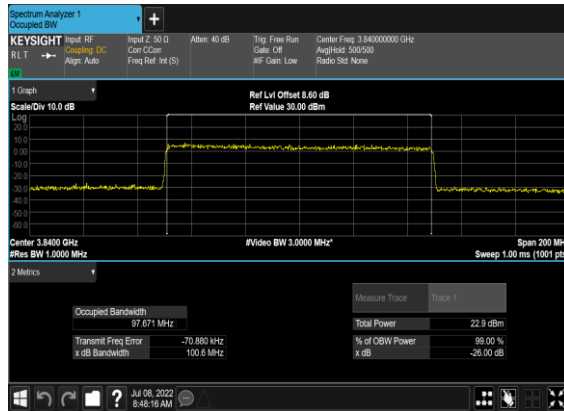

## Conducted Spurious Emissions

NR Band	SCS (kHz)	Bandwidth (MHz)	Arfcn	Freq (MHz)	Modulation	RB	Result	Verdict
77	30	10	647000	3705.0	DFT-s-OFDM BPSK	1@0	see graph	---
77	30	10	647000	3705.0	DFT-s-OFDM BPSK	1@0	see graph	PASS
77	30	10	647000	3705.0	DFT-s-OFDM BPSK	1@0	see graph	PASS
77	30	10	647000	3705.0	DFT-s-OFDM QPSK	1@0	see graph	---
77	30	10	647000	3705.0	DFT-s-OFDM QPSK	1@0	see graph	PASS
77	30	10	647000	3705.0	DFT-s-OFDM QPSK	1@0	see graph	PASS
77	30	10	656000	3840.0	DFT-s-OFDM BPSK	1@0	see graph	---
77	30	10	656000	3840.0	DFT-s-OFDM BPSK	1@0	see graph	PASS
77	30	10	656000	3840.0	DFT-s-OFDM BPSK	1@0	see graph	PASS
77	30	10	656000	3840.0	DFT-s-OFDM QPSK	1@0	see graph	---
77	30	10	656000	3840.0	DFT-s-OFDM QPSK	1@0	see graph	PASS
77	30	10	656000	3840.0	DFT-s-OFDM QPSK	1@0	see graph	PASS
77	30	10	665000	3975.0	DFT-s-OFDM BPSK	1@0	see graph	---
77	30	10	665000	3975.0	DFT-s-OFDM BPSK	1@0	see graph	PASS
77	30	10	665000	3975.0	DFT-s-OFDM BPSK	1@0	see graph	PASS
77	30	10	665000	3975.0	DFT-s-OFDM QPSK	1@0	see graph	---
77	30	10	665000	3975.0	DFT-s-OFDM QPSK	1@0	see graph	PASS
77	30	10	665000	3975.0	DFT-s-OFDM QPSK	1@0	see graph	PASS
77	30	50	648334	3725.01	DFT-s-OFDM BPSK	1@0	see graph	---
77	30	50	648334	3725.01	DFT-s-OFDM BPSK	1@0	see graph	PASS
77	30	50	648334	3725.01	DFT-s-OFDM BPSK	1@0	see graph	PASS
77	30	50	648334	3725.01	DFT-s-OFDM QPSK	1@0	see graph	---

77	30	50	648334	3725.01	DFT-s-OFDM QPSK	1@0	see graph	<b>PASS</b>
77	30	50	648334	3725.01	DFT-s-OFDM QPSK	1@0	see graph	<b>PASS</b>
77	30	50	656000	3840.0	DFT-s-OFDM BPSK	1@0	see graph	---
77	30	50	656000	3840.0	DFT-s-OFDM BPSK	1@0	see graph	<b>PASS</b>
77	30	50	656000	3840.0	DFT-s-OFDM BPSK	1@0	see graph	<b>PASS</b>
77	30	50	656000	3840.0	DFT-s-OFDM QPSK	1@0	see graph	---
77	30	50	656000	3840.0	DFT-s-OFDM QPSK	1@0	see graph	<b>PASS</b>
77	30	50	656000	3840.0	DFT-s-OFDM QPSK	1@0	see graph	<b>PASS</b>
77	30	50	663666	3954.99	DFT-s-OFDM BPSK	1@0	see graph	---
77	30	50	663666	3954.99	DFT-s-OFDM BPSK	1@0	see graph	<b>PASS</b>
77	30	50	663666	3954.99	DFT-s-OFDM BPSK	1@0	see graph	<b>PASS</b>
77	30	50	663666	3954.99	DFT-s-OFDM QPSK	1@0	see graph	---
77	30	50	663666	3954.99	DFT-s-OFDM QPSK	1@0	see graph	<b>PASS</b>
77	30	50	663666	3954.99	DFT-s-OFDM QPSK	1@0	see graph	<b>PASS</b>
77	30	100	650000	3750.0	DFT-s-OFDM BPSK	1@0	see graph	---
77	30	100	650000	3750.0	DFT-s-OFDM BPSK	1@0	see graph	<b>PASS</b>
77	30	100	650000	3750.0	DFT-s-OFDM BPSK	1@0	see graph	<b>PASS</b>
77	30	100	650000	3750.0	DFT-s-OFDM QPSK	1@0	see graph	---
77	30	100	650000	3750.0	DFT-s-OFDM QPSK	1@0	see graph	<b>PASS</b>
77	30	100	650000	3750.0	DFT-s-OFDM QPSK	1@0	see graph	<b>PASS</b>
77	30	100	656000	3840.0	DFT-s-OFDM BPSK	1@0	see graph	---
77	30	100	656000	3840.0	DFT-s-OFDM BPSK	1@0	see graph	<b>PASS</b>
77	30	100	656000	3840.0	DFT-s-OFDM BPSK	1@0	see graph	<b>PASS</b>
77	30	100	656000	3840.0	DFT-s-OFDM QPSK	1@0	see graph	---



77	30	100	656000	3840.0	DFT-s-OFDM QPSK	1@0	see graph	<b>PASS</b>
77	30	100	656000	3840.0	DFT-s-OFDM QPSK	1@0	see graph	<b>PASS</b>
77	30	100	662000	3930.0	DFT-s-OFDM BPSK	1@0	see graph	---
77	30	100	662000	3930.0	DFT-s-OFDM BPSK	1@0	see graph	<b>PASS</b>
77	30	100	662000	3930.0	DFT-s-OFDM BPSK	1@0	see graph	<b>PASS</b>
77	30	100	662000	3930.0	DFT-s-OFDM QPSK	1@0	see graph	---
77	30	100	662000	3930.0	DFT-s-OFDM QPSK	1@0	see graph	<b>PASS</b>
77	30	100	662000	3930.0	DFT-s-OFDM QPSK	1@0	see graph	<b>PASS</b>

N77(10M)\_DFT-s-OFDM\_BPSK\_Edge\_1RB\_Left\_Low\_CH

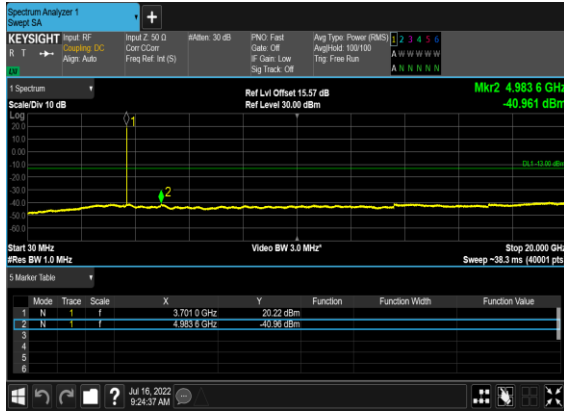

N77(10M)\_DFT-s-OFDM\_BPSK\_Edge\_1RB\_Left\_Low\_CH

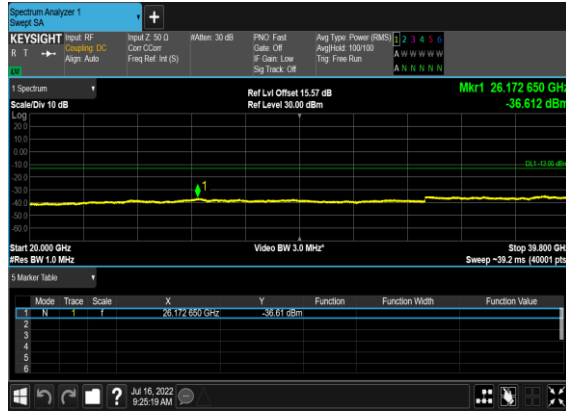

N77(10M)\_DFT-s-OFDM\_QPSK\_Edge\_1RB\_Left\_Low\_CH



N77(10M)\_DFT-s-OFDM\_QPSK\_Edge\_1RB\_Left\_Low\_CH

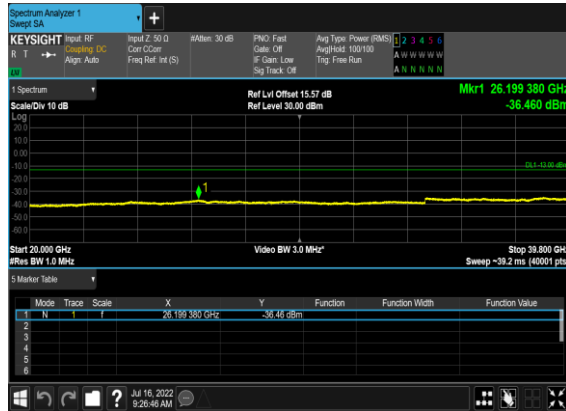

N77(10M)\_DFT-s-OFDM\_BPSK\_Edge\_1RB\_Left\_Mid\_CH

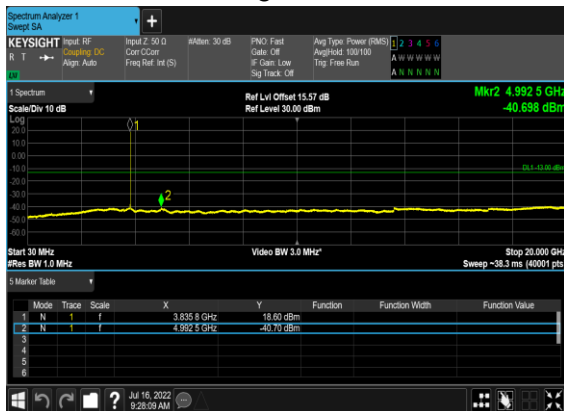

N77(10M)\_DFT-s-OFDM\_BPSK\_Edge\_1RB\_Left\_Mid\_CH

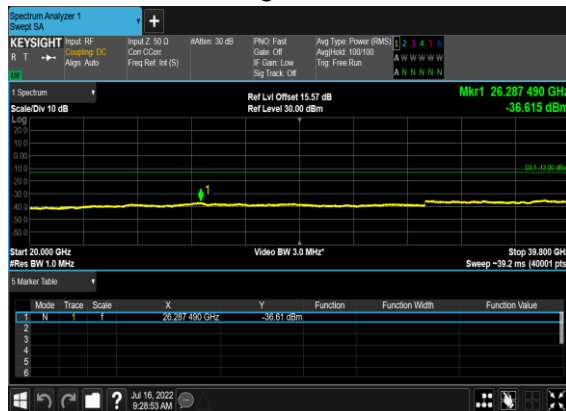

N77(10M)\_DFT-s-OFDM\_QPSK\_Edge\_1RB\_Left\_Mid\_CH



N77(10M)\_DFT-s-OFDM\_QPSK\_Edge\_1RB\_Left\_Mid\_CH

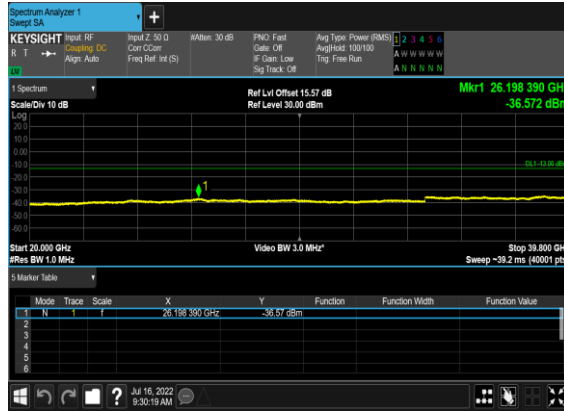

N77(10M)\_DFT-s-OFDM\_BPSK\_Edge\_1RB\_Left\_High\_CH

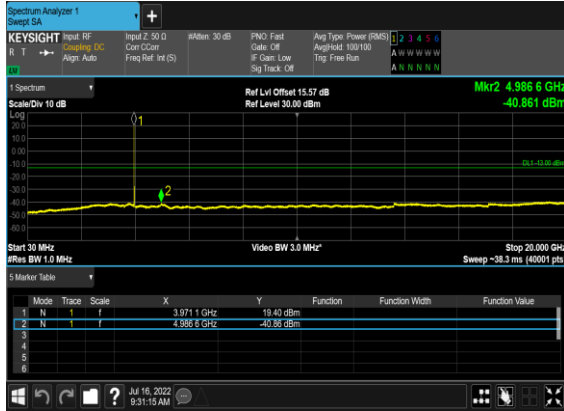

N77(10M)\_DFT-s-OFDM\_BPSK\_Edge\_1RB\_Left\_High\_CH

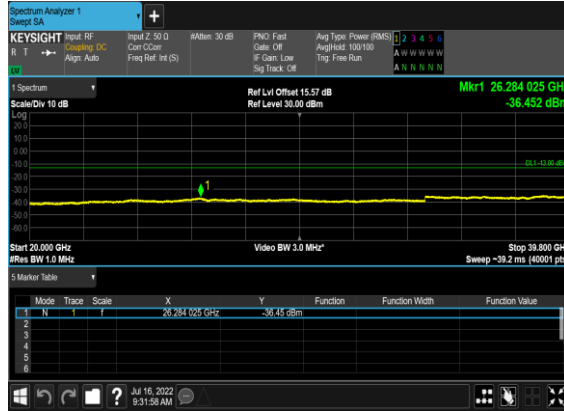

N77(10M)\_DFT-s-OFDM\_QPSK\_Edge\_1RB\_Left\_High\_CH

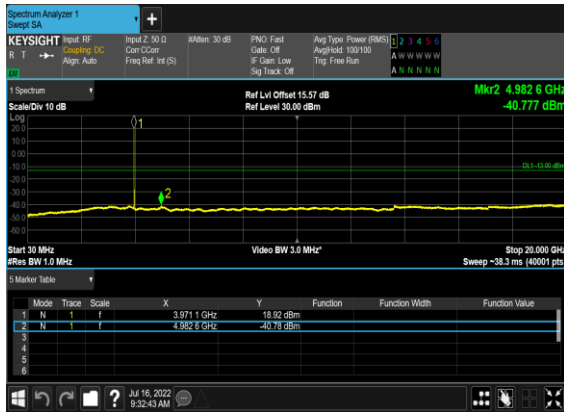

N77(10M)\_DFT-s-OFDM\_QPSK\_Edge\_1RB\_Left\_High\_CH

