



FCC RF Test Report

APPLICANT : Franklin Technology Inc.
EQUIPMENT : 5G RF module
MODEL NAME : M2500
FCC ID : XHG-M2500
STANDARD : 47 CFR Part 2, 24, 27
CLASSIFICATION : PCS Licensed Transmitter (PCB)
TEST DATE(S) : Jul. 09, 2022 ~ Jul. 28, 2022

We, Sporton International Inc. (Kunshan), would like to declare that the tested sample has been evaluated in accordance with the procedures given in ANSI C63.26-2015 and shown compliance with the applicable technical standards.

This report contains data that were produced under subcontract by Sporton International Inc. (Shenzhen).

The test results in this report apply exclusively to the tested model / sample. Without written approval of Sporton International Inc. (Kunshan), the test report shall not be reproduced except in full.

Jason Jia

Approved by: Jason Jia



Sporton International Inc. (Kunshan)

**No. 1098, Pengxi North Road, Kunshan Economic Development Zone Jiangsu Province 215300
People's Republic of China**



TABLE OF CONTENTS

REVISION HISTORY... 3
SUMMARY OF TEST RESULT ... 4
1 GENERAL DESCRIPTION ... 5
1.1 Applicant ... 5
1.2 Manufacturer ... 5
1.3 Product Feature of Equipment Under Test ... 5
1.4 Product Specification of Equipment Under Test ... 6
1.5 Modification of EUT ... 6
1.6 Maximum ERP/EIRP Power and Emission Designator ... 7
1.7 Testing Location ... 8
1.8 Test Software ... 9
1.9 Applicable Standards ... 9
2 TEST CONFIGURATION OF EQUIPMENT UNDER TEST ... 10
2.1 Test Mode ... 10
2.2 Connection Diagram of Test System ... 12
2.3 Support Unit used in test configuration and system ... 12
2.4 Measurement Results Explanation Example ... 13
2.5 Frequency List of Low/Middle/High Channels ... 14
3 CONDUCTED TEST ITEMS ... 16
3.1 Measuring Instruments ... 16
3.2 Test Setup ... 16
3.3 Test Result of Conducted Test ... 16
3.4 Conducted Output Power and ERP/EIRP ... 17
3.5 Peak-to-Average Ratio ... 18
3.6 Occupied Bandwidth ... 19
3.7 Conducted Band Edge ... 20
3.8 Conducted Spurious Emission ... 22
3.9 Frequency Stability ... 23
4 RADIATED TEST ITEMS ... 24
4.1 Measuring Instruments ... 24
4.2 Test Setup ... 24
4.3 Test Result of Radiated Test ... 25
4.4 Radiated Spurious Emission ... 26
5 LIST OF MEASURING EQUIPMENT ... 27
6 UNCERTAINTY OF EVALUATION ... 28
APPENDIX A. TEST RESULTS OF CONDUCTED TEST
APPENDIX B. TEST RESULTS OF RADIATED TEST
APPENDIX C. TEST SETUP PHOTOGRAPHS



REVISION HISTORY

REPORT NO.	VERSION	DESCRIPTION	ISSUED DATE
FG262007D	Rev. 01	Initial issue of report	Aug. 23, 2022



SUMMARY OF TEST RESULT

Report Section	FCC Rule	Description	Limit	Result	Remark
3.4	§2.1046	Conducted Output Power	Reporting Only	PASS	-
	§27.50(c)(10)	Effective Radiated Power (5G NR n71)	ERP < 3 Watt		
	§24.232(c) §27.50(h)(2)	Equivalent Isotropic Radiated Power (5G NR n25) (5G NR n41)	EIRP < 2Watt		
	§27.50(d)(4)	Equivalent Isotropic Radiated Power (5G NR n66)	EIRP < 1Watt		
3.5	§24.232(d) §27.50(j)(4)	Peak-to-Average Ratio	<13 dB	PASS	-
3.6	§2.1049	Occupied Bandwidth	Reporting Only	PASS	-
3.7	§2.1051 §24.238(a) §27.53(h) §27.53(g)	Conducted Band Edge Measurement (5G NR n25) (5G NR n66) (5G NR n71)	< 43+10log ₁₀ (P[Watts])	PASS	-
	§27.53(m)(4)	Conducted Band Edge Measurement (5G NR n41)	§27.53(m)(4)		
3.8	§2.1051 §24.238(a) §27.53(h) §27.53(g)	Conducted Spurious Emission (5G NR n25) (5G NR n66) (5G NR n71)	< 43+10log ₁₀ (P[Watts])	PASS	-
	§2.1051 §27.53(m)(4)	Conducted Spurious Emission (5G NR n41)	< 55+10log ₁₀ (P[Watts])		
3.9	§2.1055 §22.355	Frequency Stability Temperature & Voltage	< 2.5 ppm for Part 22	PASS	-
	§24.235 §27.54		Within Authorized Band		
4.4	§2.1053 §24.238(a) §27.53(h) §27.53(g)	Radiated Spurious Emission (5G NR n25) (5G NR n66) (5G NR n71)	< 43+10log ₁₀ (P[Watts])	PASS	Under limit 18.50 dB at 6910.000 MHz
	§2.1053 §27.53(m)(4)	Radiated Spurious Emission (5G NR n41)	< 55+10log ₁₀ (P[Watts])		

Declaration of Conformity:

The test results with all measurement uncertainty excluded are presented in accordance with the regulation limits or requirements declared by manufacturers.

Comments and Explanations:

The declared of product specification for EUT presented in the report are provided by the manufacturer, and the manufacturer takes all the responsibilities for the accuracy of product specification.



1 General Description

1.1 Applicant

Franklin Technology Inc.

906 JEI Platz, 186, Gasan digital 1-ro, Gumcheon-Gu, Seoul, South Korea, 08502

1.2 Manufacturer

Franklin Technology Inc.

906 JEI Platz, 186, Gasan digital 1-ro, Gumcheon-Gu, Seoul, South Korea, 08502

1.3 Product Feature of Equipment Under Test

Product Feature	
Equipment	5G RF module
Model Name	M2500
FCC ID	XHG-M2500
IMEI Code	Conducted : 358563790001254 Radiation : 355561840003083
HW Version	P1
SW Version	RG2100.TM.1354
EUT Stage	Identical Prototype

Remark:

Only 5G NR bands are tested in this report, all the other RF bands are tested in the other reports separately.



1.4 Product Specification of Equipment Under Test

Standards-related Product Specification	
Tx Frequency	5G NR n25 : 1850 MHz ~ 1915 MHz 5G NR n41 : 2496 MHz ~ 2690 MHz 5G NR n66 : 1710 MHz ~ 1780 MHz 5G NR n71: 663 MHz ~ 698 MHz
Rx Frequency	5G NR n25 : 1930 MHz ~ 1995 MHz 5G NR n41 : 2496 MHz ~ 2690 MHz 5G NR n66 : 2110 MHz~ 2200 MHz 5G NR n71: 617 MHz ~ 652 MHz
SCS	n25/n66/n71:15kHz n41:30kHz
Bandwidth	n25: 5/10/15/20/25/30/40MHz n66: 5/10/15/20/30/40MHz n41: 20MHz / 30MHz / 40MHz / 50MHz / 60MHz / 70MHz / 80MHz / 90MHz / 100MHz n71: 5MHz / 10MHz / 15MHz / 20MHz
Antenna Gain	<Ant. 0> n25: -1.66 dBi n41: -2.99 dBi n66: -1.56 dBi n71: -2.75 dBi <Ant. 2> n25: -1.54 dBi n66: -1.19 dBi <Ant. 3> n41: -2.18 dBi
Type of Modulation	CP-OFDM: QPSK / 16QAM / 64QAM / 256QAM DFT-s-OFDM: PI/2 BPSK / QPSK / 16QAM / 64QAM / 256QAM

Remark:

1. The maximum ERP/EIRP is calculated from output power and antenna gain, only the maximum ERP/EIRP are shown in the report, 5G NR n25/n66 for Ant. 2 and n41 for Ant. 3 and n71 for Ant.0.
2. 5G NR n25/n41/n66/n71 support SA and NSA modely. According to the maximum power between SA and NSA mode, SA covers NSA mode.
3. The EN-DC mode combination could be referred to the product spec.
4. 5G NR n41 supports HPUE mode.

1.5 Modification of EUT

No modifications are made to the EUT during all test items.



1.6 Maximum Conduted Power and Emission Designator

5G NR n25		PI/2 BPSK / QPSK		16QAM / 64QAM / 256QAM	
BW (MHz)	Frequency Range (MHz)	Maximum Conducted power (W)	Emission Designator (99%OBW)	Maximum Conducted power (W)	Emission Designator (99%OBW)
5	1852.5 ~ 1912.5	0.2198	4M48G7D	0.1879	4M49W7D
10	1855.0 ~ 1910.0	0.2228	9M30G7D	0.1799	9M31W7D
15	1857.5 ~ 1907.5	0.2382	14M1G7D	0.1879	14M1W7D
20	1860.0 ~ 1905.0	0.2443	18M9G7D	0.1897	18M9W7D
25	1862.5 ~ 1902.5	0.2254	23M7G7D	0.1862	23M8W7D
30	1865.0 ~ 1900.0	0.2328	28M5G7D	0.1837	28M5W7D
40	1870.0 ~ 1895.0	0.2495	38M5G7D	0.1888	38M6W7D

5G NR n41		PI/2 BPSK / QPSK		16QAM / 64QAM / 256QAM	
BW (MHz)	Frequency Range (MHz)	Maximum Conducted power (W)	Emission Designator (99%OBW)	Maximum Conducted power (W)	Emission Designator (99%OBW)
20	2506.02 ~ 2679.99	0.3148	18M2G7D	0.2500	18M2W7D
30	2511.00 ~ 2674.98	0.3148	27M8G7D	0.2547	27M9W7D
40	2516.01 ~ 2670.00	0.3206	37M8G7D	0.2570	37M9W7D
50	2521.02 ~ 2664.99	0.3155	47M5G7D	0.2506	47M6W7D
60	2526.00 ~ 2659.98	0.3076	58M1G7D	0.2500	57M9W7D
70	2531.01 ~ 2655.00	0.3048	67M6G7D	0.2388	67M6W7D
80	2536.02 ~ 2649.99	0.2944	77M7G7D	0.2466	77M6W7D
90	2541.00 ~ 2644.98	0.2917	87M7G7D	0.2333	87M8W7D
100	2546.01 ~ 2640.00	0.3357	97M6G7D	0.2704	97M7W7D

5G NR n66		PI/2 BPSK / QPSK		16QAM / 64QAM / 256QAM	
BW (MHz)	Frequency Range (MHz)	Maximum Conducted power (W)	Emission Designator (99%OBW)	Maximum Conducted power (W)	Emission Designator (99%OBW)
5	1712.5 ~ 1777.5	0.2018	4M49G7D	0.1622	4M50W7D
10	1715.0 ~ 1775.0	0.2051	9M28G7D	0.1648	9M30W7D
15	1717.5 ~ 1772.5	0.2178	14M1G7D	0.1734	14M1W7D
20	1720.0 ~ 1770.0	0.2208	18M9G7D	0.1742	18M9W7D
30	1725.0 ~ 1765.0	0.2244	28M6G7D	0.1738	28M5W7D
40	1730.0 ~ 1760.0	0.2249	38M6G7D	0.1722	38M5W7D



5G NR n71		PI/2 BPSK / QPSK		16QAM / 64QAM / 256QAM	
BW (MHz)	Frequency Range (MHz)	Maximum Conducted power (W)	Emission Designator (99%OBW)	Maximum Conducted power (W)	Emission Designator (99%OBW)
5	665.5 ~ 695.5	0.2455	4M48G7D	0.2046	4M49W7D
10	668.0 ~ 693.0	0.2438	9M29G7D	0.1968	9M31W7D
15	670.5 ~ 690.5	0.2438	14M1G7D	0.1950	14M1W7D
20	673.0 ~ 688.0	0.2518	18M9G7D	0.2080	18M9W7D

Note: All modulations have been tested, and only the worst test results of PSK & QAM are shown in the report .

1.7 Testing Location

Sporton International Inc. (Kunshan) is accredited to ISO/IEC 17025:2017 by American Association for Laboratory Accreditation with Certificate Number 5145.02.

Test Firm	Sporton International Inc. (Kunshan)		
Test Site Location	No. 1098, Pengxi North Road, Kunshan Economic Development Zone Jiangsu Province 215300 People's Republic of China TEL : +86-512-57900158 FAX : +86-512-57900958		
Test Site No.	Sporton Site No.	FCC Designation No.	FCC Test Firm Registration No.
	03CH04-KS	CN1257	314309

Sporton International Inc. (Shenzhen) is accredited to ISO/IEC 17025:2017 by American Association for Laboratory Accreditation with Certificate Number 5145.01.

Test Firm	Sporton International Inc. (Shenzhen)		
Test Site Location	1/F, 2/F, Bldg 5, Shiling Industrial Zone, Xinwei Village, Xili, Nanshan, Shenzhen, 518055 People's Republic of China TEL: +86-755-86379589 FAX: +86-755-86379595		
Test Site No.	Sporton Site No.	FCC Designation No.	FCC Test Firm Registration No.
	TH01-SZ	CN1256	421272

Note: Test data subcontracted: Conducted test cases in section 3 of this report



1.8 Test Software

Item	Site	Manufacturer	Name	Version
1.	03CH04-KS	AUDIX	E3	6.2009-8-24a

1.9 Applicable Standards

According to the specifications of the manufacturer, the EUT must comply with the requirements of the following standards:

- ♦ 47 CFR Part 2, 24, 27
- ♦ ANSI C63.26-2015
- ♦ FCC KDB 971168 D01 Power Meas License Digital Systems v03r01
- ♦ FCC KDB 412172 D01 Determining ERP and EIRP v01r01

Remark:

All test items were verified and recorded according to the standards and without any deviation during the test.



2 Test Configuration of Equipment Under Test

2.1 Test Mode

Antenna port conducted and radiated test items are performed according to KDB 971168 D01 Power Meas License Digital Systems v03r01 with maximum output power.

For radiated measurement, pre-scanned in three orthogonal panels, X, Y, Z. The worst cases (Z plane) were recorded in this report.

The device is investigated from 30MHz to 10 times of fundamental signal for radiated spurious emission test under different RB size/offset and modulations in exploratory test. Subsequently, only the worst case emissions are reported.

Orthogonal Planes of EUT	X Plane	Y Plane	Z Plane
			

Test Items	5G NR	Bandwidth (MHz)										Modulation				RB #		Test Channel			
		5	10	15	20	25	30	40	50	60	70~90	100	PI/2 BPSK	QPSK	16QAM	64QAM	256QAM	1	Full	L	M
Max. Output Power	n25	v	v	v	v	v	v	v	-	-	-	v	v	v	v	v	v	v	v	v	v
	n41				v	v	v	v	v	v	v	v	v	v	v	v	v	v	v	v	v
	n66	v	v	v	v	v	v	v	-	-	-	v	v	v	v	v	v	v	v	v	v
	n71	v	v	v	v							v	v	v	v	v	v	v	v	v	v
Peak-to-Average Ratio	n25				v							v	v				v	v	v	v	v
	n41	-	-		v							v	v				v	v	v	v	v
	n66				v							v	v				v	v	v	v	v
	n71				v							v	v				v	v	v	v	v
26dB and 99% Bandwidth	n25	v	v	v	v	v	v	v	-	-	-	v	v	v	v	v		v		v	
	n41	-	-		v	v	v	v	v	v	v	v	v	v	v	v		v		v	
	n66	v	v	v	v	v	v	v	-	-	-	v	v	v	v	v		v		v	
	n71	v	v	v	v							v	v	v	v	v		v		v	



Test Items	Band	Bandwidth (MHz)											Modulation				RB #		Test Channel			
		5	10	15	20	25	30	40	50	60	70~90	100	PI/2 BPSK	QPSK	16QAM	64QAM	256QAM	1	Full	L	M	H
Conducted Band Edge	n25	v			v			v					v	v				v	v	v		v
	n41				v					v			v	v				v	v	v		v
	n66	v			v			v					v	v				v	v	v		v
	n71	v	v		v								v	v				v	v	v		v
Conducted Spurious Emission	n25	v			v			v					v	v				v		v	v	v
	n41				v					v			v	v				v		v	v	v
	n66	v			v			v					v	v				v		v	v	v
	n71	v	v		v								v	v				v		v	v	v
Frequency Stability	n25				v									v					v		v	
	n41				v									v					v		v	
	n66				v									v					v		v	
	n71				v									v					v		v	
E.R.P / E.I.R.P	n25	v	v	v	v	v	v	v	-		-		v	v	v	v	v	v	v	v	v	v
	n41				v		v	v	v	v	v		v	v	v	v	v	v	v	v	v	v
	n66	v	v	v	v		v	v	-		-		v	v	v	v	v	v	v	v	v	v
	n71	v	v	v	v				-		-		v	v	v	v	v	v	v	v	v	v
Radiated Spurious Emission	n25	Worst Case																				v
	n41	Worst Case																				v
	n66	Worst Case																				v
	n71	Worst Case																				v
Note	<ol style="list-style-type: none"> The mark "v" means that this configuration is chosen for testing The mark "-" means that this bandwidth is not supported. The device is investigated from 30MHz to 10 times of fundamental signal for radiated spurious emission test under different RB size/offset and modulations in exploratory test. Subsequently, only the worst case emissions are reported. Based on engineering evaluation, only the worst modulation test results are shown in the report. Normal Voltage = 3.8V ; Low Voltage =3.6V. ; High Voltage =4.2V 																					

2.2 Connection Diagram of Test System

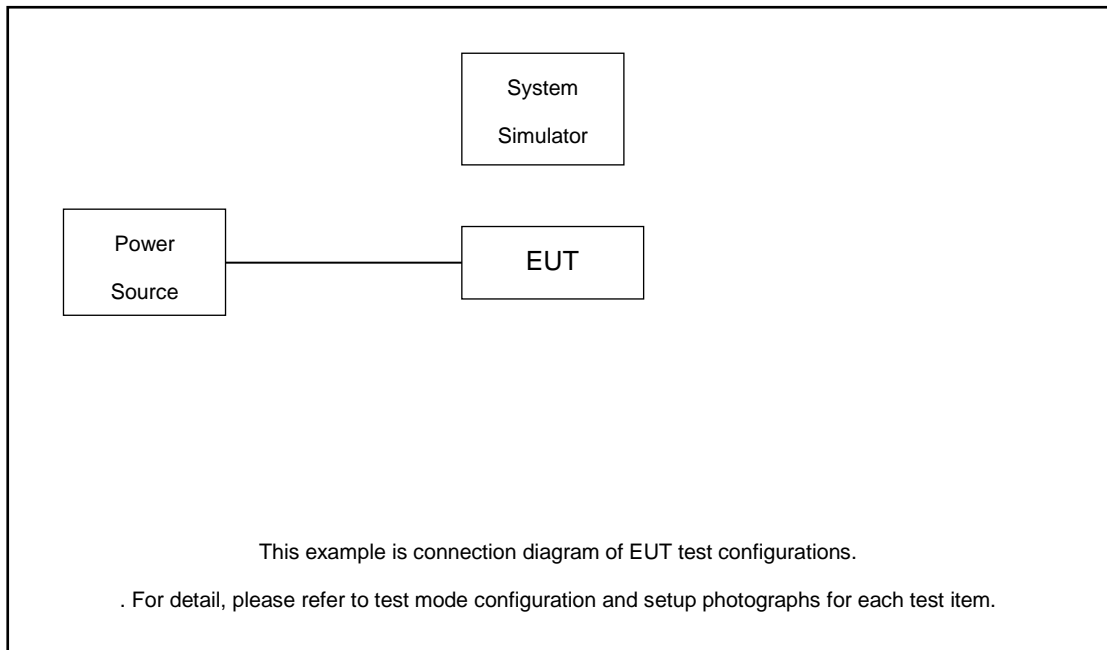

2.3 Support Unit used in test configuration and system

Item	Equipment	Trade Name	Model No.	FCC ID	Data Cable	Power Cord
1.	DC Power Supply	GW	GPS-3030D	N/A	N/A	Unshielded, 1.8 m
2.	LTE Base Station	Anritsu	MT8821C	N/A	N/A	Unshielded, 1.8 m
3.	NR Base Station	Anritsu	MT8000A	N/A	N/A	Unshielded, 1.8 m
4.	Adapter	N/A	N/A	N/A	N/A	N/A
5.	Test Jig	N/A	N/A	N/A	N/A	N/A



2.4 Measurement Results Explanation Example

For all conducted test items:

The offset level is set in the spectrum analyzer to compensate the RF cable loss between EUT conducted output port and spectrum analyzer. With the offset compensation, the spectrum analyzer reading level is exactly the EUT RF output level.

The spectrum analyzer offset is derived from RF cable loss.

Offset = RF cable loss.

Following shows an offset computation example with cable loss 7.8 dB.

Example :

$$\begin{aligned} \text{Offset(dB)} &= \text{RF cable loss(dB)}. \\ &= 7.8 \text{ (dB)} \end{aligned}$$



2.5 Frequency List of Low/Middle/High Channels

5G NR n25 Channel and Frequency List				
BW [MHz]	Channel/Frequency(MHz)	Lowest	Middle	Highest
40	Channel	390000	392500	395000
	Frequency	1870	1882.5	1895
30	Channel	389000	392500	396000
	Frequency	1865	1882.5	1900
25	Channel	388500	392500	396500
	Frequency	1862.5	1882.5	1902.5
20	Channel	388000	392500	397000
	Frequency	1860	1882.5	1905
15	Channel	387500	392500	397500
	Frequency	1857.5	1882.5	1907.5
10	Channel	387000	392500	398000
	Frequency	1855	1882.5	1910
5	Channel	386500	392500	398500
	Frequency	1852.5	1882.5	1912.5

5G NR n41 Channel and Frequency List				
BW [MHz]	Channel/Frequency(MHz)	Lowest	Middle	Highest
100	Channel	509202	518598	528000
	Frequency	2546.01	2592.99	2640
90	Channel	508200	518598	528996
	Frequency	2541	2592.99	2644.98
80	Channel	507204	518598	529998
	Frequency	2536.02	2592.99	2649.99
70	Channel	506202	518598	531000
	Frequency	2531.01	2592.99	2655
60	Channel	505200	518598	531996
	Frequency	2526	2592.99	2659.98
50	Channel	504204	518598	532998
	Frequency	2521.02	2592.99	2664.99
40	Channel	503202	518598	534000
	Frequency	2516.01	2592.99	2670
30	Channel	502200	518598	534996
	Frequency	2511	2592.99	2674.98
20	Channel	501204	518598	535998
	Frequency	2506.02	2592.99	2679.99



5G NR n66 Channel and Frequency List				
BW [MHz]	Channel/Frequency(MHz)	Lowest	Middle	Highest
40	Channel	426000	429000	432000
	Frequency	1730	1745	1760
30	Channel	425000	429000	433000
	Frequency	1725	1745	1765
20	Channel	424000	429000	434000
	Frequency	1720	1745	1770
15	Channel	423500	429000	434500
	Frequency	1717.5	1745	1772.5
10	Channel	423000	429000	435000
	Frequency	1715	1745	1775
5	Channel	422500	429000	435500
	Frequency	1712.5	1745	1777.5

5G NR n71 Channel and Frequency List				
BW [MHz]	Channel/Frequency(MHz)	Lowest	Middle	Highest
20	Channel	125400	126900	128400
	Frequency	673	680.5	688
15	Channel	124900	126900	128900
	Frequency	670.5	680.5	690.5
10	Channel	124400	126900	129400
	Frequency	668	680.5	693
5	Channel	123900	126900	129900
	Frequency	665.5	680.5	695.5

3 Conducted Test Items

3.1 Measuring Instruments

See list of measuring instruments of this test report.

3.2 Test Setup

3.2.1 Conducted Output Power



3.2.2 Peak-to-Average Ratio, Occupied Bandwidth ,Conducted Band-Edge and Conducted Spurious Emission



3.2.3 Frequency Stability

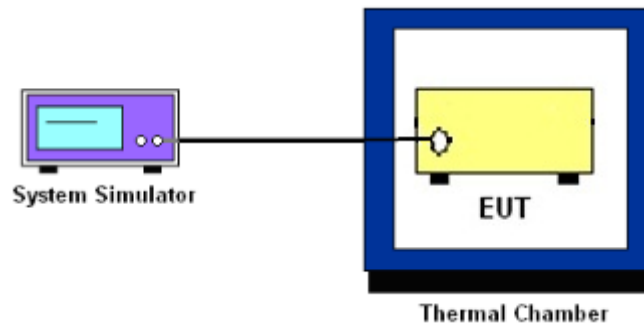

3.3 Test Result of Conducted Test

Please refer to Appendix A.



3.4 Conducted Output Power and ERP/EIRP

3.4.1 Description of the Conducted Output Power Measurement and ERP/EIRP Measurement

A system simulator was used to establish communication with the EUT. Its parameters were set to force the EUT transmitting at maximum output power. The measured power in the radio frequency on the transmitter output terminals shall be reported.

The ERP of mobile transmitters must not exceed 3 Watts for 5G NR n71.

The EIRP of mobile transmitters must not exceed 2 Watts for 5G NR n25 and n41.

The EIRP of mobile transmitters must not exceed 1 Watts for 5G NR n66.

According to KDB 412172 D01 Power Approach,

$EIRP = P_T + G_T - L_C$, $ERP = EIRP - 2.15$, where

P_T = transmitter output power in dBm

G_T = gain of the transmitting antenna in dBi

L_C = signal attenuation in the connecting cable between the transmitter and antenna in dB

3.4.2 Test Procedures

1. The testing follows ANSI C63.26 Section 5.2
2. The transmitter output port was connected to the system simulator.
3. Set EUT at maximum power through the system simulator.
4. Select lowest, middle, and highest channels for each band and different modulation.
5. Measure and record the power level from the system simulator.



3.5 Peak-to-Average Ratio

3.5.1 Description of the PAR Measurement

Power Complementary Cumulative Distribution Function (CCDF) curves provide a means for characterizing the power peaks of a digitally modulated signal on a statistical basis. A CCDF curve depicts the probability of the peak signal amplitude exceeding the average power level. Most contemporary measurement instrumentation include the capability to produce CCDF curves for an input signal provided that the instrument's resolution bandwidth can be set wide enough to accommodate the entire input signal bandwidth. In measuring transmissions in this band using an average power technique, the peak-to-average ratio (PAR) of the transmission may not exceed 13 dB.

3.5.2 Test Procedures

1. The testing follows ANSI C63.26 Section 5.2.3.4 (CCDF).
2. The EUT was connected to spectrum and system simulator via a power divider.
3. Set the CCDF (Complementary Cumulative Distribution Function) option in spectrum analyzer.
4. The highest RF powers were measured and recorded the maximum PAPR level associated with a probability of 0.1 %.
5. Record the deviation as Peak to Average Ratio.



3.6 Occupied Bandwidth

3.6.1 Description of Occupied Bandwidth Measurement

The occupied bandwidth is the width of a frequency band such that, below the lower and above the upper frequency limits, the mean powers emitted are each equal to a specified percentage 0.5% of the total mean transmitted power.

The 26 dB emission bandwidth is defined as the frequency range between two points, one above and one below the carrier frequency, at which the spectral density of the emission is attenuated 26 dB below the maximum in-band spectral density of the modulated signal. Spectral density (power per unit bandwidth) is to be measured with a detector of resolution bandwidth equal to approximately 1.0% of the emission bandwidth.

3.6.2 Test Procedures

1. The testing follows ANSI C63.26 Section 5.4
2. The EUT was connected to spectrum analyzer and system simulator via a power divider.
3. The spectrum analyzer center frequency is set to the nominal EUT channel center frequency. The span range for the spectrum analyzer shall be between two and five times the anticipated OBW.
4. The nominal resolution bandwidth (RBW) shall be in the range of 1 to 5 % of the anticipated OBW, and the VBW shall be at least 3 times the RBW.
5. Set the detection mode to peak, and the trace mode to max hold.
6. Determine the reference value: Set the EUT to transmit a modulated signal. Allow the trace to stabilize. Set the spectrum analyzer marker to the highest level of the displayed trace.
(this is the reference value)
7. Determine the “-26 dB down amplitude” as equal to (Reference Value – X).
8. Place two markers, one at the lowest and the other at the highest frequency of the envelope of the spectral display such that each marker is at or slightly below the “-X dB down amplitude” determined in step 6. If a marker is below this “-X dB down amplitude” value it shall be placed as close as possible to this value. The OBW is the positive frequency difference between the two markers.
9. Use the 99 % power bandwidth function of the spectrum analyzer and report the measured bandwidth.



3.7 Conducted Band Edge

3.7.1 Description of Conducted Band Edge Measurement

24.238 (a)

For operations in the 1850-1910 and 1930-1990 MHz band, the FCC limit is $43 + 10\log_{10}(P[\text{Watts}])$ dB below the transmitter power $P(\text{Watts})$ in a 1MHz bandwidth. However, in the 1 MHz bands immediately outside and adjacent to the frequency block a resolution bandwidth of at least one percent of the emission bandwidth of the fundamental emission of the transmitter may be employed.

27.53 (h)

For operations in the 1710 – 1755 MHz and 1710 – 1780 MHz band, the FCC limit is $43 + 10\log_{10}(P[\text{Watts}])$ dB below the transmitter power $P(\text{Watts})$ in a 1 MHz bandwidth. However, in the 1MHz bands immediately outside and adjacent to the licensee's frequency block, a resolution bandwidth of at least one percent of the emission bandwidth of the fundamental emission of the transmitter may be employed.

27.53 (g)

For operations in the 600MHz band and 698 -746 MHz band, the FCC limit is $43 + 10\log_{10}(P[\text{Watts}])$ dB below the transmitter power $P(\text{Watts})$ in a 100 kHz bandwidth. However, in the 100 kilohertz bands immediately outside and adjacent to a licensee's frequency block, a resolution bandwidth of at least 30 kHz may be employed.

27.53(m)(4)

For mobile digital stations, the attenuation factor shall be not less than $40 + 10 \log (P)$ dB on all frequencies between the channel edge and 5 megahertz from the channel edge, $43 + 10 \log (P)$ dB on all frequencies between 5 megahertz and X megahertz from the channel edge, and $55 + 10 \log (P)$ dB on all frequencies more than X megahertz from the channel edge, where X is the greater of 6 megahertz or the actual emission bandwidth as defined in paragraph (m)(6) of this section. In addition, the attenuation factor shall not be less that $43 + 10 \log (P)$ dB on all frequencies between 2490.5 MHz and 2496 MHz and $55 + 10 \log (P)$ dB at or below 2490.5 MHz. Mobile Satellite Service licensees operating on frequencies below 2495 MHz may also submit a documented interference complaint against BRS licensees operating on channel BRS Channel 1 on the same terms and conditions as adjacent channel BRS or EBS licensees.



3.7.2 Test Procedures

1. The testing follows ANSI C63.26 section 5.7
2. The EUT was connected to spectrum analyzer and system simulator via a power divider.
3. The band edges of low and high channels for the highest RF powers were measured.
4. Set RBW \geq 1%/2% EBW in the 1MHz band immediately outside and adjacent to the band edge.
5. Beyond the 1 MHz band from the band edge, RBW=1MHz was used.
6. Set spectrum analyzer with RMS detector.
7. The RF fundamental frequency should be excluded against the limit line in the operating frequency band.
8. Offset has included the duty factor for Band n41. Duty factor = $10 \log (1/x)$, where x is the measured duty cycle.
9. Checked that all the results comply with the emission limit line.

Example:

The limit line is derived from $43 + 10\log(P)$ dB below the transmitter power P(Watts)
= $P(W) - [43 + 10\log(P)]$ (dB)
= $[30 + 10\log(P)]$ (dBm) - $[43 + 10\log(P)]$ (dB) = -13dBm.

10. For 5G NR n41, the other 40 dB, and 55 dB have additionally applied same calculation above.
11. When using the integration method, the starting frequency of the integration shall be centered at one-half of the RBW away from the band edge.



3.8 Conducted Spurious Emission

3.8.1 Description of Conducted Spurious Emission Measurement

The power of any emission outside of the authorized operating frequency ranges must be lower than the transmitter power (P) by a factor of at least $43 + 10 \log (P)$ dB.

For 5G NR n41:

The power of any emission outside of the authorized operating frequency ranges must be lower than the transmitter power (P) by a factor of at least $55 + 10 \log (P)$ dB.

It is measured by means of a calibrated spectrum analyzer and scanned from 30 MHz up to a frequency including its 10th harmonic.

3.8.2 Test Procedures

1. The testing follows ANSI C63.26 section 5.7
2. The EUT was connected to spectrum analyzer and system simulator via a power divider.
3. The RF output of EUT was connected to the spectrum analyzer by RF cable and attenuator. The path loss was compensated to the results for each measurement.
4. The middle channel for the highest RF power within the transmitting frequency was measured.
5. The conducted spurious emission for the whole frequency range was taken.
6. Make the measurement with the spectrum analyzer's RBW = 1MHz, VBW = 3MHz.
7. Set spectrum analyzer with RMS detector.
8. Offset has included the duty factor for Band n41. Duty factor = $10 \log (1/x)$, where x is the measured duty cycle.
9. Taking the record of maximum spurious emission.
10. The RF fundamental frequency should be excluded against the limit line in the operating frequency band.
11. The limit line is derived from $43 + 10 \log (P)$ dB below the transmitter power P(Watts)
= $P(W) - [43 + 10 \log (P)]$ (dB)
= $[30 + 10 \log (P)]$ (dBm) - $[43 + 10 \log (P)]$ (dB)
= -13dBm.
12. For 5G NR n41
The limit line is derived from $55 + 10 \log (P)$ dB below the transmitter power P(Watts)
= $P(W) - [55 + 10 \log (P)]$ (dB)
= $[30 + 10 \log (P)]$ (dBm) - $[55 + 10 \log (P)]$ (dB)
= -25dBm.



3.9 Frequency Stability

3.9.1 Description of Frequency Stability Measurement

The frequency stability shall be measured by variation of ambient temperature and variation of primary supply voltage to ensure that the fundamental emission stays within the authorized frequency block.

3.9.2 Test Procedures for Temperature Variation

1. The testing follows ANSI C63.26 section 5.6.4
2. The EUT was set up in the thermal chamber and connected with the system simulator.
3. With power OFF, the temperature was decreased to -30°C and the EUT was stabilized before testing. Power was applied and the maximum change in frequency was recorded within one minute.
4. With power OFF, the temperature was raised in 10°C step up to 50°C. The EUT was stabilized at each step for at least half an hour. Power was applied and the maximum frequency change was recorded within one minute.

3.9.3 Test Procedures for Voltage Variation

1. The testing follows ANSI C63.26 section 5.6.5
2. The EUT was placed in a temperature chamber at 20±5°C and connected with the system simulator.
3. The power supply voltage to the EUT was varied from 85% to 115% of the nominal value for other than hand carried battery equipment.
4. For hand carried, battery powered equipment, reduce the primary ac or dc supply voltage to the battery operating end point, which shall be specified by the manufacturer.
5. The variation in frequency was measured for the worst case.

4 Radiated Test Items

4.1 Measuring Instruments

See list of measuring instruments of this test report.

4.2 Test Setup

4.2.1 For radiated test below 30MHz

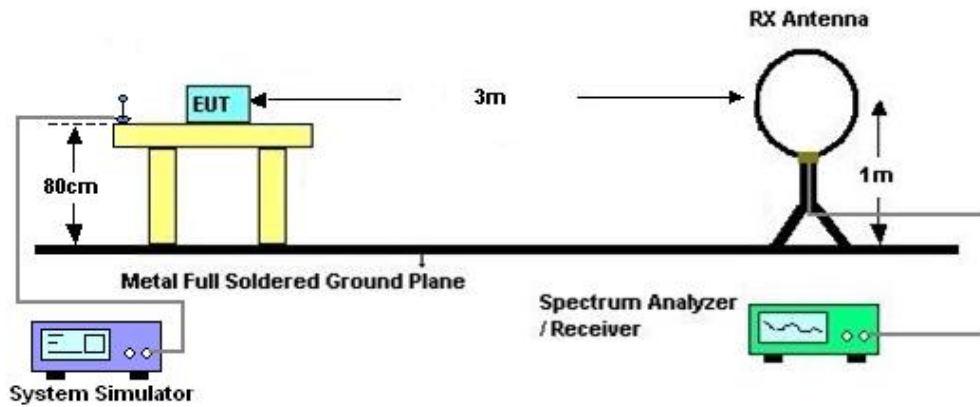

4.2.2 For radiated test from 30MHz to 1GHz

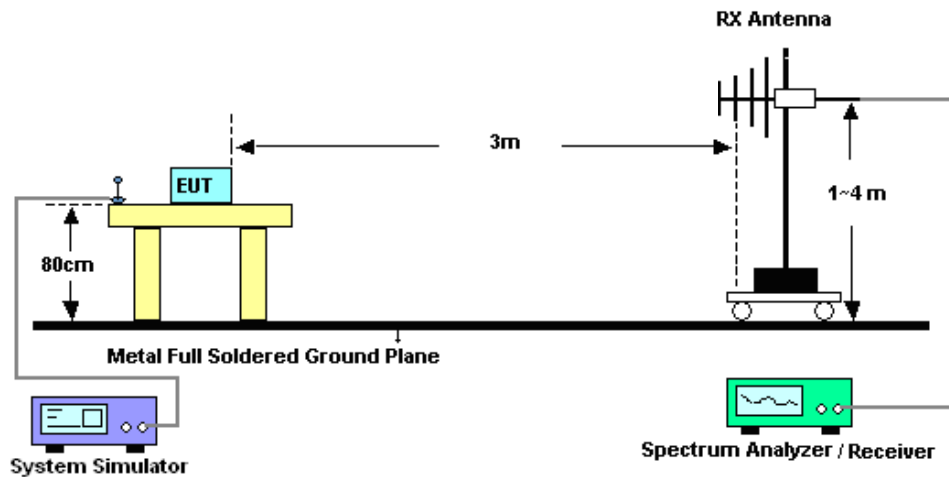

4.2.3 For radiated test above 1GHz

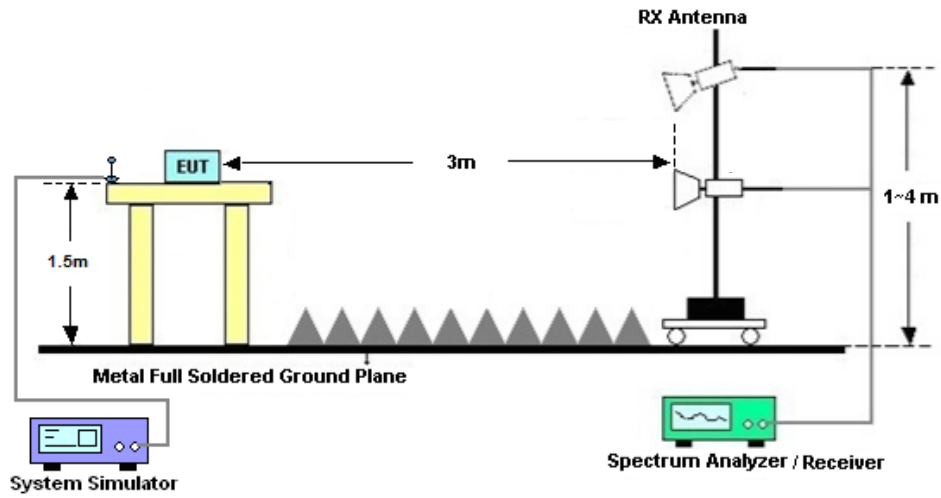

4.3 Test Result of Radiated Test

The low frequency, which started from 9 kHz to 30MHz, was pre-scanned and the result which was 20dB lower than the limit line was not reported.

Please refer to Appendix B.



4.4 Radiated Spurious Emission

4.4.1 Description of Radiated Spurious Emission

The radiated spurious emission was measured by substitution method according to ANSI C63.26. The power of any emission outside of the authorized operating frequency ranges must be attenuated below the transmitter power (P) by a factor of at least $43 + 10 \log (P)$ dB.

For 5G NR n41

The power of any emission outside of the authorized operating frequency ranges must be attenuated below the transmitter power (P) by a factor of at least $55 + 10 \log (P)$ dB.

The spectrum is scanned from 30 MHz up to a frequency including its 10th harmonic.

4.4.2 Test Procedures

1. The testing follows ANSI C63.26 Section 5.5
2. The EUT was placed on a turntable with 0.8 meter height for frequency below 1GHz and 1.5 meter height for frequency above 1GHz respectively above ground.
3. The EUT was set 3 meters from the receiving antenna mounted on the antenna tower.
4. The table was rotated 360 degrees to determine the position of the highest spurious emission.
5. The height of the receiving antenna is varied between 1m to 4m to search the maximum spurious emission for both horizontal and vertical polarizations.
6. During the measurement, the system simulator parameters were set to force the EUT transmitting at maximum output power.
7. Make the measurement with the spectrum analyzer's RBW = 1MHz, VBW = 3MHz, taking the record of maximum spurious emission.
8. A horn antenna was substituted in place of the EUT and was driven by a signal generator.
9. Tune the output power of signal generator to the same emission level with EUT maximum spurious emission.
10. $EIRP (dBm) = S.G. Power - Tx Cable Loss + Tx Antenna Gain$
11. $ERP (dBm) = EIRP - 2.15$
12. The RF fundamental frequency should be excluded against the limit line in the operating frequency band.

The limit line is derived from $43 + 10\log(P)$ dB below the transmitter power P(Watts)
 $= P(W) - [43 + 10\log(P)] (dB)$
 $= [30 + 10\log(P)] (dBm) - [43 + 10\log(P)] (dB)$
 $= -13dBm.$

13. For 5G NR n41:

The limit line is derived from $55 + 10\log(P)$ dB below the transmitter power P(Watts)The limit line is derived from $55 + 10\log(P)$ dB below the transmitter power P(Watts)



5 List of Measuring Equipment

Instrument	Manufacturer	Model No.	Serial No.	Characteristics	Calibration Date	Test Date	Due Date	Remark
EMI Test Receiver&SA	Agilent	N9038A	MY52260185	20Hz~26.5GHz	Dec. 27, 2021	Jul. 09, 2022~ Jul. 28, 2022	Dec. 26, 2022	Conducted (TH01-SZ)
Power Divider	TOJOIN	PS-2SM-04 265	60.06.020.007 7	0.4GHz~26.5GHz	Dec. 25, 2021	Jul. 09, 2022~ Jul. 28, 2022	Dec. 24, 2022	Conducted (TH01-SZ)
Thermal Chamber	Ten Billion Hongzhangroup	LP-150U	H2014081803	-40~+150°C	Jul. 14, 2021	Jul. 09, 2022~ Jul. 28, 2022	Jul. 13, 2022	Conducted (TH01-SZ)
Thermal Chamber	Ten Billion Hongzhangroup	LP-150U	H2014081803	-40~+150°C	Jul. 13, 2022		Jul. 12, 2023	Conducted (TH01-SZ)
EXA Spectrum Analyzer	Keysight	N9010B	MY57541079	10Hz-44G,MAX 30dB	Oct. 14, 2021	Jul. 13, 2022	Oct. 13, 2022	Radiation (03CH04-KS)
Loop Antenna	R&S	HFH2-Z2	100321	9kHz~30MHz	Oct. 30, 2021	Jul. 13, 2022	Oct. 29, 2022	Radiation (03CH04-KS)
Bilog Antenna	TeseQ	CBL6111D	49922	30MHz-1GHz	May 30, 2022	Jul. 13, 2022	May 29, 2023	Radiation (03CH04-KS)
Horn Antenna	Schwarzbeck	BBHA9120D	1284	1GHz~18GHz	Oct. 18, 2021	Jul. 13, 2022	Oct. 17, 2022	Radiation (03CH04-KS)
SHF-EHF Horn	Com-power	AH-840	101070	18GHz~40GHz	Jan. 05, 2022	Jul. 13, 2022	Jan. 04, 2023	Radiation (03CH04-KS)
Amplifier	SONOMA	310N	187289	9KHz-1GHz	Jan. 05, 2022	Jul. 13, 2022	Jan. 04, 2023	Radiation (03CH04-KS)
Amplifier	MITEQ	EM18G40G GA	060728	18~40GHz	Jan. 05, 2022	Jul. 13, 2022	Jan. 04, 2023	Radiation (03CH04-KS)
high gain Amplifier	MITEQ	AMF-7D-00 101800-30-1 0P	2025788	1Ghz-18Ghz	Jul. 30, 2021	Jul. 13, 2022	Jul. 29, 2022	Radiation (03CH04-KS)
Amplifier	Keysight	83017A	MY57280106	500MHz~26.5GHz	Oct. 13, 2021	Jul. 13, 2022	Oct. 12, 2022	Radiation (03CH04-KS)
AC Power Source	Chroma	61601	F104090004	N/A	NCR	Jul. 13, 2022	NCR	Radiation (03CH04-KS)
Turn Table	ChamPro	EM 1000-T	060762-T	0~360 degree	NCR	Jul. 13, 2022	NCR	Radiation (03CH04-KS)
Antenna Mast	ChamPro	EM 1000-A	060762-A	1 m~4 m	NCR	Jul. 13, 2022	NCR	Radiation (03CH04-KS)

NCR: No Calibration Required



6 Uncertainty of Evaluation

The measurement uncertainties shown below were calculated in accordance with the requirements of ANSI 63.26-2015. All the measurement uncertainty value were shown with a coverage K=2 to indicate 95% level of confidence. The measurement data show herein meets or exceeds the CISPR measurement uncertainty values specified in CISPR 16-4-2 and can be compared directly to specified limit to determine compliance.

Uncertainty of Conducted Measurement

Test Item	Uncertainty
Conducted Power	1.34 dB
Conducted Emissions	1.34 dB
Occupied Channel Bandwidth	0.012MHz
Conducted Power Spectral Density	1.32 dB
Frequency tolerance	1.30 ppm

Uncertainty of Radiated Emission Measurement (30 MHz ~ 1000 MHz)

Measuring Uncertainty for a Level of Confidence of 95% (U = 2Uc(y))	3.3dB
---	-------

Uncertainty of Radiated Emission Measurement (1 GHz ~ 18 GHz)

Measuring Uncertainty for a Level of Confidence of 95% (U = 2Uc(y))	2.8dB
---	-------

Uncertainty of Radiated Emission Measurement (18 GHz ~ 40 GHz)

Measuring Uncertainty for a Level of Confidence of 95% (U = 2Uc(y))	2.8dB
---	-------

----- THE END -----



Appendix A. Test Results of Conducted Test

Test Engineer :	Jung Guo	Temperature :	22~23°C
		Relative Humidity :	40~42%

FR1 N25(ANT2_Max Conducted Power)

Transmitter Conducted Output Power And EIRP, (G_T - L_C)= -1.54dBi

NR Band	SCS (kHz)	Bandwidth (MHz)	Arfcn	Freq (MHz)	Modulation	RB	Conducted Power(dBm)	EIRP (dBm)	EIRP (W)
25	15	5	386500	1852.5	DFT-s-OFDM QPSK	1@1	23.14	21.6	0.1445
25	15	5	386500	1852.5	DFT-s-OFDM 16 QAM	1@1	22.19	20.65	0.1161
25	15	5	392500	1882.5	DFT-s-OFDM QPSK	1@1	23.42	21.88	0.1542
25	15	5	392500	1882.5	DFT-s-OFDM 16 QAM	1@1	22.74	21.2	0.1318
25	15	5	398500	1912.5	DFT-s-OFDM QPSK	1@1	22.29	20.75	0.1189
25	15	5	398500	1912.5	DFT-s-OFDM 16 QAM	1@1	21.3	19.76	0.0946
25	15	10	387000	1855	DFT-s-OFDM QPSK	1@1	23.12	21.58	0.1439
25	15	10	387000	1855	DFT-s-OFDM 16 QAM	1@1	22.16	20.62	0.1153
25	15	10	392500	1882.5	DFT-s-OFDM QPSK	1@1	23.48	21.94	0.1563
25	15	10	392500	1882.5	DFT-s-OFDM 16 QAM	1@1	22.55	21.01	0.1262
25	15	10	398000	1910	DFT-s-OFDM QPSK	1@1	22.29	20.75	0.1189
25	15	10	398000	1910	DFT-s-OFDM 16 QAM	1@1	21.34	19.8	0.0955
25	15	15	387500	1857.5	DFT-s-OFDM QPSK	1@1	23.02	21.48	0.1406
25	15	15	387500	1857.5	DFT-s-OFDM 16 QAM	1@1	22.12	20.58	0.1143
25	15	15	392500	1882.5	DFT-s-OFDM QPSK	1@1	23.77	22.23	0.1671
25	15	15	392500	1882.5	DFT-s-OFDM 16 QAM	1@1	22.74	21.2	0.1318
25	15	15	397500	1907.5	DFT-s-OFDM QPSK	1@1	22.62	21.08	0.1282
25	15	15	397500	1907.5	DFT-s-OFDM 16 QAM	1@1	21.76	20.22	0.1052
25	15	20	388000	1860	DFT-s-OFDM QPSK	1@1	23.03	21.49	0.1409
25	15	20	388000	1860	DFT-s-OFDM 16 QAM	1@1	22.15	20.61	0.1151

25	15	20	392500	1882.5	DFT-s-OFDM QPSK	1@1	23.88	22.34	0.1714
25	15	20	392500	1882.5	DFT-s-OFDM 16 QAM	1@1	22.78	21.24	0.1330
25	15	20	397000	1905	DFT-s-OFDM QPSK	1@1	22.98	21.44	0.1393
25	15	20	397000	1905	DFT-s-OFDM 16 QAM	1@1	21.9	20.36	0.1086
25	15	25	388500	1862.5	DFT-s-OFDM QPSK	1@1	23.1	21.56	0.1432
25	15	25	388500	1862.5	DFT-s-OFDM 16 QAM	1@1	22.23	20.69	0.1172
25	15	25	392500	1882.5	DFT-s-OFDM QPSK	1@1	23.53	21.99	0.1581
25	15	25	392500	1882.5	DFT-s-OFDM 16 QAM	1@1	22.7	21.16	0.1306
25	15	25	396500	1902.5	DFT-s-OFDM QPSK	1@1	23.14	21.6	0.1445
25	15	25	396500	1902.5	DFT-s-OFDM 16 QAM	1@1	22.24	20.7	0.1175
25	15	30	389000	1865	DFT-s-OFDM QPSK	1@1	23.18	21.64	0.1459
25	15	30	389000	1865	DFT-s-OFDM 16 QAM	1@1	22.17	20.63	0.1156
25	15	30	392500	1882.5	DFT-s-OFDM QPSK	1@1	23.67	22.13	0.1633
25	15	30	392500	1882.5	DFT-s-OFDM 16 QAM	1@1	22.64	21.1	0.1288
25	15	30	396000	1900	DFT-s-OFDM QPSK	1@1	23.13	21.59	0.1442
25	15	30	396000	1900	DFT-s-OFDM 16 QAM	1@1	22.38	20.84	0.1213
25	15	40	390000	1870	DFT-s-OFDM PI/2 BPSK	108@54	23.97	22.43	0.1750
25	15	40	390000	1870	DFT-s-OFDM PI/2 BPSK	1@1	22.71	21.17	0.1309
25	15	40	390000	1870	DFT-s-OFDM PI/2 BPSK	1@214	22.95	21.41	0.1384
25	15	40	390000	1870	DFT-s-OFDM QPSK	108@54	23.6	22.06	0.1607
25	15	40	390000	1870	DFT-s-OFDM QPSK	1@1	23.02	21.48	0.1406
25	15	40	390000	1870	DFT-s-OFDM QPSK	1@214	23.12	21.58	0.1439
25	15	40	390000	1870	DFT-s-OFDM 16 QAM	108@54	22.59	21.05	0.1274
25	15	40	390000	1870	DFT-s-OFDM 16 QAM	1@1	22.05	20.51	0.1125

25	15	40	390000	1870	DFT-s-OFDM 16 QAM	1@214	22.39	20.85	0.1216
25	15	40	390000	1870	DFT-s-OFDM 64 QAM	108@54	21.1	19.56	0.0904
25	15	40	390000	1870	DFT-s-OFDM 64 QAM	1@1	20.35	18.81	0.0760
25	15	40	390000	1870	DFT-s-OFDM 64 QAM	1@214	20.71	19.17	0.0826
25	15	40	390000	1870	DFT-s-OFDM 256 QAM	108@54	19.01	17.47	0.0558
25	15	40	390000	1870	DFT-s-OFDM 256 QAM	1@1	18.06	16.52	0.0449
25	15	40	390000	1870	DFT-s-OFDM 256 QAM	1@214	18.38	16.84	0.0483
25	15	40	390000	1870	CP-OFDM QPSK	108@54	21.94	20.4	0.1096
25	15	40	390000	1870	CP-OFDM QPSK	1@1	21.42	19.88	0.0973
25	15	40	390000	1870	CP-OFDM QPSK	1@214	21.58	20.04	0.1009
25	15	40	392500	1882.5	DFT-s-OFDM PI/2 BPSK	108@54	23.33	21.79	0.1510
25	15	40	392500	1882.5	DFT-s-OFDM PI/2 BPSK	1@1	23.27	21.73	0.1489
25	15	40	392500	1882.5	DFT-s-OFDM PI/2 BPSK	1@214	22.41	20.87	0.1222
25	15	40	392500	1882.5	DFT-s-OFDM QPSK	108@54	23.36	21.82	0.1521
25	15	40	392500	1882.5	DFT-s-OFDM QPSK	1@1	23.49	21.95	0.1567
25	15	40	392500	1882.5	DFT-s-OFDM QPSK	1@214	22.46	20.92	0.1236
25	15	40	392500	1882.5	DFT-s-OFDM 16 QAM	108@54	22.41	20.87	0.1222
25	15	40	392500	1882.5	DFT-s-OFDM 16 QAM	1@1	22.58	21.04	0.1271
25	15	40	392500	1882.5	DFT-s-OFDM 16 QAM	1@214	21.65	20.11	0.1026
25	15	40	392500	1882.5	DFT-s-OFDM 64 QAM	108@54	20.9	19.36	0.0863
25	15	40	392500	1882.5	DFT-s-OFDM 64 QAM	1@1	20.97	19.43	0.0877
25	15	40	392500	1882.5	DFT-s-OFDM 64 QAM	1@214	20.13	18.59	0.0723
25	15	40	392500	1882.5	DFT-s-OFDM 256 QAM	108@54	18.65	17.11	0.0514
25	15	40	392500	1882.5	DFT-s-OFDM 256 QAM	1@1	18.68	17.14	0.0518
25	15	40	392500	1882.5	DFT-s-OFDM 256 QAM	1@214	17.88	16.34	0.0431

25	15	40	392500	1882.5	CP-OFDM QPSK	108@54	21.84	20.3	0.1072
25	15	40	392500	1882.5	CP-OFDM QPSK	1@1	21.88	20.34	0.1081
25	15	40	392500	1882.5	CP-OFDM QPSK	1@214	21.07	19.53	0.0897
25	15	40	395000	1895	DFT-s- OFDM PI/2 BPSK	108@54	22.86	21.32	0.1355
25	15	40	395000	1895	DFT-s- OFDM PI/2 BPSK	1@1	23.33	21.79	0.1510
25	15	40	395000	1895	DFT-s- OFDM PI/2 BPSK	1@214	21.9	20.36	0.1086
25	15	40	395000	1895	DFT-s- OFDM QPSK	108@54	22.74	21.2	0.1318
25	15	40	395000	1895	DFT-s- OFDM QPSK	1@1	23.45	21.91	0.1552
25	15	40	395000	1895	DFT-s- OFDM QPSK	1@214	22.12	20.58	0.1143
25	15	40	395000	1895	DFT-s- OFDM 16 QAM	108@54	21.81	20.27	0.1064
25	15	40	395000	1895	DFT-s- OFDM 16 QAM	1@1	22.76	21.22	0.1324
25	15	40	395000	1895	DFT-s- OFDM 16 QAM	1@214	21.42	19.88	0.0973
25	15	40	395000	1895	DFT-s- OFDM 64 QAM	108@54	20.26	18.72	0.0745
25	15	40	395000	1895	DFT-s- OFDM 64 QAM	1@1	21.13	19.59	0.0910
25	15	40	395000	1895	DFT-s- OFDM 64 QAM	1@214	19.82	18.28	0.0673
25	15	40	395000	1895	DFT-s- OFDM 256 QAM	108@54	18.71	17.17	0.0521
25	15	40	395000	1895	DFT-s- OFDM 256 QAM	1@1	18.82	17.28	0.0535
25	15	40	395000	1895	DFT-s- OFDM 256 QAM	1@214	17.44	15.9	0.0389
25	15	40	395000	1895	CP-OFDM QPSK	108@54	21.4	19.86	0.0968
25	15	40	395000	1895	CP-OFDM QPSK	1@1	21.93	20.39	0.1094
25	15	40	395000	1895	CP-OFDM QPSK	1@214	20.56	19.02	0.0798

Frequency Stability

NR Band	SCS (kHz)	Bandwidth (MHz)	Arfcn	Freq (MHz)	Modulation	RB	Deviation (ppm)	Verdict	Environment
25	15	20	392500	1882.5	DFT-s-OFDM QPSK	100@0	0.0043	PASS	NV
25	15	20	392500	1882.5	DFT-s-OFDM QPSK	100@0	0.0051	PASS	LV
25	15	20	392500	1882.5	DFT-s-OFDM QPSK	100@0	0.0054	PASS	HV
25	15	20	392500	1882.5	DFT-s-OFDM QPSK	100@0	0.0025	PASS	-30°C
25	15	20	392500	1882.5	DFT-s-OFDM QPSK	100@0	0.0045	PASS	-20°C
25	15	20	392500	1882.5	DFT-s-OFDM QPSK	100@0	0.0025	PASS	-10°C
25	15	20	392500	1882.5	DFT-s-OFDM QPSK	100@0	0.0031	PASS	0°C
25	15	20	392500	1882.5	DFT-s-OFDM QPSK	100@0	0.0061	PASS	10°C
25	15	20	392500	1882.5	DFT-s-OFDM QPSK	100@0	0.0043	PASS	20°C
25	15	20	392500	1882.5	DFT-s-OFDM QPSK	100@0	0.0065	PASS	30°C
25	15	20	392500	1882.5	DFT-s-OFDM QPSK	100@0	0.0049	PASS	40°C
25	15	20	392500	1882.5	DFT-s-OFDM QPSK	100@0	0.0048	PASS	50°C

Peak to Average Ratio

NR Band	SCS (kHz)	Bandwidth (MHz)	Arfcn	Freq (MHz)	Modulation	RB	Result (dB)	Limit (dB)	Verdict
25	15	20	388000	1860.0	DFT-s-OFDM PI/2 BPSK	100@0	3.5	13	PASS
25	15	20	388000	1860.0	DFT-s-OFDM PI/2 BPSK	1@0	2.94	13	PASS
25	15	20	388000	1860.0	DFT-s-OFDM QPSK	100@0	4.96	13	PASS
25	15	20	388000	1860.0	DFT-s-OFDM QPSK	1@0	3.96	13	PASS
25	15	20	392500	1882.5	DFT-s-OFDM PI/2 BPSK	100@0	3.86	13	PASS
25	15	20	392500	1882.5	DFT-s-OFDM PI/2 BPSK	1@0	3.44	13	PASS
25	15	20	392500	1882.5	DFT-s-OFDM QPSK	100@0	4.76	13	PASS
25	15	20	392500	1882.5	DFT-s-OFDM QPSK	1@0	4.9	13	PASS
25	15	20	397000	1905.0	DFT-s-OFDM PI/2 BPSK	100@0	3.8	13	PASS
25	15	20	397000	1905.0	DFT-s-OFDM PI/2 BPSK	1@0	4.17	13	PASS
25	15	20	397000	1905.0	DFT-s-OFDM QPSK	100@0	5.06	13	PASS
25	15	20	397000	1905.0	DFT-s-OFDM QPSK	1@0	5.09	13	PASS

N25(20M)_DFT-s-OFDM_PI_2-BPSK_Outer_Full_Low_CH



N25(20M)_DFT-s-OFDM_PI_2-BPSK_Edge_1RB_Left_Low_CH



N25(20M)_DFT-s-OFDM_QPSK_Outer_Full_Low_CH



N25(20M)_DFT-s-OFDM_QPSK_Edge_1RB_Left_Low_CH



N25(20M)_DFT-s-OFDM_PI_2-BPSK_Outer_Full_Mid_CH



N25(20M)_DFT-s-OFDM_PI_2-BPSK_Edge_1RB_Left_Mid_CH



N25(20M)_DFT-s-OFDM_QPSK_Outer_Full_Mid_CH



N25(20M)_DFT-s-OFDM_QPSK_Edge_1RB_Left_Mid_CH



N25(20M)_DFT-s-OFDM_PI_2-BPSK_Outer_Full_High_CH



N25(20M)_DFT-s-OFDM_PI_2-BPSK_Edge_1RB_Left_High_CH

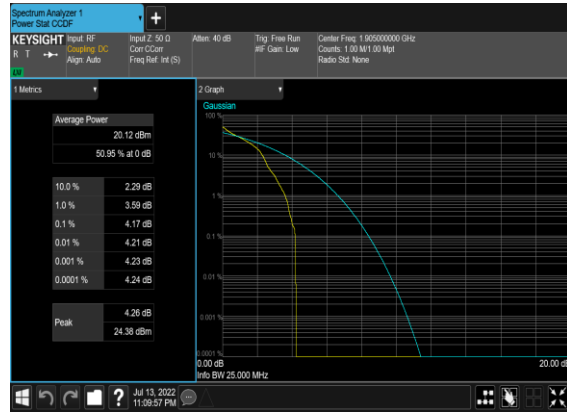

N25(20M)_DFT-s-OFDM_QPSK_Outer_Full_High_CH



N25(20M)_DFT-s-OFDM_QPSK_Edge_1RB_Left_High_CH

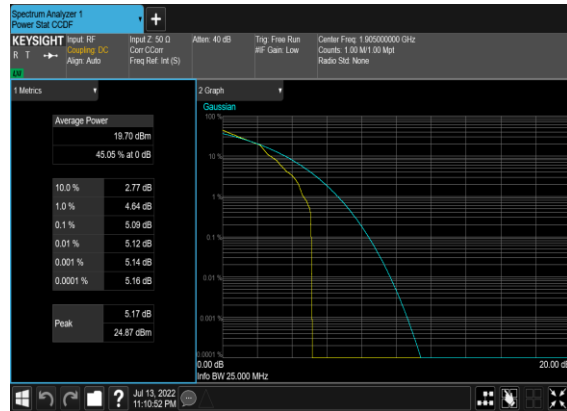

Occupied Bandwidth

NR Band	SCS (kHz)	Bandwidth (MHz)	Arfcn	Freq (MHz)	Modulation	RB	OBW (MHz)	26dB OBW (MHz)
25	15	5	392500	1882.5	DFT-s-OFDM PI/2 BPSK	25@0	4.4818	5.046
25	15	5	392500	1882.5	DFT-s-OFDM QPSK	25@0	4.4746	4.962
25	15	5	392500	1882.5	CP-OFDM QPSK	25@0	4.4799	5.12
25	15	5	392500	1882.5	CP-OFDM 16 QAM	25@0	4.4912	5.207
25	15	5	392500	1882.5	CP-OFDM 64 QAM	25@0	4.4719	5.212
25	15	5	392500	1882.5	CP-OFDM 256 QAM	25@0	4.4809	5.036
25	15	10	392500	1882.5	DFT-s-OFDM PI/2 BPSK	50@0	8.8936	9.593
25	15	10	392500	1882.5	DFT-s-OFDM QPSK	50@0	8.9188	9.681
25	15	10	392500	1882.5	CP-OFDM QPSK	52@0	9.2969	10.2
25	15	10	392500	1882.5	CP-OFDM 16 QAM	52@0	9.3055	10.08
25	15	10	392500	1882.5	CP-OFDM 64 QAM	52@0	9.273	9.994
25	15	10	392500	1882.5	CP-OFDM 256 QAM	52@0	9.2843	10.02
25	15	15	392500	1882.5	DFT-s-OFDM PI/2 BPSK	75@0	13.385	14.29
25	15	15	392500	1882.5	DFT-s-OFDM QPSK	75@0	13.398	14.35
25	15	15	392500	1882.5	CP-OFDM QPSK	79@0	14.092	14.93
25	15	15	392500	1882.5	CP-OFDM 16 QAM	79@0	14.1	15.08
25	15	15	392500	1882.5	CP-OFDM 64 QAM	79@0	14.105	14.96
25	15	15	392500	1882.5	CP-OFDM 256 QAM	79@0	14.081	14.92
25	15	20	392500	1882.5	DFT-s-OFDM PI/2 BPSK	100@0	17.9	18.76
25	15	20	392500	1882.5	DFT-s-OFDM QPSK	100@0	17.851	18.89
25	15	20	392500	1882.5	CP-OFDM QPSK	106@0	18.892	20.01
25	15	20	392500	1882.5	CP-OFDM 16 QAM	106@0	18.92	19.95

25	15	20	392500	1882.5	CP-OFDM 64 QAM	106@0	18.902	20.09
25	15	20	392500	1882.5	CP-OFDM 256 QAM	106@0	18.924	19.91
25	15	25	392500	1882.5	DFT-s- OFDM PI/2 BPSK	128@0	22.807	23.83
25	15	25	392500	1882.5	DFT-s- OFDM QPSK	128@0	22.813	23.81
25	15	25	392500	1882.5	CP-OFDM QPSK	133@0	23.676	24.8
25	15	25	392500	1882.5	CP-OFDM 16 QAM	133@0	23.703	24.82
25	15	25	392500	1882.5	CP-OFDM 64 QAM	133@0	23.756	24.73
25	15	25	392500	1882.5	CP-OFDM 256 QAM	133@0	23.705	24.66
25	15	30	392500	1882.5	DFT-s- OFDM PI/2 BPSK	160@0	28.488	29.7
25	15	30	392500	1882.5	DFT-s- OFDM QPSK	160@0	28.497	29.72
25	15	30	392500	1882.5	CP-OFDM QPSK	160@0	28.491	29.64
25	15	30	392500	1882.5	CP-OFDM 16 QAM	160@0	28.512	29.68
25	15	30	392500	1882.5	CP-OFDM 64 QAM	160@0	28.489	29.63
25	15	30	392500	1882.5	CP-OFDM 256 QAM	160@0	28.49	29.68
25	15	40	392500	1882.5	DFT-s- OFDM PI/2 BPSK	216@0	38.544	39.93
25	15	40	392500	1882.5	DFT-s- OFDM QPSK	216@0	38.431	40.09
25	15	40	392500	1882.5	CP-OFDM QPSK	216@0	38.529	40.09
25	15	40	392500	1882.5	CP-OFDM 16 QAM	216@0	38.562	40.09
25	15	40	392500	1882.5	CP-OFDM 64 QAM	216@0	38.572	40.0
25	15	40	392500	1882.5	CP-OFDM 256 QAM	216@0	38.487	39.98

N25(5M)_DFT-s-OFDM_PI_2- BPSK_Outer_Full_Mid_CH

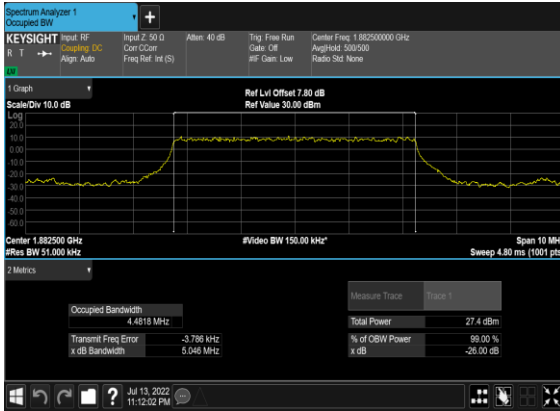

N25(5M)_DFT-s- OFDM_QPSK_Outer_Full_Mid_CH

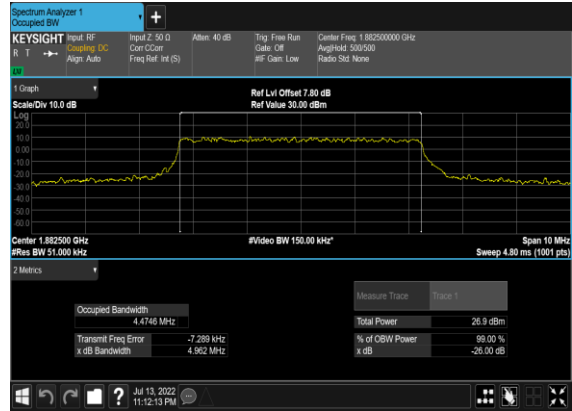

N25(5M)_CP- OFDM_QPSK_Outer_Full_Mid_CH



N25(5M)_CP-OFDM_16 QAM_Outer_Full_Mid_CH



N25(5M)_CP-OFDM_64 QAM_Outer_Full_Mid_CH

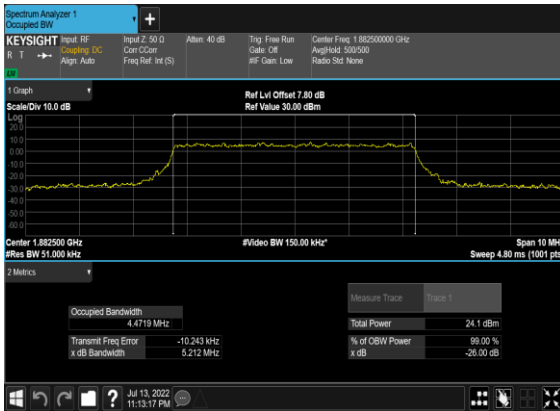

N25(5M)_CP-OFDM_256 QAM_Outer_Full_Mid_CH

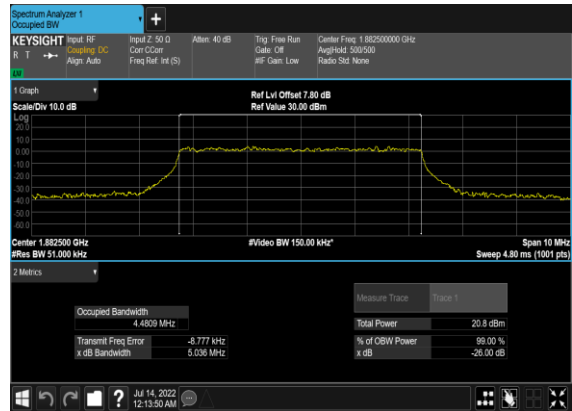

N25(10M)_DFT-s-OFDM_PI_2- BPSK_Outer_Full_Mid_CH

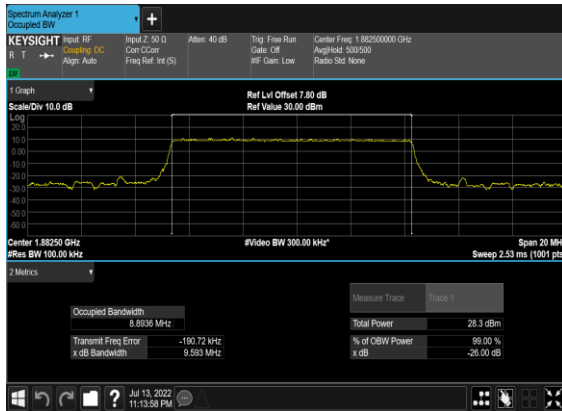

N25(10M)_DFT-s- OFDM_QPSK_Outer_Full_Mid_CH

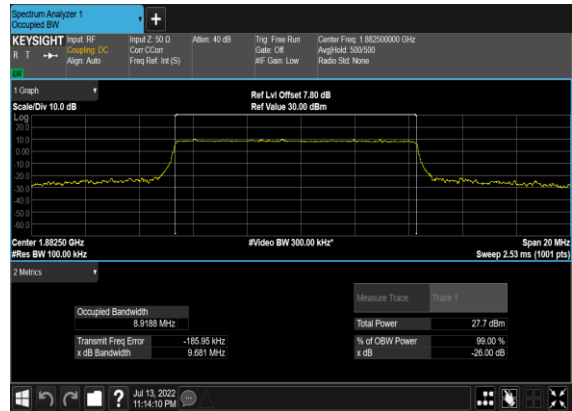

N25(10M)_CP- OFDM_QPSK_Outer_Full_Mid_CH



N25(10M)_CP-OFDM_16 QAM_Outer_Full_Mid_CH



N25(10M)_CP-OFDM_64 QAM_Outer_Full_Mid_CH

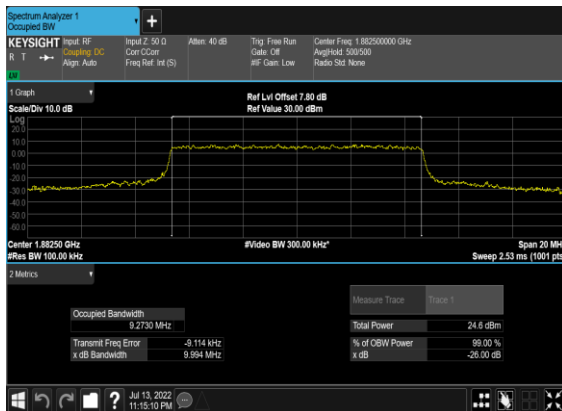

N25(10M)_CP-OFDM_256 QAM_Outer_Full_Mid_CH

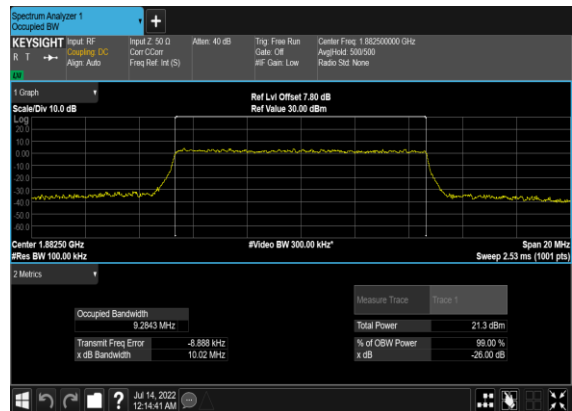

N25(15M)_DFT-s-OFDM_PI_2- BPSK_Outer_Full_Mid_CH

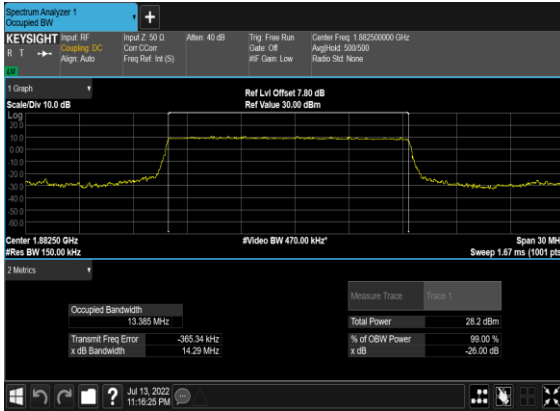

N25(15M)_DFT-s- OFDM_QPSK_Outer_Full_Mid_CH

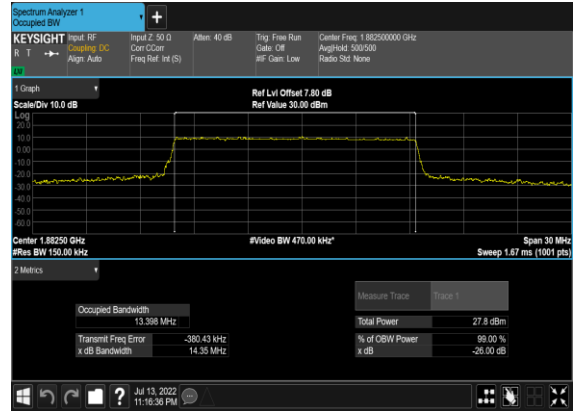

N25(15M)_CP- OFDM_QPSK_Outer_Full_Mid_CH

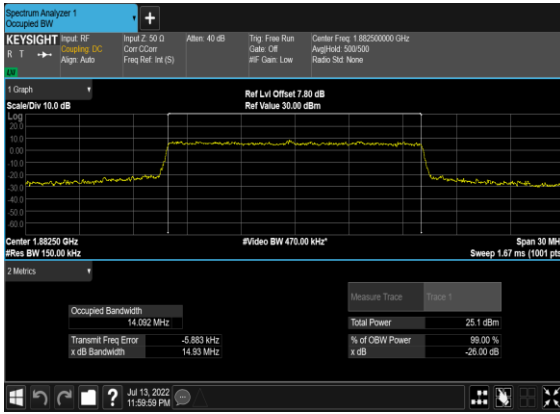

N25(15M)_CP-OFDM_16 QAM_Outer_Full_Mid_CH



N25(15M)_CP-OFDM_64 QAM_Outer_Full_Mid_CH

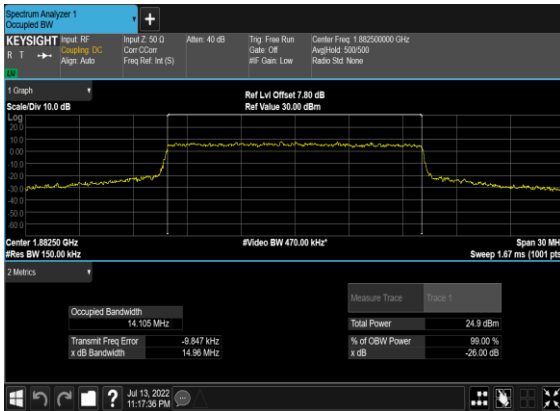

N25(15M)_CP-OFDM_256 QAM_Outer_Full_Mid_CH

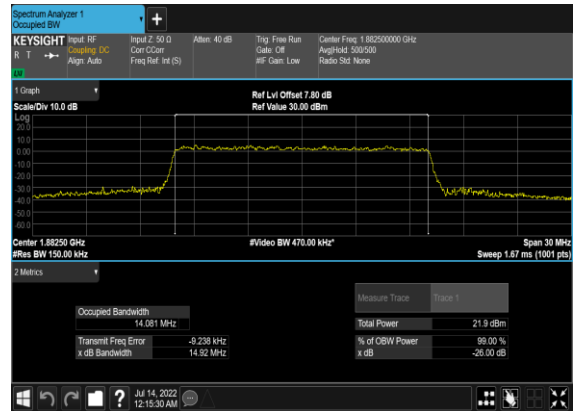

N25(20M)_DFT-s-OFDM_PI_2- BPSK_Outer_Full_Mid_CH

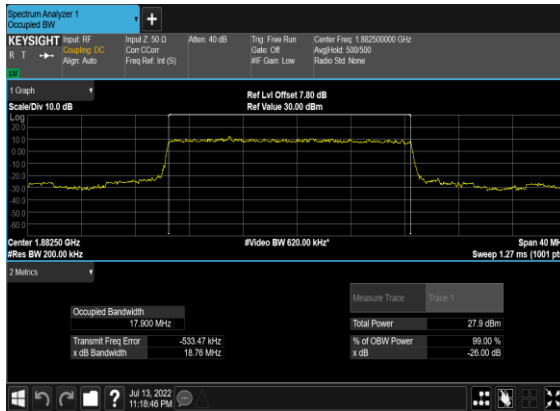

N25(20M)_DFT-s- OFDM_QPSK_Outer_Full_Mid_CH

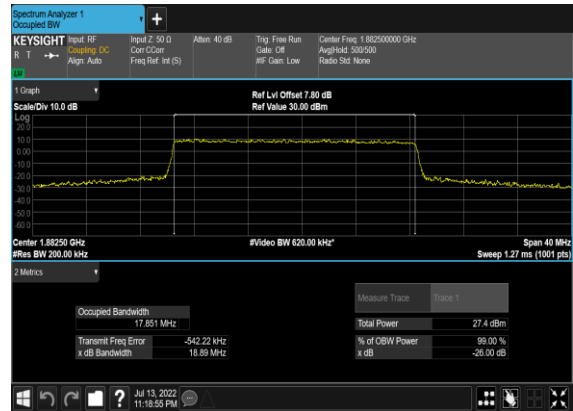

N25(20M)_CP- OFDM_QPSK_Outer_Full_Mid_CH

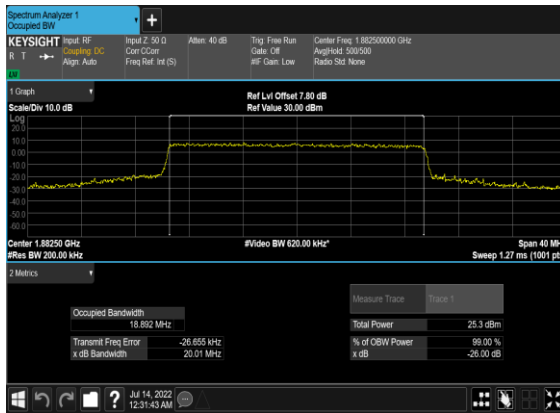

N25(20M)_CP-OFDM_16 QAM_Outer_Full_Mid_CH

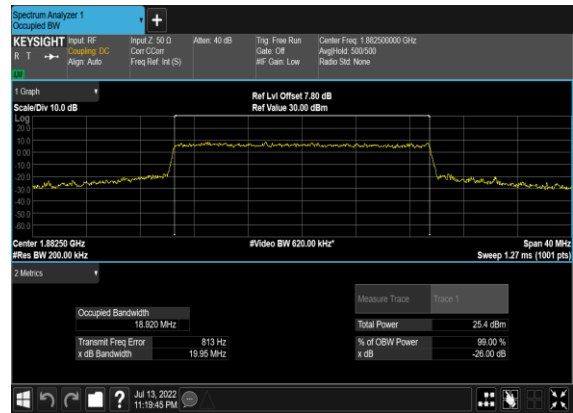

N25(20M)_CP-OFDM_64 QAM_Outer_Full_Mid_CH

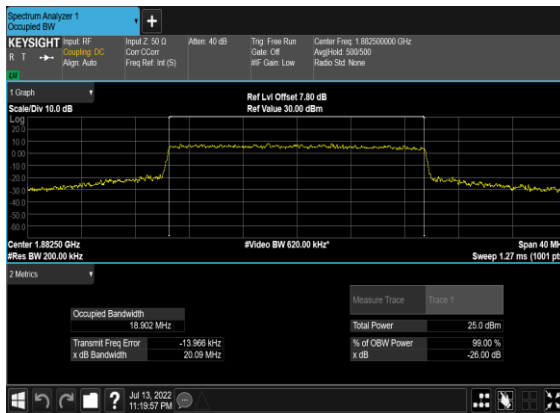

N25(20M)_CP-OFDM_256 QAM_Outer_Full_Mid_CH

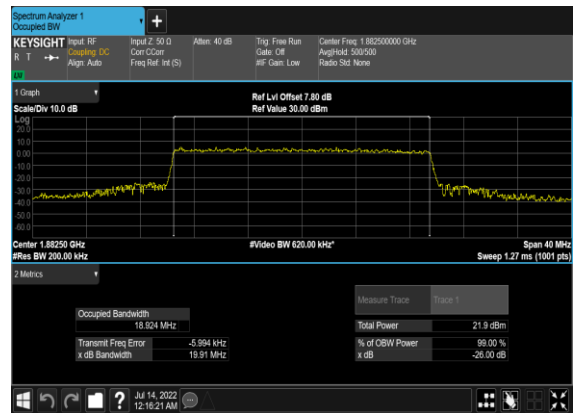

N25(25M)_DFT-s-OFDM_PI_2-BPSK_Outer_Full_Mid_CH

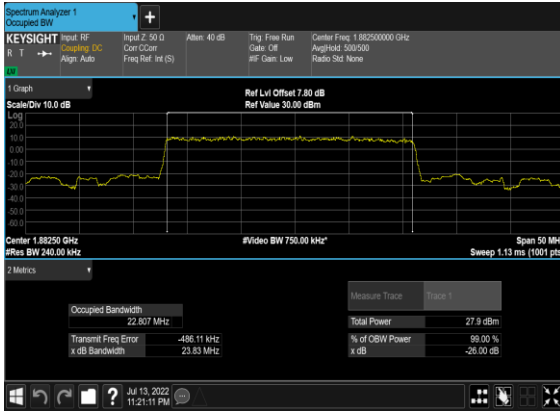

N25(25M)_DFT-s-OFDM_QPSK_Outer_Full_Mid_CH

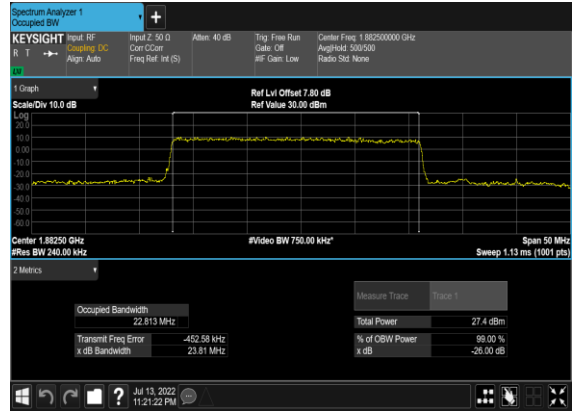

N25(25M)_CP-OFDM_QPSK_Outer_Full_Mid_CH

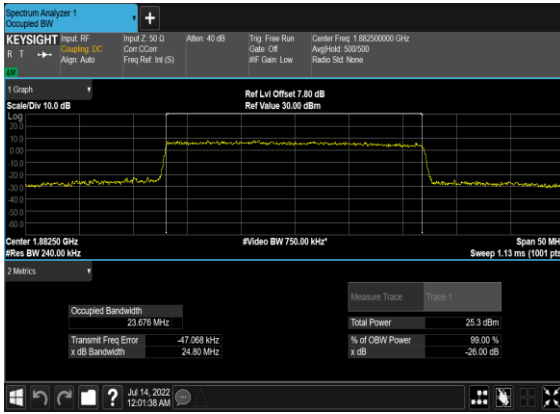

N25(25M)_CP-OFDM_16QAM_Outer_Full_Mid_CH

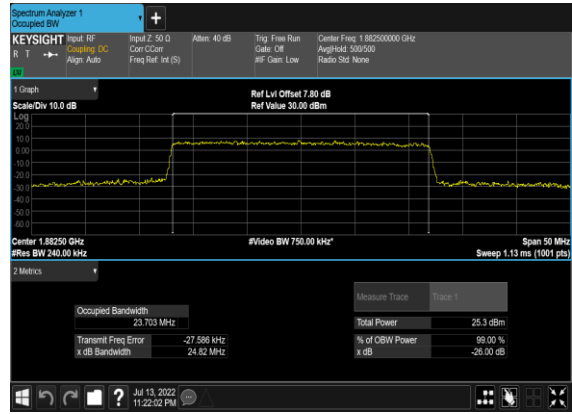

N25(25M)_CP-OFDM_64QAM_Outer_Full_Mid_CH

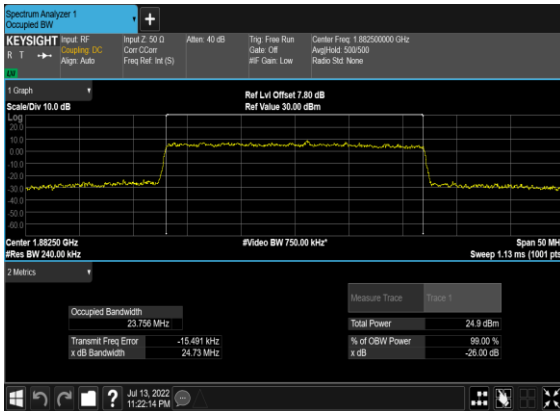

N25(25M)_CP-OFDM_256QAM_Outer_Full_Mid_CH

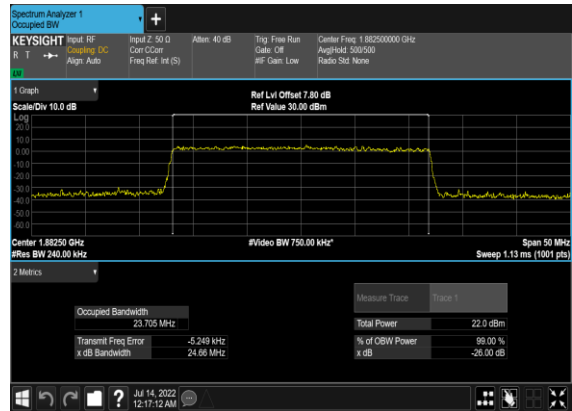

N25(30M)_DFT-s-OFDM_PI_2-BPSK_Outer_Full_Mid_CH

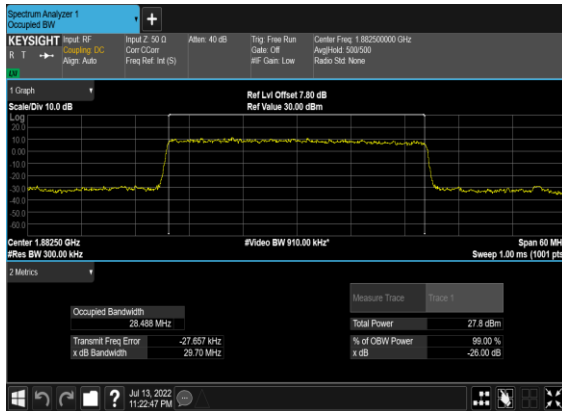

N25(30M)_DFT-s-OFDM_QPSK_Outer_Full_Mid_CH

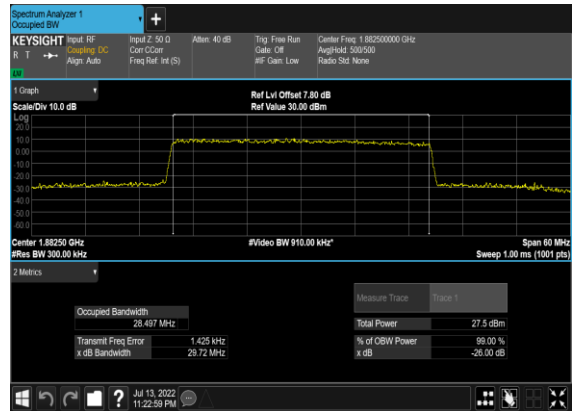

N25(30M)_CP-OFDM_QPSK_Outer_Full_Mid_CH



N25(30M)_CP-OFDM_16QAM_Outer_Full_Mid_CH

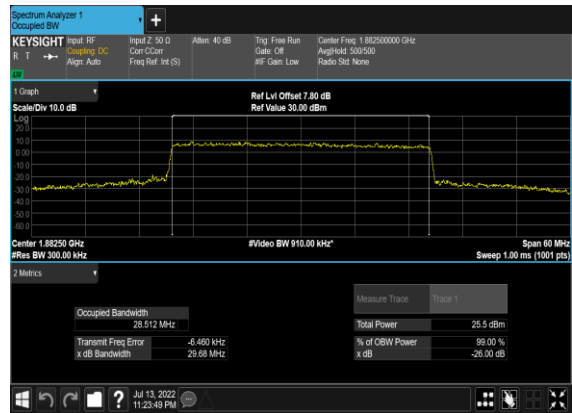

N25(30M)_CP-OFDM_64QAM_Outer_Full_Mid_CH



N25(30M)_CP-OFDM_256QAM_Outer_Full_Mid_CH

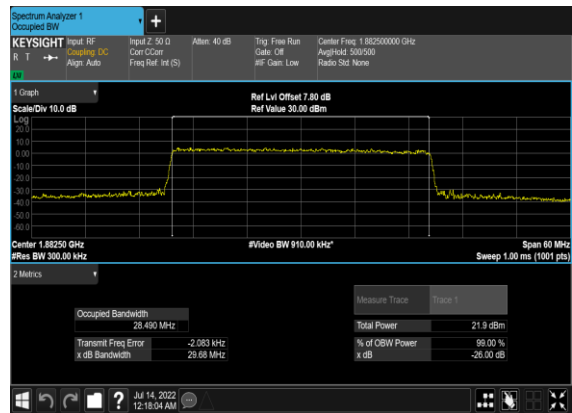

N25(40M)_DFT-s-OFDM_PI_2- BPSK_Outer_Full_Mid_CH

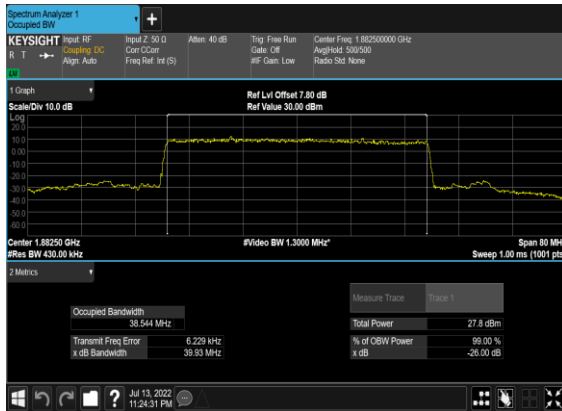

N25(40M)_DFT-s- OFDM_QPSK_Outer_Full_Mid_CH

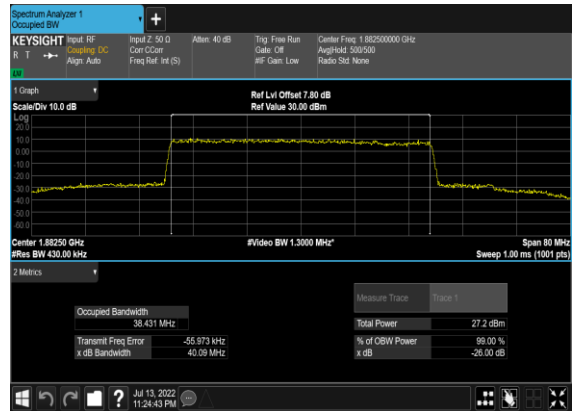

N25(40M)_CP- OFDM_QPSK_Outer_Full_Mid_CH



N25(40M)_CP-OFDM_16 QAM_Outer_Full_Mid_CH

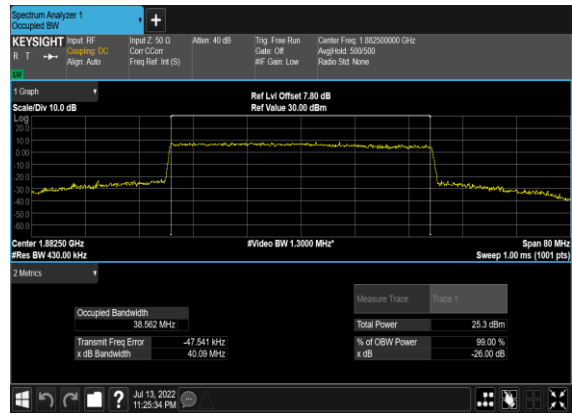

N25(40M)_CP-OFDM_64 QAM_Outer_Full_Mid_CH

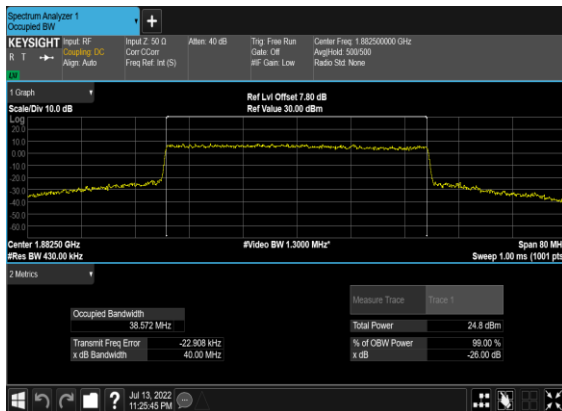

N25(40M)_CP-OFDM_256 QAM_Outer_Full_Mid_CH

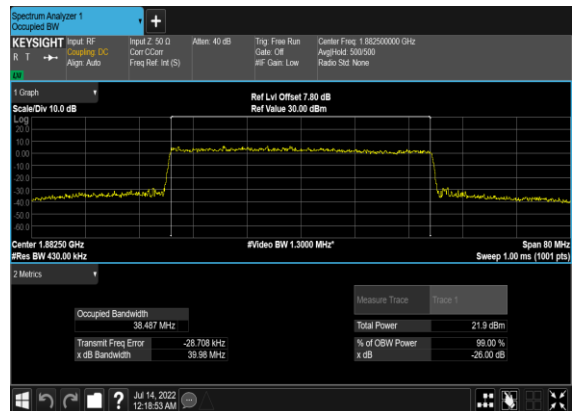

Conducted Spurious Emissions

NR Band	SCS (kHz)	Bandwidth (MHz)	Arfcn	Freq (MHz)	Modulation	RB	Result	Verdict
25	15	5	386500	1852.5	DFT-s-OFDM BPSK	1@0	see graph	---
25	15	5	386500	1852.5	DFT-s-OFDM BPSK	1@0	see graph	PASS
25	15	5	386500	1852.5	DFT-s-OFDM QPSK	1@0	see graph	---
25	15	5	386500	1852.5	DFT-s-OFDM QPSK	1@0	see graph	PASS
25	15	5	392500	1882.5	DFT-s-OFDM BPSK	1@0	see graph	---
25	15	5	392500	1882.5	DFT-s-OFDM BPSK	1@0	see graph	PASS
25	15	5	392500	1882.5	DFT-s-OFDM QPSK	1@0	see graph	---
25	15	5	392500	1882.5	DFT-s-OFDM QPSK	1@0	see graph	PASS
25	15	5	398500	1912.5	DFT-s-OFDM BPSK	1@0	see graph	---
25	15	5	398500	1912.5	DFT-s-OFDM BPSK	1@0	see graph	PASS
25	15	5	398500	1912.5	DFT-s-OFDM QPSK	1@0	see graph	---
25	15	5	398500	1912.5	DFT-s-OFDM QPSK	1@0	see graph	PASS
25	15	20	388000	1860.0	DFT-s-OFDM BPSK	1@0	see graph	---
25	15	20	388000	1860.0	DFT-s-OFDM BPSK	1@0	see graph	PASS
25	15	20	388000	1860.0	DFT-s-OFDM QPSK	1@0	see graph	---
25	15	20	388000	1860.0	DFT-s-OFDM QPSK	1@0	see graph	PASS
25	15	20	392500	1882.5	DFT-s-OFDM BPSK	1@0	see graph	---
25	15	20	392500	1882.5	DFT-s-OFDM BPSK	1@0	see graph	PASS
25	15	20	392500	1882.5	DFT-s-OFDM QPSK	1@0	see graph	---
25	15	20	392500	1882.5	DFT-s-OFDM QPSK	1@0	see graph	PASS
25	15	20	397000	1905.0	DFT-s-OFDM BPSK	1@0	see graph	---
25	15	20	397000	1905.0	DFT-s-OFDM BPSK	1@0	see graph	PASS

25	15	20	397000	1905.0	DFT-s-OFDM QPSK	1@0	see graph	---
25	15	20	397000	1905.0	DFT-s-OFDM QPSK	1@0	see graph	PASS
25	15	40	390000	1870.0	DFT-s-OFDM BPSK	1@0	see graph	---
25	15	40	390000	1870.0	DFT-s-OFDM BPSK	1@0	see graph	PASS
25	15	40	390000	1870.0	DFT-s-OFDM QPSK	1@0	see graph	---
25	15	40	390000	1870.0	DFT-s-OFDM QPSK	1@0	see graph	PASS
25	15	40	392500	1882.5	DFT-s-OFDM BPSK	1@0	see graph	---
25	15	40	392500	1882.5	DFT-s-OFDM BPSK	1@0	see graph	PASS
25	15	40	392500	1882.5	DFT-s-OFDM QPSK	1@0	see graph	---
25	15	40	392500	1882.5	DFT-s-OFDM QPSK	1@0	see graph	PASS
25	15	40	395000	1895.0	DFT-s-OFDM BPSK	1@0	see graph	---
25	15	40	395000	1895.0	DFT-s-OFDM BPSK	1@0	see graph	PASS
25	15	40	395000	1895.0	DFT-s-OFDM QPSK	1@0	see graph	---
25	15	40	395000	1895.0	DFT-s-OFDM QPSK	1@0	see graph	PASS

N25(5M)_DFT-s-OFDM_BPSK_Edge_1RB_Left_Low_CH

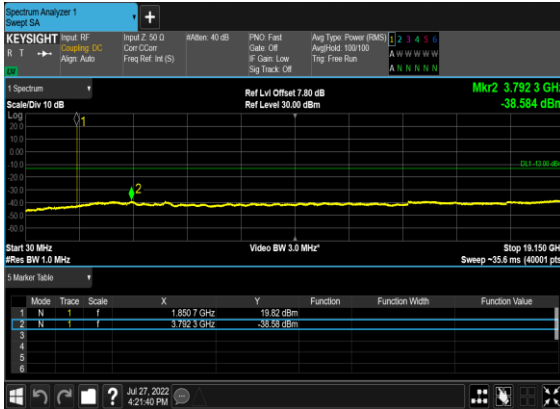

N25(5M)_DFT-s-OFDM_QPSK_Edge_1RB_Left_Low_CH

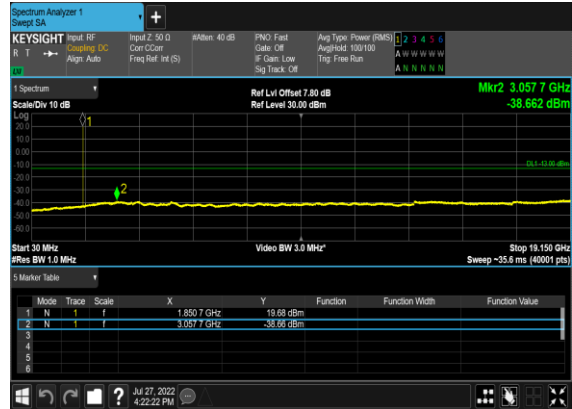

N25(5M)_DFT-s-OFDM_BPSK_Edge_1RB_Left_Mid_CH

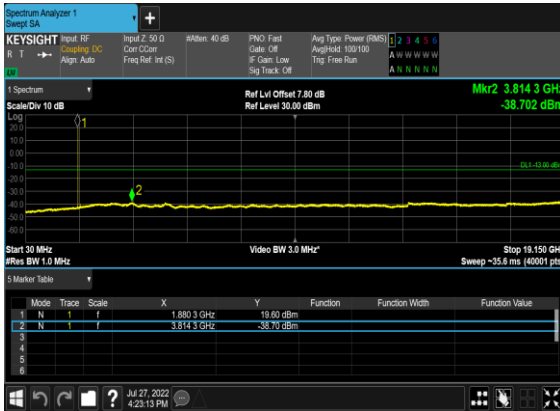

N25(5M)_DFT-s-OFDM_QPSK_Edge_1RB_Left_Mid_CH

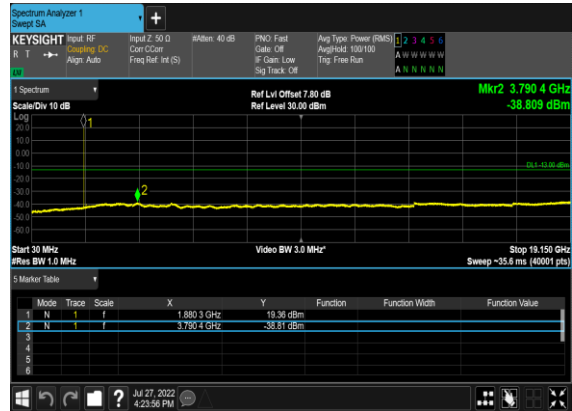

N25(5M)_DFT-s-OFDM_BPSK_Edge_1RB_Left_High_CH

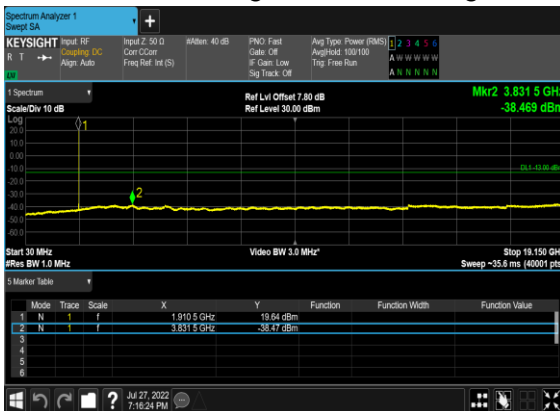

N25(5M)_DFT-s-OFDM_QPSK_Edge_1RB_Left_High_CH

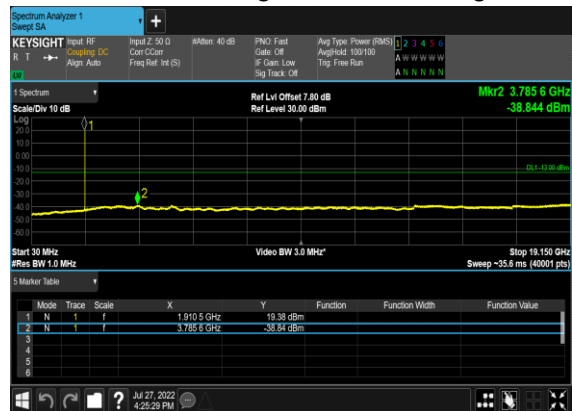

N25(20M)_DFT-s-OFDM_BPSK_Edge_1RB_Left_Low_CH

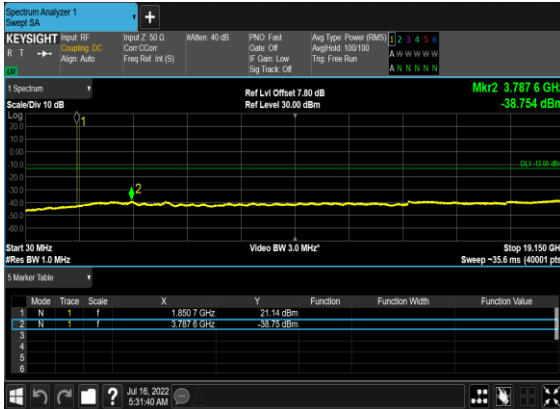

N25(20M)_DFT-s-OFDM_QPSK_Edge_1RB_Left_Low_CH

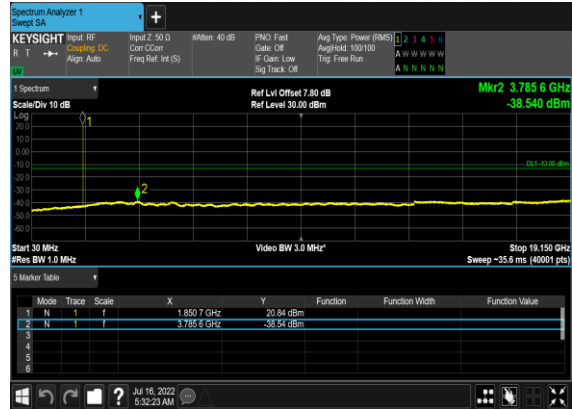

N25(20M)_DFT-s-OFDM_BPSK_Edge_1RB_Left_Mid_CH

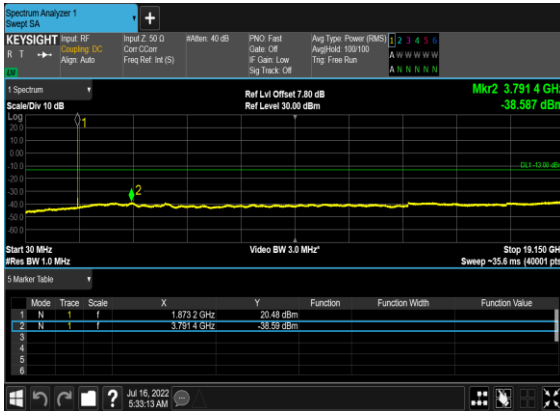

N25(20M)_DFT-s-OFDM_QPSK_Edge_1RB_Left_Mid_CH

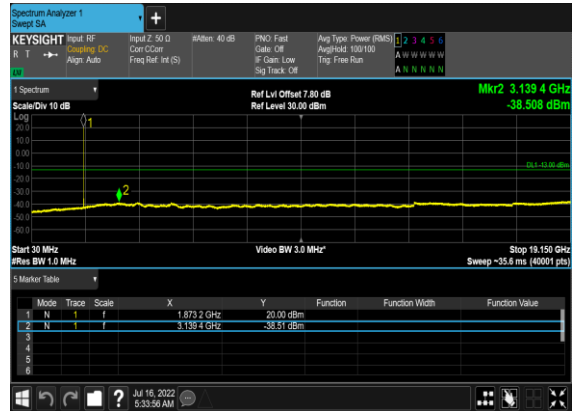

N25(20M)_DFT-s-OFDM_BPSK_Edge_1RB_Left_High_CH

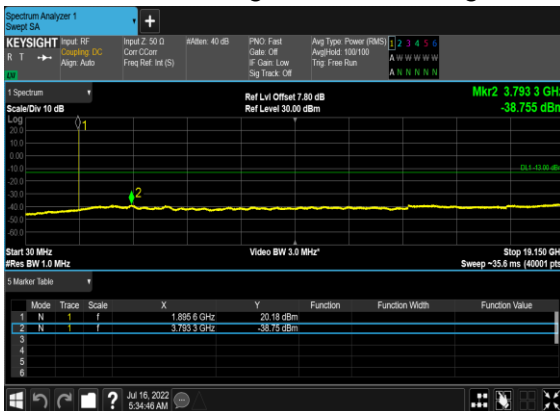

N25(20M)_DFT-s-OFDM_QPSK_Edge_1RB_Left_High_CH

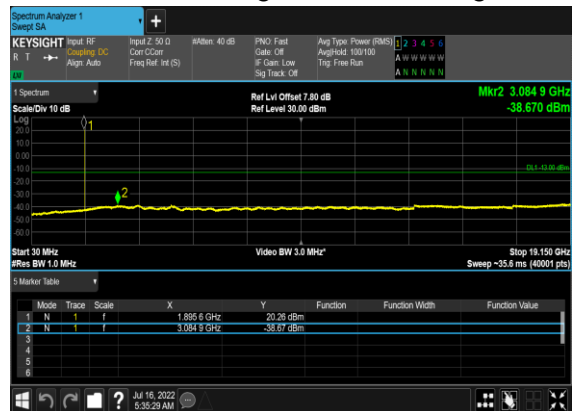

N25(40M)_DFT-s-OFDM_BPSK_Edge_1RB_Left_Low_CH

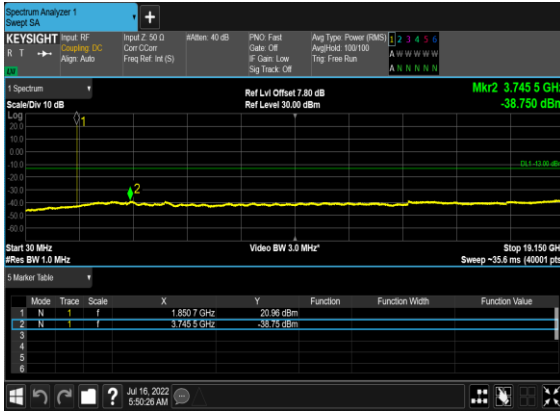

N25(40M)_DFT-s-OFDM_QPSK_Edge_1RB_Left_Low_CH

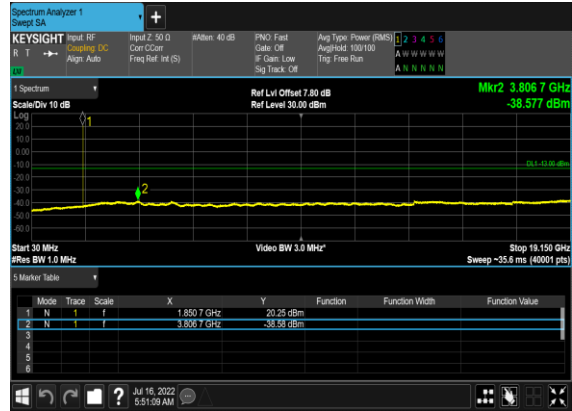

N25(40M)_DFT-s-OFDM_BPSK_Edge_1RB_Left_Mid_CH

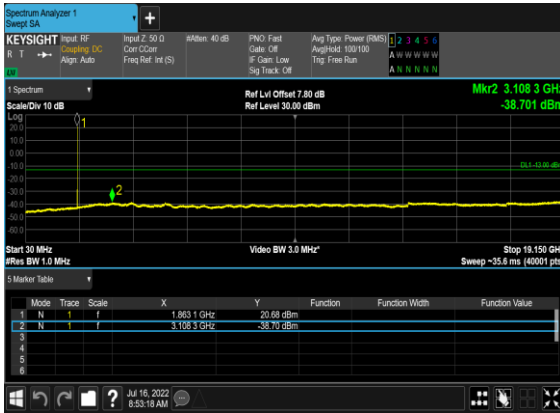

N25(40M)_DFT-s-OFDM_QPSK_Edge_1RB_Left_Mid_CH

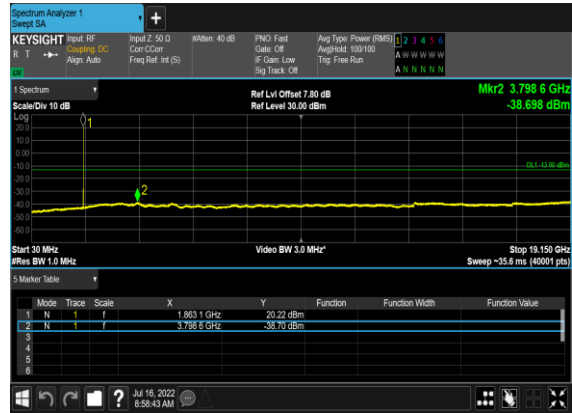

N25(40M)_DFT-s-OFDM_BPSK_Edge_1RB_Left_High_CH

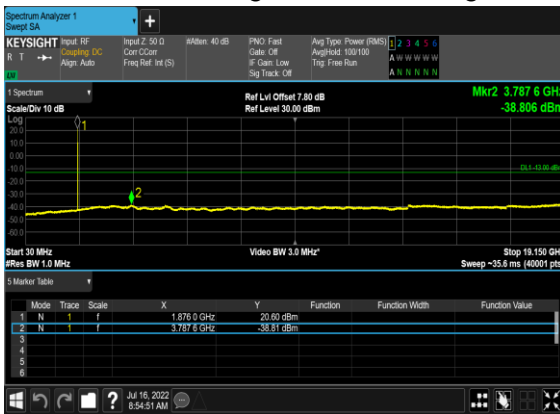

N25(40M)_DFT-s-OFDM_QPSK_Edge_1RB_Left_High_CH

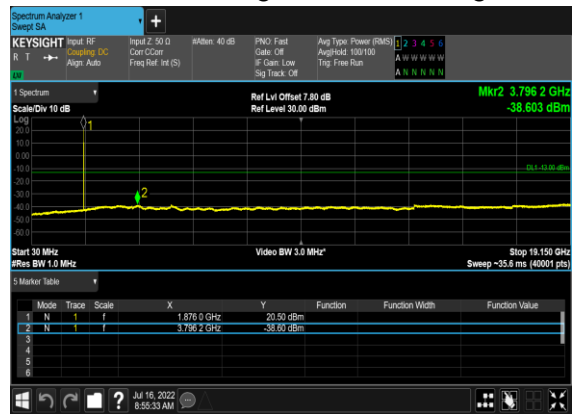

Conducted Band Edge

NR Band	SCS (kHz)	Bandwidth (MHz)	Arfcn	Freq (MHz)	Modulation	RB	Result	Verdict
25	15	5	386500	1852.5	DFT-s-OFDM BPSK	1@0	see graph	PASS
25	15	5	386500	1852.5	DFT-s-OFDM QPSK	1@0	see graph	PASS
25	15	5	386500	1852.5	DFT-s-OFDM BPSK	25@0	see graph	PASS
25	15	5	386500	1852.5	DFT-s-OFDM QPSK	25@0	see graph	PASS
25	15	5	398500	1912.5	DFT-s-OFDM BPSK	1@24	see graph	PASS
25	15	5	398500	1912.5	DFT-s-OFDM QPSK	1@24	see graph	PASS
25	15	5	398500	1912.5	DFT-s-OFDM BPSK	25@0	see graph	PASS
25	15	5	398500	1912.5	DFT-s-OFDM QPSK	25@0	see graph	PASS
25	15	20	388000	1860.0	DFT-s-OFDM BPSK	1@0	see graph	PASS
25	15	20	388000	1860.0	DFT-s-OFDM QPSK	1@0	see graph	PASS
25	15	20	388000	1860.0	DFT-s-OFDM BPSK	100@0	see graph	PASS
25	15	20	388000	1860.0	DFT-s-OFDM QPSK	100@0	see graph	PASS
25	15	20	397000	1905.0	DFT-s-OFDM BPSK	1@105	see graph	PASS
25	15	20	397000	1905.0	DFT-s-OFDM QPSK	1@105	see graph	PASS
25	15	20	397000	1905.0	DFT-s-OFDM BPSK	100@0	see graph	PASS
25	15	20	397000	1905.0	DFT-s-OFDM QPSK	100@0	see graph	PASS
25	15	40	390000	1870.0	DFT-s-OFDM BPSK	1@0	see graph	PASS
25	15	40	390000	1870.0	DFT-s-OFDM QPSK	1@0	see graph	PASS
25	15	40	390000	1870.0	DFT-s-OFDM BPSK	216@0	see graph	PASS
25	15	40	390000	1870.0	DFT-s-OFDM QPSK	216@0	see graph	PASS
25	15	40	395000	1895.0	DFT-s-OFDM BPSK	1@215	see graph	PASS
25	15	40	395000	1895.0	DFT-s-OFDM QPSK	1@215	see graph	PASS

25	15	40	395000	1895.0	DFT-s-OFDM BPSK	216@0	see graph	PASS
25	15	40	395000	1895.0	DFT-s-OFDM QPSK	216@0	see graph	PASS

N25(5M)_DFT-s-
OFDM_BPSK_Edge_1RB_Left_Low_CH

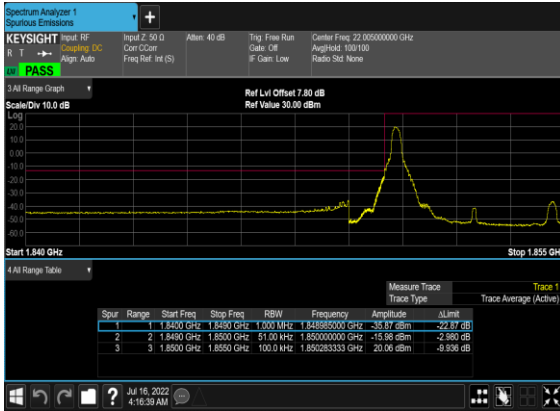

N25(5M)_DFT-s-
OFDM_QPSK_Edge_1RB_Left_Low_CH

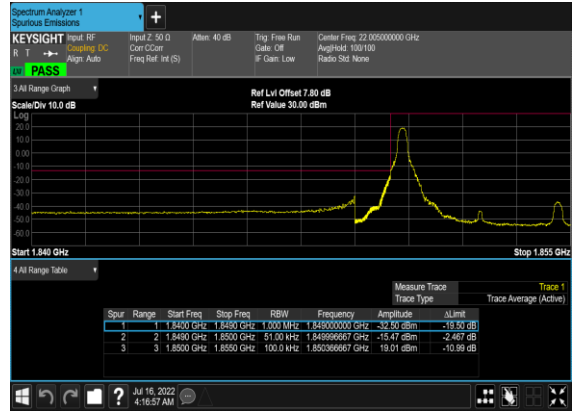

N25(5M)_DFT-s-
OFDM_BPSK_Outer_Full_Low_CH

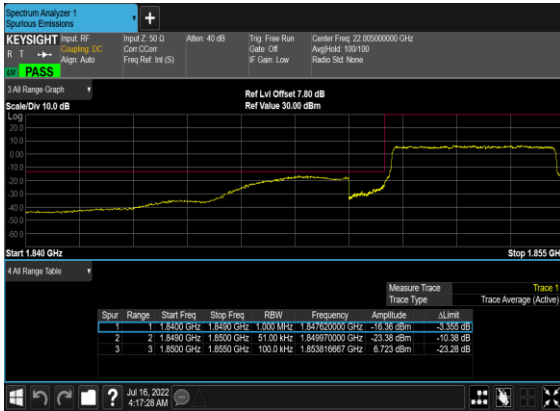

N25(5M)_DFT-s-
OFDM_QPSK_Outer_Full_Low_CH

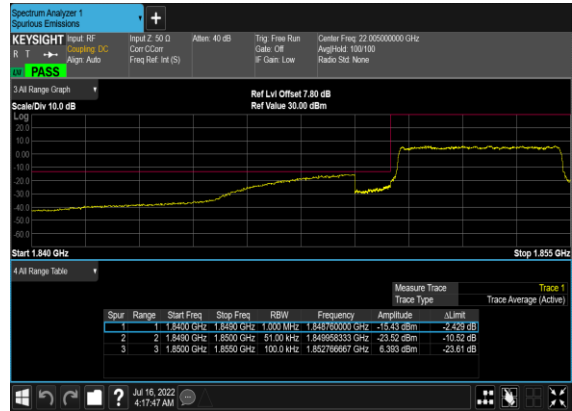

N25(5M)_DFT-s-
OFDM_BPSK_Edge_1RB_Right_High_CH

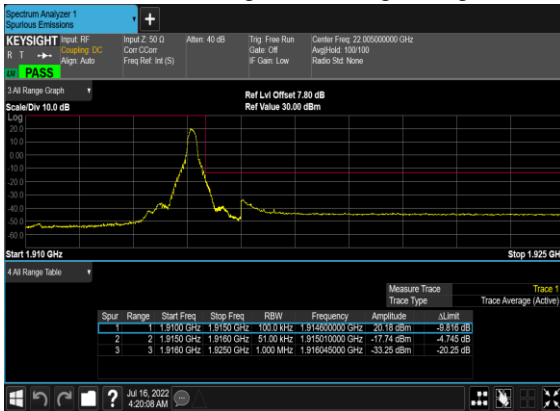

N25(5M)_DFT-s-
OFDM_QPSK_Edge_1RB_Right_High_CH

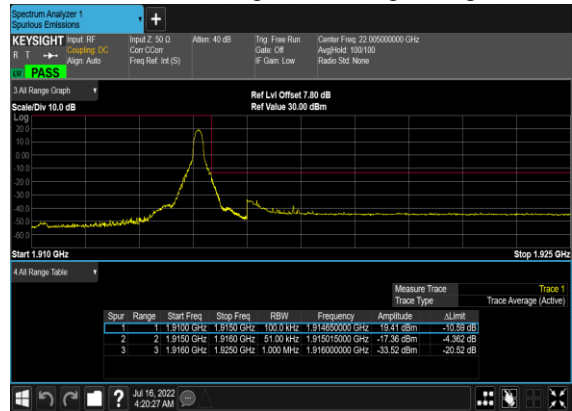

N25(5M)_DFT-s-OFDM_BPSK_Outer_Full_High_CH

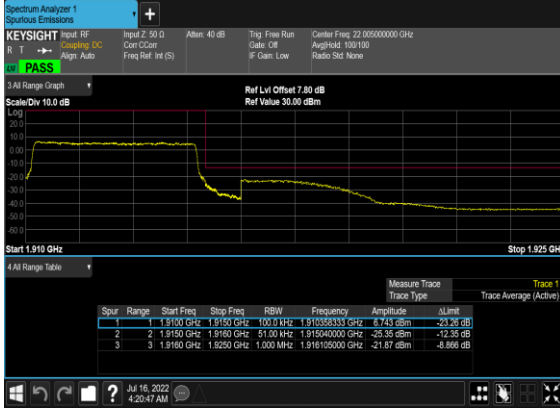

N25(5M)_DFT-s-OFDM_QPSK_Outer_Full_High_CH



N25(20M)_DFT-s-OFDM_BPSK_Edge_1RB_Left_Low_CH

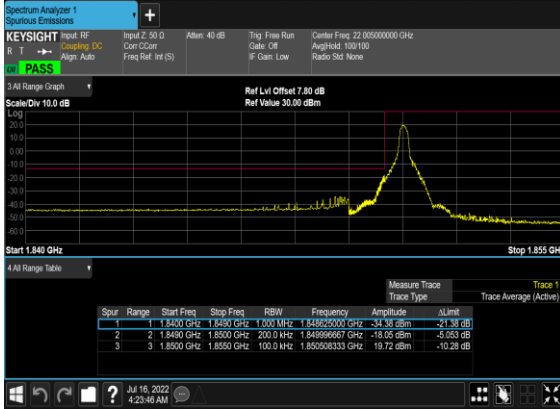

N25(20M)_DFT-s-OFDM_QPSK_Edge_1RB_Left_Low_CH

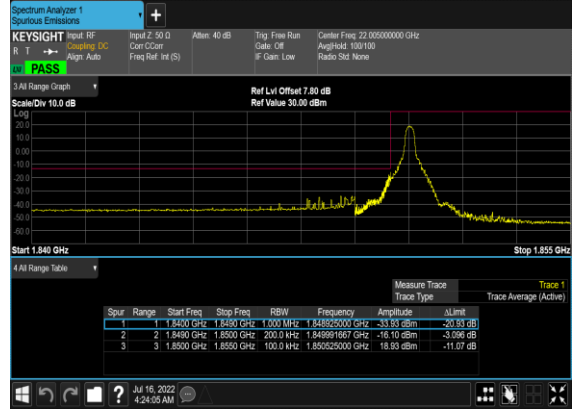

N25(20M)_DFT-s-OFDM_BPSK_Outer_Full_Low_CH

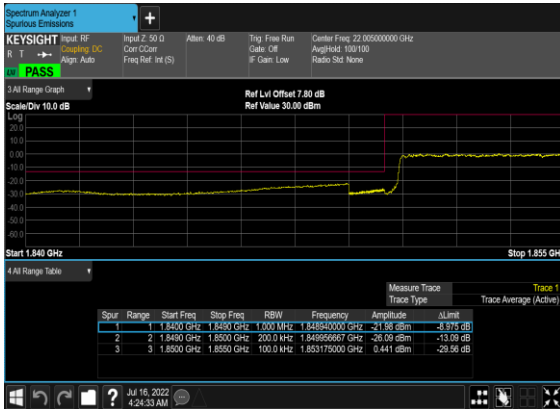

N25(20M)_DFT-s-OFDM_QPSK_Outer_Full_Low_CH

