

REPORT

FCC Certification

Applicant Name:
Franklin Technology Inc.**Address:**
906 JEI Platz, 459-11 Gasan-dong, Gumcheon-gu,
Seoul, Korea 153-792**Date of Issue:**
November 21, 2014**Location:**
HCT CO., LTD., 74, Seoicheon-ro 578beon-gil,
Majang-myeon, Icheon-si, Gyeonggi-do, Korea
Test Report No.: HCT-R-1411-F020**HCT FRN:** 0005866421**FCC ID:** XHG-C774**APPLICANT:** Franklin Technology Inc.**FCC Model(s):** C774**EUT Type:** CPE Router**FCC Classification:** PCS Licensed Transmitter (PCB)**FCC Rule Part(s):** §22, §24, §2**Tx Frequency:** 824.70 — 848.31 MHz (CDMA)
1 851.25 – 1 908.75 MHz (PCS CDMA)**Rx Frequency:** 869.70 — 893.31 MHz (CDMA)
1 931.25 – 1 988.75 MHz (PCS CDMA)**Max. RF Output Power:** 0.422 W ERP CDMA(26.25 dBm)/ 1.250 W EIRP PCS CDMA(30.97 dBm)
0.406 W ERP CDMA EVDO(26.08 dBm) / 1.626 W EIRP PCS CDMA EVDO(32.11 dBm)**Emission Designator(s):** 1M28F9W (CDMA)/ 1M28F9W (CDMA EVDO_Rev.0)/ 1M28F9W (CDMA EVDO_Rev.A)
1M28F9W (PCS CDMA)/ 1M28F9W (PCS CDMA EVDO_Rev.0)/ 1M28F9W (PCS CDMA EVDO_Rev.A)

The measurements shown in this report were made in accordance with the procedures specified in §2.947. I assume full responsibility for the accuracy and completeness of these measurements, and for the qualifications of all persons taking them.

HCT CO., LTD. Certifies that no party to this application has subject to a denial of Federal benefits that includes FCC benefits pursuant to section 5301 of the Anti-Drug Abuse Act of 1998,21 U.S. C.853(a)



Report prepared by
: Kyung Houn Seo
Test engineer of RF Team



Approved by
: Chang Seok Choi
Manager of RF Team

This report only responds to the tested sample and may not be reproduced, except in full, without written approval of the HCT Co., Ltd.

Version

TEST REPORT NO.	DATE	DESCRIPTION
HCT-R-1411-F020	November 21, 2014	- First Approval Report

Table of Contents

1. GENERAL INFORMATION	4
2. INTRODUCTION	5
2.1. EUT DESCRIPTION.....	5
2.2. MEASURING INSTRUMENT CALIBRATION.....	5
2.3. TEST FACILITY	5
3. DESCRIPTION OF TESTS	6
3.1 CONDUCTED OUTPUT POWER	6
3.2 ERP/EIRP RADIATED POWER AND RADIATED SPURIOUS EMISSIONS.....	7
3.3 PEAK- TO- AVERAGE RATIO	8
3.4 OCCUPIED BANDWIDTH.	10
3.5 SPURIOUS AND HARMONIC EMISSIONS AT ANTENNA TERMINAL.....	11
3.6 FREQUENCY STABILITY / VARIATION OF AMBIENT TEMPERATURE	12
4. LIST OF TEST EQUIPMENT	13
5. SUMMARY OF TEST RESULTS	14
6. SAMPLE CALCULATION	15
7. TEST DATA	16
7.1 CONDUCTED OUTPUT POWER	16
7.2 EFFECTIVE RADIATED POWER OUTPUT	17
7.3 EQUIVALENT ISOTROPIC RADIATED POWER	18
7.4 RADIATED SPURIOUS EMISSIONS	19
7.4.1 RADIATED SPURIOUS EMISSIONS (CDMA Mode)	19
7.4.2 RADIATED SPURIOUS EMISSIONS (PCS Mode)	20
7.5 PEAK-TO-AVERAGE RATIO	21
7.6 OCCUPIED BANDWIDTH	21
7.7 CONDUCTED SPURIOUS EMISSIONS	22
7.7.1 Band Edge.....	22
7.9 FREQUENCY STABILITY / VARIATION OF AMBIENT TEMPERATURE	23
7.9.1 RADIATED SPURIOUS EMISSIONS (CDMA Mode)	23
7.9.2 RADIATED SPURIOUS EMISSIONS (PCS Mode)	24
8. TEST PLOTS.....	25

MEASUREMENT REPORT

1. GENERAL INFORMATION

Applicant Name: Franklin Technology Inc.

Address: 906 JEI Platz, 459-11 Gasan-dong, Gumcheon-gu, Seoul, Korea 153-792

FCC ID: XHG-C774

Application Type: Certification

FCC Classification: PCS Licensed Transmitter (PCB)

FCC Rule Part(s): §22, §24, §2

EUT Type: CPE Router

FCC Model(s): C774

Tx Frequency: 824.20 — 848.80 MHz (CDMA)
1 851.25 – 1 908.75 MHz (PCS CDMA)

Rx Frequency: 869.70 — 893.31 MHz (CDMA)
1 931.25 – 1 988.75 MHz (PCS CDMA)

Max. RF Output Power: 0.422 W ERP CDMA(26.25 dBm)/ 1.250 W EIRP PCS CDMA(30.97 dBm)
0.406 W ERP CDMA EVDO(26.08 dBm) / 1.626 W EIRP PCS CDMA EVDO(32.11 dBm)

Emission Designator(s): 1M28F9W (CDMA)/ 1M28F9W (CDMA EVDO_Rev.0)/ 1M28F9W (CDMA EVDO_Rev.A)
1M28F9W (PCS CDMA)/ 1M28F9W (PCS CDMA EVDO_Rev.0)/ 1M28F9W (PCS CDMA EVDO_Rev.A)

Date(s) of Tests: November 10, 2014 ~ November 19, 2014

Antenna Specification Manufacturer: INNO-LINK
Antenna type: Internal Press Antenna(CDMA)
Whip Antenna(EVDO)
Peak Gain: CDMA : 0.81 dBi
PCS CDMA : 3.27 dBi
CDMA EVDO : 0.91 dBi
PCS CDMA : 2.24 dBi

2. INTRODUCTION

2.1. EUT DESCRIPTION

The Franklin Technology Inc. C774 CPE Router consists of Cellular CDMA, PCS CDMA, EVDO_Rev.0 and EVDO_Rev.A.

2.2. MEASURING INSTRUMENT CALIBRATION

The measuring equipment, which was utilized in performing the tests documented herein, has been calibrated in accordance with the manufacturer's recommendations for utilizing calibration equipment, which is traceable to recognized national standards.

2.3. TEST FACILITY

The Fully-anechoic chamber and conducted measurement facility used to collect the radiated data are located at the **74, Seoicheon-ro 578beon-gil, Majang-myeon, Icheon-si, Gyeonggi-do, Korea.**

3. DESCRIPTION OF TESTS

3.1 CONDUCTED OUTPUT POWER

Test Procedure

Conducted Output Power is tested in accordance with KDB971168 D01 Power Meas License Digital Systems v02r02, October 17, 2014, Section 5.2.

5.2.1 Procedure for use with a spectrum/signal analyzer when EUT can be configured to transmit continuously or when sweep triggering/signal gating can be properly implemented

The EUT is considered to transmit continuously if it can be configured to transmit at a burst duty cycle of greater than or equal to 98% throughout the duration of the measurement. If this condition can be achieved, then the following procedure can be used to measure the average output power of the EUT.

This procedure can also be used when the EUT cannot be configured to transmit continuously, provided that the measurement instrument can be configured to trigger a sweep at the beginning of each full-power transmission burst, and the sweep time is less than or equal to the minimum transmission time during each burst (*i.e.*, no burst off-time is to be included in the measurement).

- a) Set span to at least 1.5 times the OBW.
- b) Set RBW = 1-5% of the OBW, not to exceed 1 MHz.
- c) Set VBW $\geq 3 \times$ RBW.
- d) Set number of points in sweep $\geq 2 \times$ span / RBW.
- e) Sweep time = auto-couple.
- f) Detector = RMS (power averaging).
- g) If the EUT can be configured to transmit continuously (*i.e.*, burst duty cycle $\geq 98\%$), then set the trigger to free run.
- h) If the EUT cannot be configured to transmit continuously (*i.e.*, burst duty cycle $< 98\%$), then use a sweep trigger with the level set to enable triggering only on full power bursts and configure the EUT to transmit at full power for the entire duration of each sweep. Ensure that the sweep time is less than or equal to the transmission burst duration.
- i) Trace average at least 100 traces in power averaging (*i.e.*, RMS) mode.
- j) Compute the power by integrating the spectrum across the OBW of the signal using the instrument's band power measurement function, with the band limits set equal to the OBW band edges. If the instrument does not have a band power function, then sum the spectrum levels (in linear power units) at intervals equal to the RBW extending across the entire OBW of the spectrum.

3.2 ERP/EIRP RADIATED POWER AND RADIATED SPURIOUS EMISSIONS

Note: ERP(Effective Radiated Power), EIRP(Effective Isotropic Radiated Power)

Test Procedure

Radiated emission measurements are performed in the Fully-anechoic chamber. The equipment under test is placed on a non-conductive table 3-meters away from the receive antenna in accordance with ANSI/TIA-603-C-2004 Clause 2.2.17. The turntable is rotated through 360 degrees, and the receiving antenna scans in order to determine the level of the maximized emission. The level and position of the maximized emission is recorded with the spectrum analyzer using a positive peak detector.

A half wave dipole is then substituted in place of the EUT. For emissions above 1GHz, a horn antenna is substituted in place of the EUT. The substitute antenna is driven by a signal generator and the previously recorded signal was duplicated.

The power is calculated by the following formula;

$$P_{d(dBm)} = P_{g(dBm)} - \text{cable loss}_{(dB)} + \text{antenna gain}_{(dB)}$$

Where: P_d is the dipole equivalent power and P_g is the generator output power into the substitution antenna.

The maximum EIRP is calculated by adding the forward power to the calibrated source plus its appropriate gain value. These steps are repeated with the receiving antenna in both vertical and horizontal polarization. the difference between the gain of the horn and an isotropic antenna are taken into consideration

Radiated spurious emissions

1. Frequency Range : 30 MHz ~ 10th Harmonics of highest channel fundamental frequency.
2. The EUT was setup to maximum output power. The 100 kHz RBW was used to scan from 30 MHz to 1 GHz. Also, the 1 MHz RBW was used to scan from 1 GHz to 10 GHz (Cellular CDMA) or 20 GHz (PCS CDMA). The high, low and a middle channel were tested for out of band measurements.

Note : This device was tested under all R.C.s and S.O.s and worst case is reported with 'All Up' power control bits.

3.3 PEAK- TO- AVERAGE RATIO

Test Procedure

Peak to Average Power Ratio is tested in accordance with KDB971168 D01 Power Meas License Digital Systems v02r02, October 17, 2014, Section 5.7.

- Section 5.7.1 CCDF Procedure

- a) Set resolution/measurement bandwidth \geq signal's occupied bandwidth;
- b) Set the number of counts to a value that stabilizes the measured CCDF curve;
- c) Set the measurement interval as follows:
 - 1) for continuous transmissions, set to 1 ms,
 - 2) for burst transmissions, employ an external trigger that is synchronized with the EUT burst timing sequence, or use the internal burst trigger with a trigger level that allows the burst to stabilize and set the measurement interval to a time that is less than or equal to the burst duration.
- d) Record the maximum PAPR level associated with a probability of 0.1%.

- Section 5.7.2 Alternate Procedure

Use one of the procedures presented in 5.1 to measure the total peak power and record as P_{Pk} . Use one of the applicable procedures presented 5.2 to measure the total average power and record as P_{Avg} . Determine the P.A.R. from: $P.A.R_{(dB)} = P_{Pk (dBm)} - P_{Avg (dBm)}$ (P_{Avg} = Average Power + Duty cycle Factor)

5.1.1 Peak power measurements with a spectrum/signal analyzer or EMI receiver

The following procedure can be used to determine the total peak output power.

- a) Set the RBW \geq OBW.
- b) Set VBW $\geq 3 \times$ RBW.
- c) Set span $\geq 2 \times$ RBW
- d) Sweep time = auto couple.
- e) Detector = peak.
- f) Ensure that the number of measurement points \geq span/RBW.
- g) Trace mode = max hold.
- h) Allow trace to fully stabilize.
- i) Use the peak marker function to determine the peak amplitude level.

5.2.2 Procedures for use with a spectrum/signal analyzer when EUT cannot be configured to transmit continuously and sweep triggering/signal gating cannot be properly implemented

If the EUT cannot be configured to transmit continuously (burst duty cycle < 98%), then one of the following procedures can be used. The selection of the applicable procedure will depend on the characteristics of the measured burst duty cycle.

Measure the burst duty cycle with a spectrum/signal analyzer or EMC receiver can be used in zero-span mode if the response time and spacing between bins on the sweep are sufficient to permit accurate measurement of the burst on/off time of the transmitted signal.

5.2.2.2 Constant burst duty cycle

If the measured burst duty cycle is constant (i.e., duty cycle variations are less than ± 2 percent), then:

- a) Set span to at least 1.5 times the OBW.
- b) Set RBW = 1-5% of the OBW, not to exceed 1 MHz.
- c) Set VBW $\geq 3 \times$ RBW.
- d) Number of points in sweep $\geq 2 \times$ span / RBW. (This gives bin-to-bin spacing \leq RBW/2, so that narrowband signals are not lost between frequency bins.)
- e) Sweep time = auto.
- f) Detector = RMS (power averaging).
- g) Set sweep trigger to "free run".
- h) Trace average at least 100 traces in power averaging (i.e., RMS) mode.
- i) Compute power by integrating the spectrum across the OBW of the signal using the instrument's band power measurement function with band limits set equal to the OBW band edges. If the instrument does not have a band power function, sum the spectrum levels (in power units) at intervals equal to the RBW extending across the entire OBW of the spectrum.
- j) Add $10 \log (1/x)$, where x is the duty cycle, to the measured power in order to compute the average power during the actual transmission times (because the measurement represents an average over both the on and off times of the transmission).

For example, add $10 \log (1/0.25) = 6$ dB if the duty cycle is a constant 25%.

3.4 OCCUPIED BANDWIDTH.

Test set-up

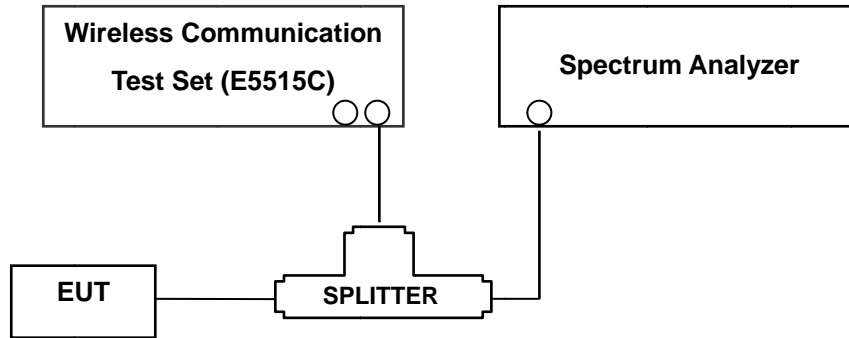

(Configuration of conducted Emission measurement)

The width of a frequency band such that, below the lower and above the upper frequency limits, the mean powers emitted are each equal to a specified percentage 0.5 % of the total mean power of a given emission.

Test Procedure

OBW is tested in accordance with KDB971168 D01 Power Meas License Digital Systems v02r02, October 17, 2014, Section 4.2..

The EUT makes a call to the communication simulator. The power was measured with R&S Spectrum Analyzer. All measurements were done at 3 channels (low, middle and high operational range.)

The conducted occupied bandwidth used the power splitter via EUT RF power connector between simulation base station and spectrum analyzer.

The communication simulator station system controlled a EUT to export maximum output power under transmission mode and specific channel frequency. Use OBW measurement function of Spectrum analyzer to measure 99 % occupied bandwidth

Note : This device was tested under all R.C.s and S.O.s and worst case is reported with 'All Up' power control bits.

3.5 SPURIOUS AND HARMONIC EMISSIONS AT ANTENNA TERMINAL.

Test Procedure

The level of the carrier and the various conducted spurious and harmonic frequencies is measured by means of a calibrated spectrum analyzer.

On any frequency outside a licensee's frequency block, the power of any emission shall be attenuated below the transmitter power (P) by at least $43 + 10 \log(P)$ dB. The RBW settings used in the testing are greater than 1 % of the occupied bw. The 1 MHz RBW was used to scan from 10 MHz to 10 GHz. (GSM1900 Mode: 10 MHz to 20 GHz). A display line was placed at - 13 dBm to show compliance. The high, lowest and a middle channel were tested for out of band measurements.

Measurements of all out of band are made on RBW = 1MHz and VBW \geq 3 MHz in the worst case despite RBW = 100 kHz and VBW \geq 300 kHz upon 1 GHz.

- RBW = 1 MHz
- VBW \geq 3 MHz
- Detector = Peak
- Trace Mode = max hold
- Sweep time = auto
- Number of points in sweep \geq 2 * Span / RBW

- Band Edge Requirement : According to FCC 22.917, 24.238(a) specified that power of any emission outside of The authorized operating frequency ranges must be attenuated below the transmitting power (P) by a factor of at least $43 + 10 \log(P)$ dB. In the 1 MHz bands immediately outside and adjacent to the frequency block a resolution bandwidth of at least one percent of the emission bandwidth of the fundamental emission of the transmitter may be employed.

The EUT makes a call to the communication simulator. The power was measured with R&S Spectrum Analyzer. All measurements were done at 2 channels(low and high operational frequency range.)

The band edge measurement used the power splitter via EUT RF power connector between simulation base station and spectrum analyzer.

Note : This device was tested under all R.C.s and S.O.s with 'All Up' power control bits.

NOTES: The analyzer plot offsets were determined by below conditions.

- For CDMA, total offset 26.8 dB = 20 dB attenuator + 6 dB Splitter + 0.8 dB RF cables,
- For PCS, total offset 27.3 dB = 20 dB attenuator + 6 dB Splitter + 1.3 dB RF cables,

3.6 FREQUENCY STABILITY / VARIATION OF AMBIENT TEMPERATURE

Test Set-up

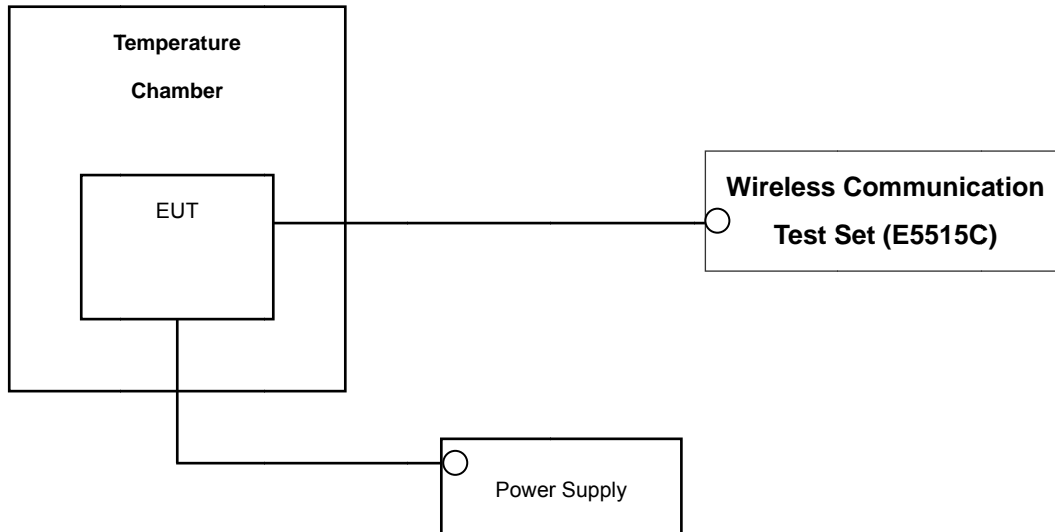

* Nominal Operating Voltage

Test Procedure

Frequency stability is tested in accordance with ANSI/TIA-603-C-2004 section 2.2.2.

The frequency stability of the transmitter is measured by:

- a.) **Temperature:** The temperature is varied from - 30 °C to + 50 °C using an environmental chamber.
- b.) **Primary Supply Voltage:** The primary supply voltage is varied from battery end point to 115 % of the voltage normally at the input to the device or at the power supply terminals if cables are not normally supplied.

Specification — the frequency stability shall be sufficient to ensure that the fundamental emission stays within the authorized frequency block(PCS CDMA). The frequency stability of the transmitter shall be maintained within $\pm 0.00025\%$ (± 2.5 ppm) of the center frequency(Cellular CDMA).

Time Period and Procedure:

The carrier frequency of the transmitter is measured at room temperature (20°C to provide a reference).

1. The equipment is turned on in a “standby” condition for one minute before applying power to the transmitter. Measurement of the carrier frequency of the transmitter is made within one minute after applying power to the transmitter.
2. Frequency measurements are made at 10°C intervals ranging from -30°C to +50°C. A period of at least one half-hour is provided to allow stabilization of the equipment at each temperature level.

NOTE: The EUT is tested down to the battery endpoint.

Note : This device was tested under all R.C.s and S.O.s with 'All Up' power control bits.

4. LIST OF TEST EQUIPMENT

Manufacture	Model/ Equipment	Serial Number	Calibration Interval	Calibration Due
Agilent	N1921A/ Power Sensor	MY45241059	Annual	07/09/2015
Agilent	N1911A/ Power Meter	MY45100523	Annual	01/24/2015
MITEQ	AMF-6D-001180-35-20P/AMP	1081666	Annual	09/04/2015
Wainwright	WHK1.2/15G-10EF/H.P.F	4	Annual	06/17/2015
Wainwright	WRCJV2400/2483.5-2370/2520-60/12SS / B.R.F.	1	Annual	06/17/2015
Wainwright	WHK3.3/18G-10EF/H.P.F	2	Annual	06/17/2015
Hewlett Packard	11667B / Power Splitter	10545	Annual	02/22/2015
Hewlett Packard	11667B / Power Splitter	11275	Annual	05/19/2015
Digital	EP-3010/ Power Supply	3110117	Annual	10/29/2015
Schwarzbeck	UHAP/ Dipole Antenna	557	Biennial	03/05/2015
Schwarzbeck	UHAP/ Dipole Antenna	558	Biennial	05/03/2015
Korea Engineering	KR-1005L / Chamber	KRAC05063-3CH	Annual	10/29/2015
Schwarzbeck	BBHA 9120D/ Horn Antenna	147	Biennial	09/01/2016
Schwarzbeck	BBHA 9120D/ Horn Antenna	1151	Biennial	10/05/2015
Schwarzbeck	BBHA 9170/ Horn Antenna(15~40GHz)	BBHA9170541	Biennial	07/05/2015
Agilent	E4440A/Spectrum Analyzer	US45303008	Annual	04/09/2015
WEINSCHEL	ATTENUATOR	BR0592	Annual	10/22/2015
REOHDE&SCHWARZ	FSV40/Spectrum Analyzer	1307.9002K40-100931-NK	Annual	06/09/2015
Agilent	8960 (E5515C)/ Base Station	MY48360222	Annual	08/26/2015
Anritsu Corp.	MT8820C/Wideband Radio Communication Tester	6200863156	Annual	04/01/2015

5. SUMMARY OF TEST RESULTS

FCC Part Section(s)	Test Description	Test Limit	Test Condition	Test Result
2.1049, 22.917(a), 24.238(a)	Occupied Bandwidth	N/A	CONDUCTED	PASS
2.1051, 22.917(a), 24.238(a)	Band Edge / Spurious and Harmonic Emissions at Antenna Terminal.	$< 43 + 10\log_{10}(P[\text{Watts}])$ at Band Edge and for all out-of-band emissions		PASS
2.1046	Conducted Output Power	N/A		PASS
24.232(d)	Peak- to- Average Ratio	$< 13 \text{ dB}$		PASS
2.1055, 22.355, 24.235	Frequency stability / variation of ambient temperature	$< 2.5 \text{ ppm}$		PASS
22.913(a)(2) 24.232(c)	Effective Radiated Power	$< 7 \text{ Watts max. ERP}$	RADIATED	PASS
	Equivalent Isotropic Radiated Power	$< 2 \text{ Watts max. EIRP}$		PASS
2.1053, 22.917(a), 24.238(a)	Radiated Spurious and Harmonic Emissions	$< 43 + 10\log_{10}(P[\text{Watts}])$ for all out-of band emissions		PASS

6. SAMPLE CALCULATION

A. ERP Sample Calculation

Mode	Ch./ Freq.		Measured Level(dBm)	Substitute LEVEL(dBm)	Ant. Gain (dBd)	C.L	Pol.	ERP	
	channel	Freq.(MHz)						W	dBm
CDMA	384	836.52	-23.45	38.92	-10.53	0.88	V	0.564	27.51

ERP = SubstituteLEVEL(dBm) + Ant. Gain – CL(Cable Loss)

- 1) The EUT mounted on a non-conductive turntable is 0.8 meter above test site ground level.
- 2) During the test , the turn table is rotated until the maximum signal is found.
- 3) Record the field strength meter's level.
- 4) Replace the EUT with dipole/Horn antenna that is connected to a calibrated signal generator.
- 5) Increase the signal generator output till the field strength meter's level is equal to the item (3).
- 6) The signal generator output level with Ant. Gain and cable loss are the rating of effective radiated power (ERP).

B. Emission Designator

CDMA Emission Designator

Emission Designator = 1M27F9W

CDMA BW = 1.27 MHz (Measured at the 99% power bandwidth)

F = Frequency Modulation

9 = Composite Digital Info

W = Combination (Audio/Data)

7. TEST DATA

7.1 CONDUCTED OUTPUT POWER

A base station simulator was used to establish communication with The EUT. The base station simulator parameters were set to produce the maximum power from the EUT. This device was tested under all configurations and the highest power is reported. Conducted Output Powers of EUT are reported below.

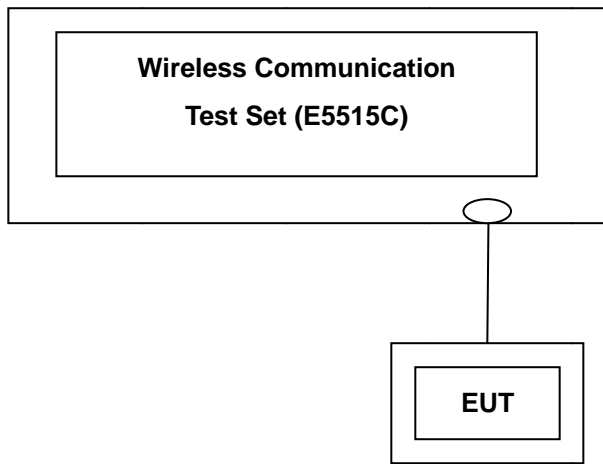

Band	Channel	SO2	SO2	SO55	SO55	TDSO	1xEVDO Rev.0	1xEVDO Rev.0	1xEVDO Rev.A	1xEVDO Rev.A
		RC1 (dBm)	RC3 (dBm)	RC1 (dBm)	RC3 (dBm)	RC3 (dBm)	(FTAP) (dBm)	(RTAP) (dBm)	(FETAP) (dBm)	(RETAP) (dBm)
CDMA	1013	23.45	23.53	23.46	23.57	24.15	23.84	23.71	23.70	23.65
	384	23.42	23.57	23.50	23.62	24.03	23.72	23.61	23.68	23.59
	777	23.75	23.86	23.85	23.91	23.75	23.48	23.69	23.42	23.23
PCS	25	23.46	23.49	23.48	23.55	23.65	23.89	23.89	23.87	23.84
	600	23.55	23.57	23.54	23.59	23.73	23.83	23.85	23.82	23.86
	1175	23.23	23.25	23.16	23.20	23.19	23.52	23.45	23.52	23.49

(Maximum Conducted Output Powers)

Note : Detecting mode is average.

7.2 EFFECTIVE RADIATED POWER OUTPUT

(CDMA Mode)

Mode	Ch./ Freq.		Measured Level (dBm)	Substitute LEVEL (dBm)	Ant. Gain (dBd)	C.L	Pol.	ERP	
	channel	Freq.(MHz)						W	dBm
CDMA	1013	824.20	-26.34	38.03	-10.59	1.19	V	0.422	26.25
	384	836.60	-28.21	36.51	-10.53	1.22	V	0.299	24.76
	777	848.80	-28.53	37.11	-10.48	1.22	V	0.348	25.41
EVDO	1013	824.20	-26.51	37.86	-10.59	1.19	V	0.406	26.08
	384	836.60	-28.40	36.32	-10.53	1.22	V	0.286	24.57
	777	848.80	-29.14	36.50	-10.48	1.22	V	0.302	24.80

Note: Standard batteries are the only options for this Phone. And a peak detector is used.

NOTES:

Effective Radiated Power Output Measurements by Substitution Method

according to ANSI/TIA/EIA-603-C-2004, Aug. 17, 2004:

The EUT was placed on a non-conductive styrofoam resin table table 3-meters from the receive antenna. The receive antenna height and turntable rotation was adjusted for the highest reading on the receive spectrum analyzer. For CDMA signals, a peak detector is used, with $RBW \geq OBW$, $VBW \geq 3 \times RBW$. A half-wave dipole was substituted in place of the EUT. This dipole antenna was driven by a signal generator and the level of the signal generator was adjusted to obtain the same receive spectrum analyzer reading. The conducted power at the terminals of the dipole is measured. The ERP is recorded.

This device was tested under all configurations and the highest power is reported. Also, we have done x, y, z planes in EUT and horizontal and vertical polarization in detecting antenna. The worst case of the EUT is in y plane in CDMA mode and CDMA EVDO mode. Also worst case of detecting Antenna is in vertical polarization in CDMA mode and CDMA EVDO mode.

The EVDO mode testing were performed using FETAP on Rev.A because FETAP on Rev.A is highest power in EVDO mode.

7.3 EQUIVALENT ISOTROPIC RADIATED POWER

(PCS CDMA Mode)

Mode	Ch./ Freq.		Measured Level (dBm)	Substitute LEVEL (dBm)	Ant. Gain (dBi)	C.L	Pol.	ERP	
	channel	Freq.(MHz)						W	dBm
PCS	25	1,851.25	-12.41	22.24	10.04	1.83	H	1.109	30.45
	600	1,880.00	-12.19	22.78	10.04	1.85	H	1.250	30.97
	1175	1,908.75	-14.47	20.55	10.05	1.88	H	0.745	28.72
EVDO	25	1,851.25	-10.92	23.73	10.04	1.83	V	1.563	31.94
	600	1,880.00	-11.05	23.92	10.04	1.85	V	1.626	32.11
	1175	1,908.75	-13.94	21.08	10.05	1.88	V	0.841	29.25

Note: Standard batteries are the only options for this Phone. And a peak detector is used.

NOTES:

Equivalent Isotropic Radiated Power Measurements by Substitution Method according to ANSI/TIA/EIA-603-C-2004, Aug. 17, 2004:

The EUT was placed on a non-conductive styrofoam resin table table 3-meters from the receive antenna. The receive antenna height and turntable rotation was adjusted for the highest reading on the receive spectrum analyzer. For CDMA signals, a peak detector is used, with $RBW \geq OBW$, $VBW \geq 3 \times RBW$. A half-wave dipole was substituted in place of the EUT. This dipole antenna was driven by a signal generator and the level of the signal generator was adjusted to obtain the same receive spectrum analyzer reading. The conducted power at the terminals of the dipole is measured. The ERP is recorded.

This device was tested under all configurations and the highest power is reported. Also, we have done x, y, z planes in EUT and horizontal and vertical polarization in detecting antenna. The worst case of the EUT is in z plane in PCS mode and PCS EVEO (y plane) mode. Also worst case of detecting Antenna is in horizontal polarization in PCS mode and PCS EVEO (vertical polarization) mode.

The EVDO mode testing were performed using FETAP on Rev.A because FETAP on Rev.A is highest power in EVDO mode.

7.4 RADIATED SPURIOUS EMISSIONS

7.4.1 RADIATED SPURIOUS EMISSIONS (CDMA Mode)

MEASURED OUTPUT POWER: 26.25 dBm = 0.422 W

MODULATION SIGNAL: CDMA

DISTANCE: 3 meters

LIMIT: $43 + 10 \log_{10}(W) =$ 39.25 dBc

Ch.	Freq.(MHz)	Measured Level [dBm]	Ant. Gain (dBd)	Substitute Level [dBm]	C.L	Pol.	ERP (dBm)	dBc
1013 (824.2)	1,649.40	-42.10	7.56	-45.84	1.74	H	-40.02	66.27
	2,474.10	-54.23	8.39	-55.78	2.14	V	-49.53	75.78
	3,298.80	-57.81	10.08	-58.88	2.50	H	-51.30	77.55
384 (836.6)	1,673.04	-39.83	7.62	-44.20	1.75	H	-38.33	64.58
	2,509.56	-55.15	8.50	-56.92	2.16	V	-50.58	76.83
	3,346.08	-57.41	10.26	-59.04	2.53	H	-51.31	77.56
777 (848.8)	1,696.62	-42.51	7.69	-46.85	1.77	H	-40.93	67.18
	2,544.93	-55.23	8.57	-56.49	2.17	H	-50.09	76.34
	3,393.24	-56.09	10.25	-57.82	2.53	H	-50.10	76.35

NOTES: 1. Radiated Spurious Emission Measurements at 3 meters by Substitution Method

according to ANSI/TIA/EIA-603-C-2004, Aug. 17, 2004:

2. We are performed all frequency to 10th harmonics from 30 MHz. Measurements above show only up to 3 maximum emissions noted, or would be lesser if no specific emissions from the EUT are recorded (ie: margin > 20 dB from the applicable limit) and considered that's already beyond the background noise floor.

3. we have done x, y, z planes in EUT and horizontal and vertical polarization in detecting antenna.

7.4.2 RADIATED SPURIOUS EMISSIONS (PCS Mode)

MEASURED OUTPUT POWER: 32.11 dBm = 1.626 W
 MODULATION SIGNAL: PCS EVDO
 DISTANCE: 3 meters
 LIMIT: $43 + 10 \log_{10}(W) =$ 45.11 dBc

Ch.	Freq.(MHz)	Measured Level [dBm]	Ant. Gain (dBi)	Substitute Level [dBm]	C.L	Pol.	ERP (dBm)	dBc
25 (1851.25)	3,702.50	-44.75	12.32	-46.53	2.64	H	-36.85	68.96
	5,553.75	-43.13	13.02	-39.59	3.39	H	-29.96	62.07
	7,405.00	-57.50	11.06	-45.07	4.10	V	-38.11	70.22
600 (1880.00)	3,760.00	-49.34	12.29	-51.04	2.67	H	-41.42	73.53
	5,640.00	-45.85	13.12	-42.44	3.51	H	-32.83	64.94
	7,520.00	-57.20	11.09	-45.68	4.38	H	-38.97	71.08
1175 (1908.75)	3,817.50	-48.47	12.28	-49.56	2.70	H	-39.98	72.09
	5,726.25	-42.04	13.07	-38.43	3.57	H	-28.93	61.04
	7,635.00	-58.67	11.37	-46.74	4.04	V	-39.41	71.52

- NOTES:**
1. Radiated Spurious Emission Measurements at 3 meters by Substitution Method according to ANSI/TIA/EIA-603-C-2004, Aug. 17, 2004:
 2. We are performed all frequency to 10th harmonics from 30 MHz. Measurements above show only up to 3 maximum emissions noted, or would be lesser if no specific emissions from the EUT are recorded (ie: margin > 20 dB from the applicable limit) and considered that's already beyond the background noise floor.
 3. we have done x, y, z planes in EUT and horizontal and vertical polarization in detecting antenna.

7.5 PEAK-TO-AVERAGE RATIO

- Plots of the EUT's Peak- to- Average Ratio are shown Page 35 ~ 36.

7.6 OCCUPIED BANDWIDTH

Band	Channel	Frequency(MHz)	Data (MHz)
CDMA	1013	824.20	1.2802
	384	836.60	1.2697
	777	848.80	1.2763
CDMA EVDO	1013	824.20	1.2656
	384	836.60	1.2753
	777	848.80	1.2730
CDMA EVDO_A	1013	824.20	1.2814
	384	836.60	1.2713
	777	848.80	1.2717
PCS	25	1851.25	1.2699
	600	1880.00	1.2726
	1175	1908.75	1.2760
PCS EVDO	25	1851.25	1.2810
	600	1880.00	1.2723
	1175	1908.75	1.2825
PCS EVDO_A	25	1851.25	1.2728
	600	1880.00	1.2752
	1175	1908.75	1.2810

- Plots of the EUT's Occupied Bandwidth are shown Page 26 ~ 34.

7.7 CONDUCTED SPURIOUS EMISSIONS

Band	Channel	Frequency of Maximum Harmonic (GHz)	Maximum Data (dBm)
CDMA	1013	4.942600	-28.81
	384	4.787530	-29.05
	777	4.996770	-29.07
PCS	25	5.593510	-26.52
	600	6.953920	-25.58
	1175	6.979340	-26.30

- Plots of the EUT's Conducted Spurious Emissions are shown Page 48 ~ 54

7.7.1 Band Edge

- Plots of the EUT's Band Edge are shown Page 36 ~ 48.

7.9 FREQUENCY STABILITY / VARIATION OF AMBIENT TEMPERATURE

7.9.1 RADIATED SPURIOUS EMISSIONS (CDMA Mode)

OPERATING FREQUENCY: 836,520,000 Hz
 CHANNEL: 384
 REFERENCE VOLTAGE: 12.0 VDC
 DEVIATION LIMIT: ± 0.000 25 % or 2.5 ppm

Voltage (%)	Power (VDC)	Temp. ()	Frequency (Hz)	Frequency Error (Hz)	Deviation (%)	ppm
100%	12.0	+20(Ref)	836 519 999	0	0.000 000	0.000
100%		-30	836 520 000	0.92	0.000 000	0.001
100%		-20	836 519 997	-1.64	0.000 000	-0.002
100%		-10	836 520 000	1.45	0.000 000	0.002
100%		0	836 520 000	1.32	0.000 000	0.002
100%		+10	836 519 996	-2.13	0.000 000	-0.003
100%		+30	836 520 000	1.75	0.000 000	0.002
100%		+40	836 520 000	1.63	0.000 000	0.002
100%		+50	836 520 001	2.35	0.000 000	0.003
115%		13.8	+20	836 520 000	1.62	0.000 000
Batt. Endpoint	10.2	+20	836 520 001	1.94	0.000 000	0.002

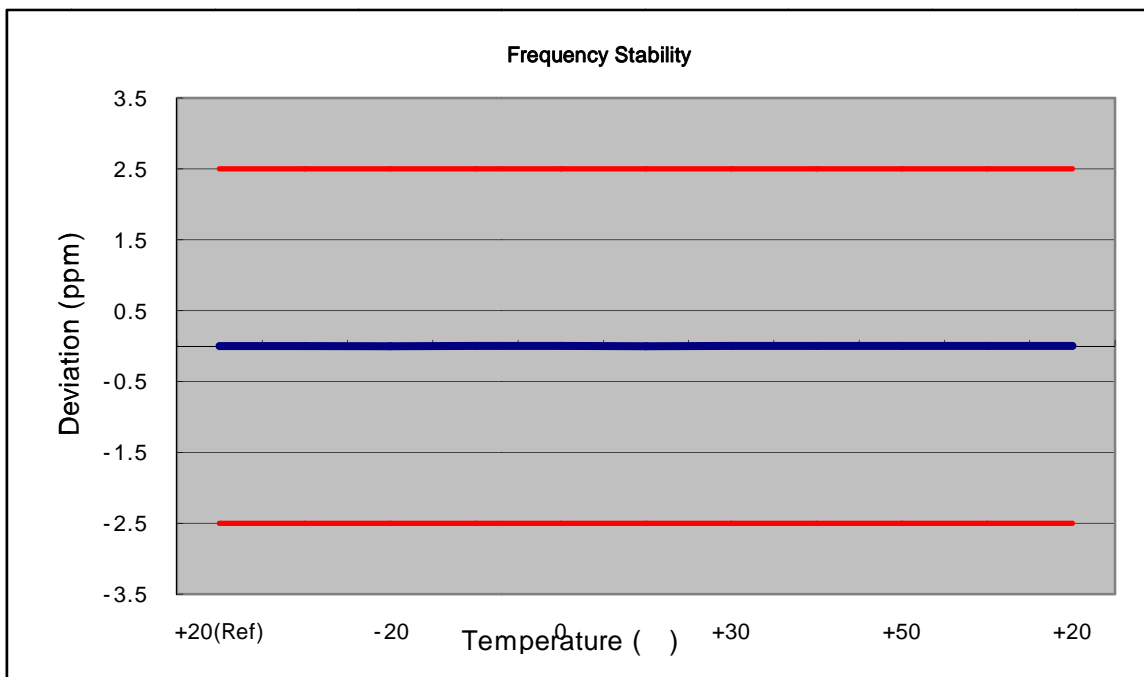

7.9.2 RADIATED SPURIOUS EMISSIONS (PCS Mode)

OPERATING FREQUENCY: 1880,000,000 Hz
 CHANNEL: 600
 REFERENCE VOLTAGE: 12.0 VDC
 DEVIATION LIMIT: -

Voltage (%)	Power (VDC)	Temp. ()	Frequency (Hz)	Frequency Error (Hz)	Deviation (%)	ppm
100%	12.0	+20(Ref)	1879 999 996	0	0.000 000	0.000
100%		-30	1879 999 997	-3.01	0.000 000	-0.002
100%		-20	1879 999 997	-2.89	0.000 000	-0.002
100%		-10	1880 000 003	3.30	0.000 000	0.002
100%		0	1879 999 997	-3.33	0.000 000	-0.002
100%		+10	1879 999 997	-3.12	0.000 000	-0.002
100%		+30	1880 000 005	4.78	0.000 000	0.003
100%		+40	1879 999 996	-3.65	0.000 000	-0.002
100%		+50	1879 999 997	-2.77	0.000 000	-0.001
115%	13.8	+20	1879 999 997	-2.86	0.000 000	-0.002
Batt. Endpoint	10.2	+20	1879 999 997	-3.42	0.000 000	-0.002

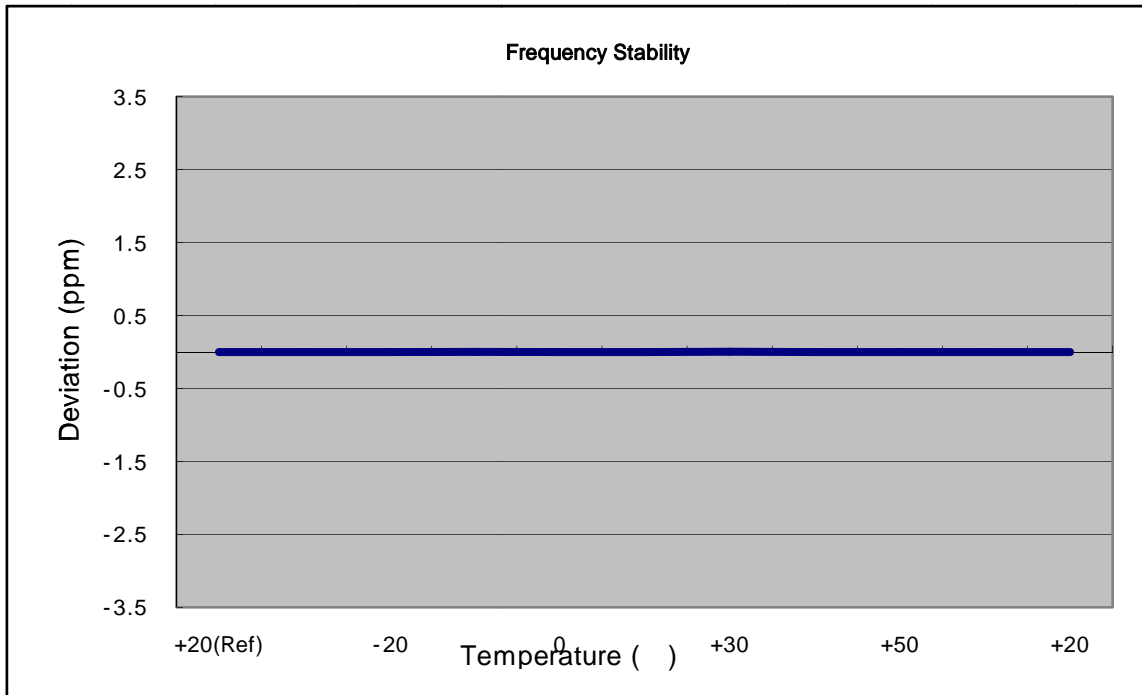

8. TEST PLOTS

■ CDMA MODE (1013 CH.) Occupied Bandwidth

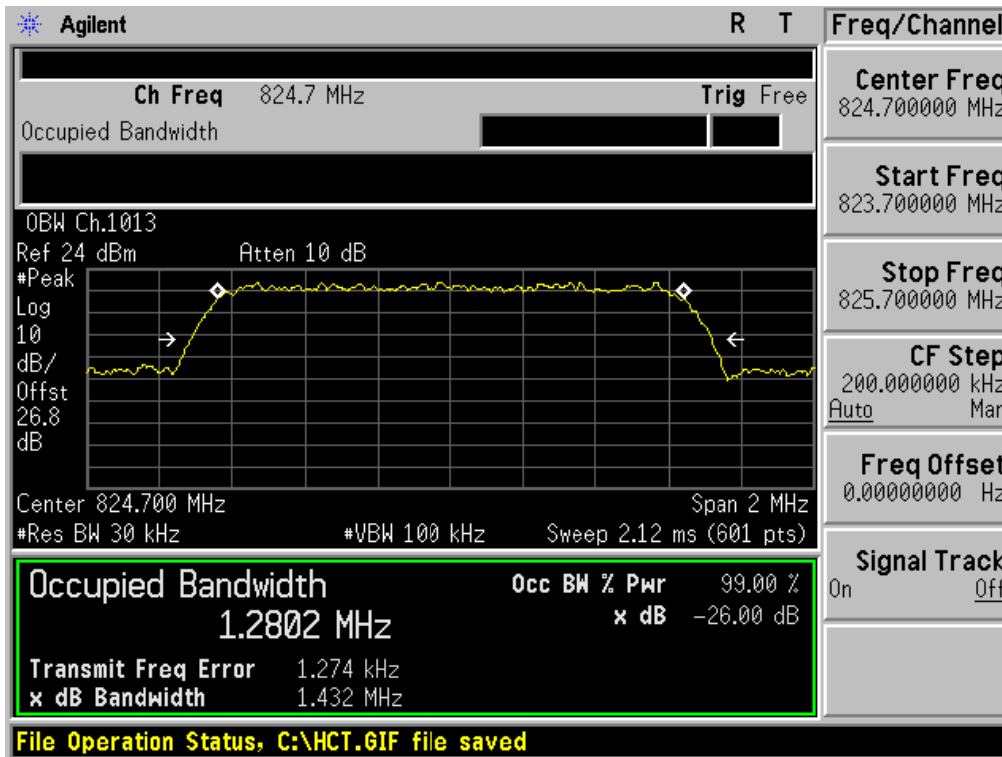

■ CDMA MODE (384 CH.) Occupied Bandwidth

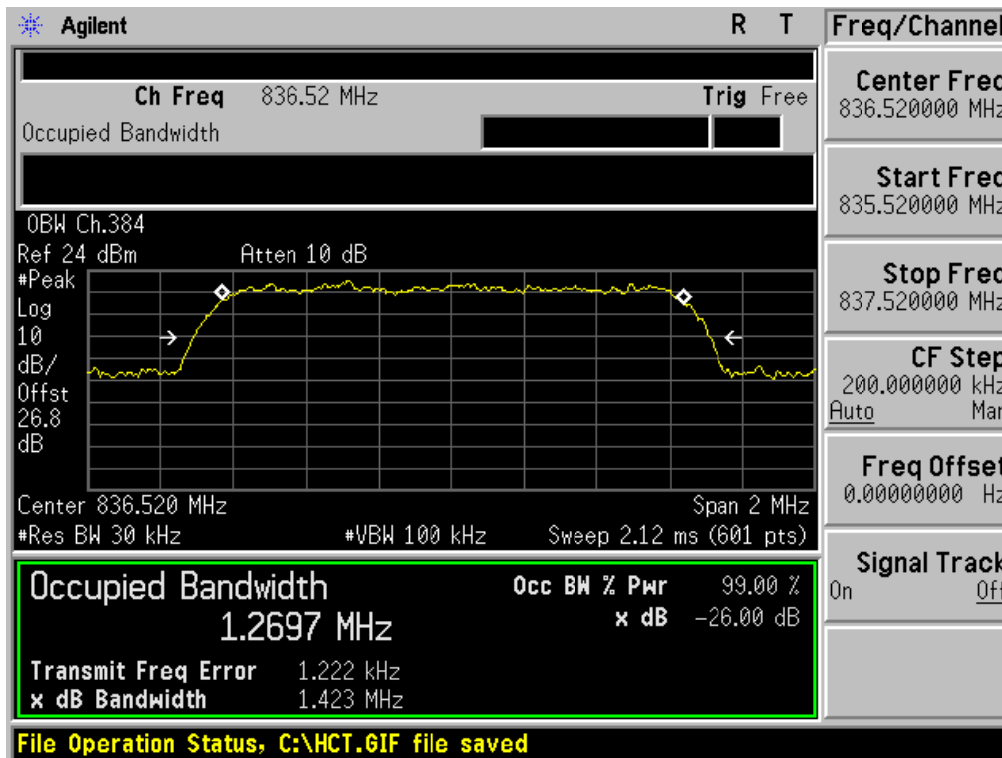

■ CDMA MODE (777 CH.) Occupied Bandwidth

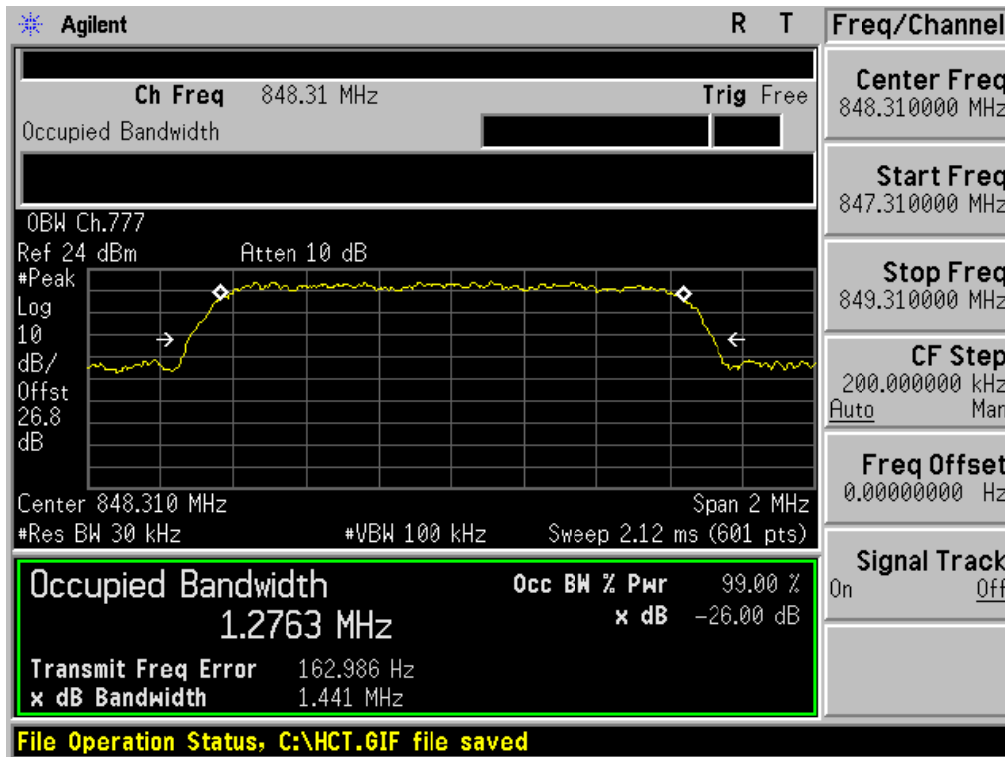

■ CDMA EVDO MODE (1013 CH.) Occupied Bandwidth

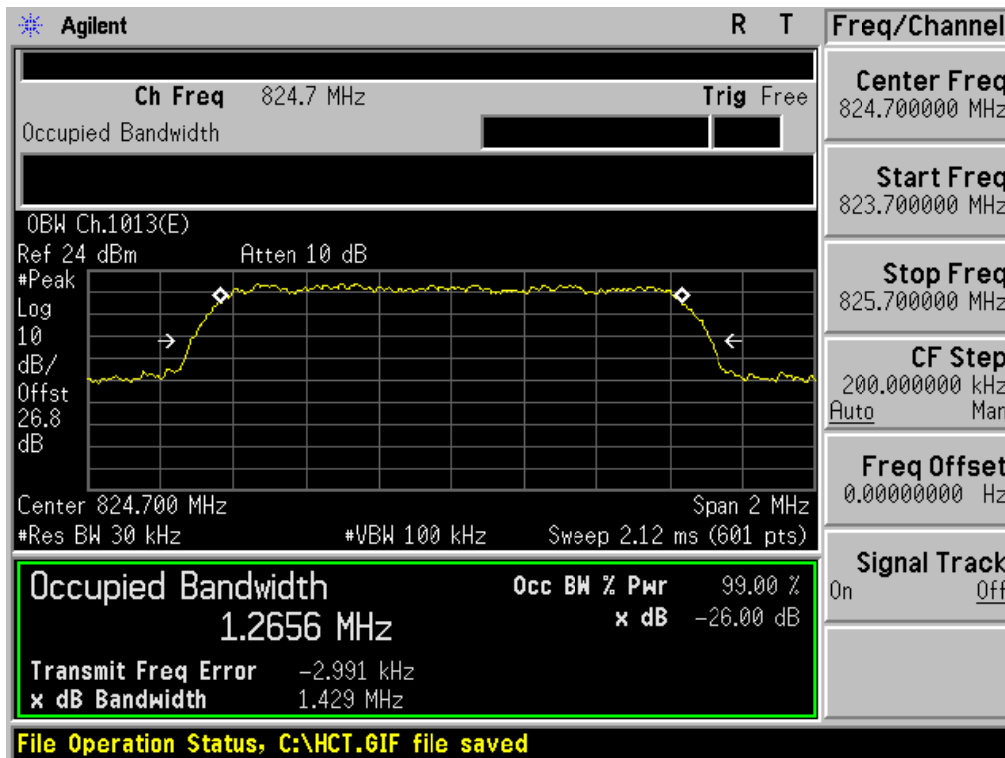

■ CDMA EVDO MODE (384 CH.) Occupied Bandwidth

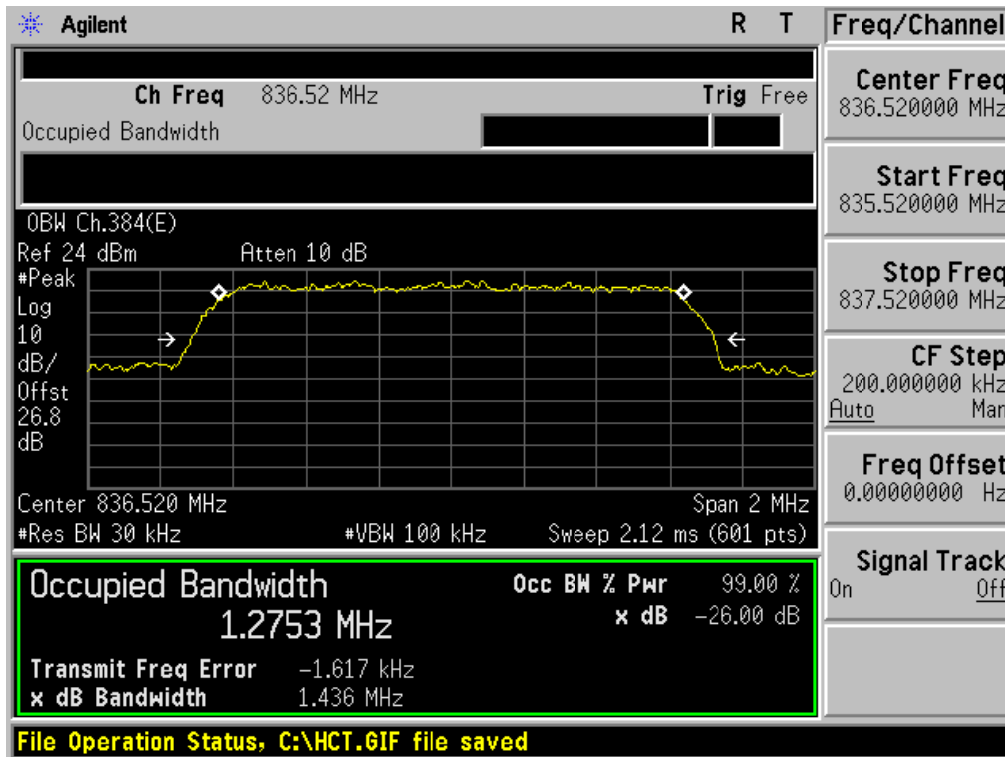

■ CDMA EVDO MODE (777 CH.) Occupied Bandwidth

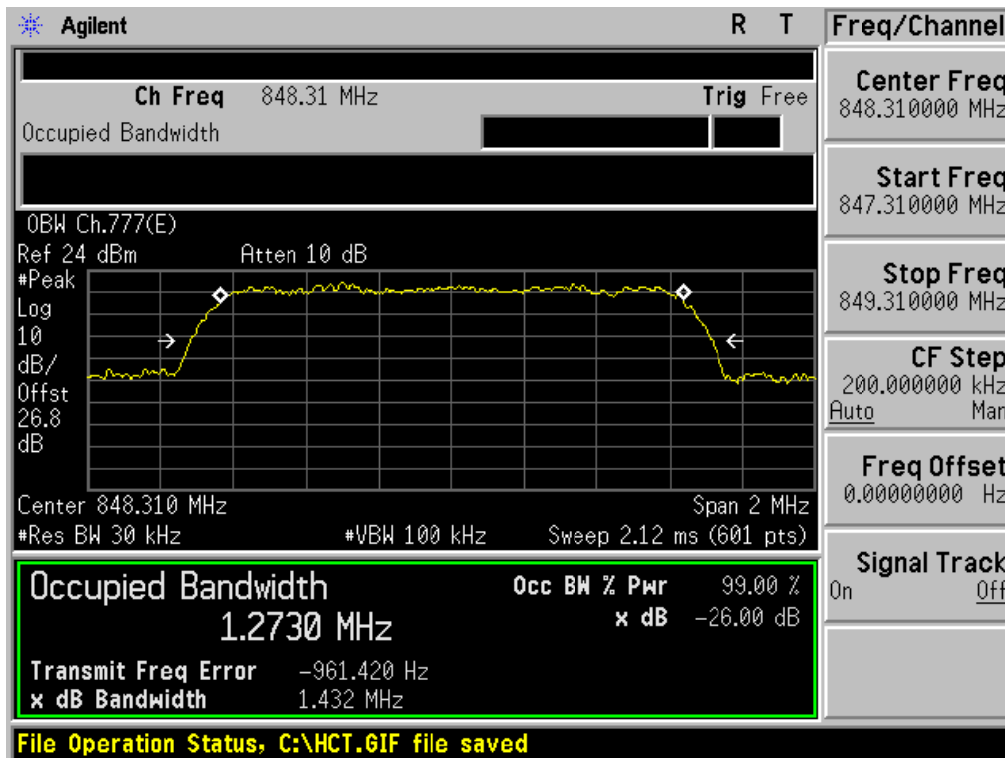

■ CDMA EVDO_A MODE (1013 CH.) Occupied Bandwidth

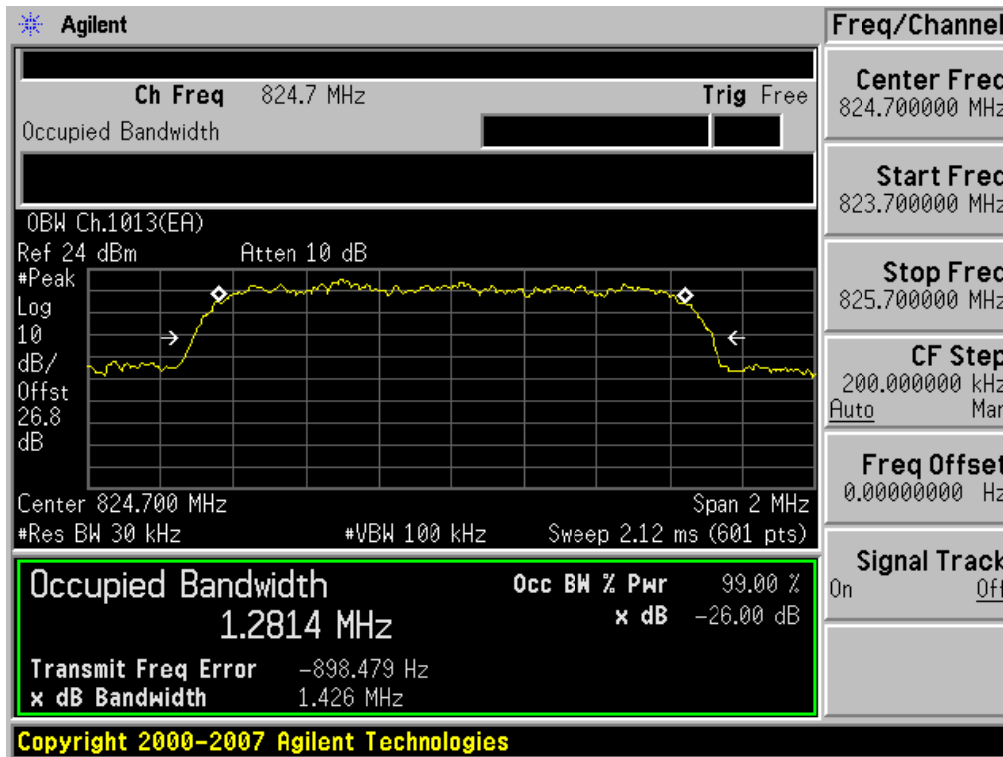

■ CDMA EVDO_A MODE (384 CH.) Occupied Bandwidth

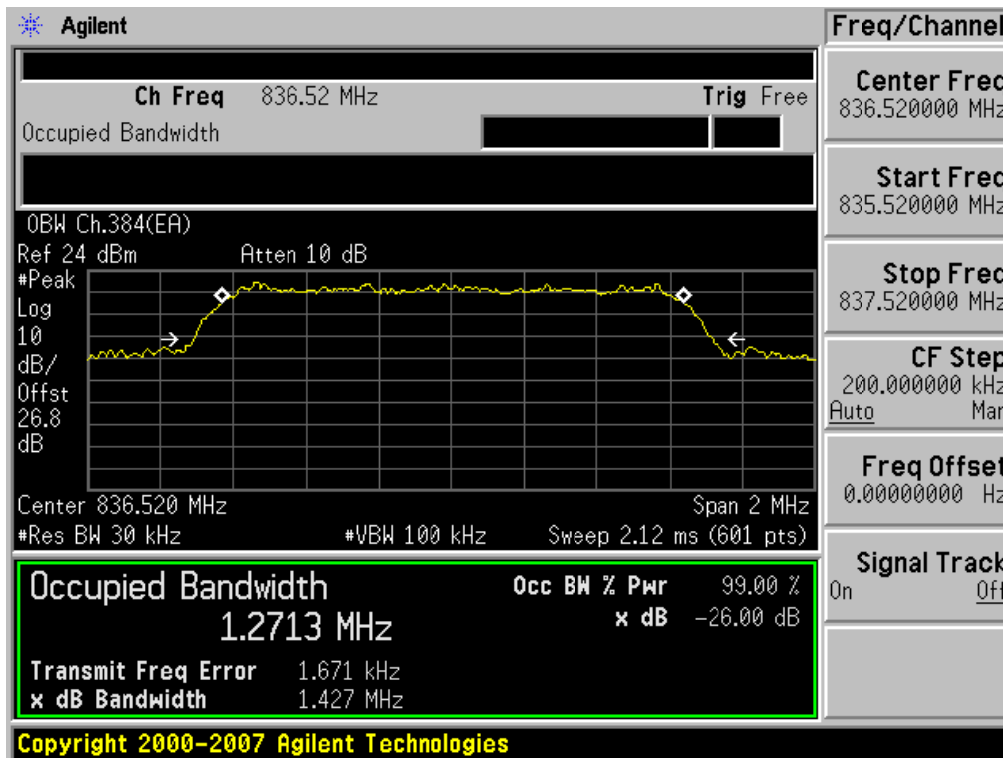

■ CDMA EVDO_A MODE (777 CH.) Occupied Bandwidth

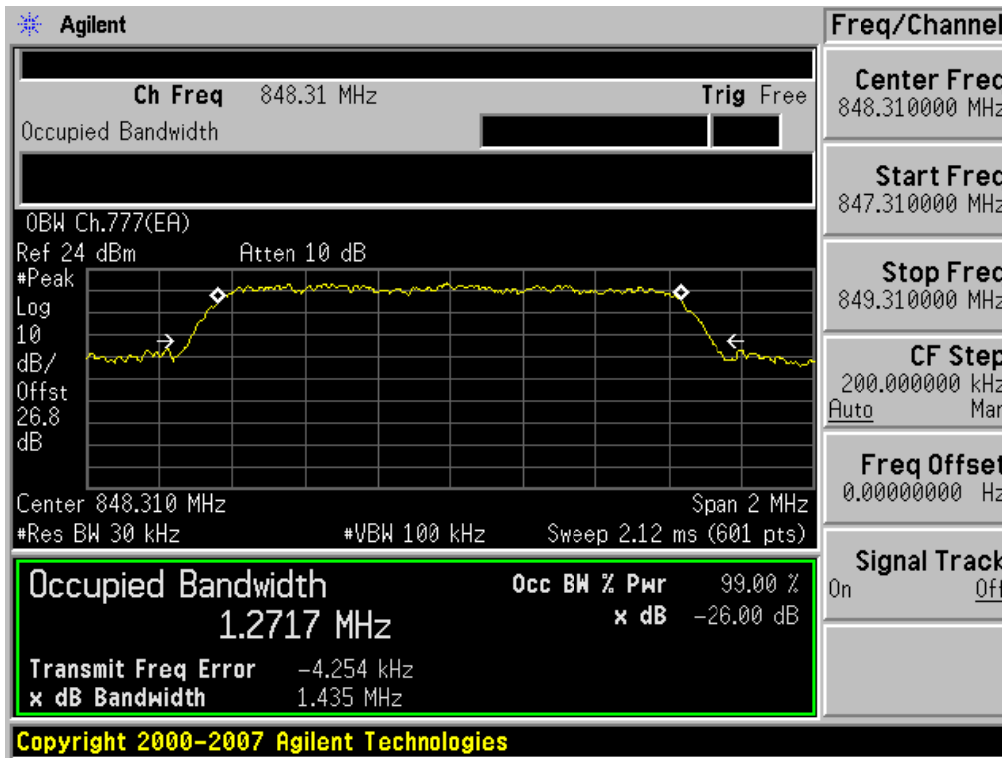

■ PCS MODE (25 CH.) Occupied Bandwidth

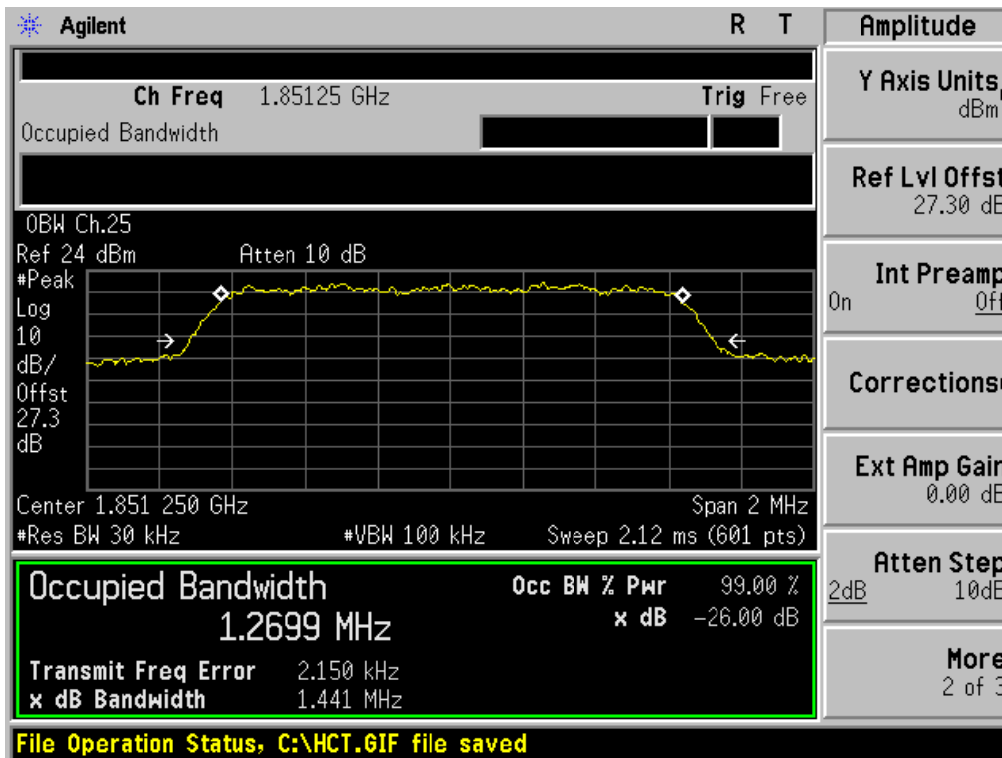

■ PCS MODE (600 CH.) Occupied Bandwidth

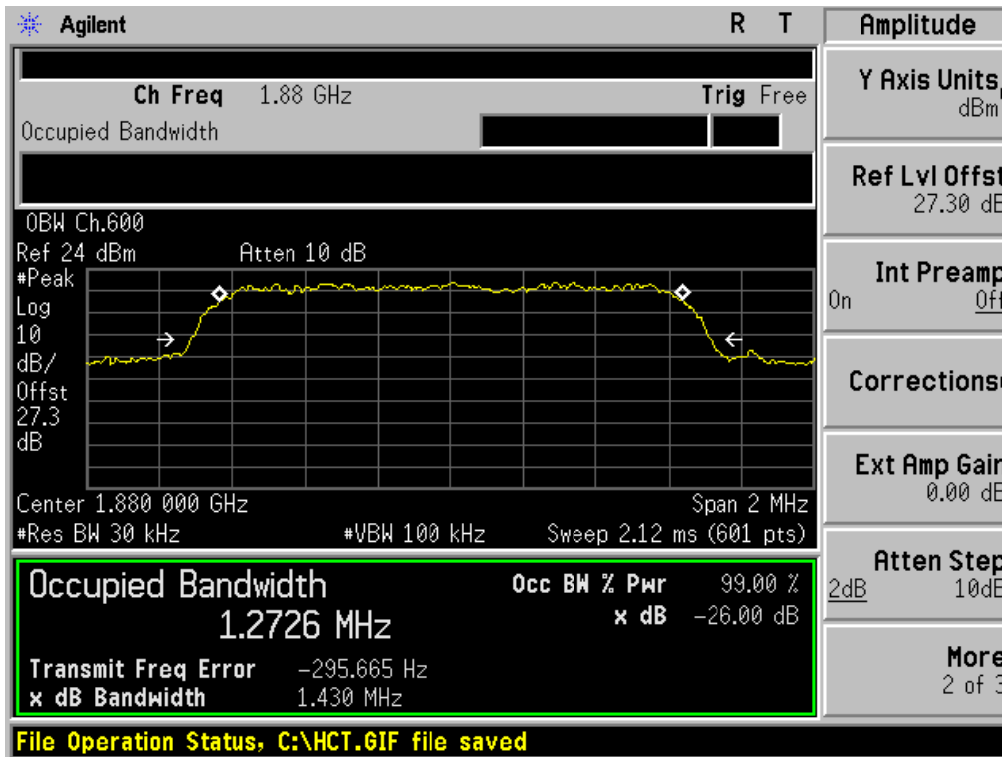

■ PCS MODE (1175 CH.) Occupied Bandwidth

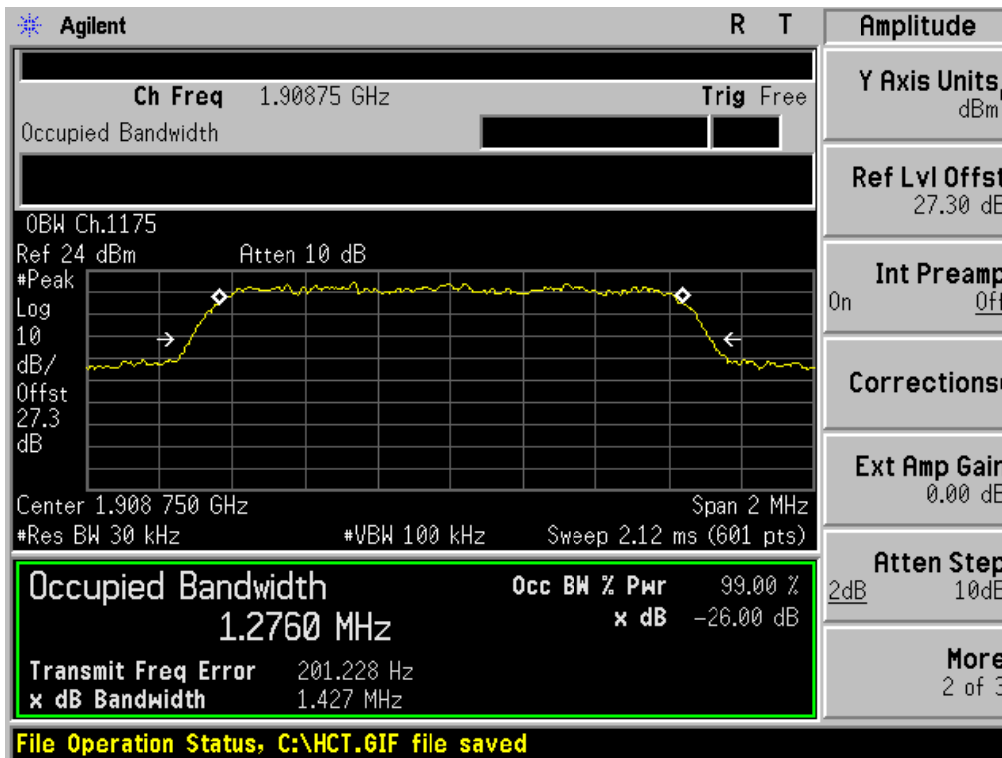

■ PCS EVDO MODE (25 CH.) Occupied Bandwidth

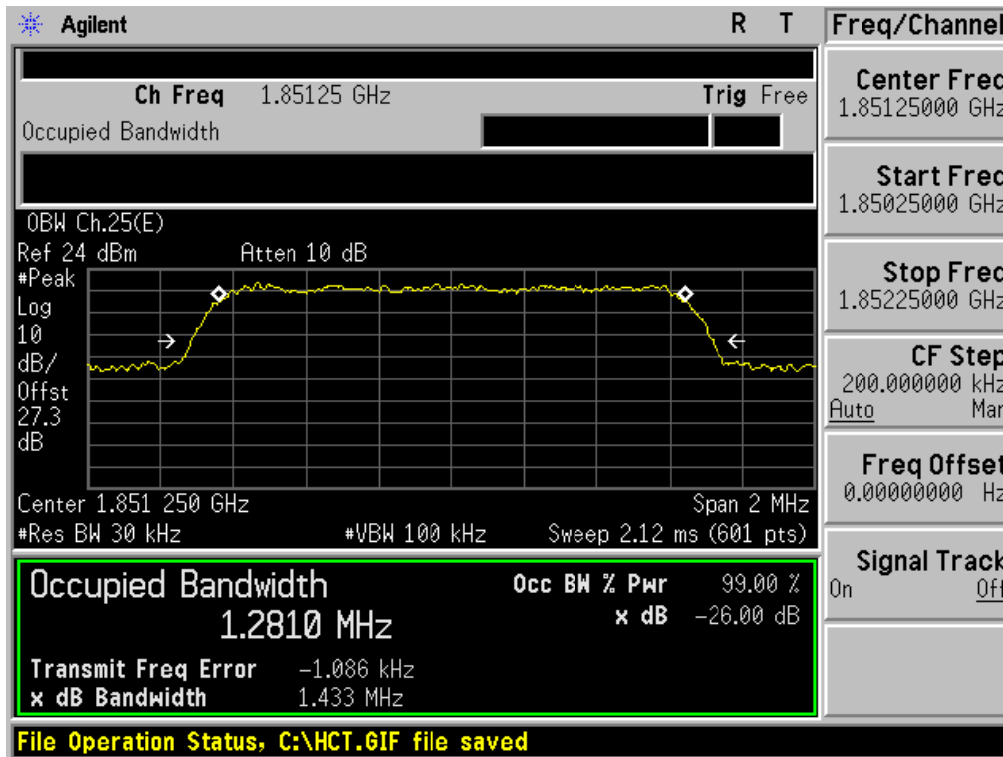

■ PCS EVDO MODE (600 CH.) Occupied Bandwidth

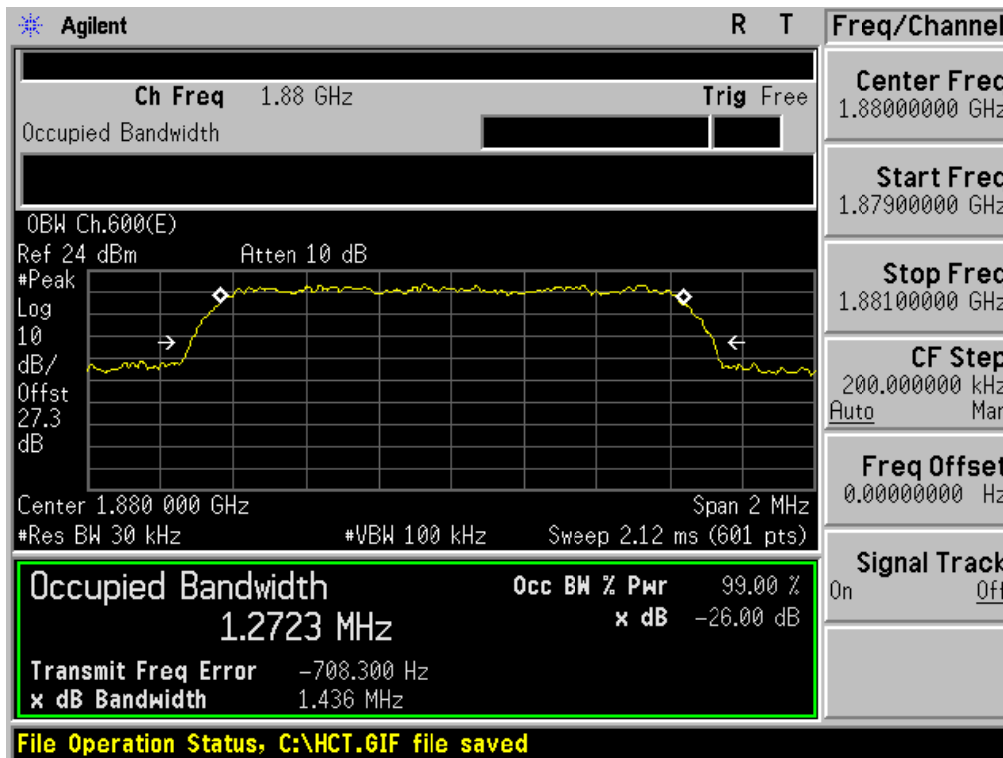

■ PCS EVDO MODE (1175 CH.) Occupied Bandwidth

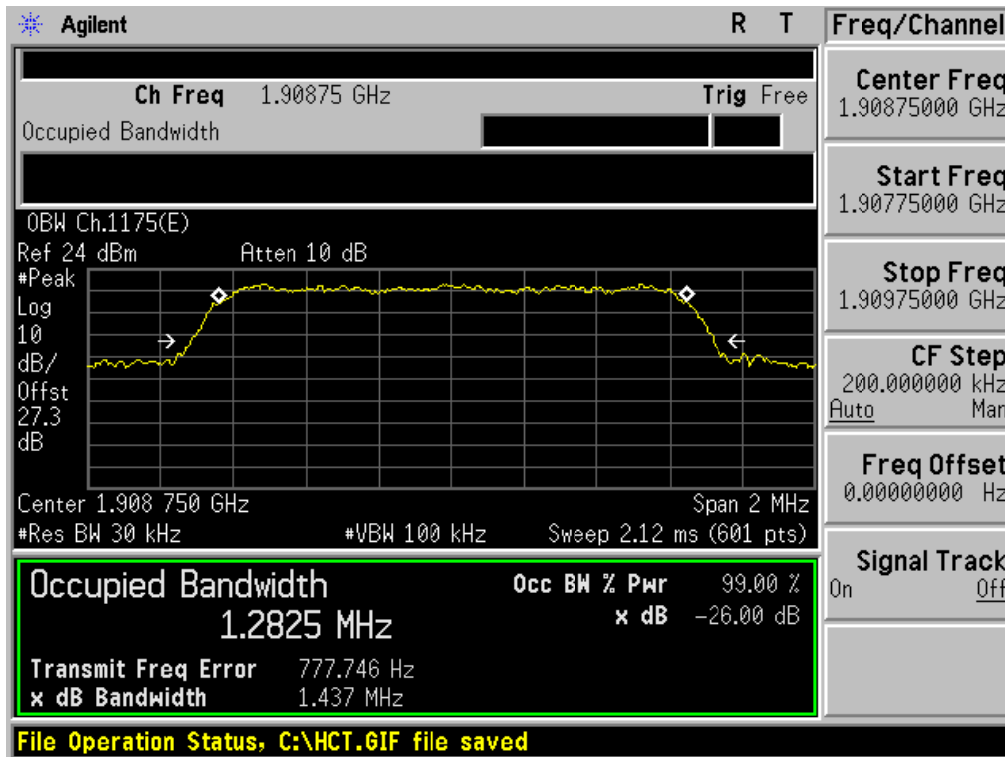

■ PCS EVDO_A MODE (25 CH.) Occupied Bandwidth

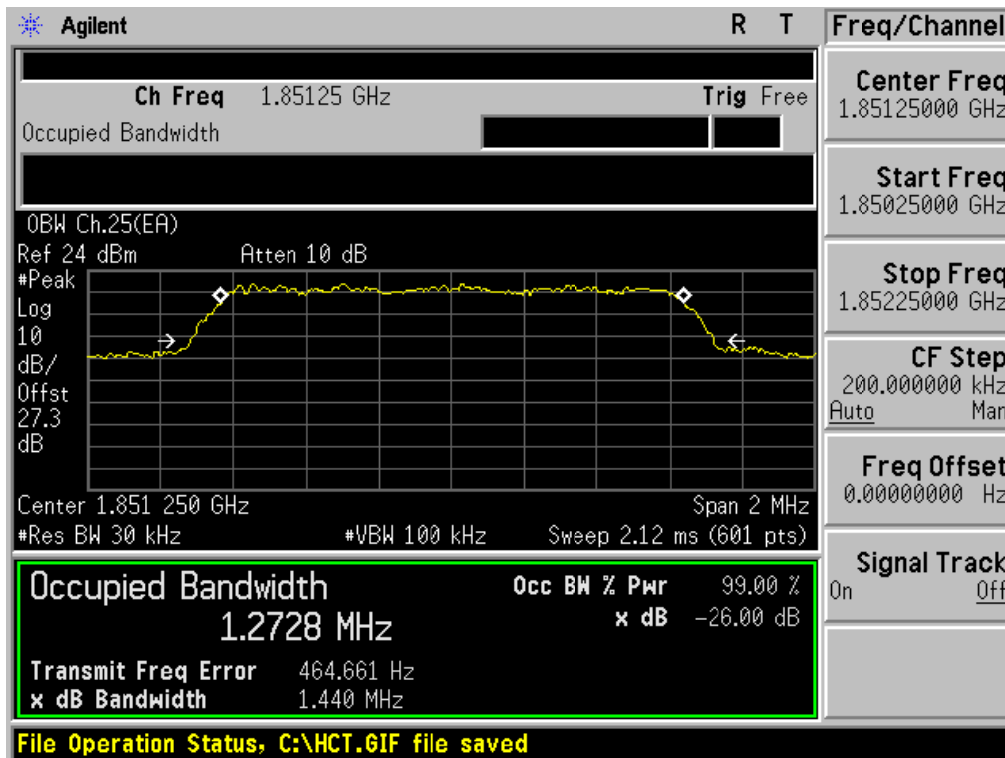

■ PCS EVDO_A MODE (600 CH.) Occupied Bandwidth

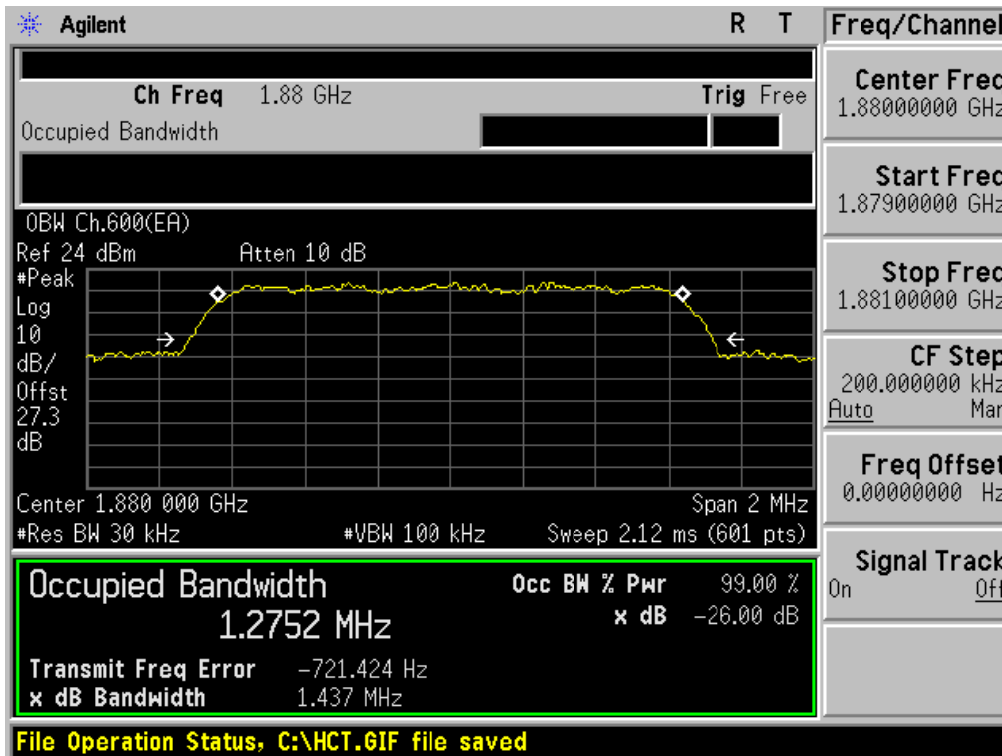

■ PCS EVDO_A MODE (1175 CH.) Occupied Bandwidth

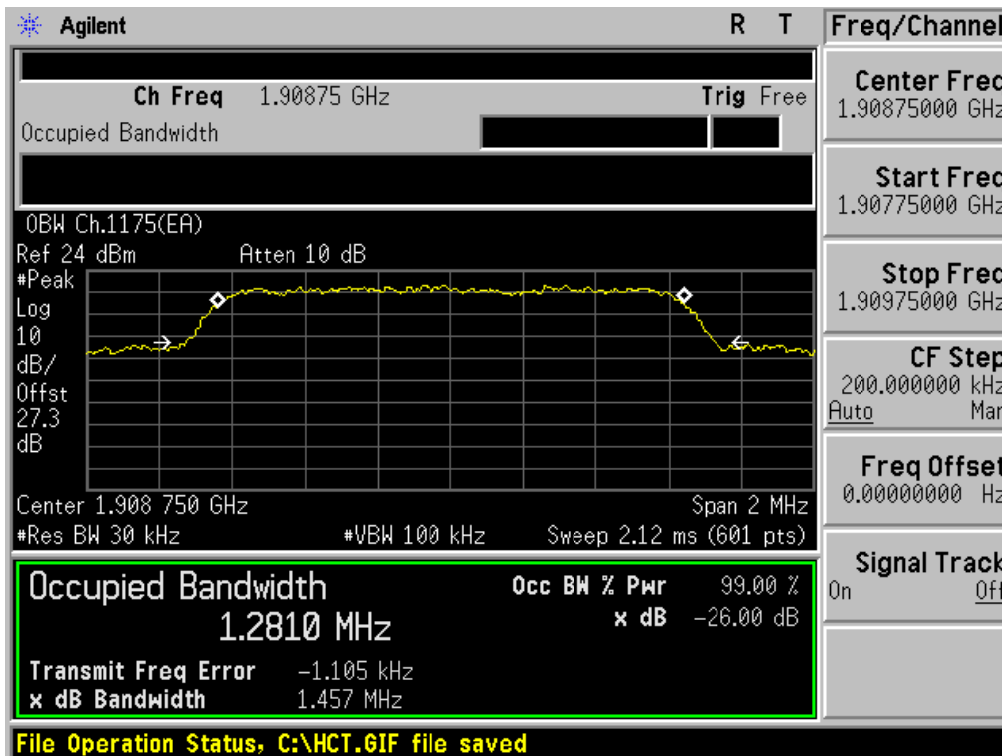

■ PCS CDMA MODE (600 CH.) Peak-to-Average Ratio

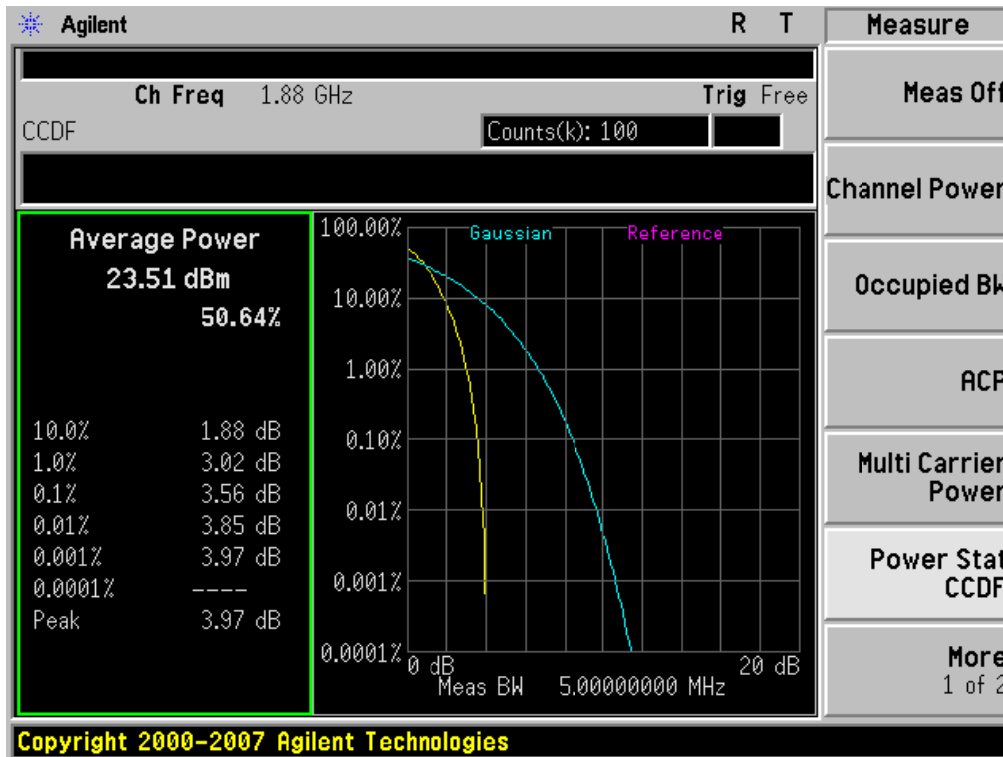

■ PCS CDMA EVDO MODE (600 CH.) Peak-to-Average Ratio

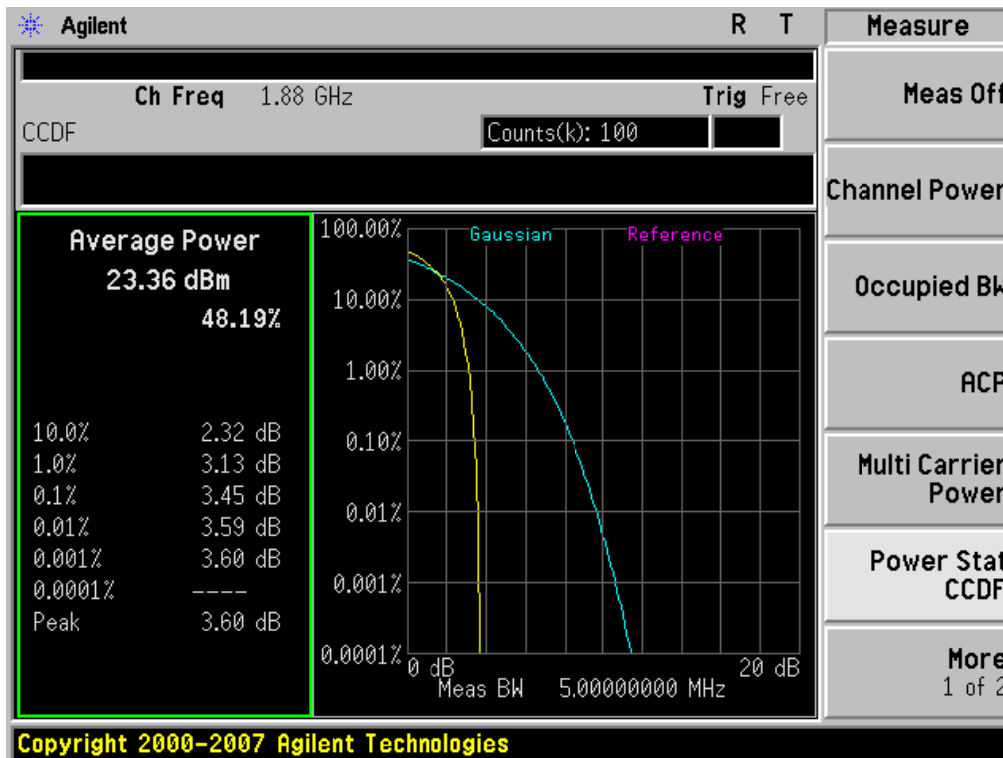

■ PCS CDMA EVDO_A MODE (600 CH.) Peak-to-Average Ratio

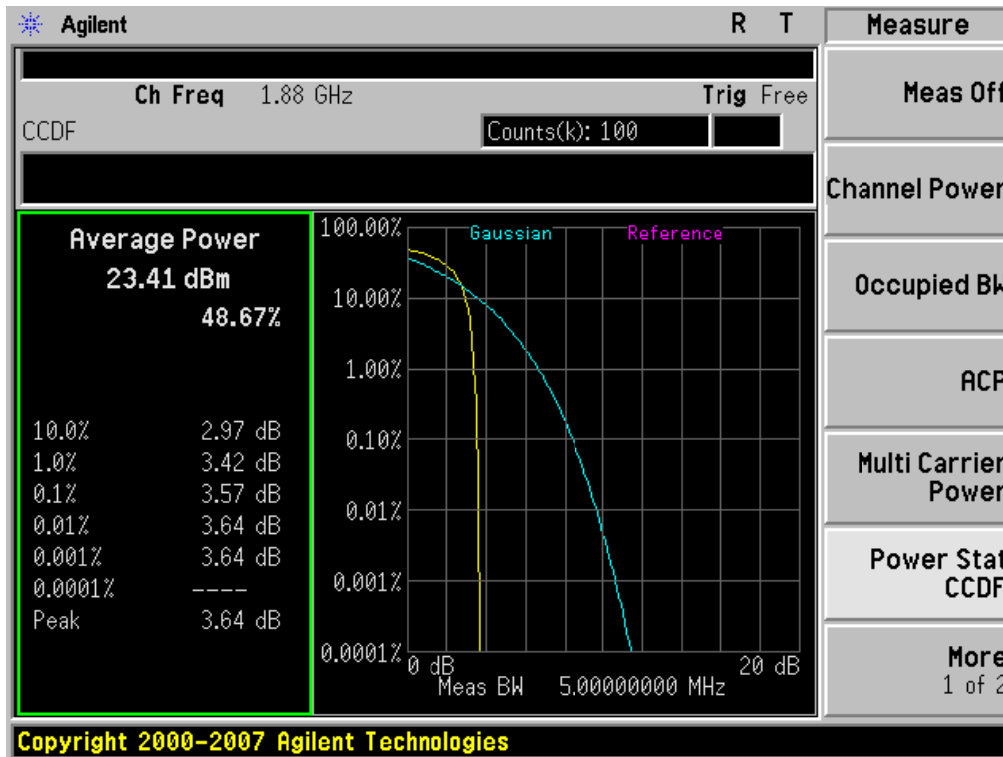

■ CDMA MODE (1013 CH.) Block Edge

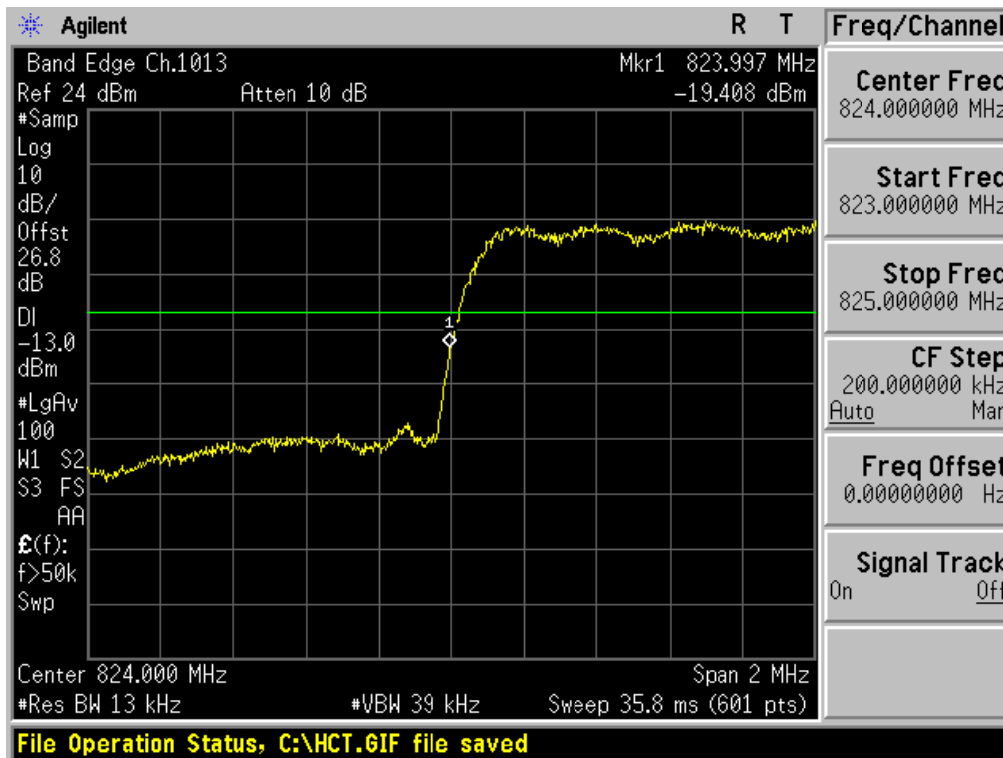

■ CDMA MODE (777 CH.) Block Edge

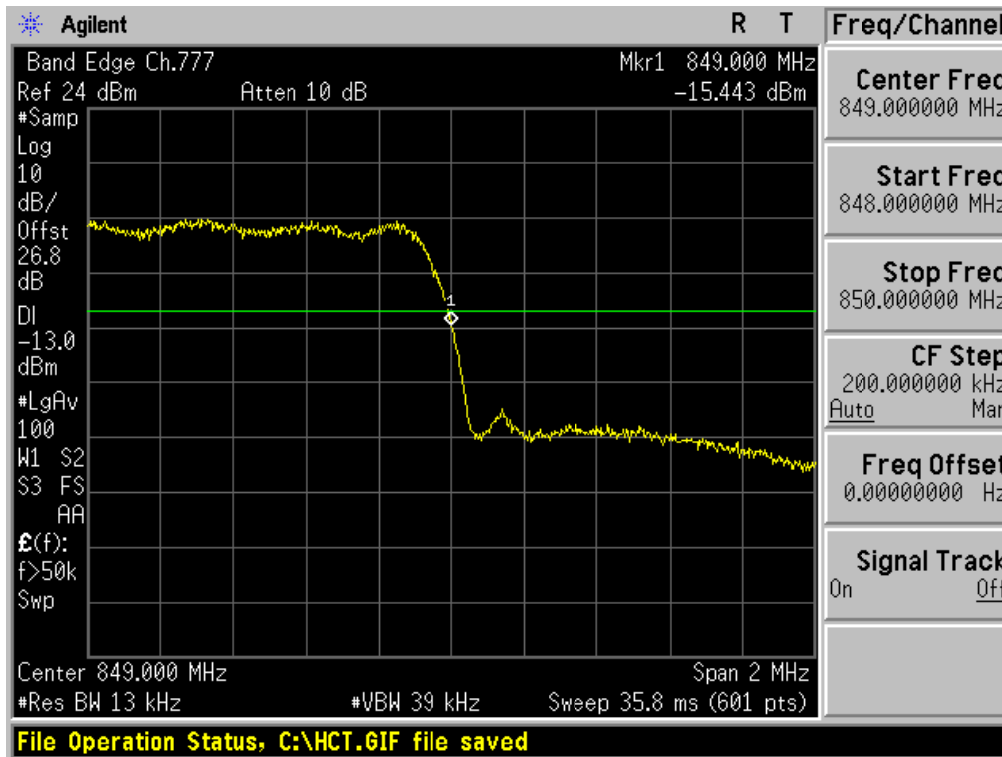

■ CDMA EVDO MODE (1013 CH.) Block Edge

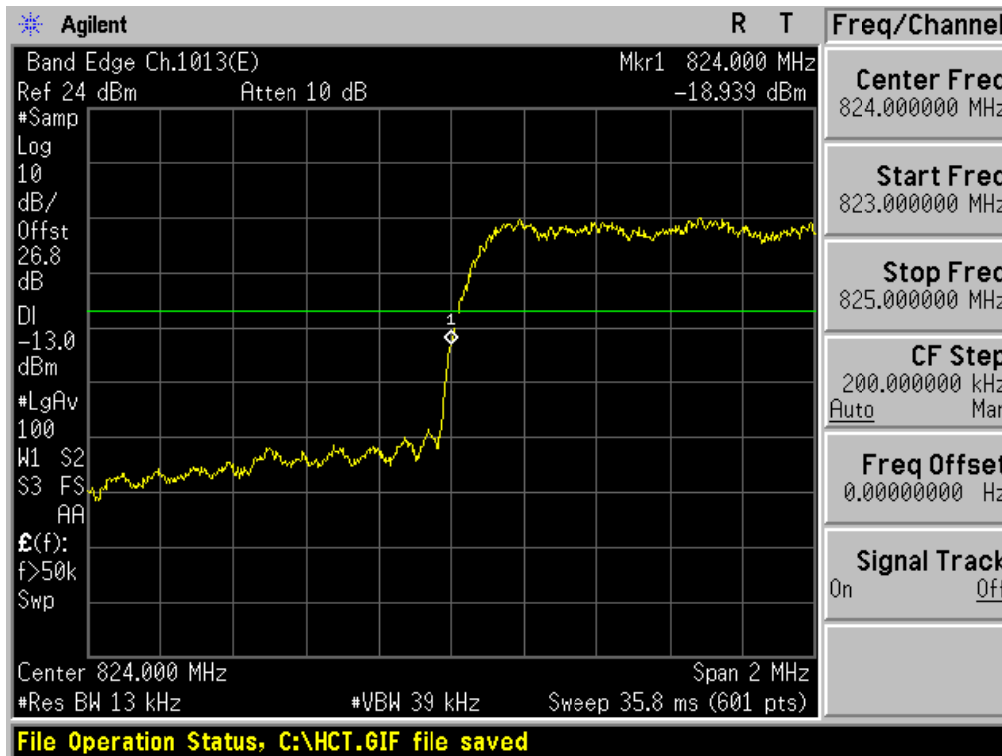

■ CDMA EVDO MODE (777 CH.) Block Edge

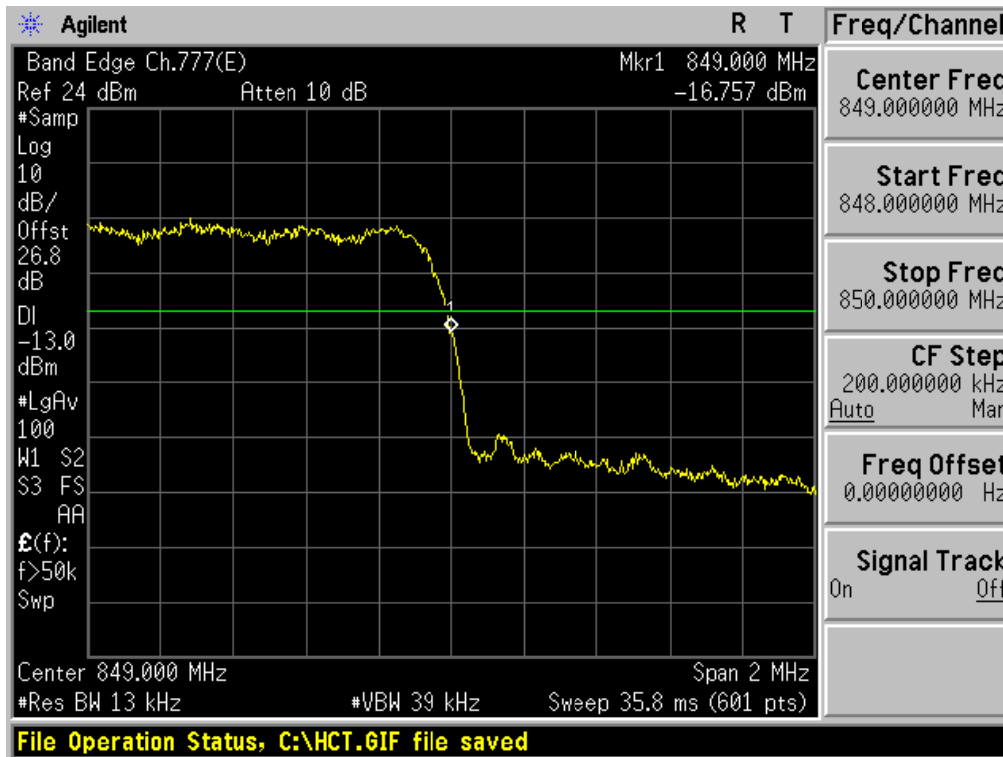

■ CDMA EVDO_A MODE (1013 CH.) Block Edge

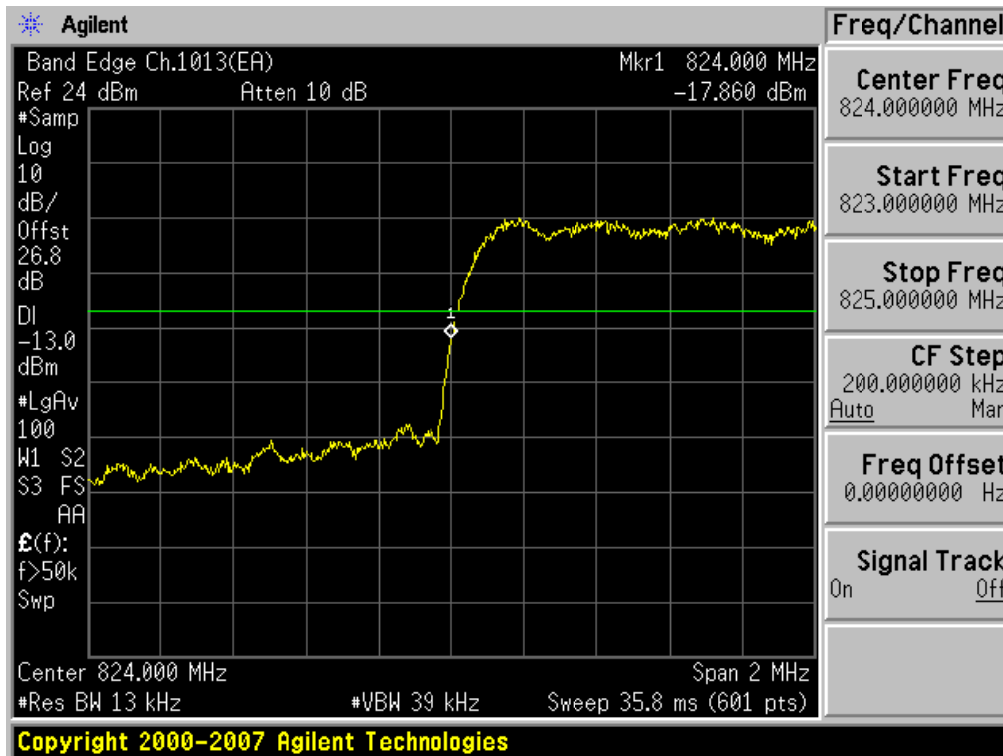

■ CDMA EVDO_A MODE (777 CH.) Block Edge

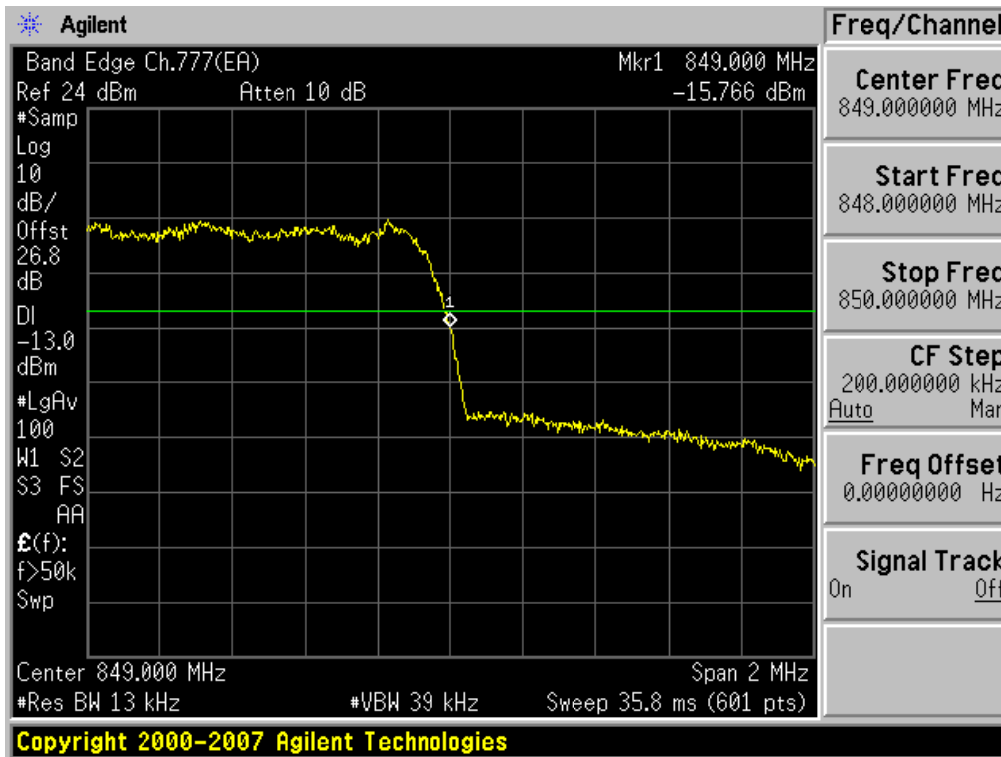

■ CDMA MODE (1013 CH.) 4 MHz Span

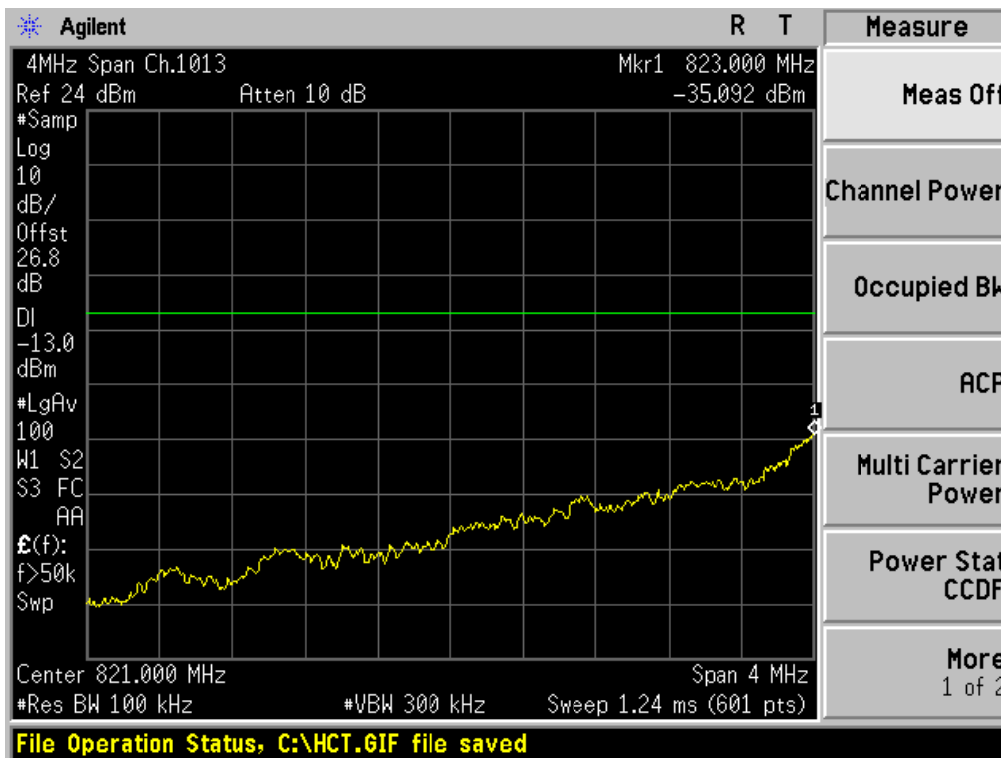

■ CDMA MODE (777 CH.) 4 MHz Span

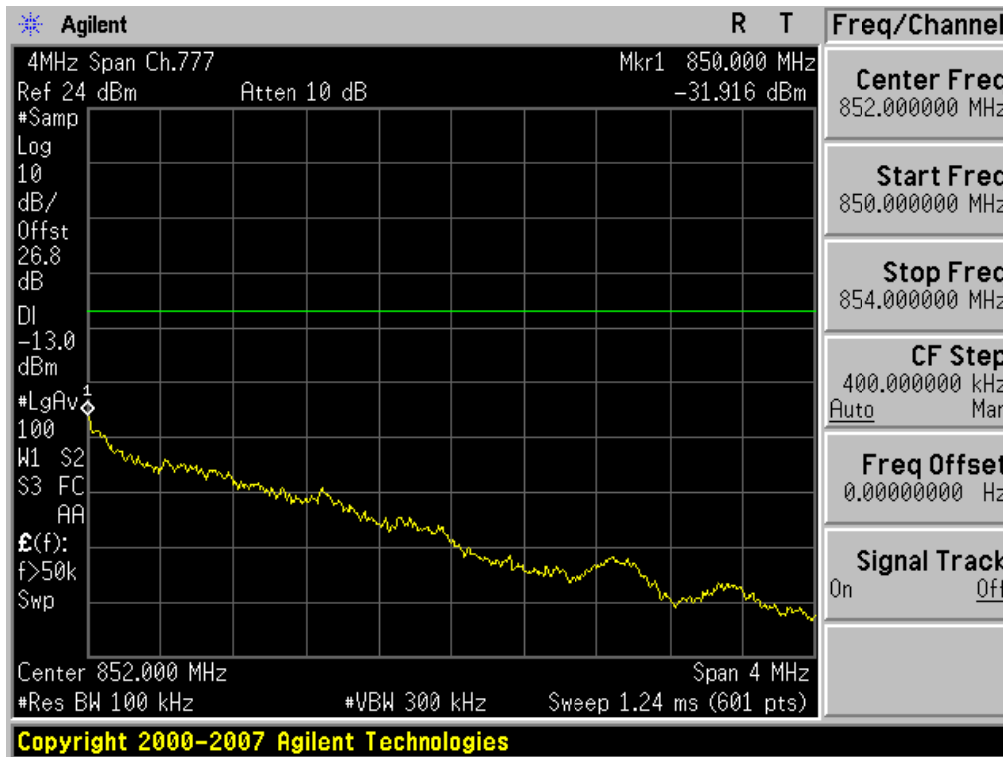

■ CDMA EVDO MODE (1013 CH.) 4 MHz Span

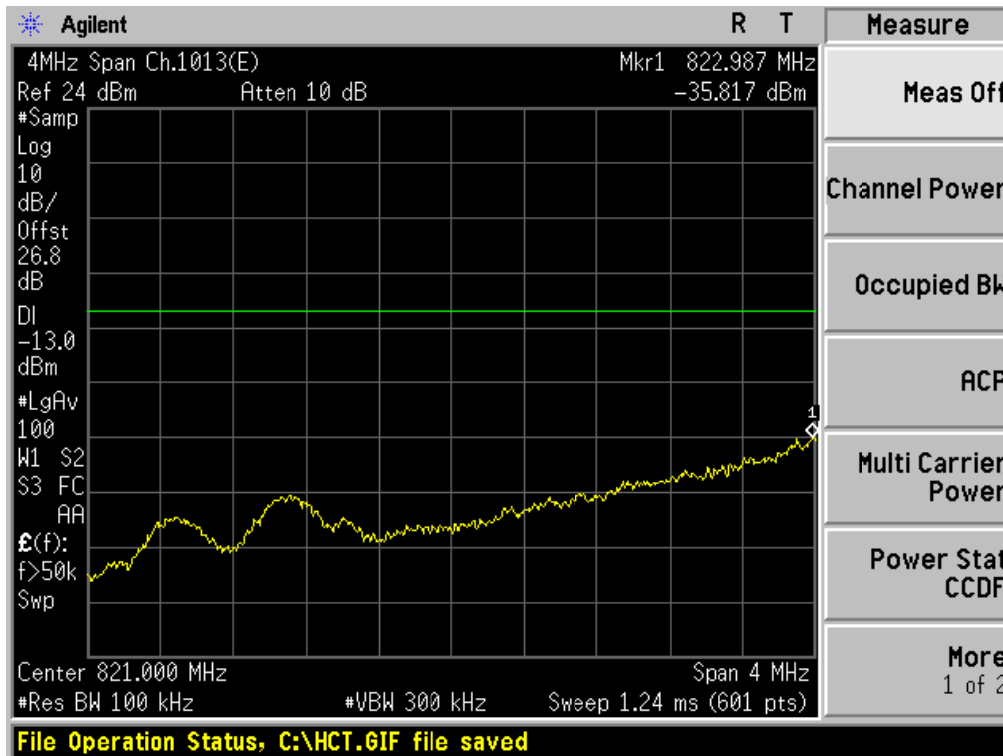

■ CDMA EVDO MODE (777 CH.) 4 MHz Span

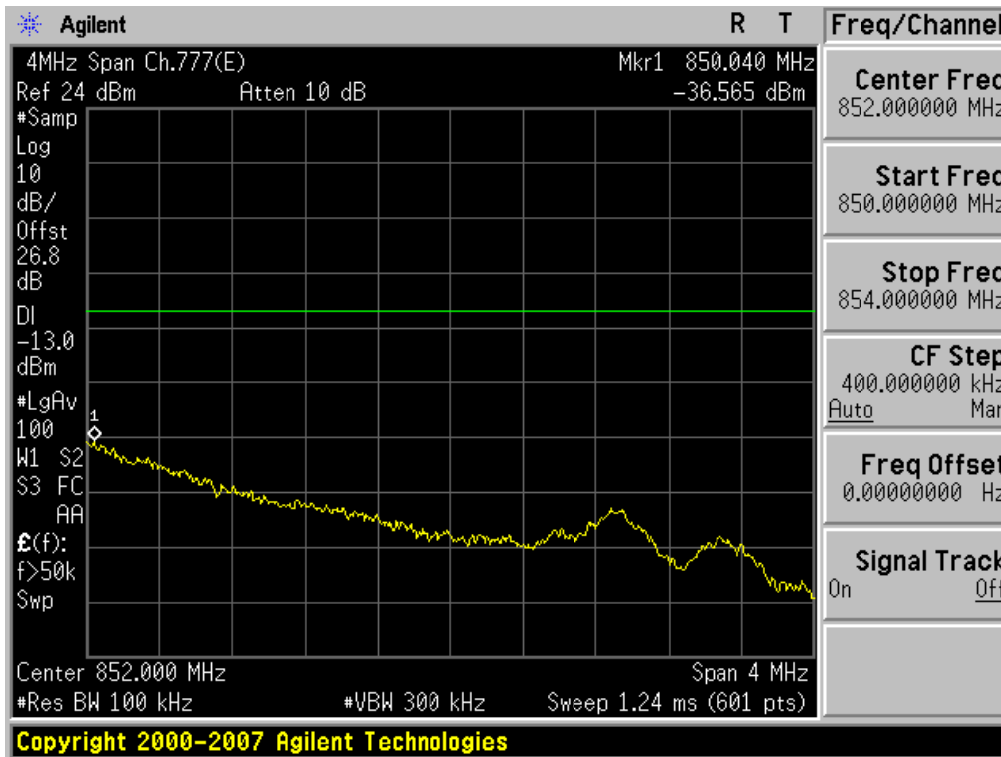

■ CDMA EVDO_A MODE (1013 CH.) 4 MHz Span

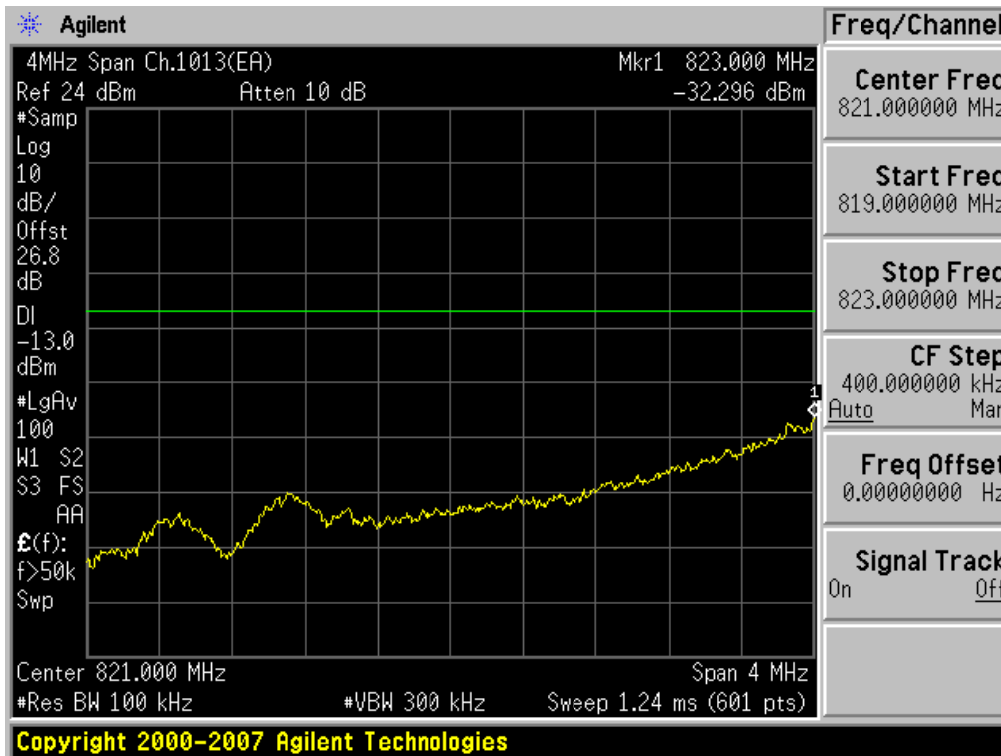

■ CDMA EVDO_A MODE (777 CH.) 4 MHz Span

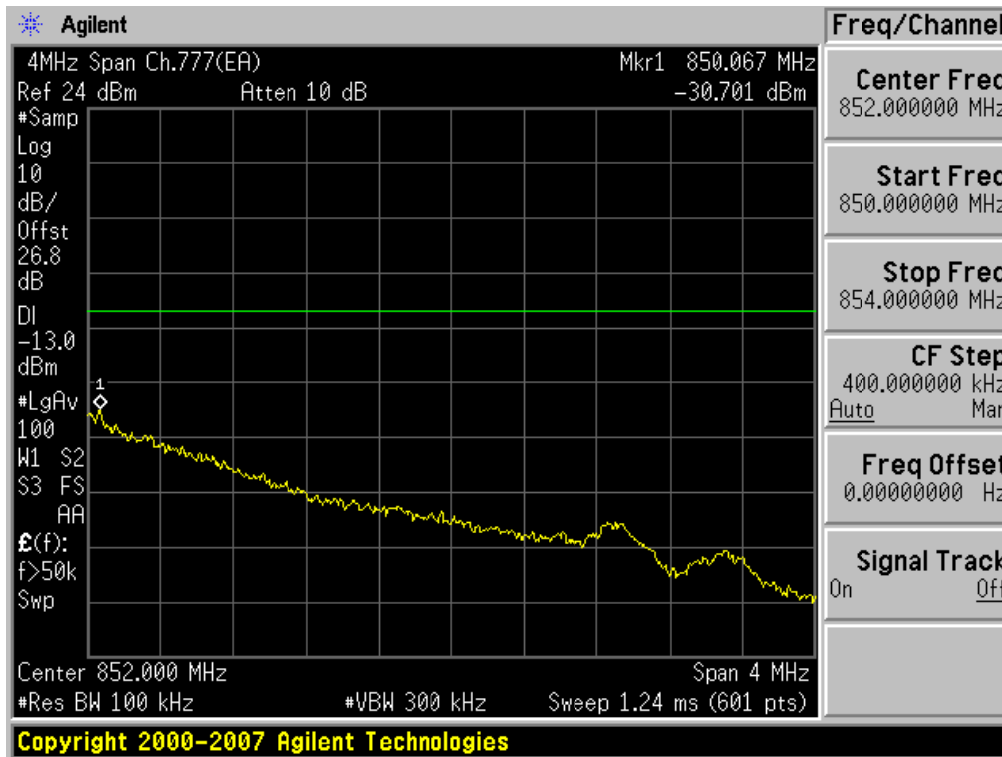

■ PCS MODE (25 CH.) Block Edge

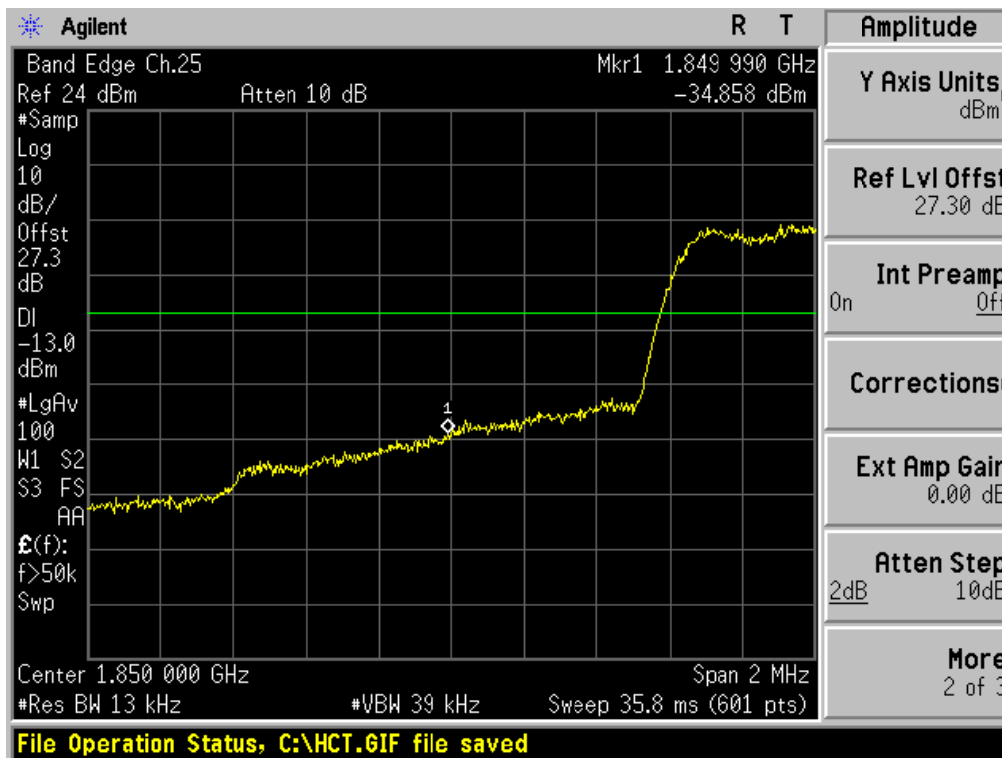

■ PCS MODE (1175 CH.) Block Edge

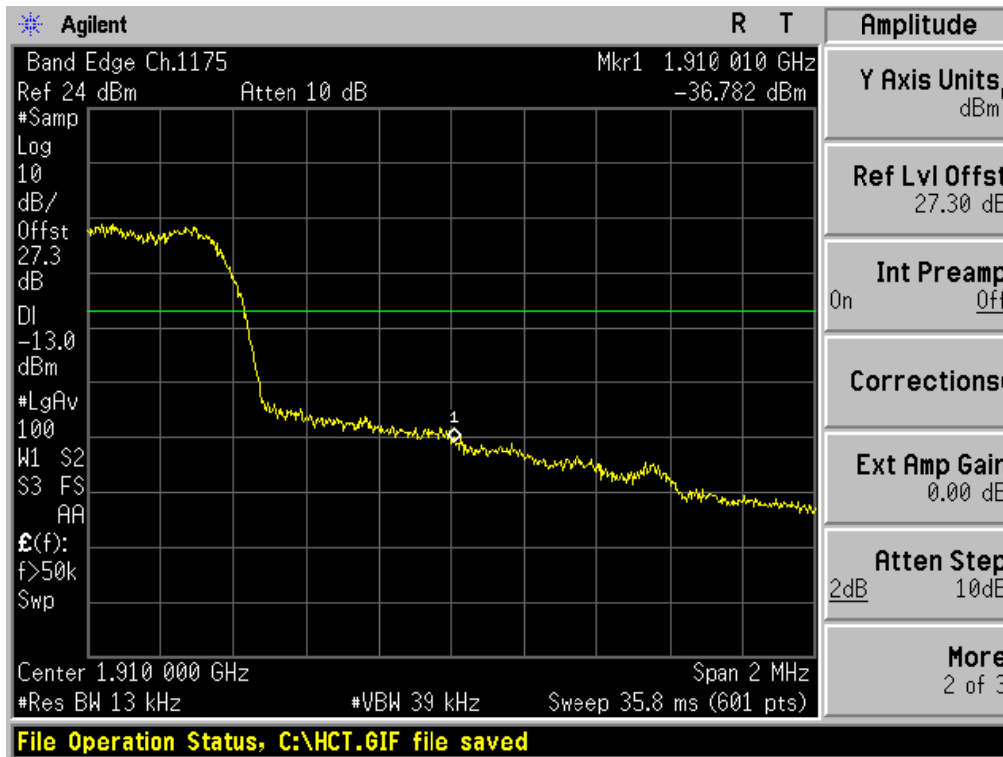

■ PCS EVDO MODE (25 CH.) Block Edge

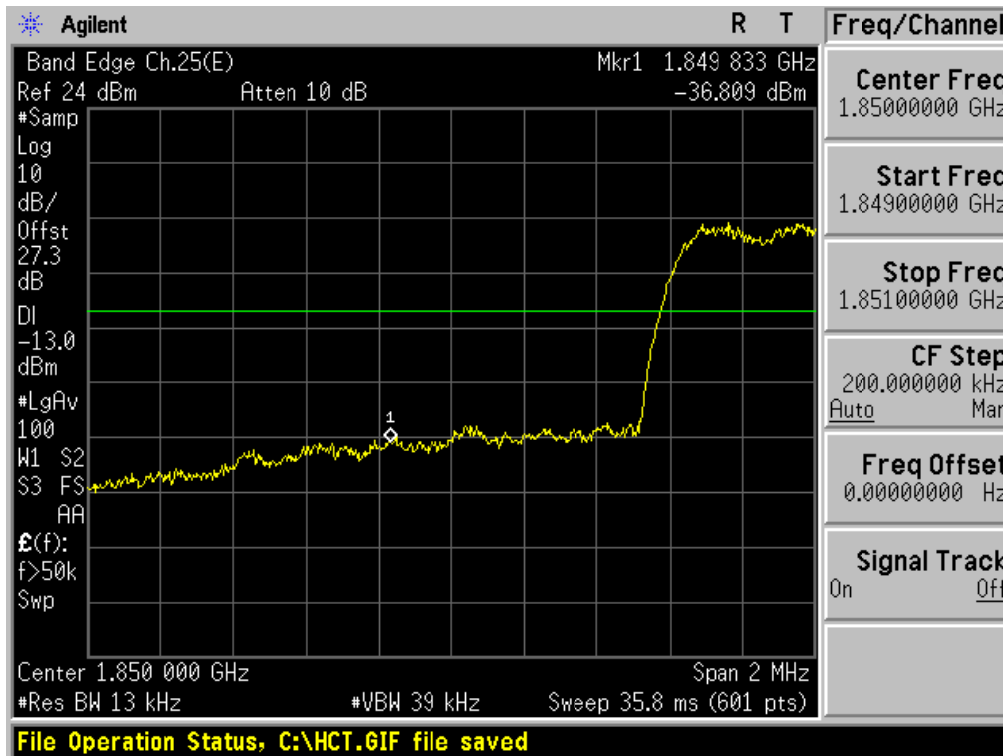

■ PCS EVDO MODE (1175 CH.) Block Edge

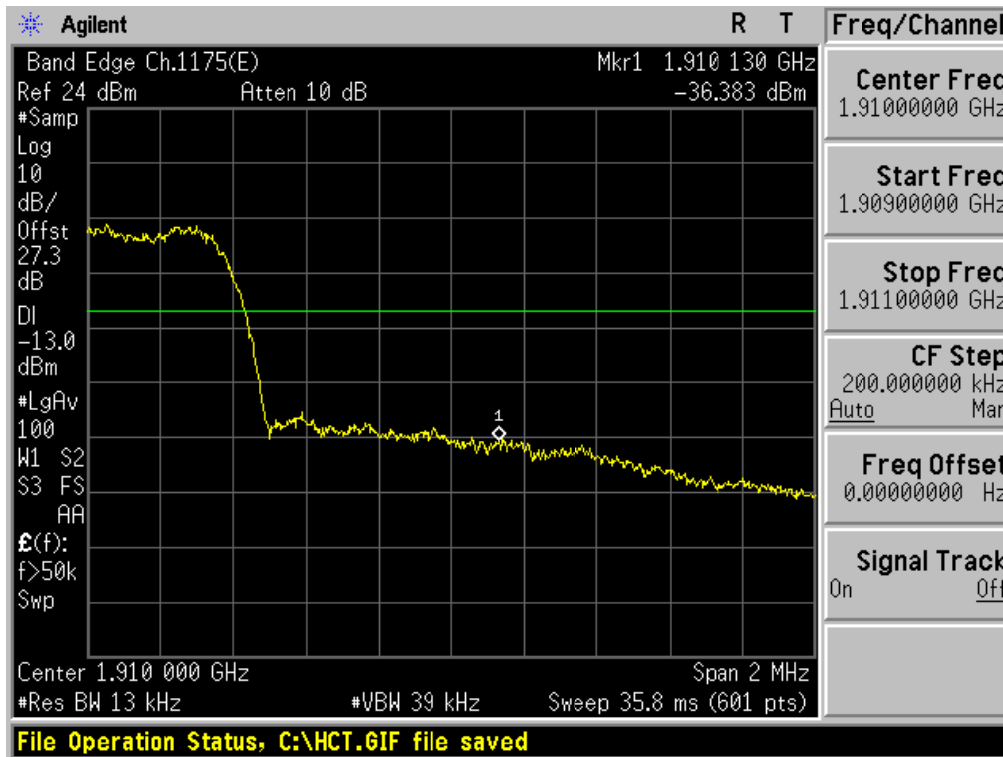

■ PCS EVDO_A MODE (25 CH.) Block Edge

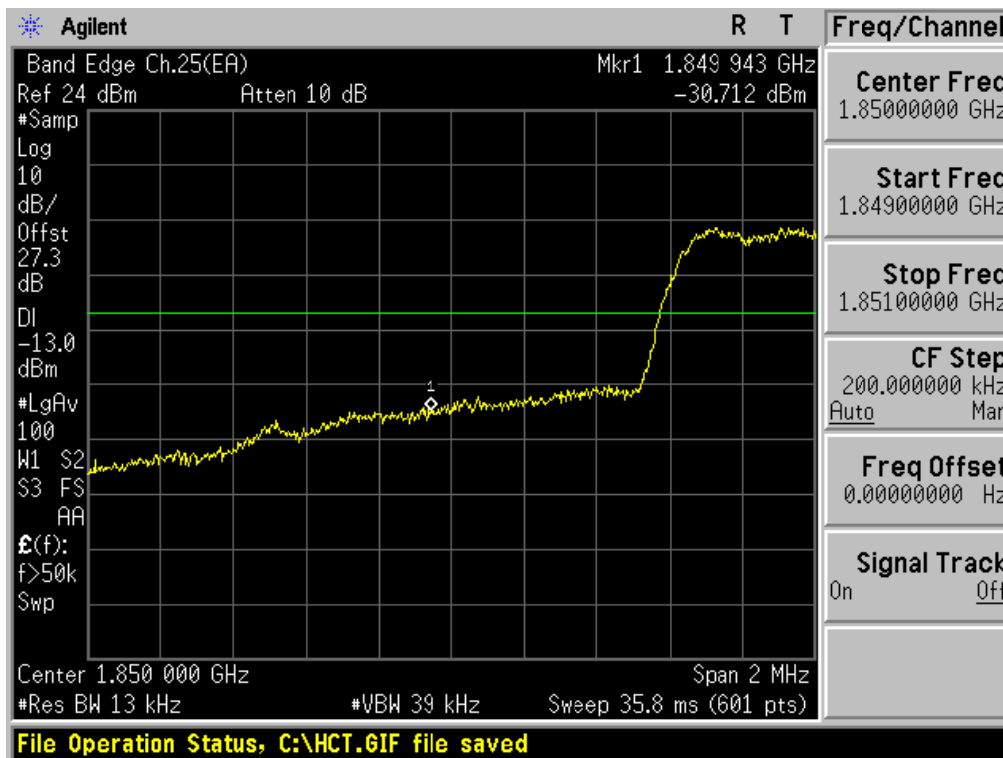

■ PCS EVDO_A MODE (1175 CH.) Block Edge

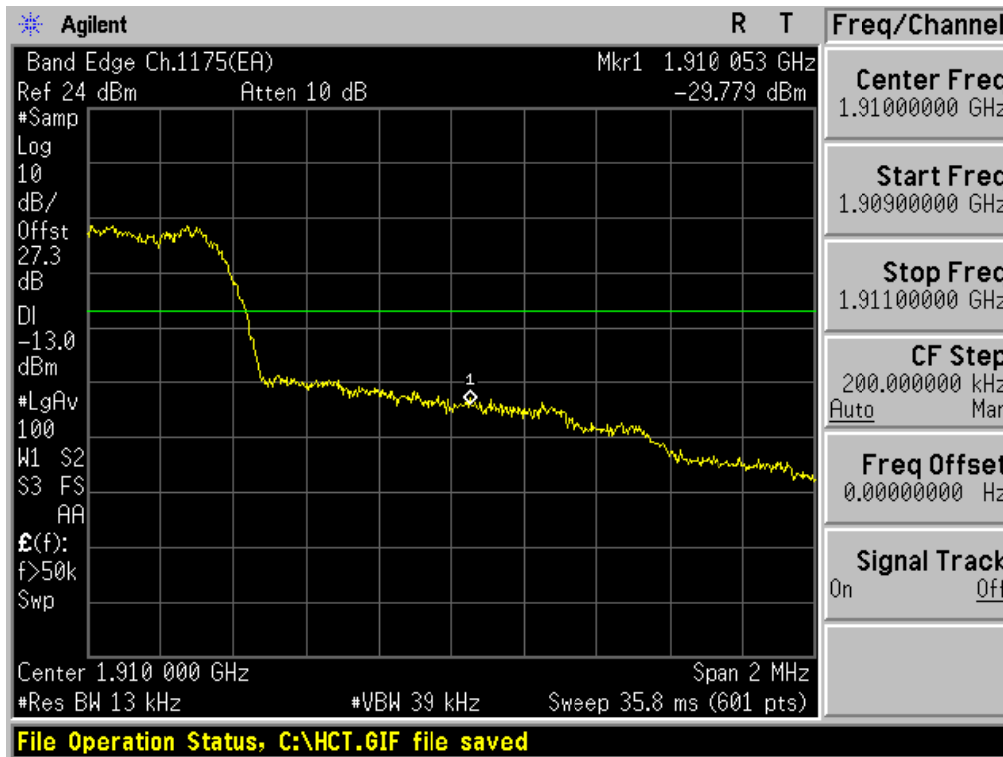

■ PCS MODE (25 CH.) 4 MHz Span

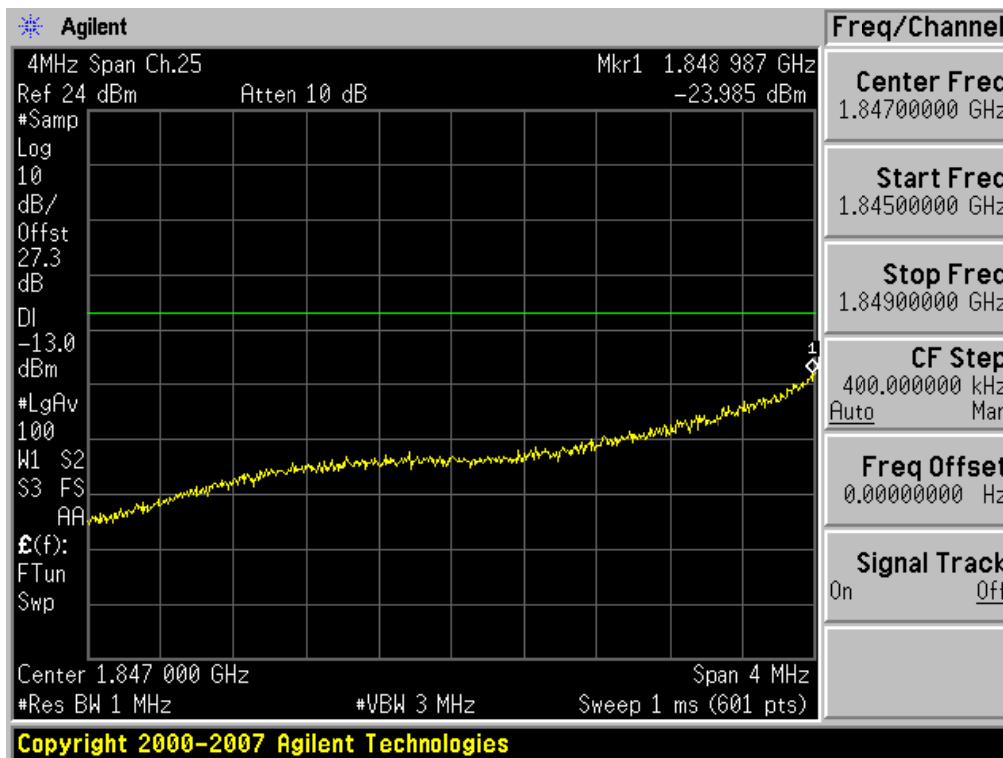

■ PCS MODE (1175 CH.) 4 MHz Span

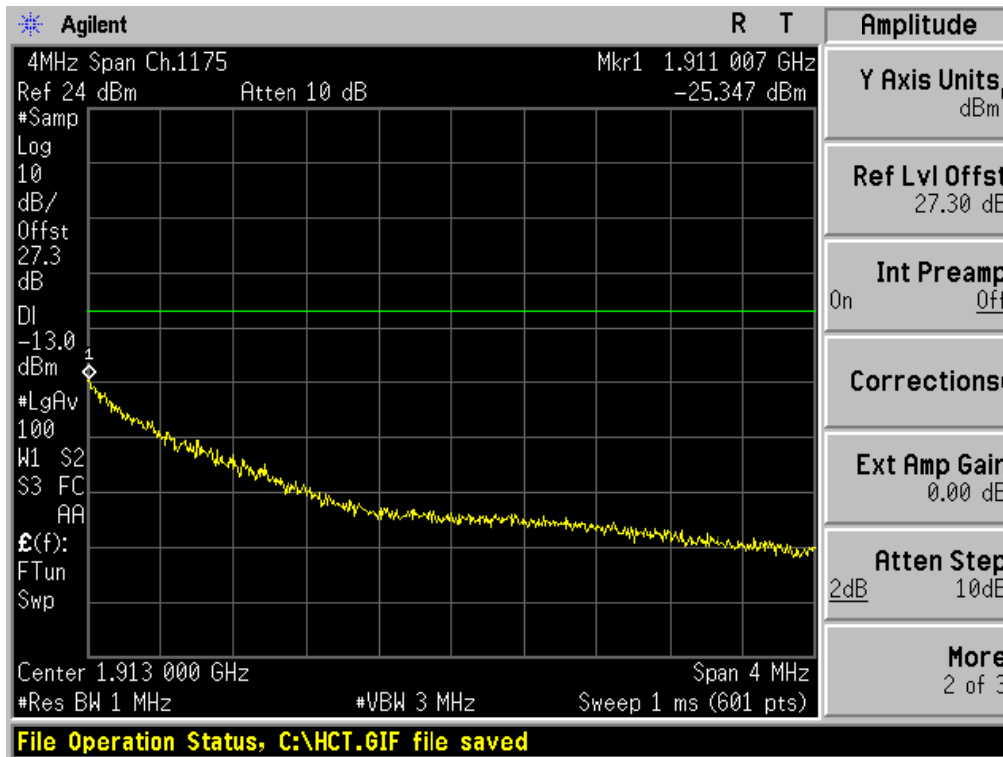

■ PCS EVDO MODE (25 CH.) 4 MHz Span

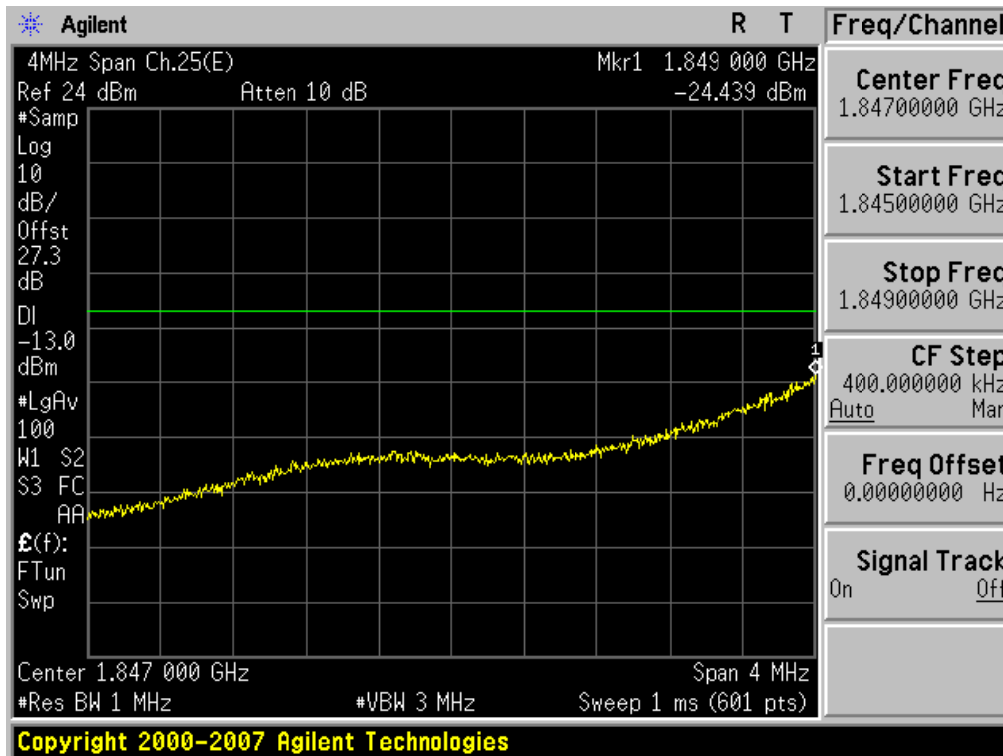

■ PCS EVDO MODE (1175 CH.) 4 MHz Span

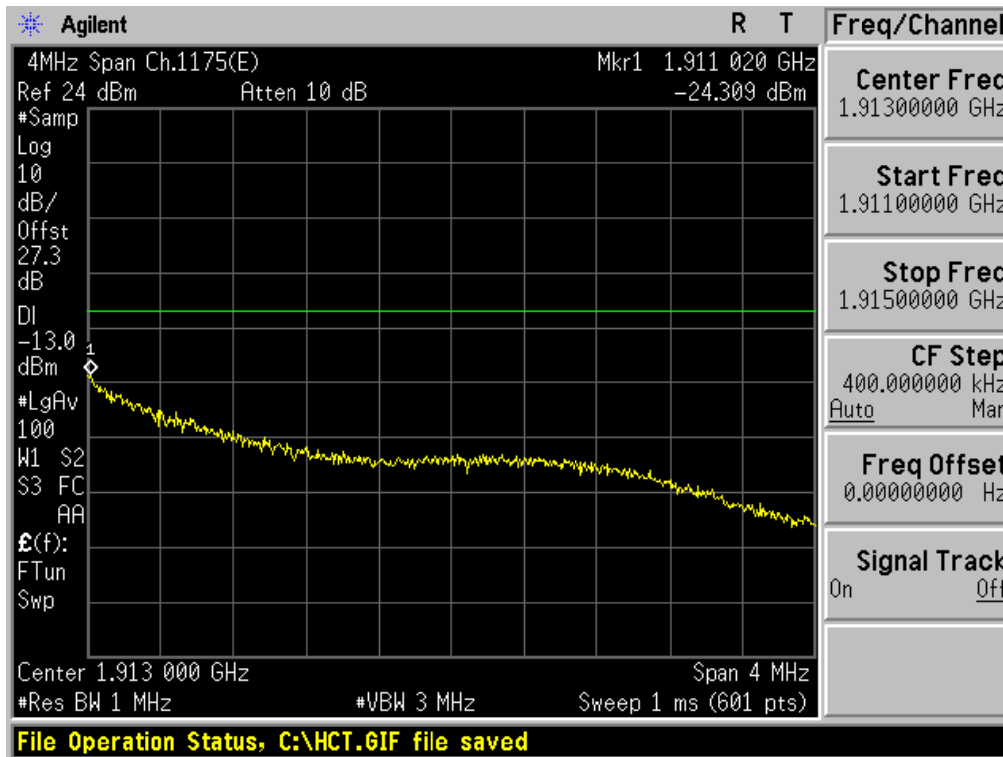

■ PCS EVDO_A MODE (25 CH.) 4 MHz Span

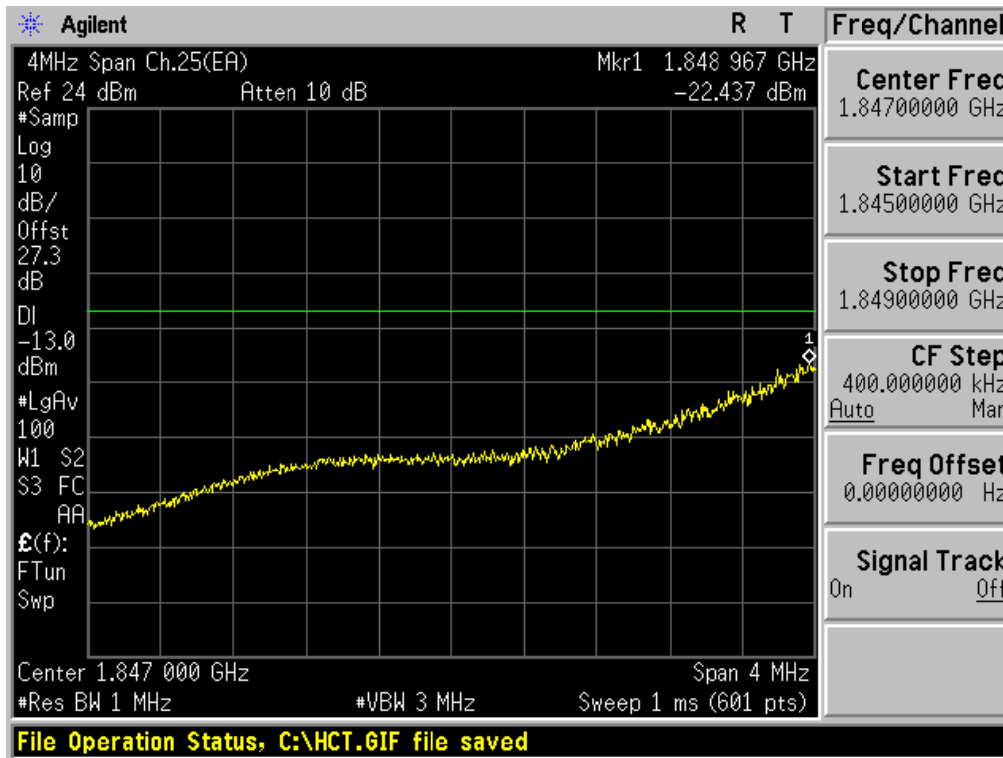

■ PCS EVDO_A MODE (1175 CH.) 4 MHz Span

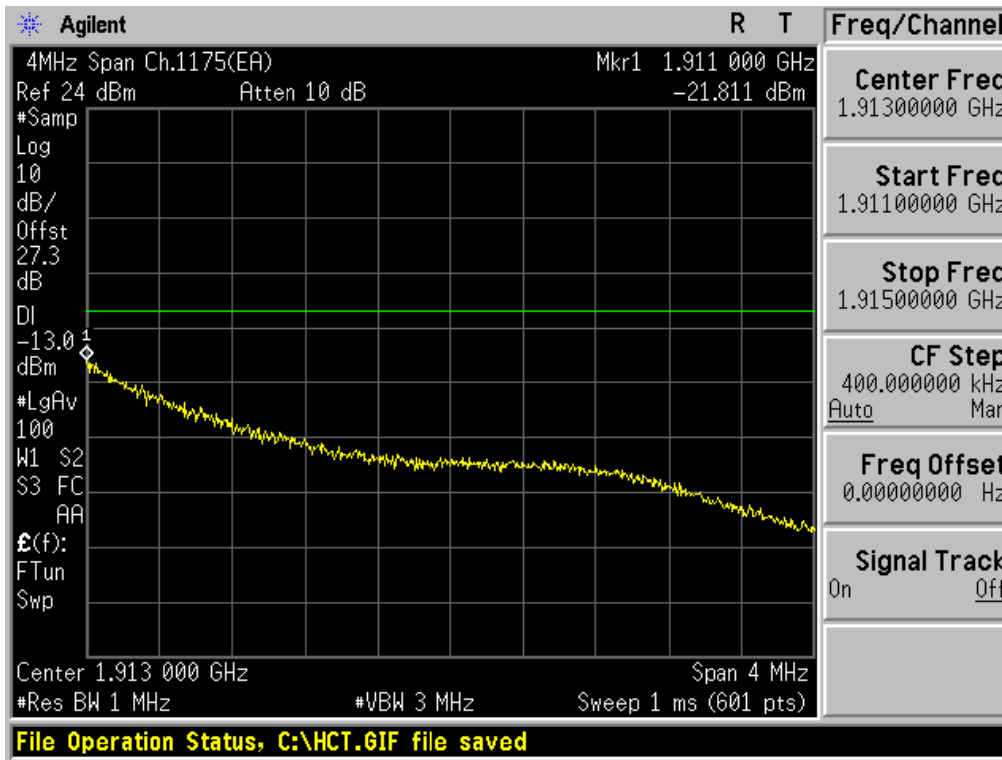

■ CDMA MODE (1013 CH.) Conducted Spurious Emissions - 1

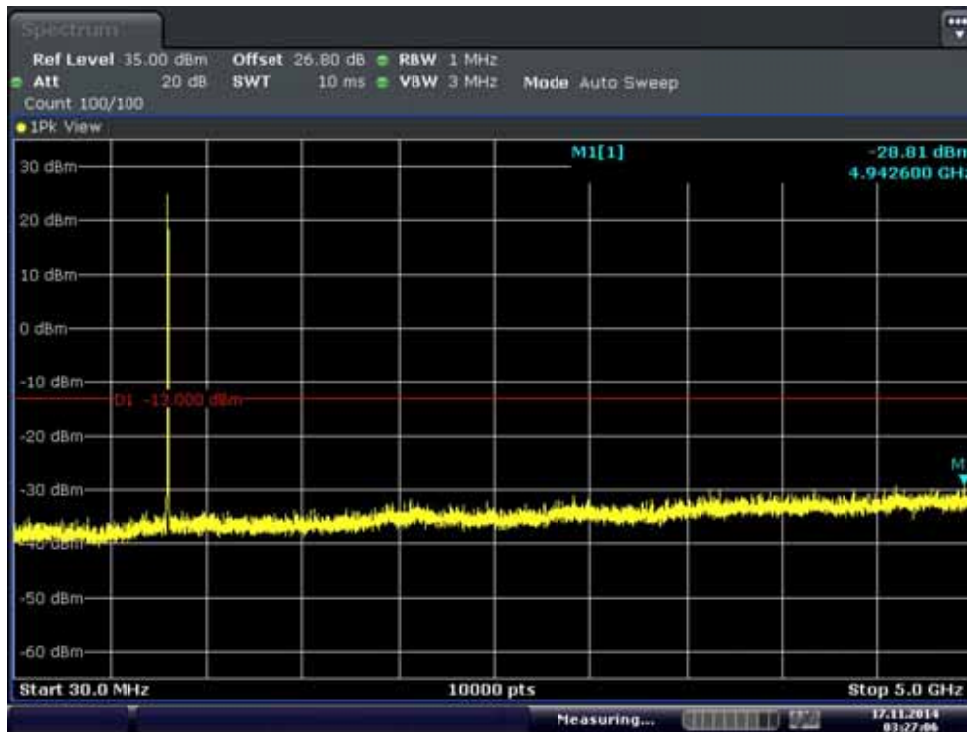

■ CDMA MODE (1013 CH.) Conducted Spurious Emissions - 2



■ CDMA MODE (384 CH.) Conducted Spurious Emissions - 1

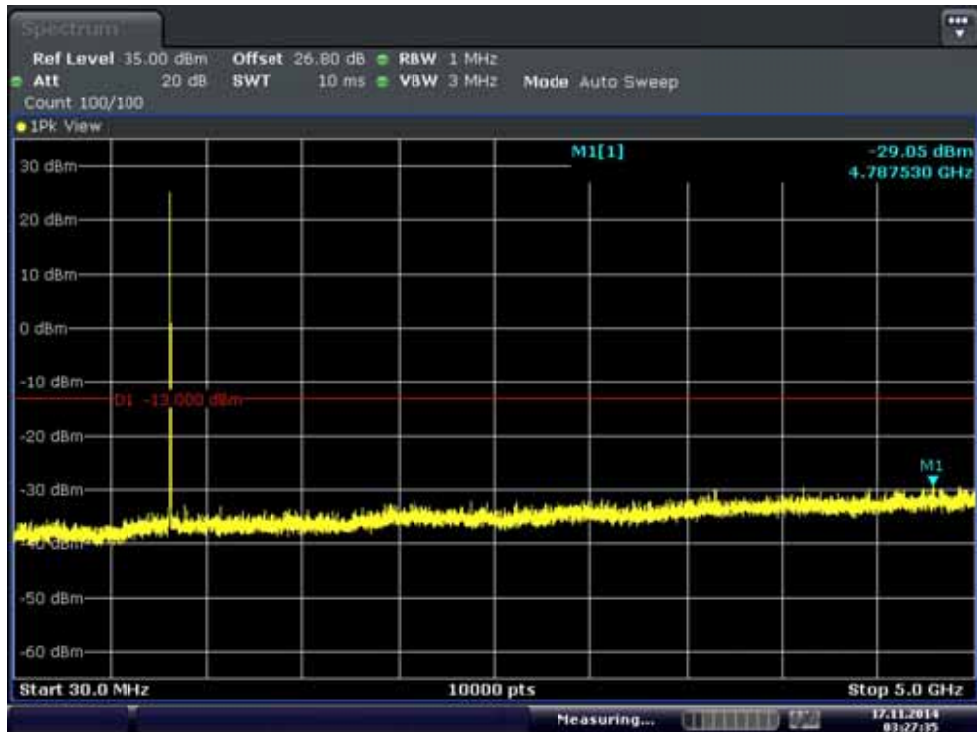

■ CDMA MODE (384 CH.) Conducted Spurious Emissions - 2

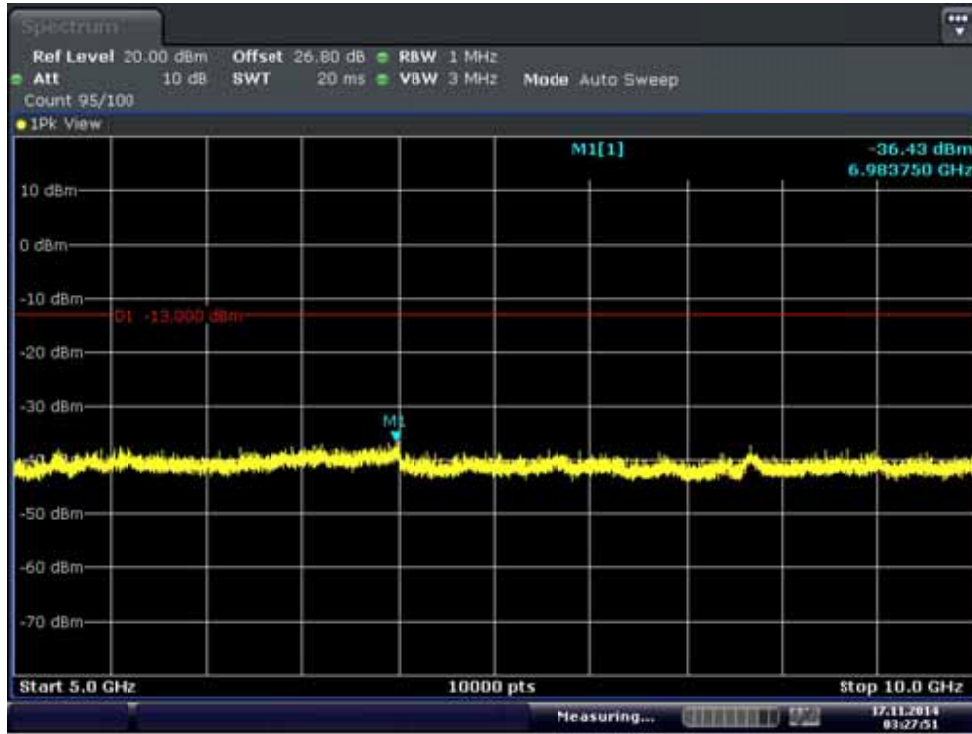

■ CDMA MODE (777 CH.) Conducted Spurious Emissions - 1

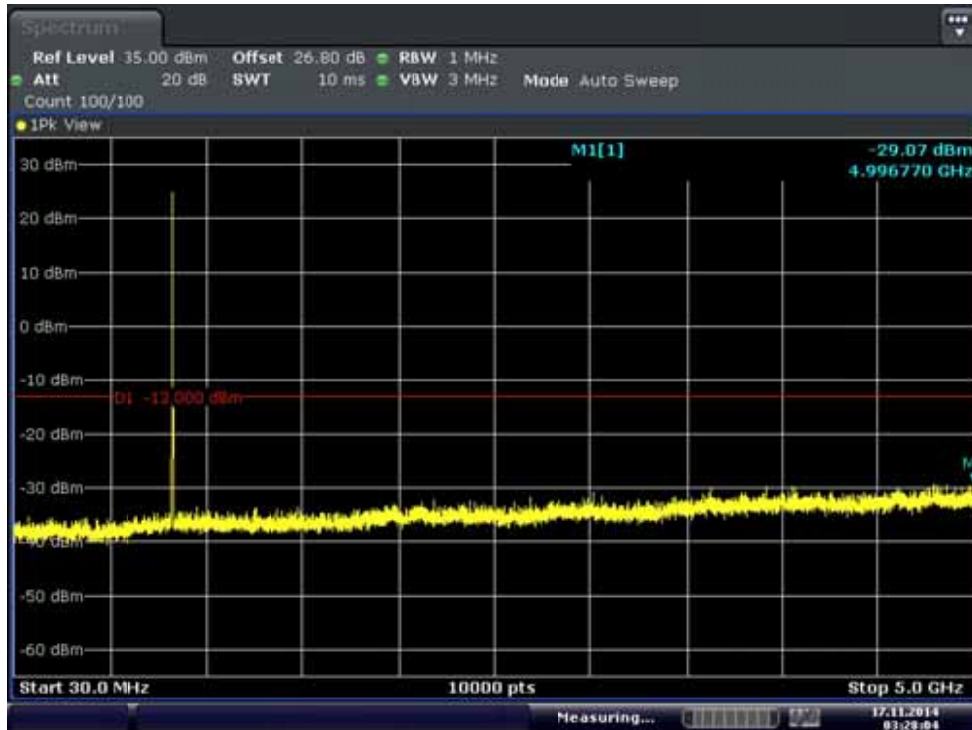

■ CDMA MODE (777 CH.) Conducted Spurious Emissions - 2



■ PCS MODE (25 CH.) Conducted Spurious Emissions - 1

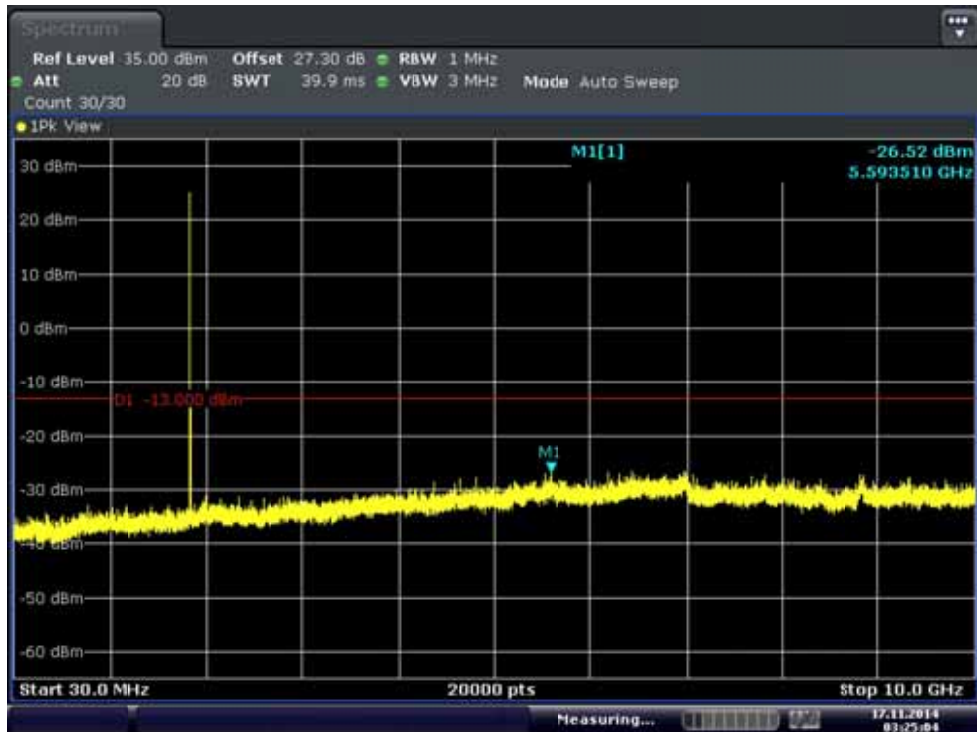

■ PCS MODE (25 CH.) Conducted Spurious Emissions - 2



■ PCS MODE (600 CH.) Conducted Spurious Emissions - 1

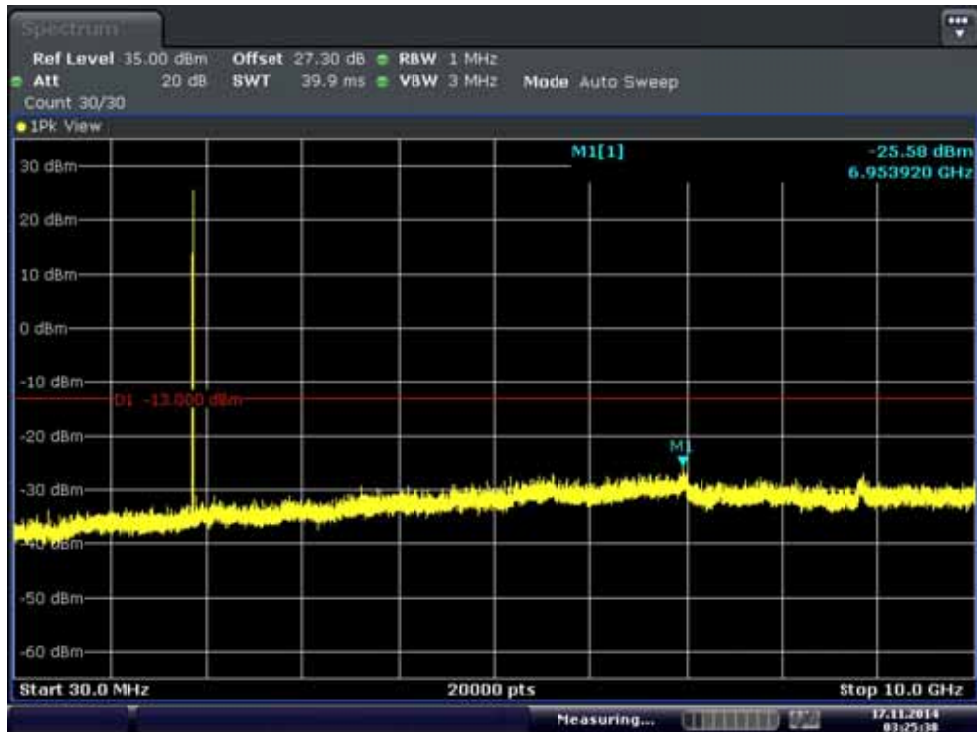

■ PCS MODE (600 CH.) Conducted Spurious Emissions - 2



■ PCS MODE (1175 CH.) Conducted Spurious Emissions - 1



■ PCS MODE (1175 CH.) Conducted Spurious Emissions - 2

