

# FCC RADIO TEST REPORT

## FCC ID: XGK-ACERNFC

**Product:** access-ER HF NFC/FAP30

**Trade Mark:** COPPERNIC

**Model No.:** access-ER

**Family Model:** N/A

**Report No.:** S22101403929004

**Issue Date:** Jan 05, 2023

### Prepared for

Coppernic

20,rue Georges Claude Aix en Provence France 13290

### Prepared by

Shenzhen NTEK Testing Technology Co., Ltd.

1/F, Building E, Fenda Science Park, Sanwei Community,  
Xixiang Street Bao'an District, Shenzhen 518126 P.R. China

Tel. 400-800-6106, 0755-2320 0050, 0755-2320 0090

Website: <http://www.ntek.org.cn>

TEST RESULT CERTIFICATION

Applicant's name : Coppernic
Address : 20,rue Georges Claude Aix en Provence France 13290
Manufacturer's Name : Askey Computer Corp.
Address : 10F, No.119, JianKang RD.,Zhonghe Dist.,New Taipei City,23585 Taiwan,R.O.C Taiwan

Product description

Product name : access-ER HF NFC/FAP30
Model and/or type reference : access-ER
Family Model : N/A
Sample number : S221014039030

Standards : FCC Part15.407

Test procedure : ANSI C63.10-2013 and KDB 789033 D02 General UNII Test Procedures New Rules v02r01
FCC KDB 662911 D01 Multiple Transmitter Output v02r01
KDB 905462 D03 Client Without DFS New Rules v01r02
KDB 905462 D02 UNII DFS Compliance Procedures New Rules v02

This device described above has been tested by NTEK, and the test results show that the equipment under test (EUT) is in compliance with the FCC requirements. And it is applicable only to the tested sample identified in the report.

This report shall not be reproduced except in full, without the written approval of NTEK, this document may be altered or revised by NTEK, personnel only, and shall be noted in the revision of the document.

Date of Test

Date (s) of performance of tests : Oct 17, 2022 ~ Jan 03, 2023

Date of Issue : Jan 05, 2023

Test Result : Pass

Testing Engineer : [Signature]
(Allen Liu)

Authorized Signatory : [Signature]
(Alex Li)

**Table of Contents**

	<b>Page</b>
<b>1. SUMMARY OF TEST RESULTS</b>	<b>7</b>
1.1 FACILITIES AND ACCREDITATIONS	8
1.2 MEASUREMENT UNCERTAINTY	8
<b>1 . GENERAL INFORMATION</b>	<b>9</b>
1.1 GENERAL DESCRIPTION OF EUT	9
1.2 DESCRIPTION OF TEST MODES	11
1.3 BLOCK DIGRAM SHOWING THE CONFIGURATION OF SYSTEM TESTED	12
1.4 DESCRIPTION OF SUPPORT UNITS(CONDUCTED MODE)	13
1.5 EQUIPMENTS LIST FOR ALL TEST ITEMS	14
<b>2 . EMC EMISSION TEST</b>	<b>16</b>
2.1 CONDUCTED EMISSION MEASUREMENT	16
2.1.1 APPLICABLE STANDARD	16
2.1.2 CONFORMANCE LIMIT	16
2.1.3 TEST CONFIGURATION	16
2.1.4 TEST PROCEDURE	16
2.2 RADIATED EMISSION MEASUREMENT	23
2.2.1 APPLICABLE STANDARD	23
2.2.2 CONFORMANCE LIMIT	23
2.2.3 MEASURING INSTRUMENTS	23
2.2.4 TEST CONFIGURATION	24
2.2.5 TEST PROCEDURE	25
2.2.6 TEST RESULTS (9KHZ – 30 MHZ)	26
2.2.7 TEST RESULTS (30MHZ – 1GHZ)	27
2.2.8 TEST RESULTS (1GHZ-18GHZ)	33
2.2.10 TEST RESULTS (18GHZ-40GHZ)	39
<b>3 . POWER SPECTRAL DENSITY TEST</b>	<b>48</b>
3.1 APPLIED PROCEDURES / LIMIT	48
3.2 TEST PROCEDURE	49
3.3 DEVIATION FROM STANDARD	49
3.4 TEST SETUP	49
3.5 EUT OPERATION CONDITIONS	49
3.6 TEST RESULTS	50
<b>4 . 26DB &amp; 99% EMISSION BANDWIDTH</b>	<b>51</b>
4.1 APPLIED PROCEDURES / LIMIT	51
4.2 TEST PROCEDURE	51
4.3 EUT OPERATION CONDITIONS	52
4.4 TEST RESULTS	52

**Table of Contents**

	<b>Page</b>
<b>5 . MINIMUM 6 DB BANDWIDTH</b>	<b>53</b>
5.1 APPLIED PROCEDURES / LIMIT	53
5.2 TEST PROCEDURE	53
5.3 DEVIATION FROM STANDARD	53
5.4 TEST SETUP	53
5.5 EUT OPERATION CONDITIONS	53
5.6 TEST RESULTS	54
<b>6 . MAXIMUM CONDUCTED OUTPUT POWER</b>	<b>55</b>
6.1 PPLIED PROCEDURES / LIMIT	55
6.2 TEST RESULTS	57
<b>7 . OUT OF BAND EMISSIONS</b>	<b>58</b>
7.1 APPLICABLE STANDARD	58
7.2 TEST PROCEDURE	58
7.3 DEVIATION FROM STANDARD	59
7.4 TEST SETUP	59
7.5 EUT OPERATION CONDITIONS	59
7.6 TEST RESULTS	60
<b>8. FREQUENCY STABILITY MEASUREMENT</b>	<b>61</b>
8.1 LIMIT	61
8.2 TEST PROCEDURES	61
8.3 TEST SETUP LAYOUT	61
8.4 EUT OPERATION DURING TEST	61
8.5 TEST RESULTS	62
<b>9. DYNAMIC FREQUENCY SELECTION(DFS)</b>	<b>71</b>
9.1 APPLICABILITY OF DFS REQUIREMENTS	71
9.2 INTERFERENCE THRESHOLD VALUES, MASTER OR CLIENT INCORPORATING IN-SERVICE MONITORING	71
9.3 DFS RESPONSE REQUIREMENT VALUES	72
9.4 SHORT PULSE RADAR TEST WAVEFORMS	72
9.5 CALIBRATION SETUP AND DFS TEST RESULTS	73
9.6 CONDUCTED CALIBRATION SETUP	73
9.7 RADAR WAVEFORM CALIBRATION RESULT	74
9.8 IN-SERVICE MONITORING: CHANNEL MOVE TIME, CHANNEL CLOSING TRANSMISSION TIME AND NON-OCCUPANCY PERIOD	75
9.9 RESULT OF CHANNEL MOVE TIME, CHANNEL CLOSING TRANSMISSION TIME AND NON-OCCUPANCY PERIOD FOR CLIENT BEACON TEST	76

**Table of Contents**

	<b>Page</b>
<b>10. ANTENNA REQUIREMENT</b>	<b>77</b>
<b>10.1 STANDARD REQUIREMENT</b>	<b>77</b>
<b>10.2 EUT ANTENNA</b>	<b>77</b>

**Revision History**

Report No.	Version	Description	Issued Date
S22101403929004	Rev.01	Initial issue of report	Jan 05, 2023

### 1. SUMMARY OF TEST RESULTS

Test procedures according to the technical standards:

FCC Part15 (15.407) , Subpart E			
Standard Section	Test Item	Judgment	Remark
15.207	AC Power Line Conducted Emissions	PASS	
15.209(a), 15.407 (b)(1) 15.407 (b)(2) 15.407 (b)(3) 15.407 (b)(4) 15.407(b)(8)(9)	Spurious Radiated Emissions	PASS	
15.407 (a)	26 dB and 99% Emission Bandwidth	PASS	
15.407(e)	Minimum 6 dB bandwidth	PASS	
15.407 (a)	Maximum Conducted Output Power	PASS	
15.407 (b)(1) 15.407 (b)(2) 15.407 (b)(3) 15.407 (b)(4)	Band Edge	PASS	
15.407 (a)	Power Spectral Density	PASS	
15.407(b)	Spurious Emissions at Antenna Terminals	PASS	
15.407(g)	Frequency Stability Measurement	PASS	
15.407(h)	Dynamic Frequency Selection(DFS)	PASS	
15.203	Antenna Requirement	PASS	
15.407(c)	Automatically discontinue transmission	PASS	(Note 3)

**NOTE:**

- (1) "N/A" denotes test is not applicable in this Test Report
- (2) This device operates with a duty cycle greater than 99%
- (3) The product is a client device, and the data transmission is limited by the AP. When the information to be sent is missing or the operation fails, the device will automatically stop sending and directly connect to the AP correctly again.

**1.1 FACILITIES AND ACCREDITATIONS**

**FACILITIES**

All measurement facilities used to collect the measurement data are located at  
1/F, Building E, Fenda Science Park Sanwei, Xixiang, Bao'an District  
Shenzhen, Guangdong, China

The sites are constructed in conformance with the requirements of ANSI C63.7, ANSI C63.10 and CISPR Publication 22.

**LABORATORY ACCREDITATIONS AND LISTINGS**

Site Description

CNAS-Lab. : The Certificate Registration Number is L5516.

IC-Registration : The Certificate Registration Number is 9270A.  
CAB identifier:CN0074

FCC- Accredited : Test Firm Registration Number: 463705.  
Designation Number: CN1184

A2LA-Lab. : The Certificate Registration Number is 4298.01

Name of Firm : Shenzhen NTEK Testing Technology Co., Ltd.

Site Location : 1/F, Building E, Fenda Science Park Sanwei, Xixiang, Bao'an District  
Shenzhen, Guangdong, China

**1.2 MEASUREMENT UNCERTAINTY**

The reported uncertainty of measurement  $y \pm U$ , where expanded uncertainty  $U$  is based on a standard uncertainty multiplied by a coverage factor of  $k=2$ , providing a level of confidence of approximately 95 %.

No.	Item	Uncertainty
1	Conducted Emission Test	$\pm 2.80\text{dB}$
2	RF power, conducted	$\pm 0.16\text{dB}$
3	Spurious emissions, conducted	$\pm 0.21\text{dB}$
4	All emissions, radiated(30MHz~1GHz)	$\pm 2.64\text{dB}$
5	All emissions, radiated(1GHz~6GHz)	$\pm 2.40\text{dB}$
6	All emissions, radiated( > 6GHz)	$\pm 2.52\text{dB}$
7	Temperature	$\pm 0.5^\circ\text{C}$
8	Humidity	$\pm 2\%$



**1. GENERAL INFORMATION**  
**1.1 GENERAL DESCRIPTION OF EUT**

Equipment	access-ER HF NFC/FAP30																		
Trade Mark	COPPERNIC																		
Model Name	access-ER																		
Family Model	N/A																		
Model Difference	N/A																		
FCC ID	XGK-ACERNFC																		
Product Description	<table border="1"> <tr> <td>Mode Supported</td> <td> <input checked="" type="checkbox"/>802.11a  <input checked="" type="checkbox"/>802.11n(HT20)  <input checked="" type="checkbox"/>802.11n(HT40)  <input checked="" type="checkbox"/>802.11ac(HT20)  <input checked="" type="checkbox"/>802.11ac(HT40)  <input checked="" type="checkbox"/>802.11ac(HT80)                 </td> </tr> <tr> <td>Data Rate</td> <td>                     802.11a: 6,9,12,18,24,36,48,54Mbps;                      802.11n(HT20/HT40):MCS0-MCS15;                      802.11ac(VHT20): NSS1, MCS0-MCS8                      802.11ac(VHT40/VHT80):NSS1, MCS0-MCS9                 </td> </tr> <tr> <td>Modulation</td> <td>OFDM with BPSK/QPSK/16QAM/64QAM</td> </tr> <tr> <td>Operating Frequency Range</td> <td> <input checked="" type="checkbox"/> U-NII-1: 5150 MHz ~5250MHz  <input checked="" type="checkbox"/> U-NII-2A: 5250MHz~5350MHz  <input checked="" type="checkbox"/> U-NII-2C: 5470MHz~5725MHz                 </td> </tr> <tr> <td>Function:</td> <td> <input type="checkbox"/>Outdoor AP <input type="checkbox"/>Indoor AP <input type="checkbox"/>Fixed P2P  <input checked="" type="checkbox"/>Client                 </td> </tr> <tr> <td>DFS type:</td> <td> <input type="checkbox"/>master devices  <input type="checkbox"/>Slave devices with radar detection  <input checked="" type="checkbox"/>Slave devices without radar detection                 </td> </tr> <tr> <td>Support TPC</td> <td> <input type="checkbox"/>YES  <input checked="" type="checkbox"/>NO                 </td> </tr> <tr> <td>Antenna Type</td> <td>LDS Antenna</td> </tr> <tr> <td>Antenna Gain</td> <td>3dBi</td> </tr> </table>	Mode Supported	<input checked="" type="checkbox"/> 802.11a <input checked="" type="checkbox"/> 802.11n(HT20) <input checked="" type="checkbox"/> 802.11n(HT40) <input checked="" type="checkbox"/> 802.11ac(HT20) <input checked="" type="checkbox"/> 802.11ac(HT40) <input checked="" type="checkbox"/> 802.11ac(HT80)	Data Rate	802.11a: 6,9,12,18,24,36,48,54Mbps; 802.11n(HT20/HT40):MCS0-MCS15; 802.11ac(VHT20): NSS1, MCS0-MCS8 802.11ac(VHT40/VHT80):NSS1, MCS0-MCS9	Modulation	OFDM with BPSK/QPSK/16QAM/64QAM	Operating Frequency Range	<input checked="" type="checkbox"/> U-NII-1: 5150 MHz ~5250MHz <input checked="" type="checkbox"/> U-NII-2A: 5250MHz~5350MHz <input checked="" type="checkbox"/> U-NII-2C: 5470MHz~5725MHz	Function:	<input type="checkbox"/> Outdoor AP <input type="checkbox"/> Indoor AP <input type="checkbox"/> Fixed P2P <input checked="" type="checkbox"/> Client	DFS type:	<input type="checkbox"/> master devices <input type="checkbox"/> Slave devices with radar detection <input checked="" type="checkbox"/> Slave devices without radar detection	Support TPC	<input type="checkbox"/> YES <input checked="" type="checkbox"/> NO	Antenna Type	LDS Antenna	Antenna Gain	3dBi
	Mode Supported	<input checked="" type="checkbox"/> 802.11a <input checked="" type="checkbox"/> 802.11n(HT20) <input checked="" type="checkbox"/> 802.11n(HT40) <input checked="" type="checkbox"/> 802.11ac(HT20) <input checked="" type="checkbox"/> 802.11ac(HT40) <input checked="" type="checkbox"/> 802.11ac(HT80)																	
	Data Rate	802.11a: 6,9,12,18,24,36,48,54Mbps; 802.11n(HT20/HT40):MCS0-MCS15; 802.11ac(VHT20): NSS1, MCS0-MCS8 802.11ac(VHT40/VHT80):NSS1, MCS0-MCS9																	
	Modulation	OFDM with BPSK/QPSK/16QAM/64QAM																	
	Operating Frequency Range	<input checked="" type="checkbox"/> U-NII-1: 5150 MHz ~5250MHz <input checked="" type="checkbox"/> U-NII-2A: 5250MHz~5350MHz <input checked="" type="checkbox"/> U-NII-2C: 5470MHz~5725MHz																	
	Function:	<input type="checkbox"/> Outdoor AP <input type="checkbox"/> Indoor AP <input type="checkbox"/> Fixed P2P <input checked="" type="checkbox"/> Client																	
	DFS type:	<input type="checkbox"/> master devices <input type="checkbox"/> Slave devices with radar detection <input checked="" type="checkbox"/> Slave devices without radar detection																	
	Support TPC	<input type="checkbox"/> YES <input checked="" type="checkbox"/> NO																	
	Antenna Type	LDS Antenna																	
	Antenna Gain	3dBi																	
Based on the application, features, or specification exhibited in User's Manual, More details of EUT technical specification, please refer to the User's Manual.																			
Ratings	DC 3.85V from battery or DC 5V from adapter DC 3.85V from battery or DC 12V from Charging base																		
Adapter	Adapter : Model: 2ACP0183C Input: 100-240V~,0.5A 50/60Hz Output: 5.0V---3.0A 15.0W/ 9.0V---2.0A 18.0W/ 12.0V---1.5A 18.0W Charging base Adapter : Model: SYS1541-2412 Input: 100-240V~,1.0A MAX 50-60Hz Output: 12.0V---2.0A																		
Battery	DC 3.85V, 4000mAh																		
Connecting I/O Port(s)	Please refer to the User's Manual																		
HW Version	PCTA200 REV:3																		
SW Version	ANDROID 10																		

Note:

1. For a more detailed features description, please refer to the manufacturer's specifications or the User's Manual.
2. Frequency and Channel list:

Band	20MHz		40MHz		80MHz	
	Channel	Frequency	Channel	Frequency	Channel	Frequency
U-NII-1	36	5180 MHz	38	5190 MHz	42	5210 MHz
	40	5200 MHz	46	5230 MHz	-	-
	44	5220 MHz				
	48	5240 MHz				
U-NII-2A	52	5260 MHz	54	5270 MHz	58	5290 MHz
	56	5280 MHz	62	5310 MHz		
	60	5300 MHz				
	64	5320 MHz				
U-NII-2C	100	5500 MHz	102	5510 MHz	106	5530 MHz
	104	5520 MHz	110	5550 MHz	122	5610 MHz
	108	5540 MHz	118	5590 MHz		
	112	5560 MHz	126	5630 MHz		
	116	5580 MHz	134	5670 MHz		
	120	5600 MHz				
	124	5620 MHz				
	128	5640 MHz				
	132	5660 MHz				
	136	5680 MHz				
	140	5700 MHz				

## 1.2 DESCRIPTION OF TEST MODES

To investigate the maximum EMI emission characteristics generates from EUT, the test system was pre-scanning tested base on the consideration of following EUT operation mode or test configuration mode which possible have effect on EMI emission level. Each of these EUT operation mode(s) or test configuration mode(s) mentioned above was evaluated respectively.

For Radiated Emission	
Final Test Mode	Description
Mode 1	Normal Link Mode
Mode 2	802.11a / n/ ac 20 CH36/ CH40/ CH48/CH52/CH56/CH64/CH100/CH120/CH140
Mode 3	802.11n40/ac40 CH38/CH46/CH54/CH62/CH102/CH118/CH134
Mode 4	802.11ac80 CH42/CH58/CH106/CH122

For Conducted Emission	
Final Test Mode	Description
Mode 1	Normal Link Mode
Mode 2	802.11a / n/ ac 20 CH36/ CH40/ CH48/CH52/CH56/CH64/CH100/CH120/CH140
Mode 3	802.11n40/ac40 CH38/CH46/CH54/CH62/CH102/CH118/CH134
Mode 4	802.11ac80 CH42/CH58/CH106/CH122

Note:

- (1) The measurements are performed at the highest, middle, lowest available channels.
- (2) The measurements are performed at all Bit Rate of Transmitter, the worst data was reported

### 1.3 BLOCK DIGRAM SHOWING THE CONFIGURATION OF SYSTEM TESTED

For AC Conducted Emission Mode

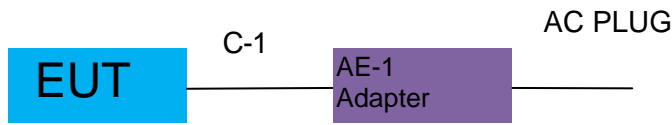

For Radiated Test Cases



For Conducted Test Cases

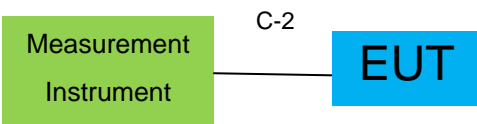

Note: 1. The temporary antenna connector is soldered on the PCB board in order to perform conducted tests and this temporary antenna connector is listed in the equipment list.

**1.4 DESCRIPTION OF SUPPORT UNITS(CONDUCTED MODE)**

The EUT has been tested as an independent unit together with other necessary accessories or support units. The following support units or accessories were used to form a representative test configuration during the tests.

Item	Equipment	Model/Type No.	Series No.	Note
AE-1	Adapter	2ACP0183C	N/A	Peripherals

Item	Cable Type	Shielded Type	Ferrite Core	Length	Note
C-1	USB Cable	NO	NO	1.0m	
C-2	RF Cable	YES	NO	0.1m	

Note:

- (1) The support equipment was authorized by Declaration of Confirmation.
- (2) For detachable type I/O cable should be specified the length in cm in 「Length」 column.
- (3) During the battery power test, the battery is fully charged.

### 1.5 EQUIPMENTS LIST FOR ALL TEST ITEMS

Radiation& Conducted Test equipment

Item	Kind of Equipment	Manufacturer	Type No.	Serial No.	Last calibration	Calibrated until	Calibration period
1	Spectrum Analyzer	Agilent	E4407B	MY45108040	2022.04.06	2023.04.05	1 year
2	Spectrum Analyzer	Agilent	N9020A	MY49100060	2022.04.06	2023.04.05	1 year
3	Spectrum Analyzer	R&S	FSV40	101417	2022.04.06	2023.04.05	1 year
4	Test Receiver	R&S	ESPI7	101318	2022.04.06	2023.04.05	1 year
5	Bilog Antenna	TESEQ	CBL6111D	31216	2022.03.30	2023.03.29	1 year
6	50Ω Coaxial Switch	Anritsu	MP59B	6200983705	2020.05.11	2023.05.10	3 year
7	Horn Antenna	EM	EM-AH-10180	2011071402	2022.03.31	2023.03.30	1 year
8	Broadband Horn Antenna	SCHWARZBECK	BBHA 9170	803	2022.11.08	2023.11.07	1 year
9	Amplifier	EMC	EMC051835SE	980246	2022.06.17	2023.06.16	1 year
10	Active Loop Antenna	SCHWARZBECK	FMZB 1519B	055	2022.11.08	2023.11.07	1 year
11	Power Meter	DARE	RPR3006W	15100041SN084	2022.11.08	2023.11.07	1 year
12	Test Cable (9KHz-30MHz)	N/A	R-01	N/A	2020.05.11	2023.05.10	3 year
13	Test Cable (30MHz-1GHz)	N/A	R-02	N/A	2020.05.11	2023.05.10	3 year
14	High Test Cable(1G-40GHz)	N/A	R-03	N/A	2022.06.17	2025.06.16	3 year
15	Filter	TRILTHIC	2400MHz	29	2022.11.08	2023.11.07	1 year
16	temporary antenna connector (Note)	NTS	R001	N/A	N/A	N/A	N/A

Note:

We will use the temporary antenna connector (soldered on the PCB board) When conducted test And this temporary antenna connector is listed within the instrument list

AC Conduction Test equipment

Item	Kind of Equipment	Manufacturer	Type No.	Serial No.	Last calibration	Calibrated until	Calibration period
1	Test Receiver	R&S	ESCI	101160	2022.04.06	2023.04.05	1 year
2	LISN	R&S	ENV216	101313	2022.04.06	2023.04.05	1 year
3	LISN	SCHWARZBECK	NNLK 8129	8129245	2022.04.06	2023.04.05	1 year
4	50Ω Coaxial Switch	ANRITSU CORP	MP59B	6200983704	2020.05.11	2023.05.10	3 year
5	Test Cable (9KHz-30MHz)	N/A	C01	N/A	2020.05.11	2023.05.10	3 year
6	Test Cable (9KHz-30MHz)	N/A	C02	N/A	2020.05.11	2023.05.10	3 year
7	Test Cable (9KHz-30MHz)	N/A	C03	N/A	2020.05.11	2023.05.10	3 year

Note: Each piece of equipment is scheduled for calibration once a year except the Test Cable& Aux Equipment which is scheduled for calibration every 3 years.

## 2. EMC EMISSION TEST

### 2.1 CONDUCTED EMISSION MEASUREMENT

#### 2.1.1 APPLICABLE STANDARD

According to FCC Part 15.207(a)

#### 2.1.2 CONFORMANCE LIMIT

Frequency(MHz)	Conducted Emission Limit	
	Quasi-peak	Average
0.15-0.5	66-56*	56-46*
0.5-5.0	56	46
5.0-30.0	60	50

Note: 1. \*Decreases with the logarithm of the frequency  
 2. The lower limit shall apply at the transition frequencies  
 3. The limit decreases in line with the logarithm of the frequency in the range of 0.15 to 0.50MHz.

#### 2.1.3 TEST CONFIGURATION

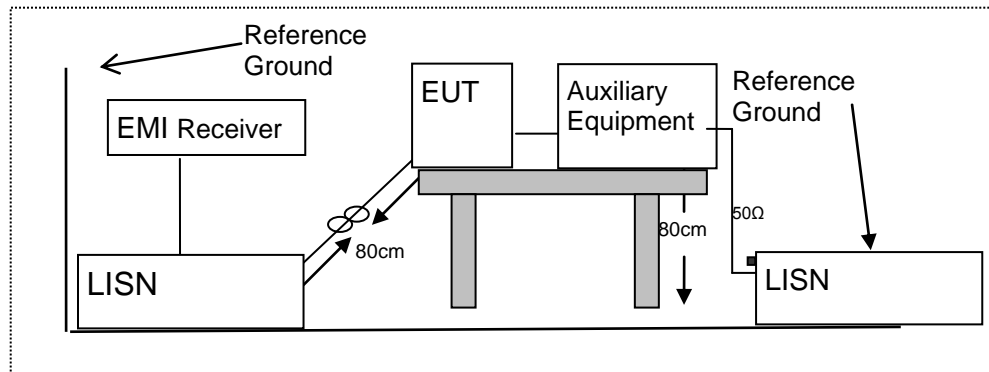

#### 2.1.4 TEST PROCEDURE

According to the requirements in Section 13.1.4.1 of ANSI C63.10-2013 Conducted emissions the EUT measured in the frequency range between 0.15 MHz and 30 MHz using CISPR Quasi-Peak and average detector mode.

1. The EUT was placed 0.4 meter from the conducting wall of the shielding room.
2. The EUT was placed on a table which is 0.8m above ground plane.
3. Connect EUT to the power mains through a line impedance stabilization network (LISN). All other support equipments powered from additional LISN(s). The LISN provide 50 Ohm/ 50uH of coupling impedance for the measuring instrument.
4. Interconnecting cables that hang closer than 40 cm to the ground plane shall be folded back and forth in the center forming a bundle 30 to 40cm long.
5. I/O cables that are not connected to a peripheral shall be bundled in the center. The end of the cable may be terminated, if required, using the correct terminating impedance. The overall length shall not exceed 1 m.
6. LISN at least 80 cm from nearest part of EUT chassis.
7. The frequency range from 150KHz to 30MHz was searched.
8. Set the test-receiver system to Peak Detect Function and specified bandwidth(IF bandwidth=9KHz) with Maximum Hold Mode
9. For the actual test configuration, please refer to the related Item –EUT Test Photos.



EUT :	access-ER HF NFC/FAP30	Model Name. :	access-ER
Temperature :	26 °C	Relative Humidity :	56%
Pressure :	1010hPa	Phase :	L
Test Voltage :	DC 5V from Adapter AC 120V/60Hz	Test Mode :	Mode 1(5.2G)

Frequency (MHz)	Reading Level (dBμV)	Correct Factor (dB)	Measurement (dBμV)	Limits (dBμV)	Margin (dB)	Remark
0.1620	36.05	9.61	45.66	65.36	-19.70	QP
0.1620	25.65	9.61	35.26	55.36	-20.10	AVG
0.1900	35.64	9.61	45.25	64.03	-18.78	QP
0.1900	25.41	9.61	35.02	54.03	-19.01	AVG
0.2500	34.06	9.63	43.69	61.75	-18.06	QP
0.2500	23.62	9.63	33.25	51.75	-18.50	AVG
0.3300	35.94	9.64	45.58	59.45	-13.87	QP
0.3300	25.51	9.64	35.15	49.45	-14.30	AVG
0.4260	32.92	9.66	42.58	57.33	-14.75	QP
0.4260	23.03	9.66	32.69	47.33	-14.64	AVG
0.5100	30.36	9.66	40.02	56.00	-15.98	QP
0.5100	20.70	9.66	30.36	46.00	-15.64	AVG

Remark:

1. All readings are Quasi-Peak and Average values.
2. Factor = Insertion Loss + Cable Loss.

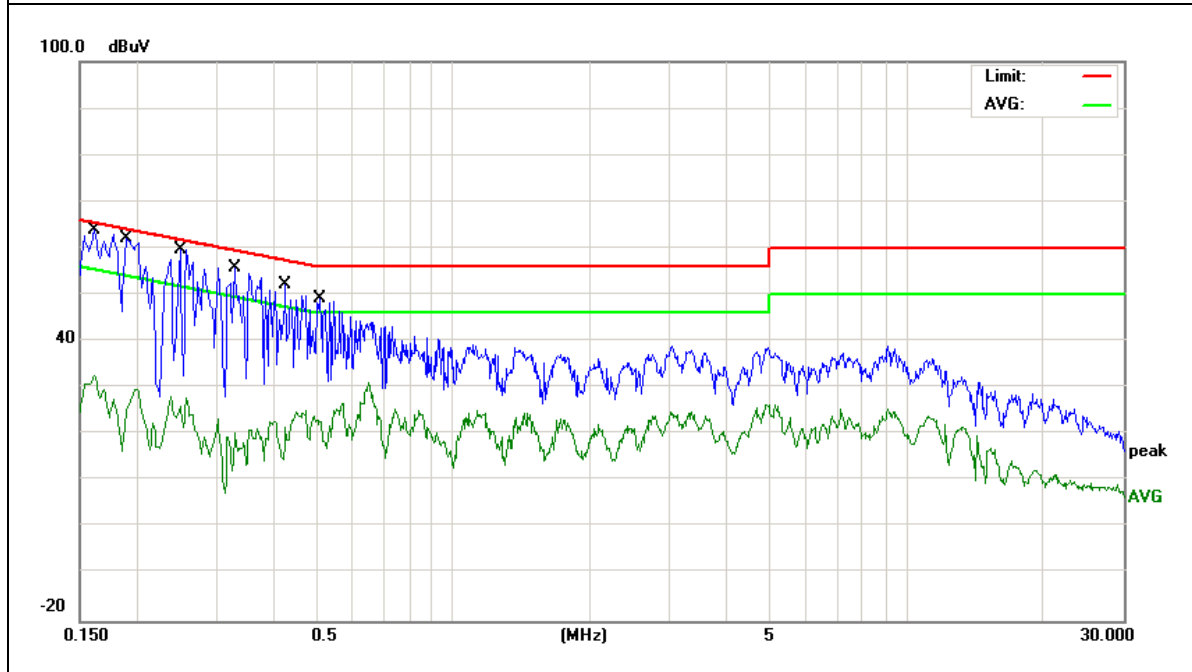

EUT :	access-ER HF NFC/FAP30	Model Name. :	access-ER
Temperature :	26 °C	Relative Humidity :	56%
Pressure :	1010hPa	Phase :	N
Test Voltage :	DC 5V from Adapter AC 120V/60Hz	Test Mode :	Mode 1(5.2G)

Frequency (MHz)	Reading Level (dBμV)	Correct Factor (dB)	Measure-ment (dBμV)	Limits (dBμV)	Margin (dB)	Remark
0.1580	38.37	9.65	48.02	65.56	-17.54	QP
0.1580	25.61	9.65	35.26	55.56	-20.30	AVG
0.2060	37.70	9.63	47.33	63.36	-16.03	QP
0.2060	26.52	9.63	36.15	53.36	-17.21	AVG
0.2500	35.07	9.62	44.69	61.75	-17.06	QP
0.2500	25.63	9.62	35.25	51.75	-16.50	AVG
0.3060	36.69	9.64	46.33	60.08	-13.75	QP
0.3060	26.61	9.64	36.25	50.08	-13.83	AVG
0.3940	31.54	9.66	41.20	57.98	-16.78	QP
0.3940	20.59	9.66	30.25	47.98	-17.73	AVG
0.5780	31.02	9.67	40.69	56.00	-15.31	QP
0.5780	20.91	9.67	30.58	46.00	-15.42	AVG

Remark:

1. All readings are Quasi-Peak and Average values.
2. Factor = Insertion Loss + Cable Loss.

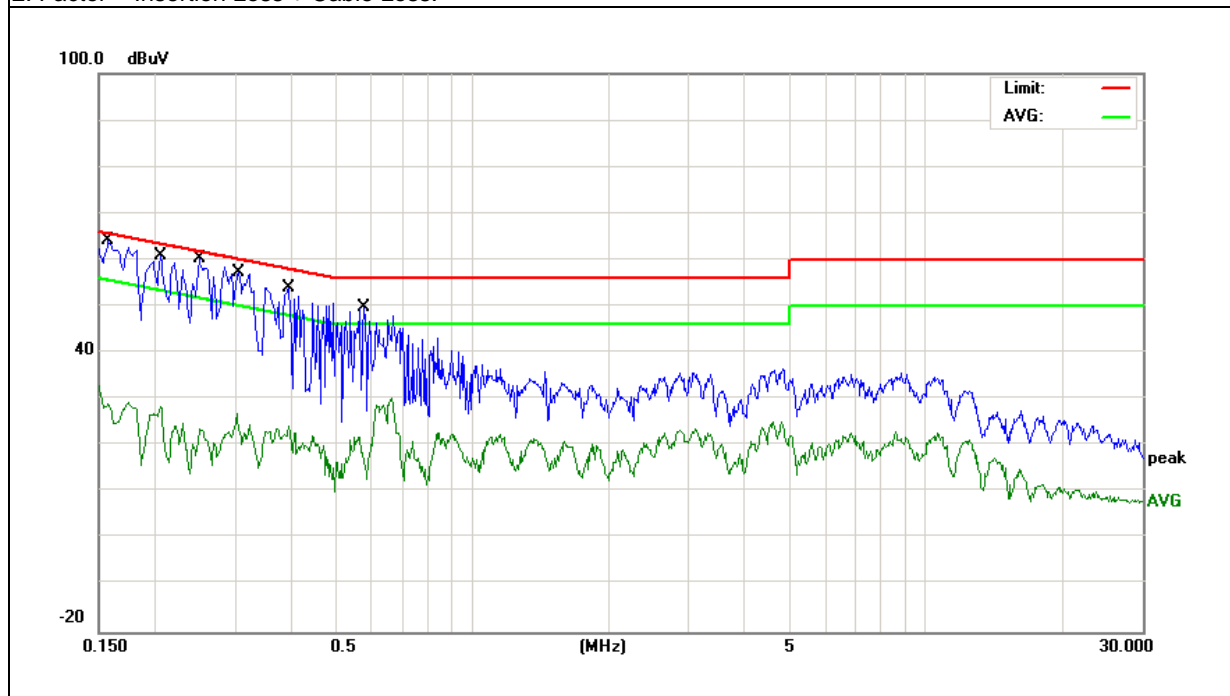

EUT :	access-ER HF NFC/FAP30	Model Name. :	access-ER
Temperature :	26 °C	Relative Humidity :	56%
Pressure :	1010hPa	Phase :	L
Test Voltage :	DC 5V from Adapter AC 120V/60Hz	Test Mode :	Mode 1(5.3G)

Frequency (MHz)	Reading Level (dBμV)	Correct Factor (dB)	Measure-ment (dBμV)	Limits (dBμV)	Margin (dB)	Remark
0.1779	40.41	9.61	50.02	64.58	-14.56	QP
0.1779	27.51	9.61	37.12	54.58	-17.46	AVG
0.2220	40.71	9.62	50.33	62.74	-12.41	QP
0.2220	28.63	9.62	38.25	52.74	-14.49	AVG
0.2500	39.39	9.63	49.02	61.75	-12.73	QP
0.2500	29.73	9.63	39.36	51.75	-12.39	AVG
0.4178	33.70	9.66	43.36	57.49	-14.13	QP
0.4178	23.99	9.66	33.65	47.49	-13.84	AVG
0.4500	32.92	9.66	42.58	56.87	-14.29	QP
0.4500	22.99	9.66	32.65	46.87	-14.22	AVG
0.6580	30.58	9.67	40.25	56.00	-15.75	QP
0.6580	20.44	9.67	30.11	46.00	-15.89	AVG

Remark:

1. All readings are Quasi-Peak and Average values.
2. Factor = Insertion Loss + Cable Loss.

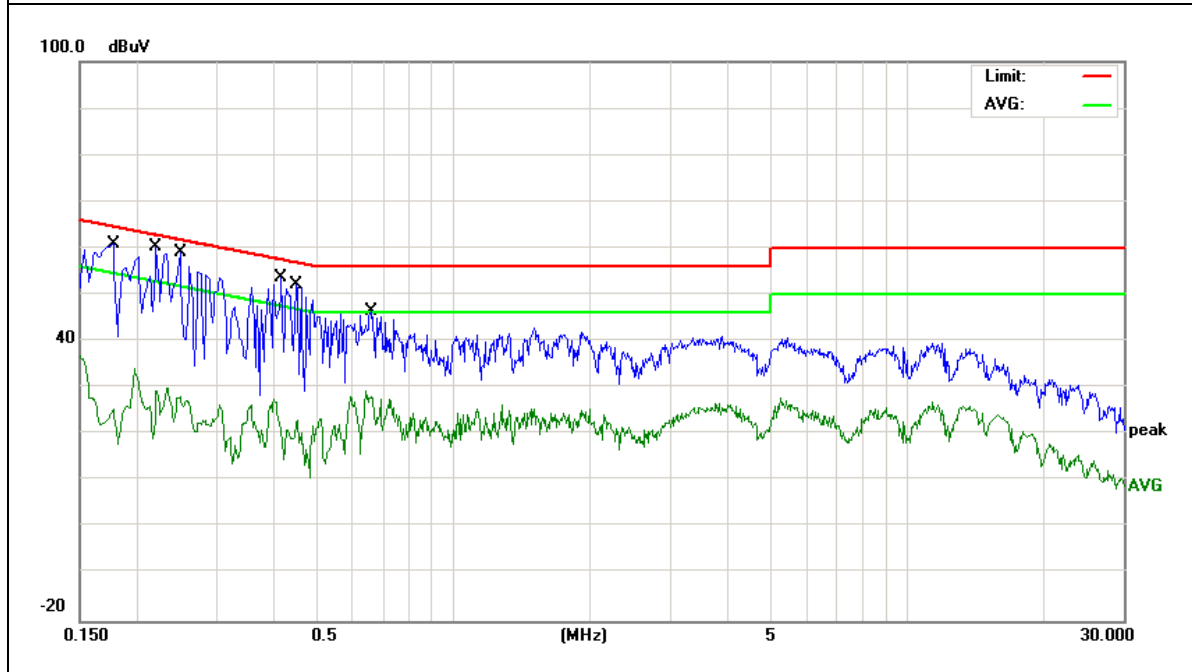

EUT :	access-ER HF NFC/FAP30	Model Name. :	access-ER
Temperature :	26 °C	Relative Humidity :	56%
Pressure :	1010hPa	Phase :	N
Test Voltage :	DC 5V from Adapter AC 120V/60Hz	Test Mode :	Mode 1(5.3G)

Frequency (MHz)	Reading Level (dBμV)	Correct Factor (dB)	Measure-ment (dBμV)	Limits (dBμV)	Margin (dB)	Remark
0.1700	44.37	9.65	54.02	64.96	-10.94	QP
0.1700	24.50	9.65	34.15	54.96	-20.81	AVG
0.1980	39.40	9.62	49.02	63.69	-14.67	QP
0.1980	29.71	9.62	39.33	53.69	-14.36	AVG
0.2300	30.49	9.62	40.11	62.45	-22.34	QP
0.2300	20.63	9.62	30.25	52.45	-22.20	AVG
0.3578	36.54	9.66	46.20	58.78	-12.58	QP
0.3578	26.49	9.66	36.15	48.78	-12.63	AVG
0.3980	35.70	9.66	45.36	57.89	-12.53	QP
0.3980	25.56	9.66	35.22	47.89	-12.67	AVG
0.5778	28.48	9.67	38.15	56.00	-17.85	QP
0.5778	18.55	9.67	28.22	46.00	-17.78	AVG

Remark:

1. All readings are Quasi-Peak and Average values.
2. Factor = Insertion Loss + Cable Loss.

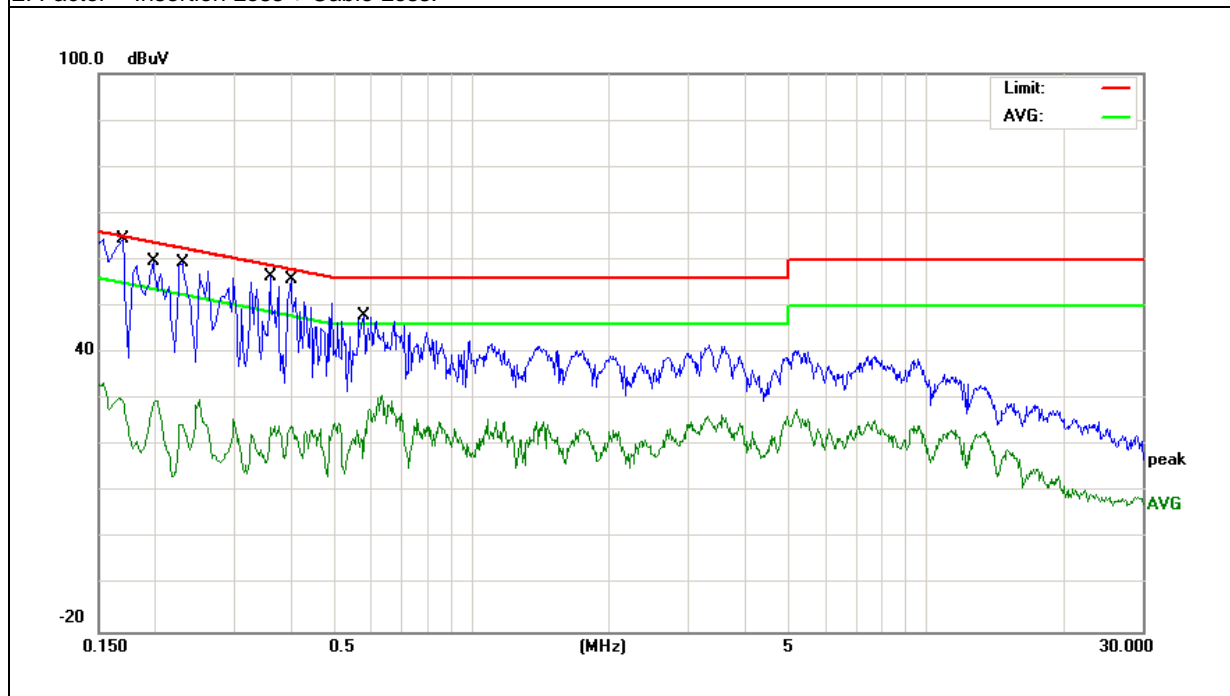

EUT :	access-ER HF NFC/FAP30	Model Name. :	access-ER
Temperature :	26 °C	Relative Humidity :	56%
Pressure :	1010hPa	Phase :	L
Test Voltage :	DC 5V from Adapter AC 120V/60Hz	Test Mode :	Mode 1(5.6G)

Frequency (MHz)	Reading Level (dBμV)	Correct Factor (dB)	Measurement (dBμV)	Limits (dBμV)	Margin (dB)	Remark
0.1737	41.41	9.61	51.02	64.78	-13.76	QP
0.1737	31.72	9.61	41.33	54.78	-13.45	AVG
0.2058	39.50	9.62	49.12	63.37	-14.25	QP
0.2058	28.60	9.62	38.22	53.37	-15.15	AVG
0.2379	38.39	9.63	48.02	62.17	-14.15	QP
0.2379	27.52	9.63	37.15	52.17	-15.02	AVG
0.2977	36.01	9.64	45.65	60.30	-14.65	QP
0.2977	25.68	9.64	35.32	50.30	-14.98	AVG
0.3537	33.61	9.64	43.25	58.87	-15.62	QP
0.3537	22.61	9.64	32.25	48.87	-16.62	AVG
0.4620	31.36	9.66	41.02	56.66	-15.64	QP
0.4620	21.60	9.66	31.26	46.66	-15.40	AVG

Remark:

1. All readings are Quasi-Peak and Average values.
2. Factor = Insertion Loss + Cable Loss.

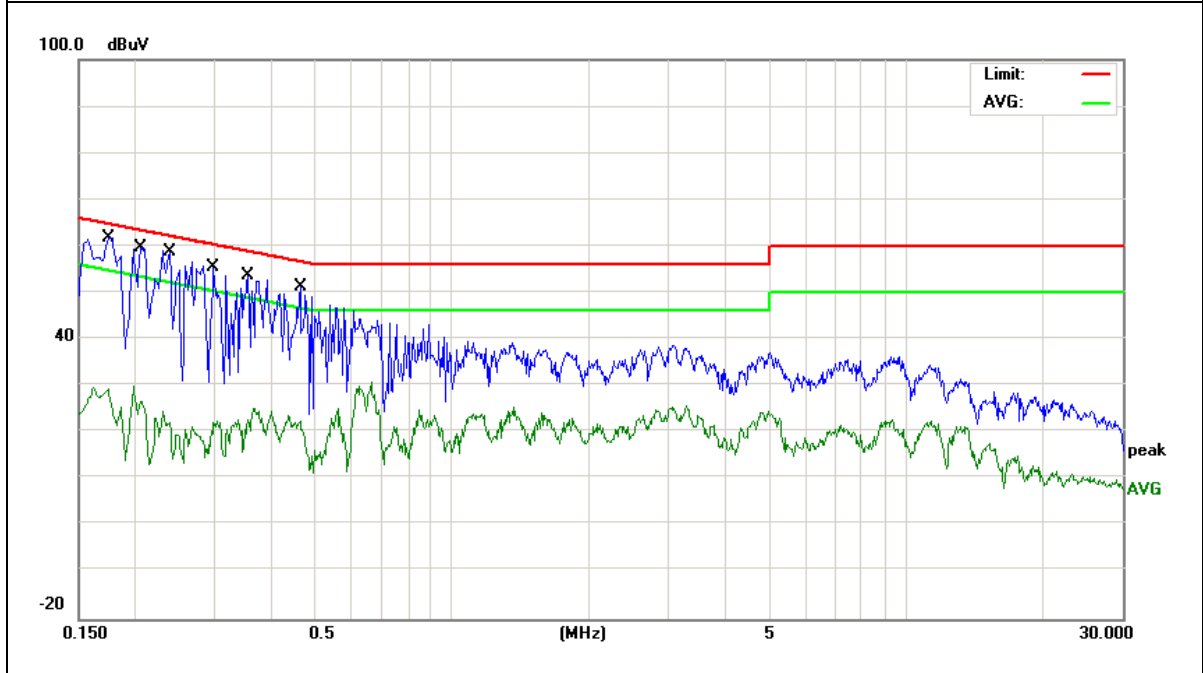

EUT :	access-ER HF NFC/FAP30	Model Name. :	access-ER
Temperature :	26 °C	Relative Humidity :	56%
Pressure :	1010hPa	Phase :	N
Test Voltage :	DC 5V from Adapter AC 120V/60Hz	Test Mode :	Mode 1(5.6G)

Frequency (MHz)	Reading Level (dBμV)	Correct Factor (dB)	Measure-ment (dBμV)	Limits (dBμV)	Margin (dB)	Remark
0.1580	42.37	9.65	52.02	65.56	-13.54	QP
0.1580	32.50	9.65	42.15	55.56	-13.41	AVG
0.1900	41.39	9.63	51.02	64.03	-13.01	QP
0.1900	31.73	9.63	41.36	54.03	-12.67	AVG
0.2500	40.63	9.62	50.25	61.75	-11.50	QP
0.2500	30.71	9.62	40.33	51.75	-11.42	AVG
0.3578	32.99	9.66	42.65	58.78	-16.13	QP
0.3578	22.92	9.66	32.58	48.78	-16.20	AVG
0.4620	30.49	9.66	40.15	56.66	-16.51	QP
0.4620	20.70	9.66	30.36	46.66	-16.30	AVG
0.6219	27.48	9.67	37.15	56.00	-18.85	QP
0.6219	18.58	9.67	28.25	46.00	-17.75	AVG

Remark:

1. All readings are Quasi-Peak and Average values.
2. Factor = Insertion Loss + Cable Loss.

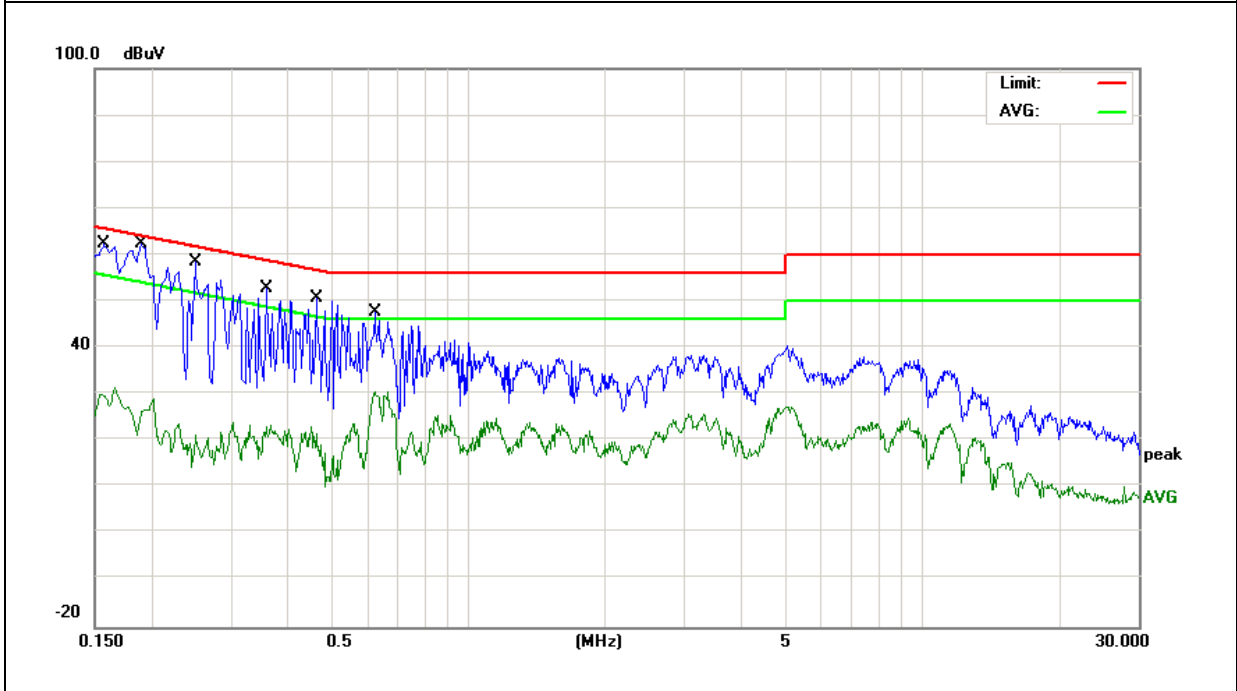

## 2.2 RADIATED EMISSION MEASUREMENT

### 2.2.1 APPLICABLE STANDARD

According to FCC Part 15.407(d) and 15.209

### 2.2.2 CONFORMANCE LIMIT

According to FCC Part 15.407(b)(7): radiated emissions which fall in the restricted bands, as defined in §15.205(a), must also comply with the radiated emission limits specified in §15.209(a) (see §15.205(c)).  
According to FCC Part 15.205, Restricted bands

MHz	MHz	MHz	GHz
0.090-0.110	16.42-16.423	399.9-410	4.5-5.15
0.495-0.505	16.69475-16.69525	608-614	5.35-5.46
2.1735-2.1905	16.80425-16.80475	960-1240	7.25-7.75
4.125-4.128	25.5-25.67	1300-1427	8.025-8.5
4.17725-4.17775	37.5-38.25	1435-1626.5	9.0-9.2
4.20725-4.20775	73-74.6	1645.5-1646.5	9.3-9.5
6.215-6.218	74.8-75.2	1660-1710	10.6-12.7
6.26775-6.26825	123-138	2200-2300	14.47-14.5
8.291-8.294	149.9-150.05	2310-2390	15.35-16.2
8.362-8.366	156.52475-156.52525	2483.5-2500	17.7-21.4
8.37625-8.38675	156.7-156.9	2690-2900	22.01-23.12
8.41425-8.41475	162.0125-167.17	3260-3267	23.6-24.0
12.29-12.293	167.72-173.2	3332-3339	31.2-31.8
12.51975-12.52025	240-285	3345.8-3358	36.43-36.5
12.57675-12.57725	322-335.4	3600-4400	(2)
13.36-13.41			

20dBc in any 100 kHz bandwidth outside the operating frequency band. In case the emission fall within the restricted band specified on 15.205(a), then the 15.209(a) limit in the table below has to be followed.

Restricted Frequency(MHz)	Field Strength (µV/m)	Field Strength (dBµV/m)	Measurement Distance
0.009-0.490	2400/F(KHz)	20 log (uV/m)	300
0.490-1.705	24000/F(KHz)	20 log (uV/m)	30
1.705-30.0	30	29.5	30
30-88	100	40	3
88-216	150	43.5	3
216-960	200	46	3
Above 960	500	54	3

### Limits of Radiated Emission Measurement(Above 1000MHz)

Frequency(MHz)	Class B (dBuV/m) (at 3M)	
	PEAK	AVERAGE
Above 1000	74	54

Remark :1. Emission level in dBuV/m=20 log (uV/m)  
 2. Measurement was performed at an antenna to the closed point of EUT distance of meters.  
 3. For Frequency 9kHz~30MHz:  
 Distance extrapolation factor =40log(Specific distance/ test distance)(dB);  
 Limit line=Specific limits(dBuV) + distance extrapolation factor.  
 For Frequency above 30MHz:  
 Distance extrapolation factor =20log(Specific distance/ test distance)(dB);  
 Limit line=Specific limits(dBuV) + distance extrapolation factor.

### 2.2.3 MEASURING INSTRUMENTS

The Measuring equipment is listed in the section 6.3 of this test report.

2.2.4 TEST CONFIGURATION

(a) For radiated emissions below 30MHz

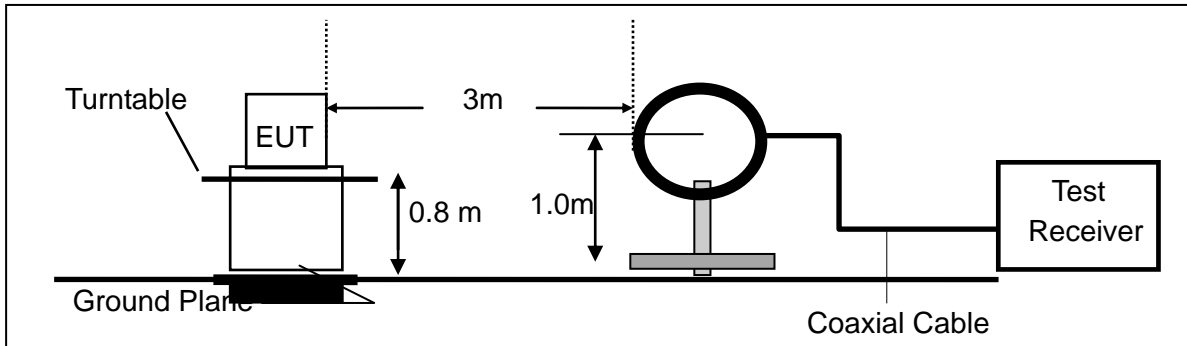

(b) For radiated emissions from 30MHz to 1000MHz

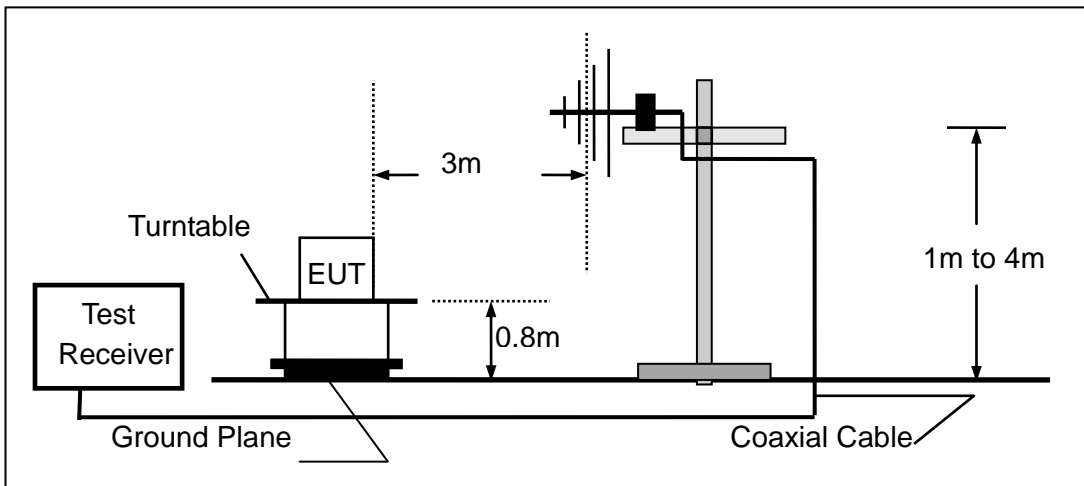

(c) For radiated emissions above 1000MHz

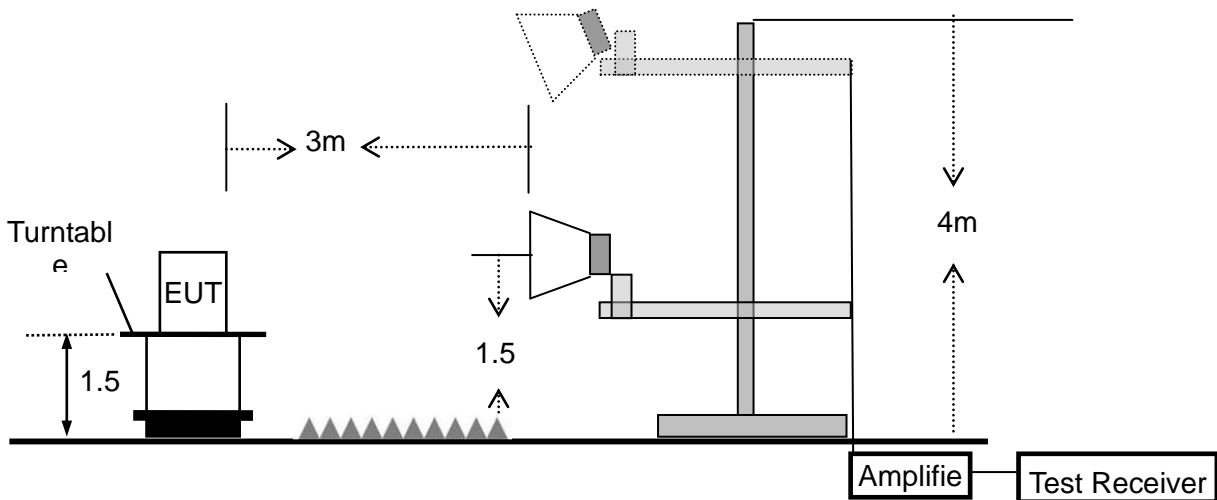



2.2.5 TEST PROCEDURE

The test site semi-anechoic chamber has met the requirement of NSA tolerance 4 dB according to the standards: ANSI C63.10-2013. The test distance is 3m. The setup is according to the requirements in Section 13.1.4.1 of ANSI C63.10-2013 and CAN/CSA-CEI/IEC CISPR 22.

This test is required for any spurious emission that falls in a Restricted Band, as defined in Section 15.205. It must be performed with the highest gain of each type of antenna proposed for use with the EUT.

Use the following spectrum analyzer settings:

Spectrum Parameter	Setting
Attenuation	Auto
Start Frequency	1000 MHz
Stop Frequency	10th carrier harmonic
RB / VB (emission in restricted band)	1 MHz / 1 MHz for Peak, 1 MHz / 10Hz for Average

Receiver Parameter	Setting
Attenuation	Auto
Start ~ Stop Frequency	9kHz~150kHz / RB 200Hz for QP
Start ~ Stop Frequency	150kHz~30MHz / RB 9kHz for QP
Start ~ Stop Frequency	30MHz~1000MHz / RB 120kHz for QP

- a. The measuring distance of at 3 m shall be used for measurements at frequency up to 1GHz. For frequencies above 1GHz, any suitable measuring distance may be used.
- b. The EUT was placed on the top of a rotating table 0.8 m for below 1GHz and 1.5m for above 1GHz the ground at a 3 meter. The table was rotated 360 degrees to determine the position of the highest radiation.
- c. The height of the equipment or of the substitution antenna shall be 0.8 m for below 1GHz and 1.5m for above 1GHz; the height of the test antenna shall vary between 1 m to 4 m. Both horizontal and vertical polarizations of the antenna are set to make the measurement.
- d. The initial step in collecting conducted emission data is a spectrum analyzer peak detector mode pre-scanning the measurement frequency range. Significant peaks are then marked and then Quasi Peak detector mode re-measured.
- e. If the Peak Mode measured value compliance with and lower than Quasi Peak Mode Limit, the EUT shall be deemed to meet QP Limits and then no additional QP Mode measurement performed.
- f. For the actual test configuration, please refer to the related Item –EUT Test Photos.

Note:

Both horizontal and vertical antenna polarities were tested and performed pretest to three orthogonal axis. The worst case emissions were reported

During the radiated emission test, the Spectrum Analyzer was set with the following configurations:

Frequency Band (MHz)	Function	Resolution bandwidth	Video Bandwidth
30 to 1000	QP	120 kHz	300 kHz
Above 1000	Peak	1 MHz	1 MHz
	Average	1 MHz	10 Hz

Note: for the frequency ranges below 30 MHz, a narrower RBW is used for these ranges but the measured value should add a RBW correction factor (RBWCF) where  $RBWCF [dB] = 10 \cdot \lg(100 [kHz] / \text{narrower RBW [kHz]})$ . , the narrower RBW is 1 kHz and RBWCF is 20 dB for the frequency 9 kHz to 150 kHz, and the narrower RBW is 10 kHz and RBWCF is 10 dB for the frequency 150 kHz to 30 MHz.

**2.2.6 TEST RESULTS (9KHZ – 30 MHZ)**

EUT :	access-ER HF NFC/FAP30	Model Name :	access-ER
Temperature :	26 °C	Relative Humidity :	54%
Pressure:	1010 hPa	Test Voltage :	DC 3.85V
Test Mode :	TX	Polarization :	--

Freq.	Reading	Limit	Margin	State
(MHz)	(dBuV/m)	(dBuV/m)	(dB)	P/F
--	--	--	--	N/A
--	--	--	--	N/A

**NOTE:**

The amplitude of spurious emissions which are attenuated by more than 20dB below the permissible value has no need to be reported.

**2.2.7 TEST RESULTS (30MHZ – 1GHZ)**

EUT :	access-ER HF NFC/FAP30	Model Name :	access-ER
Temperature :	26 °C	Relative Humidity :	54%
Pressure :	1010 hPa	Test Voltage :	DC 3.85V
Test Mode :	TX(5.2G)- 802.11ac40 (Low CH)		

Polar (H/V)	Frequency	Meter Reading	Factor	Emission Level	Limits	Margin	Remark
	(MHz)	(dBuV)	(dB)	(dBuV/m)	(dBuV/m)	(dB)	
V	30.9618	9.64	25.87	35.51	40.00	-4.49	QP
V	45.5347	8.60	17.54	26.14	40.00	-13.86	QP
V	87.1115	8.59	16.22	24.81	40.00	-15.19	QP
V	163.7548	9.70	17.95	27.65	43.50	-15.85	QP
V	185.7880	10.49	16.78	27.27	43.50	-16.23	QP
V	656.5298	7.01	27.19	34.20	46.00	-11.80	QP

**Remark:**

Absolute Level= ReadingLevel+ Factor, Margin= Absolute Level - Limit

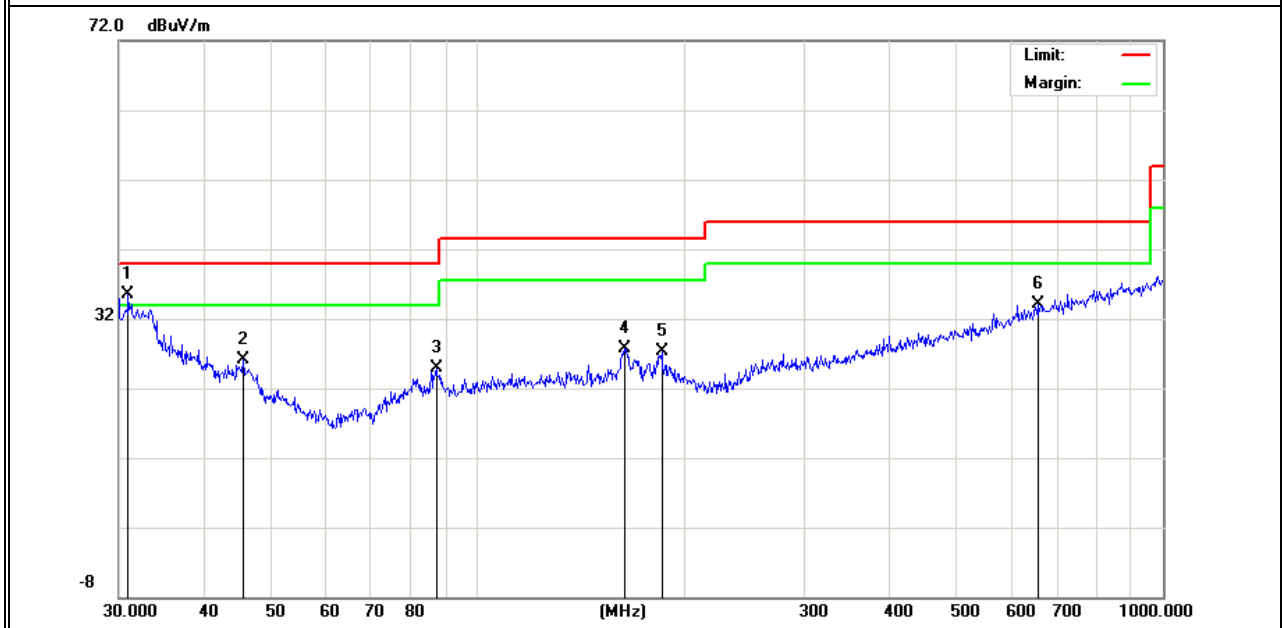

Polar (H/V)	Frequency	Meter Reading	Factor	Emission Level	Limits	Margin	Remark
	(MHz)	(dBuV)	(dB)	(dBuV/m)	(dBuV/m)	(dB)	
H	30.6377	5.29	25.87	31.16	40.00	-8.84	QP
H	37.6798	6.27	22.04	28.31	40.00	-11.69	QP
H	79.8002	5.53	15.47	21.00	40.00	-19.00	QP
H	144.8418	6.49	18.56	25.05	43.50	-18.45	QP
H	276.1235	11.82	19.61	31.43	46.00	-14.57	QP
H	385.2805	8.00	22.98	30.98	46.00	-15.02	QP

**Remark:**

Absolute Level= ReadingLevel+ Factor, Margin= Absolute Level - Limit

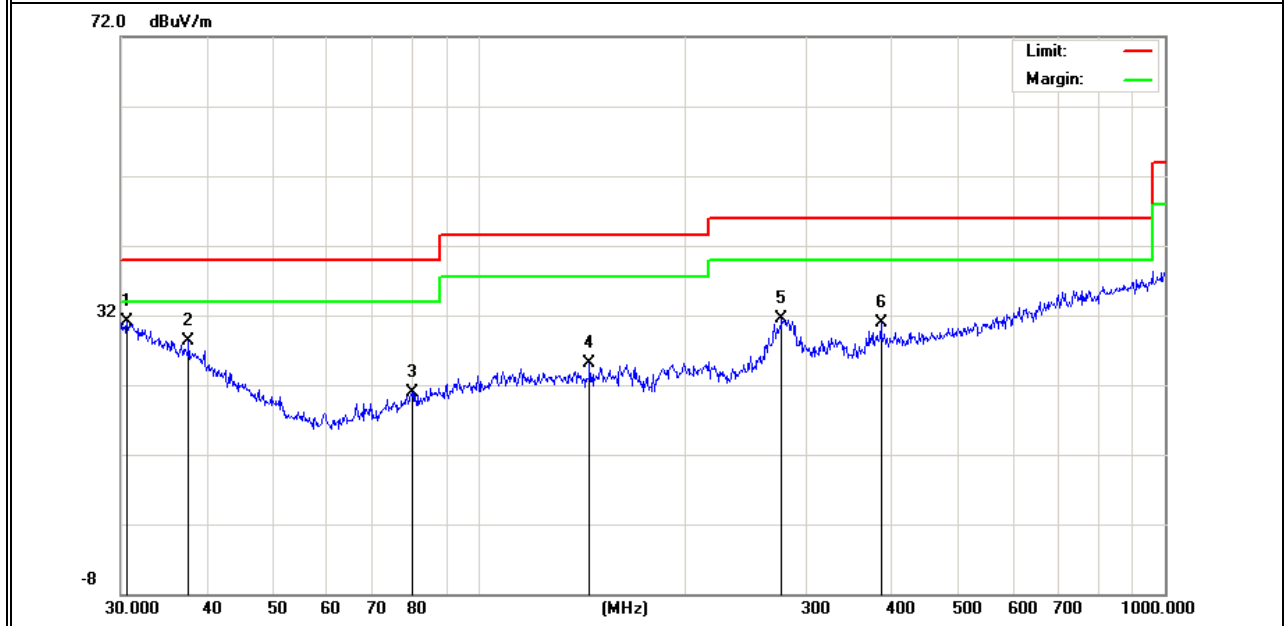

EUT :	access-ER HF NFC/FAP30	Model Name :	access-ER
Temperature :	26 °C	Relative Humidity :	54%
Pressure :	1010 hPa	Test Voltage :	DC 3.85V
Test Mode :	TX(5.3G)- 802.11n40 (Middle CH)		

Polar (H/V)	Frequency	Meter Reading	Factor	Emission Level	Limits	Margin	Remark
	(MHz)	(dBuV)	(dB)	(dBuV/m)	(dBuV/m)	(dB)	
V	30.5304	8.66	25.87	34.53	40.00	-5.47	QP
V	46.8303	7.92	16.60	24.52	40.00	-15.48	QP
V	85.5977	10.56	16.12	26.68	40.00	-13.32	QP
V	164.3300	15.23	17.90	33.13	43.50	-10.37	QP
V	184.4898	15.81	16.75	32.56	43.50	-10.94	QP
V	629.4772	7.18	26.39	33.57	46.00	-12.43	QP

**Remark:**

Absolute Level= ReadingLevel+ Factor, Margin= Absolute Level - Limit

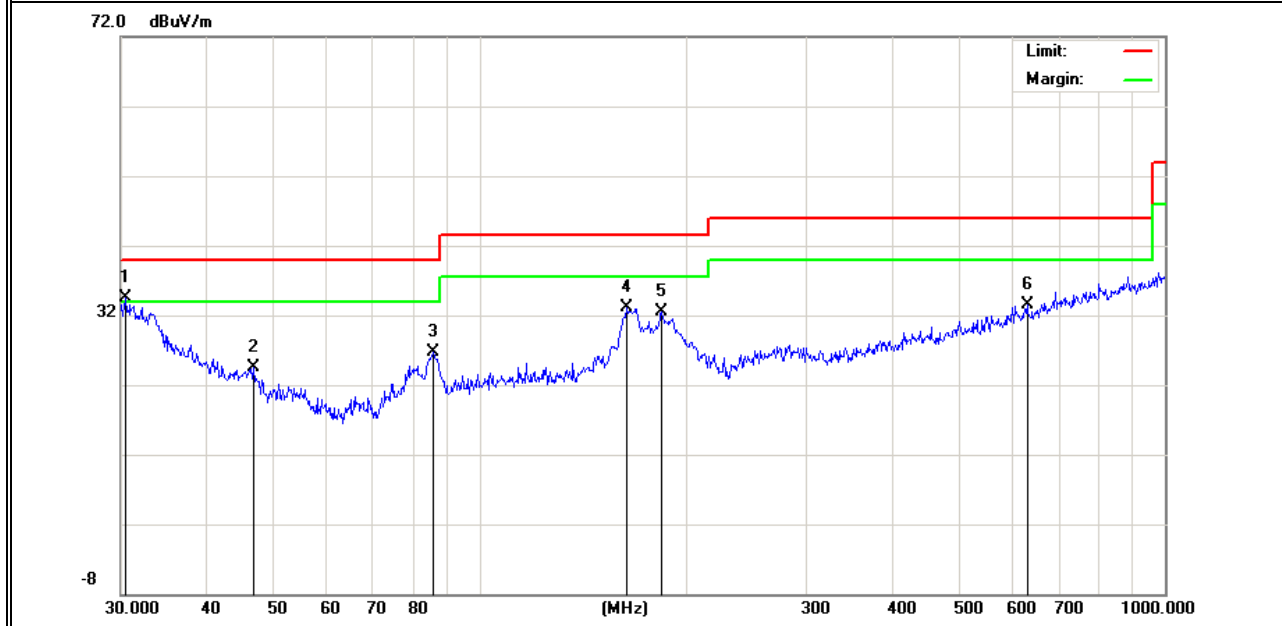

Polar (H/V)	Frequency	Meter Reading	Factor	Emission Level	Limits	Margin	Remark
	(MHz)	(dBuV)	(dB)	(dBuV/m)	(dBuV/m)	(dB)	
H	30.8535	5.81	25.87	31.68	40.00	-8.32	QP
H	42.4508	6.66	18.96	25.62	40.00	-14.38	QP
H	163.1818	11.02	17.66	28.68	43.50	-14.82	QP
H	190.4050	12.66	16.23	28.89	43.50	-14.61	QP
H	285.9778	13.78	20.11	33.89	46.00	-12.11	QP
H	552.8832	10.39	25.46	35.85	46.00	-10.15	QP

**Remark:**

Absolute Level= ReadingLevel+ Factor, Margin= Absolute Level - Limit

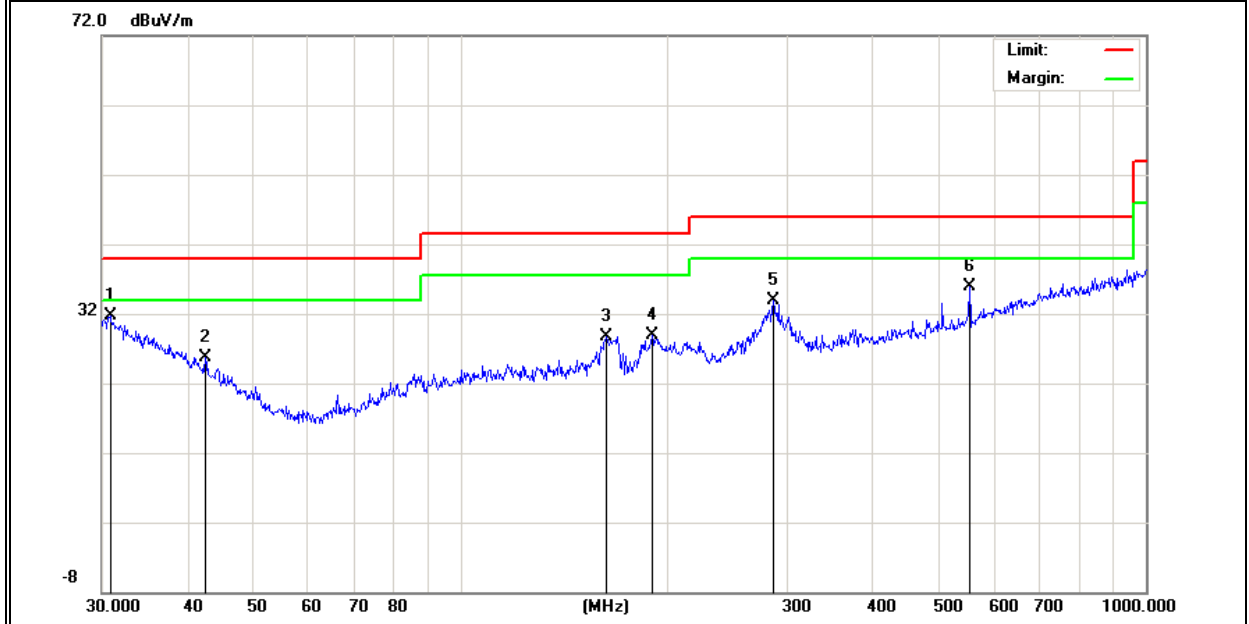

EUT :	access-ER HF NFC/FAP30	Model Name :	access-ER
Temperature :	26 °C	Relative Humidity :	54%
Pressure :	1010 hPa	Test Voltage :	DC 3.85V
Test Mode :	TX(5.6G)- 802.11n20 (Low CH)		

Polar (H/V)	Frequency	Meter Reading	Factor	Emission Level	Limits	Margin	Remark
	(MHz)	(dBuV)	(dB)	(dBuV/m)	(dBuV/m)	(dB)	
V	30.9618	9.64	25.87	35.51	40.00	-4.49	QP
V	45.5347	8.60	17.54	26.14	40.00	-13.86	QP
V	87.1115	8.59	16.22	24.81	40.00	-15.19	QP
V	163.7547	9.70	17.95	27.65	43.50	-15.85	QP
V	185.7880	10.49	16.78	27.27	43.50	-16.23	QP
V	656.5298	7.01	27.19	34.20	46.00	-11.80	QP

**Remark:**

Absolute Level= ReadingLevel+ Factor, Margin= Absolute Level - Limit

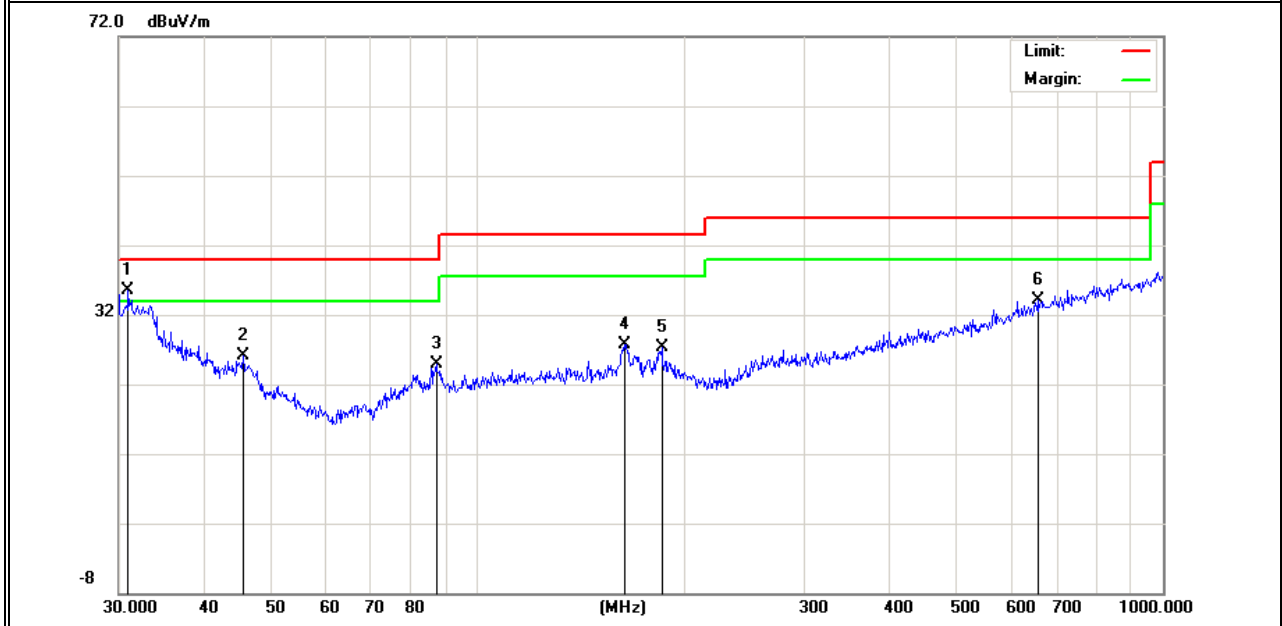

Polar (H/V)	Frequency	Meter Reading	Factor	Emission Level	Limits	Margin	Remark
	(MHz)	(dBuV)	(dB)	(dBuV/m)	(dBuV/m)	(dB)	
H	30.6377	5.29	25.87	31.16	40.00	-8.84	QP
H	37.6798	6.27	22.04	28.31	40.00	-11.69	QP
H	114.9167	5.81	18.44	24.25	43.50	-19.25	QP
H	276.1235	11.82	19.61	31.43	46.00	-14.57	QP
H	385.2805	8.00	22.98	30.98	46.00	-15.02	QP
H	758.0407	6.94	28.58	35.52	46.00	-10.48	QP

**Remark:**

Absolute Level= ReadingLevel+ Factor, Margin= Absolute Level - Limit

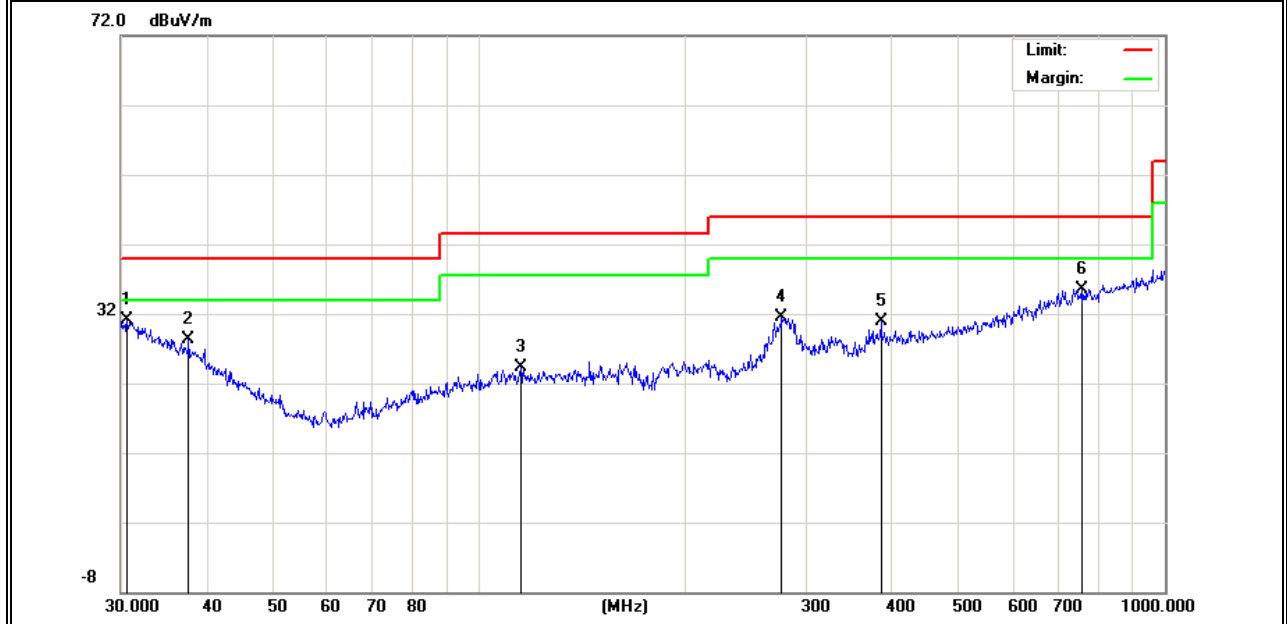

Note: All modes have been tested, just the the worst mode has been recorded in the report.



### 2.2.8 TEST RESULTS (1GHz-18GHz)

EUT :	access-ER HF NFC/FAP30	Model Name. :	access-ER
Temperature :	20 °C	Relative Humidity :	48%
Pressure :	1010 hPa	Test Voltage :	DC 3.85V
Test Mode :	TX(5.2G) - 802.11ac20 _5190~5230MHz		

Polar	Frequency	Meter Reading	Cable loss	Antenna Factor	Preamp Factor	Emission Level	Limits	Margin	Detector Type
(H/V)	(MHz)	(dBuV)	(dB)	dB/m	(dB)	(dBuV/m)	(dBuV/m)	(dB)	
Low Channel (5180 MHz)-Above 1G									
Vertical	3694.10	59.03	5.94	35.40	44.00	56.37	74.00	-17.63	Pk
Vertical	3694.10	40.05	5.94	35.40	44.00	37.39	54.00	-16.61	AV
Vertical	10360.15	60.80	8.46	39.75	44.50	64.51	68.20	-3.69	Pk
Vertical	15540.22	60.89	10.12	38.80	44.10	65.71	74.00	-8.29	Pk
Vertical	15540.22	39.57	10.12	38.80	42.70	45.79	54.00	-8.21	AV
Horizontal	3713.00	59.33	5.94	35.18	44.00	56.45	74.00	-17.55	Pk
Horizontal	3713.00	40.76	5.94	35.18	44.00	37.88	54.00	-16.12	AV
Horizontal	10360.47	60.05	8.46	38.71	44.50	62.72	68.20	-5.48	Pk
Horizontal	15540.38	59.43	10.12	38.38	44.10	63.83	74.00	-10.17	Pk
Horizontal	15540.38	39.64	10.12	38.38	44.10	44.04	54.00	-9.96	AV
middle Channel (5200 MHz)-Above 1G									
Vertical	3624.13	60.10	6.48	36.35	44.05	58.88	74.00	-15.12	Pk
Vertical	3624.13	39.58	6.48	36.35	44.05	38.36	54.00	-15.64	AV
Vertical	10400.09	60.19	8.47	37.88	44.51	62.03	68.20	-6.17	Pk
Vertical	15600.15	59.51	10.12	38.80	44.10	64.33	74.00	-9.67	Pk
Vertical	15600.15	40.78	10.12	38.80	42.70	47.00	54.00	-7.00	AV
Horizontal	4202.14	59.86	6.48	36.37	44.05	58.66	74.00	-15.34	Pk
Horizontal	4202.14	40.42	6.48	36.37	44.05	39.22	54.00	-14.78	AV
Horizontal	10400.14	60.29	8.47	38.64	44.50	62.90	68.20	-5.30	Pk
Horizontal	15600.51	59.39	10.12	38.38	44.10	63.79	74.00	-10.21	Pk
Horizontal	15600.51	40.74	10.12	38.38	44.10	45.14	54.00	-8.86	AV

High Channel (5240 MHz)-Above 1G									
Vertical	4597.70	60.70	7.10	37.24	43.50	61.54	74.00	-12.46	Pk
Vertical	4597.70	39.63	7.10	37.24	43.50	40.47	54.00	-13.53	AV
Vertical	10480.23	59.27	8.46	37.68	44.50	60.91	68.20	-7.29	Pk
Vertical	15720.15	59.09	10.12	38.80	44.10	63.91	74.00	-10.09	Pk
Vertical	15720.15	39.68	10.12	38.80	42.70	45.90	54.00	-8.10	AV
Horizontal	4589.26	60.16	7.10	37.24	43.50	61.00	74.00	-13.00	Pk
Horizontal	4589.26	40.80	7.10	37.24	43.50	41.64	54.00	-12.36	AV
Horizontal	10480.59	60.98	8.46	38.57	44.50	63.51	68.20	-4.69	Pk
Horizontal	15720.18	59.99	10.12	38.38	44.10	64.39	74.00	-9.61	Pk
Horizontal	15720.18	40.48	10.12	38.38	44.10	44.88	54.00	-9.12	AV

Note: "802.11ac20(5G)" mode is the worst mode. PK value is lower than the Average value limit, So average didn't record.

The amplitude of spurious emissions that are attenuated by more than 20dB below the permissible value has no need to be reported.

Emission level (dBuV/m) = 20 log Emission level (uV/m).

Corrected Reading: Antenna Factor + Cable Loss + Read Level - Preamp Factor = Level.

EUT :	access-ER HF NFC/FAP30	Model Name. :	access-ER
Temperature :	20 °C	Relative Humidity :	48%
Pressure :	1010 hPa	Test Voltage :	DC 3.85V
Test Mode :	TX(5.3G) - 802.11ac20_5260~5320MHz		

Polar	Frequency	Meter Reading	Cable loss	Antenna Factor	Preamp Factor	Emission Level	Limits	Margin	Detector Type
(H/V)	(MHz)	(dBuV)	(dB)	dB/m	(dB)	(dBuV/m)	(dBuV/m)	(dB)	
Low Channel (5260 MHz)-Above 1G									
Vertical	4633.25	59.13	5.44	35.40	44.00	55.97	74.00	-18.03	Pk
Vertical	4633.25	39.95	5.74	35.40	44.00	37.09	54.00	-16.91	AV
Vertical	10520.12	60.18	8.26	39.75	44.50	63.70	68.20	-4.50	Pk
Vertical	15780.34	59.27	10.12	38.80	44.10	64.09	74.00	-9.91	Pk
Vertical	15780.34	39.15	9.62	38.80	42.70	44.88	54.00	-9.12	AV
Horizontal	4366.15	60.43	5.57	35.18	44.00	57.17	74.00	-16.83	Pk
Horizontal	4366.15	40.29	5.74	35.18	44.00	37.21	54.00	-16.79	AV
Horizontal	10520.26	59.49	8.38	38.71	44.50	62.08	68.20	-6.12	Pk
Horizontal	15780.34	59.22	9.88	38.38	44.10	63.38	74.00	-10.62	Pk
Horizontal	15780.34	40.28	9.94	38.38	44.10	44.50	54.00	-9.50	AV
middle Channel (5280 MHz)-Above 1G									
Vertical	4122.34	60.40	6.08	36.35	44.05	58.78	74.00	-15.22	Pk
Vertical	4122.34	39.54	6.39	36.35	44.05	38.23	54.00	-15.77	AV
Vertical	10560.19	60.44	8.28	37.88	44.51	62.09	68.20	-6.11	Pk
Vertical	15840.36	60.63	9.79	38.8	44.10	65.11	74.00	-8.89	Pk
Vertical	15840.36	39.70	9.70	38.8	42.70	45.49	54.00	-8.51	AV
Horizontal	3869.48	60.64	6.11	36.37	44.05	59.07	74.00	-14.93	Pk
Horizontal	3869.48	40.00	6.27	36.37	44.05	38.59	54.00	-15.41	AV
Horizontal	10560.74	60.13	8.33	38.64	44.50	62.60	68.20	-5.60	Pk
Horizontal	15840.37	60.98	9.99	38.38	44.10	65.25	74.00	-8.75	Pk
Horizontal	15840.37	39.02	9.81	38.38	44.10	43.11	54.00	-10.89	AV

High Channel (5320 MHz)-Above 1G									
Vertical	5366.52	60.16	6.96	37.24	43.50	60.86	74.00	-13.14	Pk
Vertical	5366.52	40.60	7.07	37.24	43.50	41.41	54.00	-12.59	AV
Vertical	10640.58	60.46	8.14	37.68	44.50	61.78	74.00	-12.22	Pk
Vertical	10640.58	39.71	8.35	37.68	44.50	41.24	54.00	-12.76	AV
Vertical	15960.41	40.63	10.11	38.8	44.10	45.44	74.00	-28.56	Pk
Vertical	15960.41	39.83	9.64	38.8	42.70	45.57	54.00	-8.43	AV
Horizontal	5436.59	59.94	7.05	37.24	43.50	60.73	74.00	-13.27	Pk
Horizontal	5436.59	40.99	7.05	37.24	43.50	41.78	54.00	-12.22	AV
Horizontal	10640.24	60.22	8.20	38.57	44.50	62.49	74.00	-11.51	Pk
Horizontal	10640.24	40.97	8.03	38.57	44.50	43.07	54.00	-10.93	AV
Horizontal	15960.88	50.74	9.81	38.38	44.10	54.83	74.00	-19.17	Pk
Horizontal	15960.88	40.96	9.96	38.38	44.10	45.20	54.00	-8.80	AV

Note: ANT 1 802.11ac20(5G) mode is the worst mode. PK value is lower than the Average value limit, So average didn't record.

The amplitude of spurious emissions that are attenuated by more than 20dB below the permissible value has no need to be reported.

Emission level (dBuV/m) = 20 log Emission level (uV/m).

Corrected Reading: Antenna Factor + Cable Loss + Read Level - Preamp Factor = Level.

EUT :	access-ER HF NFC/FAP30	Model Name. :	access-ER
Temperature :	20 °C	Relative Humidity :	48%
Pressure :	1010 hPa	Test Voltage :	DC 3.85V
Test Mode :	TX(5.6G) - 802.11ac20 _5500~5700MHz		

Polar	Frequency	Meter Reading	Cable loss	Antenna Factor	Preamp Factor	Emission Level	Limits	Margin	Detector Type
(H/V)	(MHz)	(dBuV)	(dB)	dB/m	(dB)	(dBuV/m)	(dBuV/m)	(dB)	
Low Channel (5500 MHz)-Above 1G									
Vertical	5433.02	60.15	5.61	35.40	44.00	57.16	74.00	-16.84	Pk
Vertical	5433.02	50.47	5.76	35.40	44.00	47.63	54.00	-6.37	AV
Vertical	11000.25	60.59	8.24	39.75	44.50	64.08	74.00	-9.92	Pk
Vertical	11000.25	39.64	8.35	39.75	44.50	43.24	54.00	-10.76	AV
Vertical	16500.41	59.95	10.05	38.80	44.10	64.70	68.20	-3.50	Pk
Horizontal	5126.47	60.31	5.78	35.18	44.00	57.27	74.00	-16.73	Pk
Horizontal	5126.47	50.28	5.66	35.18	44.00	47.13	54.00	-6.87	AV
Horizontal	11000.32	60.68	8.22	38.71	44.50	63.11	74.00	-10.89	Pk
Horizontal	11000.32	40.28	8.14	38.71	44.50	42.64	54.00	-11.36	AV
Horizontal	16500.47	57.05	10.04	38.38	44.10	61.37	68.20	-6.83	Pk
Middle Channel (5600 MHz)-Above 1G									
Vertical	4933.25	60.65	6.29	36.35	44.05	59.24	74.00	-14.76	Pk
Vertical	4933.25	50.83	6.24	36.35	44.05	49.37	54.00	-4.63	AV
Vertical	11200.58	59.83	8.24	37.88	44.51	61.44	74.00	-12.56	Pk
Vertical	11200.58	39.22	8.13	37.88	44.51	40.71	54.00	-13.29	AV
Vertical	16800.45	60.39	9.71	38.80	44.10	64.80	68.20	-3.40	Pk
Horizontal	4766.32	59.29	6.44	36.37	44.05	58.05	74.00	-15.95	Pk
Horizontal	4766.32	49.94	6.13	36.37	44.05	48.39	54.00	-5.61	AV
Horizontal	11200.45	59.16	8.31	38.64	44.50	61.61	74.00	-12.39	Pk
Horizontal	11200.45	40.69	8.04	38.64	44.50	42.87	54.00	-11.13	AV
Horizontal	16800.33	56.36	10.09	38.38	44.10	60.72	68.20	-7.48	Pk

High Channel (5700 MHz)-Above 1G									
Vertical	5647.33	59.61	6.79	37.24	43.50	60.13	68.20	-8.07	Pk
Vertical	11400.29	59.35	8.10	37.68	44.50	60.63	74.00	-13.37	Pk
Vertical	11400.29	40.06	8.23	37.68	44.50	41.47	54.00	-12.53	AV
Vertical	17100.54	49.95	9.70	38.80	44.10	54.36	68.20	-13.84	Pk
Horizontal	5433.26	60.27	6.74	37.24	43.50	60.75	74.00	-13.25	Pk
Horizontal	5433.26	40.44	6.74	37.24	43.50	40.92	54.00	-13.08	AV
Horizontal	11400.43	49.51	8.25	38.57	44.50	51.83	74.00	-22.17	Pk
Horizontal	11400.43	39.08	8.35	38.57	44.50	41.50	54.00	-12.50	AV
Horizontal	17100.58	39.64	9.70	38.38	44.10	43.61	68.20	-24.59	Pk

Note: "802.11ac20(5G)" mode is the worst mode. PK value is lower than the Average value limit, So average didn't record.

The amplitude of spurious emissions that are attenuated by more than 20dB below the permissible value has no need to be reported.

Emission level (dBuV/m) = 20 log Emission level (uV/m).

Corrected Reading: Antenna Factor + Cable Loss + Read Level - Preamp Factor = Level.

**2.2.10 TEST RESULTS (18GHz-40GHz)**

EUT :	access-ER HF NFC/FAP30	Model Name. :	access-ER
Temperature :	20 °C	Relative Humidity :	48%
Pressure :	1010 hPa	Test Voltage :	DC 3.85V
Test Mode :	TX (5.2G)-802.11ac40 5190MHz~5230MHz; TX (5.3G)-802.11n40 5270MHz~5310MHz; TX (5.6G)-802.11n20 5500MHz~5700MHz;		

All the modulation modes have been tested, and the worst result was report as below:

Low Channel (5190 MHz)-Above 1G

Horizontal

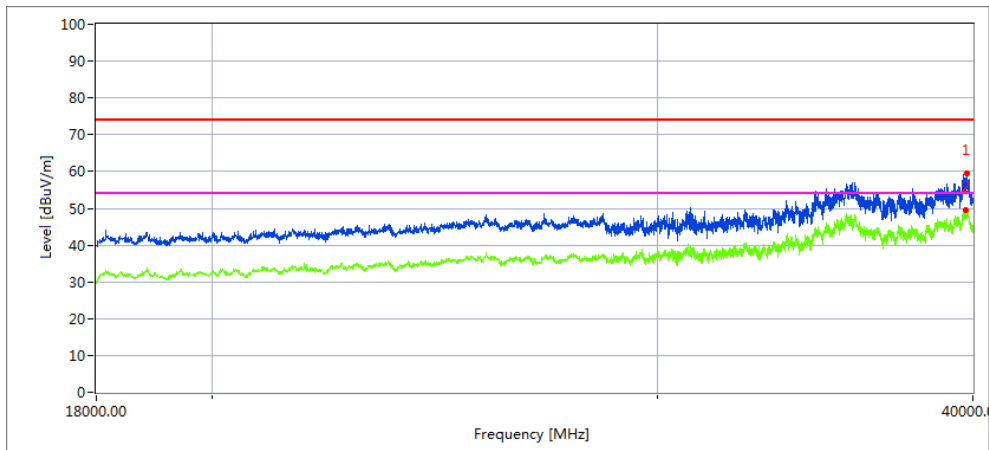

Frequency	Meter Reading	Cable loss	Antenna Factor	Preamp Factor	Emission Level	Limits	Margin	Remark
39769.27	41.45	20.09	44.07	43.48	62.13	68.2	6.07	Peak
39767.19	28.52	20.09	44.04	43.48	49.17	54	4.83	AVG

Vertical

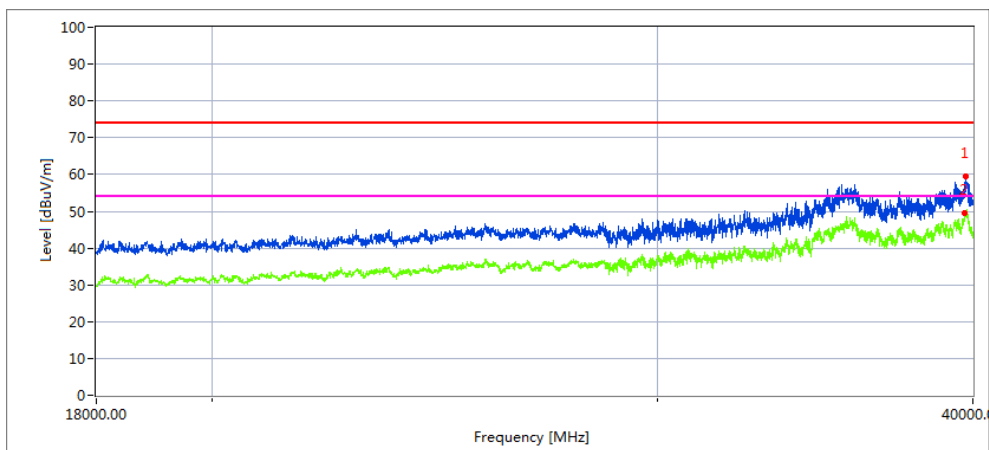

Frequency	Meter Reading	Cable loss	Antenna Factor	Preamp Factor	Emission Level	Limits	Margin	Remark
39769.546	43.95	20.09	44.07	43.48	64.63	68.2	3.57	Peak
39769.365	28.08	20.09	44.04	43.48	48.73	54	5.27	AVG

### High Channel (5230 MHz)-Above 1G

Horizontal

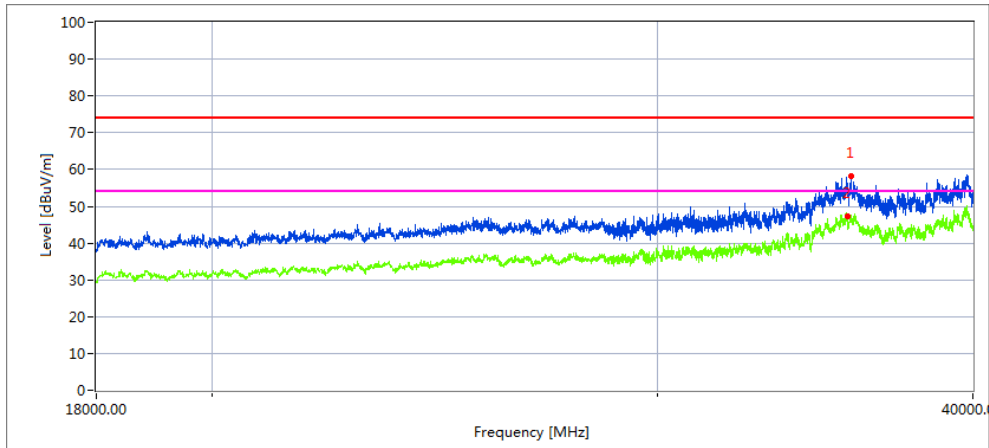

Frequency	Meter Reading	Cable loss	Antenna Factor	Preamp Factor	Emission Level	Limits	Margin	Remark
35628.37	44.16	19.11	42.73	44.61	61.39	68.2	6.81	Peak
35596.986	30.22	19.11	42.73	44.61	47.45	54	6.55	AVG

Vertical

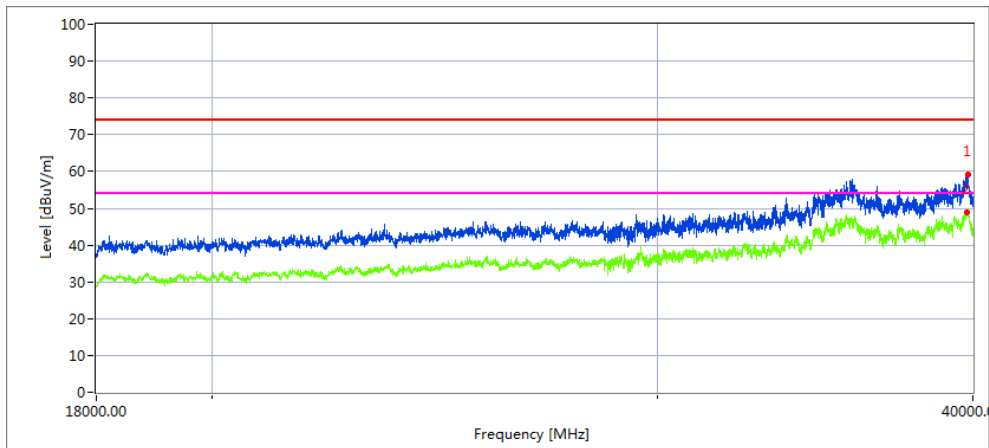

Frequency	Meter Reading	Cable loss	Antenna Factor	Preamp Factor	Emission Level	Limits	Margin	Remark
39769.476	43.09	20.09	44.07	43.48	63.77	68.2	4.43	Peak
39769.476	28.96	20.09	44.04	43.48	49.61	54	4.39	AVG

Note:802.11 ac40 mode is the worst mode.



Low Channel (5270 MHz)-Above 1G

Horizontal

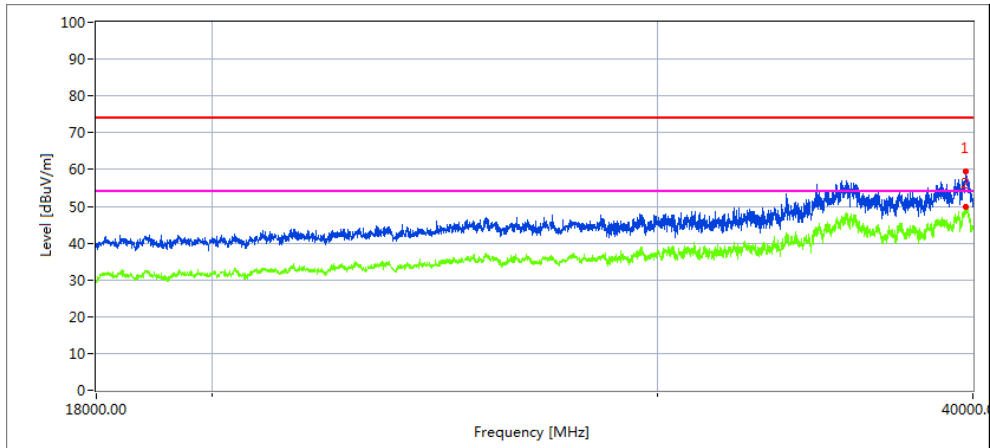

Frequency	Meter Reading	Cable loss	Antenna Factor	Preamp Factor	Emission Level	Limits	Margin	Remark
39176.23	43.93	19.98	43.84	44.62	63.13	68.2	5.07	Peak
39176.23	28.67	19.98	43.84	44.62	47.87	54	6.13	AVG

Vertical

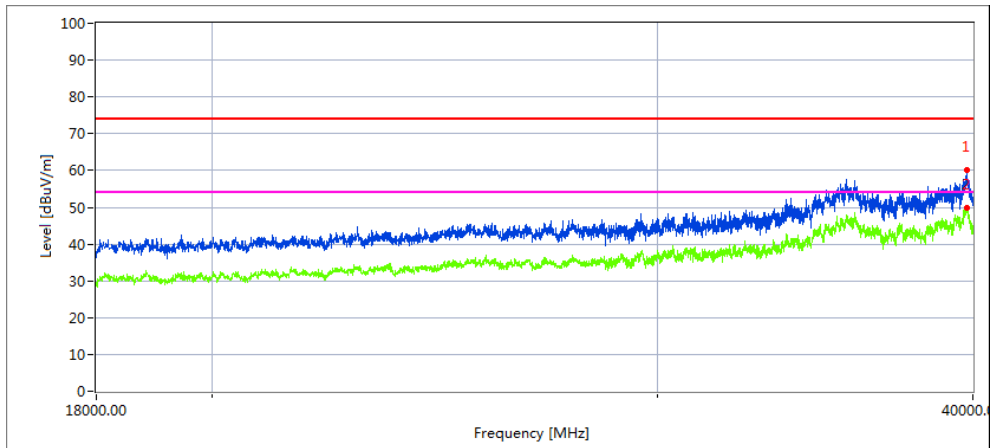

Frequency	Meter Reading	Cable loss	Antenna Factor	Preamp Factor	Emission Level	Limits	Margin	Remark
39385.84	40.73	20.01	44.06	42.69	62.11	68.2	6.09	Peak
39385.84	26.34	20.01	44.06	42.69	47.72	54	6.28	AVG

### High Channel (5310 MHz)-Above 1G

Horizontal

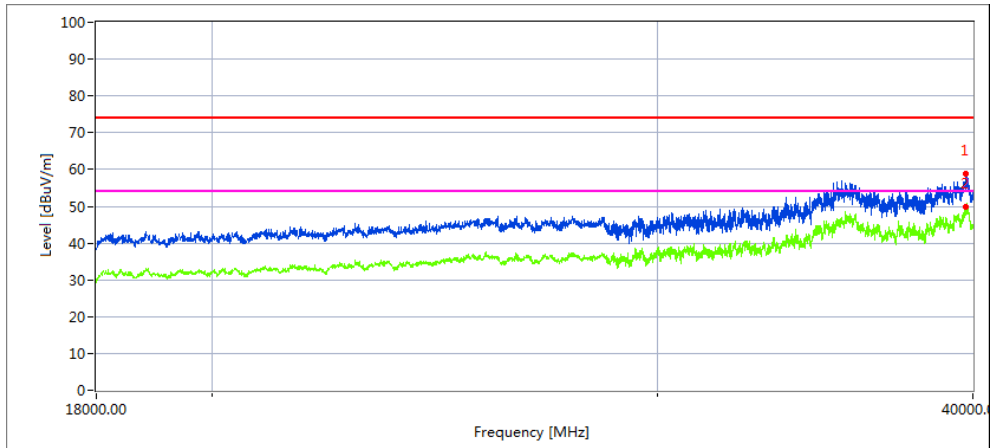

Frequency	Meter Reading	Cable loss	Antenna Factor	Preamp Factor	Emission Level	Limits	Margin	Remark
39176.94	43.87	19.98	43.84	44.62	63.07	68.2	5.13	Peak
39176.94	28.08	19.98	43.84	44.62	47.28	54	6.72	AVG

Vertical

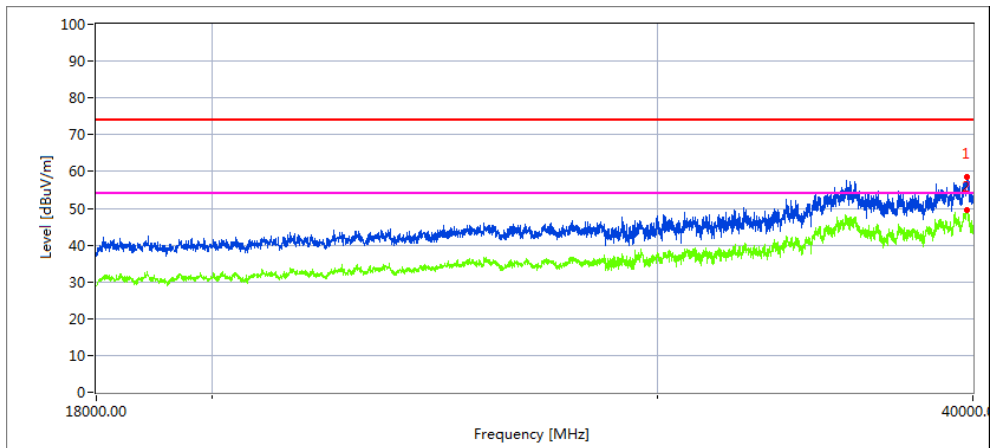

Frequency	Meter Reading	Cable loss	Antenna Factor	Preamp Factor	Emission Level	Limits	Margin	Remark
39369.174	40.34	20.01	44.06	42.69	61.72	68.2	6.48	Peak
39369.174	26.64	20.01	44.06	42.69	48.02	54	5.98	AVG

Note:802.11 n40 mode is the worst mode.

Low Channel (5500 MHz)-Above 1G

Horizontal

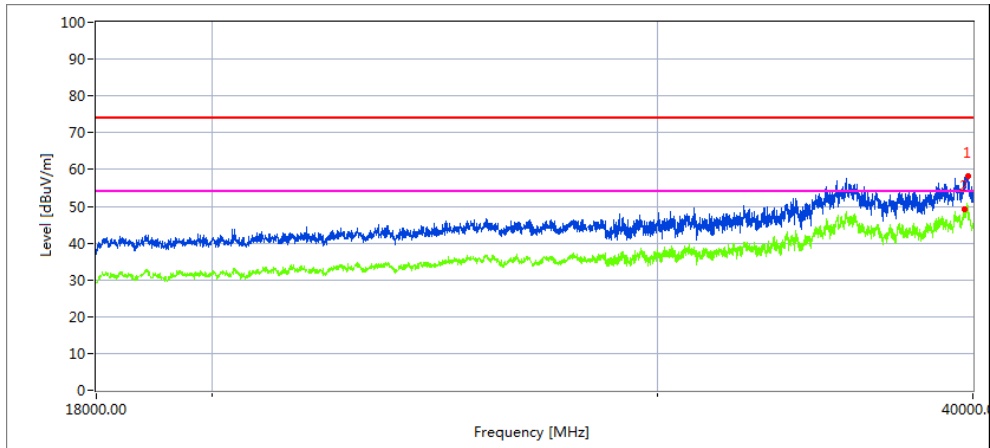

Frequency	Meter Reading	Cable loss	Antenna Factor	Preamp Factor	Emission Level	Limits	Margin	Remark
39696.437	43.58	20.09	44.07	43.48	64.26	68.2	3.94	Peak
39653.181	28.97	20.07	44.06	43.48	49.62	54	4.38	AVG

Vertical

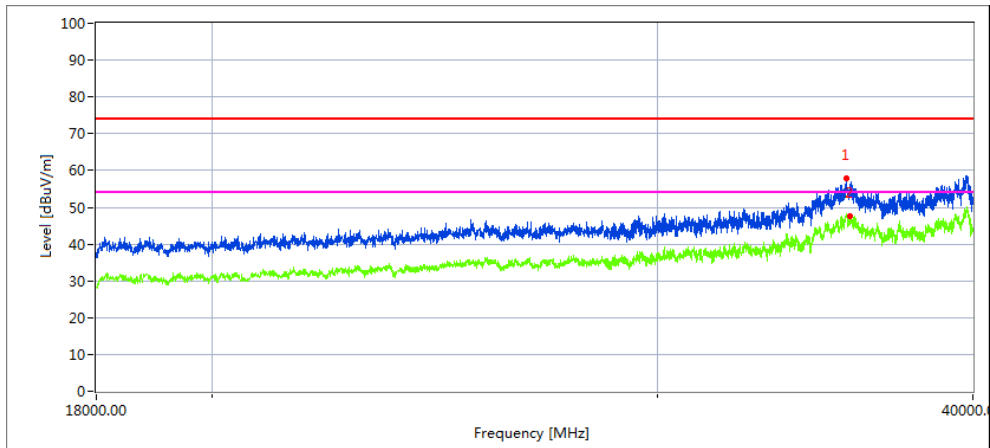

Frequency	Meter Reading	Cable loss	Antenna Factor	Preamp Factor	Emission Level	Limits	Margin	Remark
36575.641	43.47	19.16	42.61	41.56	63.68	68.2	4.52	Peak
36575.641	28.87	19.16	42.61	41.56	49.08	54	4.92	AVG

### High Channel (5700 MHz)-Above 1G

Horizontal

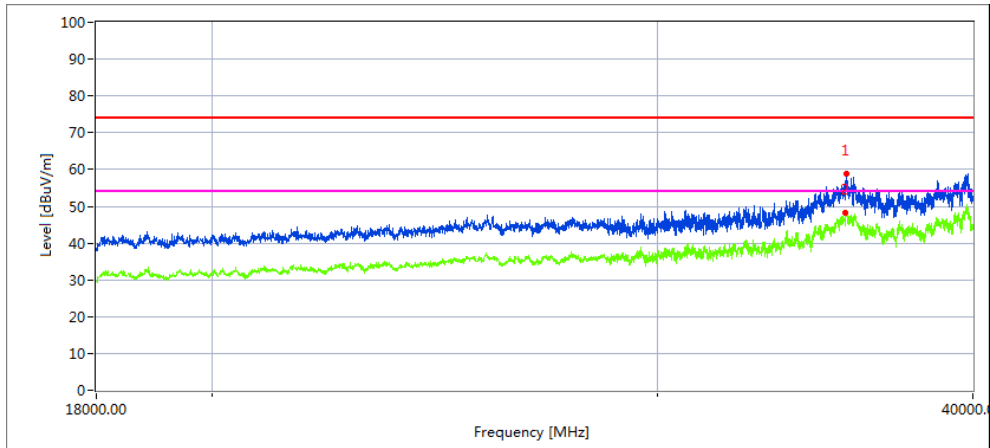

Frequency	Meter Reading	Cable loss	Antenna Factor	Preamp Factor	Emission Level	Limits	Margin	Remark
35794.5	43.97	19.17	42.63	42.74	63.03	68.2	5.17	Peak
35763.418	28.86	19.14	42.61	42.71	47.90	54	6.10	AVG

Vertical

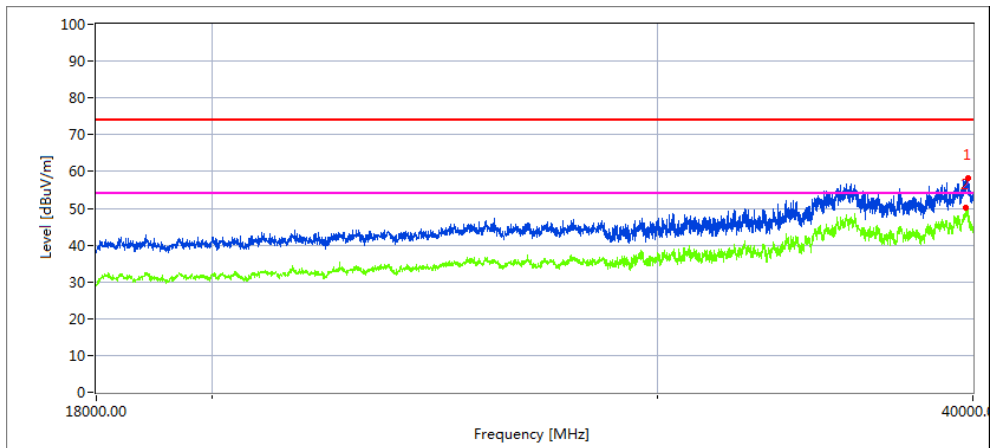

Frequency	Meter Reading	Cable loss	Antenna Factor	Preamp Factor	Emission Level	Limits	Margin	Remark
39816.733	43.86	20.09	42.63	43.48	63.10	68.2	5.10	Peak
39804.018	28.88	20.09	42.61	43.48	48.10	54	5.90	AVG

Note:802.11 n20 mode is the worst mode.

2.2.10 Spurious Emission in Restricted Band 4.5GHz~5.150 GHz& 5.350GHz~5460GHz

EUT :	access-ER HF NFC/FAP30	Model Name. :	access-ER
Temperature :	20 °C	Relative Humidity :	48%
Pressure :	1010 hPa	Test Voltage :	DC 3.85V
Test Mode :	TX (5.2G)-802.11ac20 5150MHz~5250MHz,		

All the modulation modes have been tested, The report just record the worst data mode.

Frequency	Meter Reading	Cable Loss	Antenna Factor	Preamp Factor	Emission Level	Limits	Margin	Detector	Comment
(MHz)	(dBμV)	(dB)	dB/m	(dB)	(dBμV/m)	(dBμV/m)	(dB)	Type	
5.2G WIFI-802.11a Mode									
4500	63.05	5.2	35.6	44.2	59.65	74	-14.35	Pk	Horizontal
4500	36.07	5.2	35.6	44.2	32.67	54	-21.33	AV	Horizontal
4500	63.76	5.2	35.6	44.2	60.36	74	-13.64	Pk	Horizontal
4500	33.55	5.2	35.6	44.2	30.15	54	-23.85	AV	Horizontal
5150	63.12	5.36	35.66	44.22	59.92	74	-14.08	Pk	Horizontal
5150	32.56	5.36	35.66	44.22	29.36	54	-24.64	AV	Horizontal
5150	62.50	5.36	35.66	44.22	59.30	74	-14.70	Pk	Vertical
5150	42.13	5.36	35.66	44.22	38.93	54	-15.07	AV	Vertical
5350	62.26	5.68	35.68	44.22	59.40	74	-14.60	Pk	Vertical
5350	34.62	5.68	35.68	44.22	31.76	54	-22.24	AV	Vertical
5350	63.11	5.68	35.68	44.22	60.25	74	-13.75	Pk	Horizontal
5350	38.78	5.68	35.68	44.22	35.92	54	-18.08	AV	Horizontal

Note: (1) Emission Level= Antenna Factor + Cable Loss + Read Level - Preamp Factor  
 (2) "802.11ac20" mode is the worst mode. When PK value is lower than the Average value limit, average don't record.

EUT :	access-ER HF NFC/FAP30	Model Name. :	access-ER
Temperature :	20 °C	Relative Humidity :	48%
Pressure :	1010 hPa	Test Voltage :	DC 3.85V
Test Mode :	TX (5.3G)-802.11ac20 5250MHz~5350MHz,		

All the modulation modes have been tested, The report just record the worst data mode.

Polar	Frequency	Meter Reading	Cable loss	Antenna Factor	Preamp Factor	Emission Level	Limits	Margin	Detector Type
(H/V)	(MHz)	(dBuV)	(dB)	dB/m	(dB)	(dBuV/m)	(dBuV/m)	(dB)	
High Channel (5320 MHz)-Above 1G									
Vertical	5350.00	66.06	6.96	37.24	43.50	66.76	74.00	-7.24	Pk
Vertical	5350.00	47.66	7.07	37.24	43.50	48.47	54.00	-5.53	AV
Horizontal	5350.00	67.87	7.05	37.24	43.50	68.66	74.00	-5.34	Pk
Horizontal	5350.00	43.33	7.05	37.24	43.50	44.12	54.00	-9.88	AV

Note: (1) Emission Level= Antenna Factor + Cable Loss + Read Level - Preamp Factor

(2) "802.11ac20 " mode is the worst mode. When PK value is lower than the Average value limit, average don't record.

EUT :	access-ER HF NFC/FAP30	Model Name. :	access-ER
Temperature :	20 °C	Relative Humidity :	48%
Pressure :	1010 hPa	Test Voltage :	DC 3.85V
Test Mode :	TX (5.6G)-802.11ac20 5470MHz~5725MHz,		

All the modulation modes have been tested, The report just record the worst data mode.

Polar	Frequency	Meter Reading	Cable loss	Antenna Factor	Preamp Factor	Emission Level	Limits	Margin	Detector Type
(H/V)	(MHz)	(dBuV)	(dB)	dB/m	(dB)	(dBuV/m)	(dBuV/m)	(dB)	
Low Channel (5500 MHz)-Above 1G									
Vertical	5460.00	67.06	5.61	35.40	44.00	64.07	74.00	-9.93	Pk
Vertical	5460.00	46.71	5.76	35.40	44.00	43.87	54.00	-10.13	AV
Horizontal	5460.00	66.27	5.78	35.18	44.00	63.23	74.00	-10.77	Pk
Horizontal	5460.00	43.65	5.66	35.18	44.00	40.50	54.00	-13.50	AV

Note: (1) Emission Level= Antenna Factor + Cable Loss + Read Level - Preamp Factor

(2) "802.11ac20 " mode is the worst mode. When PK value is lower than the Average value limit, average don't record.

### 3. POWER SPECTRAL DENSITY TEST

#### 3.1 APPLIED PROCEDURES / LIMIT

##### According to FCC §15.407(a)

For the band 5.15-5.25 GHz,

- (i) For an outdoor access point operating in the band 5.15-5.25 GHz, the maximum power spectral density shall not exceed 17 dBm in any 1 megahertz band. If transmitting antennas of directional gain greater than 6 dBi are used, both the maximum conducted output power and the maximum power spectral density shall be reduced by the amount in dB that the directional gain of the antenna exceeds 6 dBi. The maximum e.i.r.p. at any elevation angle above 30 degrees as measured from the horizon must not exceed 125 mW (21 dBm).
- (ii) For an indoor access point operating in the band 5.15-5.25 GHz, the maximum power spectral density shall not exceed 17 dBm in any 1 megahertz band. If transmitting antennas of directional gain greater than 6 dBi are used, both the maximum conducted output power and the maximum power spectral density shall be reduced by the amount in dB that the directional gain of the antenna exceeds 6 dBi.
- (iii) For fixed point-to-point access points operating in the band 5.15-5.25 GHz, the maximum power spectral density shall not exceed 17 dBm in any 1 megahertz band. Fixed point-to-point U-NII devices may employ antennas with directional gain up to 23 dBi without any corresponding reduction in the maximum conducted output power or maximum power spectral density. For fixed point-to-point transmitters that employ a directional antenna gain greater than 23 dBi, a 1 dB reduction in maximum conducted output power and maximum power spectral density is required for each 1 dB of antenna gain in excess of 23 dBi. Fixed, point-to-point operations exclude the use of point-to-multipoint systems, omnidirectional applications, and multiple collocated transmitters transmitting the same information. The operator of the U-NII device, or if the equipment is professionally installed, the installer, is responsible for ensuring that systems employing high gain directional antennas are used exclusively for fixed, point-to-point operations.
- (iv) For client devices in the 5.15-5.25 GHz band, the maximum power spectral density shall not exceed 11 dBm in any 1 megahertz band. If transmitting antennas of directional gain greater than 6 dBi are used, both the maximum conducted output power and the maximum power spectral density shall be reduced by the amount in dB that the directional gain of the antenna exceeds 6 dBi.

For the 5.25-5.35 GHz and 5.47-5.725 GHz bands, the maximum conducted output power over the frequency bands of operation shall not exceed the lesser of 250 mW or  $11 \text{ dBm} + 10 \log B$ , where B is the 26 dB emission bandwidth in megahertz. In addition, the maximum power spectral density shall not exceed 11 dBm in any 1 megahertz band. If transmitting antennas of directional gain greater than 6 dBi are used, both the maximum conducted output power and the maximum power spectral density shall be reduced by the amount in dB that the directional gain of the antenna exceeds 6 dBi.

For the band 5.725-5.85 GHz

- (3) For the band 5.725-5.85 GHz, the maximum power spectral density shall not exceed 30 dBm in any 500-kHz band. If transmitting antennas of directional gain greater than 6 dBi are used, both the maximum conducted output power and the maximum power spectral density shall be reduced by the amount in dB that the directional gain of the antenna exceeds 6 dBi.



### 3.2 TEST PROCEDURE

For devices operating in the bands 5.15-5.25 GHz, 5.25-5.35 GHz, and 5.47-5.725 GHz, the above procedures make use of 1 MHz RBW to satisfy directly the 1 MHz reference bandwidth specified in § 15.407(a)(5). For devices operating in the band 5.725-5.85 GHz, the rules specify a measurement bandwidth of 500 kHz. Many spectrum analyzers do not have 500 kHz RBW, thus a narrower RBW may need to be used. The rules permit the use of a RBWs less than 1 MHz, or 500 kHz, “provided that the measured power is integrated over the full reference bandwidth” to show the total power over the specified measurement bandwidth (i.e., 1 MHz, or 500 kHz). If measurements are performed using a reduced resolution bandwidth (< 1 MHz, or < 500 kHz) and integrated over 1 MHz, or 500 KHz bandwidth, the following adjustments to the procedures apply:

- a) Set  $RBW \geq 1/T$ , where T is defined in section II.B.I.a).
- b) Set  $VBW \geq 3 RBW$ .
- c) If measurement bandwidth of Maximum PSD is specified in 500 kHz, add  $10\log(500\text{kHz}/RBW)$  to the measured result, whereas  $RBW (< 500 \text{ KHz})$  is the reduced resolution bandwidth of the spectrum analyzer set during measurement.
- d) If measurement bandwidth of Maximum PSD is specified in 1 MHz, add  $10\log(1\text{MHz}/RBW)$  to the measured result, whereas  $RBW (< 1 \text{ MHz})$  is the reduced resolution bandwidth of spectrum analyzer set during measurement.
- e) Care must be taken to ensure that the measurements are performed during a period of continuous transmission or are corrected upward for duty cycle.

Note: As a practical matter, it is recommended to use reduced RBW of 100 KHz for the sections 5.c) and 5.d) above, since  $RBW=100 \text{ KHz}$  is available on nearly all spectrum analyzers.

### 3.3 DEVIATION FROM STANDARD

No deviation.

### 3.4 TEST SETUP

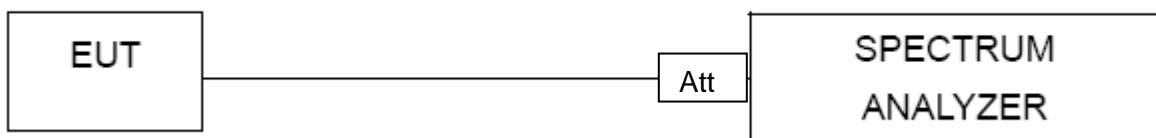

### 3.5 EUT OPERATION CONDITIONS

The EUT tested system was configured as the statements of 2.1 Unless otherwise a special operating condition is specified in the follows during the testing.

**3.6 TEST RESULTS**

EUT :	access-ER HF NFC/FAP30	Model Name :	access-ER
Temperature :	26 °C	Relative Humidity :	54%
Pressure :	1015 hPa	Test Voltage :	DC 3.85V
Test Mode :	TX Frequency Band 1 (5150-5250MHz), Band 2A (5250-5350MHz), Band 2C (5470-5725MHz)		

Test data reference attachment.

## 4. 26DB & 99% EMISSION BANDWIDTH

### 4.1 APPLIED PROCEDURES / LIMIT

The maximum power spectral density is measured as a conducted emission by direct connection of a calibrated test instrument to the equipment under test. If the device cannot be connected directly, alternative techniques acceptable to the Commission may be used. Measurements in the 5.725-5.85 GHz band are made over a reference bandwidth of 500 kHz or the 26 dB emission bandwidth of the device, whichever is less. Measurements in the 5.15-5.25 GHz, 5.25-5.35 GHz, and the 5.47-5.725 GHz bands are made over a bandwidth of 1 MHz or the 26 dB emission bandwidth of the device, whichever is less. A narrower resolution bandwidth can be used, provided that the measured power is integrated over the full reference bandwidth.

### 4.2 TEST PROCEDURE

- a) Set RBW = approximately 1% of the emission bandwidth.
- b) Set the VBW > RBW.
- c) Detector = Peak.
- d) Trace mode = max hold.
- e) Measure the maximum width of the emission that is 26 dB down from the maximum of the emission. Compare this with the RBW setting of the analyzer. Readjust RBW and repeat measurement as needed until the RBW/EBW ratio is approximately 1%.

The following procedure shall be used for measuring (99 %) power bandwidth:

- 1. Set center frequency to the nominal EUT channel center frequency.
- 2. Set span = 1.5 times to 5.0 times the OBW.
- 3. Set RBW = 1 % to 5 % of the OBW
- 4. Set VBW  $\geq 3 \cdot$  RBW
- 5. Video averaging is not permitted. Where practical, a sample detection and single sweep mode shall be used. Otherwise, peak detection and max hold mode (until the trace stabilizes) shall be used.
- 6. Use the 99 % power bandwidth function of the instrument (if available).
- 7. If the instrument does not have a 99 % power bandwidth function, the trace data points are recovered and directly summed in power units. The recovered amplitude data points, beginning at the lowest frequency, are placed in a running sum until 0.5 % of the total is reached; that frequency is recorded as the lower frequency. The process is repeated until 99.5 % of the total is reached; that frequency is recorded as the upper frequency. The 99% occupied bandwidth is the difference between these two frequencies.

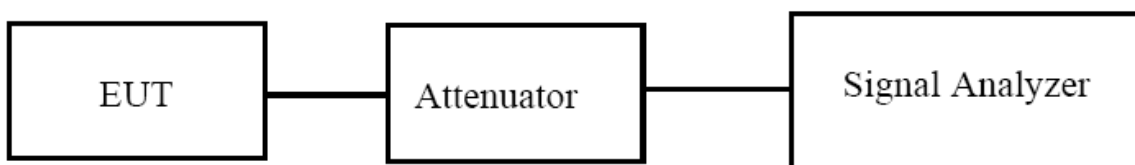

**4.3 EUT OPERATION CONDITIONS**

The EUT tested system was configured as the statements of 2.4 Unless otherwise a special operating condition is specified in the follows during the testing.

**4.4 TEST RESULTS**

EUT :	access-ER HF NFC/FAP30	Model Name :	access-ER
Temperature :	26 °C	Relative Humidity :	54%
Pressure :	1012 hPa	Test Voltage :	DC 3.85V
Test Mode :	TX Frequency Band 1 (5150-5250MHz), Band 2A (5250-5350MHz), Band 2C(5470-5725MHz)		

Test data reference attachment.

**5. MINIMUM 6 DB BANDWIDTH**

**5.1 APPLIED PROCEDURES / LIMIT**

**According to FCC §15.407(e)**

(e) Within the 5.725-5.85 GHz band, the minimum 6 dB bandwidth of U-NII devices shall be at least 500 kHz.

**5.2 TEST PROCEDURE**

Section 15.407(e) specifies the minimum 6 dB emission bandwidth of at least 500 KHz for the band 5.715-5.85 GHz. The following procedure shall be used for measuring this bandwidth:

- a) Set RBW = 100 kHz.
- b) Set the video bandwidth (VBW)  $\geq 3 \times$  RBW.
- c) Detector = Peak.
- d) Trace mode = max hold.
- e) Sweep = auto couple.
- f) Allow the trace to stabilize.
- g) Measure the maximum width of the emission that is constrained by the frequencies associated with the two outermost amplitude points (upper and lower frequencies) that are attenuated by 6 dB relative to the maximum level measured in the fundamental emission.

**5.3 DEVIATION FROM STANDARD**

No deviation.

**5.4 TEST SETUP**

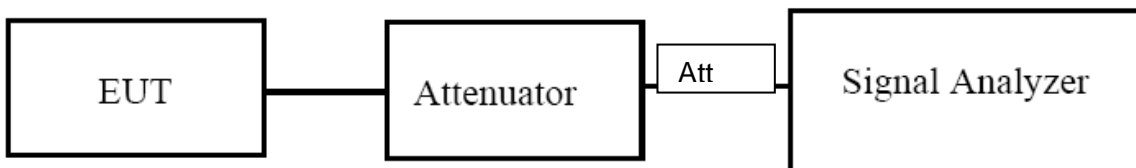

**5.5 EUT OPERATION CONDITIONS**

The EUT tested system was configured as the statements of 2.4 Unless otherwise a special operating condition is specified in the follows during the testing.

**5.6 TEST RESULTS**

EUT :	access-ER HF NFC/FAP30	Model Name :	access-ER
Temperature :	26 °C	Relative Humidity :	54%
Pressure :	1012 hPa	Test Voltage :	N/A
Test Mode :	N/A		

Note: Not Applicable

## 6. MAXIMUM CONDUCTED OUTPUT POWER

### 6.1 PPLIED PROCEDURES / LIMIT

#### According to FCC §15.407

The maximum conduced output power should not exceed:

Frequency Band(MHz)	Limit
5150~5250	250mW
5250~5350	250 mW or 11 dBm + 10 log B Note: The limit is the smaller of the two, "B" represents -26dB bandwidth.
5470~5725	250 mW or 11 dBm + 10 log B Note: The limit is the smaller of the two, "B" represents -26dB bandwidth.
5725~5850	1W

### 6.2 TEST PROCEDURE

- Method PM is Measurement using an RF average power meter. The procedure for this method is as follows:
  - a) Measurements may be performed using a wideband RF power meter with a thermocouple detector or equivalent if all of the following conditions are satisfied:
    - 1) The EUT is configured to transmit continuously, or to transmit with a constant duty cycle.
    - 2) At all times when the EUT is transmitting, it shall be transmitting at its maximum power control level.
    - 3) The integration period of the power meter exceeds the repetition period of the transmitted signal by at least a factor of five.
  - b) If the transmitter does not transmit continuously, measure the duty cycle D of the transmitter output signal as described in 12.2.
  - c) Measure the average power of the transmitter. This measurement is an average over both the ON and OFF periods of the transmitter.
  - d) Adjust the measurement in dBm by adding  $[10 \log (1 / D)]$ , where D is the duty cycle {e.g.,  $[10 \log (1 / 0.25)]$ , if the duty cycle is 25%}.

### 6.3 DEVIATION FROM STANDARD

No deviation.

### 6.4 TEST SETUP

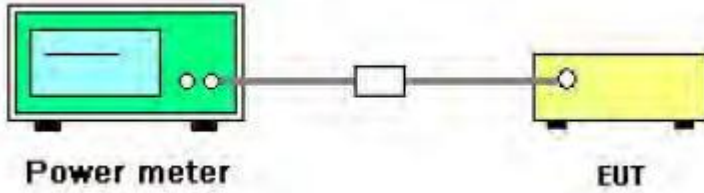

### 6.5 EUT OPERATION CONDITIONS

The EUT tested system was configured as the statements of 2.4 Unless otherwise a special operating condition is specified in the follows during the testing.



**6.2 TEST RESULTS**

EUT :	access-ER HF NFC/FAP30	Model Name :	access-ER
Temperature :	26 °C	Relative Humidity :	54%
Pressure :	1012 hPa	Test Voltage :	DC 3.85V
Test Mode :	TX (5G) Mode Frequency Band 1 (5150-5250MHz), Band 2A (5250-5350MHz) Band 2C, (5470-5725MHz)		

Test data reference attachment.

## 7. OUT OF BAND EMISSIONS

### 7.1 APPLICABLE STANDARD

#### According to FCC §15.407(b)

Undesirable emission limits. Except as shown in paragraph (b)(7) of this section, the maximum emissions outside of the frequency bands of operation shall be attenuated in accordance with the following limits:

- (1) For transmitters operating in the 5.15-5.25 GHz band: All emissions outside of the 5.15-5.35 GHz band shall not exceed an e.i.r.p. of  $-27$  dBm/MHz.
- (2) For transmitters operating in the 5.25-5.35 GHz band: All emissions outside of the 5.15-5.35 GHz band shall not exceed an e.i.r.p. of  $-27$  dBm/MHz.
- (3) For transmitters operating in the 5.47-5.725 GHz band: All emissions outside of the 5.47-5.725 GHz band shall not exceed an e.i.r.p. of  $-27$  dBm/MHz.
- (4) For transmitters operating in the 5.725-5.85 GHz band:
  - (i) All emissions shall be limited to a level of  $-27$  dBm/MHz at 75 MHz or more above or below the band edge increasing linearly to 10 dBm/MHz at 25 MHz above or below the band edge, and from 25 MHz above or below the band edge increasing linearly to a level of 15.6 dBm/MHz at 5 MHz above or below the band edge, and from 5 MHz above or below the band edge increasing linearly to a level of 27 dBm/MHz at the band edge.
  - (ii) Devices certified before March 2, 2017 with antenna gain greater than 10 dBi may demonstrate compliance with the emission limits in §15.247(d), but manufacturing, marketing and importing of devices certified under this alternative must cease by March 2, 2018. Devices certified before March 2, 2018 with antenna gain of 10 dBi or less may demonstrate compliance with the emission limits in §15.247(d), but manufacturing, marketing and importing of devices certified under this alternative must cease before March 2, 2020.

### 7.2 TEST PROCEDURE

1. Check the calibration of the measuring instrument using either an internal calibrator or a known signal from an external generator.
2. Position the EUT without connection to measurement instrument. Turn on the EUT and connect its antenna terminal to measurement instrument via a low loss cable. Then set it to any one measured frequency within its operating range, and make sure the instrument is operated in its linear range.
3. Set RBW of spectrum analyzer to 1 MHz with a convenient frequency span.
4. Measure the highest amplitude appearing on spectral display and set it as a reference level. Plot

the graph with marking the highest point and edge frequency.

5. Repeat above procedures until all measured frequencies were complete.

### 7.3 DEVIATION FROM STANDARD

No deviation.

### 7.4 TEST SETUP

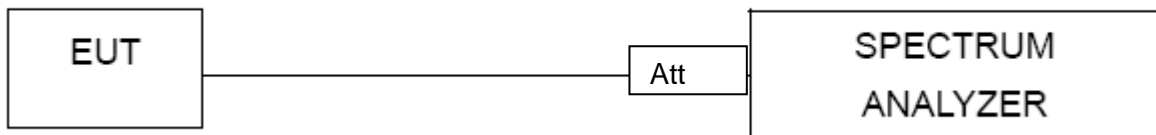

### 7.5 EUT OPERATION CONDITIONS

The EUT tested system was configured as the statements of 2.4 Unless otherwise a special operating condition is specified in the follows during the testing.

### 7.6 TEST RESULTS

EUT :	access-ER HF NFC/FAP30	Model Name :	access-ER
Temperature :	26 °C	Relative Humidity :	54%
Pressure :	1012 hPa	Test Voltage :	DC 3.85V

Test data reference attachment.

### 8. Frequency Stability Measurement

#### 8.1 LIMIT

Manufactures of U-NII devices are responsible for ensuring frequency stability such that an emission is maintained within the band of operation under all conditions of normal operation as specified in the user's manual.

#### 8.2 TEST PROCEDURES

1. The transmitter output (antenna port) was connected to the spectrum analyzer.
2. EUT have transmitted absence of modulation signal and fixed channelize.
3. Set the spectrum analyzer span to view the entire absence of modulation emissions bandwidth.
4. Set RBW = 10 kHz, VBW = 10 kHz with peak detector and maxhold settings.
5.  $f_c$  is declaring of channel frequency. Then the frequency error formula is  $(f_c - f) / f_c \times 10^6$  ppm and the limit is less than  $\pm 20$  ppm (IEEE 802.11 specification).
6. The test extreme voltage is to change the primary supply voltage from 85 to 115 percent of the nominal value
7. Extreme temperature is  $-20^\circ\text{C} \sim 70^\circ\text{C}$ .

#### 8.3 TEST SETUP LAYOUT

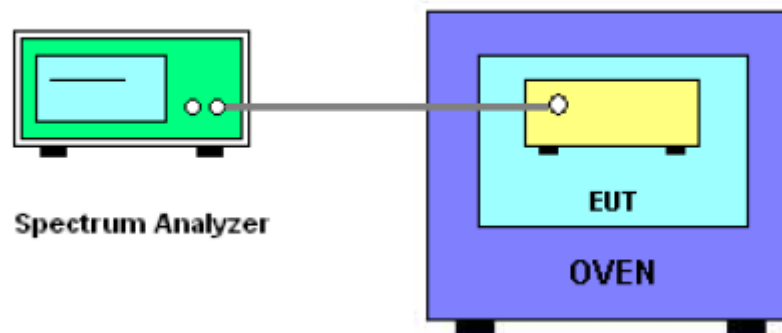

#### 8.4 EUT OPERATION DURING TEST

1. The EUT was programmed to be in continuously un-modulation transmitting mode.

8.5 TEST RESULTS

EUT :	access-ER HF NFC/FAP30	Model Name. :	access-ER
Temperature :	25 °C	Relative Humidity :	56%
Pressure :	1012 hPa	Test Voltage :	DC 3.85V
Test Mode :	TX Frequency Band I (5150-5250MHz)		

Voltage vs. Frequency Stability

TEST CONDITIONS				Reference Frequency: 5180MHz			
				f	fc	Max. Deviation (MHz)	Max. Deviation (ppm)
T nom (°C)	20	V nom (V)	3.85	5180.0051	5180	0.0051	-0.9767
		V max (V)	4.2	5180.0089	5180	0.0089	-1.7146
		V min (V)	3.4	5180.0008	5180	0.0008	-0.1531
Limits				Within 5150-5250MHz			
Result				Complies			

Temperature vs. Frequency Stability

TEST CONDITIONS				Reference Frequency: 5180MHz			
				f	fc	Max. Deviation (MHz)	Max. Deviation (ppm)
V nom (V)	3.85	T (°C)	-20	5180.0041	5180	0.0041	-0.7840
		T (°C)	-10	5180.0078	5180	0.0078	-1.5070
		T (°C)	0	5180.0048	5180	0.0048	-0.9299
		T (°C)	10	5180.0073	5180	0.0073	-1.4153
		T (°C)	20	5180.0086	5180	0.0086	-1.6620
		T (°C)	30	5180.0022	5180	0.0022	-0.4186
		T (°C)	40	5180.0078	5180	0.0078	-1.5085
		T (°C)	50	5180.0019	5180	0.0019	-0.3754
		T (°C)	60	5180.0010	5180	0.0010	-0.2018
		T (°C)	70	5180.0039	5180	0.0039	-0.7483
Limits				Within 5150-5250MHz			
Result				Complies			

Voltage vs. Frequency Stability

TEST CONDITIONS				Reference Frequency: 5200MHz			
				f	fc	Max. Deviation (MHz)	Max. Deviation (ppm)
T nom (°C)	20	V nom (V)	3.85	5200.0072	5200	0.0072	-1.3829
		V max (V)	4.2	5200.0077	5200	0.0077	-1.4810
		V min (V)	3.4	5200.0068	5200	0.0068	-1.3017
Limits				Within 5150-5250MHz			
Result				Complies			

Temperature vs. Frequency Stability

TEST CONDITIONS				Reference Frequency: 5200MHz			
				f	fc	Max. Deviation (MHz)	Max. Deviation (ppm)
V nom (V)	3.85	T (°C)	-20	5200.0076	5200	0.0076	-1.4607
		T (°C)	-10	5200.0026	5200	0.0026	-0.5094
		T (°C)	0	5200.0008	5200	0.0008	-0.1630
		T (°C)	10	5200.0066	5200	0.0066	-1.2670
		T (°C)	20	5200.0071	5200	0.0071	-1.3715
		T (°C)	30	5200.0069	5200	0.0069	-1.3352
		T (°C)	40	5200.0056	5200	0.0056	-1.0822
		T (°C)	50	5200.0008	5200	0.0008	-0.1482
		T (°C)	60	5200.0016	5200	0.0016	-0.3048
		T (°C)	70	5200.0094	5200	0.0094	-1.8064
Limits				Within 5150-5250MHz			
Result				Complies			

Voltage vs. Frequency Stability

TEST CONDITIONS				Reference Frequency: 5240MHz			
				f	fc	Max. Deviation (MHz)	Max. Deviation (ppm)
T nom (°C)	20	V nom (V)	3.85	5240.0086	5240	0.0086	-1.6486
		V max (V)	4.2	5240.0075	5240	0.0075	-1.4368
		V min (V)	3.4	5240.0043	5240	0.0043	-0.8137
Limits				Within 5150-5250MHz			
Result				Complies			

Temperature vs. Frequency Stability

TEST CONDITIONS				Reference Frequency: 5240MHz			
				f	fc	Max. Deviation (MHz)	Max. Deviation (ppm)
V nom (V)	3.85	T (°C)	-20	5240.0079	5240	0.0079	-1.5069
		T (°C)	-10	5240.0099	5240	0.0099	-1.8938
		T (°C)	0	5240.0074	5240	0.0074	-1.4035
		T (°C)	10	5240.0031	5240	0.0031	-0.5949
		T (°C)	20	5240.0081	5240	0.0081	-1.5496
		T (°C)	30	5240.0041	5240	0.0041	-0.7755
		T (°C)	40	5240.0066	5240	0.0066	-1.2687
		T (°C)	50	5240.0087	5240	0.0087	-1.6648
		T (°C)	60	5240.0027	5240	0.0027	-0.5247
		T (°C)	70	5240.0014	5240	0.0014	-0.2764
Limits				Within 5150-5250MHz			
Result				Complies			



EUT :	access-ER HF NFC/FAP30	Model Name. :	access-ER
Temperature :	25 °C	Relative Humidity :	56%
Pressure :	1012 hPa	Test Voltage :	DC 3.85V
Test Mode :	TX Frequency Band 2A (5250-5350MHz)		

Voltage vs. Frequency Stability

TEST CONDITIONS				Reference Frequency: 5260MHz			
				f	fc	Max. Deviation (MHz)	Max. Deviation (ppm)
T nom (°C)	20	V nom (V)	3.85	5260.0038	5260	0.00383	-0.7287
		V max (V)	4.2	5260.0003	5260	0.00029	-0.0561
		V min (V)	3.4	5260.0073	5260	0.00726	-1.3800
Limits				Within 5250-5350MHz			
Result				Complies			

Temperature vs. Frequency Stability

TEST CONDITIONS				Reference Frequency: 5260MHz			
				f	fc	Max. Deviation (MHz)	Max. Deviation (ppm)
V nom (V)	3.85	T (°C)	-20	5260.0039	5260	0.00390	-0.7420
		T (°C)	-10	5260.0025	5260	0.00253	-0.4818
		T (°C)	0	5260.0029	5260	0.00288	-0.5467
		T (°C)	10	5260.0050	5260	0.00500	-0.9509
		T (°C)	20	5260.0041	5260	0.00407	-0.7745
		T (°C)	30	5260.0094	5260	0.00935	-1.7784
		T (°C)	40	5260.0023	5260	0.00233	-0.4434
		T (°C)	50	5260.0096	5260	0.00956	-1.8174
		T (°C)	60	5260.0054	5260	0.00539	-1.0246
		T (°C)	70	5260.0045	5260	0.00450	-0.8546
Limits				Within 5250-5350MHz			
Result				Complies			

Voltage vs. Frequency Stability

TEST CONDITIONS				Reference Frequency: 5280MHz			
				f	fc	Max. Deviation (MHz)	Max. Deviation (ppm)
T nom (°C)	20	V nom (V)	3.85	5280.0076	5280	0.00764	-1.4473
		V max (V)	4.2	5280.0067	5280	0.00668	-1.2647
		V min (V)	3.4	5280.0022	5280	0.00224	-0.4236
Limits				Within 5250-5350MHz			
Result				Complies			

Temperature vs. Frequency Stability

TEST CONDITIONS				Reference Frequency: 5280MHz			
				f	fc	Max. Deviation (MHz)	Max. Deviation (ppm)
V nom (V)	3.85	T (°C)	-20	5280.0028	5280	0.00281	-0.5316
		T (°C)	-10	5280.0041	5280	0.00410	-0.7762
		T (°C)	0	5280.0099	5280	0.00987	-1.8701
		T (°C)	10	5280.0011	5280	0.00106	-0.2013
		T (°C)	20	5280.0033	5280	0.00330	-0.6242
		T (°C)	30	5280.0075	5280	0.00752	-1.4241
		T (°C)	40	5280.0042	5280	0.00419	-0.7944
		T (°C)	50	5280.0052	5280	0.00523	-0.9906
		T (°C)	60	5280.0066	5280	0.00659	-1.2488
		T (°C)	70	5280.0083	5280	0.00832	-1.5751
Limits				Within 5250-5350MHz			
Result				Complies			

Voltage vs. Frequency Stability

TEST CONDITIONS				Reference Frequency: 5320MHz			
				f	fc	Max. Deviation (MHz)	Max. Deviation (ppm)
T nom (°C)	20	V nom (V)	3.85	5320.0064	5320	0.00637	-1.1976
		V max (V)	4.2	5320.0060	5320	0.00599	-1.1252
		V min (V)	3.4	5320.0025	5320	0.00248	-0.4654
Limits				Within 5250-5350MHz			
Result				Complies			

Temperature vs. Frequency Stability

TEST CONDITIONS				Reference Frequency: 5320MHz			
				f	fc	Max. Deviation (MHz)	Max. Deviation (ppm)
V nom (V)	3.85	T (°C)	-20	5320.0056	5320	0.00559	-1.0504
		T (°C)	-10	5320.0021	5320	0.00207	-0.3891
		T (°C)	0	5320.0078	5320	0.00780	-1.4654
		T (°C)	10	5320.0080	5320	0.00799	-1.5016
		T (°C)	20	5320.0040	5320	0.00403	-0.7570
		T (°C)	30	5320.0067	5320	0.00666	-1.2511
		T (°C)	40	5320.0079	5320	0.00787	-1.4787
		T (°C)	50	5320.0029	5320	0.00291	-0.5471
		T (°C)	60	5320.0046	5320	0.00464	-0.8715
		T (°C)	70	5320.0004	5320	0.00043	-0.0806
Limits				Within 5250-5350MHz			
Result				Complies			

EUT :	access-ER HF NFC/FAP30	Model Name. :	access-ER
Temperature :	25 °C	Relative Humidity :	56%
Pressure :	1012 hPa	Test Voltage :	DC 3.85V
Test Mode :	TX Frequency Band 2C (5470-5725MHz)		

Voltage vs. Frequency Stability

TEST CONDITIONS				Reference Frequency: 5500MHz			
				f	fc	Max. Deviation (MHz)	Max. Deviation (ppm)
T nom (°C)	20	V nom (V)	3.85	5500.0041	5500	0.00406	-0.7385
		V max (V)	4.2	5500.0007	5500	0.00072	-0.1318
		V min (V)	3.4	5500.0071	5500	0.00714	-1.2991
Limits				Within 5470-5725MHz			
Result				Complies			

Temperature vs. Frequency Stability

TEST CONDITIONS				Reference Frequency: 5500MHz			
				f	fc	Max. Deviation (MHz)	Max. Deviation (ppm)
V nom (V)	3.85	T (°C)	-20	5500.0075	5500	0.00749	-1.3612
		T (°C)	-10	5500.0052	5500	0.00524	-0.9529
		T (°C)	0	5500.0036	5500	0.00360	-0.6546
		T (°C)	10	5500.0046	5500	0.00464	-0.8439
		T (°C)	20	5500.0012	5500	0.00122	-0.2217
		T (°C)	30	5500.0075	5500	0.00747	-1.3578
		T (°C)	40	5500.0089	5500	0.00892	-1.6220
		T (°C)	50	5500.0081	5500	0.00808	-1.4693
		T (°C)	60	5500.0042	5500	0.00420	-0.7634
		T (°C)	70	5500.0080	5500	0.00796	-1.4481
Limits				Within 5470-5725MHz			
Result				Complies			

Voltage vs. Frequency Stability

TEST CONDITIONS				Reference Frequency: 5600MHz			
				f	fc	Max. Deviation (MHz)	Max. Deviation (ppm)
T nom (°C)	20	V nom (V)	3.85	5600.0090	5600	0.00897	-1.6022
		V max (V)	4.2	5600.0019	5600	0.00190	-0.3384
		V min (V)	3.4	5600.0100	5600	0.00995	-1.7775
Limits				Within 5470-5725MHz			
Result				Complies			

Temperature vs. Frequency Stability

TEST CONDITIONS				Reference Frequency: 5600MHz			
				f	fc	Max. Deviation (MHz)	Max. Deviation (ppm)
V nom (V)	3.85	T (°C)	-20	5600.0046	5600	0.00459	-0.8189
		T (°C)	-10	5600.0078	5600	0.00776	-1.3855
		T (°C)	0	5600.0051	5600	0.00510	-0.9108
		T (°C)	10	5600.0069	5600	0.00692	-1.2350
		T (°C)	20	5600.0034	5600	0.00344	-0.6137
		T (°C)	30	5600.0009	5600	0.00089	-0.1586
		T (°C)	40	5600.0011	5600	0.00109	-0.1940
		T (°C)	50	5600.0058	5600	0.00582	-1.0393
		T (°C)	60	5600.0081	5600	0.00811	-1.4483
		T (°C)	70	5600.0038	5600	0.00385	-0.6875
Limits				Within 5470-5725MHz			
Result				Complies			

Voltage vs. Frequency Stability

TEST CONDITIONS				Reference Frequency: 5700MHz			
				f	fc	Max. Deviation (MHz)	Max. Deviation (ppm)
T nom (°C)	20	V nom (V)	3.85	5700.0096	5700	0.00957	-1.6781
		V max (V)	4.2	5700.0018	5700	0.00176	-0.3085
		V min (V)	3.4	5700.0028	5700	0.00282	-0.4942
Limits				Within 5470-5725MHz			
Result				Complies			

Temperature vs. Frequency Stability

TEST CONDITIONS				Reference Frequency: 5700MHz			
				f	fc	Max. Deviation (MHz)	Max. Deviation (ppm)
V nom (V)	3.85	T (°C)	-20	5700.0001	5700	0.00011	-0.0193
		T (°C)	-10	5700.0042	5700	0.00419	-0.7345
		T (°C)	0	5700.0005	5700	0.00051	-0.0896
		T (°C)	10	5700.0096	5700	0.00960	-1.6835
		T (°C)	20	5700.0028	5700	0.00280	-0.4906
		T (°C)	30	5700.0001	5700	0.00012	-0.0205
		T (°C)	40	5700.0096	5700	0.00962	-1.6881
		T (°C)	50	5700.0024	5700	0.00239	-0.4197
		T (°C)	60	5700.0024	5700	0.00236	-0.4133
		T (°C)	70	5700.0014	5700	0.00135	-0.2371
Limits				Within 5470-5725MHz			
Result				Complies			

## 9. DYNAMIC FREQUENCY SELECTION(DFS)

### 9.1 APPLICABILITY OF DFS REQUIREMENTS

EUT is client and operates as client without radar detection function.

Table 1: Applicability of DFS Requirements Prior to Use of a Channel

Requirement	Operational Mode		
	Master	Client Without Radar Detection	Client With Radar Detection
Non-Occupancy Period	Yes	Not required	Yes
DFS Detection Threshold	Yes	Not required	Yes
Channel Availability Check Time	Yes	Not required	Not required
U-NII Detection Bandwidth	Yes	Not required	Yes

Table 2: Applicability of DFS requirements during normal operation

Requirement	Operational Mode		
	Master	Client Without Radar Detection	Client With Radar Detection
DFS Detection Threshold	Yes	Not required	Yes
Channel Closing Transmission Time	Yes	Yes	Yes
Channel Move Time	Yes	Yes	Yes
U-NII Detection Bandwidth	Yes	Not required	Yes
Client Beacon Test	N/A	Yes	Yes

Additional requirements for devices with multiple bandwidth modes	Operational Mode	
	Master or Client With Radar Detection	Client Without Radar Detection
U-NII Detection Bandwidth and Statistical Performance Check	All BW modes must be tested	Not required
Channel Move Time and Channel Closing Transmission Time	Test using widest BW mode available	Test using the widest BW mode available for the link
All other tests	Any single BW mode	Not required
<b>Note</b> Frequencies selected for statistical performance check (Section 7.8.4) should include several frequencies within the radar detection bandwidth and frequencies near the edge of the radar detection bandwidth. For 802.11 devices it is suggested to select frequencies in each of the bonded 20 MHz channels and the channel center frequency.		

### 9.2 INTERFERENCE THRESHOLD VALUES, MASTER OR CLIENT INCORPORATING IN-SERVICE MONITORING

Maximum Transmit Power	Value (see notes 1, 2, and 3)
EIRP $\geq$ 200 milliwatt	-64 dBm
EIRP < 200 milliwatt and power spectral density < 10 dBm/MHz	-62 dBm
EIRP < 200 milliwatt that do not meet the power spectral density requirement	-64 dBm
<b>Note 1:</b> This is the level at the input of the receiver assuming a 0 dBi receive antenna. <b>Note 2:</b> Throughout these test procedures an additional 1 dB has been added to the amplitude of the test transmission waveforms to account for variations in measurement equipment. This will ensure that the test signal is at or above the detection threshold level to trigger a DFS response. <b>Note 3:</b> EIRP is based on the highest antenna gain.	

### 9.3 DFS RESPONSE REQUIREMENT VALUES

Parameter	Value
Non-occupancy period	Minimum 30 minutes
Channel Availability Check Time	60 seconds
Channel Move Time	10 seconds See Note 1.
Channel Closing Transmission Time	200 milliseconds + an aggregate of 60 milliseconds over remaining 10 second period. See Notes 1 and 2.
U-NII Detection Bandwidth	Minimum 100% of the 99% power bandwidth See Note 3.

**Note 1:** The instant that the Channel Move Time and the Channel Closing Transmission Time begins is as follows:

- For the Short pulse radar Test Signals this instant is the end of the Burst.
- For the Frequency Hopping radar Test Signal, this instant is the end of the last radar Burst generated.
- For the Long Pulse radar Test Signal this instant is the end of the 12 second period defining the radar transmission.

**Note 2:** The Channel Closing Transmission Time is comprised of 200 milliseconds starting at the beginning of the Channel Move Time plus any additional intermittent control signals required to facilitate Channel changes (an aggregate of 60 milliseconds) during the remainder of the 10 second period. The aggregate duration of control signals will not count quiet periods in between transmissions.

**Note 3:** During the U-NII Detection Bandwidth detection test, radar type 0 is used and for each frequency step the minimum percentage of detection is 90%. Measurements are performed with no data traffic.

### 9.4 SHORT PULSE RADAR TEST WAVEFORMS

As the EUT is a Client Device with no Radar Detection, only one type radar pulse is required for the testing. Radar Pulse type 0 was used in the evaluation of the Client device for the purpose of measuring the Channel Move Time and the Channel Closing Transmission Time.

Radar Type	Pulse Width (µsec)	PRI (µsec)	Number of Pulses	Minimum Percentage of Successful Detection	Minimum Trials
0	1	1428	18	60%	30
1	1	Test A Test B	$\text{Roundup}\left(\frac{1}{360} \cdot \frac{19 \cdot 10^6}{\text{PRI}_{\text{min}}}\right)$	60%	30
2	1-5	150-230	23-29	60%	30
3	6-10	200-500	16-18	60%	30
4	11-20	200-500	12-16	60%	30
Aggregate (Radar Types 1-4)				80%	120

Test A: 15 unique PRI values randomly selected from the list of 23 PRI values in Table 5a  
 Test B: 15 unique PRI values randomly selected within the range of 518-3066 µsec, with a minimum increment of 1 µsec, excluding PRI values selected in Test A

A minimum of 30 unique waveforms are required for each of the short pulse radar types 2 through 4. For short pulse radar type 1, the same waveform is used a minimum of 30 times. If more than 30 waveforms are used for short pulse radar types 2 through 4, then each additional waveform must also be unique and not repeated from the previous waveforms.

If more than 30 waveforms are used for Short Pulse Radar Type 1, then each additional waveform is generated with Test B and must also be unique and not repeated from the previous waveforms in Tests A or B. The aggregate is the average of the percentage of successful detections of short pulse radar types 1-4.



**9.5 CALIBRATION SETUP AND DFS TEST RESULTS**

Radar Waveform Calibration Procedure

- 1) A 50 ohm load is connected in place of the spectrum analyzer, and the spectrum analyzer is connected to place of the master
- 2) The interference Radar Detection Threshold Level is  $-62\text{dBm} - 2\text{dBi} + 1\text{dB} = -63\text{dBm}$  that had been taken into account the output power range and antenna gain.
- 3) The following equipment setup was used to calibrate the conducted radar waveform. A vector signal generator was utilized to establish the test signal level for radar type 0. During this process there were no transmissions by either the master or client device. The spectrum analyzer was switched to the zero spans (time domain) at the frequency of the radar waveform generator. Peak detection was used. The spectrum analyzer resolution bandwidth (RBW) and video bandwidth (VBW) were set to 3 MHz. The spectrum analyzer had offset  $-1.0\text{dB}$  to compensate RF cable loss  $1.0\text{dB}$ .
- 4) The vector signal generator amplitude was set so that the power level measured at the spectrum analyzer was  $-62\text{dBm} - 2\text{dBi} + 1\text{dB} = -63\text{dBm}$ . Capture the spectrum analyzer plots on short pulse radar waveform.

**9.6 CONDUCTED CALIBRATION SETUP**

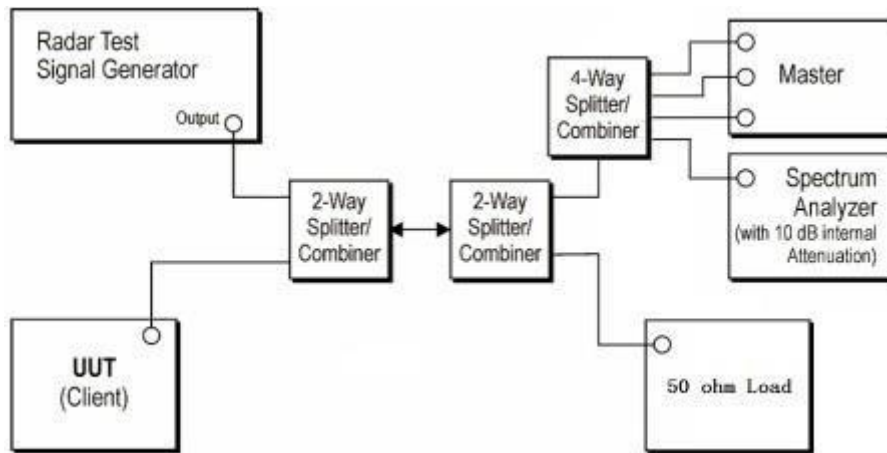

Wireless AP	Manufacturer	LINKSYS LLC
	Model NO.	WRT32X
	FCC ID	Q87-WRT3200ACM

### 9.7 RADAR WAVEFORM CALIBRATION RESULT

Test data reference attachment.

**9.8 IN-SERVICE MONITORING: CHANNEL MOVE TIME, CHANNEL CLOSING TRANSMISSION TIME AND NON-OCCUPANCY PERIOD**

**TEST CONFIGURATION:**

Setup for Client with injection at the Master

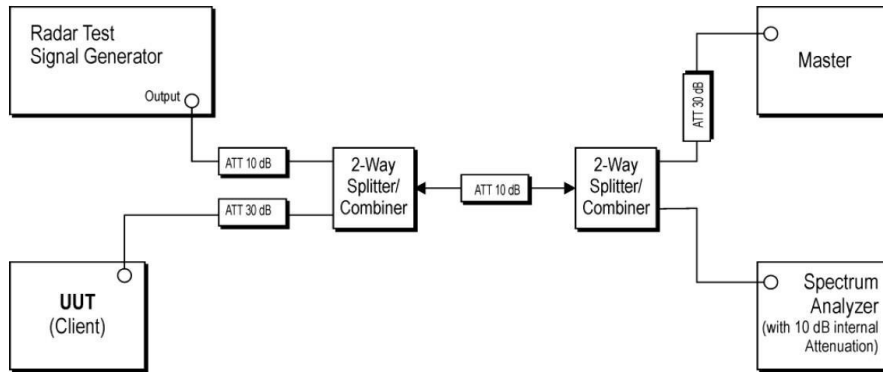

**TEST PROCEDURE:**

1. The radar pulse generator is setup to provide a pulse at frequency that the master and client are operating. A type 0 radar pulse with a 1us pulse width and a 1428us PRI is used for the testing.
2. The vector signal generator is adjusted to provide the radar burst (18 pulses) at the level of approximately -61dBm at the antenna port of the master device
3. A trigger is provided from the pulse generator to the DFS monitoring system in order to capture the traffic and the occurrence of the radar pulse.
4. EUT will associate with the master at channel. The file "iperf.exe" specified by the FCC is Streamed from the PC 2 through the master and the client device to the PC 1 and played in full motion video using Media Player Classic Ver. 6.4.8.6 in order to properly load the network for the entire period of the test.
5. When radar burst with a level equal to the DFS Detection Threshold +1dB is generated on the operating channel of the U-NII device. At time T0 the radar waveform generator sends a burst of pulse of the radar waveform at Detection Threshold +1dB.
6. Observe the transmissions of the EUT at the end of the radar Burst on the Operating Channel Measure and record the transmissions from the UUT during the observation time (Channel Move Time). One 15 seconds plot is reported for the Short Pulse Radar Type 0. The plot for the Short Pulse Radar Types start at the end of the radar burst. The Channel Move Time will be calculated based on the zoom In 600ms plot of the Short Pulse Radar Type
7. Measurement of the aggregate duration of the Channel Closed Transmission Time method. With the spectrum analyzer set to zero span tuned to the center frequency of the EUT operating channel at the radar simulated frequency, peak detection, and max hold, the dwell time per bin is given by:  $Dwell (0.3ms) = S (12000ms) / B (4000)$ ; where Dwell is the dwell time per spectrum analyzer sampling bin, S is sweep time and B is the number of spectrum analyzer sampling bins. An upper bound of the aggregate duration of the intermittent control signals of Channel Closing Transmission Time is calculated by:  $C (ms) = N \times Dwell (0.3ms)$ ; where C is the Closing Time, N is the number of spectrum analyzer sampling bins (intermittent control signals) showing a U-NII transmission and Dwell is the dwell time per bin.
8. Measurement the EUT for more than 30 minutes following the channel move time to verify that no transmission or beacons occur on this channel.

**TEST MODE:**

Please refer to the clause 2.2

**9.9 RESULT OF CHANNEL MOVE TIME, CHANNEL CLOSING TRANSMISSION TIME AND  
NON-OCCUPANCY PERIOD FOR CLIENT BEACON TEST**

Test data reference attachment.

## 10. ANTENNA REQUIREMENT

### 10.1 STANDARD REQUIREMENT

15.203 requirement: For intentional device, according to 15.203: an intentional radiator shall be designed to ensure that no antenna other than that furnished by the responsible party shall be used with the device.

### 10.2 EUT ANTENNA

The EUT antenna is permanent attached LDS Antenna (antenna gain: 3dBi). It comply with the standard requirement.

END OF REPORT