

Test of
Ear Force i70 TX Wireless Audio Transmitter
To: FCC 47 CFR Part 15.247 & IC RSS-210
Test Report Serial No.: COMM71-U6 Rev A



TEST REPORT

FROM



Test of Ear Force i70 TX Wireless Audio Transmitter

to

To FCC 47 CFR Part 15.247 & IC RSS-210

Test Report Serial No.: COMM71-U6 Rev A

Note: this report contains data with regard to the 2400 to 2483.5 MHz operational modes of the Turtle Beach, Ear Force i70 TX Wireless Audio Transmitter. Test data for 5150 - 5250 MHz operation is reported in MiCOM Labs test report COMM71-U7.

This report supersedes: None

Applicant: Voyetra Turtle Beach Inc
100 Summit Lake Drive, Suite 100
Valhalla
New York, 10595, USA

Product Function: Wireless Audio Transmitter

Copy No: pdf Issue Date: 27th February 2014

This Test Report is Issued Under the Authority of:

MiCOM Labs, Inc.
575 Boulder Court,
Pleasanton, CA 94566 USA
Phone: +1 (925) 462-0304
Fax: +1 (925) 462-0306
www.micomlabs.com



TESTING CERT #2381.01

MiCOM Labs is an ISO 17025 Accredited Testing Laboratory

This test report may be reproduced in full only. The document may only be updated by MiCOM Labs personnel. Any changes will be noted in the Document History section of the report.



Title: Ear Force i70 TX Wireless Audio Transmitter
To: FCC 47 CFR Part 15.247 & IC RSS-210
Serial #: COMM71-U6 Rev A
Issue Date: 27th February 2014
Page: 3 of 53

This page has been left intentionally blank

This test report may be reproduced in full only. The document may only be updated by MiCOM Labs personnel. Any changes will be noted in the Document History section of the report.



TABLE OF CONTENTS

1	ACCREDITATION, LISTINGS & RECOGNITION	5
1.1	ACCREDITATION - TESTING.....	5
1.2	RECOGNITION	6
1.3	PRODUCT CERTIFICATION	7
2	DOCUMENT HISTORY	8
3	TEST RESULT SUMMARY	9
3.1	COMPLIANCE STATEMENT	10
4	REFERENCES AND MEASUREMENT UNCERTAINTY	11
4.1	Normative References	11
4.2	Test and Uncertainty Procedures	12
5	PRODUCT DETAILS AND TEST CONFIGURATIONS	13
5.1	Technical Details	13
5.2	Scope of Test Program.....	14
5.3	Equipment Model(s) and Serial Number(s)	15
5.4	Antenna Details	15
5.5	Cabling and I/O Ports	15
5.6	Test Configurations.....	16
5.7	Equipment Modifications.....	18
5.8	Deviations from the Test Standard	18
6	TEST EQUIPMENT CONFIGURATION(S)	19
6.1	Conducted RF Emission Test Set-up	19
6.2	Radiated Spurious Emission Test Set-up > 1 GHz.....	20
6.3	Digital Emissions Test Set-up (0.03 – 1 GHz)	21
6.4	ac Wireline Emission Test Set-up.....	22
7	TEST SUMMARY	23
8	TEST RESULTS	25
8.1	Device Characteristics	25
8.1.1	<i>Conducted Testing</i>	25
8.1.2	<i>Radiated Emission Testing</i>	34
8.1.3	<i>AC Wireline Conducted Emissions (150 kHz – 30 MHz)</i>	43
9	PHOTOGRAPHS.....	45
9.1	Conducted Test Setup	45
10	TEST EQUIPMENT	46
APPENDIX		47
A.	SUPPORTING INFORMATION	47
A.1.	CONDUCTED TEST PLOTS.....	47
A.1.1.	<i>6 dB & 99% Bandwidth</i>	48
A.1.2.	<i>Peak Output Power</i>	49
A.1.3.	<i>Power Spectral Density</i>	50
A.1.4.	<i>Conducted Spurious Emissions</i>	51

This test report may be reproduced in full only. The document may only be updated by MiCOM Labs personnel. Any changes will be noted in the Document History section of the report.

1 ACCREDITATION, LISTINGS & RECOGNITION

1.1 ACCREDITATION - TESTING

MiCOM Labs, Inc. is an accredited Electrical testing laboratory per the international standard EN ISO/IEC 17025. The company is accredited by the American Association for Laboratory Accreditation (A2LA) www.a2la.org test laboratory number 2381.01. MiCOM Labs test schedule is available at the following URL; <http://www.a2la.org/scopepdf/2381-01.pdf>



The American Association for Laboratory Accreditation

World Class Accreditation

Accredited Laboratory

A2LA has accredited

MICOM LABS

Pleasanton, CA

for technical competence in the field of

Electrical Testing

This laboratory is accredited in accordance with the recognized International Standard ISO/IEC 17025:2005 *General Requirements for the Competence of Testing and Calibration Laboratories*. This accreditation demonstrates technical competence for a defined scope and the operation of a laboratory quality management system (refer to joint ISO-ILAC-LAF Communiqué dated 8 January 2009).

Presented this 27th day of March 2012.



President & CEO
For the Accreditation Council
Certificate Number 2381.01
Valid to March 31, 2014
Revised February 26, 2014

For the tests or types of tests to which this accreditation applies, please refer to the laboratory's Electrical Scope of Accreditation.

This test report may be reproduced in full only. The document may only be updated by MiCOM Labs personnel. Any changes will be noted in the Document History section of the report.



Title: Ear Force i70 TX Wireless Audio Transmitter
To: FCC 47 CFR Part 15.247 & IC RSS-210
Serial #: COMM71-U6 Rev A
Issue Date: 27th February 2014
Page: 6 of 53

1.2 RECOGNITION

MiCOM Labs, Inc has widely recognized Electrical testing capabilities. Our international recognition includes Conformity Assessment Body designation by APEC MRA** countries. Our test reports are widely accepted for global type approvals.

Country	Recognition Body	Status	Phase	Identification No.
USA	Federal Communications Commission (FCC)	TCB	-	US0159 Listing #: 102167
Canada	Industry Canada (IC)	FCB	APEC MRA 2	US0159 Listing #: 4143A-2 4143A-3
Japan	MIC (Ministry of Internal Affairs and Communication)	CAB	APEC MRA 2	RCB 210
	VCCI	--	--	A-0012
Europe	European Commission	NB	EU MRA	NB 2280
Australia	Australian Communications and Media Authority (ACMA)	CAB	APEC MRA 1	US0159
Hong Kong	Office of the Telecommunication Authority (OFTA)	CAB	APEC MRA 1	
Korea	Ministry of Information and Communication Radio Research Laboratory (RRL)	CAB	APEC MRA 1	
Singapore	Infocomm Development Authority (IDA)	CAB	APEC MRA 1	
Taiwan	National Communications Commission (NCC) Bureau of Standards, Metrology and Inspection (BSMI)	CAB	APEC MRA 1	
Vietnam	Ministry of Communication (MIC)	CAB	APEC MRA 1	

**APEC MRA – Asia Pacific Economic Community Mutual Recognition Agreement.

Is a recognition agreement under which test lab is accredited to regulatory standards of the APEC member countries.

Phase I - recognition for product testing

Phase II – recognition for both product testing and certification

N/A – Not Applicable

**EU MRA – European Union Mutual Recognition Agreement.

Is a recognition agreement under which test lab is accredited to regulatory standards of the EU member countries.

**NB – Notified Body

This test report may be reproduced in full only. The document may only be updated by MiCOM Labs personnel. Any changes will be noted in the Document History section of the report.

1.3 PRODUCT CERTIFICATION

MiCOM Labs, Inc. is an accredited Product Certification Body per the international standard EN ISO/IEC Guide 65. The company is accredited by the American Association for Laboratory Accreditation (A2LA) www.a2la.org test laboratory number 2381.02. MiCOM Labs test schedule is available at the following URL; <http://www.a2la.org/scopepdf/2381-02.pdf>



The American Association for Laboratory Accreditation

Accredited Product Certification Body

A2LA has accredited

MICOM LABS

Pleasanton, CA

for technical competence as a

Product Certification Body

This product certification body is accredited in accordance with the recognized International Standard ISO/IEC Guide 65:1996 *General requirements for bodies operating product certification systems*. This accreditation demonstrates technical competence for a defined scope and the operation of a quality management system.

Presented this 27th day of March 2012.



President & CEO
For the Accreditation Council
Certificate Number 2381.02
Valid to March 31, 2014
Revised February 26, 2014

For the product certification schemes to which this accreditation applies, please refer to the organization's Product Certification Scope of Accreditation

United States of America – Telecommunication Certification Body (TCB)

TCB Identifier – US0159

Industry Canada – Certification Body

CAB Identifier – US0159

Europe – Notified Body

Notified Body Identifier - 2280

Japan – Recognized Certification Body (RCB)

RCB Identifier - 210

This test report may be reproduced in full only. The document may only be updated by MiCOM Labs personnel. Any changes will be noted in the Document History section of the report.



Title: Ear Force i70 TX Wireless Audio Transmitter
To: FCC 47 CFR Part 15.247 & IC RSS-210
Serial #: COMM71-U6 Rev A
Issue Date: 27th February 2014
Page: 8 of 53

2 DOCUMENT HISTORY

Document History		
Revision	Date	Comments
Draft		
Rev A	27 th February 2014	<p>Initial Release</p> <p>The Ear Force i70 TX Wireless Transmitter is 100% electrically and mechanically identical to the Ear Force i60 TX Wireless Transmitter.</p> <p>The radio modules were tested for compliance to the requirements of the standard by MiCOM Labs and results reported in MiCOM Labs test report COMM38-U3. This report includes conducted RF data that was originally reported in MiCOM Labs test report COMM38-U3.</p>

This test report may be reproduced in full only. The document may only be updated by MiCOM Labs personnel. Any changes will be noted in the Document History section of the report.



Title: Ear Force i70 TX Wireless Audio Transmitter
To: FCC 47 CFR Part 15.247 & IC RSS-210
Serial #: COMM71-U6 Rev A
Issue Date: 27th February 2014
Page: 9 of 53

3 TEST RESULT SUMMARY

Manufacturer:	Voyetra Turtle Beach Inc 100 Summit Lake Drive, Suite 100 Valhalla New York, 10595, USA	Tested By:	MiCOM Labs, Inc. 575 Boulder Court Pleasanton California, 94566, USA
EUT:	Wireless Audio Transmitter	Telephone:	+1 925 462 0304
Model:	Ear Force i70 TX (TB300-7031-01)	Fax:	+1 925 462 0306
S/N's:	N/A		
Test Date(s):	20th to 29th Aug & 18th to 20th Dec '13	Website:	www.micomlabs.com

STANDARD(S)	TEST RESULTS
FCC 47 CFR Part 15.247 & IC RSS-210	EQUIPMENT COMPLIES

MiCOM Labs, Inc. tested the equipment mentioned in accordance with the requirements set forth in the above standards. Test results indicate that the equipment tested is capable of demonstrating compliance with the requirements as documented within this report.

Notes:

1. This document reports conditions under which testing was conducted and the results of testing performed.
2. Details of test methods used have been recorded and kept on file by the laboratory.
3. Test results apply only to the item(s) tested.

Approved & Released for MiCOM Labs, Inc. by:





Graeme Grieve
Quality Manager MiCOM Labs,

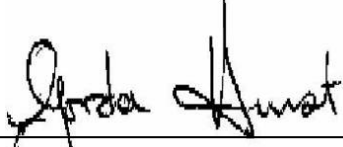

Gordon Hurst
President & CEO MiCOM Labs, Inc.

This test report may be reproduced in full only. The document may only be updated by MiCOM Labs personnel. Any changes will be noted in the Document History section of the report.



Title: Ear Force i70 TX Wireless Audio Transmitter
To: FCC 47 CFR Part 15.247 & IC RSS-210
Serial #: COMM71-U6 Rev A
Issue Date: 27th February 2014
Page: 10 of 53

3.1 COMPLIANCE STATEMENT

Applicant:	Voyetra Turtle Beach Inc 100 Summit Lake Drive, Suite 100 Valhalla, New York, 10595, USA	Tested By:	MiCOM Labs, Inc. 575 Boulder Court Pleasanton California, 94566 USA
Product:	Wireless Audio Transmitter	Telephone: Fax:	+1 925 462 0304 +1 925 462 0306
Model No.:	Ear Force i70 TX (TB300-7031-01)	Website:	www.micomlabs.com

STANDARD(S)

FCC 47 CFR Part 15.247 & IC RSS-210

MiCOM Labs attests that the above noted models meet the requirements set forth in the above standard(s) based on testing of samples as noted in the Test Result Summary and the manufacturer's declaration of similarity.

Test results indicate that the equipment tested is capable of demonstrating compliance with the requirements as documented within this report.

Notes:

1. The different model numbers identified are declared as being electrically identical by the manufacturer.
2. The manufacturer declared that the only difference between the models is cosmetic; the different models are marketed under separate brands.

This test report may be reproduced in full only. The document may only be updated by MiCOM Labs personnel. Any changes will be noted in the Document History section of the report.

4 REFERENCES AND MEASUREMENT UNCERTAINTY

4.1 Normative References

REF.	PUBLICATION	YEAR	TITLE
i.	FCC 47 CFR Part 15, Subpart C	2013	Title 47: Telecommunication PART 15—RADIO FREQUENCY DEVICES Subpart C—Intentional Radiators
ii.	RSS-210 Annex 8	2010	Radio Standards Specification 210, Issue 8, Low-power Licence-exempt Radiocommunication Devices (All Frequency Bands): Category I Equipment
iii.	FCC OET KDB 662911	4 th April 2011	Emissions Testing of Transmitters with Multiple Outputs in the Same Band
iv.	DA 00-705	2000	FCC DA 00-705 "Filing and Measurement Guidelines for Frequency Hopping Spread Spectrum Systems" released March 30, 2000
v.	RSS-GEN	2010	Radio Standards Specification-Gen, Issue 3, General Requirements and Information for the Certification of Radiocommunication Equipment
vi.	FCC 47 CFR Pt 15, Subpart B	2012	47 CFR Part 15, SubPart B; Unintentional Radiators
vii.	ICES-003	2004	Spectrum Management and Telecommunications Policy Interference-Causing Equipment Standard Digital Apparatus; Issue 4
viii.	ANSI C63.4	2009	American National Standards for Methods of Measurement of Radio-Noise Emissions from Low-Voltage Electrical and Electronic Equipment in the Range of 9 kHz to 40 GHz
ix.	CISPR 22/ EN 55022	2008 2006+A1:2007	Limits and Methods of Measurements of Radio Disturbance Characteristics of Information Technology Equipment
x.	M 3003	Edition 1 Dec. 1997	Expression of Uncertainty and Confidence in Measurements
xi.	LAB34	Edition 1 Aug 2002	The expression of uncertainty in EMC Testing
xii.	ETSI TR 100 028	2001	Parts 1 and 2 Electromagnetic compatibility and Radio Spectrum Matters (ERM); Uncertainties in the measurement of mobile radio equipment characteristics
xiii.	A2LA	July 2012	Reference to A2LA Accreditation Status – A2LA Advertising Policy

This test report may be reproduced in full only. The document may only be updated by MiCOM Labs personnel. Any changes will be noted in the Document History section of the report.



Title: Ear Force i70 TX Wireless Audio Transmitter
To: FCC 47 CFR Part 15.247 & IC RSS-210
Serial #: COMM71-U6 Rev A
Issue Date: 27th February 2014
Page: 12 of 53

4.2 Test and Uncertainty Procedures

Conducted and radiated emission measurements were conducted in accordance with American National Standards Institute ANSI C63.4, listed in the Normative References section of this report.

Measurement uncertainty figures are calculated in accordance with ETSI TR 100 028 Parts 1 and 2.

Measurement uncertainties stated are based on a standard uncertainty multiplied by a coverage factor $k = 2$, providing a level of confidence of approximately 95 % in accordance with UKAS document M 3003 listed in the Normative References section of this report.

This test report may be reproduced in full only. The document may only be updated by MiCOM Labs personnel. Any changes will be noted in the Document History section of the report.



Title: Ear Force i70 TX Wireless Audio Transmitter
To: FCC 47 CFR Part 15.247 & IC RSS-210
Serial #: COMM71-U6 Rev A
Issue Date: 27th February 2014
Page: 13 of 53

5 PRODUCT DETAILS AND TEST CONFIGURATIONS

5.1 Technical Details

Details	Description
Purpose:	Test of the Ear Force i70 TX Wireless Audio Transmitter to FCC Part 15.247 and Industry Canada RSS-210 regulations.
Applicant:	Voyetra Turtle Beach Inc 100 Summit Lake Drive, Suite 100 Valhalla New York, 10595, USA
Manufacturer:	As applicant.
Laboratory performing the tests:	MiCOM Labs, Inc. 575 Boulder Court, Pleasanton, California 94566 USA
Test report reference number:	COMM71-U6 Rev A
Date EUT received:	18 th December 2013
Standard(s) applied:	FCC 47 CFR Part 15.247 & IC RSS-210
Dates of test (from - to):	20th to 29th Aug & 18th to 20th Dec '13
No of Units Tested:	Two
Type of Equipment:	Wireless Audio Transmitter
Manufacturers Trade Name:	Ear Force
Model(s):	Ear Force i70 TX (TB300-7031-01)
Location for use:	Indoor
Declared Frequency Range(s):	2400 - 2483.5 MHz;
Hardware Rev	PP
Software Rev	N/A
Type of Modulation:	Per 802.11 – OFDM
Declared Nominal Tx Power:	802.11g;Leg. +11.08 dBm
EUT Modes of Operation:	Legacy 802.11 g
Transmit/Receive Operation:	Time Division Duplex
System Beam Forming:	EUT has no capability for antenna beam forming
Rated Input Voltage and Current:	5V (USB)
Operating Temperature Range:	Declared range 0° to +50°C at 95% humidity non condensing
ITU Emission Designator:	2400 – 2483.5 MHz 802.11 g 17M5D1D
Equipment Dimensions:	4.5 x 4.5 x 1 inches
Weight:	4 oz
Primary function of equipment:	Wireless Audio Transmitter

This test report may be reproduced in full only. The document may only be updated by MiCOM Labs personnel. Any changes will be noted in the Document History section of the report.

5.2 Scope of Test Program

Ear Force i70 TX Wireless Audio Transmitter RF Testing

The scope of the test program was to test the Ear Force i70 TX Wireless Audio Transmitter (TB300-7031-01), in the frequency range 2400 - 2483.5 MHz for compliance against FCC 47 CFR Part 15.247 and Industry Canada RSS-210 specifications.

The Ear Force i70 TX Wireless Transmitter is 100% electrically and mechanically identical to the Ear Force i60 TX Wireless Transmitter.

The radio modules were tested for compliance to the requirements of the standard by MiCOM Labs and results reported in MiCOM Labs test report COMM38-U3. This report includes conducted RF data that was originally reported in MiCOM Labs test report COMM38-U3.

Ear Force i70 TX Wireless Audio Transmitter

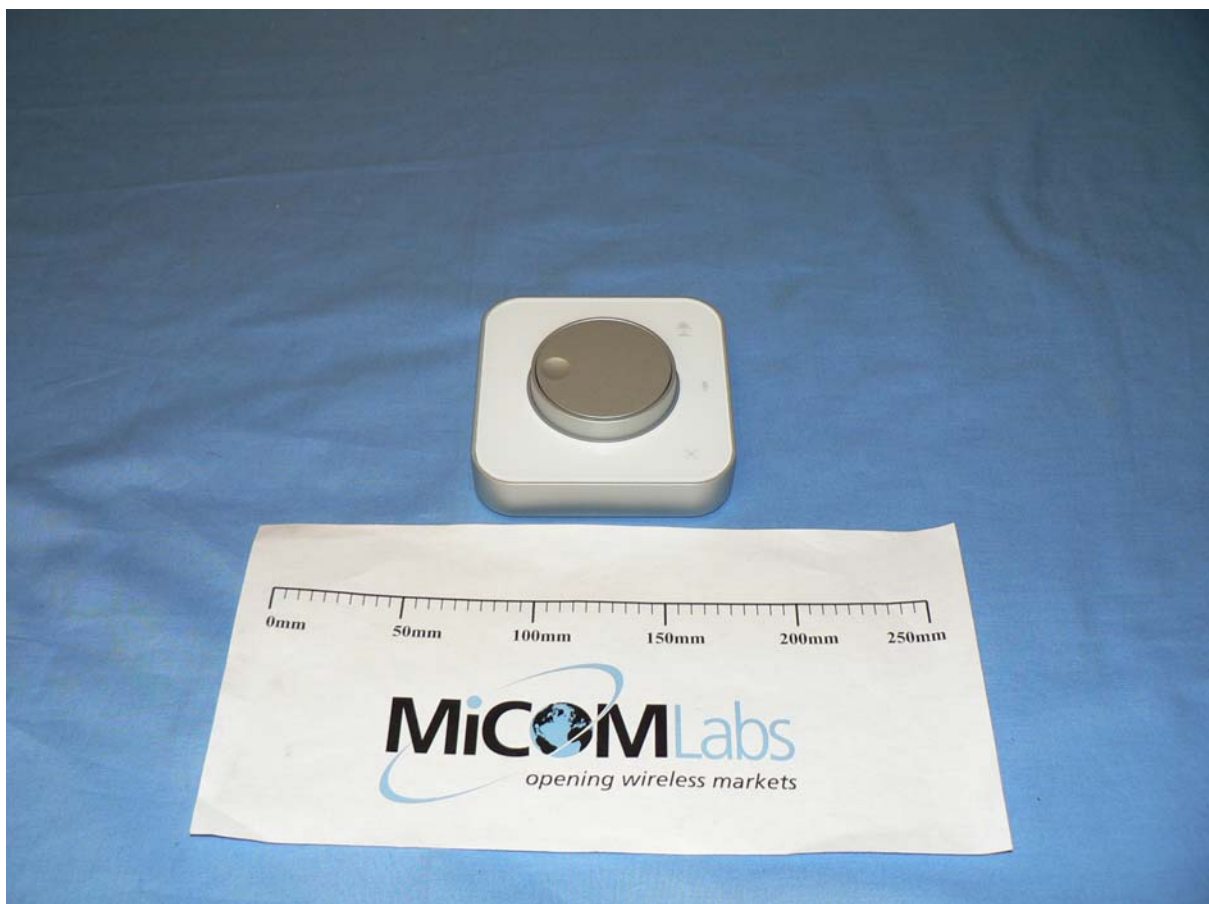

This test report may be reproduced in full only. The document may only be updated by MiCOM Labs personnel. Any changes will be noted in the Document History section of the report.



Title: Ear Force i70 TX Wireless Audio Transmitter
To: FCC 47 CFR Part 15.247 & IC RSS-210
Serial #: COMM71-U6 Rev A
Issue Date: 27th February 2014
Page: 15 of 53

5.3 Equipment Model(s) and Serial Number(s)

Equipment Type	Equipment Description (Including Brand Name)	Mfr	Model No.	Serial No.
EUT	Wireless Audio Transmitter	Voyetra Turtle Beach	Ear Force i70 TX	N/A
Support	Laptop PC	Apple	MacBook Air	None

5.4 Antenna Details

Antenna Type	Manufacturer	Model Number	Antenna Gain (dBi)	
			2.4 GHz	5 GHz
Integral Folded F (Bluetooth)	Turtle Beach	PCB	2.8	--
Chip (Wi-Fi)	Fractus	FR05-S1-NO-1-004	-1.5	--
Chip (Wi-Fi)	Fractus	FR05-S1-NO-1-004	--	3.3

5.5 Cabling and I/O Ports

Number and type of I/O ports

1. 1 x USB (power only)

This test report may be reproduced in full only. The document may only be updated by MiCOM Labs personnel. Any changes will be noted in the Document History section of the report.



Title: Ear Force i70 TX Wireless Audio Transmitter
To: FCC 47 CFR Part 15.247 & IC RSS-210
Serial #: COMM71-U6 Rev A
Issue Date: 27th February 2014
Page: 16 of 53

5.6 Test Configurations

Testing was performed to determine the highest power level versus bit rate. The variant with the highest power was used to exercise the product.

Operational Mode(s) (802.11)	Variant	Data Rate with Highest Power	Frequencies (MHz)
g	Legacy	6 MBit/s	2,462

Legacy – data rates for 802.11g products

Results for the above configurations are provided in this report.

This test report may be reproduced in full only. The document may only be updated by MiCOM Labs personnel. Any changes will be noted in the Document History section of the report.



Title: Ear Force i70 TX Wireless Audio Transmitter
To: FCC 47 CFR Part 15.247 & IC RSS-210
Serial #: COMM71-U6 Rev A
Issue Date: 27th February 2014
Page: 17 of 53

Antenna Test Configurations for Radiated Emissions

Results for the following configurations are provided in this report.

Modes with the highest spectral density will have the highest spurious emissions, only those modes were tested for this test program.

2,400 – 2,483.5 MHz

15.247	
802.11g	g SE 2462
	BE g 2390
	BE g 2483.5

KEY;-

SE – Spurious Emission
BE – Band-Edge

This test report may be reproduced in full only. The document may only be updated by MiCOM Labs personnel. Any changes will be noted in the Document History section of the report.



Title: Ear Force i70 TX Wireless Audio Transmitter
To: FCC 47 CFR Part 15.247 & IC RSS-210
Serial #: COMM71-U6 Rev A
Issue Date: 27th February 2014
Page: 18 of 53

5.7 Equipment Modifications

The following modifications were required to bring the equipment into compliance:

1. Band-Edge and Radiated Spurious Power Reduction

All conducted spurious emission testing was performed with the device set for maximum power at all times.

5.8 Deviations from the Test Standard

The following deviations from the test standard were required in order to complete the test program:

1. NONE

This test report may be reproduced in full only. The document may only be updated by MiCOM Labs personnel. Any changes will be noted in the Document History section of the report.

6 TEST EQUIPMENT CONFIGURATION(S)

6.1 Conducted RF Emission Test Set-up

The following tests were performed using the conducted test set-up shown in the diagram below.

1. Section 6.1.1.1. 6 dB and 99% Bandwidth
2. Section 6.1.1.2. Peak Output Power
3. Section 6.1.1.3. Power Spectral Density
4. Section 6.1.1.4. Conducted Spurious Emissions

Conducted Test Set-Up Pictorial Representation

Test Measurement set up

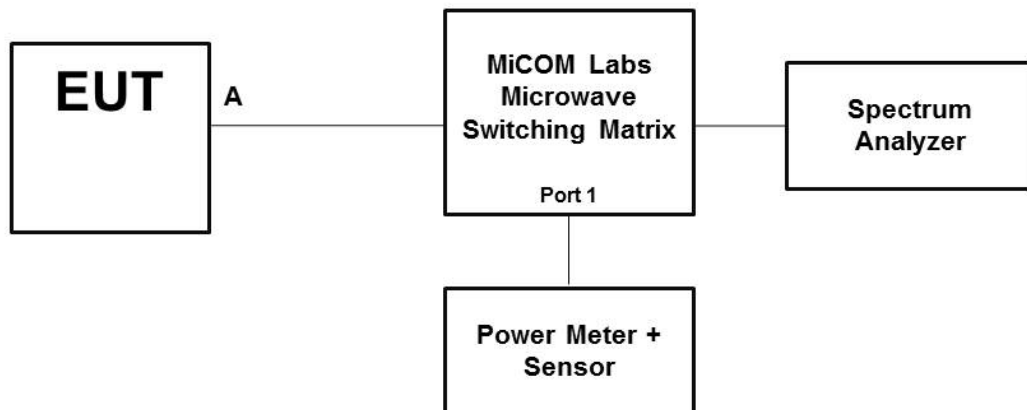

Conducted Test Measurement Setup

6.2 Radiated Spurious Emission Test Set-up > 1 GHz

The following tests were performed using the conducted test set-up shown in the diagram below.

Radiated Emission Measurement Setup – Above 1 GHz

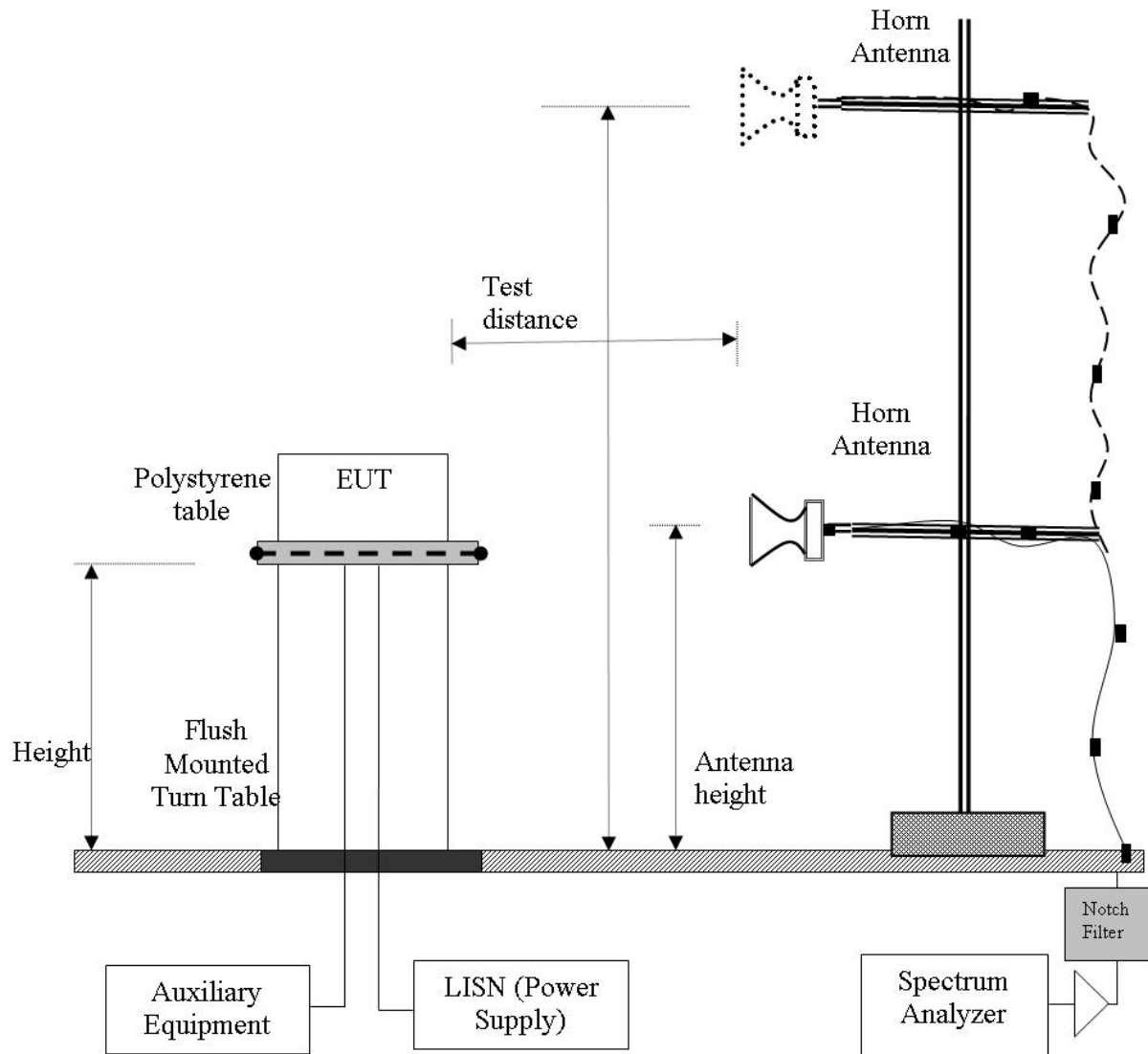

This test report may be reproduced in full only. The document may only be updated by MiCOM Labs personnel. Any changes will be noted in the Document History section of the report.

6.3 Digital Emissions Test Set-up (0.03 – 1 GHz)

The following tests were performed using the conducted test set-up shown in the diagram below.

Digital Emission Measurement Setup – Below 1 GHz

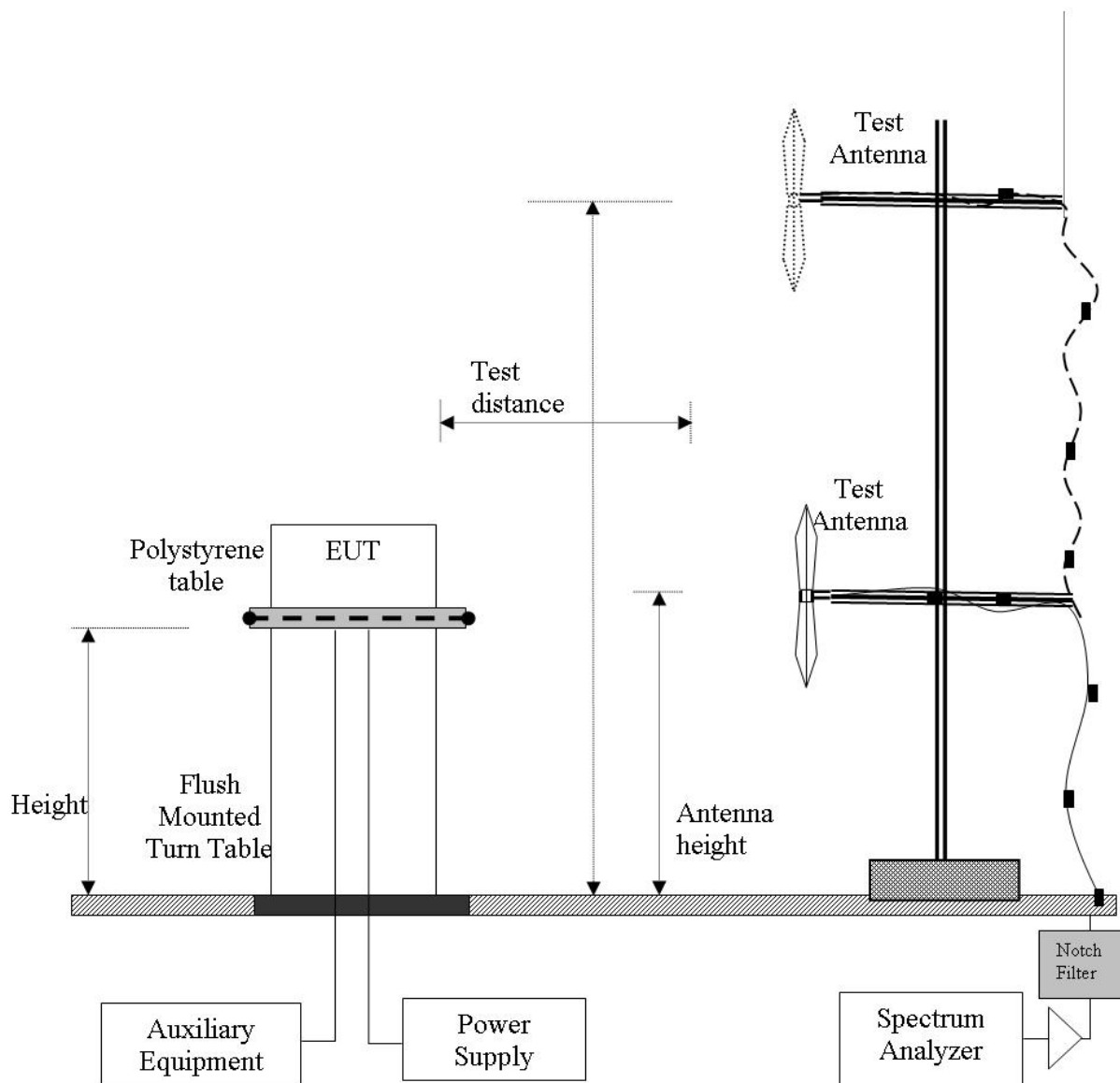

This test report may be reproduced in full only. The document may only be updated by MiCOM Labs personnel. Any changes will be noted in the Document History section of the report.

6.4 ac Wireline Emission Test Set-up

The following tests were performed using the conducted test set-up shown in the diagram below.

Not Required EUT not powered by AC.

1. Section 6.1.3 ac Wireline Conducted Emissions

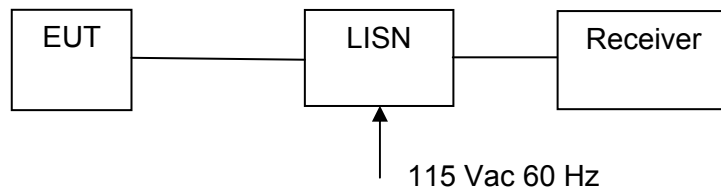

Measurement Setup for Conducted Emissions Test



Title: Ear Force i70 TX Wireless Audio Transmitter
To: FCC 47 CFR Part 15.247 & IC RSS-210
Serial #: COMM71-U6 Rev A
Issue Date: 27th February 2014
Page: 23 of 53

7 TEST SUMMARY

List of Measurements

The following table represents the list of measurements required under the **FCC CFR47 Part 15.247** and **Industry Canada RSS-210** and **Industry Canada RSS-Gen**.

Section(s)	Test Items	Description	Condition	Result	Test Report Section
15.247(a)(2) A8.2(1) 4.4	6 dB and 99 % Bandwidths	≥500 kHz	Conducted	Complies	8.1.1.1
15.247(b)(3) 15.31(e) A8.4(4)	Peak Output Power Voltage Variation	Shall not exceed 1W Variation of supply voltage 85 % -115 %	Conducted	Complies	8.1.1.2
15.247(e) A8.2	Peak Power Spectral Density	Shall not be greater than +8 dBm in any 3 kHz band	Conducted	Complies	8.1.1.3
15.247(d) 15.205 / 15.209 A8.5 2.2 4.7	Spurious Emissions (30MHz - 26 GHz b/g and 30 MHz – 40 GHz a)	The radiated emission in any 100 kHz of out- band shall be at least 20 dB below the highest in- band spectral density	Conducted	Complies	8.1.1.4

This test report may be reproduced in full only. The document may only be updated by MiCOM Labs personnel. Any changes will be noted in the Document History section of the report.



Title: Ear Force i70 TX Wireless Audio Transmitter
To: FCC 47 CFR Part 15.247 & IC RSS-210
Serial #: COMM71-U6 Rev A
Issue Date: 27th February 2014
Page: 24 of 53

List of Measurements (continued)

The following table represents the list of measurements required under the **FCC CFR47 Part 15.247**, **Industry Canada RSS-210**, and **Industry Canada RSS-Gen**.

Section(s)	Test Items	Description	Condition	Result	Test Report Section
15.247(d) 15.205 / 15.209 A8.5 2.2 2.6 4.7	Radiated Emissions	Restricted Bands	Radiated	Complies	8.1.2.
	Transmitter Radiated Spurious Emissions	Emissions above 1 GHz		Complies	
	Radiated Band Edge	Band-edge results Peak Emissions		Complies	
15.205 / 15.209 2.2	Radiated Spurious Emissions	Emissions <1 GHz (30M-1 GHz)	Radiated	Complies	8.1.2.1
15.207 7.2.2	AC Wireline Conducted Emissions 150 kHz– 30 MHz	Conducted Emissions	Conducted	N/A EUT is DC powered	8.1.3

Note 1: Test results reported in this document relate only to the items tested

Note 2: The required tests demonstrated compliance as per client declaration of test configuration, monitoring methodology and associated pass/fail criteria

Note 3: Section 5.7 Equipment Modifications highlights the equipment modifications that were required to bring the product into compliance with the above test matrix

This test report may be reproduced in full only. The document may only be updated by MiCOM Labs personnel. Any changes will be noted in the Document History section of the report.



Title: Ear Force i70 TX Wireless Audio Transmitter
To: FCC 47 CFR Part 15.247 & IC RSS-210
Serial #: COMM71-U6 Rev A
Issue Date: 27th February 2014
Page: 25 of 53

8 TEST RESULTS

8.1 Device Characteristics

8.1.1 Conducted Testing

8.1.1.1 6 dB and 99 % Bandwidth

Conducted Test Conditions for 6 dB and 99% Bandwidth			
Standard:	FCC CFR 47:15.247	Ambient Temp. (°C):	24.0 - 27.5
Test Heading:	6 dB and 99 % Bandwidth	Rel. Humidity (%):	32 - 45
Standard Section(s):	15.247 (a)(2)	Pressure (mBars):	999 - 1001
Reference Document(s):	KDB 558074 - D01 DTS Measurement Guidance v01: Section 5.1 Emission Bandwidth		
Test Procedure for 6 dB and 99% Bandwidth Measurement The bandwidth at 6 dB and 99 % was measured with a spectrum analyzer connected to the antenna terminal, while EUT is operating in transmission mode at the appropriate centre frequency.			

Equipment Configuration for 6 dB & 99% Bandwidth			
Variant:	802.11g	Duty Cycle (%):	100
Data Rate:	6 Mbit/s	Antenna Gain (dBi):	Not Applicable
Modulation:	OFDM	Beam Forming Gain (Y):	Not Applicable
TPC:	Not Applicable	Tested By:	JMH
Engineering Test Notes:			

Test Measurement Results

Test Frequency	Measured 6 dB Bandwidth (MHz)				6 dB Bandwidth (MHz)		Limit	Lowest Margin
	Port(s)				Highest	Lowest		
MHz	a	b	c	d			KHz	MHz
2462.0	16.754				16.754	16.754	≥500.0	-16.25

Test Frequency	Measured 99% Bandwidth (MHz)				Maximum 99% Bandwidth (MHz)		
	Port(s)						
MHz	a	b	c	d			
2462.0	18.517				18.517		

Traceability to Industry Recognized Test Methodologies	
Work Instruction:	WI-03 MEASURING RF SPECTRUM MASK
Measurement Uncertainty:	±2.81 dB

Note: click the link in the above results matrix to view the plot

This test report may be reproduced in full only. The document may only be updated by MiCOM Labs personnel. Any changes will be noted in the Document History section of the report.



Title: Ear Force i70 TX Wireless Audio Transmitter
To: FCC 47 CFR Part 15.247 & IC RSS-210
Serial #: COMM71-U6 Rev A
Issue Date: 27th February 2014
Page: 26 of 53

Specification

Limits

§15.247 (a)(2) & RSS-210 §A8.2(a)

The minimum 6 dB bandwidth shall be at least 500 kHz.

Traceability

Test Equipment Used

0158, 0287, 0252, 0313, 0314, 0070, 0116, 0117

This test report may be reproduced in full only. The document may only be updated by MiCOM Labs personnel. Any changes will be noted in the Document History section of the report.



Title: Ear Force i70 TX Wireless Audio Transmitter
To: FCC 47 CFR Part 15.247 & IC RSS-210
Serial #: COMM71-U6 Rev A
Issue Date: 27th February 2014
Page: 27 of 53

8.1.1.2 Peak Output Power

Conducted Test Conditions for Fundamental Emission Output Power			
Standard:	FCC CFR 47:15.247	Ambient Temp. (°C):	24.0 - 27.5
Test Heading:	Emission Output Power	Rel. Humidity (%):	32 - 45
Standard Section(s):	15.247 (a)(2)	Pressure (mBars):	999 - 1004
Reference Document(s):	KDB 558074 - D01 DTS Measurement Guidance v01: Section 5.2 Fundamental Emission Output Power KDB 662911 was implemented for In-band power measurements. The measure and sum technique was implemented in all cases.		

Test Procedure for Fundamental Emission Output Power Measurement

The transmitter terminal of EUT was connected to the input of the spectrum analyzer set to measure peak power. The resolution filter bandwidth was set to 6 dB, peak detector selected and the analyzer built-in power function was used to integrate peak power over the 20 dB bandwidth.

Supporting Information

Calculated Power = A + G + 10 log (1/x) dBm

A = Total Power [10 Log10 (10^{a/10} + 10^{b/10} + 10^{c/10} + 10^{d/10})], G = Antenna Gain,
 x = Duty Cycle

Equipment Configuration for Peak Output Power

Variant:	802.11g	Duty Cycle (%):	100
Data Rate:	6 Mbit/s	Antenna Gain (dBi):	-1.50
Modulation:	OFDM	Beam Forming Gain (Y):	Not Applicable
TPC:	Not Applicable	Tested By:	JMH
Engineering Test Notes:			

Test Measurement Results

Test Frequency	Measured Output Power (dBm)				Limit	Margin	EUT Power Setting	
	Port(s)							
MHz	a	b	c	d	dBm	dBm	dBm	
2462.0	11.08				11.08	30.00	-18.92	SPW 1

Traceability to Industry Recognized Test Methodologies

Work Instruction:	WI-01 MEASURING RF OUTPUT POWER
Measurement Uncertainty:	±1.33 dB

Note: [click the link in the above results matrix to view the plot](#)

This test report may be reproduced in full only. The document may only be updated by MiCOM Labs personnel. Any changes will be noted in the Document History section of the report.



Specification

Limits

§15.247 (b) The maximum peak output power of the intentional radiator shall not exceed the following:

§15.247 (b) (3) For systems using digital modulation in the 902-928 MHz, 2400-2483.5 MHz and 5725-5850 MHz bands: 1.0 watt.

15.247 (b) (4) The conducted output power limit specified in paragraph (b) of this section is based on the use of antennas with directional gains that do not exceed 6 dBi. Except as shown in paragraph (c) of this section, if transmitting antennas of directional gain greater than 6 dBi are used, the conducted output power from the intentional radiator shall be reduced below the stated values in paragraphs (b)(1), (b)(2), and (b)(3) of this section, as appropriate, by the amount in dB that the directional gain of the antenna exceeds 6 dBi.

15.247 (c) Operation with directional antenna gains greater than 6 dBi.

(1) Fixed point-to-point operation:

(i) Systems operating in the 2400–2483.5 MHz band that are used exclusively for fixed, point-to-point operations may employ transmitting antennas with directional gain greater than 6 dBi provided the maximum conducted output power of the intentional radiator is reduced by 1 dB for every 3 dB that the directional gain of the antenna exceeds 6 dBi.

(ii) Systems operating in the 5725–5850 MHz band that are used exclusively for fixed, point-to-point operations may employ transmitting antennas with directional gain greater than 6 dBi without any corresponding reduction in transmitter conducted output power.

§15.31 (e) For intentional radiators, measurements of the variation of the input power or the radiated signal level of the fundamental frequency component of the emission, as appropriate, shall be performed with the supply voltage varied between 85% and 115% of the nominal rated supply voltage. For battery operated equipment, the equipment tests shall be performed using a new battery.

§ RSS-210 A8.4(4) For systems employing digital modulation techniques operating in the 902-928 MHz, 2400-2483.5 MHz and 5725-5850 MHz bands the maximum peak conducted power shall not exceed 1 watt.

Traceability

Method	Test Equipment Used
Measurements were made per work instruction WI-01 'Measuring RF Output Power'	0158, 0287, 0252, 0313, 0314, 0070, 0116, 0117

This test report may be reproduced in full only. The document may only be updated by MiCOM Labs personnel. Any changes will be noted in the Document History section of the report.



Title: Ear Force i70 TX Wireless Audio Transmitter
To: FCC 47 CFR Part 15.247 & IC RSS-210
Serial #: COMM71-U6 Rev A
Issue Date: 27th February 2014
Page: 29 of 53

8.1.1.3 Power Spectral Density

Conducted Test Conditions for Power Spectral Density			
Standard:	FCC CFR 47:15.247	Ambient Temp. (°C):	24.0 - 27.5
Test Heading:	Power Spectral Density	Rel. Humidity (%):	32 - 45
Standard Section(s):	15.247 (e)	Pressure (mBars):	999 - 1001
Reference Document(s):	KDB 558074 - D01 DTS Measurement Guidance v01: Section 5.3 Maximum Power Spectral Density Level in the Emission Bandwidth		
Test Procedure for Power Spectral Density			
<p>The transmitter output was connected to a spectrum analyzer and the maximum level in a 3 kHz bandwidth was measured. A peak value was found over the full emission bandwidth and the frequency span reduced to obtain enhanced resolution. Sweep time \geq span / 3 kHz with video averaging turned off. The Peak Power Spectral Density is the highest level found across the emission in a 3 kHz resolution bandwidth.</p>			
Supporting Information			
<p>Calculated Power = $A + 10 \log (1/x)$ dBm $A = \text{Total Power Spectral Density } [10 \text{ Log}_{10} (10^{a/10} + 10^{b/10} + 10^{c/10} + 10^{d/10})]$ $x = \text{Duty Cycle}$</p>			
<p>Limit Line: KDB 662911 was implemented for In-band power spectral density (PSD) measurements - Option (2) measure and subtract 10 log (N) dB from the limit for devices with multiple RF ports</p>			

Equipment Configuration for Power Spectral Density - Peak			
Variant:	802.11g	Duty Cycle (%):	100
Data Rate:	6 Mbit/s	Antenna Gain (dBi):	Not Applicable
Modulation:	OFDM	Beam Forming Gain (Y):	Not Applicable
TPC:	Not Applicable	Tested By:	JMH
Engineering Test Notes:			

Test Measurement Results

Test Frequency	Measured Power Spectral Density (dBm)				Calculated Total Power Spectral Density		Limit	Margin
	Port(s)				dBm			
MHz	a	b	c	d		Conversion to 3 kHz RBW	dBm	dB
2462.0	-13.434				-13.434	-23.434	8.00	-31.43

Traceability to Industry Recognized Test Methodologies	
Work Instruction:	WI-03 MEASURING RF SPECTRUM MASK
Measurement Uncertainty:	± 1.33 dB

Note: [click the link in the above results matrix to view the plot](#)

This test report may be reproduced in full only. The document may only be updated by MiCOM Labs personnel. Any changes will be noted in the Document History section of the report.



Title: Ear Force i70 TX Wireless Audio Transmitter
To: FCC 47 CFR Part 15.247 & IC RSS-210
Serial #: COMM71-U6 Rev A
Issue Date: 27th February 2014
Page: 30 of 53

Specification
Peak Power Spectral Density Limits

§15.247(e) For digitally modulated systems, the power spectral density conducted from the intentional radiator to the antenna shall not be greater than +8 dBm in any 3 kHz band during any time interval of continuous transmission

RSS-210 §A8.2(2) The transmitter power spectral density (into the antenna) shall not be greater than +8 dBm in any 3 kHz band during any time interval of continuous transmission or over 1.0 second if the transmission exceeds 1.0 second duration.

Traceability

Method	Test Equipment Used
Measurements were made per work instruction WI-01 'Measuring RF Output Power'	0158, 0287, 0252, 0313, 0314, 0070, 0116, 0117

This test report may be reproduced in full only. The document may only be updated by MiCOM Labs personnel. Any changes will be noted in the Document History section of the report.



Title: Ear Force i70 TX Wireless Audio Transmitter
To: FCC 47 CFR Part 15.247 & IC RSS-210
Serial #: COMM71-U6 Rev A
Issue Date: 27th February 2014
Page: 31 of 53

8.1.1.4 Conducted Spurious Emissions

Conducted Test Conditions for Transmitter Conducted Spurious and Band-Edge Emissions			
Standard:	FCC CFR 47:15.247	Ambient Temp. (°C):	24.0 - 27.5
Test Heading:	Max Unwanted Emission Levels	Rel. Humidity (%):	32 - 45
Standard Section(s):	15.247 (d)	Pressure (mBars):	999 - 1001
Reference Document(s):	KDB 558074 - D01 DTS Measurement Guidance v01: Section 5.4 Maximum Unwanted Emission Levels		

Test Procedure for Transmitter Conducted Spurious and Band-Edge Emissions Measurement
Transmitter Conducted Spurious and Band-Edge emissions were measured at a limit of 20 dB below the highest in-band spectral density measured with a spectrum analyzer connected to the antenna terminal. Measurements were made while EUT was operating in transmit mode of operation at the appropriate centre frequency closest to the band-edge. Emissions were maximized during the measurement and limits derived from the peak spectral power and drawn on each plot.

This test report may be reproduced in full only. The document may only be updated by MiCOM Labs personnel. Any changes will be noted in the Document History section of the report.



Title: Ear Force i70 TX Wireless Audio Transmitter
To: FCC 47 CFR Part 15.247 & IC RSS-210
Serial #: COMM71-U6 Rev A
Issue Date: 27th February 2014
Page: 32 of 53

Equipment Configuration for Transmitter Conducted Spurious Emissions

Variant:	802.11g	Duty Cycle (%):	100
Data Rate:	6 Mbit/s	Antenna Gain (dBi):	Not Applicable
Modulation:	OFDM	Beam Forming Gain (Y):	Not Applicable
TPC:	Not Applicable	Tested By:	JMH
Engineering Test Notes:			

Test Measurement Results

Test Frequency	Frequency Range	Transmitter Conducted Spurious Emissions (dBm)							
		Port a		Port b		Port c		Port d	
MHz	MHz	SE	Limit	SE	Limit	SE	Limit	SE	Limit
2462.0	30.0 - 26000.0	-56.452	-30.20						

Test Measurement Results

Test Frequency	Band-Edge Frequency	Transmitter Conducted Band-Edge Emissions (dBm)							
		Port a		Port b		Port c		Port d	
MHz	MHz	BE	Limit	BE	Limit	BE	Limit	BE	Limit
2462.0	2483.5	-42.767	-29.65						

Traceability to Industry Recognized Test Methodologies

Work Instruction:	WI-05 MEASUREMENT OF SPURIOUS EMISSIONS
Measurement Uncertainty:	= 40 GHz \pm 2.37 dB, > 40 GHz \pm 4.6 dB

This test report may be reproduced in full only. The document may only be updated by MiCOM Labs personnel. Any changes will be noted in the Document History section of the report.



Title: Ear Force i70 TX Wireless Audio Transmitter
To: FCC 47 CFR Part 15.247 & IC RSS-210
Serial #: COMM71-U6 Rev A
Issue Date: 27th February 2014
Page: 33 of 53

Specification

Limits Band-Edge

Lower Limit Band-edge	Upper Limit Band-edge	Limit below highest level of desired power
2,400 MHz	2,483.5 MHz	≥ 20 dB
5725 MHz	5850 MHz	

§15.247(d) and RSS-210 §A8.5 In any 100 kHz bandwidth outside the frequency band in which the spread spectrum or digitally modulated intentional radiator is operating, the radio frequency power that is produced by the intentional radiator shall be at least 20 dB below that in the 100 kHz bandwidth within the band that contains the highest level of the desired power, based on either an RF conducted or a radiated measurement, provided the transmitter demonstrates compliance with the peak conducted power limits. If the transmitter complies with the conducted power limits based on the use of RMS averaging over a time interval, as permitted under paragraph (b)(3) of this section, the attenuation required under this paragraph shall be 30 dB instead of 20 dB. Attenuation below the general limits specified in § 15.209(a) is not required. In addition, radiated emissions which fall in the restricted bands, as defined in § 15.205(a), must also comply with the radiated emission limits specified in § 15.209(a) (see § 15.205(c)).

Laboratory Measurement Uncertainty for Conducted Spurious Emissions

Measurement uncertainty	±2.37 dB
-------------------------	----------

Traceability

Method	Test Equipment Used
Measurements were made per work instruction WI-05 'Measurement of Spurious Emissions'	0088, 0158, 0287, 0252, 0313, 0314, 0070, 0116, 0117.

This test report may be reproduced in full only. The document may only be updated by MiCOM Labs personnel. Any changes will be noted in the Document History section of the report.



Title: Ear Force i70 TX Wireless Audio Transmitter
To: FCC 47 CFR Part 15.247 & IC RSS-210
Serial #: COMM71-U6 Rev A
Issue Date: 27th February 2014
Page: 34 of 53

8.1.2 Radiated Emission Testing

Transmitter Radiated Spurious Emissions (above 1 GHz); Peak Field Strength Measurements; and Radiated Band Edge Measurements – Restricted Bands

FCC, Part 15 Subpart C §15.247(d) 15.205; 15.209
Industry Canada RSS-210 §A8.5, §2.2, §2.6
Industry Canada RSS-Gen §4.7

Test Procedure

The worst case highest spectral density radiated emissions above 1 GHz are measured in the anechoic chamber at a 3-meter distance on every azimuth in both horizontal and vertical polarities. The emissions are recorded and maximized as a function of azimuth by rotation through 360° with a spectrum analyzer in peak hold mode. Depending on the frequency band spanned a notch filter and waveguide filter was used to remove the fundamental frequency. The highest emissions relative to the limit are listed for each frequency spanned.

All measurements on any frequency or frequencies over 1 MHz are based on the use of measurement instrumentation employing an average detector function. All measurements above 1 GHz were performed using a minimum resolution bandwidth of 1 MHz.

Field Strength Calculation

The field strength is calculated by adding the Antenna Factor and Cable Loss, and subtracting Amplifier Gain from the measured reading. All factors are included in the reported data.

$$FS = R + AF + CORR - FO$$

where: FS = Field Strength

R = Measured Spectrum analyzer Input Amplitude

AF = Antenna Factor

CORR = Correction Factor = CL – AG + NFL

CL = Cable Loss

AG = Amplifier Gain

FO = Distance Falloff Factor

NFL = Notch Filter Loss or Waveguide Loss

For example:

Given receiver input reading of 51.5 dB μ V; Antenna Factor of 8.5 dB; Cable Loss of 1.3 dB; Falloff Factor of 0 dB, an Amplifier Gain of 26 dB and Notch Filter Loss of 1 dB. The Field Strength of the measured emission is:

$$FS = 51.5 + 8.5 + 1.3 - 26.0 + 1 = 36.3 \text{ dB}\mu\text{V/m}$$

Conversion between dB μ V/m (or dB μ V) and μ V/m (or μ V) are done as:

$$\text{Level (dB}\mu\text{V/m)} = 20 * \text{Log (level (\mu\text{V/m}))}$$

$$40 \text{ dB}\mu\text{V/m} = 100 \mu\text{V/m}$$

$$48 \text{ dB}\mu\text{V/m} = 250 \mu\text{V/m}$$

This test report may be reproduced in full only. The document may only be updated by MiCOM Labs personnel. Any changes will be noted in the Document History section of the report.



Title: Ear Force i70 TX Wireless Audio Transmitter
To: FCC 47 CFR Part 15.247 & IC RSS-210
Serial #: COMM71-U6 Rev A
Issue Date: 27th February 2014
Page: 35 of 53

Test Freq.	2462	Engineer	JMH
Variant	802.11g; 6 Mbs	Temp (°C)	25
Freq. Range	1000 MHz - 18000 MHz	Rel. Hum.(%)	32
Power Setting	SPW 0	Press. (mBars)	1002
Antenna	Chip -1.5 dBi	Duty Cycle (%)	100
Test Notes 1			
Test Notes 2			

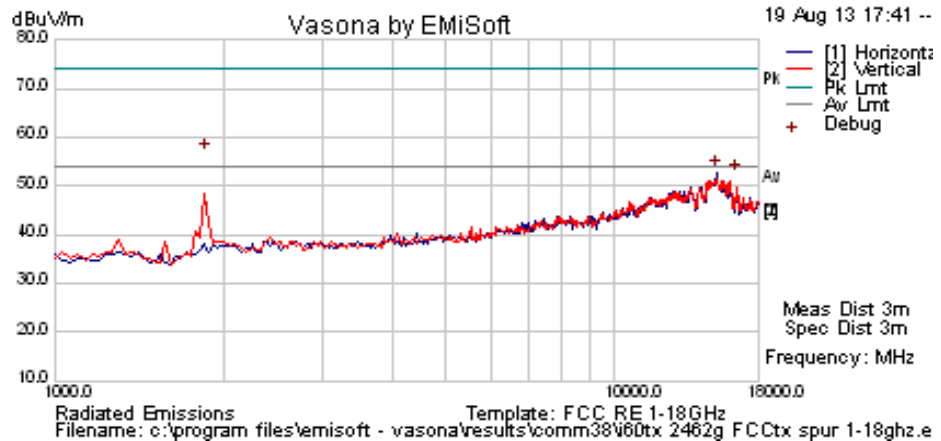

Formally measured emission peaks

Frequency MHz	Raw dBuV	Cable Loss	AF dB	Level dBuV/m	Measurement Type	Pol	Hgt cm	Azt Deg	Limit dBuV/m	Margin dB	Pass /Fail	Comments
1861.403	66.3	2.8	-12.3	56.8	Peak Max	V	141	231	74.0	-17.3	Pass	NRB
15198.156	46.2	8.6	-1.5	53.4	Peak Max	H	176	332	74	-20.7	Pass	NRB
16516.152	42.8	9.2	0.4	52.4	Peak Max	V	99	0	74	-21.6	Pass	NRB

Legend: TX = Transmitter Emissions; DIG = Digital Emissions; FUND = Fundamental; WB = Wideband Emission
 RB = Restricted Band (15.209 Limits); NRB = Non Restricted Band, Limit is 20dB below fundamental peak

This test report may be reproduced in full only. The document may only be updated by MiCOM Labs personnel. Any changes will be noted in the Document History section of the report.



Title: Ear Force i70 TX Wireless Audio Transmitter
To: FCC 47 CFR Part 15.247 & IC RSS-210
Serial #: COMM71-U6 Rev A
Issue Date: 27th February 2014
Page: 36 of 53

Band Edge 2300-2390 MHz

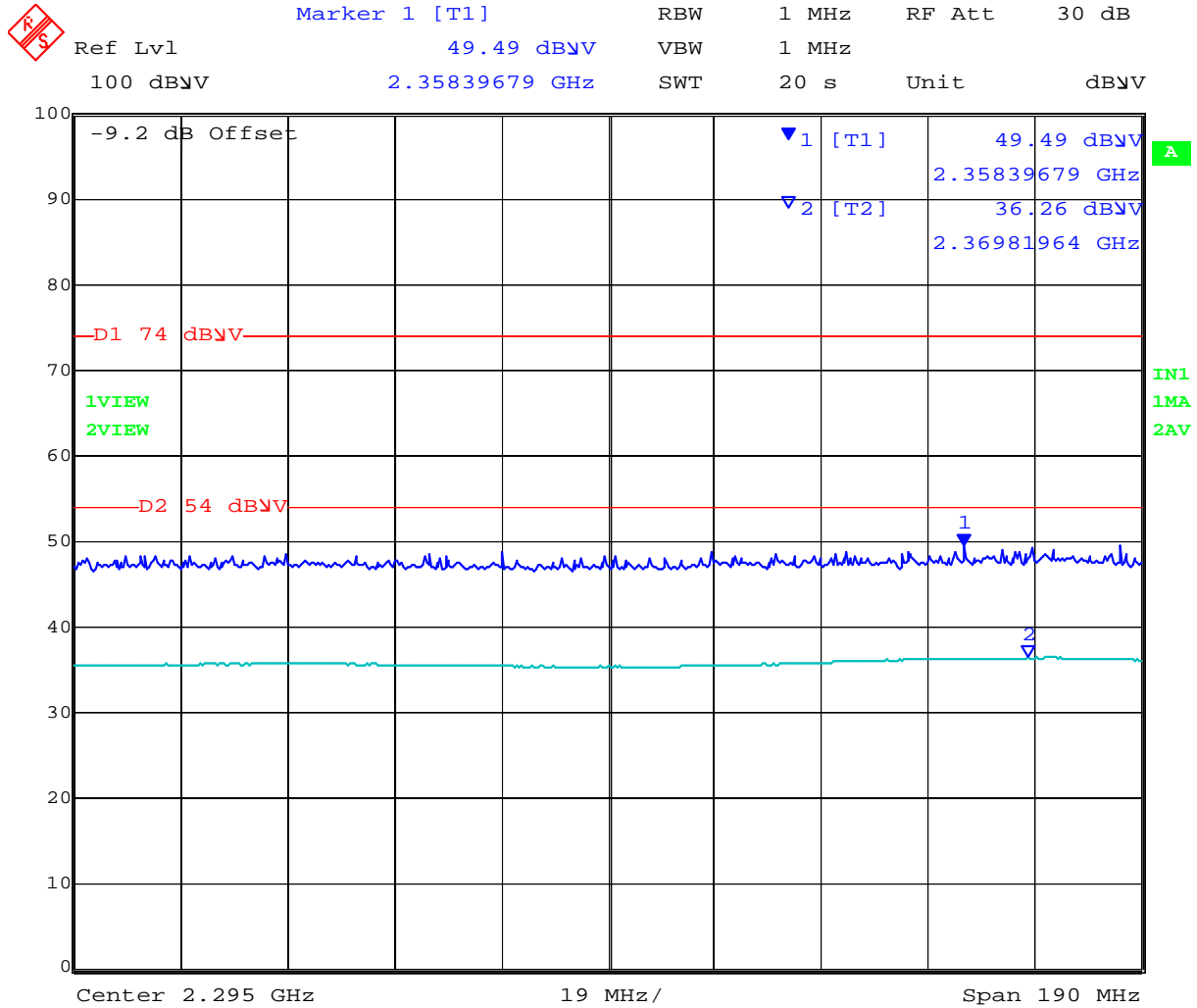

Date: 19.AUG.2013 18:15:50

This test report may be reproduced in full only. The document may only be updated by MiCOM Labs personnel. Any changes will be noted in the Document History section of the report.



Band Edge 2483.5 – 2500 MHz

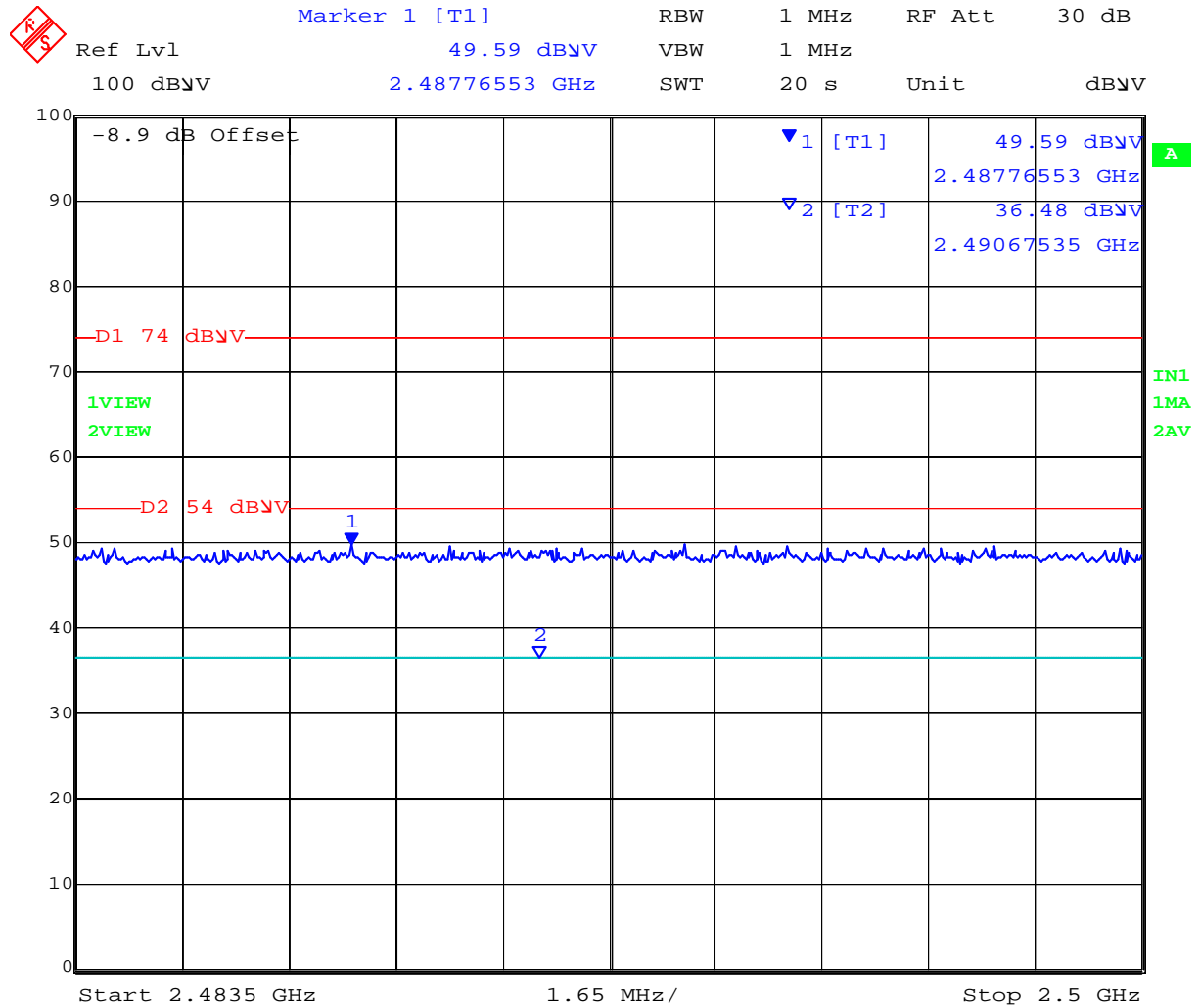

Date: 20.AUG.2013 09:57:22

This test report may be reproduced in full only. The document may only be updated by MiCOM Labs personnel. Any changes will be noted in the Document History section of the report.



Title: Ear Force i70 TX Wireless Audio Transmitter
To: FCC 47 CFR Part 15.247 & IC RSS-210
Serial #: COMM71-U6 Rev A
Issue Date: 27th February 2014
Page: 38 of 53

Specification Limits

FCC §15.247(d) and RSS-210 §A8.5 In any 100 kHz bandwidth outside the frequency band in which the spread spectrum or digitally modulated intentional radiator is operating, the radio frequency power that is produced by the intentional radiator shall be at least 20 dB below that in the 100 kHz bandwidth within the band that contains the highest level of the desired power, based on either an RF conducted or radiated measurement, provided the transmitter demonstrates compliance with the peak conducted power limits.

FCC §15.247(d)

If the transmitter complies with the conducted power limits based on the use of RMS averaging over a time interval, as permitted under paragraph (b)(3) of this section, the attenuation required under this paragraph shall be 30 dB instead of 20 dB. Attenuation below the general limits specified §15.209(a) is not required. In addition, radiated emissions which fall in the restricted bands, as defined in Section §15.205(a), must also comply with the radiated emission limits specified in Section 15.209(a) (see Section 15.205(a)).

IC RSS-210 §A8.5 If the transmitter complies with the conducted power limits based on the use of RMS averaging over a time interval, as permitted under section A8.4(4), the attenuation required shall be 30 dB instead of 20 dB. Attenuation below the general limits specified in Tables 2 and 3 is not required. In addition, radiated emissions which fall in the restricted bands of Table 1 must also comply with the radiated emission limits specified in Tables 2 and 3.

FCC §15.205 (a) Except as shown in paragraph (d) of 15.205 (a), only spurious emissions are permitted in any of the frequency bands listed.

FCC §15.205 (a) Except as shown in paragraphs (d) and (e) of this section, the field strength of emissions appearing within these frequency bands shall not exceed the limits shown in Section §15.209. At frequencies equal to or less than 1000 MHz, compliance with the limits in Section 15.209 shall be demonstrated using measurement instrumentation employing a CISPR quasi-peak detector. Above 1000 MHz, compliance with the emission limits in Section 15.209 shall be demonstrated based on the average value of the measured emissions. The provisions in Section 15.35 apply to these measurements.

FCC §15.209 (a) Except as provided elsewhere in this subpart, the emissions from an intentional radiator shall not exceed the field strength levels specified in the following table.



Title: Ear Force i70 TX Wireless Audio Transmitter
To: FCC 47 CFR Part 15.247 & IC RSS-210
Serial #: COMM71-U6 Rev A
Issue Date: 27th February 2014
Page: 39 of 53

§15.209 (a) Limit Matrix

Frequency(MHz)	Field Strength ($\mu\text{V/m}$)	Field Strength ($\text{dB}\mu\text{V/m}$)	Measurement Distance (meters)
30-88	100	40.0	3
88-216	150	43.5	3
216-960	200	46.0	3
Above 960	500	54.0	3

Laboratory Measurement Uncertainty for Radiated Emissions

Measurement uncertainty	+5.6/ -4.5 dB
-------------------------	---------------

Traceability

Method	Test Equipment Used
Measurements were made per work instruction WI-03 'Measurement of Radiated Emissions'	0088, 0158, 0134, 0304, 0311, 0315, 0310, 0312

This test report may be reproduced in full only. The document may only be updated by MiCOM Labs personnel. Any changes will be noted in the Document History section of the report.



Title: Ear Force i70 TX Wireless Audio Transmitter
To: FCC 47 CFR Part 15.247 & IC RSS-210
Serial #: COMM71-U6 Rev A
Issue Date: 27th February 2014
Page: 40 of 53

8.1.2.1 Digital Emissions (0.03-1 GHz)

FCC, Part 15 Subpart C §15.205/ §15.209
Industry Canada RSS-Gen §7.2.5

Test Procedure

Testing 30M-1 GHz was performed in a 3-meter anechoic chamber using a CISPR compliant receiver. Preliminary radiated emissions were measured on every azimuth and with the receiving antenna in both horizontal and vertical polarizations. To further maximize emissions the receive antenna was varied between 1 and 4 meters. The emissions are recorded with receiver in peak hold mode. Emissions closest to the limits are measured in the quasi-peak mode with the tuned receiver using a bandwidth of 120 kHz. Only the highest emissions relative to the limit are listed. The anechoic chamber test set-up is identified in Section 6 Test Set-Up Photographs.

The EUT had two methods of powering on ac/dc converter and Power over Ethernet (POE). Both modes were tested for emissions below 1GHz.

Field Strength Calculation

The field strength is calculated by adding the Antenna Factor and Cable Loss, and subtracting Amplifier Gain from the measured reading. In this test facility, the Antenna Factor, Cable Loss, and Amplifier Gains are loaded into the Rohde & Schwarz Receiver and the corrected field strength can be read directly on the receiver.

$$FS = R + AF + CORR$$

where:

FS = Field Strength
R = Measured Receiver Input Amplitude
AF = Antenna Factor
CORR = Correction Factor = CL – AG + NFL
CL = Cable Loss
AG = Amplifier Gain

For example:

Given a Receiver input reading of 51.5dB μ V; Antenna Factor of 8.5dB; Cable Loss of 1.3dB; Falloff Factor of 0dB, an Amplifier Gain of 26dB and Notch Filter Loss of 1dB. The Field Strength of the measured emission is:

$$FS = 51.5 + 8.5 + 1.3 - 26.0 + 1 = 36.3\text{dB}\mu\text{V/m}$$

Conversion between dB μ V/m (or dB μ V) and μ V/m (or μ V) are done as:

$$\text{Level (dB}\mu\text{V/m)} = 20 * \text{Log (level (\mu\text{V/m}))}$$

$$40 \text{ dB}\mu\text{V/m} = 100\mu\text{V/m}$$

$$48 \text{ dB}\mu\text{V/m} = 250\mu\text{V/m}$$

This test report may be reproduced in full only. The document may only be updated by MiCOM Labs personnel. Any changes will be noted in the Document History section of the report.



Title: Ear Force i70 TX Wireless Audio Transmitter
To: FCC 47 CFR Part 15.247 & IC RSS-210
Serial #: COMM71-U6 Rev A
Issue Date: 27th February 2014
Page: 41 of 53

WiFi Only

Test Freq.	NA	Engineer	JMH
Variant	Digital Emissions	Temp (°C)	13
Freq. Range	30 MHz - 1000 MHz	Rel. Hum.(%)	33
Power Setting	NA	Press. (mBars)	1007
Antenna	NA		
Test Notes 1	Wifi Mode		
Test Notes 2			

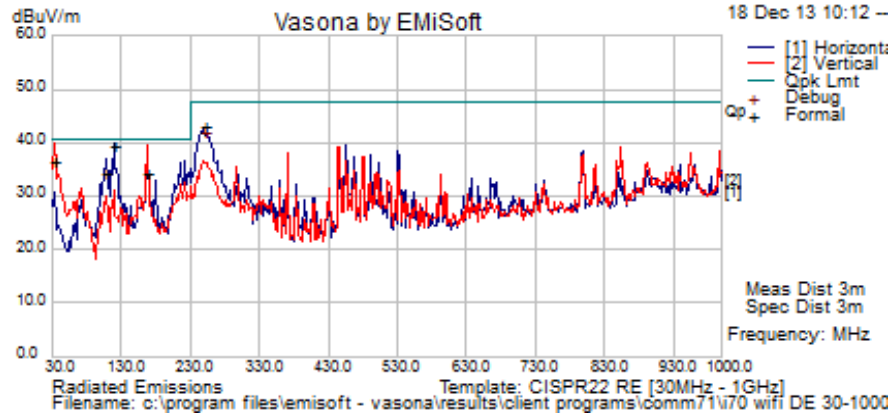

Formally measured emission peaks

Frequency MHz	Raw dBuV	Cable Loss	AF dB	Level dBuV/m	Measurement Type	Pol	Hgt cm	Azt Deg	Limit dBuV/m	Margin dB	Pass /Fail	Comments
33.558	44.9	3.5	-12.2	36.260	Quasi Max	V	125	218	40.5	-4.2	Pass	
120.025	52.4	4.2	-17.2	39.4	Quasi Max	H	249	236	40.5	-1.1	Pass	
168.061	48.5	4.5	-18.9	34.1	Quasi Max	V	109	333	40.5	-6.4	Pass	
108.061	49.0	4.1	-18.8	34.3	Quasi Max	H	181	204	40.5	-6.2	Pass	
250.000	57.0	4.9	-18.8	43.0	Quasi Max	H	120	155	47.5	-4.5	Pass	

Legend: DIG = Digital Device Emission; TX = Transmitter Emission; FUND = Fundamental Frequency
 NRB = Non-Restricted Band, Limit is 20 dB below Fundamental; RB = Restricted Band

This test report may be reproduced in full only. The document may only be updated by MiCOM Labs personnel. Any changes will be noted in the Document History section of the report.



Title: Ear Force i70 TX Wireless Audio Transmitter
To: FCC 47 CFR Part 15.247 & IC RSS-210
Serial #: COMM71-U6 Rev A
Issue Date: 27th February 2014
Page: 42 of 53

Specification

Limits

§15.205 (a) Except as shown in paragraph (d) of 15.205 (a), only spurious emissions are permitted in any of the frequency bands listed.

§15.205 (a) Except as shown in paragraphs (d) and (e) of this section, the field strength of emissions appearing within these frequency bands shall not exceed the limits shown in Section §15.209. At frequencies equal to or less than 1000 MHz, compliance with the limits in Section 15.209 shall be demonstrated using measurement instrumentation employing a CISPR quasi-peak detector. Above 1000 MHz, compliance with the emission limits in Section 15.209 shall be demonstrated based on the average value of the measured emissions. The provisions in Section 15.35 apply to these measurements.

§15.209 (a) Except as provided elsewhere in this subpart, the emissions from an intentional radiator shall not exceed the field strength levels specified in the following table.

§15.209 (a) and Industry Canada RSS-Gen §7.2.5 Limit Matrix

Frequency(MHz)	Field Strength ($\mu\text{V}/\text{m}$)	Field Strength ($\text{dB}\mu\text{V}/\text{m}$)	Measurement Distance (meters)
30-88	100	40.0	3
88-216	150	43.5	3
216-960	200	46.0	3
Above 960	500	54.0	3

Laboratory Measurement Uncertainty for Radiated Emissions

Measurement uncertainty	+5.6/ -4.5 dB
-------------------------	---------------

Traceability

Method	Test Equipment Used
Measurements were made per work instruction WI-03 'Measurement of Radiated Emissions'	0088, 0158, 0134, 0304, 0311, 0315, 0310, 0312

This test report may be reproduced in full only. The document may only be updated by MiCOM Labs personnel. Any changes will be noted in the Document History section of the report.

8.1.3 AC Wireline Conducted Emissions (150 kHz – 30 MHz)

FCC, Part 15 Subpart C §15.207
Industry Canada RSS-Gen §7.2.4

Test Procedure

The EUT is configured in accordance with ANSI C63.4. The conducted emissions are measured in a shielded room with a spectrum analyzer in peak hold in the first instance. Emissions closest to the limit are measured in the quasi-peak mode (QP) with the tuned receiver using a bandwidth of 9 kHz. The emissions are maximized further by cable manipulation. The highest emissions relative to the limit are listed.

Test Measurement Set up

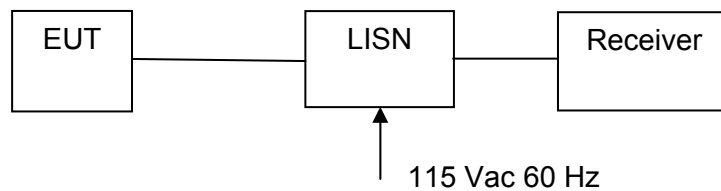

Measurement set up for AC Wireline Conducted Emissions Test

Measurement Results for AC Wireline Conducted Emissions (150 kHz – 30 MHz)

Ambient conditions.

Temperature: 17 to 23 °C Relative humidity: 31 to 57 % Pressure: 999 to 1012 mbar

Not required - EUT is power by USB only.



Title: Ear Force i70 TX Wireless Audio Transmitter
To: FCC 47 CFR Part 15.247 & IC RSS-210
Serial #: COMM71-U6 Rev A
Issue Date: 27th February 2014
Page: 44 of 53

Specification

Limit

§15.207 (a) Except as shown in paragraphs (b) and (c) of this section, for an intentional radiator that is designed to be connected to the public utility (AC) power line, the radio frequency voltage that is conducted back onto the AC power line on any frequency or frequencies within the band 150 kHz to 30 MHz shall not exceed the limits in the following table, as measured using a 50 $\mu\Omega$ line impedance stabilization network (LISN), see §15.207 (a) matrix below. Compliance with the provisions of this paragraph shall be based on the measurement of the radio frequency voltage between each power line and ground at the power terminal.

RSS-Gen §7.2.4

Except when the requirements applicable to a given device state otherwise, for any radio apparatus equipped to operate from the public utility AC power supply, either directly or indirectly (such as with a battery charger), the radio frequency voltage of emissions conducted back onto the AC power lines in the frequency range of 0.15 MHz to 30 MHz shall not exceed the limits shown in the table below. The more stringent limit applies at the frequency range boundaries. The conducted emissions shall be measured with a 50 ohm/50 microhenry line impedance stabilization network (LISN).

§15.207 (a) and RSS-Gen §7.2.4 Limit Matrix

The lower limit applies at the boundary between frequency ranges

Frequency of Emission (MHz)	Conducted Limit (dB μ V)	
	Quasi-peak	Average
0.15-0.5	66 to 56*	56 to 46*
0.5-5	56	46
5-30	60	50

* Decreases with the logarithm of the frequency

Laboratory Measurement Uncertainty for Conducted Emissions

Measurement uncertainty	± 2.64 dB
-------------------------	---------------

Traceability

Method	Test Equipment Used
Measurements were made per work instruction WI-EMC-01 'Measurement of Conducted Emissions'	0158, 0184, 0287, 0190, 0293, 0307

This test report may be reproduced in full only. The document may only be updated by MiCOM Labs personnel. Any changes will be noted in the Document History section of the report.

9 PHOTOGRAPHS

9.1 Conducted Test Setup



This test report may be reproduced in full only. The document may only be updated by MiCOM Labs personnel. Any changes will be noted in the Document History section of the report.



Title: Ear Force i70 TX Wireless Audio Transmitter
To: FCC 47 CFR Part 15.247 & IC RSS-210
Serial #: COMM71-U6 Rev A
Issue Date: 27th February 2014
Page: 46 of 53

10 TEST EQUIPMENT

Asset #	Instrument	Manufacturer	Part #	Serial #	Calibration Due Date
0390	Power Sensor	Agilent	U2000A	MY50000103	17 th Oct 14
0158	Barometer/ Thermometer	Control Co.	4196	E2844	8th Jan '15
0287	EMI Receiver	Rhode & Schwartz	ESIB40	100201	31 st Jul 14
0338	30 - 3000 MHz Antenna	Sunol	JB3	A052907	14 th Aug 14
0399	1-18 GHz Horn Antenna	EMCO	3117	00154575	10 th Oct 14
0252	SMA Cable	Megaphase	Sucoflex 104	None	N/A
0293	BNC Cable	Megaphase	1689 1GVT4	15F50B001	N/A
0307	BNC Cable	Megaphase	1689 1GVT4	15F50B002	N/A
0310	2m SMA Cable	Micro-Coax	UFA210A-0- 0787-3G03G0	209089-001	N/A
0312	3m SMA Cable	Micro-Coax	UFA210A-1- 1181-3G0300	209092-001	N/A
0314	30dB N-Type Attenuator	ARRA	N9444-30	1623	N/A
	EMC Test Software	EMISoft	Vasona	5.0051	N/A
	RF Conducted Test Software	National Instruments	Labview	Version 8.2	N/A
	RF Conducted Test Software	MiCOM Labs ATS		Version 1.5	N/A

This test report may be reproduced in full only. The document may only be updated by MiCOM Labs personnel. Any changes will be noted in the Document History section of the report.



Title: Ear Force i70 TX Wireless Audio Transmitter
To: FCC 47 CFR Part 15.247 & IC RSS-210
Serial #: COMM71-U6 Rev A
Issue Date: 27th February 2014
Page: 47 of 53

APPENDIX

A. SUPPORTING INFORMATION

A.1. CONDUCTED TEST PLOTS

This test report may be reproduced in full only. The document may only be updated by MiCOM Labs personnel. Any changes will be noted in the Document History section of the report.



A.1.1.1. 6 dB & 99% Bandwidth



6 dB & 99% BANDWIDTH

Variant: 802.11g, Channel: 2462.00 MHz, Chain a, Temp: Ambient, Voltage: 5 Vdc

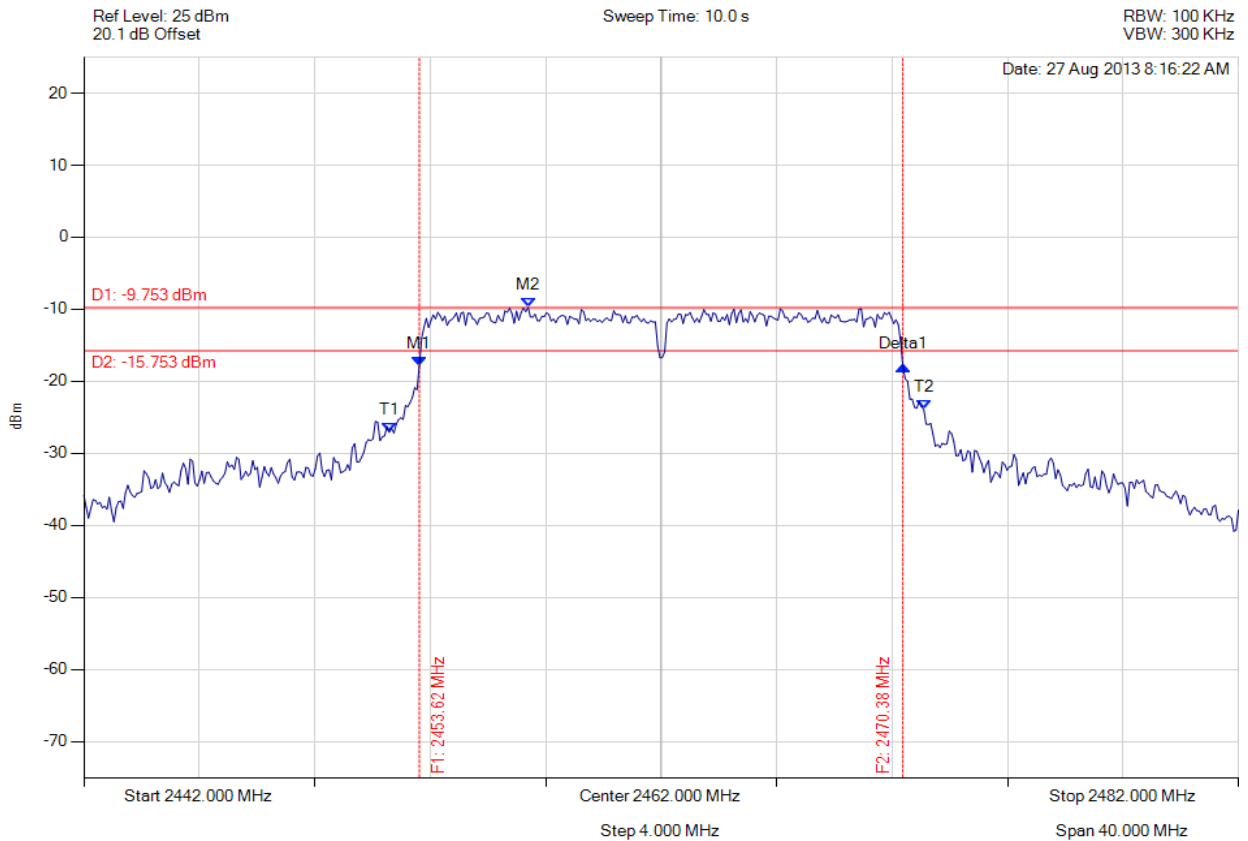

Analyser Setup	Marker : Frequency : Amplitude	Test Results
Detector = MAX PEAK Sweep Count = 0 RF Atten (dB) = 20 Trace Mode = VIEW	M1 : 2453.623 MHz : -17.892 dBm M2 : 2457.391 MHz : -9.753 dBm Delta1 : 16.754 MHz : -0.051 dB T1 : 2452.581 MHz : -27.068 dBm T2 : 2471.098 MHz : -23.928 dBm OBW : 18.517 MHz	Measured 6 dB Bandwidth: 16.754 MHz Limit: ≥500.0 kHz Margin: -16.25 MHz

[Back to the Matrix](#)

This test report may be reproduced in full only. The document may only be updated by MiCOM Labs personnel. Any changes will be noted in the Document History section of the report.

A.1.2. Peak Output Power



PEAK OUTPUT POWER

Variant: 802.11g, Channel: 2462.00 MHz, Chain a, Temp: Ambient, Voltage: 5 Vdc

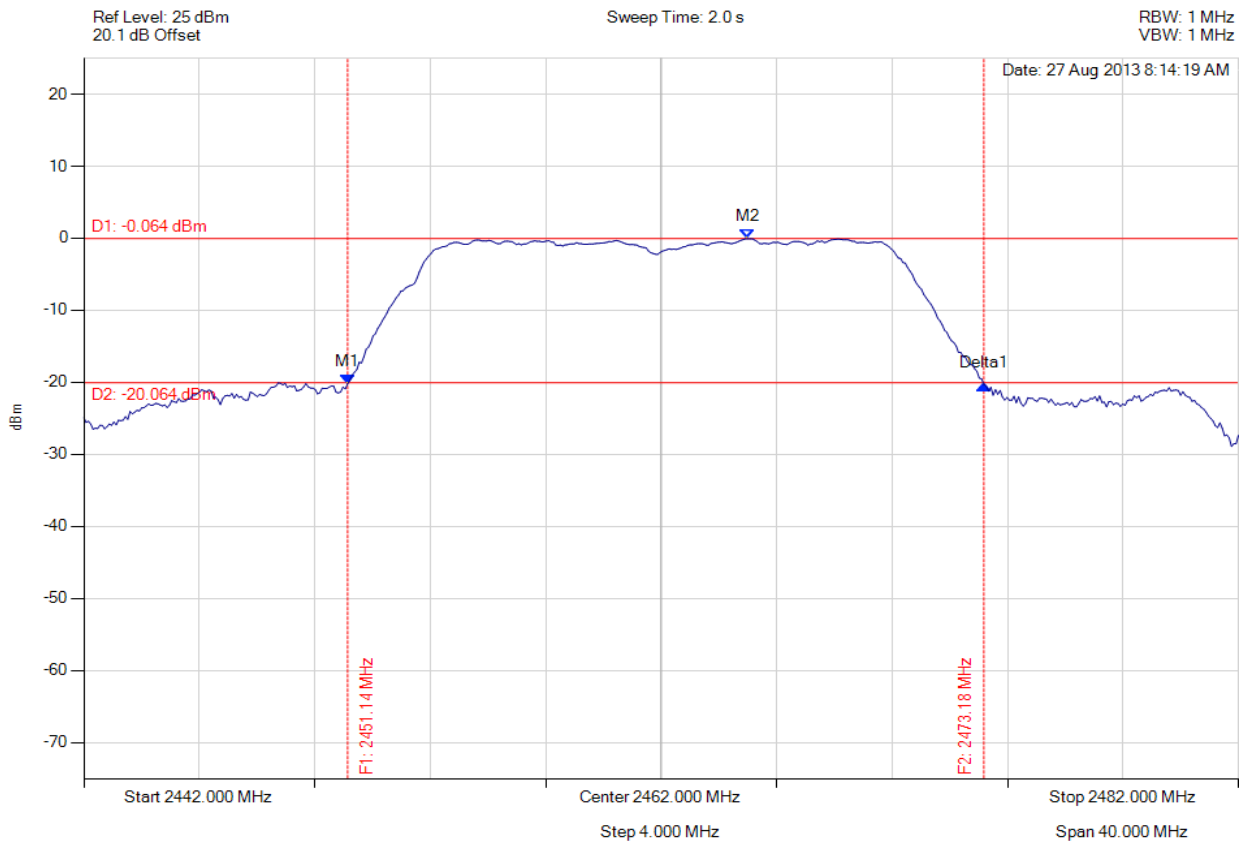

Analyser Setup	Marker : Frequency : Amplitude	Test Results
Detector = MAX PEAK Sweep Count = 0 RF Atten (dB) = 20 Trace Mode = VIEW	M1 : 2451.138 MHz : -20.212 dBm M2 : 2465.006 MHz : -0.064 dBm Delta1 : 22.044 MHz : -0.100 dB	Channel Power: 11.08 dBm Limit: 30.00 dBm Margin: -18.92 dB

[Back to the Matrix](#)

This test report may be reproduced in full only. The document may only be updated by MiCOM Labs personnel. Any changes will be noted in the Document History section of the report.



Title: Ear Force i70 TX Wireless Audio Transmitter
To: FCC 47 CFR Part 15.247 & IC RSS-210
Serial #: COMM71-U6 Rev A
Issue Date: 27th February 2014
Page: 50 of 53

A.1.3. Power Spectral Density



POWER SPECTRAL DENSITY - PEAK

Variant: 802.11g, Channel: 2462.00 MHz, Chain a, Temp: Ambient, Voltage: 5 Vdc

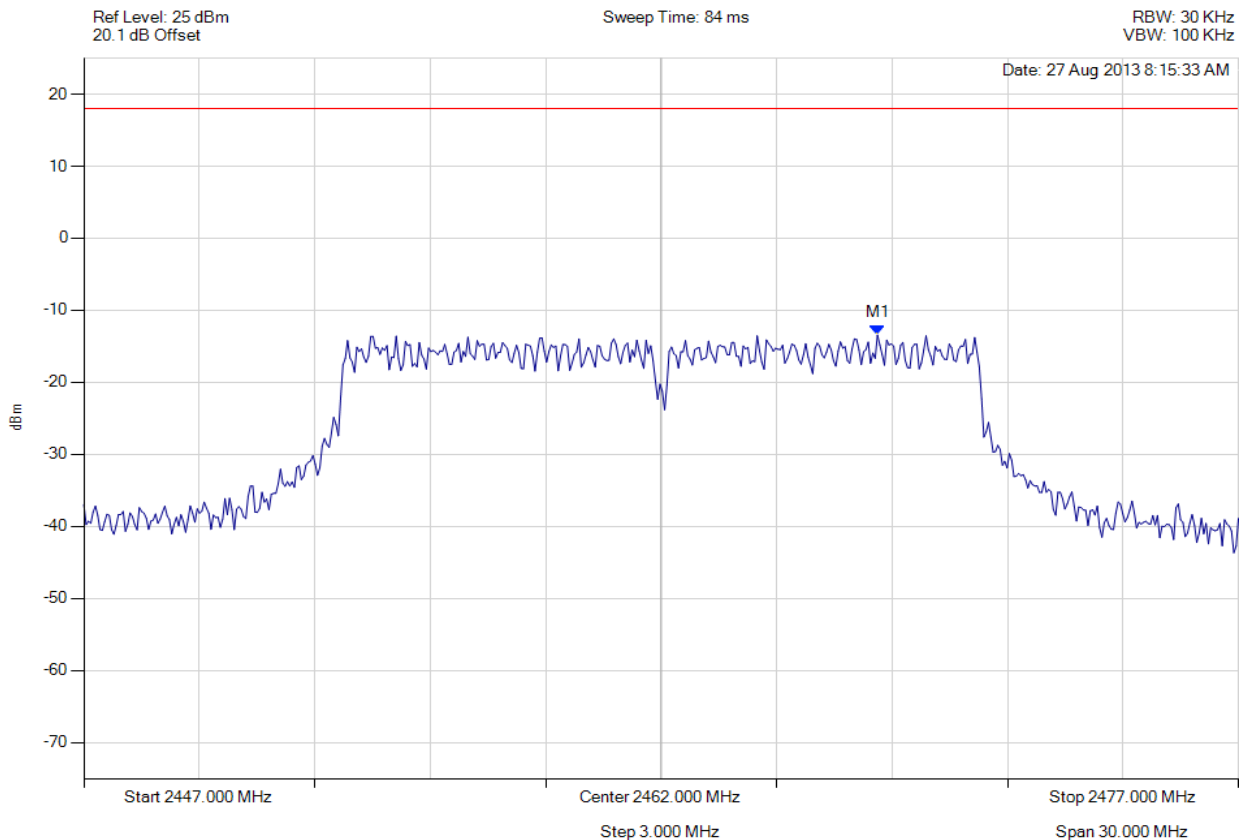

Analyser Setup	Marker : Frequency : Amplitude	Test Results
Detector = MAX PEAK Sweep Count = 0 RF Atten (dB) = 20 Trace Mode = VIEW	M1 : 2467.621 MHz : -13.434 dBm	Limit: ≤ 18.000 dBm Margin: dB

[Back to the Matrix](#)

This test report may be reproduced in full only. The document may only be updated by MiCOM Labs personnel. Any changes will be noted in the Document History section of the report.



Title: Ear Force i70 TX Wireless Audio Transmitter
To: FCC 47 CFR Part 15.247 & IC RSS-210
Serial #: COMM71-U6 Rev A
Issue Date: 27th February 2014
Page: 51 of 53

A.1.4. Conducted Spurious Emissions



CONDUCTED SPURIOUS EMISSIONS - PEAK

Variant: 802.11g, Channel: 2462.00 MHz, Chain a, Temp: Ambient, Voltage: 5 Vdc

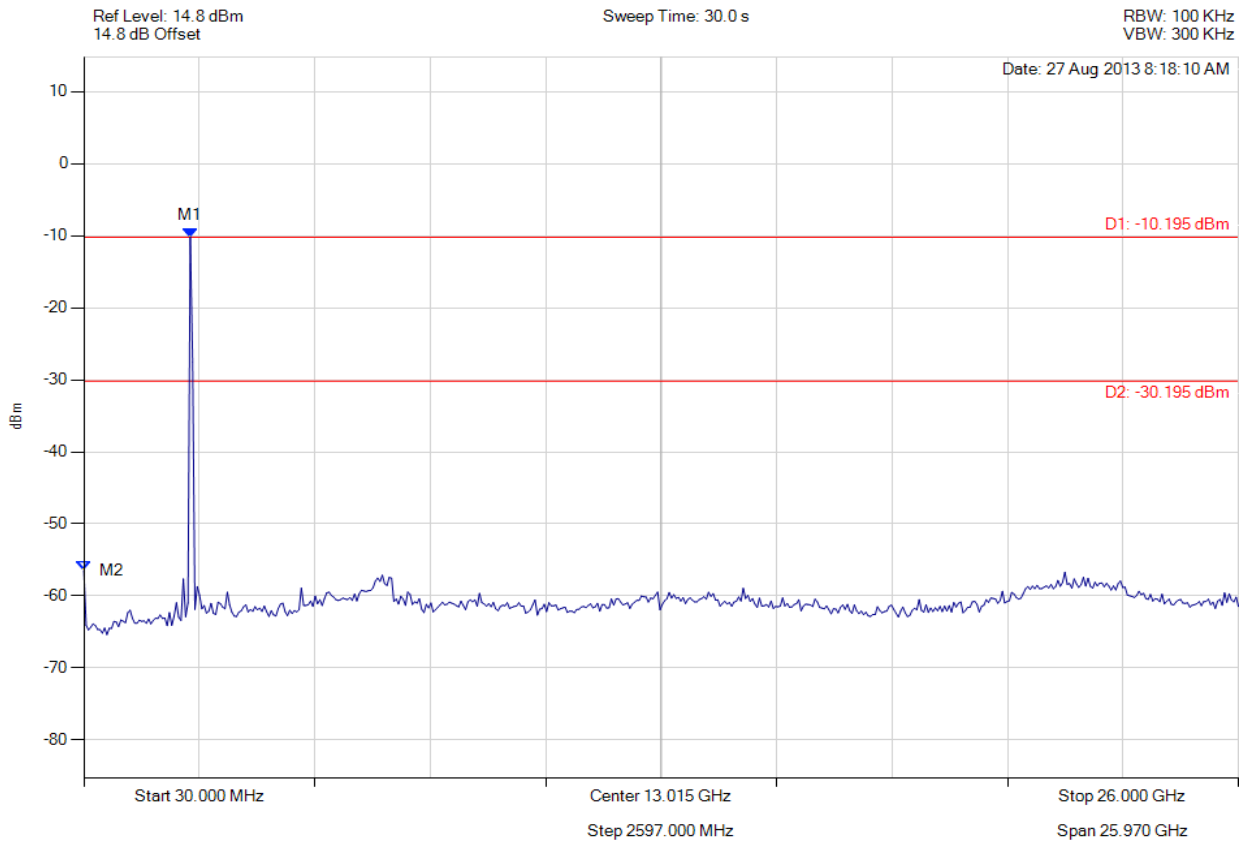

Analyser Setup	Marker : Frequency : Amplitude	Test Results
Detector = MAX PEAK Sweep Count = 0 RF Atten (dB) = 10 Trace Mode = VIEW	M1 : 2424.028 MHz : -10.195 dBm M2 : 30.000 MHz : -56.452 dBm	Limit: -30.20 dBm Margin: -26.25 dB

[Back to the Matrix](#)

This test report may be reproduced in full only. The document may only be updated by MiCOM Labs personnel. Any changes will be noted in the Document History section of the report.



Title: Ear Force i70 TX Wireless Audio Transmitter
To: FCC 47 CFR Part 15.247 & IC RSS-210
Serial #: COMM71-U6 Rev A
Issue Date: 27th February 2014
Page: 52 of 53



CONDUCTED HIGH BAND-EDGE EMISSION - PEAK

Variant: 802.11g, Channel: 2462.00 MHz, Chain a, Temp: Ambient, Voltage: 5 Vdc

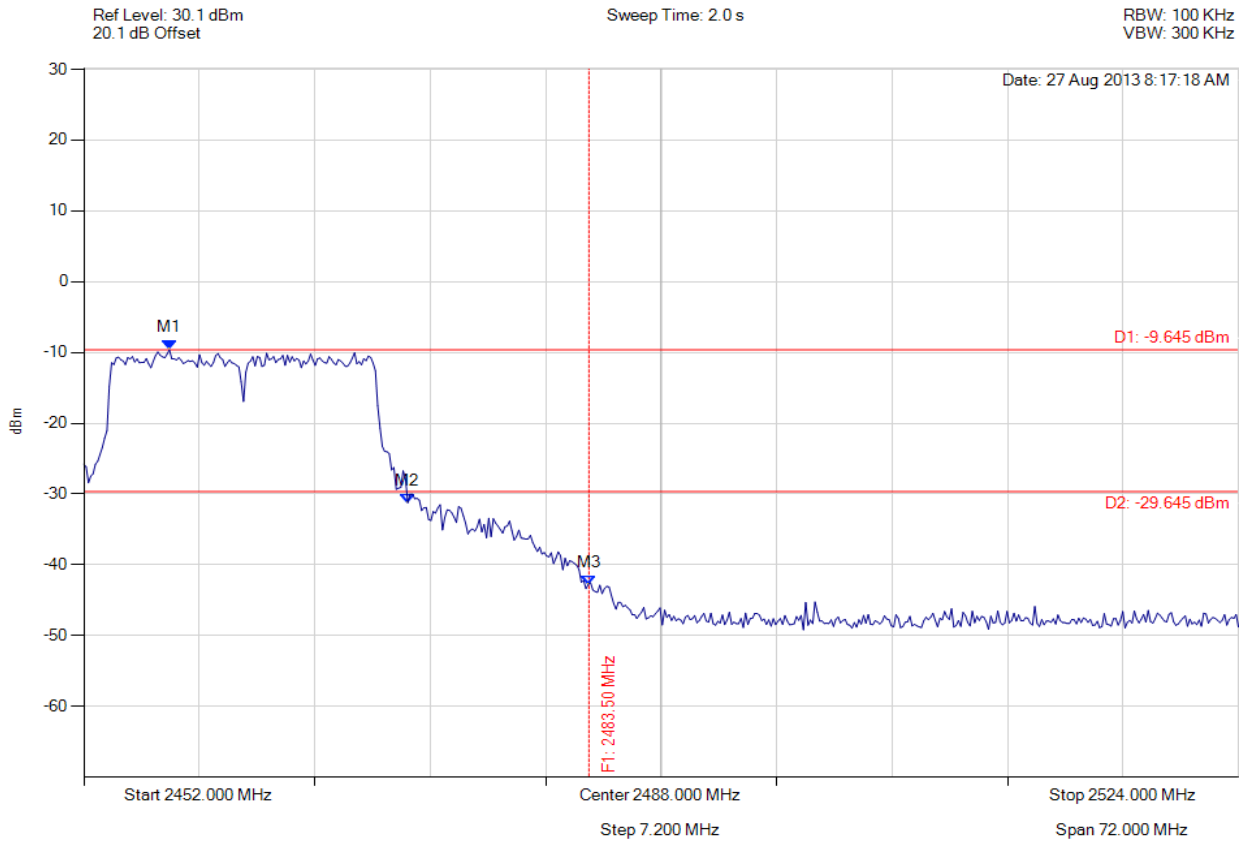

Analyser Setup	Marker : Frequency : Amplitude	Test Results
Detector = MAX PEAK Sweep Count = 0 RF Atten (dB) = 20 Trace Mode = VIEW	M1 : 2457.339 MHz : -9.645 dBm M2 : 2472.200 MHz : -31.228 dBm M3 : 2483.500 MHz : -42.767 dBm	Limit: -29.65 dBm Margin: -13.12 dB

[Back to the Matrix](#)

This test report may be reproduced in full only. The document may only be updated by MiCOM Labs personnel. Any changes will be noted in the Document History section of the report.



575 Boulder Court,
Pleasanton,
California 94566, USA
Tel: 1.925.462.0304
Fax: 1.925.462.0306
www.micomlabs.com