

Test of  
Ear Force i60 TX Wireless Audio Transmitter  
To: FCC 47 CFR Part 15.247 & IC RSS-210  
Test Report Serial No.: COMM38-U3 Rev A



# TEST REPORT

FROM



Test of Ear Force i60 TX Wireless Audio Transmitter

to

To FCC 47 CFR Part 15.247 & IC RSS-210

Test Report Serial No.: COMM38-U3 Rev A

Note: this report contains data with regard to the 2400 to 2483.5 MHz operational modes of the Turtle Beach, Ear Force i60 TX Wireless Audio Transmitter. Test data for Bluetooth operation for this device is reported in test report COMM38-U2; 5150 - 5250 MHz test data are reported in MiCOM Labs test report COMM38-U5.

This report supersedes: None

Applicant: Voyetra Turtle Beach Inc  
100 Summit Lake Drive, Suite 100  
Valhalla  
New York, 10595, USA

Product Function: Wireless Audio Transmitter

Copy No: pdf Issue Date: 30th September 2013

**This Test Report is Issued Under the Authority of:**

MiCOM Labs, Inc.  
440 Boulder Court, Suite 200  
Pleasanton, CA 94566 USA  
Phone: +1 (925) 462-0304  
Fax: +1 (925) 462-0306  
[www.micomlabs.com](http://www.micomlabs.com)



TEST CERTIFICATE #2381.01

**MiCOM Labs is an ISO 17025 Accredited Testing Laboratory**



**Title:** Ear Force i60 TX Wireless Audio Transmitter  
**To:** FCC 47 CFR Part 15.247 & IC RSS-210  
**Serial #:** COMM38-U3 Rev A  
**Issue Date:** 30th September 2013  
**Page:** 3 of 53

---

This page has been left intentionally blank



## TABLE OF CONTENTS

<b>ACCREDITATION, LISTINGS &amp; RECOGNITION .....</b>	<b>5</b>
TESTING ACCREDITATION .....	5
RECOGNITION .....	6
PRODUCT CERTIFICATION .....	7
<b>1. TEST RESULT SUMMARY .....</b>	<b>9</b>
<b>COMPLIANCE STATEMENT .....</b>	<b>10</b>
<b>2. REFERENCES AND MEASUREMENT UNCERTAINTY .....</b>	<b>11</b>
2.1. Normative References .....	11
2.2. Test and Uncertainty Procedures .....	12
<b>3. PRODUCT DETAILS AND TEST CONFIGURATIONS .....</b>	<b>13</b>
3.1. Technical Details .....	13
3.2. Scope of Test Program .....	14
3.3. Equipment Model(s) and Serial Number(s) .....	15
3.4. Antenna Details .....	15
3.5. Cabling and I/O Ports .....	15
3.6. Test Configurations .....	16
3.7. Equipment Modifications .....	18
3.8. Deviations from the Test Standard .....	18
<b>4. TEST EQUIPMENT CONFIGURATION(S) .....</b>	<b>19</b>
4.1. Conducted RF Emission Test Set-up .....	19
4.2. Radiated Spurious Emission Test Set-up > 1 GHz .....	20
4.3. Digital Emissions Test Set-up (0.03 – 1 GHz) .....	21
4.4. ac Wireline Emission Test Set-up .....	22
<b>5. TEST SUMMARY .....</b>	<b>23</b>
<b>6. TEST RESULTS .....</b>	<b>25</b>
6.1. Device Characteristics .....	25
6.1.1. <i>Conducted Testing</i> .....	25
6.1.2. <i>Radiated Emission Testing</i> .....	34
6.1.3. <i>AC Wireline Conducted Emissions (150 kHz – 30 MHz)</i> .....	43
<b>7. PHOTOGRAPHS .....</b>	<b>45</b>
7.1. Conducted Test Setup .....	45
<b>8. TEST EQUIPMENT .....</b>	<b>46</b>
<b>APPENDIX .....</b>	<b>47</b>
<b>A. SUPPORTING INFORMATION .....</b>	<b>47</b>
A.1. CONDUCTED TEST PLOTS .....	47
A.1.1. <i>6 dB &amp; 99% Bandwidth</i> .....	48
A.1.2. <i>Peak Output Power</i> .....	49
A.1.3. <i>Power Spectral Density</i> .....	50
A.1.4. <i>Conducted Spurious Emissions</i> .....	51

This test report may be reproduced in full only. The document may only be updated by MiCOM Labs personnel. Any changes will be noted in the Document History section of the report.

## ACCREDITATION, LISTINGS & RECOGNITION

### TESTING ACCREDITATION

MiCOM Labs, Inc. is an accredited Electrical testing laboratory per the international standard EN ISO/IEC 17025. The company is accredited by the American Association for Laboratory Accreditation (A2LA) [www.a2la.org](http://www.a2la.org) test laboratory number 2381.01. MiCOM Labs test schedule is available at the following URL; <http://www.a2la.org/scopepdf/2381-01.pdf>



The American Association for Laboratory Accreditation

World Class Accreditation

### *Accredited Laboratory*

A2LA has accredited

**MICOM LABS**

*Pleasanton, CA*

for technical competence in the field of

**Electrical Testing**

This laboratory is accredited in accordance with the recognized International Standard ISO/IEC 17025:2005 *General Requirements for the Competence of Testing and Calibration Laboratories*. This accreditation demonstrates technical competence for a defined scope and the operation of a laboratory quality management system (refer to joint ISO-ILAC-IAF Communiqué dated 8 January 2009).

Presented this 27<sup>th</sup> day of March 2012.



President & CEO  
For the Accreditation Council  
Certificate Number 2381.01  
Valid to November 30, 2013

*For the tests or types of tests to which this accreditation applies, please refer to the laboratory's Electrical Scope of Accreditation.*

This test report may be reproduced in full only. The document may only be updated by MiCOM Labs personnel. Any changes will be noted in the Document History section of the report.



**Title:** Ear Force i60 TX Wireless Audio Transmitter  
**To:** FCC 47 CFR Part 15.247 & IC RSS-210  
**Serial #:** COMM38-U3 Rev A  
**Issue Date:** 30th September 2013  
**Page:** 6 of 53

## **RECOGNITION**

MiCOM Labs, Inc has widely recognized Electrical testing capabilities. Our international recognition includes Conformity Assessment Body designation by APEC MRA\*\* countries. Our test reports are widely accepted for global type approvals.

Country	Recognition Body	Status	Phase	Identification No.
USA	Federal Communications Commission (FCC)	TCB	-	US0159 Listing #: 102167
Canada	Industry Canada (IC)	FCB	APEC MRA 2	US0159 Listing #: 4143A-2 4143A-3
Japan	MIC (Ministry of Internal Affairs and Communication)	CAB	APEC MRA 2	RCB 210
	VCCI	--	--	A-0012
Europe	European Commission	NB	EU MRA	NB 2280
Australia	Australian Communications and Media Authority (ACMA)	CAB	APEC MRA 1	US0159
Hong Kong	Office of the Telecommunication Authority (OFTA)	CAB	APEC MRA 1	
Korea	Ministry of Information and Communication Radio Research Laboratory (RRL)	CAB	APEC MRA 1	
Singapore	Infocomm Development Authority (IDA)	CAB	APEC MRA 1	
Taiwan	National Communications Commission (NCC) Bureau of Standards, Metrology and Inspection (BSMI)	CAB	APEC MRA 1	
Vietnam	Ministry of Communication (MIC)	CAB	APEC MRA 1	

\*\*APEC MRA – Asia Pacific Economic Community Mutual Recognition Agreement.

Is a recognition agreement under which test lab is accredited to regulatory standards of the APEC member countries.

Phase I - recognition for product testing

Phase II – recognition for both product testing and certification

N/A – Not Applicable

\*\*EU MRA – European Union Mutual Recognition Agreement.

Is a recognition agreement under which test lab is accredited to regulatory standards of the EU member countries.

\*\*NB – Notified Body

This test report may be reproduced in full only. The document may only be updated by MiCOM Labs personnel. Any changes will be noted in the Document History section of the report.

## **PRODUCT CERTIFICATION**

MiCOM Labs, Inc. is an accredited Product Certification Body per the international standard EN ISO/IEC Guide 65. The company is accredited by the American Association for Laboratory Accreditation (A2LA) [www.a2la.org](http://www.a2la.org) test laboratory number 2381.02. MiCOM Labs test schedule is available at the following URL; <http://www.a2la.org/scopepdf/2381-02.pdf>



The American Association for Laboratory Accreditation

"World Class Accreditation"

### *Accredited Product Certification Body*

A2LA has accredited

**MICOM LABS**

*Pleasanton, CA*

for technical competence as a

**Product Certification Body**

This product certification body is accredited in accordance with the recognized International Standard ISO/IEC Guide 65:1996 *General requirements for bodies operating product certification systems*. This accreditation demonstrates technical competence for a defined scope and the operation of a quality management system.

Presented this 27<sup>th</sup> day of March 2012.



President & CEO  
For the Accreditation Council  
Certificate Number 2381.02  
Valid to November 30, 2013

*For the product certification schemes to which this accreditation applies, please refer to the organization's Product Certification Scope of Accreditation*

### **United States of America – Telecommunication Certification Body (TCB)**

TCB Identifier – US0159

### **Industry Canada – Certification Body**

CAB Identifier – US0159

### **Europe – Notified Body**

Notified Body Identifier - 2280

### **Japan – Recognized Certification Body (RCB)**

RCB Identifier - 210

This test report may be reproduced in full only. The document may only be updated by MiCOM Labs personnel. Any changes will be noted in the Document History section of the report.



**Title:** Ear Force i60 TX Wireless Audio Transmitter  
**To:** FCC 47 CFR Part 15.247 & IC RSS-210  
**Serial #:** COMM38-U3 Rev A  
**Issue Date:** 30th September 2013  
**Page:** 8 of 53

---

## DOCUMENT HISTORY

Document History		
Revision	Date	Comments
Draft		
Rev A	30 <sup>th</sup> September 2013	Initial release.

---

This test report may be reproduced in full only. The document may only be updated by MiCOM Labs personnel. Any changes will be noted in the Document History section of the report.





**Title:** Ear Force i60 TX Wireless Audio Transmitter  
**To:** FCC 47 CFR Part 15.247 & IC RSS-210  
**Serial #:** COMM38-U3 Rev A  
**Issue Date:** 30th September 2013  
**Page:** 9 of 53

## 1. TEST RESULT SUMMARY

Manufacturer:	Voyetra Turtle Beach Inc 100 Summit Lake Drive, Suite 100 Valhalla New York, 10595, USA	Tested By:	MiCOM Labs, Inc. 440 Boulder Court Suite 200 Pleasanton California, 94566, USA
EUT:	Wireless Audio Transmitter	Telephone:	+1 925 462 0304
Model:	Ear Force i60 TX (TB300-7021-01)	Fax:	+1 925 462 0306
S/N's:	N/A		
Test Date(s):	20th to 29th August '13	Website:	www.micomlabs.com

STANDARD(S)	TEST RESULTS
FCC 47 CFR Part 15.247 & IC RSS-210	EQUIPMENT COMPLIES

MiCOM Labs, Inc. tested the equipment mentioned in accordance with the requirements set forth in the above standards. Test results indicate that the equipment tested is capable of demonstrating compliance with the requirements as documented within this report.

### Notes:

1. This document reports conditions under which testing was conducted and the results of testing performed.
2. Details of test methods used have been recorded and kept on file by the laboratory.
3. Test results apply only to the item(s) tested.

Approved & Released for MiCOM Labs, Inc. by:



TEST CERTIFICATE #2381.01

  
\_\_\_\_\_  
Graeme Grieve  
Quality Manager MiCOM Labs,

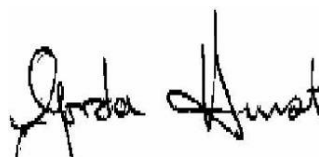
  
\_\_\_\_\_  
Gordon Hurst  
President & CEO MiCOM Labs, Inc.

This test report may be reproduced in full only. The document may only be updated by MiCOM Labs personnel. Any changes will be noted in the Document History section of the report.



**Title:** Ear Force i60 TX Wireless Audio Transmitter  
**To:** FCC 47 CFR Part 15.247 & IC RSS-210  
**Serial #:** COMM38-U3 Rev A  
**Issue Date:** 30th September 2013  
**Page:** 10 of 53

## **COMPLIANCE STATEMENT**

Applicant:	Voyetra Turtle Beach Inc 100 Summit Lake Drive, Suite 100 Valhalla, New York, 10595, USA	Tested By:	MiCOM Labs, Inc. 440 Boulder Court Suite 200 Pleasanton California, 94566 USA
Product:	Wireless Audio Transmitter	Telephone: Fax:	+1 925 462 0304 +1 925 462 0306
Model No.:	Ear Force i60 TX (TB300-7021-01)	Website:	www.micomlabs.com

### **STANDARD(S)**

FCC 47 CFR Part 15.247 & IC RSS-210

MiCOM Labs attests that the above noted models meet the requirements set forth in the above standard(s) based on testing of samples as noted in the Test Result Summary and the manufacturer's declaration of similarity.

Test results indicate that the equipment tested is capable of demonstrating compliance with the requirements as documented within this report.

#### **Notes:**

1. The different model numbers identified are declared as being electrically identical by the manufacturer.
2. The manufacturer declared that the only difference between the models is cosmetic; the different models are marketed under separate brands.

This test report may be reproduced in full only. The document may only be updated by MiCOM Labs personnel. Any changes will be noted in the Document History section of the report.

## 2. REFERENCES AND MEASUREMENT UNCERTAINTY

### 2.1. Normative References

REF.	PUBLICATION	YEAR	TITLE
i.	FCC 47 CFR Part 15, Subpart C	2013	Title 47: Telecommunication PART 15—RADIO FREQUENCY DEVICES Subpart C—Intentional Radiators
ii.	RSS-210 Annex 8	2010	Radio Standards Specification 210, Issue 8, Low-power Licence-exempt Radiocommunication Devices (All Frequency Bands): Category I Equipment
iii.	FCC OET KDB 662911	4 <sup>th</sup> April 2011	Emissions Testing of Transmitters with Multiple Outputs in the Same Band
iv.	DA 00-705	2000	FCC DA 00-705 "Filing and Measurement Guidelines for Frequency Hopping Spread Spectrum Systems" released March 30, 2000
v.	RSS-GEN	2010	Radio Standards Specification-Gen, Issue 3, General Requirements and Information for the Certification of Radiocommunication Equipment
vi.	FCC 47 CFR Pt 15, Subpart B	2012	47 CFR Part 15, SubPart B; Unintentional Radiators
vii.	ICES-003	2004	Spectrum Management and Telecommunications Policy Interference-Causing Equipment Standard Digital Apparatus; Issue 4
viii.	ANSI C63.4	2009	American National Standards for Methods of Measurement of Radio-Noise Emissions from Low-Voltage Electrical and Electronic Equipment in the Range of 9 kHz to 40 GHz
ix.	CISPR 22/ EN 55022	2008 2006+A1:2007	Limits and Methods of Measurements of Radio Disturbance Characteristics of Information Technology Equipment
x.	M 3003	Edition 1 Dec. 1997	Expression of Uncertainty and Confidence in Measurements
xi.	LAB34	Edition 1 Aug 2002	The expression of uncertainty in EMC Testing
xii.	ETSI TR 100 028	2001	Parts 1 and 2 Electromagnetic compatibility and Radio Spectrum Matters (ERM); Uncertainties in the measurement of mobile radio equipment characteristics
xiii.	A2LA	July 2012	Reference to A2LA Accreditation Status – A2LA Advertising Policy

This test report may be reproduced in full only. The document may only be updated by MiCOM Labs personnel. Any changes will be noted in the Document History section of the report.



**Title:** Ear Force i60 TX Wireless Audio Transmitter  
**To:** FCC 47 CFR Part 15.247 & IC RSS-210  
**Serial #:** COMM38-U3 Rev A  
**Issue Date:** 30th September 2013  
**Page:** 12 of 53

---

## **2.2. Test and Uncertainty Procedures**

Conducted and radiated emission measurements were conducted in accordance with American National Standards Institute ANSI C63.4, listed in the Normative References section of this report.

Measurement uncertainty figures are calculated in accordance with ETSI TR 100 028 Parts 1 and 2.

Measurement uncertainties stated are based on a standard uncertainty multiplied by a coverage factor  $k = 2$ , providing a level of confidence of approximately 95 % in accordance with UKAS document M 3003 listed in the Normative References section of this report.

---

This test report may be reproduced in full only. The document may only be updated by MiCOM Labs personnel. Any changes will be noted in the Document History section of the report.



**Title:** Ear Force i60 TX Wireless Audio Transmitter  
**To:** FCC 47 CFR Part 15.247 & IC RSS-210  
**Serial #:** COMM38-U3 Rev A  
**Issue Date:** 30th September 2013  
**Page:** 13 of 53

### 3. PRODUCT DETAILS AND TEST CONFIGURATIONS

#### 3.1. Technical Details

Details	Description
Purpose:	Test of the Ear Force i60 TX Wireless Audio Transmitter to FCC Part 15.247 and Industry Canada RSS-210 regulations.
Applicant:	Voyetra Turtle Beach Inc 100 Summit Lake Drive, Suite 100 Valhalla New York, 10595, USA
Manufacturer:	As applicant.
Laboratory performing the tests:	MiCOM Labs, Inc. 440 Boulder Court, Suite 200 Pleasanton, California 94566 USA
Test report reference number:	COMM38-U3 Rev A
Date EUT received:	19 <sup>th</sup> August 2013
Standard(s) applied:	FCC 47 CFR Part 15.247 & IC RSS-210
Dates of test (from - to):	20th to 29th August '13
No of Units Tested:	Two
Type of Equipment:	Wireless Audio Transmitter
Manufacturers Trade Name:	Ear Force
Model(s):	Ear Force i60 TX (TB300-7021-01)
Location for use:	Indoor
Declared Frequency Range(s):	2400 - 2483.5 MHz;
Hardware Rev	PP
Software Rev	N/A
Type of Modulation:	Per 802.11 – OFDM
Declared Nominal Tx Power:	802.11g;Leg. +11.08 dBm
EUT Modes of Operation:	Legacy 802.11 g
Transmit/Receive Operation:	Time Division Duplex
System Beam Forming:	EUT has no capability for antenna beam forming
Rated Input Voltage and Current:	5V (USB)
Operating Temperature Range:	Declared range 0° to +50°C at 95% humidity non condensing
ITU Emission Designator:	2400 – 2483.5 MHz 802.11 g                      17M5D1D
Equipment Dimensions:	4.5 x 4.5 x 1 inches
Weight:	4 oz
Primary function of equipment:	Wireless Audio Transmitter

This test report may be reproduced in full only. The document may only be updated by MiCOM Labs personnel. Any changes will be noted in the Document History section of the report.

### 3.2. Scope of Test Program

#### Ear Force i60 TX Wireless Audio Transmitter RF Testing

The scope of the test program was to test the Ear Force i60 TX Wireless Audio Transmitter (TB300-7021-01), in the frequency range 2400 - 2483.5 MHz for compliance against FCC 47 CFR Part 15.247 and Industry Canada RSS-210 specifications.

#### Ear Force i60 TX Wireless Audio Transmitter



---

This test report may be reproduced in full only. The document may only be updated by MiCOM Labs personnel. Any changes will be noted in the Document History section of the report.



**Title:** Ear Force i60 TX Wireless Audio Transmitter  
**To:** FCC 47 CFR Part 15.247 & IC RSS-210  
**Serial #:** COMM38-U3 Rev A  
**Issue Date:** 30th September 2013  
**Page:** 15 of 53

---

### 3.3. Equipment Model(s) and Serial Number(s)

Equipment Type	Equipment Description (Including Brand Name)	Mfr	Model No.	Serial No.
EUT	Wireless Audio Transmitter	Voyetra Turtle Beach	Ear Force i60 TX	N/A
Support	Laptop PC	Apple	MacBook Air	None

### 3.4. Antenna Details

Antenna Type	Manufacturer	Model Number	Antenna Gain (dBi)	
			2.4 GHz	5 GHz
Integral Folded F (Bluetooth)	Turtle Beach	PCB	2.8	--
Chip (Wi-Fi)	Fractus	FR05-S1-NO-1-004	-1.5	--
Chip (Wi-Fi)	Fractus	FR05-S1-NO-1-004	--	3.3

### 3.5. Cabling and I/O Ports

Number and type of I/O ports

1. 1 x USB (power only)

---

This test report may be reproduced in full only. The document may only be updated by MiCOM Labs personnel. Any changes will be noted in the Document History section of the report.



**Title:** Ear Force i60 TX Wireless Audio Transmitter  
**To:** FCC 47 CFR Part 15.247 & IC RSS-210  
**Serial #:** COMM38-U3 Rev A  
**Issue Date:** 30th September 2013  
**Page:** 16 of 53

---

### 3.6. Test Configurations

Testing was performed to determine the highest power level versus bit rate. The variant with the highest power was used to exercise the product.

Operational Mode(s) (802.11)	Variant	Data Rate with Highest Power	Frequencies (MHz)
g	Legacy	6 MBit/s	2,462

Legacy – data rates for 802.11g products

Results for the above configurations are provided in this report.

---

This test report may be reproduced in full only. The document may only be updated by MiCOM Labs personnel. Any changes will be noted in the Document History section of the report.





**Title:** Ear Force i60 TX Wireless Audio Transmitter  
**To:** FCC 47 CFR Part 15.247 & IC RSS-210  
**Serial #:** COMM38-U3 Rev A  
**Issue Date:** 30th September 2013  
**Page:** 17 of 53

---

### Antenna Test Configurations for Radiated Emissions

Results for the following configurations are provided in this report.

Modes with the highest spectral density will have the highest spurious emissions, only those modes were tested for this test program.

2,400 – 2,483.5 MHz

---

15.247	
802.11g	g SE 2462
	BE g 2390
	BE g 2483.5

KEY;-

SE – Spurious Emission  
BE – Band-Edge

---

This test report may be reproduced in full only. The document may only be updated by MiCOM Labs personnel. Any changes will be noted in the Document History section of the report.



**Title:** Ear Force i60 TX Wireless Audio Transmitter  
**To:** FCC 47 CFR Part 15.247 & IC RSS-210  
**Serial #:** COMM38-U3 Rev A  
**Issue Date:** 30th September 2013  
**Page:** 18 of 53

---

### **3.7. Equipment Modifications**

The following modifications were required to bring the equipment into compliance:

1. Band-Edge and Radiated Spurious Power Reduction

All conducted spurious emission testing was performed with the device set for maximum power at all times.

### **3.8. Deviations from the Test Standard**

The following deviations from the test standard were required in order to complete the test program:

1. NONE

---

This test report may be reproduced in full only. The document may only be updated by MiCOM Labs personnel. Any changes will be noted in the Document History section of the report.

## 4. TEST EQUIPMENT CONFIGURATION(S)

### 4.1. Conducted RF Emission Test Set-up

The following tests were performed using the conducted test set-up shown in the diagram below.

1. Section 6.1.1.1. 6 dB and 99% Bandwidth
2. Section 6.1.1.2. Peak Output Power
3. Section 6.1.1.3. Power Spectral Density
4. Section 6.1.1.4. Conducted Spurious Emissions

#### Conducted Test Set-Up Pictorial Representation

##### Test Measurement set up

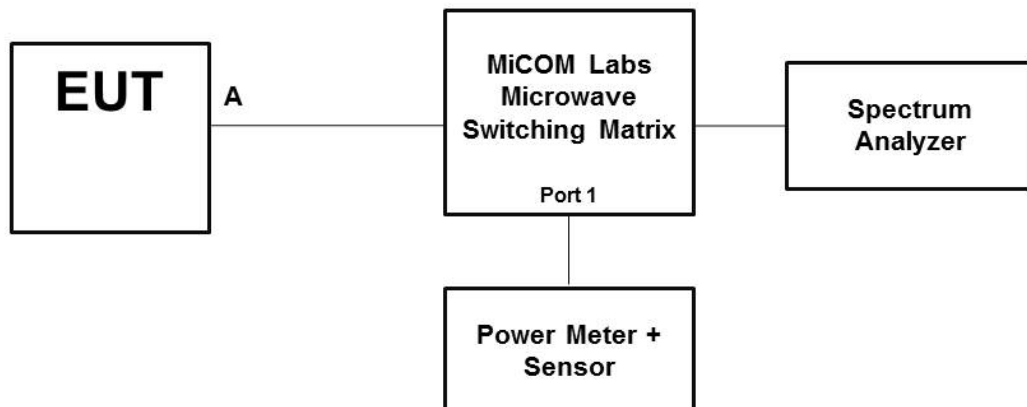

**Conducted Test Measurement Setup**

#### 4.2. Radiated Spurious Emission Test Set-up > 1 GHz

The following tests were performed using the conducted test set-up shown in the diagram below.

##### Radiated Emission Measurement Setup – Above 1 GHz

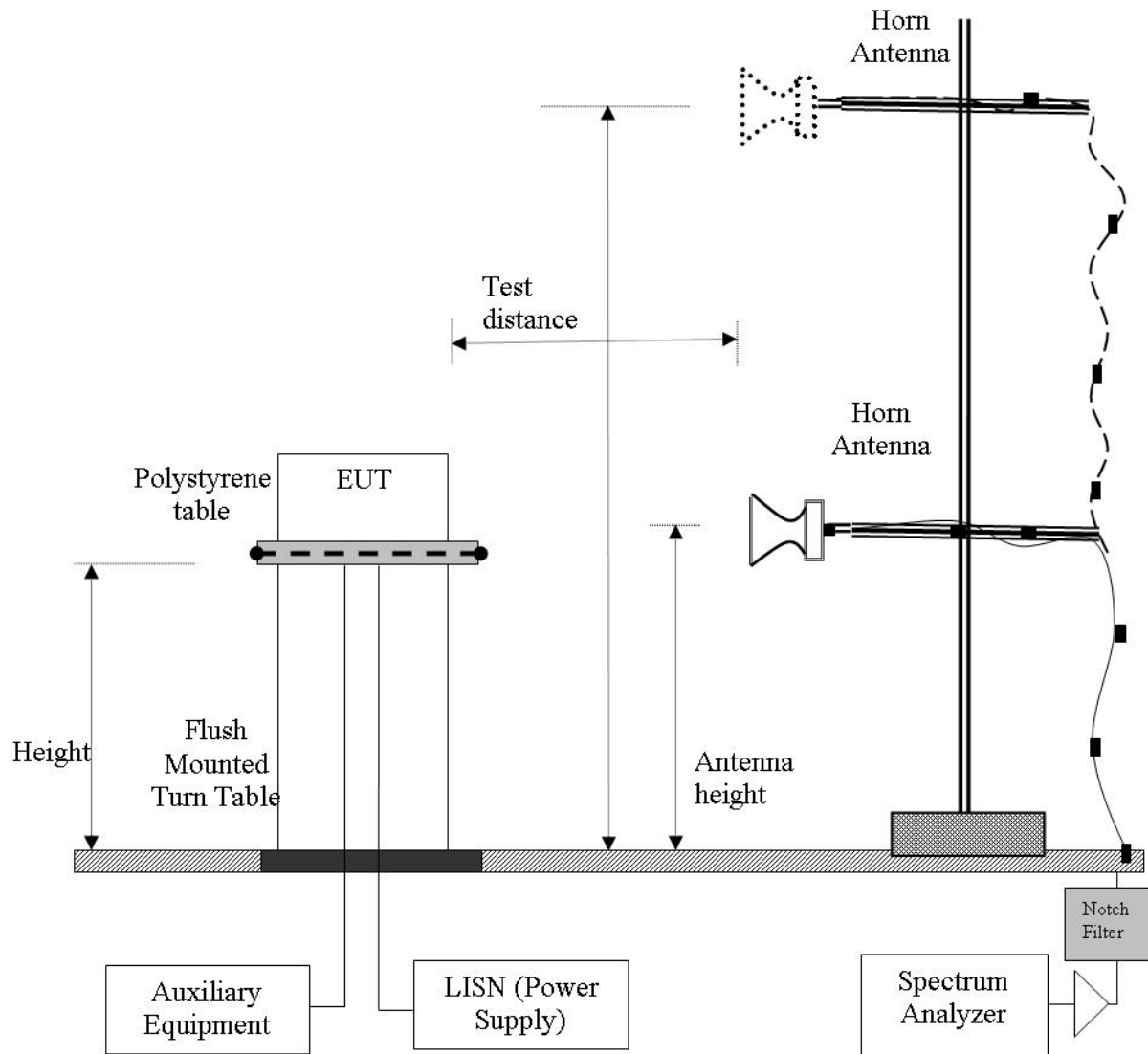

This test report may be reproduced in full only. The document may only be updated by MiCOM Labs personnel. Any changes will be noted in the Document History section of the report.

#### 4.3. Digital Emissions Test Set-up (0.03 – 1 GHz)

The following tests were performed using the conducted test set-up shown in the diagram below.

##### Digital Emission Measurement Setup – Below 1 GHz

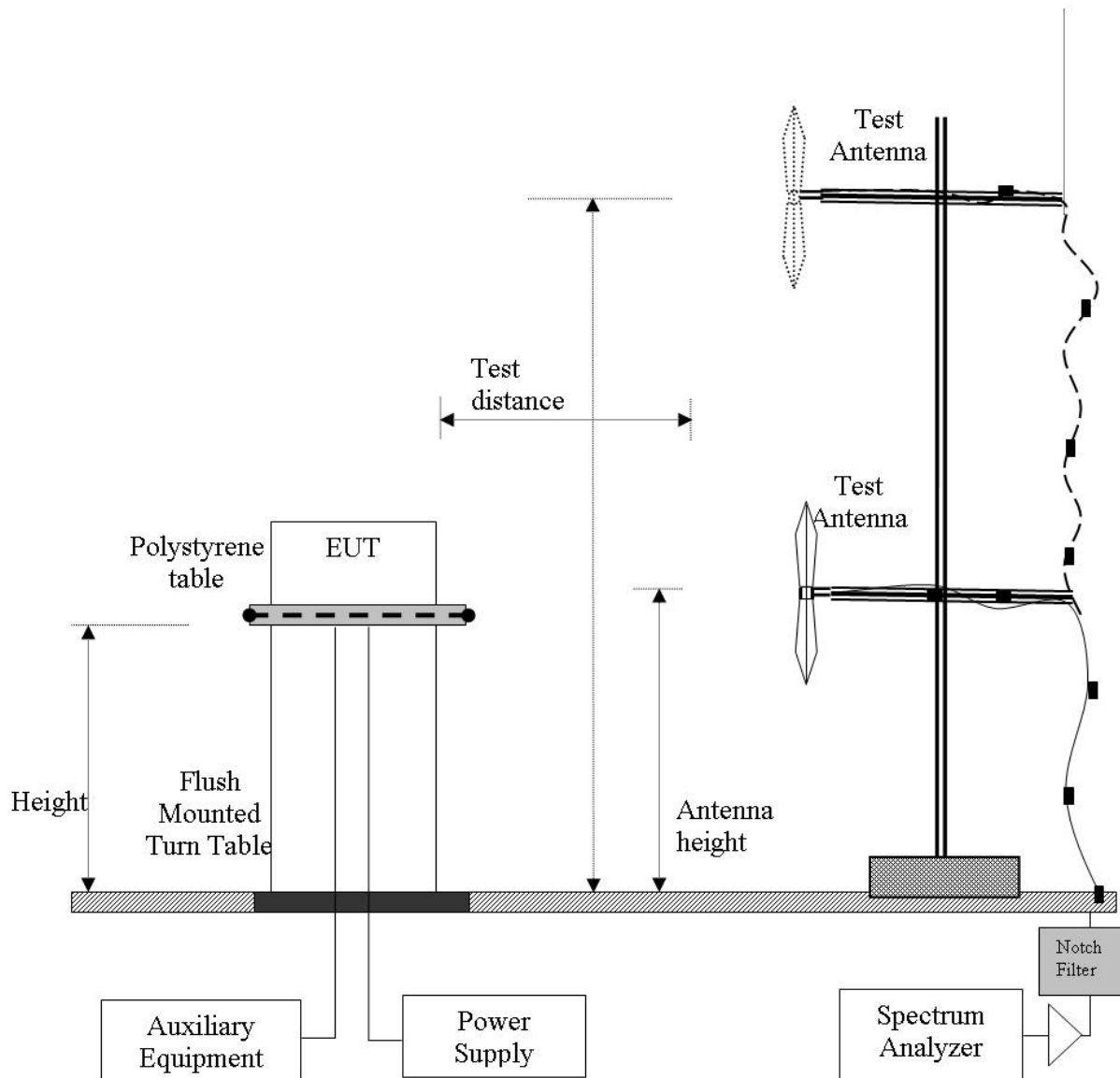

This test report may be reproduced in full only. The document may only be updated by MiCOM Labs personnel. Any changes will be noted in the Document History section of the report.

#### 4.4. ac Wireline Emission Test Set-up

The following tests were performed using the conducted test set-up shown in the diagram below.

Not Required EUT not powered by AC.

1. Section 6.1.3 ac Wireline Conducted Emissions

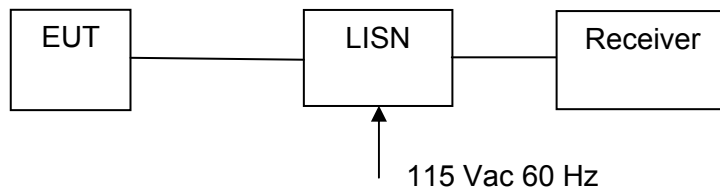

**Measurement Setup for Conducted Emissions Test**



**Title:** Ear Force i60 TX Wireless Audio Transmitter  
**To:** FCC 47 CFR Part 15.247 & IC RSS-210  
**Serial #:** COMM38-U3 Rev A  
**Issue Date:** 30th September 2013  
**Page:** 23 of 53

## 5. TEST SUMMARY

### List of Measurements

The following table represents the list of measurements required under the **FCC CFR47 Part 15.247** and **Industry Canada RSS-210** and **Industry Canada RSS-Gen.**

Section(s)	Test Items	Description	Condition	Result	Test Report Section
15.247(a)(2) A8.2(1) 4.4	6 dB and 99 % Bandwidths	≥500 kHz	Conducted	Complies	6.1.1.1
15.247(b)(3) 15.31(e) A8.4(4)	Peak Output Power  Voltage Variation	Shall not exceed 1W  Variation of supply voltage 85 % -115 %	Conducted	Complies	6.1.1.2
15.247(e) A8.2	Peak Power Spectral Density	Shall not be greater than +8 dBm in any 3 kHz band	Conducted	Complies	6.1.1.3
15.247(d) 15.205 / 15.209 A8.5 2.2 4.7	Spurious Emissions  (30MHz - 26 GHz b/g and 30 MHz – 40 GHz a)	The radiated emission in any 100 kHz of out- band shall be at least 20 dB below the highest in- band spectral density	Conducted	Complies	6.1.1.4

This test report may be reproduced in full only. The document may only be updated by MiCOM Labs personnel. Any changes will be noted in the Document History section of the report.



**Title:** Ear Force i60 TX Wireless Audio Transmitter  
**To:** FCC 47 CFR Part 15.247 & IC RSS-210  
**Serial #:** COMM38-U3 Rev A  
**Issue Date:** 30th September 2013  
**Page:** 24 of 53

### List of Measurements (continued)

The following table represents the list of measurements required under the **FCC CFR47 Part 15.247**, **Industry Canada RSS-210**, and **Industry Canada RSS-Gen**.

Section(s)	Test Items	Description	Condition	Result	Test Report Section
15.247(d) 15.205 / 15.209 A8.5 2.2 2.6 4.7	Radiated Emissions	Restricted Bands	Radiated	Complies	6.1.2.
	Transmitter Radiated Spurious Emissions	Emissions above 1 GHz		Complies	
	Radiated Band Edge	Band-edge results Peak Emissions		Complies	
15.205 / 15.209 2.2	Radiated Spurious Emissions	Emissions <1 GHz (30M-1 GHz)	Radiated	Complies	6.1.2.1
15.207 7.2.2	AC Wireline Conducted Emissions 150 kHz– 30 MHz	Conducted Emissions	Conducted	N/A EUT is DC powered	6.1.3

**Note 1:** Test results reported in this document relate only to the items tested

**Note 2:** The required tests demonstrated compliance as per client declaration of test configuration, monitoring methodology and associated pass/fail criteria

**Note 3:** Section 3.7 Equipment Modifications highlights the equipment modifications that were required to bring the product into compliance with the above test matrix

This test report may be reproduced in full only. The document may only be updated by MiCOM Labs personnel. Any changes will be noted in the Document History section of the report.





**Title:** Ear Force i60 TX Wireless Audio Transmitter  
**To:** FCC 47 CFR Part 15.247 & IC RSS-210  
**Serial #:** COMM38-U3 Rev A  
**Issue Date:** 30th September 2013  
**Page:** 25 of 53

## 6. TEST RESULTS

### 6.1. Device Characteristics

#### 6.1.1. Conducted Testing

##### 6.1.1.1. 6 dB and 99 % Bandwidth

Conducted Test Conditions for 6 dB and 99% Bandwidth			
<b>Standard:</b>	FCC CFR 47:15.247	<b>Ambient Temp. (°C):</b>	24.0 - 27.5
<b>Test Heading:</b>	6 dB and 99 % Bandwidth	<b>Rel. Humidity (%):</b>	32 - 45
<b>Standard Section(s):</b>	15.247 (a)(2)	<b>Pressure (mBars):</b>	999 - 1001
<b>Reference Document(s):</b>	KDB 558074 - D01 DTS Measurement Guidance v01: Section 5.1 Emission Bandwidth		
<b>Test Procedure for 6 dB and 99% Bandwidth Measurement</b> The bandwidth at 6 dB and 99 % was measured with a spectrum analyzer connected to the antenna terminal, while EUT is operating in transmission mode at the appropriate centre frequency.			

Equipment Configuration for 6 dB & 99% Bandwidth			
<b>Variant:</b>	802.11g	<b>Duty Cycle (%):</b>	100
<b>Data Rate:</b>	6 Mbit/s	<b>Antenna Gain (dBi):</b>	Not Applicable
<b>Modulation:</b>	OFDM	<b>Beam Forming Gain (Y):</b>	Not Applicable
<b>TPC:</b>	Not Applicable	<b>Tested By:</b>	JMH
<b>Engineering Test Notes:</b>			

#### Test Measurement Results

Test Frequency	Measured 6 dB Bandwidth (MHz)				6 dB Bandwidth (MHz)		Limit	Lowest Margin
	Port(s)				Highest	Lowest		
MHz	a	b	c	d			KHz	MHz
2462.0	16.754				16.754	16.754	≥500.0	-16.25

Test Frequency	Measured 99% Bandwidth (MHz)				Maximum 99% Bandwidth (MHz)		
	Port(s)						
MHz	a	b	c	d			
2462.0	18.517				18.517		

Traceability to Industry Recognized Test Methodologies	
Work Instruction:	WI-03 MEASURING RF SPECTRUM MASK
Measurement Uncertainty:	±2.81 dB

Note: click the link in the above results matrix to view the plot

This test report may be reproduced in full only. The document may only be updated by MiCOM Labs personnel. Any changes will be noted in the Document History section of the report.



**Title:** Ear Force i60 TX Wireless Audio Transmitter  
**To:** FCC 47 CFR Part 15.247 & IC RSS-210  
**Serial #:** COMM38-U3 Rev A  
**Issue Date:** 30th September 2013  
**Page:** 26 of 53

---

## Specification

### Limits

#### **§15.247 (a)(2) & RSS-210 §A8.2(a)**

The minimum 6 dB bandwidth shall be at least 500 kHz.

## Traceability

### Test Equipment Used

0158, 0287, 0252, 0313, 0314, 0070, 0116, 0117

---

This test report may be reproduced in full only. The document may only be updated by MiCOM Labs personnel. Any changes will be noted in the Document History section of the report.



**Title:** Ear Force i60 TX Wireless Audio Transmitter  
**To:** FCC 47 CFR Part 15.247 & IC RSS-210  
**Serial #:** COMM38-U3 Rev A  
**Issue Date:** 30th September 2013  
**Page:** 27 of 53

### 6.1.1.2. Peak Output Power

Conducted Test Conditions for Fundamental Emission Output Power			
<b>Standard:</b>	FCC CFR 47:15.247	<b>Ambient Temp. (°C):</b>	24.0 - 27.5
<b>Test Heading:</b>	Emission Output Power	<b>Rel. Humidity (%):</b>	32 - 45
<b>Standard Section(s):</b>	15.247 (a)(2)	<b>Pressure (mBars):</b>	999 - 1004
<b>Reference Document(s):</b>	KDB 558074 - D01 DTS Measurement Guidance v01: Section 5.2 Fundamental Emission Output Power  KDB 662911 was implemented for In-band power measurements. The measure and sum technique was implemented in all cases.		

#### Test Procedure for Fundamental Emission Output Power Measurement

The transmitter terminal of EUT was connected to the input of the spectrum analyzer set to measure peak power. The resolution filter bandwidth was set to 6 dB, peak detector selected and the analyzer built-in power function was used to integrate peak power over the 20 dB bandwidth.

#### Supporting Information

Calculated Power = A + G + 10 log (1/x) dBm

A = Total Power [10 Log10 (10<sup>a/10</sup> + 10<sup>b/10</sup> + 10<sup>c/10</sup> + 10<sup>d/10</sup>)], G = Antenna Gain,  
 x = Duty Cycle

#### Equipment Configuration for Peak Output Power

<b>Variant:</b>	802.11g	<b>Duty Cycle (%):</b>	100
<b>Data Rate:</b>	6 Mbit/s	<b>Antenna Gain (dBi):</b>	-1.50
<b>Modulation:</b>	OFDM	<b>Beam Forming Gain (Y):</b>	Not Applicable
<b>TPC:</b>	Not Applicable	<b>Tested By:</b>	JMH
<b>Engineering Test Notes:</b>			

#### Test Measurement Results

Test Frequency	Measured Output Power (dBm)				Limit	Margin	EUT Power Setting	
	Port(s)							
MHz	a	b	c	d	dBm	dBm	dBm	
2462.0	<a href="#">11.08</a>				11.08	30.00	-18.92	SPW 1

#### Traceability to Industry Recognized Test Methodologies

Work Instruction:	WI-01 MEASURING RF OUTPUT POWER
Measurement Uncertainty:	±1.33 dB

Note: [click the link in the above results matrix to view the plot](#)

This test report may be reproduced in full only. The document may only be updated by MiCOM Labs personnel. Any changes will be noted in the Document History section of the report.



**Title:** Ear Force i60 TX Wireless Audio Transmitter  
**To:** FCC 47 CFR Part 15.247 & IC RSS-210  
**Serial #:** COMM38-U3 Rev A  
**Issue Date:** 30th September 2013  
**Page:** 28 of 53

## Specification

### Limits

**§15.247 (b)** The maximum peak output power of the intentional radiator shall not exceed the following:

**§15.247 (b) (3)** For systems using digital modulation in the 902-928 MHz, 2400-2483.5 MHz and 5725-5850 MHz bands: 1.0 watt.

**15.247 (b) (4)** The conducted output power limit specified in paragraph (b) of this section is based on the use of antennas with directional gains that do not exceed 6 dBi. Except as shown in paragraph (c) of this section, if transmitting antennas of directional gain greater than 6 dBi are used, the conducted output power from the intentional radiator shall be reduced below the stated values in paragraphs (b)(1), (b)(2), and (b)(3) of this section, as appropriate, by the amount in dB that the directional gain of the antenna exceeds 6 dBi.

15.247 (c) Operation with directional antenna gains greater than 6 dBi.

(1) Fixed point-to-point operation:

(i) Systems operating in the 2400–2483.5 MHz band that are used exclusively for fixed, point-to-point operations may employ transmitting antennas with directional gain greater than 6 dBi provided the maximum conducted output power of the intentional radiator is reduced by 1 dB for every 3 dB that the directional gain of the antenna exceeds 6 dBi.

(ii) Systems operating in the 5725–5850 MHz band that are used exclusively for fixed, point-to-point operations may employ transmitting antennas with directional gain greater than 6 dBi without any corresponding reduction in transmitter conducted output power.

**§15.31 (e)** For intentional radiators, measurements of the variation of the input power or the radiated signal level of the fundamental frequency component of the emission, as appropriate, shall be performed with the supply voltage varied between 85% and 115% of the nominal rated supply voltage. For battery operated equipment, the equipment tests shall be performed using a new battery.

**§ RSS-210 A8.4(4)** For systems employing digital modulation techniques operating in the 902-928 MHz, 2400-2483.5 MHz and 5725-5850 MHz bands the maximum peak conducted power shall not exceed 1 watt.

### Traceability

Method	Test Equipment Used
Measurements were made per work instruction WI-01 'Measuring RF Output Power'	0158, 0287, 0252, 0313, 0314, 0070, 0116, 0117

This test report may be reproduced in full only. The document may only be updated by MiCOM Labs personnel. Any changes will be noted in the Document History section of the report.



**Title:** Ear Force i60 TX Wireless Audio Transmitter  
**To:** FCC 47 CFR Part 15.247 & IC RSS-210  
**Serial #:** COMM38-U3 Rev A  
**Issue Date:** 30th September 2013  
**Page:** 29 of 53

### 6.1.1.3. Power Spectral Density

Conducted Test Conditions for Power Spectral Density			
<b>Standard:</b>	FCC CFR 47:15.247	<b>Ambient Temp. (°C):</b>	24.0 - 27.5
<b>Test Heading:</b>	Power Spectral Density	<b>Rel. Humidity (%):</b>	32 - 45
<b>Standard Section(s):</b>	15.247 (e)	<b>Pressure (mBars):</b>	999 - 1001
<b>Reference Document(s):</b>	KDB 558074 - D01 DTS Measurement Guidance v01: Section 5.3 Maximum Power Spectral Density Level in the Emission Bandwidth		
<b>Test Procedure for Power Spectral Density</b>			
<p>The transmitter output was connected to a spectrum analyzer and the maximum level in a 3 kHz bandwidth was measured. A peak value was found over the full emission bandwidth and the frequency span reduced to obtain enhanced resolution. Sweep time <math>\geq</math> span / 3 kHz with video averaging turned off. The Peak Power Spectral Density is the highest level found across the emission in a 3 kHz resolution bandwidth.</p>			
<b>Supporting Information</b>			
<p>Calculated Power = <math>A + 10 \log (1/x)</math> dBm  <math>A = \text{Total Power Spectral Density } [10 \text{ Log}_{10} (10^{a/10} + 10^{b/10} + 10^{c/10} + 10^{d/10})]</math>  <math>x = \text{Duty Cycle}</math></p>			
<p>Limit Line: KDB 662911 was implemented for In-band power spectral density (PSD) measurements - Option (2) measure and subtract 10 log (N) dB from the limit for devices with multiple RF ports</p>			

Equipment Configuration for Power Spectral Density - Peak			
<b>Variant:</b>	802.11g	<b>Duty Cycle (%):</b>	100
<b>Data Rate:</b>	6 Mbit/s	<b>Antenna Gain (dBi):</b>	Not Applicable
<b>Modulation:</b>	OFDM	<b>Beam Forming Gain (Y):</b>	Not Applicable
<b>TPC:</b>	Not Applicable	<b>Tested By:</b>	JMH
<b>Engineering Test Notes:</b>			

#### Test Measurement Results

Test Frequency	Measured Power Spectral Density (dBm)				Calculated Total Power Spectral Density		Limit	Margin
	Port(s)				dBm			
MHz	a	b	c	d		Conversion to 3 kHz RBW	dBm	dB
2462.0	-13.434				-13.434	-23.434	8.00	-31.43

Traceability to Industry Recognized Test Methodologies	
Work Instruction:	WI-03 MEASURING RF SPECTRUM MASK
Measurement Uncertainty:	$\pm 1.33$ dB

Note: [click the link in the above results matrix to view the plot](#)

This test report may be reproduced in full only. The document may only be updated by MiCOM Labs personnel. Any changes will be noted in the Document History section of the report.



**Title:** Ear Force i60 TX Wireless Audio Transmitter  
**To:** FCC 47 CFR Part 15.247 & IC RSS-210  
**Serial #:** COMM38-U3 Rev A  
**Issue Date:** 30th September 2013  
**Page:** 30 of 53

---

**Specification**  
**Peak Power Spectral Density Limits**

**§15.247(e)** For digitally modulated systems, the power spectral density conducted from the intentional radiator to the antenna shall not be greater than +8 dBm in any 3 kHz band during any time interval of continuous transmission

**RSS-210 §A8.2(2)** The transmitter power spectral density (into the antenna) shall not be greater than +8 dBm in any 3 kHz band during any time interval of continuous transmission or over 1.0 second if the transmission exceeds 1.0 second duration.

**Traceability**

Method	Test Equipment Used
Measurements were made per work instruction WI-01 'Measuring RF Output Power'	0158, 0287, 0252, 0313, 0314, 0070, 0116, 0117

---

This test report may be reproduced in full only. The document may only be updated by MiCOM Labs personnel. Any changes will be noted in the Document History section of the report.



**Title:** Ear Force i60 TX Wireless Audio Transmitter  
**To:** FCC 47 CFR Part 15.247 & IC RSS-210  
**Serial #:** COMM38-U3 Rev A  
**Issue Date:** 30th September 2013  
**Page:** 31 of 53

---

#### 6.1.1.4. Conducted Spurious Emissions

<b>Conducted Test Conditions for Transmitter Conducted Spurious and Band-Edge Emissions</b>			
<b>Standard:</b>	FCC CFR 47:15.247	<b>Ambient Temp. (°C):</b>	24.0 - 27.5
<b>Test Heading:</b>	Max Unwanted Emission Levels	<b>Rel. Humidity (%):</b>	32 - 45
<b>Standard Section(s):</b>	15.247 (d)	<b>Pressure (mBars):</b>	999 - 1001
<b>Reference Document(s):</b>	KDB 558074 - D01 DTS Measurement Guidance v01: Section 5.4 Maximum Unwanted Emission Levels		

**Test Procedure for Transmitter Conducted Spurious and Band-Edge Emissions Measurement**  
Transmitter Conducted Spurious and Band-Edge emissions were measured at a limit of 20 dB below the highest in-band spectral density measured with a spectrum analyzer connected to the antenna terminal. Measurements were made while EUT was operating in transmit mode of operation at the appropriate centre frequency closest to the band-edge. Emissions were maximized during the measurement and limits derived from the peak spectral power and drawn on each plot.

---

This test report may be reproduced in full only. The document may only be updated by MiCOM Labs personnel. Any changes will be noted in the Document History section of the report.



**Title:** Ear Force i60 TX Wireless Audio Transmitter  
**To:** FCC 47 CFR Part 15.247 & IC RSS-210  
**Serial #:** COMM38-U3 Rev A  
**Issue Date:** 30th September 2013  
**Page:** 32 of 53

**Equipment Configuration for Transmitter Conducted Spurious Emissions**

<b>Variant:</b>	802.11g	<b>Duty Cycle (%):</b>	100
<b>Data Rate:</b>	6 Mbit/s	<b>Antenna Gain (dBi):</b>	Not Applicable
<b>Modulation:</b>	OFDM	<b>Beam Forming Gain (Y):</b>	Not Applicable
<b>TPC:</b>	Not Applicable	<b>Tested By:</b>	JMH
<b>Engineering Test Notes:</b>			

**Test Measurement Results**

Test Frequency	Frequency Range	Transmitter Conducted Spurious Emissions (dBm)							
		Port a		Port b		Port c		Port d	
MHz	MHz	SE	Limit	SE	Limit	SE	Limit	SE	Limit
2462.0	30.0 - 26000.0	-56.452	-30.20						

**Test Measurement Results**

Test Frequency	Band-Edge Frequency	Transmitter Conducted Band-Edge Emissions (dBm)							
		Port a		Port b		Port c		Port d	
MHz	MHz	BE	Limit	BE	Limit	BE	Limit	BE	Limit
2462.0	2483.5	-42.767	-29.65						

**Traceability to Industry Recognized Test Methodologies**

Work Instruction:	WI-05 MEASUREMENT OF SPURIOUS EMISSIONS
Measurement Uncertainty:	= 40 GHz ±2.37 dB, > 40 GHz ±4.6 dB

This test report may be reproduced in full only. The document may only be updated by MiCOM Labs personnel. Any changes will be noted in the Document History section of the report.





**Title:** Ear Force i60 TX Wireless Audio Transmitter  
**To:** FCC 47 CFR Part 15.247 & IC RSS-210  
**Serial #:** COMM38-U3 Rev A  
**Issue Date:** 30th September 2013  
**Page:** 33 of 53

## Specification

### Limits Band-Edge

Lower Limit Band-edge	Upper Limit Band-edge	Limit below highest level of desired power
2,400 MHz	2,483.5 MHz	≥ 20 dB
5725 MHz	5850 MHz	

**§15.247(d) and RSS-210 §A8.5** In any 100 kHz bandwidth outside the frequency band in which the spread spectrum or digitally modulated intentional radiator is operating, the radio frequency power that is produced by the intentional radiator shall be at least 20 dB below that in the 100 kHz bandwidth within the band that contains the highest level of the desired power, based on either an RF conducted or a radiated measurement, provided the transmitter demonstrates compliance with the peak conducted power limits. If the transmitter complies with the conducted power limits based on the use of RMS averaging over a time interval, as permitted under paragraph (b)(3) of this section, the attenuation required under this paragraph shall be 30 dB instead of 20 dB. Attenuation below the general limits specified in § 15.209(a) is not required. In addition, radiated emissions which fall in the restricted bands, as defined in § 15.205(a), must also comply with the radiated emission limits specified in § 15.209(a) (see § 15.205(c)).

### Laboratory Measurement Uncertainty for Conducted Spurious Emissions

Measurement uncertainty	±2.37 dB
-------------------------	----------

### Traceability

Method	Test Equipment Used
Measurements were made per work instruction WI-05 'Measurement of Spurious Emissions'	0088, 0158, 0287, 0252, 0313, 0314, 0070, 0116, 0117.

This test report may be reproduced in full only. The document may only be updated by MiCOM Labs personnel. Any changes will be noted in the Document History section of the report.



**Title:** Ear Force i60 TX Wireless Audio Transmitter  
**To:** FCC 47 CFR Part 15.247 & IC RSS-210  
**Serial #:** COMM38-U3 Rev A  
**Issue Date:** 30th September 2013  
**Page:** 34 of 53

## 6.1.2. Radiated Emission Testing

### Transmitter Radiated Spurious Emissions (above 1 GHz); Peak Field Strength Measurements; and Radiated Band Edge Measurements – Restricted Bands

**FCC, Part 15 Subpart C §15.247(d) 15.205; 15.209**  
**Industry Canada RSS-210 §A8.5, §2.2, §2.6**  
**Industry Canada RSS-Gen §4.7**

#### Test Procedure

The worst case highest spectral density radiated emissions above 1 GHz are measured in the anechoic chamber at a 3-meter distance on every azimuth in both horizontal and vertical polarities. The emissions are recorded and maximized as a function of azimuth by rotation through 360° with a spectrum analyzer in peak hold mode. Depending on the frequency band spanned a notch filter and waveguide filter was used to remove the fundamental frequency. The highest emissions relative to the limit are listed for each frequency spanned.

All measurements on any frequency or frequencies over 1 MHz are based on the use of measurement instrumentation employing an average detector function. All measurements above 1 GHz were performed using a minimum resolution bandwidth of 1 MHz.

#### Field Strength Calculation

The field strength is calculated by adding the Antenna Factor and Cable Loss, and subtracting Amplifier Gain from the measured reading. All factors are included in the reported data.

$$FS = R + AF + CORR - FO$$

where: FS = Field Strength

R = Measured Spectrum analyzer Input Amplitude

AF = Antenna Factor

CORR = Correction Factor = CL – AG + NFL

CL = Cable Loss

AG = Amplifier Gain

FO = Distance Falloff Factor

NFL = Notch Filter Loss or Waveguide Loss

For example:

Given receiver input reading of 51.5 dB $\mu$ V; Antenna Factor of 8.5 dB; Cable Loss of 1.3 dB; Falloff Factor of 0 dB, an Amplifier Gain of 26 dB and Notch Filter Loss of 1 dB. The Field Strength of the measured emission is:

$$FS = 51.5 + 8.5 + 1.3 - 26.0 + 1 = 36.3 \text{ dB}\mu\text{V/m}$$

Conversion between dB $\mu$ V/m (or dB $\mu$ V) and  $\mu$ V/m (or  $\mu$ V) are done as:

$$\text{Level (dB}\mu\text{V/m)} = 20 * \text{Log (level (\mu\text{V/m}))}$$

$$40 \text{ dB}\mu\text{V/m} = 100 \mu\text{V/m}$$

$$48 \text{ dB}\mu\text{V/m} = 250 \mu\text{V/m}$$

This test report may be reproduced in full only. The document may only be updated by MiCOM Labs personnel. Any changes will be noted in the Document History section of the report.



**Title:** Ear Force i60 TX Wireless Audio Transmitter  
**To:** FCC 47 CFR Part 15.247 & IC RSS-210  
**Serial #:** COMM38-U3 Rev A  
**Issue Date:** 30th September 2013  
**Page:** 35 of 53

i60 TX

<b>Test Freq.</b>	2462	<b>Engineer</b>	JMH
<b>Variant</b>	802.11g; 6 Mbs	<b>Temp (°C)</b>	25
<b>Freq. Range</b>	1000 MHz - 18000 MHz	<b>Rel. Hum.(%)</b>	32
<b>Power Setting</b>	SPW 0	<b>Press. (mBars)</b>	1002
<b>Antenna</b>	Chip -1.5 dBi	<b>Duty Cycle (%)</b>	100
<b>Test Notes 1</b>			
<b>Test Notes 2</b>	i60 TX Transmitter		

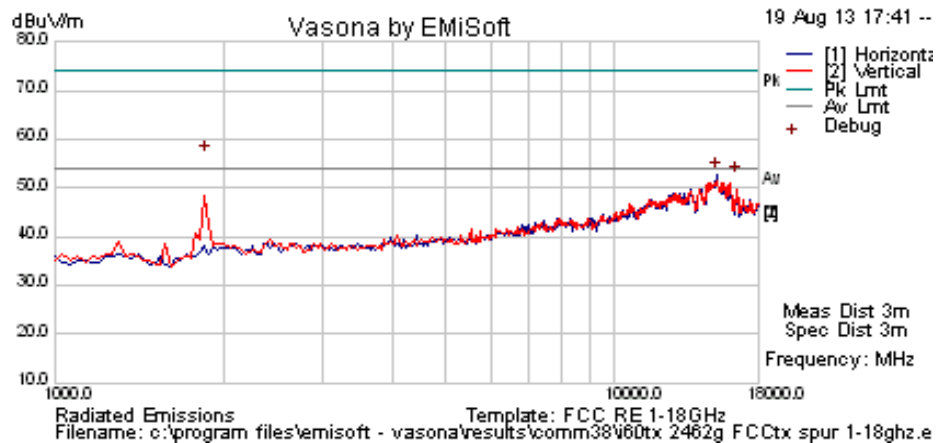

**Formally measured emission peaks**

Frequency MHz	Raw dBuV	Cable Loss	AF dB	Level dBuV/m	Measurement Type	Pol	Hgt cm	Azt Deg	Limit dBuV/m	Margin dB	Pass /Fail	Comments
1861.403	66.3	2.8	-12.3	56.8	Peak Max	V	141	231	74.0	-17.3	Pass	NRB
15198.156	46.2	8.6	-1.5	53.4	Peak Max	H	176	332	74	-20.7	Pass	NRB
16516.152	42.8	9.2	0.4	52.4	Peak Max	V	99	0	74	-21.6	Pass	NRB

Legend: TX = Transmitter Emissions; DIG = Digital Emissions; FUND = Fundamental; WB = Wideband Emission  
 RB = Restricted Band (15.209 Limits); NRB = Non Restricted Band, Limit is 20dB below fundamental peak

This test report may be reproduced in full only. The document may only be updated by MiCOM Labs personnel. Any changes will be noted in the Document History section of the report.



**Title:** Ear Force i60 TX Wireless Audio Transmitter  
**To:** FCC 47 CFR Part 15.247 & IC RSS-210  
**Serial #:** COMM38-U3 Rev A  
**Issue Date:** 30th September 2013  
**Page:** 36 of 53

Band Edge 2300-2390 MHz

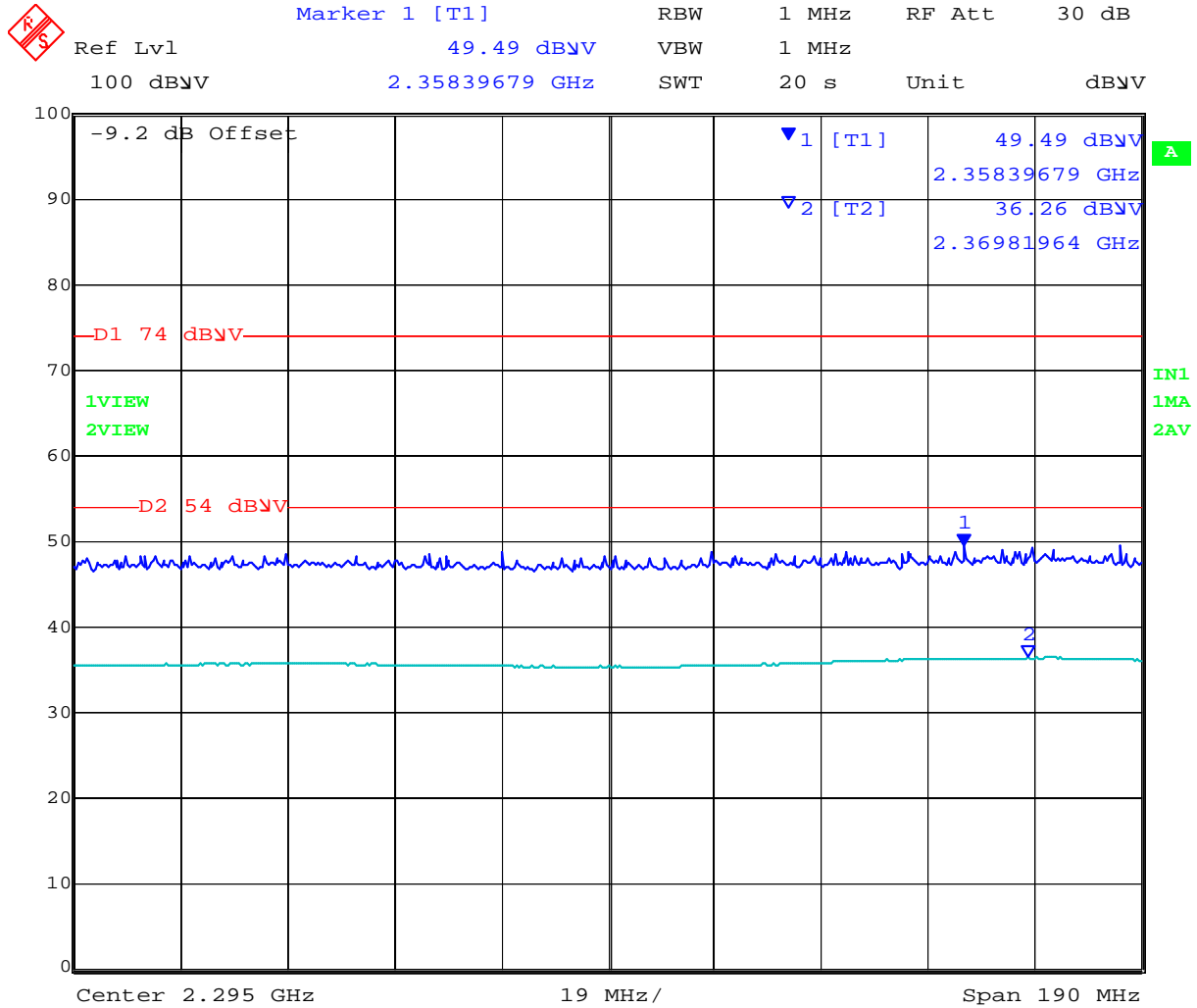

Date: 19.AUG.2013 18:15:50

This test report may be reproduced in full only. The document may only be updated by MiCOM Labs personnel. Any changes will be noted in the Document History section of the report.



Band Edge 2483.5 – 2500 MHz

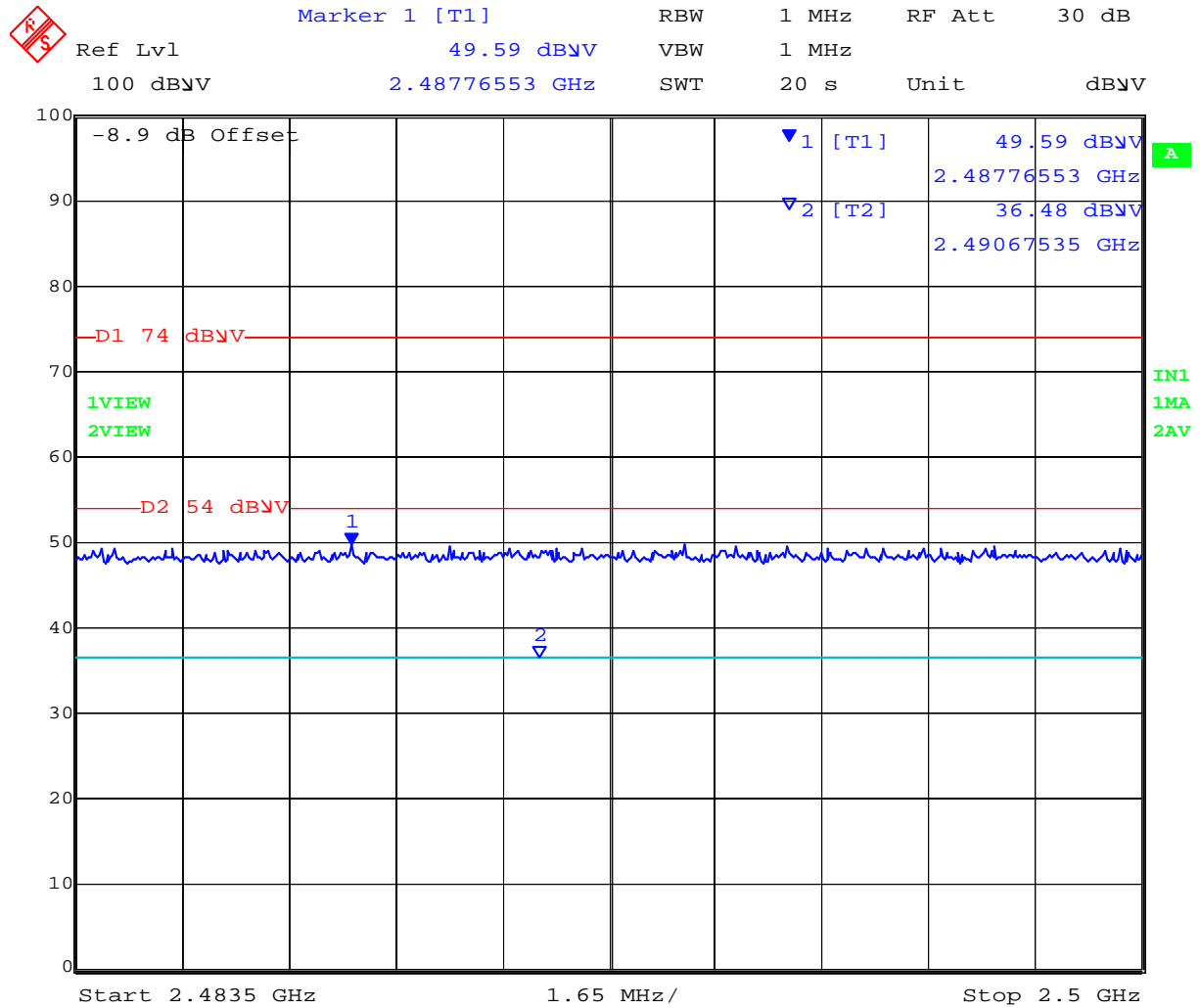

Date: 20.AUG.2013 09:57:22

This test report may be reproduced in full only. The document may only be updated by MiCOM Labs personnel. Any changes will be noted in the Document History section of the report.



**Title:** Ear Force i60 TX Wireless Audio Transmitter  
**To:** FCC 47 CFR Part 15.247 & IC RSS-210  
**Serial #:** COMM38-U3 Rev A  
**Issue Date:** 30th September 2013  
**Page:** 38 of 53

---

## Specification Limits

**FCC §15.247(d) and RSS-210 §A8.5** In any 100 kHz bandwidth outside the frequency band in which the spread spectrum or digitally modulated intentional radiator is operating, the radio frequency power that is produced by the intentional radiator shall be at least 20 dB below that in the 100 kHz bandwidth within the band that contains the highest level of the desired power, based on either an RF conducted or radiated measurement, provided the transmitter demonstrates compliance with the peak conducted power limits.

### **FCC §15.247(d)**

If the transmitter complies with the conducted power limits based on the use of RMS averaging over a time interval, as permitted under paragraph (b)(3) of this section, the attenuation required under this paragraph shall be 30 dB instead of 20 dB. Attenuation below the general limits specified §15.209(a) is not required. In addition, radiated emissions which fall in the restricted bands, as defined in Section §15.205(a), must also comply with the radiated emission limits specified in Section 15.209(a) (see Section 15.205(a)).

**IC RSS-210 §A8.5** If the transmitter complies with the conducted power limits based on the use of RMS averaging over a time interval, as permitted under section A8.4(4), the attenuation required shall be 30 dB instead of 20 dB. Attenuation below the general limits specified in Tables 2 and 3 is not required. In addition, radiated emissions which fall in the restricted bands of Table 1 must also comply with the radiated emission limits specified in Tables 2 and 3.

**FCC §15.205 (a)** Except as shown in paragraph (d) of 15.205 (a), only spurious emissions are permitted in any of the frequency bands listed.

**FCC §15.205 (a)** Except as shown in paragraphs (d) and (e) of this section, the field strength of emissions appearing within these frequency bands shall not exceed the limits shown in Section §15.209. At frequencies equal to or less than 1000 MHz, compliance with the limits in Section 15.209 shall be demonstrated using measurement instrumentation employing a CISPR quasi-peak detector. Above 1000 MHz, compliance with the emission limits in Section 15.209 shall be demonstrated based on the average value of the measured emissions. The provisions in Section 15.35 apply to these measurements.

**FCC §15.209 (a)** Except as provided elsewhere in this subpart, the emissions from an intentional radiator shall not exceed the field strength levels specified in the following table.

---

This test report may be reproduced in full only. The document may only be updated by MiCOM Labs personnel. Any changes will be noted in the Document History section of the report.



**Title:** Ear Force i60 TX Wireless Audio Transmitter  
**To:** FCC 47 CFR Part 15.247 & IC RSS-210  
**Serial #:** COMM38-U3 Rev A  
**Issue Date:** 30th September 2013  
**Page:** 39 of 53

**§15.209 (a) Limit Matrix**

Frequency(MHz)	Field Strength ( $\mu\text{V/m}$ )	Field Strength ( $\text{dB}\mu\text{V/m}$ )	Measurement Distance (meters)
30-88	100	40.0	3
88-216	150	43.5	3
216-960	200	46.0	3
Above 960	500	54.0	3

**Laboratory Measurement Uncertainty for Radiated Emissions**

Measurement uncertainty	+5.6/ -4.5 dB
-------------------------	---------------

**Traceability**

Method	Test Equipment Used
Measurements were made per work instruction WI-03 'Measurement of Radiated Emissions'	0088, 0158, 0134, 0304, 0311, 0315, 0310, 0312

This test report may be reproduced in full only. The document may only be updated by MiCOM Labs personnel. Any changes will be noted in the Document History section of the report.



**Title:** Ear Force i60 TX Wireless Audio Transmitter  
**To:** FCC 47 CFR Part 15.247 & IC RSS-210  
**Serial #:** COMM38-U3 Rev A  
**Issue Date:** 30th September 2013  
**Page:** 40 of 53

---

### 6.1.2.1. Digital Emissions (0.03-1 GHz)

**FCC, Part 15 Subpart C §15.205/ §15.209**  
**Industry Canada RSS-Gen §7.2.5**

#### Test Procedure

Testing 30M-1 GHz was performed in a 3-meter anechoic chamber using a CISPR compliant receiver. Preliminary radiated emissions were measured on every azimuth and with the receiving antenna in both horizontal and vertical polarizations. To further maximize emissions the receive antenna was varied between 1 and 4 meters. The emissions are recorded with receiver in peak hold mode. Emissions closest to the limits are measured in the quasi-peak mode with the tuned receiver using a bandwidth of 120 kHz. Only the highest emissions relative to the limit are listed. The anechoic chamber test set-up is identified in Section 6 Test Set-Up Photographs.

The EUT had two methods of powering on ac/dc converter and Power over Ethernet (POE). Both modes were tested for emissions below 1GHz.

#### Field Strength Calculation

The field strength is calculated by adding the Antenna Factor and Cable Loss, and subtracting Amplifier Gain from the measured reading. In this test facility, the Antenna Factor, Cable Loss, and Amplifier Gains are loaded into the Rohde & Schwarz Receiver and the corrected field strength can be read directly on the receiver.

$$FS = R + AF + CORR$$

where:

FS = Field Strength

R = Measured Receiver Input Amplitude

AF = Antenna Factor

CORR = Correction Factor = CL – AG + NFL

CL = Cable Loss

AG = Amplifier Gain

For example:

Given a Receiver input reading of 51.5dB $\mu$ V; Antenna Factor of 8.5dB; Cable Loss of 1.3dB; Falloff Factor of 0dB, an Amplifier Gain of 26dB and Notch Filter Loss of 1dB. The Field Strength of the measured emission is:

$$FS = 51.5 + 8.5 + 1.3 - 26.0 + 1 = 36.3\text{dB}\mu\text{V}/\text{m}$$

Conversion between dB $\mu$ V/m (or dB $\mu$ V) and  $\mu$ V/m (or  $\mu$ V) are done as:

$$\text{Level (dB}\mu\text{V}/\text{m)} = 20 * \text{Log (level (\mu\text{V}/\text{m}))}$$

$$40 \text{ dB}\mu\text{V}/\text{m} = 100\mu\text{V}/\text{m}$$

$$48 \text{ dB}\mu\text{V}/\text{m} = 250\mu\text{V}/\text{m}$$

---

This test report may be reproduced in full only. The document may only be updated by MiCOM Labs personnel. Any changes will be noted in the Document History section of the report.





**Title:** Ear Force i60 TX Wireless Audio Transmitter  
**To:** FCC 47 CFR Part 15.247 & IC RSS-210  
**Serial #:** COMM38-U3 Rev A  
**Issue Date:** 30th September 2013  
**Page:** 41 of 53

**WiFi Only**

<b>Test Freq.</b>	NA	<b>Engineer</b>	JMH
<b>Variant</b>	Digital Emissions	<b>Temp (°C)</b>	25
<b>Freq. Range</b>	30 MHz - 1000 MHz	<b>Rel. Hum.(%)</b>	32
<b>Power Setting</b>		<b>Press. (mBars)</b>	1002
<b>Antenna</b>			
<b>Test Notes 1</b>	i60 TX		
<b>Test Notes 2</b>			

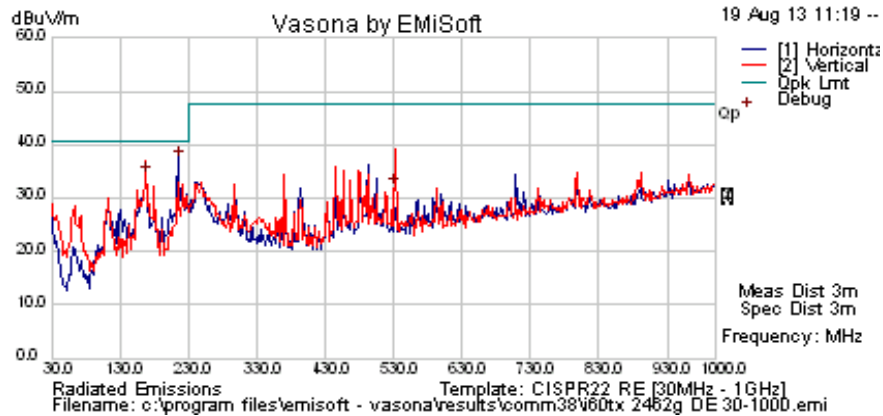

**Formally measured emission peaks**

Frequency MHz	Raw dBuV	Cable Loss	AF dB	Level dBuV/m	Measurement Type	Pol	Hgt cm	Azt Deg	Limit dBuV/m	Margin dB	Pass /Fail	Comments
216.037	52.4	4.7	-19.9	37.2	Quasi Max	H	128	166	40.5	-3.3	Pass	
167.985	49.0	4.5	-19.2	34.4	Quasi Max	V	109	30	40.5	-6.2	Pass	
530.898	38.3	5.9	-12.3	31.9	Quasi Max	V	99	347	47.5	-15.6	Pass	

Legend:	DIG = Digital Device Emission; TX = Transmitter Emission; FUND = Fundamental Frequency
	NRB = Non-Restricted Band, Limit is 20 dB below Fundamental; RB = Restricted Band

This test report may be reproduced in full only. The document may only be updated by MiCOM Labs personnel. Any changes will be noted in the Document History section of the report.



**Title:** Ear Force i60 TX Wireless Audio Transmitter  
**To:** FCC 47 CFR Part 15.247 & IC RSS-210  
**Serial #:** COMM38-U3 Rev A  
**Issue Date:** 30th September 2013  
**Page:** 42 of 53

## Specification

### Limits

**§15.205 (a)** Except as shown in paragraph (d) of 15.205 (a), only spurious emissions are permitted in any of the frequency bands listed.

**§15.205 (a)** Except as shown in paragraphs (d) and (e) of this section, the field strength of emissions appearing within these frequency bands shall not exceed the limits shown in Section §15.209. At frequencies equal to or less than 1000 MHz, compliance with the limits in Section 15.209 shall be demonstrated using measurement instrumentation employing a CISPR quasi-peak detector. Above 1000 MHz, compliance with the emission limits in Section 15.209 shall be demonstrated based on the average value of the measured emissions. The provisions in Section 15.35 apply to these measurements.

**§15.209 (a)** Except as provided elsewhere in this subpart, the emissions from an intentional radiator shall not exceed the field strength levels specified in the following table.

### §15.209 (a) and Industry Canada RSS-Gen §7.2.5 Limit Matrix

Frequency(MHz)	Field Strength ( $\mu\text{V}/\text{m}$ )	Field Strength ( $\text{dB}\mu\text{V}/\text{m}$ )	Measurement Distance (meters)
30-88	100	40.0	3
88-216	150	43.5	3
216-960	200	46.0	3
Above 960	500	54.0	3

### Laboratory Measurement Uncertainty for Radiated Emissions

Measurement uncertainty	+5.6/ -4.5 dB
-------------------------	---------------

### Traceability

Method	Test Equipment Used
Measurements were made per work instruction WI-03 'Measurement of Radiated Emissions'	0088, 0158, 0134, 0304, 0311, 0315, 0310, 0312

This test report may be reproduced in full only. The document may only be updated by MiCOM Labs personnel. Any changes will be noted in the Document History section of the report.

### 6.1.3. AC Wireline Conducted Emissions (150 kHz – 30 MHz)

**FCC, Part 15 Subpart C §15.207**  
**Industry Canada RSS-Gen §7.2.4**

#### **Test Procedure**

The EUT is configured in accordance with ANSI C63.4. The conducted emissions are measured in a shielded room with a spectrum analyzer in peak hold in the first instance. Emissions closest to the limit are measured in the quasi-peak mode (QP) with the tuned receiver using a bandwidth of 9 kHz. The emissions are maximized further by cable manipulation. The highest emissions relative to the limit are listed.

#### **Test Measurement Set up**

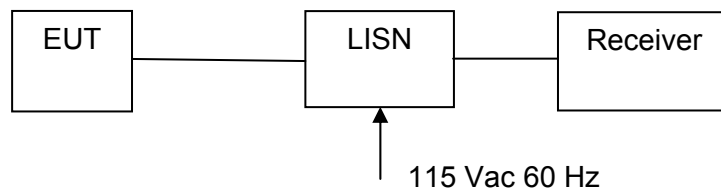

Measurement set up for AC Wireline Conducted Emissions Test

#### **Measurement Results for AC Wireline Conducted Emissions (150 kHz – 30 MHz)**

Ambient conditions.

Temperature: 17 to 23 °C    Relative humidity: 31 to 57 %    Pressure: 999 to 1012 mbar

**Not required - EUT is power by USB only.**

## Specification

### Limit

**§15.207 (a)** Except as shown in paragraphs (b) and (c) of this section, for an intentional radiator that is designed to be connected to the public utility (AC) power line, the radio frequency voltage that is conducted back onto the AC power line on any frequency or frequencies within the band 150 kHz to 30 MHz shall not exceed the limits in the following table, as measured using a 50  $\mu\Omega$  line impedance stabilization network (LISN), see §15.207 (a) matrix below. Compliance with the provisions of this paragraph shall be based on the measurement of the radio frequency voltage between each power line and ground at the power terminal.

### RSS-Gen §7.2.4

Except when the requirements applicable to a given device state otherwise, for any radio apparatus equipped to operate from the public utility AC power supply, either directly or indirectly (such as with a battery charger), the radio frequency voltage of emissions conducted back onto the AC power lines in the frequency range of 0.15 MHz to 30 MHz shall not exceed the limits shown in the table below. The more stringent limit applies at the frequency range boundaries. The conducted emissions shall be measured with a 50 ohm/50 microhenry line impedance stabilization network (LISN).

### §15.207 (a) and RSS-Gen §7.2.4 Limit Matrix

The lower limit applies at the boundary between frequency ranges

Frequency of Emission (MHz)	Conducted Limit (dB $\mu$ V)	
	Quasi-peak	Average
0.15-0.5	66 to 56*	56 to 46*
0.5-5	56	46
5-30	60	50

\* Decreases with the logarithm of the frequency

### Laboratory Measurement Uncertainty for Conducted Emissions

Measurement uncertainty	$\pm 2.64$ dB
-------------------------	---------------

### Traceability

Method	Test Equipment Used
Measurements were made per work instruction WI-EMC-01 'Measurement of Conducted Emissions'	0158, 0184, 0287, 0190, 0293, 0307

This test report may be reproduced in full only. The document may only be updated by MiCOM Labs personnel. Any changes will be noted in the Document History section of the report.

## 7. PHOTOGRAPHS

### 7.1. Conducted Test Setup



---

This test report may be reproduced in full only. The document may only be updated by MiCOM Labs personnel. Any changes will be noted in the Document History section of the report.



**Title:** Ear Force i60 TX Wireless Audio Transmitter  
**To:** FCC 47 CFR Part 15.247 & IC RSS-210  
**Serial #:** COMM38-U3 Rev A  
**Issue Date:** 30th September 2013  
**Page:** 46 of 53

## 8. TEST EQUIPMENT

Asset #	Instrument	Manufacturer	Part #	Serial #	Calibration Due Date
0070	Power Meter	Hewlett Packard	437B	3125U11552	28 <sup>th</sup> Nov 13
0117	Power Sensor	Hewlett Packard	8487D	3318A00371	15 <sup>th</sup> Nov 13
0223	Power Meter	Hewlett Packard	EPM-442A	US37480256	15 <sup>th</sup> Nov 13
0374	Power Sensor	Hewlett Packard	8485A	3318A19694	29 <sup>th</sup> Nov 13
0376	Power Sensor	Agilent	U2000A	MY51440005	8 <sup>th</sup> Dec 13
0158	Barometer /Thermometer	Control Co.	4196	E2846	8 <sup>th</sup> Dec 13
0193	EMI Receiver	Rhode & Schwartz	ESI 7	838496/007	2 <sup>nd</sup> Dec 13
0287	EMI Receiver	Rhode & Schwartz	ESIB40	100201	16 <sup>th</sup> Nov 13
0338	30 - 3000 MHz Antenna	Sunol	JB3	A052907	8 <sup>th</sup> Nov 13
0335	1-18 GHz Horn Antenna	EMCO	3117	00066580	7 <sup>th</sup> Nov 13
0252	SMA Cable	Megaphase	Sucoflex 104	None	N/A
0293	BNC Cable	Megaphase	1689 1GVT4	15F50B001	N/A
0307	BNC Cable	Megaphase	1689 1GVT4	15F50B002	N/A
0310	2m SMA Cable	Micro-Coax	UFA210A-0-0787-3G03G0	209089-001	N/A
0312	3m SMA Cable	Micro-Coax	UFA210A-1-1181-3G0300	209092-001	N/A
0314	30dB N-Type Attenuator	ARRA	N9444-30	1623	N/A
	EMC Test Software	EMISoft	Vasona	5.0051	N/A
	RF Conducted Test Software	National Instruments	Labview	Version 8.2	N/A
	RF Conducted Test Software	MiCOM Labs ATS		Version 1.5	N/A

This test report may be reproduced in full only. The document may only be updated by MiCOM Labs personnel. Any changes will be noted in the Document History section of the report.



**Title:** Ear Force i60 TX Wireless Audio Transmitter  
**To:** FCC 47 CFR Part 15.247 & IC RSS-210  
**Serial #:** COMM38-U3 Rev A  
**Issue Date:** 30th September 2013  
**Page:** 47 of 53

---

## **APPENDIX**

### **A. SUPPORTING INFORMATION**

#### **A.1. CONDUCTED TEST PLOTS**

---

This test report may be reproduced in full only. The document may only be updated by MiCOM Labs personnel. Any changes will be noted in the Document History section of the report.



**Title:** Ear Force i60 TX Wireless Audio Transmitter  
**To:** FCC 47 CFR Part 15.247 & IC RSS-210  
**Serial #:** COMM38-U3 Rev A  
**Issue Date:** 30th September 2013  
**Page:** 48 of 53

### A.1.1.1. 6 dB & 99% Bandwidth



#### 6 dB & 99% BANDWIDTH

Variant: 802.11g, Channel: 2462.00 MHz, Chain a, Temp: Ambient, Voltage: 5 Vdc

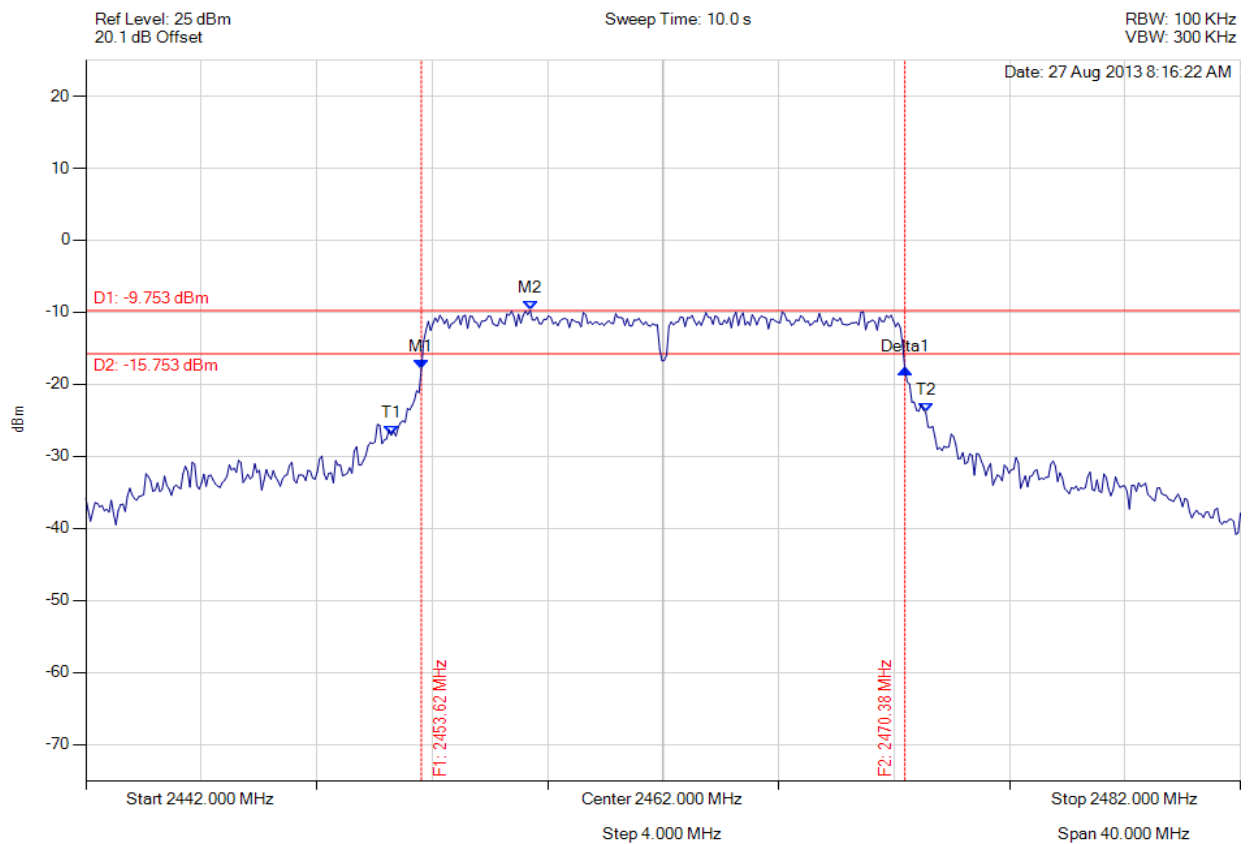

Analyser Setup	Marker : Frequency : Amplitude	Test Results
Detector = MAX PEAK Sweep Count = 0 RF Atten (dB) = 20 Trace Mode = VIEW	M1 : 2453.623 MHz : -17.892 dBm M2 : 2457.391 MHz : -9.753 dBm Delta1 : 16.754 MHz : -0.051 dB T1 : 2452.581 MHz : -27.068 dBm T2 : 2471.098 MHz : -23.928 dBm OBW : 18.517 MHz	Measured 6 dB Bandwidth: 16.754 MHz Limit: ≥500.0 kHz Margin: -16.25 MHz

[Back to the Matrix](#)

This test report may be reproduced in full only. The document may only be updated by MiCOM Labs personnel. Any changes will be noted in the Document History section of the report.



### A.1.2. Peak Output Power



#### PEAK OUTPUT POWER

Variant: 802.11g, Channel: 2462.00 MHz, Chain a, Temp: Ambient, Voltage: 5 Vdc

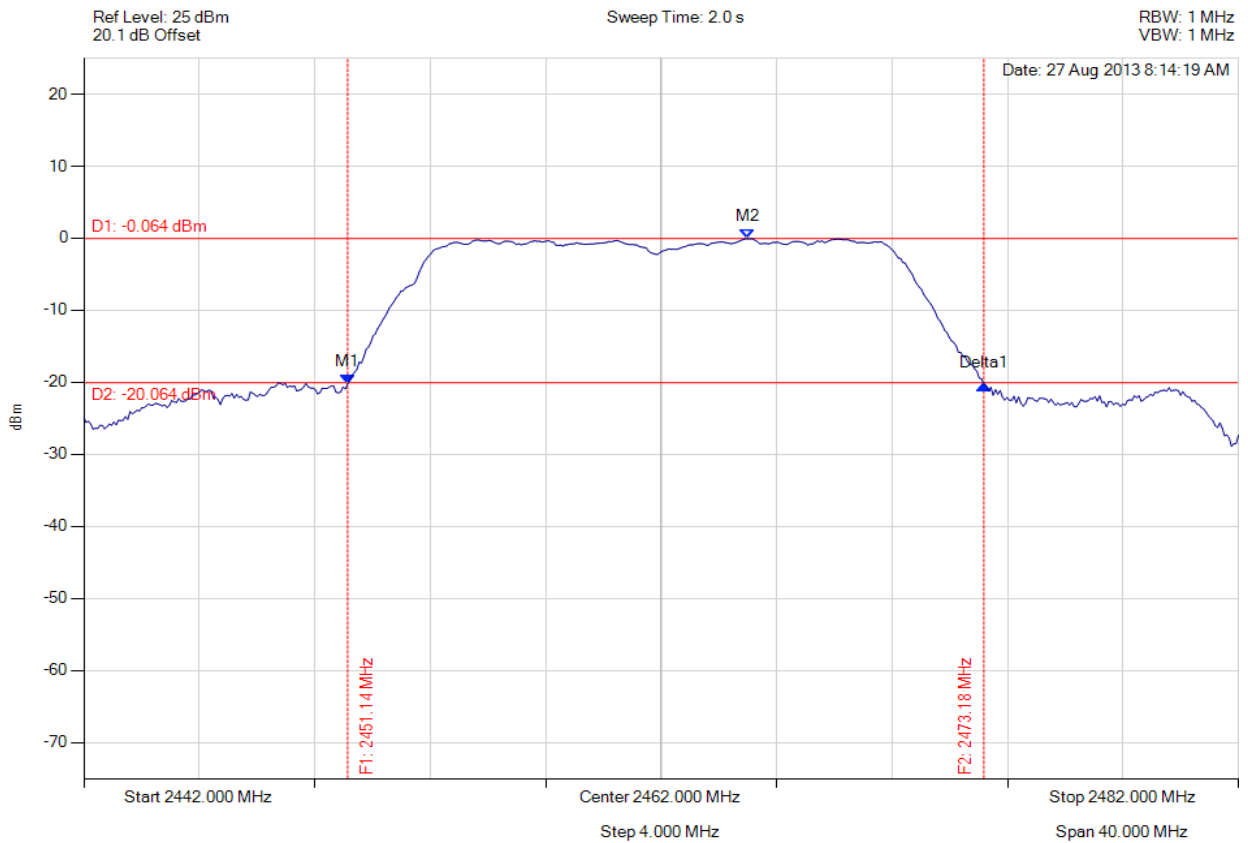

Analyser Setup	Marker : Frequency : Amplitude	Test Results
Detector = MAX PEAK Sweep Count = 0 RF Atten (dB) = 20 Trace Mode = VIEW	M1 : 2451.138 MHz : -20.212 dBm M2 : 2465.006 MHz : -0.064 dBm Delta1 : 22.044 MHz : -0.100 dB	Channel Power: 11.08 dBm Limit: 30.00 dBm Margin: -18.92 dB

[Back to the Matrix](#)

This test report may be reproduced in full only. The document may only be updated by MiCOM Labs personnel. Any changes will be noted in the Document History section of the report.



### A.1.3. Power Spectral Density



#### POWER SPECTRAL DENSITY - PEAK

Variant: 802.11g, Channel: 2462.00 MHz, Chain a, Temp: Ambient, Voltage: 5 Vdc

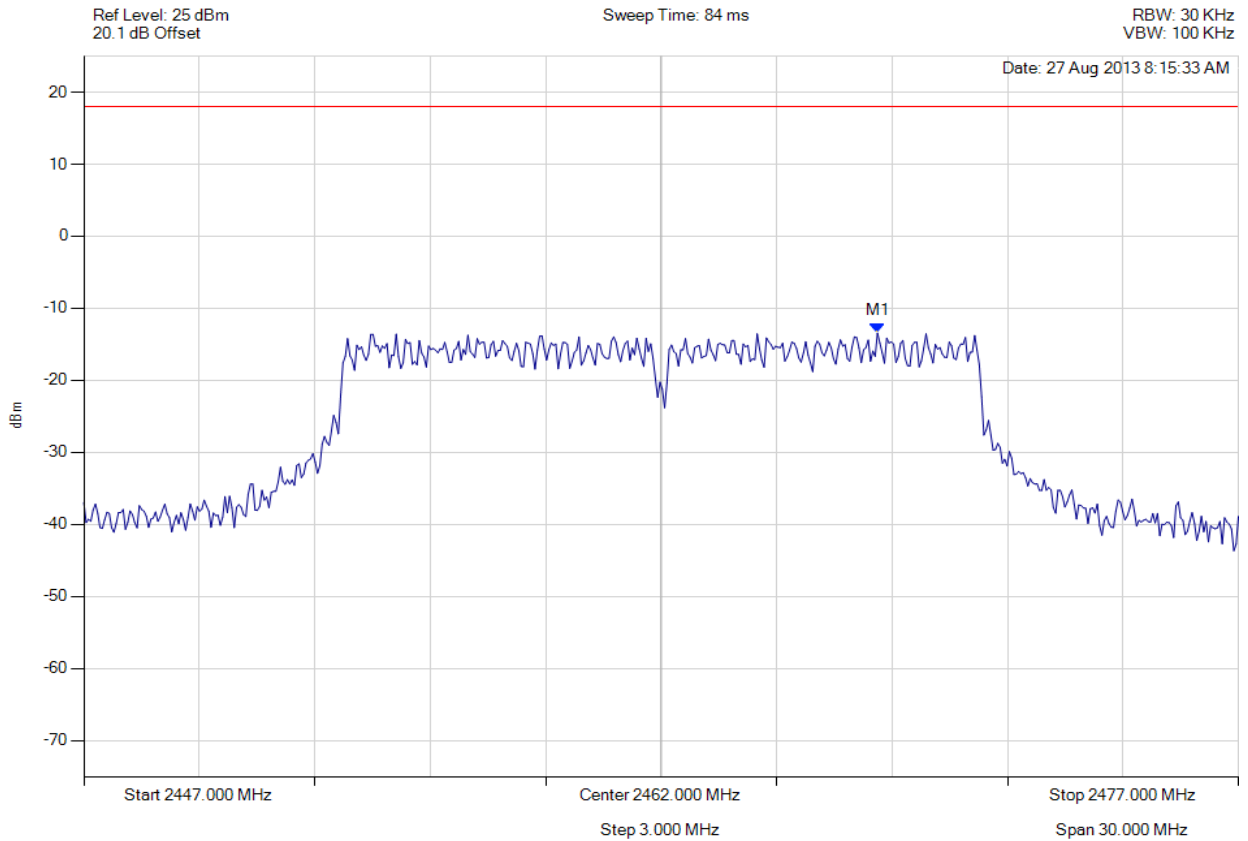

Analyser Setup	Marker : Frequency : Amplitude	Test Results
Detector = MAX PEAK Sweep Count = 0 RF Atten (dB) = 20 Trace Mode = VIEW	M1 : 2467.621 MHz : -13.434 dBm	Limit: $\leq 18.000$ dBm Margin: dB

[Back to the Matrix](#)

This test report may be reproduced in full only. The document may only be updated by MiCOM Labs personnel. Any changes will be noted in the Document History section of the report.



**Title:** Ear Force i60 TX Wireless Audio Transmitter  
**To:** FCC 47 CFR Part 15.247 & IC RSS-210  
**Serial #:** COMM38-U3 Rev A  
**Issue Date:** 30th September 2013  
**Page:** 51 of 53

#### A.1.4. Conducted Spurious Emissions



#### CONDUCTED SPURIOUS EMISSIONS - PEAK

Variant: 802.11g, Channel: 2462.00 MHz, Chain a, Temp: Ambient, Voltage: 5 Vdc

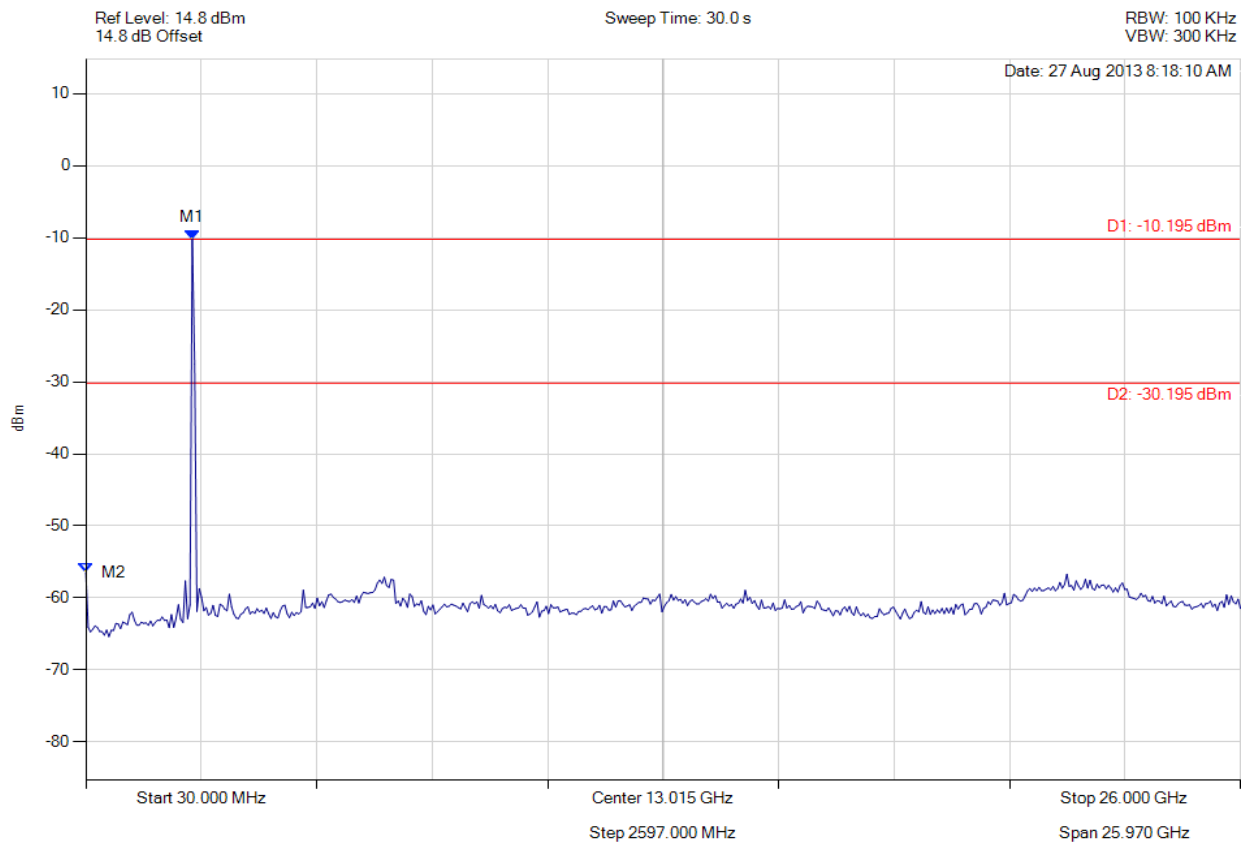

Analyser Setup	Marker : Frequency : Amplitude	Test Results
Detector = MAX PEAK Sweep Count = 0 RF Atten (dB) = 10 Trace Mode = VIEW	M1 : 2424.028 MHz : -10.195 dBm M2 : 30.000 MHz : -56.452 dBm	Limit: -30.20 dBm Margin: -26.25 dB

[Back to the Matrix](#)

This test report may be reproduced in full only. The document may only be updated by MiCOM Labs personnel. Any changes will be noted in the Document History section of the report.



**Title:** Ear Force i60 TX Wireless Audio Transmitter  
**To:** FCC 47 CFR Part 15.247 & IC RSS-210  
**Serial #:** COMM38-U3 Rev A  
**Issue Date:** 30th September 2013  
**Page:** 52 of 53



**CONDUCTED HIGH BAND-EDGE EMISSION - PEAK**

Variant: 802.11g, Channel: 2462.00 MHz, Chain a, Temp: Ambient, Voltage: 5 Vdc

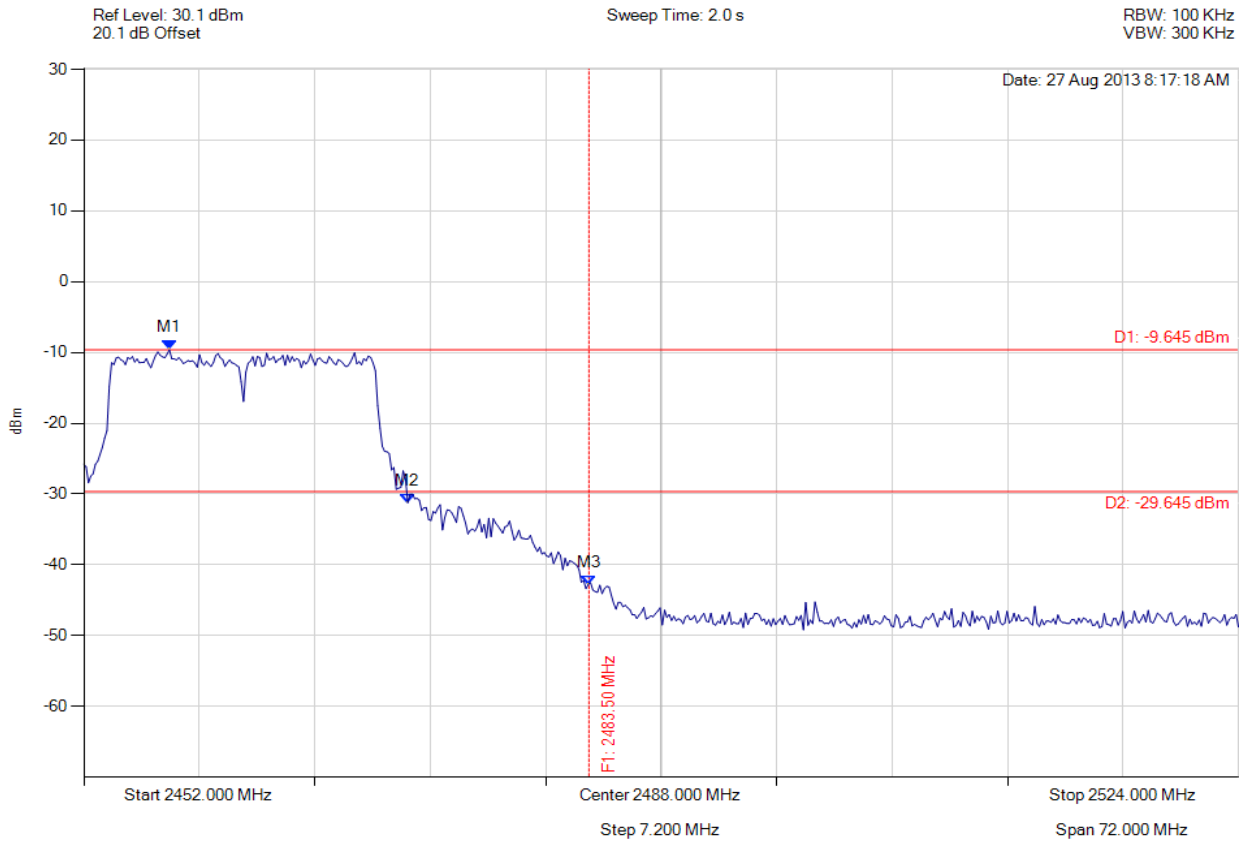

Analyser Setup	Marker : Frequency : Amplitude	Test Results
Detector = MAX PEAK Sweep Count = 0 RF Atten (dB) = 20 Trace Mode = VIEW	M1 : 2457.339 MHz : -9.645 dBm M2 : 2472.200 MHz : -31.228 dBm M3 : 2483.500 MHz : -42.767 dBm	Limit: -29.65 dBm Margin: -13.12 dB

[Back to the Matrix](#)

This test report may be reproduced in full only. The document may only be updated by MiCOM Labs personnel. Any changes will be noted in the Document History section of the report.



440 Boulder Court, Suite 200  
Pleasanton, CA 94566, USA  
Tel: 1.925.462.0304  
Fax: 1.925.462.0306  
[www.micomlabs.com](http://www.micomlabs.com)