

Test of  
Ear Force i30 Wireless Audio Headset

To: FCC 47 CFR Part 15.247 & IC RSS-210

Test Report Serial No.: COMM37-U2 Rev A



# TEST REPORT

FROM



Test of Ear Force i30 Wireless Audio Headset

to

To FCC 47 CFR Part 15.247 & IC RSS-210

Test Report Serial No.: COMM37-U2 Rev A

This report supersedes: None

Applicant: Voyetra Turtle Beach Inc  
100 Summit Lake Drive, Suite 100  
Valhalla  
New York, 10595, USA

Product Function: Wireless Audio Headset

Copy No: pdf Issue Date: 25th September 2013

**This Test Report is Issued Under the Authority of:**

**MiCOM Labs, Inc.**

440 Boulder Court, Suite 200

Pleasanton, CA 94566 USA

Phone: +1 (925) 462-0304

Fax: +1 (925) 462-0306

[www.micomlabs.com](http://www.micomlabs.com)



TEST CERTIFICATE #2381.01

**MiCOM Labs is an ISO 17025 Accredited Testing Laboratory**



**Title:** Ear Force i30 Wireless Audio Headset  
**To:** FCC 47 CFR Part 15.247 & IC RSS-210  
**Serial #:** COMM37-U2 Rev A  
**Issue Date:** 25th September 2013  
**Page:** 3 of 127

---

This page has been left intentionally blank

---

This test report may be reproduced in full only. The document may only be updated by MiCOM Labs personnel. Any changes will be noted in the Document History section of the report.



**Title:** Ear Force i30 Wireless Audio Headset  
**To:** FCC 47 CFR Part 15.247 & IC RSS-210  
**Serial #:** COMM37-U2 Rev A  
**Issue Date:** 25th September 2013  
**Page:** 4 of 127

## TABLE OF CONTENTS

<b>ACCREDITATION, LISTINGS &amp; RECOGNITION .....</b>	<b>6</b>
TESTING ACCREDITATION .....	6
RECOGNITION .....	7
PRODUCT CERTIFICATION .....	8
<b>1. TEST RESULT SUMMARY .....</b>	<b>10</b>
<b>COMPLIANCE STATEMENT .....</b>	<b>11</b>
<b>2. REFERENCES AND MEASUREMENT UNCERTAINTY .....</b>	<b>12</b>
2.1. Normative References .....	12
2.2. Test and Uncertainty Procedures .....	13
<b>3. PRODUCT DETAILS AND TEST CONFIGURATIONS .....</b>	<b>14</b>
3.1. Technical Details .....	14
3.2. Scope of Test Program .....	15
3.3. Equipment Model(s) and Serial Number(s) .....	19
3.4. Antenna Details .....	19
3.5. Cabling and I/O Ports .....	19
3.6. Types of Modulation Supported .....	20
3.7. EUT Configurations .....	20
3.8. Equipment Modifications .....	20
3.9. Deviations from the Test Standard .....	20
<b>4. TEST EQUIPMENT CONFIGURATION(S) .....</b>	<b>21</b>
4.1. Conducted RF Emission Test Set-up .....	21
4.2. Radiated Spurious Emission Test Set-up > 1 GHz .....	22
4.3. Digital Emissions Test Set-up (0.03 – 1 GHz) .....	23
4.4. AC Wireline Emission Test Set-up .....	24
<b>5. TEST SUMMARY .....</b>	<b>25</b>
<b>6. TEST RESULTS .....</b>	<b>27</b>
6.1. Device Characteristics .....	27
6.1.1. <i>Conducted Testing</i> .....	27
6.1.2. <i>Radiated Emission Testing</i> .....	58
6.1.3. <i>AC Wireline Conducted Emissions (150 kHz – 30 MHz)</i> .....	74
<b>7. PHOTOGRAPHS .....</b>	<b>76</b>
7.1. Conducted Test Setup .....	76
7.2. Radiated Emissions Test Setup > 1 GHz .....	77
<b>8. TEST EQUIPMENT .....</b>	<b>78</b>
<b>APPENDIX .....</b>	<b>79</b>
<b>A. SUPPORTING INFORMATION .....</b>	<b>79</b>
A.1. CONDUCTED TEST PLOTS .....	79
A.1.1. <i>6 dB &amp; 99% Bandwidth</i> .....	80
A.1.2. <i>Channel Separation</i> .....	92
A.1.3. <i>Number of Hopping Frequencies</i> .....	99
A.1.4. <i>Dwell Time</i> .....	101
A.1.5. <i>Peak Power Output</i> .....	110

This test report may be reproduced in full only. The document may only be updated by MiCOM Labs personnel. Any changes will be noted in the Document History section of the report.



**Title:** Ear Force i30 Wireless Audio Headset  
**To:** FCC 47 CFR Part 15.247 & IC RSS-210  
**Serial #:** COMM37-U2 Rev A  
**Issue Date:** 25th September 2013  
**Page:** 5 of 127

---

A.1.6. *Conducted Spurious Emissions* ..... 122

---

This test report may be reproduced in full only. The document may only be updated by MiCOM Labs personnel. Any changes will be noted in the Document History section of the report.

## ACCREDITATION, LISTINGS & RECOGNITION

### TESTING ACCREDITATION

MiCOM Labs, Inc. is an accredited Electrical testing laboratory per the international standard EN ISO/IEC 17025. The company is accredited by the American Association for Laboratory Accreditation (A2LA) [www.a2la.org](http://www.a2la.org) test laboratory number 2381.01. MiCOM Labs test schedule is available at the following URL; <http://www.a2la.org/scopepdf/2381-01.pdf>



The American Association for Laboratory Accreditation

World Class Accreditation

## *Accredited Laboratory*

A2LA has accredited

**MICOM LABS**

*Pleasanton, CA*

for technical competence in the field of

**Electrical Testing**

This laboratory is accredited in accordance with the recognized International Standard ISO/IEC 17025:2005 *General Requirements for the Competence of Testing and Calibration Laboratories*. This accreditation demonstrates technical competence for a defined scope and the operation of a laboratory quality management system (*refer to joint ISO-ILAC-IAF Communiqué dated 8 January 2009*).

Presented this 27<sup>th</sup> day of March 2012.



President & CEO  
For the Accreditation Council  
Certificate Number 2381.01  
Valid to November 30, 2013

*For the tests or types of tests to which this accreditation applies, please refer to the laboratory's Electrical Scope of Accreditation.*

This test report may be reproduced in full only. The document may only be updated by MiCOM Labs personnel. Any changes will be noted in the Document History section of the report.



**Title:** Ear Force i30 Wireless Audio Headset  
**To:** FCC 47 CFR Part 15.247 & IC RSS-210  
**Serial #:** COMM37-U2 Rev A  
**Issue Date:** 25th September 2013  
**Page:** 7 of 127

## **RECOGNITION**

MiCOM Labs, Inc has widely recognized Electrical testing capabilities. Our international recognition includes Conformity Assessment Body designation by APEC MRA\*\* countries. Our test reports are widely accepted for global type approvals.

<b>Country</b>	<b>Recognition Body</b>	<b>Status</b>	<b>Phase</b>	<b>Identification No.</b>
USA	Federal Communications Commission (FCC)	TCB	-	US0159 Listing #: 102167
Canada	Industry Canada (IC)	FCB	APEC MRA 2	US0159 Listing #: 4143A-2 4143A-3
Japan	MIC (Ministry of Internal Affairs and Communication)	CAB	APEC MRA 2	RCB 210
	VCCI	--	--	A-0012
Europe	European Commission	NB	EU MRA	NB 2280
Australia	Australian Communications and Media Authority (ACMA)	CAB	APEC MRA 1	US0159
Hong Kong	Office of the Telecommunication Authority (OFTA)	CAB	APEC MRA 1	
Korea	Ministry of Information and Communication Radio Research Laboratory (RRL)	CAB	APEC MRA 1	
Singapore	Infocomm Development Authority (IDA)	CAB	APEC MRA 1	
Taiwan	National Communications Commission (NCC) Bureau of Standards, Metrology and Inspection (BSMI)	CAB	APEC MRA 1	
Vietnam	Ministry of Communication (MIC)	CAB	APEC MRA 1	

\*\*APEC MRA – Asia Pacific Economic Community Mutual Recognition Agreement.

Is a recognition agreement under which test lab is accredited to regulatory standards of the APEC member countries.

Phase I - recognition for product testing

Phase II – recognition for both product testing and certification

N/A – Not Applicable

\*\*EU MRA – European Union Mutual Recognition Agreement.

Is a recognition agreement under which test lab is accredited to regulatory standards of the EU member countries.

\*\*NB – Notified Body

This test report may be reproduced in full only. The document may only be updated by MiCOM Labs personnel. Any changes will be noted in the Document History section of the report.

## **PRODUCT CERTIFICATION**

MiCOM Labs, Inc. is an accredited Product Certification Body per the international standard EN ISO/IEC Guide 65. The company is accredited by the American Association for Laboratory Accreditation (A2LA) [www.a2la.org](http://www.a2la.org) test laboratory number 2381.02. MiCOM Labs test schedule is available at the following URL; <http://www.a2la.org/scopepdf/2381-02.pdf>



The American Association for Laboratory Accreditation

"World Class Accreditation"

### *Accredited Product Certification Body*

A2LA has accredited

**MICOM LABS**

*Pleasanton, CA*

for technical competence as a

**Product Certification Body**

This product certification body is accredited in accordance with the recognized International Standard ISO/IEC Guide 65:1996 *General requirements for bodies operating product certification systems*. This accreditation demonstrates technical competence for a defined scope and the operation of a quality management system.

Presented this 27<sup>th</sup> day of March 2012.



President & CEO  
For the Accreditation Council  
Certificate Number 2381.02  
Valid to November 30, 2013

*For the product certification schemes to which this accreditation applies, please refer to the organization's Product Certification Scope of Accreditation*

### **United States of America – Telecommunication Certification Body (TCB)**

TCB Identifier – US0159

### **Industry Canada – Certification Body**

CAB Identifier – US0159

### **Europe – Notified Body**

Notified Body Identifier - 2280

### **Japan – Recognized Certification Body (RCB)**

RCB Identifier - 210

This test report may be reproduced in full only. The document may only be updated by MiCOM Labs personnel. Any changes will be noted in the Document History section of the report.





**Title:** Ear Force i30 Wireless Audio Headset  
**To:** FCC 47 CFR Part 15.247 & IC RSS-210  
**Serial #:** COMM37-U2 Rev A  
**Issue Date:** 25th September 2013  
**Page:** 9 of 127

---

## DOCUMENT HISTORY

Document History		
Revision	Date	Comments
Draft		
Rev A	25 <sup>th</sup> September 2013	Initial release.

---

This test report may be reproduced in full only. The document may only be updated by MiCOM Labs personnel. Any changes will be noted in the Document History section of the report.



**Title:** Ear Force i30 Wireless Audio Headset  
**To:** FCC 47 CFR Part 15.247 & IC RSS-210  
**Serial #:** COMM37-U2 Rev A  
**Issue Date:** 25th September 2013  
**Page:** 10 of 127

## 1. TEST RESULT SUMMARY

Manufacturer:	Voyetra Turtle Beach Inc 100 Summit Lake Drive, Suite 100 Valhalla New York, 10595, USA	Tested By:	MiCOM Labs, Inc. 440 Boulder Court Suite 200 Pleasanton California, 94566, USA
EUT:	Wireless Audio Headset	Telephone:	+1 925 462 0304
Model:	Ear Force i30 (TB300-7010-01)	Fax:	+1 925 462 0306
S/N's:	PP		
Test Date(s):	20th August to 28th August '13	Website:	www.micomlabs.com

STANDARD(S)	TEST RESULTS
FCC 47 CFR Part 15.247 & IC RSS-210	EQUIPMENT COMPLIES

MiCOM Labs, Inc. tested the equipment mentioned in accordance with the requirements set forth in the above standards. Test results indicate that the equipment tested is capable of demonstrating compliance with the requirements as documented within this report.

### Notes:

1. This document reports conditions under which testing was conducted and the results of testing performed.
2. Details of test methods used have been recorded and kept on file by the laboratory.
3. Test results apply only to the item(s) tested.

Approved & Released for MiCOM Labs, Inc. by:



TEST CERTIFICATE #2381.01

  
\_\_\_\_\_  
Graeme Grieve  
Quality Manager MiCOM Labs,

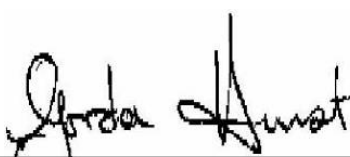
  
\_\_\_\_\_  
Gordon Hurst  
President & CEO MiCOM Labs, Inc.

This test report may be reproduced in full only. The document may only be updated by MiCOM Labs personnel. Any changes will be noted in the Document History section of the report.



**Title:** Ear Force i30 Wireless Audio Headset  
**To:** FCC 47 CFR Part 15.247 & IC RSS-210  
**Serial #:** COMM37-U2 Rev A  
**Issue Date:** 25th September 2013  
**Page:** 11 of 127

## **COMPLIANCE STATEMENT**

Applicant:	Voyetra Turtle Beach Inc 100 Summit Lake Drive, Suite 100 Valhalla, New York, 10595, USA	Tested By:	MiCOM Labs, Inc. 440 Boulder Court Suite 200 Pleasanton California, 94566 USA
Product:	Ear Force i30	Telephone: Fax:	+1 925 462 0304 +1 925 462 0306
Model No.:	Ear Force i30 (TB300-7010-01)	Website:	www.micomlabs.com

### **STANDARD(S)**

FCC 47 CFR Part 15.247 & IC RSS-210

MiCOM Labs attests that the above noted models meet the requirements set forth in the above standard(s) based on testing of samples as noted in the Test Result Summary and the manufacturer's declaration of similarity.

Test results indicate that the equipment tested is capable of demonstrating compliance with the requirements as documented within this report.

#### **Notes:**

1. The different model numbers identified are declared as being electrically identical by the manufacturer.
2. The manufacturer declared that the only difference between the models is cosmetic; the different models are marketed under separate brands.

This test report may be reproduced in full only. The document may only be updated by MiCOM Labs personnel. Any changes will be noted in the Document History section of the report.

## 2. REFERENCES AND MEASUREMENT UNCERTAINTY

### 2.1. Normative References

REF.	PUBLICATION	YEAR	TITLE
i.	FCC 47 CFR Part 15, Subpart C	2012	Title 47: Telecommunication PART 15—RADIO FREQUENCY DEVICES Subpart C—Intentional Radiators
ii.	RSS-210 Annex 8	2010	Radio Standards Specification 210, Issue 8, Low-power Licence-exempt Radiocommunication Devices (All Frequency Bands): Category I Equipment
iii.	FCC OET KDB 662911	4 <sup>th</sup> April 2011	Emissions Testing of Transmitters with Multiple Outputs in the Same Band
iv.	DA 00-705	2000	FCC DA 00-705 "Filing and Measurement Guidelines for Frequency Hopping Spread Spectrum Systems" released March 30, 2000
v.	RSS-GEN	2010	Radio Standards Specification-Gen, Issue 3, General Requirements and Information for the Certification of Radiocommunication Equipment
vi.	FCC 47 CFR Pt 15, Subpart B	2012	47 CFR Part 15, SubPart B; Unintentional Radiators
vii.	ICES-003	2004	Spectrum Management and Telecommunications Policy Interference-Causing Equipment Standard Digital Apparatus; Issue 4
viii.	ANSI C63.4	2009	American National Standards for Methods of Measurement of Radio-Noise Emissions from Low-Voltage Electrical and Electronic Equipment in the Range of 9 kHz to 40 GHz
ix.	CISPR 22/ EN 55022	2008 2006+A1: 2007	Limits and Methods of Measurements of Radio Disturbance Characteristics of Information Technology Equipment
x.	M 3003	Edition 2 Jan. 2007	Expression of Uncertainty and Confidence in Measurements
xi.	LAB34	Edition 1 Aug 2002	The expression of uncertainty in EMC Testing
xii.	ETSI TR 100 028	2001	Parts 1 and 2 Electromagnetic compatibility and Radio Spectrum Matters (ERM); Uncertainties in the measurement of mobile radio equipment characteristics
xiii.	A2LA	July 2012	Reference to A2LA Accreditation Status – A2LA Advertising Policy

This test report may be reproduced in full only. The document may only be updated by MiCOM Labs personnel. Any changes will be noted in the Document History section of the report.



**Title:** Ear Force i30 Wireless Audio Headset  
**To:** FCC 47 CFR Part 15.247 & IC RSS-210  
**Serial #:** COMM37-U2 Rev A  
**Issue Date:** 25th September 2013  
**Page:** 13 of 127

---

## **2.2. Test and Uncertainty Procedures**

Conducted and radiated emission measurements were conducted in accordance with American National Standards Institute ANSI C63.4, listed in the Normative References section of this report.

Measurement uncertainty figures are calculated in accordance with ETSI TR 100 028 Parts 1 and 2.

Measurement uncertainties stated are based on a standard uncertainty multiplied by a coverage factor  $k = 2$ , providing a level of confidence of approximately 95 % in accordance with UKAS document M 3003 listed in the Normative References section of this report.

---

This test report may be reproduced in full only. The document may only be updated by MiCOM Labs personnel. Any changes will be noted in the Document History section of the report.



**Title:** Ear Force i30 Wireless Audio Headset  
**To:** FCC 47 CFR Part 15.247 & IC RSS-210  
**Serial #:** COMM37-U2 Rev A  
**Issue Date:** 25th September 2013  
**Page:** 14 of 127

### 3. PRODUCT DETAILS AND TEST CONFIGURATIONS

#### 3.1. Technical Details

Details	Description
Purpose:	Test of the Ear Force i30 Wireless Audio Headset to FCC Part 15.247 and Industry Canada RSS-210 regulations.
Applicant:	Voyetra Turtle Beach Inc 100 Summit Lake Drive, Suite 100 Valhalla New York, 10595, USA
Manufacturer:	As applicant.
Laboratory performing the tests:	MiCOM Labs, Inc. 440 Boulder Court, Suite 200 Pleasanton, California 94566 USA
Test report reference number:	COMM37-U2 Rev A
Date EUT received:	20 <sup>th</sup> August 2013
Standard(s) applied:	FCC 47 CFR Part 15.247 & IC RSS-210
Dates of test (from - to):	20th August to 28th August '13
No of Units Tested:	Two
Type of Equipment:	Wireless Audio Headset
Manufacturers Trade Name:	Ear Force
Model(s):	Ear Force i30 (TB300-7010-01)
Location for use:	Indoor
Declared Frequency Range(s):	2400 - 2483.5 MHz
Hardware Rev	PP
Software Rev	PP
Rated Input Voltage and Current:	3.7 Vdc (Battery)
Operating Temperature Range:	Declared range 0° to +50°C at 95% humidity non condensing
Equipment Dimensions:	9 x 6 x 3.5 inches
Weight:	7 oz
Primary function of equipment:	Wireless Audio Headset

This test report may be reproduced in full only. The document may only be updated by MiCOM Labs personnel. Any changes will be noted in the Document History section of the report.

### 3.2. Scope of Test Program

#### Ear Force i30 Wireless Audio Headset RF Testing

The scope of the test program was to test the Ear Force i30 Wireless Audio Headset , in the frequency ranges 2400 - 2483.5 MHz for compliance against FCC 47 CFR Part 15.247 and Industry Canada RSS-210 specifications.

#### Ear Force i30 Wireless Audio Headset



---

This test report may be reproduced in full only. The document may only be updated by MiCOM Labs personnel. Any changes will be noted in the Document History section of the report.

### Ear Force i30 Wireless Audio Headset



---

This test report may be reproduced in full only. The document may only be updated by MiCOM Labs personnel. Any changes will be noted in the Document History section of the report.



**Ear Force i30 Wireless Audio Headset – Audio PCB Top/Bottom**

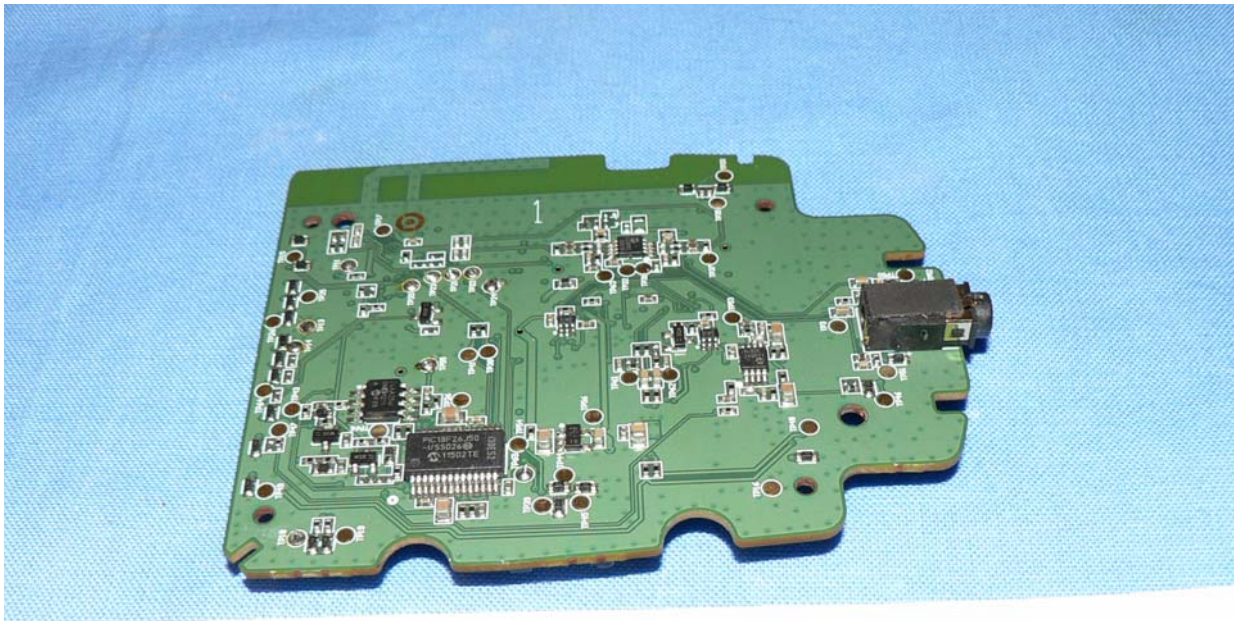
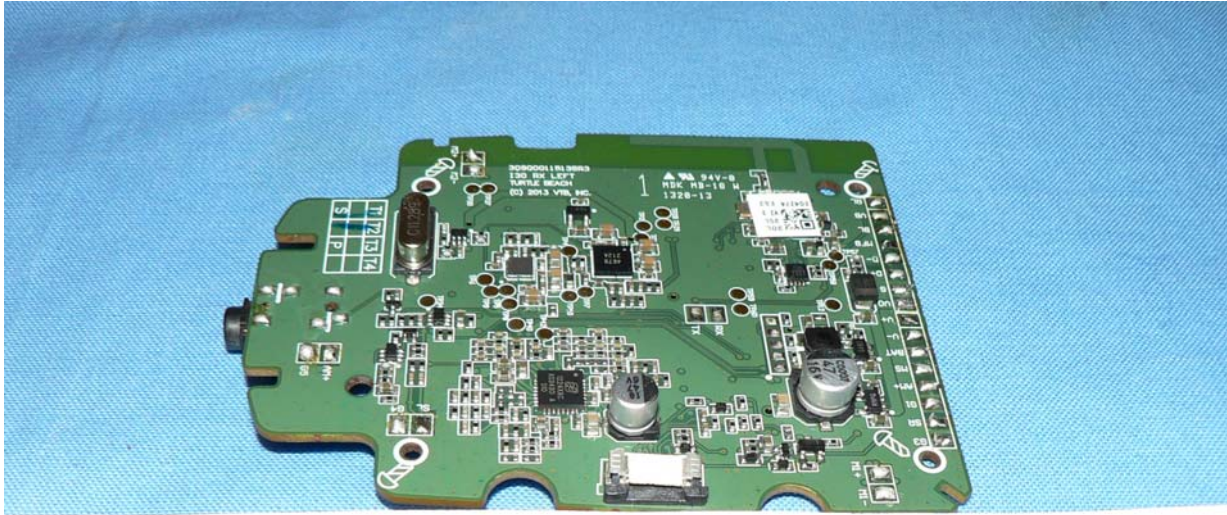

---

This test report may be reproduced in full only. The document may only be updated by MiCOM Labs personnel. Any changes will be noted in the Document History section of the report.

### Ear Force i30 Wireless Audio Headset – Battery



---

This test report may be reproduced in full only. The document may only be updated by MiCOM Labs personnel. Any changes will be noted in the Document History section of the report.



**Title:** Ear Force i30 Wireless Audio Headset  
**To:** FCC 47 CFR Part 15.247 & IC RSS-210  
**Serial #:** COMM37-U2 Rev A  
**Issue Date:** 25th September 2013  
**Page:** 19 of 127

### 3.3. Equipment Model(s) and Serial Number(s)

Equipment Type	Equipment Description (Including Brand Name)	Mfr	Model No.	Serial No.
EUT	Wireless Audio Headset	Voyetra Turtle Beach	Ear Force i30	PP
Support	Laptop PC	Apple	MacBook Air	None

### 3.4. Antenna Details

Antenna Type	Manufacturer	Model Number	Antenna Gain (dBi)	
			2.4 GHz	5 GHz
On Board Folded F - Bluetooth	Turtle Beach	PCB	2.8	--
Chip	Fractus	FR05-S1-NO-1-004	-1.5	--
Chip	Fractus	FR05-S1-NO-1-004	--	3.3

### 3.5. Cabling and I/O Ports

Number and type of I/O ports

1. 1 x USB (charge only)
2. 1 x 3.5 mm Analog Audio Input

This test report may be reproduced in full only. The document may only be updated by MiCOM Labs personnel. Any changes will be noted in the Document History section of the report.



**Title:** Ear Force i30 Wireless Audio Headset  
**To:** FCC 47 CFR Part 15.247 & IC RSS-210  
**Serial #:** COMM37-U2 Rev A  
**Issue Date:** 25th September 2013  
**Page:** 20 of 127

---

### 3.6. Types of Modulation Supported

Operational Mode(s) (802.15.2)	Packet type	Data Rate (Mbits/s)	Frequencies (MHz)
FHSS: GFSK $\pi/4$ DQPSK 8DPSK	DH1	1, 2, 3	2,402
	DH3	1, 2, 3	2,441
	DH5	1, 2, 3	2,480

### 3.7. EUT Configurations

Band (GHz)	Mode	Freq Band (MHz)	Freq Range (MHz)	Low Ch.	Mid Ch.	High Ch.	# Ch.	Ch. Spacing (MHz)
2.4	Bluetooth	2400-2483.5	2402-2480	2402	2441	2480	79	1 MHz

### 3.8. Equipment Modifications

None.

### 3.9. Deviations from the Test Standard

The following deviations from the test standard were required in order to complete the test program:

1. NONE

---

This test report may be reproduced in full only. The document may only be updated by MiCOM Labs personnel. Any changes will be noted in the Document History section of the report.

## 4. TEST EQUIPMENT CONFIGURATION(S)

### 4.1. Conducted RF Emission Test Set-up

The following tests were performed using the conducted test set-up shown in the diagram below.

1. Section 6.1.1.1. 20 dB Bandwidth
2. Section 6.1.1.2. Carrier Frequency Separation
3. Section 6.1.1.3. Number of Hopping Frequencies
4. Section 6.1.1.4. Time of Occupancy (Dwell Time)
5. Section 6.1.1.5 Channel Occupancy
6. Section 6.1.1.5 Peak Output Power
7. Section 6.1.1.7 Band-Edge
8. Section 6.1.1.8 Spurious RF Conducted – Transmitter
9. Section 6.1.1.9 Spurious RF Conducted - Receiver

#### Conducted Test Set-Up Pictorial Representation

##### Test Measurement set up

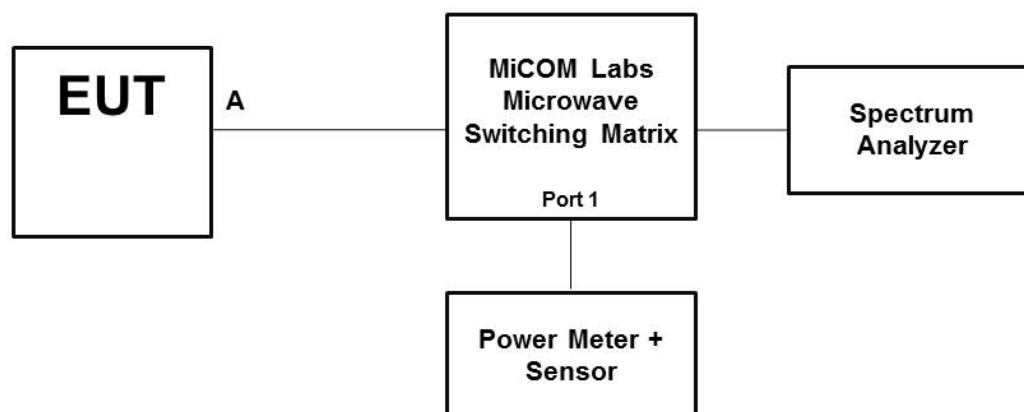

**Conducted Test Measurement Setup**

#### 4.2. Radiated Spurious Emission Test Set-up > 1 GHz

The following tests were performed using the conducted test set-up shown in the diagram below.

1. Section 6.1.2.1.

#### Radiated Emission Measurement Setup – Above 1 GHz

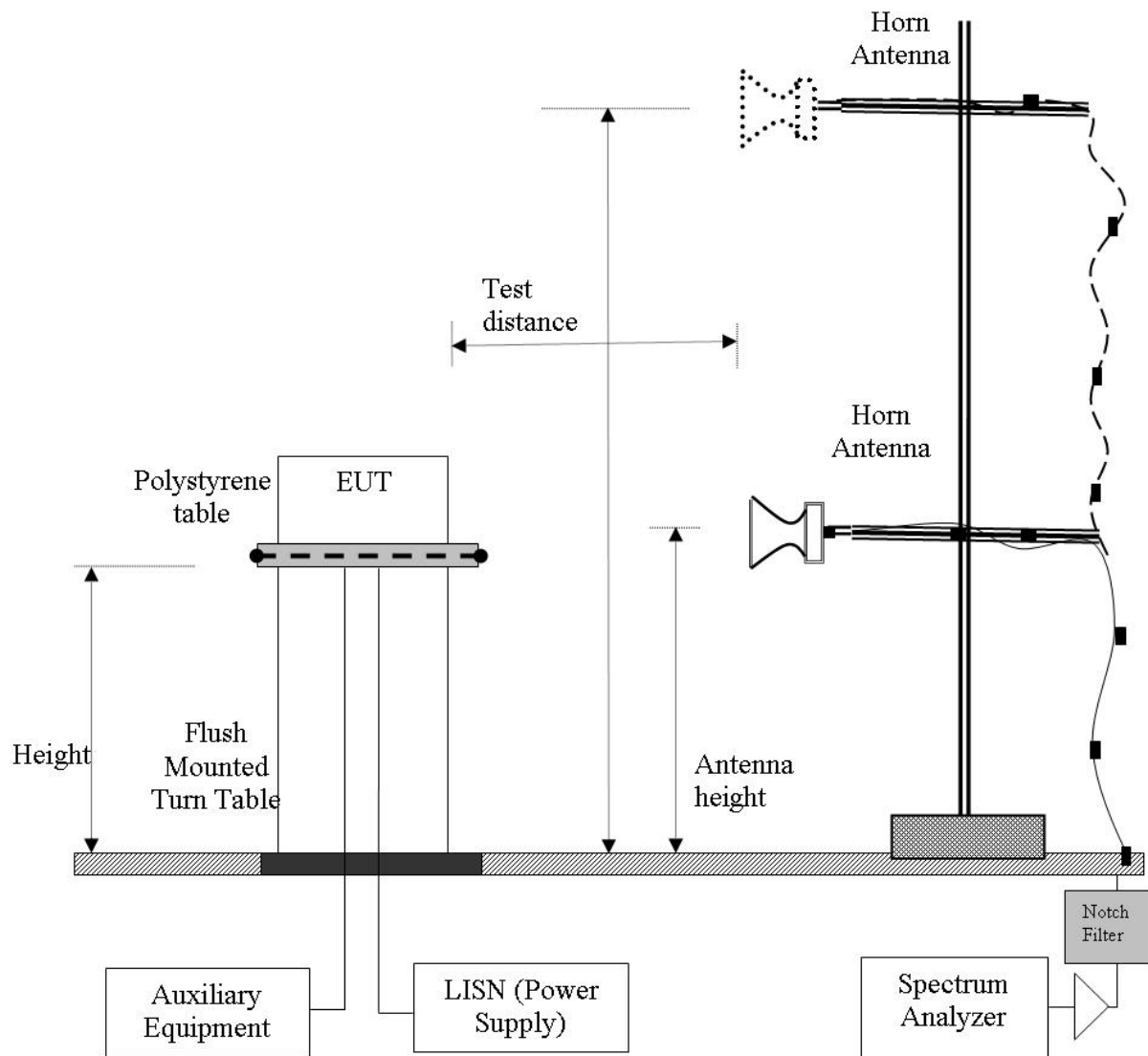

This test report may be reproduced in full only. The document may only be updated by MiCOM Labs personnel. Any changes will be noted in the Document History section of the report.

#### 4.3. Digital Emissions Test Set-up (0.03 – 1 GHz)

The following tests were performed using the conducted test set-up shown in the diagram below.

1. Section 6.1.2.2.

#### Digital Emission Measurement Setup – Below 1 GHz

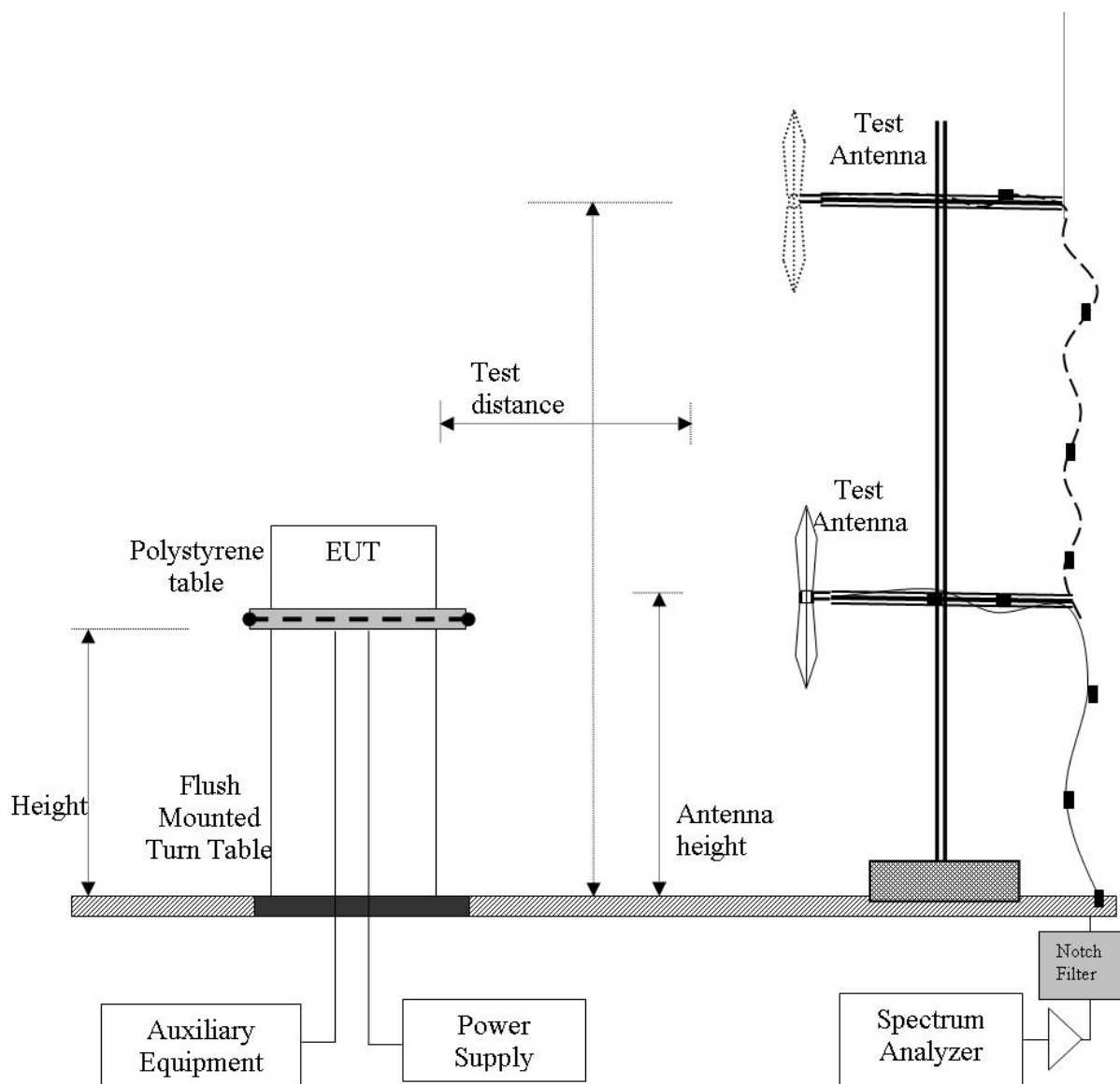

This test report may be reproduced in full only. The document may only be updated by MiCOM Labs personnel. Any changes will be noted in the Document History section of the report.

#### 4.4. AC Wireline Emission Test Set-up

The following tests were performed using the conducted test set-up shown in the diagram below.

Not Required EUT not powered by AC.

1. Section 6.1.3 AC Wireline Conducted Emissions

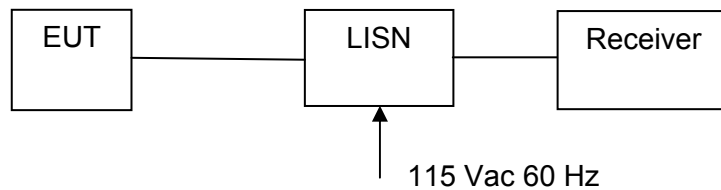

**Measurement Setup for Conducted Emissions Test**





**Title:** Ear Force i30 Wireless Audio Headset  
**To:** FCC 47 CFR Part 15.247 & IC RSS-210  
**Serial #:** COMM37-U2 Rev A  
**Issue Date:** 25th September 2013  
**Page:** 25 of 127

## 5. TEST SUMMARY

### List of Measurements

The following table represents the list of measurements required under the **FCC CFR47 Part 15.247** and **Industry Canada RSS-210** and **Industry Canada RSS-Gen.**

Note: as this is an Enhanced Data Rate (EDR) Bluetooth Device.

Section(s)	Test Items / Description	Condition	Result	Test Report Section
15.247(a)(1) A8.1(a) 4.4	20 dB Bandwidths	Conducted	Complies	6.1.1.1
15.247(a)(1) A8.1(d)	Carrier Frequency Separation	Conducted	Complies	6.1.1.2
15.247(a)(1) A8.1(d)	Number of Hopping Frequencies	Conducted	Complies	6.1.1.3
15.247(a)(1)(iii) A8.1(d)	Time of Occupany (Dwell Time)	Conducted	Complies	6.1.1.4
15.247(a)(1)(iii) A8.1(d)	Channel Occupancy	Conducted	Complies	6.1.1.5
15.247(b)(2) A8.4(2)	Peak Output Power	Conducted	Complies	6.1.1.6
15.247(d) A8.5	Spurious RF Conducted Emissions	Conducted	Complies	6.1.1.7

This test report may be reproduced in full only. The document may only be updated by MiCOM Labs personnel. Any changes will be noted in the Document History section of the report.



**Title:** Ear Force i30 Wireless Audio Headset  
**To:** FCC 47 CFR Part 15.247 & IC RSS-210  
**Serial #:** COMM37-U2 Rev A  
**Issue Date:** 25th September 2013  
**Page:** 26 of 127

### List of Measurements (continued)

The following table represents the list of measurements required under the **FCC CFR47 Part 15.247**, **Industry Canada RSS-210**, and **Industry Canada RSS-Gen**.

Section(s)	Test Items	Description	Condition	Result	Test Report Section
15.247(d) 15.205 / 15.209 A8.5 2.2 2.6 4.7	Transmitter Radiated Spurious Emissions	Emissions above 1 GHz	Radiated	Complies	6.1.2.1
	Radiated Band Edge	Band-edge results	Radiated	Complies	
15.205 / 15.209 2.2	Radiated Spurious Emissions	Emissions <1 GHz (30M- 1 GHz)	Radiated	Complies	6.1.2.2
15.207 7.2.2	AC Wireline Conducted Emissions 150 kHz– 30 MHz	Conducted Emissions	Conducted	N/A EUT is DC powered	6.1.3

**Note 1:** Test results reported in this document relate only to the items tested

**Note 2:** The required tests demonstrated compliance as per client declaration of test configuration, monitoring methodology and associated pass/fail criteria

**Note 3:** Section 3.8 Equipment Modifications highlights the equipment modifications that were required to bring the product into compliance with the above test matrix

This test report may be reproduced in full only. The document may only be updated by MiCOM Labs personnel. Any changes will be noted in the Document History section of the report.



**Title:** Ear Force i30 Wireless Audio Headset  
**To:** FCC 47 CFR Part 15.247 & IC RSS-210  
**Serial #:** COMM37-U2 Rev A  
**Issue Date:** 25th September 2013  
**Page:** 27 of 127

## 6. TEST RESULTS

### 6.1. Device Characteristics

#### 6.1.1. Conducted Testing

##### 6.1.1.1. 20 dB Bandwidth

Conducted Test Conditions for 20 dB Bandwidth			
<b>Standard:</b>	FCC CFR 47:15.247	<b>Ambient Temp. (°C):</b>	18.0 - 27.5
<b>Test Heading:</b>	20 dB Bandwidth	<b>Rel. Humidity (%):</b>	32 - 45
<b>Standard Section(s):</b>	15.247 (a)(2)	<b>Pressure (mBars):</b>	999 - 1001
<b>Reference Document(s):</b>	FCC DA 00-705 "Filing and Measurement Guidelines for Frequency Hopping Spread Spectrum Systems"		
<b>Test Procedure for 20 dB Bandwidth Measurement</b> The bandwidth at 20 dB was measured with a spectrum analyzer connected to the antenna terminal, while EUT is operating in transmission mode at the appropriate centre frequency. Although there are no limits for 20 dB bandwidth for frequency hopping systems in the 2400-2483.5 MHz band. The 20 dB bandwidth is required to calculate the carrier frequency separation limits.			

The EUT was tested at the lowest and highest data rate available (1-3 Mbits/s) for each packet type DH1, DH5.

This test report may be reproduced in full only. The document may only be updated by MiCOM Labs personnel. Any changes will be noted in the Document History section of the report.



**Title:** Ear Force i30 Wireless Audio Headset  
**To:** FCC 47 CFR Part 15.247 & IC RSS-210  
**Serial #:** COMM37-U2 Rev A  
**Issue Date:** 25th September 2013  
**Page:** 28 of 127

### DH1, 1 Mbs/sec

#### Equipment Configuration for 6 dB & 99% Bandwidth

<b>Variant:</b>	802.15 DH1	<b>Duty Cycle (%):</b>	100
<b>Data Rate:</b>	DH1	<b>Antenna Gain (dBi):</b>	Not Applicable
<b>Modulation:</b>	GFSK	<b>Beam Forming Gain (Y):</b>	Not Applicable
<b>TPC:</b>	Not Applicable	<b>Tested By:</b>	JMH
<b>Engineering Test Notes:</b>			

#### Test Measurement Results

Test Frequency MHz	Measured 20 dB Bandwidth (MHz)				Maximum 20 dB Bandwidth (MHz)		
	Port(s)						
	a	b	c	d			
2402.0	<a href="#">0.842</a>				0.842		
2441.0	<a href="#">0.836</a>				0.836		
2480.0	<a href="#">0.836</a>				0.836		

Traceability to Industry Recognized Test Methodologies	
Work Instruction:	WI-03 MEASURING RF SPECTRUM MASK
Measurement Uncertainty:	±2.81 dB

Note: [click the link in the above results matrix to view the plot](#)

This test report may be reproduced in full only. The document may only be updated by MiCOM Labs personnel. Any changes will be noted in the Document History section of the report.



**Title:** Ear Force i30 Wireless Audio Headset  
**To:** FCC 47 CFR Part 15.247 & IC RSS-210  
**Serial #:** COMM37-U2 Rev A  
**Issue Date:** 25th September 2013  
**Page:** 29 of 127

**DH5, 1 Mbs/sec**

**Equipment Configuration for 6 dB & 99% Bandwidth**

<b>Variant:</b>	802.15 DH5	<b>Duty Cycle (%):</b>	100
<b>Data Rate:</b>	DH5	<b>Antenna Gain (dBi):</b>	Not Applicable
<b>Modulation:</b>	GFSK	<b>Beam Forming Gain (Y):</b>	Not Applicable
<b>TPC:</b>	Not Applicable	<b>Tested By:</b>	JMH
<b>Engineering Test Notes:</b>			

**Test Measurement Results**

Test Frequency	Measured 20 dB Bandwidth (MHz)				Maximum 20 dB Bandwidth (MHz)		
	Port(s)						
MHz	a	b	c	d			
2402.0	<a href="#">0.860</a>				0.860		
2441.0	<a href="#">0.860</a>				0.860		
2480.0	<a href="#">0.860</a>				0.860		

<b>Traceability to Industry Recognized Test Methodologies</b>	
Work Instruction:	WI-03 MEASURING RF SPECTRUM MASK
Measurement Uncertainty:	±2.81 dB

Note: [click the link in the above results matrix to view the plot](#)

This test report may be reproduced in full only. The document may only be updated by MiCOM Labs personnel. Any changes will be noted in the Document History section of the report.



**Title:** Ear Force i30 Wireless Audio Headset  
**To:** FCC 47 CFR Part 15.247 & IC RSS-210  
**Serial #:** COMM37-U2 Rev A  
**Issue Date:** 25th September 2013  
**Page:** 30 of 127

### 3-DH1, 3 Mbs/sec

#### Equipment Configuration for 6 dB & 99% Bandwidth

<b>Variant:</b>	802.15 3-DH1	<b>Duty Cycle (%):</b>	100
<b>Data Rate:</b>	3-DH1	<b>Antenna Gain (dBi):</b>	Not Applicable
<b>Modulation:</b>	8DPSK	<b>Beam Forming Gain (Y):</b>	Not Applicable
<b>TPC:</b>	Not Applicable	<b>Tested By:</b>	JMH
<b>Engineering Test Notes:</b>			

#### Test Measurement Results

Test Frequency MHz	Measured 20 dB Bandwidth (MHz)				Maximum 20 dB Bandwidth (MHz)		
	Port(s)						
	a	b	c	d			
2402.0	<a href="#">1.154</a>				1.154		
2441.0	<a href="#">1.142</a>				1.142		
2480.0	<a href="#">1.142</a>				1.142		

#### Traceability to Industry Recognized Test Methodologies

Work Instruction:	WI-03 MEASURING RF SPECTRUM MASK
Measurement Uncertainty:	±2.81 dB

Note: [click the link in the above results matrix to view the plot](#)

This test report may be reproduced in full only. The document may only be updated by MiCOM Labs personnel. Any changes will be noted in the Document History section of the report.



**Title:** Ear Force i30 Wireless Audio Headset  
**To:** FCC 47 CFR Part 15.247 & IC RSS-210  
**Serial #:** COMM37-U2 Rev A  
**Issue Date:** 25th September 2013  
**Page:** 31 of 127

### 3-DH5, 3 Mbs/sec

#### Equipment Configuration for 6 dB & 99% Bandwidth

<b>Variant:</b>	802	<b>Duty Cycle (%):</b>	100
<b>Data Rate:</b>	3-DH5	<b>Antenna Gain (dBi):</b>	Not Applicable
<b>Modulation:</b>	8-DPSK	<b>Beam Forming Gain (Y):</b>	Not Applicable
<b>TPC:</b>	Not Applicable	<b>Tested By:</b>	JMH
<b>Engineering Test Notes:</b>			

#### Test Measurement Results

Test Frequency	Measured 99% Bandwidth (MHz)				Maximum 20 dB Bandwidth (MHz)		
	Port(s)						
MHz	a	b	c	d			
2402.0	<a href="#">1.154</a>				1.154		
2441.0	<a href="#">1.160</a>				1.160		
2480.0	<a href="#">1.160</a>				1.160		

#### Traceability to Industry Recognized Test Methodologies

Work Instruction:	WI-03 MEASURING RF SPECTRUM MASK
Measurement Uncertainty:	±2.81 dB

Note: click the link in the above results matrix to view the plot

This test report may be reproduced in full only. The document may only be updated by MiCOM Labs personnel. Any changes will be noted in the Document History section of the report.



**Title:** Ear Force i30 Wireless Audio Headset  
**To:** FCC 47 CFR Part 15.247 & IC RSS-210  
**Serial #:** COMM37-U2 Rev A  
**Issue Date:** 25th September 2013  
**Page:** 32 of 127

## Specification

### Limits

#### §15.247 (a)

(1) Frequency hopping systems shall have hopping channel carrier frequencies separated by a minimum of 25 kHz or the 20 dB bandwidth of the hopping channel, whichever is greater. Alternatively, frequency hopping systems operating in the 2400-2483.5 MHz band may have hopping channel carrier frequencies that are separated by 25 kHz or two-thirds of the 20 dB bandwidth of the hopping channel, whichever is greater, provided the systems operate with an output power no greater than 125 mW. The system shall hop to channel frequencies that are selected at the system hopping rate from a pseudo randomly ordered list of hopping frequencies. Each frequency must be used equally on the average by each transmitter. The system receivers shall have input bandwidths that match the hopping channel bandwidths of their corresponding transmitters and shall shift frequencies in synchronization with the transmitted signals

#### RSS-210 §A8.1

a. The bandwidth of a frequency hopping channel is the -20 dB emission bandwidth, measured with the hopping stopped. The system radio frequency (RF) bandwidth is equal to the channel bandwidth multiplied by the number of channels in the hopset. The hopset shall be such that the near-term distribution of frequencies appears random, with sequential hops randomly distributed in both direction and magnitude of change in the hopset, while the long-term distribution appears evenly distributed.

b. Frequency hopping systems shall have hopping channel carrier frequencies separated by a minimum of 25 kHz or the -20 dB bandwidth of the hopping channel, whichever is greater. Alternatively, frequency hopping systems operating in the band 2400–2483.5 MHz may have hopping channel carrier frequencies that are separated by 25 kHz or two-thirds of the -20 dB bandwidth of the hopping channel, whichever is greater, provided that the systems operate with an output power no greater than 0.125 W. The system receivers shall have input bandwidths that match the hopping channel bandwidths of their corresponding transmitters and shall shift frequencies in synchronization with the transmitted signals.

## Traceability

### Test Equipment Used

0158, 0287, 0252, 0313, 0314, 0070, 0116, 0117

This test report may be reproduced in full only. The document may only be updated by MiCOM Labs personnel. Any changes will be noted in the Document History section of the report.





**Title:** Ear Force i30 Wireless Audio Headset  
**To:** FCC 47 CFR Part 15.247 & IC RSS-210  
**Serial #:** COMM37-U2 Rev A  
**Issue Date:** 25th September 2013  
**Page:** 33 of 127

---

### 6.1.1.2. Carrier Frequency Separation

Conducted Test Conditions for Carrier Frequency Separation			
<b>Standard:</b>	FCC CFR 47:15.247	<b>Ambient Temp. (°C):</b>	18.0 – 24.0
<b>Test Heading:</b>	Carrier Frequency Separation	<b>Rel. Humidity (%):</b>	32 - 45
<b>Standard Section(s):</b>	15.247 (a)(1)	<b>Pressure (mBars):</b>	999 - 1004
<b>Reference Document(s):</b>	FCC DA 00-705 "Filing and Measurement Guidelines for Frequency Hopping Spread Spectrum Systems"		
<b>Test Procedure for Carrier Frequency Separation Measurement</b> The EUT must have its hopping function enabled. The transmitter terminal of EUT was connected to the input of the spectrum analyzer set to measure carrier frequency separation. The Span was set wide enough to capture two adjacent peaks. The resolution bandwidth (RBW) was set to $\geq 1\%$ of the span, video bandwidth (VBW) $\geq$ RBW, peak detector selected and max hold trace selected. After the trace is stabilized use marker delta function to determine the separation between adjacent channels. The limit is $> 2/3$ of the 20 dB bandwidth.			

---

This test report may be reproduced in full only. The document may only be updated by MiCOM Labs personnel. Any changes will be noted in the Document History section of the report.



**Title:** Ear Force i30 Wireless Audio Headset  
**To:** FCC 47 CFR Part 15.247 & IC RSS-210  
**Serial #:** COMM37-U2 Rev A  
**Issue Date:** 25th September 2013  
**Page:** 34 of 127

#### Equipment Configuration for Carrier Frequency Separation

<b>Variant:</b>	802.15.2	<b>Duty Cycle (%):</b>	100%
<b>Data Rate:</b>	1-3 Mbit/s	<b>Antenna Gain (dBi):</b>	2.8
<b>Modulation:</b>	GFSK, $\pi/4$ DQPSK, 8DPSK	<b>Beam Forming Gain (Y):</b>	Not Applicable
<b>TPC:</b>	N/A		
<b>Engineering Test Notes:</b>	all 3 supported modes were measured		

#### Test Measurement Results

Centered on Channel	Center Frequency	Packet Type	Chan Separation	Maximum 20 dB Bandwidth	Limit	Result
	MHz		MHz	MHz	MHz	
39	2441	DH1	<a href="#">1.022</a>	0.842	> 1 MHz	Pass
39	2441	DH3	<a href="#">1.034</a>	0.845	> 1 MHz	Pass
39	2441	DH5	<a href="#">1.046</a>	0.859	> 1 MHz	Pass
39	2441	2-DH1	<a href="#">1.022</a>	1.004	> 1 MHz	Pass
39	2441	2-DH5	<a href="#">1.016</a>	1.002	> 1 MHz	Pass
39	2441	3-DH1	<a href="#">1.010</a>	1.142	> 1 MHz	Pass
39	2441	3-DH5	<a href="#">1.016</a>	1.160	> 1 MHz	Pass

#### Traceability to Industry Recognized Test Methodologies

Measurement Uncertainty: $\pm 2.81$ dB (Spectrum/Amplitude), $\pm 0.86$ ppm (Frequency)
---

Note: click the link in the above results matrix to view the plot

This test report may be reproduced in full only. The document may only be updated by MiCOM Labs personnel. Any changes will be noted in the Document History section of the report.



**Title:** Ear Force i30 Wireless Audio Headset  
**To:** FCC 47 CFR Part 15.247 & IC RSS-210  
**Serial #:** COMM37-U2 Rev A  
**Issue Date:** 25th September 2013  
**Page:** 35 of 127

## Specification

### Limits

**§15.247 (a)** Operation under the provisions of this Section is limited to frequency hopping and digitally modulated intentional radiators that comply with the following provisions:

(1) Frequency hopping systems shall have hopping channel carrier frequencies separated by a minimum of 25 kHz or the 20 dB bandwidth of the hopping channel, whichever is greater. Alternatively, frequency hopping systems operating in the 2400–2483.5 MHz band may have hopping channel carrier frequencies that are separated by 25 kHz or two-thirds of the 20 dB bandwidth of the hopping channel, whichever is greater, provided the systems operate with an output power no greater than 125 mW. The system shall hop to channel frequencies that are selected at the system hopping rate from a pseudo randomly ordered list of hopping frequencies. Each frequency must be used equally on the average by each transmitter. The system receivers shall have input bandwidths that match the hopping channel bandwidths of their corresponding transmitters and shall shift frequencies in synchronization with the transmitted signals.

### RSS-210 §A8.1

b. Frequency hopping systems shall have hopping channel carrier frequencies separated by a minimum of 25 kHz or the -20 dB bandwidth of the hopping channel, whichever is greater. Alternatively, frequency hopping systems operating in the band 2400–2483.5 MHz may have hopping channel carrier frequencies that are separated by 25 kHz or two-thirds of the -20 dB bandwidth of the hopping channel, whichever is greater, provided that the systems operate with an output power no greater than 0.125 W. The system receivers shall have input bandwidths that match the hopping channel bandwidths of their corresponding transmitters and shall shift frequencies in synchronization with the transmitted signals.

## Traceability

### Test Equipment Used

0158, 0287, 0252, 0313, 0314, 0070, 0116, 0117

This test report may be reproduced in full only. The document may only be updated by MiCOM Labs personnel. Any changes will be noted in the Document History section of the report.



**Title:** Ear Force i30 Wireless Audio Headset  
**To:** FCC 47 CFR Part 15.247 & IC RSS-210  
**Serial #:** COMM37-U2 Rev A  
**Issue Date:** 25th September 2013  
**Page:** 36 of 127

---

### 6.1.1.3. Number of Hopping Frequencies

Conducted Test Conditions for Number of Hopping Frequencies			
<b>Standard:</b>	FCC CFR 47:15.247	<b>Ambient Temp. (°C):</b>	18.0 - 27.5
<b>Test Heading:</b>	Carrier Hopping Frequencies	<b>Rel. Humidity (%):</b>	32 - 45
<b>Standard Section(s):</b>	15.247 (a)	<b>Pressure (mBars):</b>	999 - 1008
<b>Reference Document(s):</b>	FCC DA 00-705 "Filing and Measurement Guidelines for Frequency Hopping Spread Spectrum Systems"		
<b>Test Procedure for Number of Hopping Frequencies</b> The EUT must have its hopping function Enabled The transmitter output was connected to a spectrum analyzer and the span was set for the frequency of operation (Note 2 or more spans may be necessary for an accurate count). RBW ≥ 1% of the span, VBW ≥ RBW, Sweep = auto, detector function = peak, trace = max hold. Allow trace to stabilize. It may prove necessary to break the span up into sections to clearly show the hopping frequencies.			

---

This test report may be reproduced in full only. The document may only be updated by MiCOM Labs personnel. Any changes will be noted in the Document History section of the report.



**Title:** Ear Force i30 Wireless Audio Headset  
**To:** FCC 47 CFR Part 15.247 & IC RSS-210  
**Serial #:** COMM37-U2 Rev A  
**Issue Date:** 25th September 2013  
**Page:** 37 of 127

**Equipment Configuration for Hopping Sequence**

<b>Variant:</b>	802.15.2	<b>Duty Cycle (%):</b>	100%
<b>Data Rate:</b>	1-3 Mbit/s	<b>Antenna Gain (dBi):</b>	2.8
<b>Modulation:</b>	GFSK,π/4 DQPSK, 8DPSK	<b>Beam Forming Gain (Y):</b>	Not Applicable
<b>TPC:</b>	N/A		
<b>Engineering Test Notes:</b>			

**Test Measurement Results**

Test Frequency	Number of Hopping Frequencies				Limit	Result
	Port(s)					
MHz	a	b	c	d	No of Hopping Channels	
NA	79	--	--	--	≥ 20	Pass

**Traceability to Industry Recognized Test Methodologies**

Work Instruction:	WI-03 MEASURING RF SPECTRUM MASK
Measurement Uncertainty:	±2.81 dB

Note: click the link in the above results matrix to view the plot

This test report may be reproduced in full only. The document may only be updated by MiCOM Labs personnel. Any changes will be noted in the Document History section of the report.



**Title:** Ear Force i30 Wireless Audio Headset  
**To:** FCC 47 CFR Part 15.247 & IC RSS-210  
**Serial #:** COMM37-U2 Rev A  
**Issue Date:** 25th September 2013  
**Page:** 38 of 127

---

**Specification**  
**Number of Hopping Frequencies**

**§15.247(a)(1)(iii)** Frequency hopping systems in the 2400–2483.5 MHz band shall use at least 15 channels. The average time of occupancy on any channel shall not be greater than 0.4 seconds within a period of 0.4 seconds multiplied by the number of hopping channels employed. Frequency hopping systems may avoid or suppress transmissions on a particular hopping frequency provided that a minimum of 15 channels are used.

**RSS-210 §A8.1 (d)** Frequency hopping systems operating in the 2400–2483.5 MHz band shall use at least 15 hopping channels. The average time of occupancy on any channel shall not be greater than 0.4 seconds within a period of 0.4 seconds, multiplied by the number of hopping channels employed. Transmissions on particular frequencies may be avoided or suppressed provided that a minimum of 15 hopping channels are used.

**Traceability**

Method	Test Equipment Used
FCC DA 00-175	0078, 0134, 0158, 0184, 0193, 0287, 0250, 0252, 0310, 0312

---

This test report may be reproduced in full only. The document may only be updated by MiCOM Labs personnel. Any changes will be noted in the Document History section of the report.



**Title:** Ear Force i30 Wireless Audio Headset  
**To:** FCC 47 CFR Part 15.247 & IC RSS-210  
**Serial #:** COMM37-U2 Rev A  
**Issue Date:** 25th September 2013  
**Page:** 39 of 127

---

#### 6.1.1.4. Time of Occupancy (Dwell Time)

Conducted Test Conditions for Time of Occupancy (Dwell Time)			
<b>Standard:</b>	FCC CFR 47:15.247	<b>Ambient Temp. (°C):</b>	24.0 - 27.5
<b>Test Heading:</b>	Time of Occupancy (Dwell Time)	<b>Rel. Humidity (%):</b>	32 - 45
<b>Standard Section(s):</b>	15.247 (a)	<b>Pressure (mBars):</b>	999 - 1001
<b>Reference Document(s):</b>	FCC DA 00-705 "Filing and Measurement Guidelines for Frequency Hopping Spread Spectrum Systems"		
<b>Test Procedure for Time of Occupancy (Dwell Time)</b> The EUT must have its hopping function Enabled The transmitter output was connected to a spectrum analyzer and the span was set for the frequency of operation. RBW = 1 MHz, VBW ≥ RBW, Sweep = as necessary to capture the entire dwell time period, detector function = peak, trace = max hold. If possible use the marker-delta function to determine the dwell time. If this value varies with different modes of operation (e.g., data rate, modulation format, etc.), repeat this test for each variation.			

---

This test report may be reproduced in full only. The document may only be updated by MiCOM Labs personnel. Any changes will be noted in the Document History section of the report.



**Title:** Ear Force i30 Wireless Audio Headset  
**To:** FCC 47 CFR Part 15.247 & IC RSS-210  
**Serial #:** COMM37-U2 Rev A  
**Issue Date:** 25th September 2013  
**Page:** 40 of 127

**Equipment Configuration for Time of Occupancy (Dwell Time)**

<b>Variant:</b>	802.15.2	<b>Duty Cycle (%):</b>	100%
<b>Data Rate:</b>	1-3 Mbit/s	<b>Antenna Gain (dBi):</b>	2.8
<b>Modulation:</b>	GFSK, $\pi/4$ DQPSK, 8DPSK	<b>Beam Forming Gain (Y):</b>	Not Applicable
<b>TPC:</b>	N/A		
<b>Engineering Test Notes:</b>			

**Test Measurement Results**

Centered on Channel	Center Frequency	Packet Type	Dwell Time (Single Channel)	Limit (Single Channel)	Result
	MHz		mS	mS	
0	2402	DH1	<a href="#">0.385</a>	400	Pass
0	2402	DH3	<a href="#">1.62</a>	400	Pass
0	2402	DH5	<a href="#">2.895</a>	400	Pass
0	2402	2-DH1	<a href="#">0.399</a>	400	Pass
0	2402	2-DH3	<a href="#">1.623</a>	400	Pass
0	2402	2-DH5	<a href="#">2.870</a>	400	Pass
0	2402	3-DH1	<a href="#">0.389</a>	400	Pass
0	2402	3-DH3	<a href="#">1.611</a>	400	Pass
0	2402	3-DH5	<a href="#">2.830</a>	400	Pass

**Traceability to Industry Recognized Test Methodologies**

Measurement Uncertainty:	$\pm 2.81$ dB (Spectrum/Amplitude), $\pm 0.86$ ppm (Frequency)
--------------------------	--

Note: click the link in the above results matrix to view the plot

This test report may be reproduced in full only. The document may only be updated by MiCOM Labs personnel. Any changes will be noted in the Document History section of the report.





**Title:** Ear Force i30 Wireless Audio Headset  
**To:** FCC 47 CFR Part 15.247 & IC RSS-210  
**Serial #:** COMM37-U2 Rev A  
**Issue Date:** 25th September 2013  
**Page:** 41 of 127

---

## Specification

### Limits Channel Occupancy (Dwell Time)

**§15.247(a)(1)(iii)** Frequency hopping systems in the 2400–2483.5 MHz band shall use at least 15 channels. The average time of occupancy on any channel shall not be greater than 0.4 seconds within a period of 0.4 seconds multiplied by the number of hopping channels employed. Frequency hopping systems may avoid or suppress transmissions on a particular hopping frequency provided that a minimum of 15 channels are used.

**RSS-210 §A8.1 (d)** Frequency hopping systems operating in the 2400–2483.5 MHz band shall use at least 15 hopping channels. The average time of occupancy on any channel shall not be greater than 0.4 seconds within a period of 0.4 seconds, multiplied by the number of hopping channels employed. Transmissions on particular frequencies may be avoided or suppressed provided that a minimum of 15 hopping channels are used.

## Traceability

Method	Test Equipment Used
FCC DA 00-175	0078, 0134, 0158, 0184, 0193, 0287, 0250, 0252, 0310, 0312

---

This test report may be reproduced in full only. The document may only be updated by MiCOM Labs personnel. Any changes will be noted in the Document History section of the report.



**Title:** Ear Force i30 Wireless Audio Headset  
**To:** FCC 47 CFR Part 15.247 & IC RSS-210  
**Serial #:** COMM37-U2 Rev A  
**Issue Date:** 25th September 2013  
**Page:** 42 of 127

---

### 6.1.1.5. Channel Occupancy

Conducted Test Conditions for Channel Occupancy			
<b>Standard:</b>	FCC CFR 47:15.247	<b>Ambient Temp. (°C):</b>	24.0 - 27.5
<b>Test Heading:</b>	Channel Occupancy	<b>Rel. Humidity (%):</b>	32 - 45
<b>Standard Section(s):</b>	15.247 (a)	<b>Pressure (mBars):</b>	999 - 1001
<b>Reference Document(s):</b>	FCC DA 00-705 "Filing and Measurement Guidelines for Frequency Hopping Spread Spectrum Systems"		
<b>Test Procedure for Time of Occupancy (Dwell Time)</b> The EUT must have its hopping function Enabled The transmitter output was connected to a spectrum analyzer and the span was set for the frequency of operation. RBW = 1 MHz, VBW ≥ RBW, Sweep = Dwell time x number of hopping frequencies, detector function = peak, trace = max hold.			

---

This test report may be reproduced in full only. The document may only be updated by MiCOM Labs personnel. Any changes will be noted in the Document History section of the report.



**Title:** Ear Force i30 Wireless Audio Headset  
**To:** FCC 47 CFR Part 15.247 & IC RSS-210  
**Serial #:** COMM37-U2 Rev A  
**Issue Date:** 25th September 2013  
**Page:** 43 of 127

#### Equipment Configuration for Channel Occupancy

<b>Variant:</b>	802.15.2	<b>Duty Cycle (%):</b>	100%
<b>Data Rate:</b>	1-3 Mbit/s	<b>Antenna Gain (dBi):</b>	2.8
<b>Modulation:</b>	GFSK, $\pi/4$ DQPSK, 8DPSK	<b>Beam Forming Gain (Y):</b>	Not Applicable
<b>TPC:</b>	N/A		
<b>Engineering Test Notes:</b>	DH5 Packet types give the highest Dwell time, varying packet length also varies occupancy time		

#### Test Measurement Results

Centered on Channel	Center Frequency	Data Rate	Packet Length	Dwell Time (Single Channel)	Number of Hops	Channel Occupancy	Limit	Result
	MHz	Mbs		mS		mS		
0	2402	1	0	0.399	348	138.85	400	Pass
0	2402	2	510	1.653	190	308.37	400	Pass
0	2402	3	1021	2.895	126	364.77	400	Pass

Channel Occupancy was performed using a sweep time of 32 seconds ( $79 \times 0.4 = 31.6$  seconds).

All packet types were then checked with a sweep time of 1 second to verify the number of times the transmitter occupied Channel 0 (2402 MHz). Each packet type transmitted on channel 0 at the following rates:

DH5 packet length 0 = 11

DH5 packet length 510 = 6

DH5 packet length 1021 = 4

The number of hops = hops per one second  $\times$  31.6 seconds

Finally the channel occupancy time = number of hops  $\times$  single channel dwell time

This test report may be reproduced in full only. The document may only be updated by MiCOM Labs personnel. Any changes will be noted in the Document History section of the report.



**Title:** Ear Force i30 Wireless Audio Headset  
**To:** FCC 47 CFR Part 15.247 & IC RSS-210  
**Serial #:** COMM37-U2 Rev A  
**Issue Date:** 25th September 2013  
**Page:** 44 of 127

---

### Specification Limits

**§15.247 (b)** The maximum peak output power of the intentional radiator shall not exceed the following:

**(1)** For frequency hopping systems operating in the 2400–2483.5 MHz band employing at least 75 non-overlapping hopping channels, and all frequency hopping systems in the 5725–5850 MHz band: 1 watt. For all other frequency hopping systems in the 2400–2483.5 MHz band: 0.125 watts.

**RSS-210 §A8.4 (2)** For frequency hopping systems operating in the band 2400-2483.5 MHz and employing at least 75 hopping channels, the maximum peak conducted output power shall not exceed 1 W; for all other frequency hopping systems in the band, the maximum peak conducted output power shall not exceed 0.125 W. Except as provided in Section A8.4 (5), the e.i.r.p. shall not exceed 4 W..

### Laboratory Measurement Uncertainty for Power Measurements

Measurement uncertainty	±1.33 dB
-------------------------	----------

---

This test report may be reproduced in full only. The document may only be updated by MiCOM Labs personnel. Any changes will be noted in the Document History section of the report.



**Title:** Ear Force i30 Wireless Audio Headset  
**To:** FCC 47 CFR Part 15.247 & IC RSS-210  
**Serial #:** COMM37-U2 Rev A  
**Issue Date:** 25th September 2013  
**Page:** 45 of 127

### 6.1.1.6. Peak Output Power

Conducted Test Conditions for Fundamental Emission Output Power			
<b>Standard:</b>	FCC CFR 47:15.247	<b>Ambient Temp. (°C):</b>	24.0 - 27.5
<b>Test Heading:</b>	Emission Output Power	<b>Rel. Humidity (%):</b>	32 - 45
<b>Standard Section(s):</b>	15.247 (a)(2)	<b>Pressure (mBars):</b>	999 - 1004
<b>Reference Document(s):</b>	KDB 558074 - D01 DTS Measurement Guidance v01: Section 5.2 Fundamental Emission Output Power  KDB 662911 was implemented for In-band power measurements. The measure and sum technique was implemented in all cases.		
<b>Test Procedure for Fundamental Emission Output Power Measurement</b> The transmitter terminal of EUT was connected to the input of the spectrum analyzer set to measure peak power. The resolution filter bandwidth was set to 6 dB, peak detector selected and the analyzer built-in power function was used to integrate peak power over the 20 dB bandwidth.			
<b>Supporting Information</b> Calculated Power = A + G + 10 log (1/x) dBm A = Total Power [10 Log10 (10 <sup>a/10</sup> + 10 <sup>b/10</sup> + 10 <sup>c/10</sup> + 10 <sup>d/10</sup> )], G = Antenna Gain, x = Duty Cycle			

Equipment Configuration for Peak Output Power			
<b>Variant:</b>	802.15 DH1 & DH5	<b>Duty Cycle (%):</b>	100
<b>Data Rate:</b>	DH1	<b>Antenna Gain (dBi):</b>	2.80
<b>Modulation:</b>	GFSK	<b>Beam Forming Gain (Y):</b>	Not Applicable
<b>TPC:</b>	Not Applicable	<b>Tested By:</b>	JMH
<b>Engineering Test Notes:</b>			

#### Test Measurement Results DH1 & DH5

Test Frequency	DH1 Measured Output Power (dBm)				Calculated Total Power Σ Port(s)	Limit	Margin	EUT Power Setting
	Port(s)							
MHz	a	b	c	d	dBm	dBm	dBm	
2402.0	<a href="#">6.52</a>				6.52	30.00	-23.48	Max
2441.0	<a href="#">5.99</a>				5.99	30.00	-24.01	Max
2480.0	<a href="#">5.74</a>				5.74	30.00	-24.26	Max

Test Frequency	DH5 Measured Output Power (dBm)				Calculated Total Power Σ Port(s)	Limit	Margin	EUT Power Setting
	Port(s)							
MHz	a	b	c	d	dBm	dBm	dBm	
2402.0	<a href="#">7.72</a>				7.72	30.00	-22.28	Max
2441.0	<a href="#">6.95</a>				6.95	30.00	-23.05	Max
2480.0	<a href="#">6.98</a>				6.98	30.00	-23.02	Max

Note: [click the link in the above results matrix to view the plot](#)

This test report may be reproduced in full only. The document may only be updated by MiCOM Labs personnel. Any changes will be noted in the Document History section of the report.



**Title:** Ear Force i30 Wireless Audio Headset  
**To:** FCC 47 CFR Part 15.247 & IC RSS-210  
**Serial #:** COMM37-U2 Rev A  
**Issue Date:** 25th September 2013  
**Page:** 46 of 127

**Equipment Configuration for Peak Output Power**

<b>Variant:</b>	802.15 3-DH1 & 3-DH5	<b>Duty Cycle (%):</b>	100
<b>Data Rate:</b>	3-DH1 & 3-DH5	<b>Antenna Gain (dBi):</b>	2.80
<b>Modulation:</b>	8DPSK	<b>Beam Forming Gain (Y):</b>	Not Applicable
<b>TPC:</b>	Not Applicable	<b>Tested By:</b>	JMH
<b>Engineering Test Notes:</b>			

**Test Measurement Results**

Test Frequency	3 DH1 Measured Output Power (dBm)				Calculated Total Power $\Sigma$ Port(s)	Limit	Margin	EUT Power Setting
	Port(s)							
MHz	a	b	c	d	dBm	dBm	dBm	
2402.0	<a href="#">2.78</a>				2.78	30.00	-27.22	Max
2441.0	<a href="#">2.37</a>				2.37	30.00	-27.63	Max
2480.0	<a href="#">2.45</a>				2.45	30.00	-27.55	Max

Test Frequency	3 DH5 Measured Output Power (dBm)				Calculated Total Power $\Sigma$ Port(s)	Limit	Margin	EUT Power Setting
	Port(s)							
MHz	a	b	c	d	dBm	dBm	dBm	
2402.0	<a href="#">4.76</a>				4.76	30.00	-25.24	Max
2441.0	<a href="#">4.19</a>				4.19	30.00	-25.81	Max
2480.0	<a href="#">4.64</a>				4.64	30.00	-25.36	Max

Traceability to Industry Recognized Test Methodologies	
Work Instruction:	WI-01 MEASURING RF OUTPUT POWER
Measurement Uncertainty:	± 1.33 dB

Note: click the link in the above results matrix to view the plot

This test report may be reproduced in full only. The document may only be updated by MiCOM Labs personnel. Any changes will be noted in the Document History section of the report.



**Title:** Ear Force i30 Wireless Audio Headset  
**To:** FCC 47 CFR Part 15.247 & IC RSS-210  
**Serial #:** COMM37-U2 Rev A  
**Issue Date:** 25th September 2013  
**Page:** 47 of 127

## Specification

### Limits

#### §15.247 (b)(1)

(b) The maximum peak conducted output power of the intentional radiator shall not exceed the following.

(1) For frequency hopping systems in the 2400 – 2483.5 MHz band employing at least 75 non-overlapping hopping channels, and all frequency hopping systems in the 5725-5850 MHz band: 1 watt. For all other frequency hopping systems in the 2400 – 2483.5 MHz band: 0.125 watts.

§ RSS-210 A8.4(2) For frequency hopping systems operating in the 2400-2483.5 MHz and employing at least 75 hopping channels, the maximum peak conducted power shall not exceed 1 W; for all other frequency hopping systems in the band, the maximum peak conducted power shall not exceed 0.125 W. Except as provided in Section A8.4 (5), the e.i.r.p. shall not exceed 4 W.

Frequency hopping systems operating in the band 2400 – 2483.5 MHz may have hopping channel carrier frequencies that are separated by 25 kHz or two-thirds of the -20 dB bandwidth of the hopping channel, whichever is greater, provided that the systems operate with an output power no greater than 0.125 W.

### Traceability

Method	Test Equipment Used
FCC DA 00-0705	0158, 0193, 0287, 0252, 0313, 0314, 0070, 0116, 0117

This test report may be reproduced in full only. The document may only be updated by MiCOM Labs personnel. Any changes will be noted in the Document History section of the report.



**Title:** Ear Force i30 Wireless Audio Headset  
**To:** FCC 47 CFR Part 15.247 & IC RSS-210  
**Serial #:** COMM37-U2 Rev A  
**Issue Date:** 25th September 2013  
**Page:** 48 of 127

---

#### 6.1.1.7. Conducted Spurious Emissions

<b>Conducted Test Conditions for Transmitter Conducted Spurious and Band-Edge Emissions</b>			
<b>Standard:</b>	FCC CFR 47:15.247	<b>Ambient Temp. (°C):</b>	24.0 - 27.5
<b>Test Heading:</b>	Max Unwanted Emission Levels	<b>Rel. Humidity (%):</b>	32 - 45
<b>Standard Section(s):</b>	15.247 (d)	<b>Pressure (mBars):</b>	999 - 1001
<b>Reference Document(s):</b>	KDB 558074 - D01 DTS Measurement Guidance v01: Section 5.4 Maximum Unwanted Emission Levels		
<b>Test Procedure for Transmitter Conducted Spurious and Band-Edge Emissions Measurement</b> Transmitter Conducted Spurious and Band-Edge emissions were measured at a limit of 20 dB below the highest in-band spectral density measured with a spectrum analyzer connected to the antenna terminal. Measurements were made while EUT was operating in transmit mode of operation at the appropriate centre frequency closest to the band-edge. Emissions were maximized during the measurement and limits derived from the peak spectral power and drawn on each plot.			

---

This test report may be reproduced in full only. The document may only be updated by MiCOM Labs personnel. Any changes will be noted in the Document History section of the report.





**Title:** Ear Force i30 Wireless Audio Headset  
**To:** FCC 47 CFR Part 15.247 & IC RSS-210  
**Serial #:** COMM37-U2 Rev A  
**Issue Date:** 25th September 2013  
**Page:** 49 of 127

**Equipment Configuration for Transmitter Conducted Spurious Emissions**

<b>Variant:</b>	802.15.2	<b>Duty Cycle (%):</b>	100
<b>Data Rate:</b>	3-DH5	<b>Antenna Gain (dBi):</b>	Not Applicable
<b>Modulation:</b>	8-DPSK	<b>Beam Forming Gain (Y):</b>	Not Applicable
<b>TPC:</b>	Not Applicable	<b>Tested By:</b>	JMH
<b>Engineering Test Notes:</b>			

**Test Measurement Results**

Test Frequency	Frequency Range	Transmitter Conducted Spurious Emissions (dBm)							
		Port a		Port b		Port c		Port d	
MHz	MHz	SE	Limit	SE	Limit	SE	Limit	SE	Limit
2402.0	30.0 - 26000.0	<a href="#">-46.650</a>	-25.37						
2441.0	30.0 - 26000.0	<a href="#">-46.493</a>	-23.44						
2480.0	30.0 - 26000.0	<a href="#">-47.553</a>	-25.09						

Test Frequency	Band-Edge Frequency	Transmitter Conducted Band-Edge Emissions (dBm)							
		Port a		Port b		Port c		Port d	
MHz	MHz	BE	Limit	BE	Limit	BE	Limit	BE	Limit
2402.0	2400.0	<a href="#">-46.508</a>	-22.39						
2480.0	2483.5	<a href="#">-46.115</a>	-22.77						

Traceability to Industry Recognized Test Methodologies	
Work Instruction:	WI-05 MEASUREMENT OF SPURIOUS EMISSIONS
Measurement Uncertainty:	=40 GHz $\diamond$ 2.37 dB, > 40 GHz $\diamond$ 4.6 dB

Note: [click the link in the above results matrix to view the plot](#)

This test report may be reproduced in full only. The document may only be updated by MiCOM Labs personnel. Any changes will be noted in the Document History section of the report.



**Title:** Ear Force i30 Wireless Audio Headset  
**To:** FCC 47 CFR Part 15.247 & IC RSS-210  
**Serial #:** COMM37-U2 Rev A  
**Issue Date:** 25th September 2013  
**Page:** 50 of 127

## Specification

### Limits Band-Edge

Lower Limit Band-edge	Upper Limit Band-edge	Limit below highest level of desired power
2,400 MHz	2,483.5 MHz	≥ 20 dB
5725 MHz	5850 MHz	

**§15.247(d) and RSS-210 §A8.5** In any 100 kHz bandwidth outside the frequency band in which the spread spectrum or digitally modulated intentional radiator is operating, the radio frequency power that is produced by the intentional radiator shall be at least 20 dB below that in the 100 kHz bandwidth within the band that contains the highest level of the desired power, based on either an RF conducted or a radiated measurement, provided the transmitter demonstrates compliance with the peak conducted power limits. If the transmitter complies with the conducted power limits based on the use of RMS averaging over a time interval, as permitted under paragraph (b)(3) of this section, the attenuation required under this paragraph shall be 30 dB instead of 20 dB. Attenuation below the general limits specified in § 15.209(a) is not required. In addition, radiated emissions which fall in the restricted bands, as defined in § 15.205(a), must also comply with the radiated emission limits specified in § 15.209(a) (see § 15.205(c)).

### Laboratory Measurement Uncertainty for Conducted Spurious Emissions

Measurement uncertainty	±2.37 dB
-------------------------	----------

### Traceability

Method	Test Equipment Used
Measurements were made per work instruction WI-05 'Measurement of Spurious Emissions'	0088, 0158, 0287, 0252, 0313, 0314, 0070, 0116, 0117.

This test report may be reproduced in full only. The document may only be updated by MiCOM Labs personnel. Any changes will be noted in the Document History section of the report.



**Title:** Ear Force i30 Wireless Audio Headset  
**To:** FCC 47 CFR Part 15.247 & IC RSS-210  
**Serial #:** COMM37-U2 Rev A  
**Issue Date:** 25th September 2013  
**Page:** 51 of 127

### 6.1.1.8. Pseudorandom Hopping Frequency Sequence

Test Conditions for Pseudorandom Hopping Frequency Sequence			
<b>Standard:</b>	FCC CFR 47:15.247	<b>Ambient Temp. (°C):</b>	18.0 - 27.5
<b>Test Heading:</b>	Pseudorandom Hopping Sequence	<b>Rel. Humidity (%):</b>	32 - 45
<b>Standard Section(s):</b>	15.247 (a)(1)	<b>Pressure (mBars):</b>	999 - 1004
<b>Reference Document(s):</b>	FCC DA 00-705 "Filing and Measurement Guidelines for Frequency Hopping Spread Spectrum Systems"		

#### Pseudorandom Frequency Hopping Sequence

Describe how the hopping sequence is generated. Provide an example of the hopping sequence channels, in order to demonstrate that the sequence meets the requirement specified in the definition of a frequency hopping spread spectrum system, found in Section (a)(1).

#### **Declaration from the Manufacturer**

The hopping sequence is selected according to the Bluetooth standard. There are a total of 79 channels available in the 2.4 GHz band. The Bluetooth standard defines an algorithmic basis for determining the pseudorandom sequence to use.

This test report may be reproduced in full only. The document may only be updated by MiCOM Labs personnel. Any changes will be noted in the Document History section of the report.



**Title:** Ear Force i30 Wireless Audio Headset  
**To:** FCC 47 CFR Part 15.247 & IC RSS-210  
**Serial #:** COMM37-U2 Rev A  
**Issue Date:** 25th September 2013  
**Page:** 52 of 127

---

## Specifications

### §15.247 (a) (1)

(1) Frequency hopping systems shall have hopping channel carrier frequencies separated by a minimum of 25 kHz or the 20 dB bandwidth of the hopping channel, whichever is greater. Alternatively, frequency hopping systems operating in the 2400–2483.5 MHz band may have hopping channel carrier frequencies that are separated by 25 kHz or two-thirds of the 20 dB bandwidth of the hopping channel, whichever is greater, provided the systems operate with an output power no greater than 125 mW. The system shall hop to channel frequencies that are selected at the system hopping rate from a pseudo randomly ordered list of hopping frequencies. Each frequency must be used equally on the average by each transmitter. The system receivers shall have input bandwidths that match the hopping channel bandwidths of their corresponding transmitters and shall shift frequencies in synchronization with the transmitted signals.

---

This test report may be reproduced in full only. The document may only be updated by MiCOM Labs personnel. Any changes will be noted in the Document History section of the report.



**Title:** Ear Force i30 Wireless Audio Headset  
**To:** FCC 47 CFR Part 15.247 & IC RSS-210  
**Serial #:** COMM37-U2 Rev A  
**Issue Date:** 25th September 2013  
**Page:** 53 of 127

### 6.1.1.9. Equal Hopping Frequency Use

Test Conditions for Equal Hopping Frequency Use			
<b>Standard:</b>	FCC CFR 47:15.247	<b>Ambient Temp. (°C):</b>	18.0 - 27.5
<b>Test Heading:</b>	Equal Hopping Frequency Use	<b>Rel. Humidity (%):</b>	32 - 45
<b>Standard Section(s):</b>	15.247 (a)(1)	<b>Pressure (mBars):</b>	999 - 1004
<b>Reference Document(s):</b>	FCC DA 00-705 "Filing and Measurement Guidelines for Frequency Hopping Spread Spectrum Systems"		

#### Equal Hopping Frequency Use

Describe how each individual EUT meets the requirement that each of its hopping channels is used equally on average (e.g., that each new transmission event begins on the next channel in the hopping sequence after the final channel used in the previous transmission event). See Section (a)(1).

#### Declaration from the Manufacturer

Bluetooth uses a packet based air interface with a fixed timing. Each packet goes out on a different channel in the sequence, so all frequencies in the hopping sequence get used equally.

#### Specifications

##### **§15.247 (a) (1)**

(1) Frequency hopping systems shall have hopping channel carrier frequencies separated by a minimum of 25 kHz or the 20 dB bandwidth of the hopping channel, whichever is greater. Alternatively, frequency hopping systems operating in the 2400–2483.5 MHz band may have hopping channel carrier frequencies that are separated by 25 kHz or two-thirds of the 20 dB bandwidth of the hopping channel, whichever is greater, provided the systems operate with an output power no greater than 125 mW. The system shall hop to channel frequencies that are selected at the system hopping rate from a pseudo randomly ordered list of hopping frequencies. Each frequency must be used equally on the average by each transmitter. The system receivers shall have input bandwidths that match the hopping channel bandwidths of their corresponding transmitters and shall shift frequencies in synchronization with the transmitted signals.

This test report may be reproduced in full only. The document may only be updated by MiCOM Labs personnel. Any changes will be noted in the Document History section of the report.



**Title:** Ear Force i30 Wireless Audio Headset  
**To:** FCC 47 CFR Part 15.247 & IC RSS-210  
**Serial #:** COMM37-U2 Rev A  
**Issue Date:** 25th September 2013  
**Page:** 54 of 127

#### 6.1.1.10. System Receiver Input Bandwidth

Test Conditions for System Receiver Input Bandwidth			
<b>Standard:</b>	FCC CFR 47:15.247	<b>Ambient Temp. (°C):</b>	18.0 - 27.5
<b>Test Heading:</b>	System Receiver Input Bandwidth	<b>Rel. Humidity (%):</b>	32 - 45
<b>Standard Section(s):</b>	15.247 (a)(1)	<b>Pressure (mBars):</b>	999 - 1004
<b>Reference Document(s):</b>	FCC DA 00-705 "Filing and Measurement Guidelines for Frequency Hopping Spread Spectrum Systems"		

#### System Receiver Input Bandwidth

Describe how each individual EUT meets the requirement that each of its hopping channels is used equally on average (e.g., that each new transmission event begins on the next channel in the hopping sequence after the final channel used in the previous transmission event). See Section (a)(1).

#### Declaration from the Manufacturer

Chipset by CSR BT is used in the design and complies with Bluetooth specifications. There are no external channel filters present, but filters are present in the chipset design in order to achieve the receiver sensitivity.

This test report may be reproduced in full only. The document may only be updated by MiCOM Labs personnel. Any changes will be noted in the Document History section of the report.



**Title:** Ear Force i30 Wireless Audio Headset  
**To:** FCC 47 CFR Part 15.247 & IC RSS-210  
**Serial #:** COMM37-U2 Rev A  
**Issue Date:** 25th September 2013  
**Page:** 55 of 127

---

## Specifications

### §15.247 (a) (1)

(1) Frequency hopping systems shall have hopping channel carrier frequencies separated by a minimum of 25 kHz or the 20 dB bandwidth of the hopping channel, whichever is greater. Alternatively, frequency hopping systems operating in the 2400–2483.5 MHz band may have hopping channel carrier frequencies that are separated by 25 kHz or two-thirds of the 20 dB bandwidth of the hopping channel, whichever is greater, provided the systems operate with an output power no greater than 125 mW. The system shall hop to channel frequencies that are selected at the system hopping rate from a pseudo randomly ordered list of hopping frequencies. Each frequency must be used equally on the average by each transmitter. The system receivers shall have input bandwidths that match the hopping channel bandwidths of their corresponding transmitters and shall shift frequencies in synchronization with the transmitted signals.

§ RSS-210 A8.1 (b) (b) Frequency hopping systems shall have hopping channel carrier frequencies separated by a minimum of 25 kHz or the -20 dB bandwidth of the hopping channel, whichever is greater. Alternatively, frequency hopping systems operating in the band 2400-2483.5 MHz may have hopping channel carrier frequencies that are separated by 25 kHz or two-thirds of the -20 dB bandwidth of the hopping channel, whichever is greater, provided that the systems operate with an output power no greater than 0.125 W. The system receivers shall have input bandwidths that match the hopping channel bandwidths of their corresponding transmitters and shall shift frequencies in synchronization with the transmitted signals

---

This test report may be reproduced in full only. The document may only be updated by MiCOM Labs personnel. Any changes will be noted in the Document History section of the report.



**Title:** Ear Force i30 Wireless Audio Headset  
**To:** FCC 47 CFR Part 15.247 & IC RSS-210  
**Serial #:** COMM37-U2 Rev A  
**Issue Date:** 25th September 2013  
**Page:** 56 of 127

#### 6.1.1.11. System Receiver Hopping Capability

Test Conditions for System Receiver Hopping Capability			
<b>Standard:</b>	FCC CFR 47:15.247	<b>Ambient Temp. (°C):</b>	18.0 - 27.5
<b>Test Heading:</b>	System Receiver Hopping Capability	<b>Rel. Humidity (%):</b>	32 - 45
<b>Standard Section(s):</b>	15.247 (a)(1)	<b>Pressure (mBars):</b>	999 - 1004
<b>Reference Document(s):</b>	FCC DA 00-705 "Filing and Measurement Guidelines for Frequency Hopping Spread Spectrum Systems"		

#### System Receiver Hopping Capability

Describe how the associated receiver(s) has the ability to shift frequencies in synchronization with the transmitted signals. See Section (a)(1).

#### Declaration from the Manufacturer

A slave device follows the master device's hopping sequence by quickly scanning through channels to find the master's transmission (this is called discovery). It then uses information in that packet and the same algorithmic process described in the standard to determine what the hopping sequence is that the master is using. The slave also synchronizes to the master's transmit packet timing so it knows when to hop.

This test report may be reproduced in full only. The document may only be updated by MiCOM Labs personnel. Any changes will be noted in the Document History section of the report.





**Title:** Ear Force i30 Wireless Audio Headset  
**To:** FCC 47 CFR Part 15.247 & IC RSS-210  
**Serial #:** COMM37-U2 Rev A  
**Issue Date:** 25th September 2013  
**Page:** 57 of 127

---

## Specifications

### §15.247 (a) (1)

(1) Frequency hopping systems shall have hopping channel carrier frequencies separated by a minimum of 25 kHz or the 20 dB bandwidth of the hopping channel, whichever is greater. Alternatively, frequency hopping systems operating in the 2400–2483.5 MHz band may have hopping channel carrier frequencies that are separated by 25 kHz or two-thirds of the 20 dB bandwidth of the hopping channel, whichever is greater, provided the systems operate with an output power no greater than 125 mW. The system shall hop to channel frequencies that are selected at the system hopping rate from a pseudo randomly ordered list of hopping frequencies. Each frequency must be used equally on the average by each transmitter. The system receivers shall have input bandwidths that match the hopping channel bandwidths of their corresponding transmitters and shall shift frequencies in synchronization with the transmitted signals.

§ RSS-210 A8.1 (b) (b) Frequency hopping systems shall have hopping channel carrier frequencies separated by a minimum of 25 kHz or the -20 dB bandwidth of the hopping channel, whichever is greater. Alternatively, frequency hopping systems operating in the band 2400-2483.5 MHz may have hopping channel carrier frequencies that are separated by 25 kHz or two-thirds of the -20 dB bandwidth of the hopping channel, whichever is greater, provided that the systems operate with an output power no greater than 0.125 W. The system receivers shall have input bandwidths that match the hopping channel bandwidths of their corresponding transmitters and shall shift frequencies in synchronization with the transmitted signals

---

This test report may be reproduced in full only. The document may only be updated by MiCOM Labs personnel. Any changes will be noted in the Document History section of the report.



**Title:** Ear Force i30 Wireless Audio Headset  
**To:** FCC 47 CFR Part 15.247 & IC RSS-210  
**Serial #:** COMM37-U2 Rev A  
**Issue Date:** 25th September 2013  
**Page:** 58 of 127

---

## 6.1.2. Radiated Emission Testing

### Transmitter Radiated Spurious Emissions (above 1 GHz); Peak Field Strength Measurements; and Radiated Band Edge Measurements – Restricted Bands

**FCC, Part 15 Subpart C §15.247(d) 15.205; 15.209**  
**Industry Canada RSS-210 §A8.5,**  
**Industry Canada RSS-Gen §4.10**

#### Test Procedure

The worst case highest spectral density radiated emissions above 1 GHz are measured in the anechoic chamber at a 3-meter distance on every azimuth in both horizontal and vertical polarities. The emissions are recorded and maximized as a function of azimuth by rotation through 360° with a spectrum analyzer in peak hold mode. Depending on the frequency band spanned a notch filter and waveguide filter was used to remove the fundamental frequency. The highest emissions relative to the limit are listed for each frequency spanned.

All measurements on any frequency or frequencies over 1 MHz are based on the use of measurement instrumentation employing an average detector function. All measurements above 1 GHz were performed using a minimum resolution bandwidth of 1 MHz.

#### Field Strength Calculation

The field strength is calculated by adding the Antenna Factor and Cable Loss, and subtracting Amplifier Gain from the measured reading. All factors are included in the reported data.

$$FS = R + AF + CORR - FO$$

where: FS = Field Strength

R = Measured Spectrum analyzer Input Amplitude

AF = Antenna Factor

CORR = Correction Factor = CL – AG + NFL

CL = Cable Loss

AG = Amplifier Gain

FO = Distance Falloff Factor

NFL = Notch Filter Loss or Waveguide Loss

For example:

Given receiver input reading of 51.5 dB $\mu$ V; Antenna Factor of 8.5 dB; Cable Loss of 1.3 dB; Falloff Factor of 0 dB, an Amplifier Gain of 26 dB and Notch Filter Loss of 1 dB. The Field Strength of the measured emission is:

$$FS = 51.5 + 8.5 + 1.3 - 26.0 + 1 = 36.3 \text{ dB}\mu\text{V/m}$$

Conversion between dB $\mu$ V/m (or dB $\mu$ V) and  $\mu$ V/m (or  $\mu$ V) are done as:

$$\text{Level (dB}\mu\text{V/m)} = 20 * \text{Log (level (\mu\text{V/m}))}$$

$$40 \text{ dB}\mu\text{V/m} = 100 \mu\text{V/m}$$

$$48 \text{ dB}\mu\text{V/m} = 250 \mu\text{V/m}$$

---

This test report may be reproduced in full only. The document may only be updated by MiCOM Labs personnel. Any changes will be noted in the Document History section of the report.



**Title:** Ear Force i30 Wireless Audio Headset  
**To:** FCC 47 CFR Part 15.247 & IC RSS-210  
**Serial #:** COMM37-U2 Rev A  
**Issue Date:** 25th September 2013  
**Page:** 59 of 127

### 6.1.2.1. Test Results

<b>Test Freq.</b>	2402 MHz	<b>Engineer</b>	JMH
<b>Variant</b>	802.15	<b>Temp (°C)</b>	25
<b>Freq. Range</b>	1000 MHz - 18000 MHz	<b>Rel. Hum.(%)</b>	33
<b>Power Setting</b>	+4 dBm	<b>Press. (mBars)</b>	998
<b>Antenna</b>	2.8 dBi	<b>Duty Cycle (%)</b>	100
<b>Test Notes 1</b>	i30 Headset		
<b>Test Notes 2</b>	Target set to =+4 dBm, BDR GFSK DH1 Packet Type		

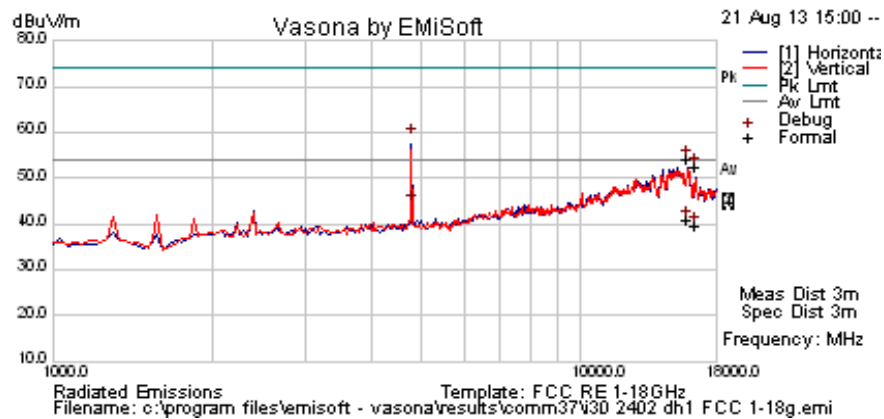

#### Formally measured emission peaks

Frequency MHz	Raw dBuV	Cable Loss	AF dB	Level dBuV/m	Measurement Type	Pol	Hgt cm	Azt Deg	Limit dBuV/m	Margin dB	Pass /Fail	Comments
4804.285	63.8	4.6	-9.7	58.8	Peak	H	153	317	74.0	-15.2	Pass	RB
4804.285	49.4	4.6	-9.7	44.4	Average	H	153	317	54.0	-9.6	Pass	RB
15920.802	32.0	9.0	-0.1	41.0	Average Max	H	130	317	54	-13.1	Pass	RB
15920.802	45.3	9.0	-0.1	54.2	Peak Max	H	130	317	74	-19.8	Pass	RB
16449.138	29.9	9.4	0.2	39.5	Average Max	H	141	347	54	-14.5	Pass	RB
16449.138	42.7	9.4	0.2	52.3	Peak Max	H	141	347	74	-21.7	Pass	RB

Legend: TX = Transmitter Emissions; DIG = Digital Emissions; FUND = Fundamental; WB = Wideband Emission  
 RB = Restricted Band (15.209 Limits); NRB = Non Restricted Band, Limit is 20dB below fundamental peak

This test report may be reproduced in full only. The document may only be updated by MiCOM Labs personnel. Any changes will be noted in the Document History section of the report.



**Title:** Ear Force i30 Wireless Audio Headset  
**To:** FCC 47 CFR Part 15.247 & IC RSS-210  
**Serial #:** COMM37-U2 Rev A  
**Issue Date:** 25th September 2013  
**Page:** 60 of 127

Test Freq.	2441 MHz	Engineer	JMH
Variant	802.15	Temp (°C)	25
Freq. Range	1000 MHz - 18000 MHz	Rel. Hum.(%)	33
Power Setting	+4 dBm	Press. (mBars)	998
Antenna	2.8 dBi	Duty Cycle (%)	100
Test Notes 1	i30 Headset		
Test Notes 2	Target set to =+4 dBm, BDR GFSK DH1 Packet Type		

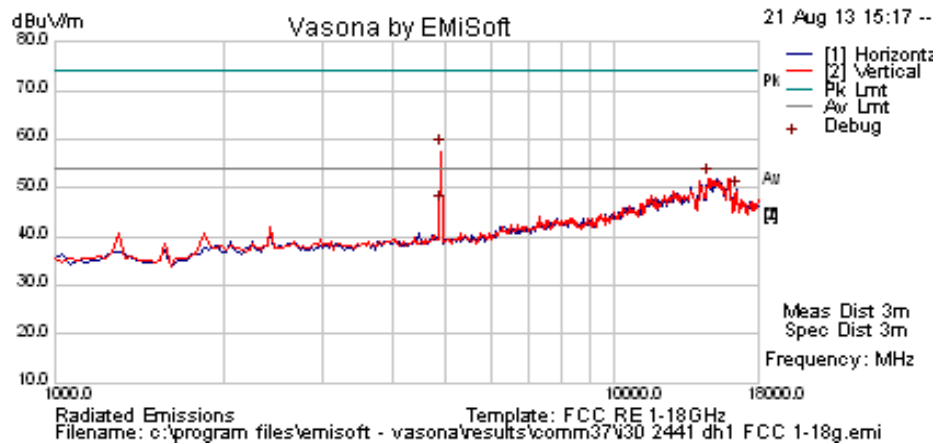

### Formally measured emission peaks

Frequency MHz	Raw dBuV	Cable Loss	AF dB	Level dBuV/m	Measurement Type	Pol	Hgt cm	Azt Deg	Limit dBuV/m	Margin dB	Pass /Fail	Comments
4881.894	63.2	4.6	-9.7	58.0	Peak Max	V	145	41	74.0	-16.0	Pass	RB
4881.894	51.8	4.6	-9.7	46.7	Average Max	V	145	41	54	-7.3	Pass	RB
14661.323	46.2	8.4	-2.6	52.0	Peak [Scan]	V						NRB
16466.934	39.9	9.4	0.3	49.5	Peak [Scan]	H						NRB

Legend: TX = Transmitter Emissions; DIG = Digital Emissions; FUND = Fundamental; WB = Wideband Emission  
 RB = Restricted Band (15.209 Limits); NRB = Non Restricted Band, Limit is 20dB below fundamental peak

This test report may be reproduced in full only. The document may only be updated by MiCOM Labs personnel. Any changes will be noted in the Document History section of the report.



**Title:** Ear Force i30 Wireless Audio Headset  
**To:** FCC 47 CFR Part 15.247 & IC RSS-210  
**Serial #:** COMM37-U2 Rev A  
**Issue Date:** 25th September 2013  
**Page:** 61 of 127

<b>Test Freq.</b>	2480 MHz	<b>Engineer</b>	JMH
<b>Variant</b>	802.15	<b>Temp (°C)</b>	25
<b>Freq. Range</b>	1000 MHz - 18000 MHz	<b>Rel. Hum.(%)</b>	33
<b>Power Setting</b>	+4 dBm	<b>Press. (mBars)</b>	998
<b>Antenna</b>	2.8 dBi	<b>Duty Cycle (%)</b>	100
<b>Test Notes 1</b>	i30 Headset		
<b>Test Notes 2</b>	Target set to =+4 dBm, BDR GFSK DH1 Packet Type		

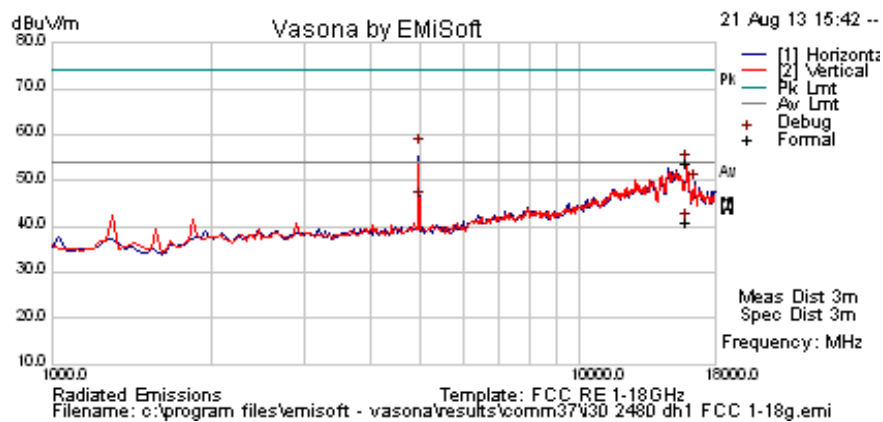

### Formally measured emission peaks

Frequency MHz	Raw dBuV	Cable Loss	AF dB	Level dBuV/m	Measurement Type	Pol	Hgt cm	Azt Deg	Limit dBuV/m	Margin dB	Pass /Fail	Comments
4959.637	62.6	4.6	-9.9	57.4	Peak Max	H	147	335	74	-16.6	Pass	RB
4959.993713	50.8	4.6	-9.9	45.5	Average Max	H	147	335	54	-8.5	Pass	RB
15919.920	45.0	9.0	-0.1	53.9	Peak Max	V	137	98	74	-20.1	Pass	RB
15919.920	32.0	9.0	-0.1	40.9	Average Max	V	137	98	54	-13.1	Pass	RB
16466.104	39.9	9.4	0.3	49.6	Peak [Scan]						Pass	NRB
Legend: TX = Transmitter Emissions; DIG = Digital Emissions; FUND = Fundamental; WB = Wideband Emission RB = Restricted Band (15.209 Limits); NRB = Non Restricted Band, Limit is 20dB below fundamental peak												

This test report may be reproduced in full only. The document may only be updated by MiCOM Labs personnel. Any changes will be noted in the Document History section of the report.



**Title:** Ear Force i30 Wireless Audio Headset  
**To:** FCC 47 CFR Part 15.247 & IC RSS-210  
**Serial #:** COMM37-U2 Rev A  
**Issue Date:** 25th September 2013  
**Page:** 62 of 127

<b>Test Freq.</b>	2402 MHz	<b>Engineer</b>	JMH
<b>Variant</b>	802.15	<b>Temp (°C)</b>	25
<b>Freq. Range</b>	1000 MHz - 18000 MHz	<b>Rel. Hum.(%)</b>	33
<b>Power Setting</b>	+4 dBm	<b>Press. (mBars)</b>	998
<b>Antenna</b>	2.8 dBi	<b>Duty Cycle (%)</b>	100
<b>Test Notes 1</b>	i30 Headset		
<b>Test Notes 2</b>	Target set to +4 dBm, EDR 8 DPSK 3-DH5 Packet Type		

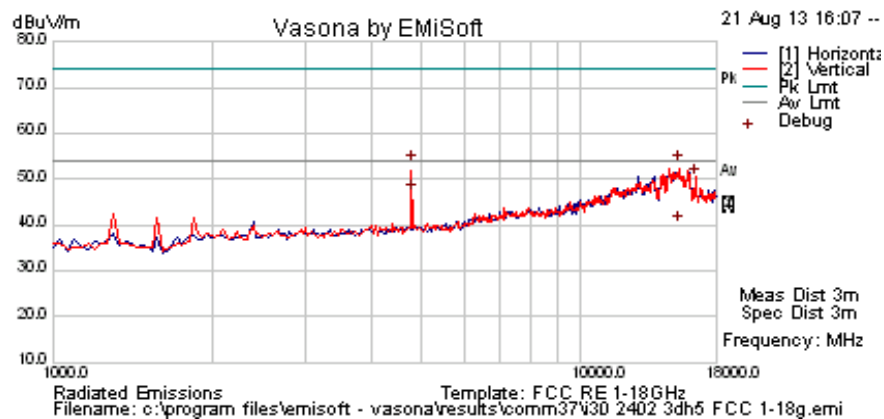

### Formally measured emission peaks

Frequency MHz	Raw dBuV	Cable Loss	AF dB	Level dBuV/m	Measurement Type	Pol	Hgt cm	Azt Deg	Limit dBuV/m	Margin dB	Pass /Fail	Comments
4803.447	58.5	4.6	-9.7	53.4	Peak Max	H	178	315	74.0	-20.6	Pass	RB
4803.447	51.8	4.6	-9.7	46.8	Average Max	H	178	315	54.0	-7.2	Pass	RB
15373.708	32.2	8.7	-0.7	40.2	Average Max	V	152	51	54	-13.8	Pass	RB
15373.708	45.5	8.7	-0.7	53.5	Peak Max	V	152	51	74	-20.5	Pass	RB
16466.934	40.9	9.4	0.3	50.5	Peak [Scan]	V						NRB
Legend: TX = Transmitter Emissions; DIG = Digital Emissions; FUND = Fundamental; WB = Wideband Emission RB = Restricted Band (15.209 Limits); NRB = Non Restricted Band, Limit is 20dB below fundamental peak												

This test report may be reproduced in full only. The document may only be updated by MiCOM Labs personnel. Any changes will be noted in the Document History section of the report.



**Title:** Ear Force i30 Wireless Audio Headset  
**To:** FCC 47 CFR Part 15.247 & IC RSS-210  
**Serial #:** COMM37-U2 Rev A  
**Issue Date:** 25th September 2013  
**Page:** 63 of 127

DH5 2400 MHz Band Edge

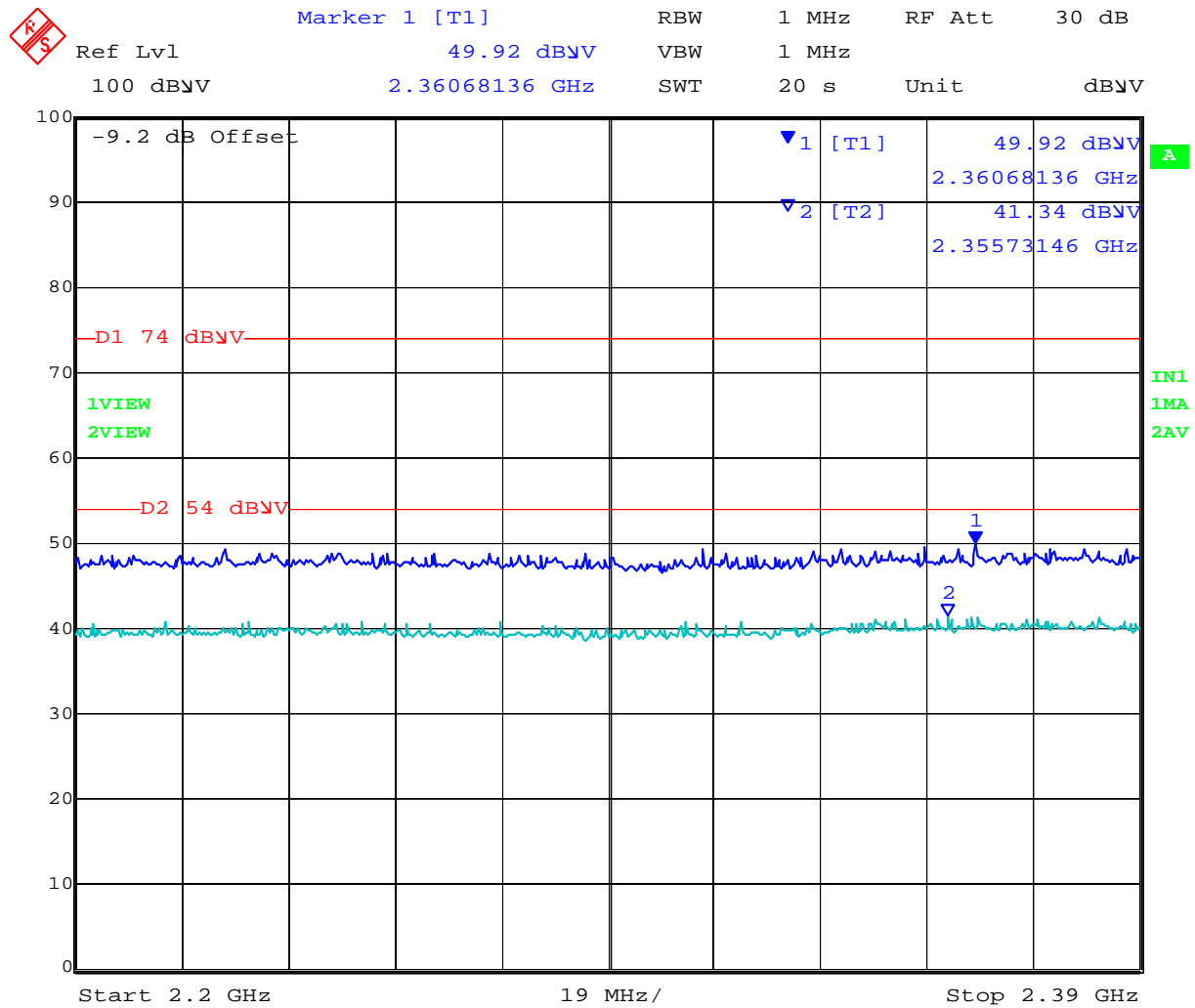

Date: 21.AUG.2013 17:03:57

This test report may be reproduced in full only. The document may only be updated by MiCOM Labs personnel. Any changes will be noted in the Document History section of the report.



**Title:** Ear Force i30 Wireless Audio Headset  
**To:** FCC 47 CFR Part 15.247 & IC RSS-210  
**Serial #:** COMM37-U2 Rev A  
**Issue Date:** 25th September 2013  
**Page:** 64 of 127

Test Freq.	2441	Engineer	JMH
Variant	802.15	Temp (°C)	25
Freq. Range	1000 MHz - 18000 MHz	Rel. Hum.(%)	33
Power Setting	+4 dBm	Press. (mBars)	998
Antenna	2.8 dBi	Duty Cycle (%)	100
Test Notes 1	i30 Headset		
Test Notes 2	Target set to +4 dBm, EDR 8 DPSK 3-DH5 Packet Type		

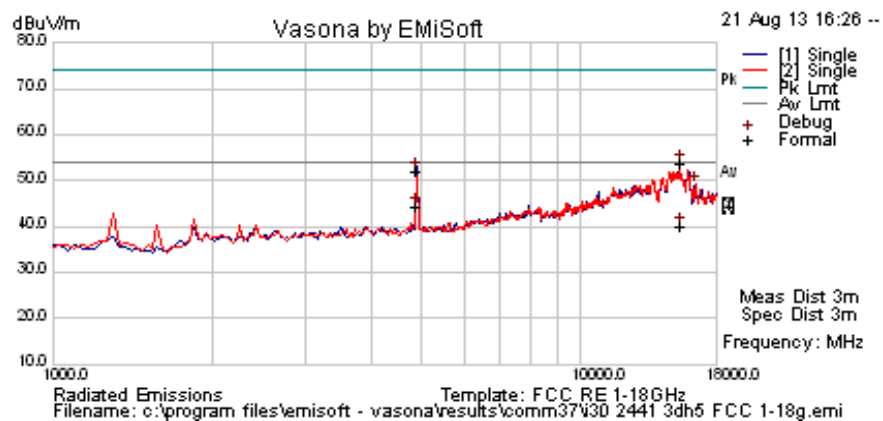

### Formally measured emission peaks

Frequency MHz	Raw dBuV	Cable Loss	AF dB	Level dBuV/m	Measurement Type	Pol	Hgt cm	Azt Deg	Limit dBuV/m	Margin dB	Pass /Fail	Comments
4881.713	57.0	4.6	-9.7	51.9	Peak Max	H	176	212	74.0	-22.1	Pass	RB
4881.713	49.3	4.6	-9.7	44.2	Average Max	H	176	212	54.0	-9.8	Pass	RB
15404.610	32.0	8.8	-0.6	40.2	Average Max	V	131	7	54	-13.8	Pass	RB
15404.610	45.6	8.8	-0.6	53.7	Peak Max	V	131	7	74	-20.3	Pass	RB
16432.866	39.7	9.3	0.2	49.2	Peak [Scan]	H						NRB

Legend: TX = Transmitter Emissions; DIG = Digital Emissions; FUND = Fundamental; WB = Wideband Emission  
 RB = Restricted Band (15.209 Limits); NRB = Non Restricted Band, Limit is 20dB below fundamental peak

This test report may be reproduced in full only. The document may only be updated by MiCOM Labs personnel. Any changes will be noted in the Document History section of the report.





**Title:** Ear Force i30 Wireless Audio Headset  
**To:** FCC 47 CFR Part 15.247 & IC RSS-210  
**Serial #:** COMM37-U2 Rev A  
**Issue Date:** 25th September 2013  
**Page:** 65 of 127

Test Freq.	2480	Engineer	JMH
Variant	802.15	Temp (°C)	25
Freq. Range	1000 MHz - 18000 MHz	Rel. Hum.(%)	33
Power Setting	+4 dBm	Press. (mBars)	998
Antenna	2.8 dBi	Duty Cycle (%)	100
Test Notes 1	i30 Headset		
Test Notes 2	Target set to +4 dBm, EDR 8 DPSK 3-DH5 Packet Type		

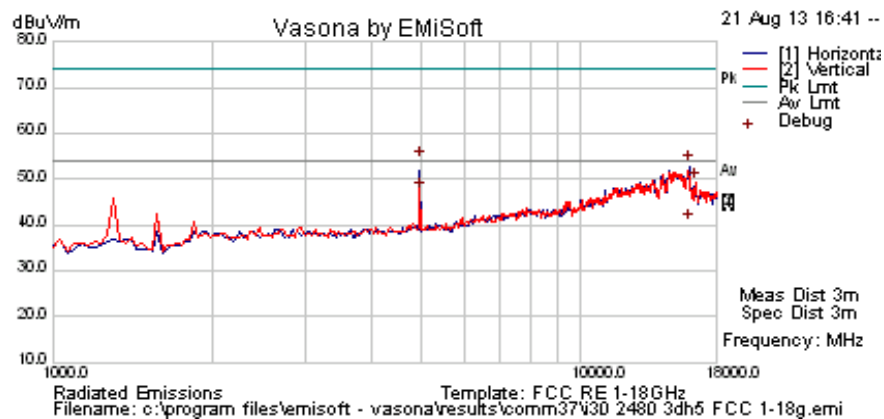

### Formally measured emission peaks

Frequency MHz	Raw dBuV	Cable Loss	AF dB	Level dBuV/m	Measurement Type	Pol	Hgt cm	Azt Deg	Limit dBuV/m	Margin dB	Pass /Fail	Comments
4959.407056	59.4	4.6	-9.9	54.1	Peak Max	H	138	328	74.0	-19.9	Pass	RB
4959.407	52.6	4.6	-9.9	47.4	Average Max	H	138	328	54	-6.6	Pass	RB
15982.770	31.2	9.1	0.1	40.3	Average Max	H	147	87	54	-13.7	Pass	RB
15982.770	44.1	9.1	0.1	53.3	Peak Max	H	147	87	74	-20.7	Pass	RB
16466.934	39.8	9.4	0.3	49.4	Peak [Scan]	V						NRB
Legend: TX = Transmitter Emissions; DIG = Digital Emissions; FUND = Fundamental; WB = Wideband Emission												
RB = Restricted Band (15.209 Limits); NRB = Non Restricted Band, Limit is 20dB below fundamental peak												

This test report may be reproduced in full only. The document may only be updated by MiCOM Labs personnel. Any changes will be noted in the Document History section of the report.



**Title:** Ear Force i30 Wireless Audio Headset  
**To:** FCC 47 CFR Part 15.247 & IC RSS-210  
**Serial #:** COMM37-U2 Rev A  
**Issue Date:** 25th September 2013  
**Page:** 66 of 127

### DH5 2483.5 MHz Band Edge

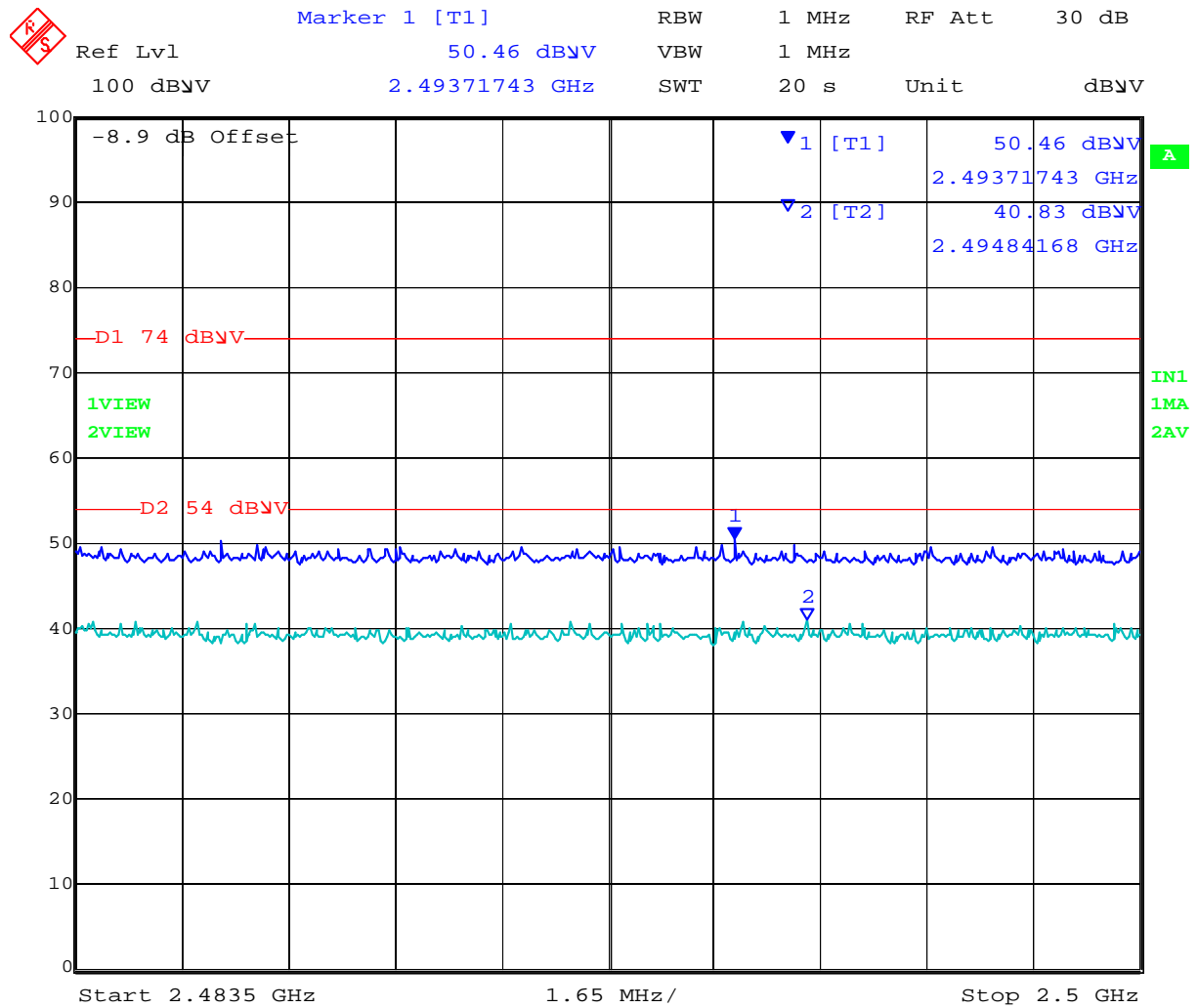

Date: 21.AUG.2013 16:56:24

This test report may be reproduced in full only. The document may only be updated by MiCOM Labs personnel. Any changes will be noted in the Document History section of the report.



**Title:** Ear Force i30 Wireless Audio Headset  
**To:** FCC 47 CFR Part 15.247 & IC RSS-210  
**Serial #:** COMM37-U2 Rev A  
**Issue Date:** 25th September 2013  
**Page:** 67 of 127

Hopping Band Edge: 2390-2400

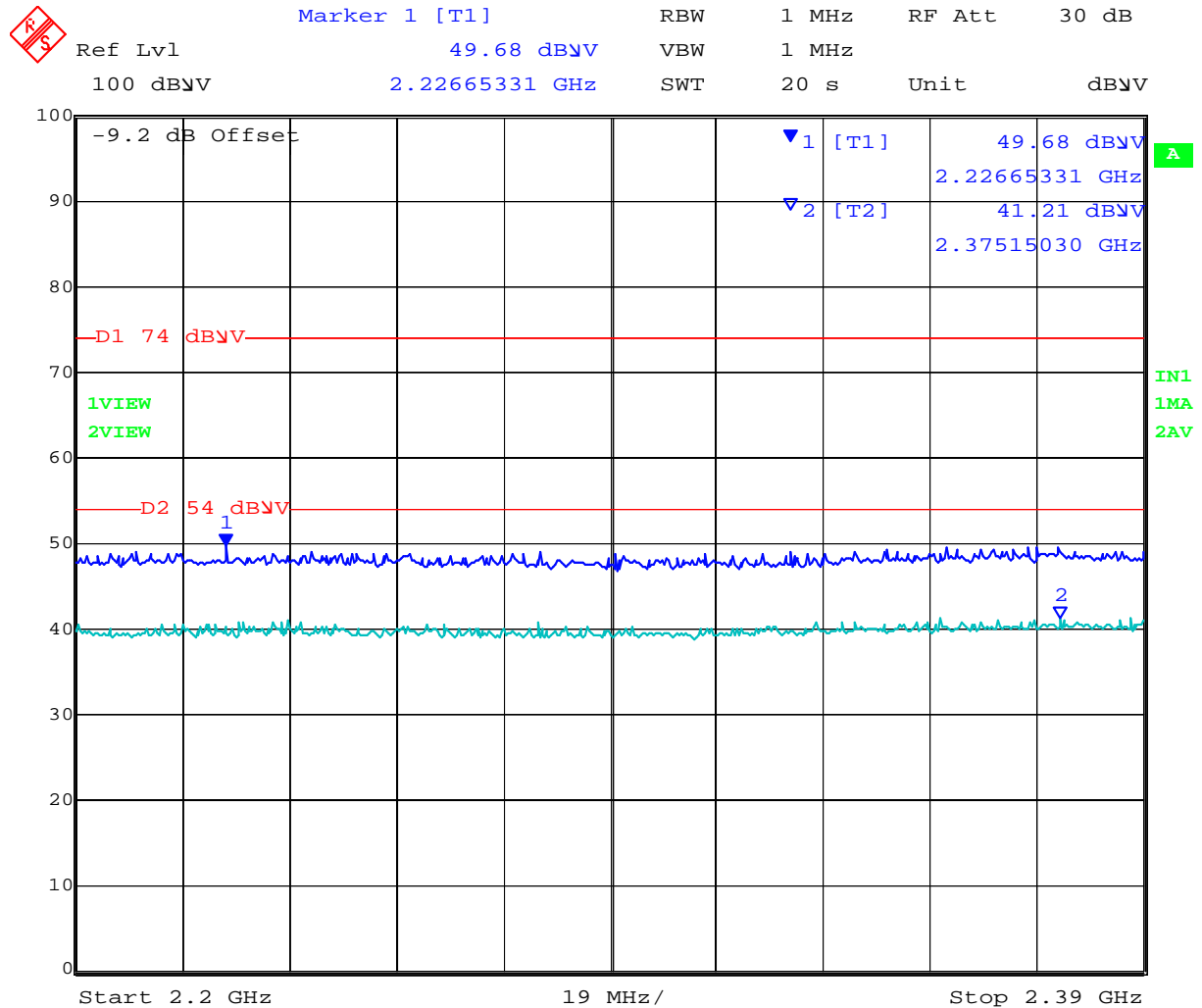

Date: 21.AUG.2013 17:10:01

This test report may be reproduced in full only. The document may only be updated by MiCOM Labs personnel. Any changes will be noted in the Document History section of the report.



**Title:** Ear Force i30 Wireless Audio Headset  
**To:** FCC 47 CFR Part 15.247 & IC RSS-210  
**Serial #:** COMM37-U2 Rev A  
**Issue Date:** 25th September 2013  
**Page:** 68 of 127

Hopping Band Edge: 2483.5-2500

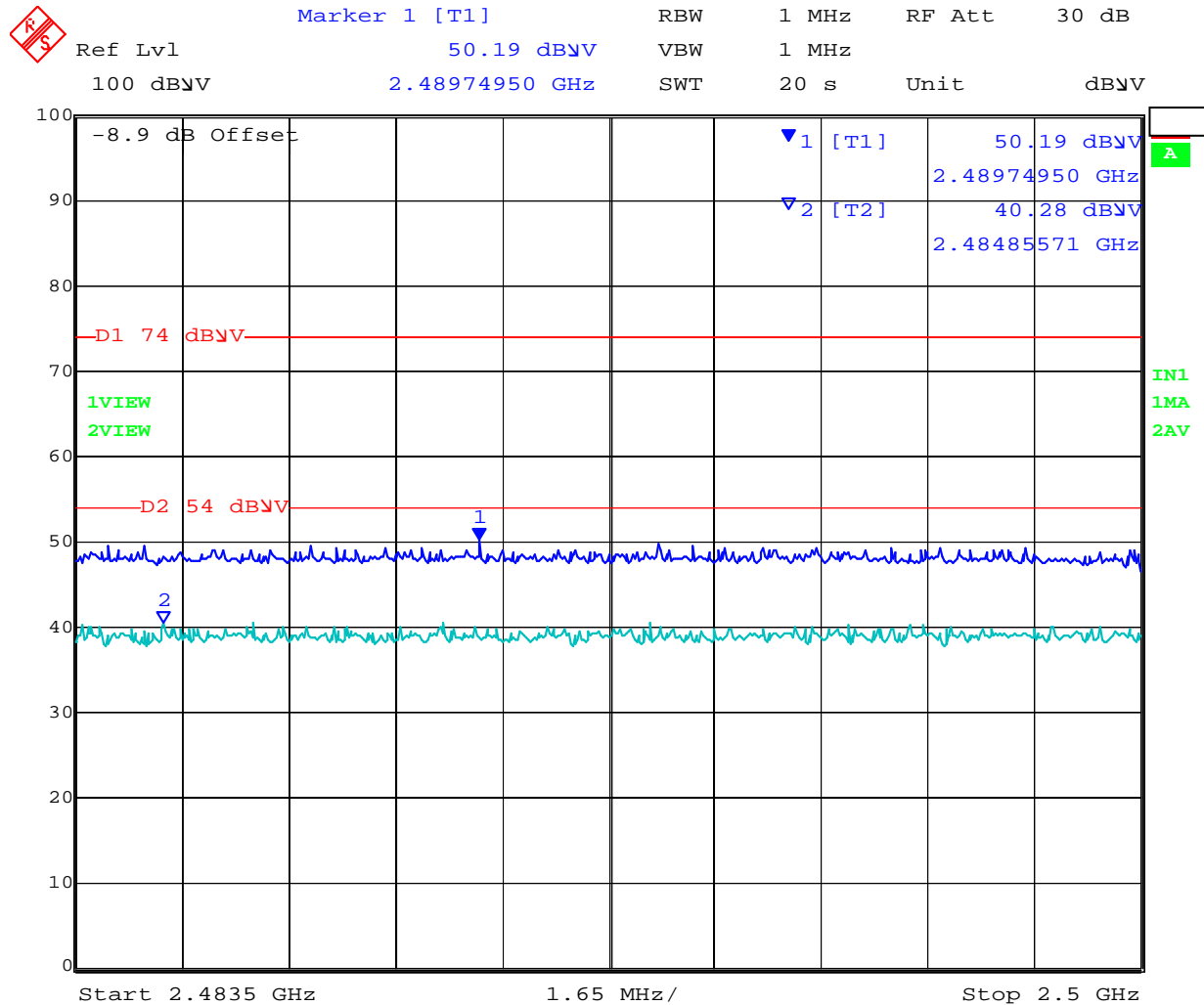

Date: 21.AUG.2013 17:13:29

This test report may be reproduced in full only. The document may only be updated by MiCOM Labs personnel. Any changes will be noted in the Document History section of the report.



**Title:** Ear Force i30 Wireless Audio Headset  
**To:** FCC 47 CFR Part 15.247 & IC RSS-210  
**Serial #:** COMM37-U2 Rev A  
**Issue Date:** 25th September 2013  
**Page:** 69 of 127

---

## Specification Limits

**FCC §15.247(d)** In any 100 kHz bandwidth outside the frequency band in which the spread spectrum or digitally modulated intentional radiator is operating, the radio frequency power that is produced by the intentional radiator shall be at least 20 dB below that in the 100 kHz bandwidth within the band that contains the highest level of the desired power, based on either an RF conducted or radiated measurement, provided the transmitter demonstrates compliance with the peak conducted power limits.

If the transmitter complies with the conducted power limits based on the use of RMS averaging over a time interval, as permitted under paragraph (b)(3) of this section, the attenuation required under this paragraph shall be 30 dB instead of 20 dB. Attenuation below the general limits specified §15.209(a) is not required. In addition, radiated emissions which fall in the restricted bands, as defined in Section §15.205(a), must also comply with the radiated emission limits specified in Section 15.209(a) (see Section 15.205(a)).

**IC RSS-210 §A8.5** In any 100 kHz bandwidth outside the frequency band in which the spread spectrum or digitally modulated device is operating, the RF power that is produced shall be at least 20 dB below that in the 100 kHz bandwidth within the band that contains the highest level of the desired power, based on either an RF conducted or a radiated measurement, provided that the transmitter demonstrates compliance with the peak conducted power limits. If the transmitter complies with the conducted power limits based on the use of root-mean-square averaging over a time interval, as permitted under Section A8.4 (4), the attenuation required shall be 30 dB instead of 20 dB. Attenuation below the general field strength limits specified in RSS-Gen is not required

**FCC §15.205 (a)** Except as shown in paragraph (d) of 15.205 (a), only spurious emissions are permitted in any of the frequency bands listed.

**FCC §15.205 (a)** Except as shown in paragraphs (d) and (e) of this section, the field strength of emissions appearing within these frequency bands shall not exceed the limits shown in Section §15.209. At frequencies equal to or less than 1000 MHz, compliance with the limits in Section 15.209 shall be demonstrated using measurement instrumentation employing a CISPR quasi-peak detector. Above 1000 MHz, compliance with the emission limits in Section 15.209 shall be demonstrated based on the average value of the measured emissions. The provisions in Section 15.35 apply to these measurements.

**FCC §15.209 (a)** Except as provided elsewhere in this subpart, the emissions from an intentional radiator shall not exceed the field strength levels specified in the following table.

---

This test report may be reproduced in full only. The document may only be updated by MiCOM Labs personnel. Any changes will be noted in the Document History section of the report.



**Title:** Ear Force i30 Wireless Audio Headset  
**To:** FCC 47 CFR Part 15.247 & IC RSS-210  
**Serial #:** COMM37-U2 Rev A  
**Issue Date:** 25th September 2013  
**Page:** 70 of 127

**§15.209 (a) Limit Matrix**

Frequency(MHz)	Field Strength ( $\mu\text{V/m}$ )	Field Strength ( $\text{dB}\mu\text{V/m}$ )	Measurement Distance (meters)
30-88	100	40.0	3
88-216	150	43.5	3
216-960	200	46.0	3
Above 960	500	54.0	3

**Laboratory Measurement Uncertainty for Radiated Emissions**

Measurement uncertainty	+5.6/ -4.5 dB
-------------------------	---------------

**Traceability**

Method	Test Equipment Used
Measurements were made per work instruction WI-03 'Measurement of Radiated Emissions'	0088, 0158, 0134, 0304, 0311, 0315, 0310, 0312

This test report may be reproduced in full only. The document may only be updated by MiCOM Labs personnel. Any changes will be noted in the Document History section of the report.



**Title:** Ear Force i30 Wireless Audio Headset  
**To:** FCC 47 CFR Part 15.247 & IC RSS-210  
**Serial #:** COMM37-U2 Rev A  
**Issue Date:** 25th September 2013  
**Page:** 71 of 127

---

### 6.1.2.2. Digital Emissions (0.03-1 GHz)

**FCC, Part 15 Subpart C §15.205/ §15.209**  
**Industry Canada RSS-Gen §7.2.5**

#### Test Procedure

Testing 30M-1 GHz was performed in a 3-meter anechoic chamber using a CISPR compliant receiver. Preliminary radiated emissions were measured on every azimuth and with the receiving antenna in both horizontal and vertical polarizations. To further maximize emissions the receive antenna was varied between 1 and 4 meters. The emissions are recorded with receiver in peak hold mode. Emissions closest to the limits are measured in the quasi-peak mode with the tuned receiver using a bandwidth of 120 kHz. Only the highest emissions relative to the limit are listed. The anechoic chamber test set-up is identified in Section 6 Test Set-Up Photographs.

The EUT had two methods of powering on ac/dc converter and Power over Ethernet (POE). Both modes were tested for emissions below 1GHz.

#### Field Strength Calculation

The field strength is calculated by adding the Antenna Factor and Cable Loss, and subtracting Amplifier Gain from the measured reading. In this test facility, the Antenna Factor, Cable Loss, and Amplifier Gains are loaded into the Rohde & Schwarz Receiver and the corrected field strength can be read directly on the receiver.

$$FS = R + AF + CORR$$

where:

FS = Field Strength  
R = Measured Receiver Input Amplitude  
AF = Antenna Factor  
CORR = Correction Factor = CL – AG + NFL  
CL = Cable Loss  
AG = Amplifier Gain

For example:

Given a Receiver input reading of 51.5dB $\mu$ V; Antenna Factor of 8.5dB; Cable Loss of 1.3dB; Falloff Factor of 0dB, an Amplifier Gain of 26dB and Notch Filter Loss of 1dB. The Field Strength of the measured emission is:

$$FS = 51.5 + 8.5 + 1.3 - 26.0 + 1 = 36.3\text{dB}\mu\text{V}/\text{m}$$

Conversion between dB $\mu$ V/m (or dB $\mu$ V) and  $\mu$ V/m (or  $\mu$ V) are done as:

$$\text{Level (dB}\mu\text{V}/\text{m)} = 20 * \text{Log (level (\mu\text{V}/\text{m}))}$$

$$\begin{aligned} 40 \text{ dB}\mu\text{V}/\text{m} &= 100\mu\text{V}/\text{m} \\ 48 \text{ dB}\mu\text{V}/\text{m} &= 250\mu\text{V}/\text{m} \end{aligned}$$

---

This test report may be reproduced in full only. The document may only be updated by MiCOM Labs personnel. Any changes will be noted in the Document History section of the report.



**Title:** Ear Force i30 Wireless Audio Headset  
**To:** FCC 47 CFR Part 15.247 & IC RSS-210  
**Serial #:** COMM37-U2 Rev A  
**Issue Date:** 25th September 2013  
**Page:** 72 of 127

<b>Test Freq.</b>	NA	<b>Engineer</b>	JMH
<b>Variant</b>	Digital Emissions	<b>Temp (°C)</b>	25
<b>Freq. Range</b>	30 MHz - 1000 MHz	<b>Rel. Hum.(%)</b>	32
<b>Power Setting</b>	NA	<b>Press. (mBars)</b>	1002
<b>Antenna</b>	2.8		
<b>Test Notes 1</b>			

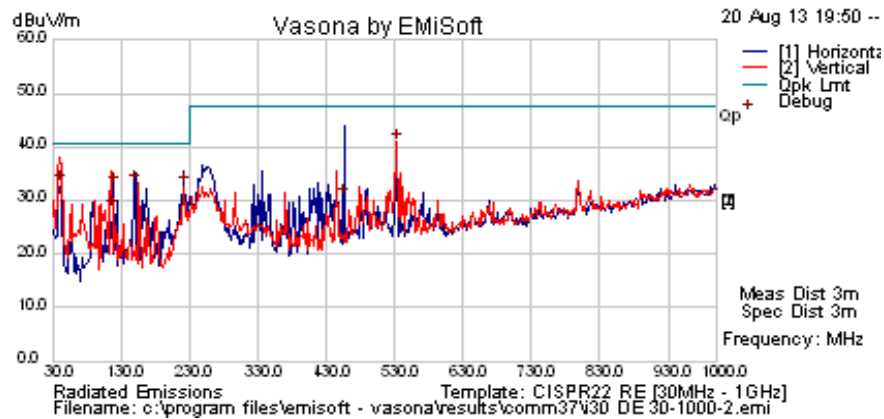

### Formally measured emission peaks

Frequency MHz	Raw dBuV	Cable Loss	AF dB	Level dBuV/m	Measurement Type	Pol	Hgt cm	Azt Deg	Limit dBuV/m	Margin dB	Pass /Fail	Comments
533.251	47.2	6.0	-12.2	40.9	Peak [Scan]	V	150	89	47.5	-6.6	Pass	
150.521	47.6	4.4	-18.8	33.2	Peak [Scan]	H	100	0	40.5	-7.3	Pass	
41.900	48.4	3.6	-19.0	33.0	Quasi Peak.	V	99	142	40.5	-7.5	Pass	
222.721	47.8	4.7	-19.7	32.8	Quasi Peak.	H	133	157	40.5	-7.7	Pass	
119.419	46.0	4.2	-17.5	32.7	Peak [Scan]	H	150	0	40.5	-7.8	Pass	
117.343	41.8	4.2	-17.7	28.3	Quasi Max	V	150	183	40.5	-12.2	Pass	
456.833	38.7	5.7	-13.7	30.7	Quasi Peak.	H	148	216	47.5	-16.8	Pass	

Legend: DIG = Digital Device Emission; TX = Transmitter Emission; FUND = Fundamental Frequency  
 NRB = Non-Restricted Band, Limit is 20 dB below Fundamental; RB = Restricted Band

This test report may be reproduced in full only. The document may only be updated by MiCOM Labs personnel. Any changes will be noted in the Document History section of the report.





**Title:** Ear Force i30 Wireless Audio Headset  
**To:** FCC 47 CFR Part 15.247 & IC RSS-210  
**Serial #:** COMM37-U2 Rev A  
**Issue Date:** 25th September 2013  
**Page:** 73 of 127

## Specification

### Limits

**§15.205 (a)** Except as shown in paragraph (d) of 15.205 (a), only spurious emissions are permitted in any of the frequency bands listed.

**§15.205 (a)** Except as shown in paragraphs (d) and (e) of this section, the field strength of emissions appearing within these frequency bands shall not exceed the limits shown in Section §15.209. At frequencies equal to or less than 1000 MHz, compliance with the limits in Section 15.209 shall be demonstrated using measurement instrumentation employing a CISPR quasi-peak detector. Above 1000 MHz, compliance with the emission limits in Section 15.209 shall be demonstrated based on the average value of the measured emissions. The provisions in Section 15.35 apply to these measurements.

**§15.209 (a)** Except as provided elsewhere in this subpart, the emissions from an intentional radiator shall not exceed the field strength levels specified in the following table.

### §15.209 (a) and Industry Canada RSS-Gen §7.2.5 Limit Matrix

Frequency(MHz)	Field Strength ( $\mu\text{V}/\text{m}$ )	Field Strength ( $\text{dB}\mu\text{V}/\text{m}$ )	Measurement Distance (meters)
30-88	100	40.0	3
88-216	150	43.5	3
216-960	200	46.0	3
Above 960	500	54.0	3

### Laboratory Measurement Uncertainty for Radiated Emissions

Measurement uncertainty	+5.6/ -4.5 dB
-------------------------	---------------

### Traceability

Method	Test Equipment Used
Measurements were made per work instruction WI-03 'Measurement of Radiated Emissions'	0088, 0158, 0134, 0304, 0311, 0315, 0310, 0312

This test report may be reproduced in full only. The document may only be updated by MiCOM Labs personnel. Any changes will be noted in the Document History section of the report.

### 6.1.3. AC Wireline Conducted Emissions (150 kHz – 30 MHz)

**Not required - EUT is power by Battery only.**

**FCC, Part 15 Subpart C §15.207**  
**Industry Canada RSS-Gen §7.2.4**

#### **Test Procedure**

The EUT is configured in accordance with ANSI C63.4. The conducted emissions are measured in a shielded room with a spectrum analyzer in peak hold in the first instance. Emissions closest to the limit are measured in the quasi-peak mode (QP) with the tuned receiver using a bandwidth of 9 kHz. The emissions are maximized further by cable manipulation. The highest emissions relative to the limit are listed.

#### **Test Measurement Set up**

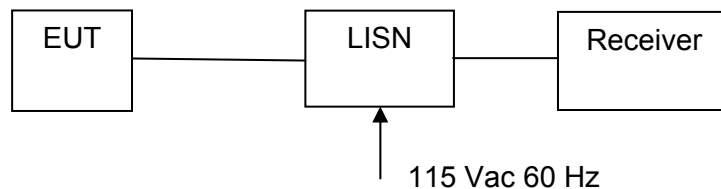

Measurement set up for AC Wireline Conducted Emissions Test

#### **Measurement Results for AC Wireline Conducted Emissions (150 kHz – 30 MHz)**

Ambient conditions.

Temperature: 17 to 23 °C    Relative humidity: 31 to 57 %    Pressure: 999 to 1012 mbar

**Not required - EUT is power by Battery only.**

## Specification

### Limit

**§15.207 (a)** Except as shown in paragraphs (b) and (c) of this section, for an intentional radiator that is designed to be connected to the public utility (AC) power line, the radio frequency voltage that is conducted back onto the AC power line on any frequency or frequencies within the band 150 kHz to 30 MHz shall not exceed the limits in the following table, as measured using a 50  $\mu\Omega$  line impedance stabilization network (LISN), see §15.207 (a) matrix below. Compliance with the provisions of this paragraph shall be based on the measurement of the radio frequency voltage between each power line and ground at the power terminal.

### RSS-Gen §7.2.4

Except when the requirements applicable to a given device state otherwise, for any radio apparatus equipped to operate from the public utility AC power supply, either directly or indirectly (such as with a battery charger), the radio frequency voltage of emissions conducted back onto the AC power lines in the frequency range of 0.15 MHz to 30 MHz shall not exceed the limits shown in the table below. The more stringent limit applies at the frequency range boundaries. The conducted emissions shall be measured with a 50 ohm/50 microhenry line impedance stabilization network (LISN).

### §15.207 (a) and RSS-Gen §7.2.4 Limit Matrix

The lower limit applies at the boundary between frequency ranges

Frequency of Emission (MHz)	Conducted Limit (dB $\mu$ V)	
	Quasi-peak	Average
0.15-0.5	66 to 56*	56 to 46*
0.5-5	56	46
5-30	60	50

\* Decreases with the logarithm of the frequency

### Laboratory Measurement Uncertainty for Conducted Emissions

Measurement uncertainty	$\pm 2.64$ dB
-------------------------	---------------

### Traceability

Method	Test Equipment Used
Measurements were made per work instruction WI-EMC-01 'Measurement of Conducted Emissions'	0158, 0184, 0287, 0190, 0293, 0307

This test report may be reproduced in full only. The document may only be updated by MiCOM Labs personnel. Any changes will be noted in the Document History section of the report.

## 7. PHOTOGRAPHS

### 7.1. Conducted Test Setup

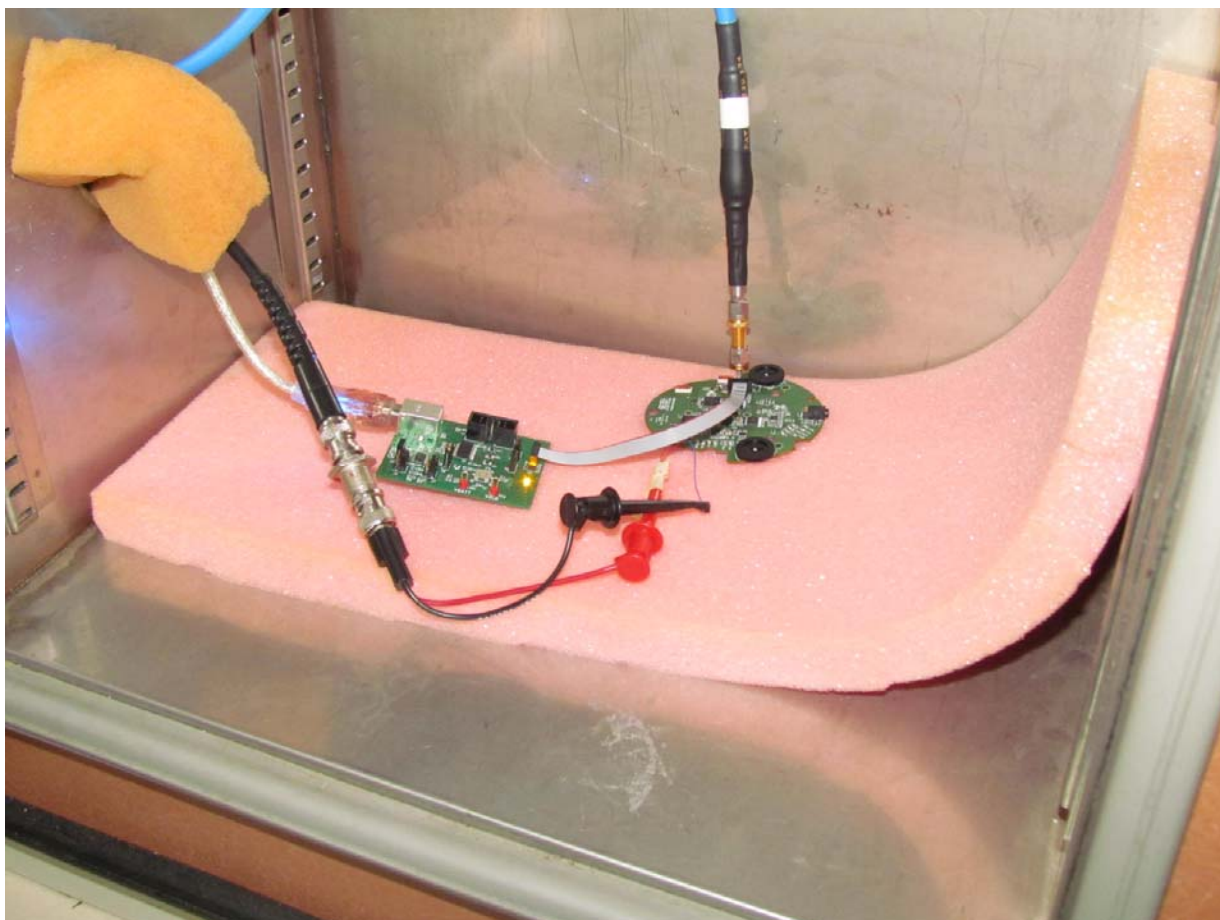

---

This test report may be reproduced in full only. The document may only be updated by MiCOM Labs personnel. Any changes will be noted in the Document History section of the report.

## 7.2. Radiated Emissions Test Setup > 1 GHz

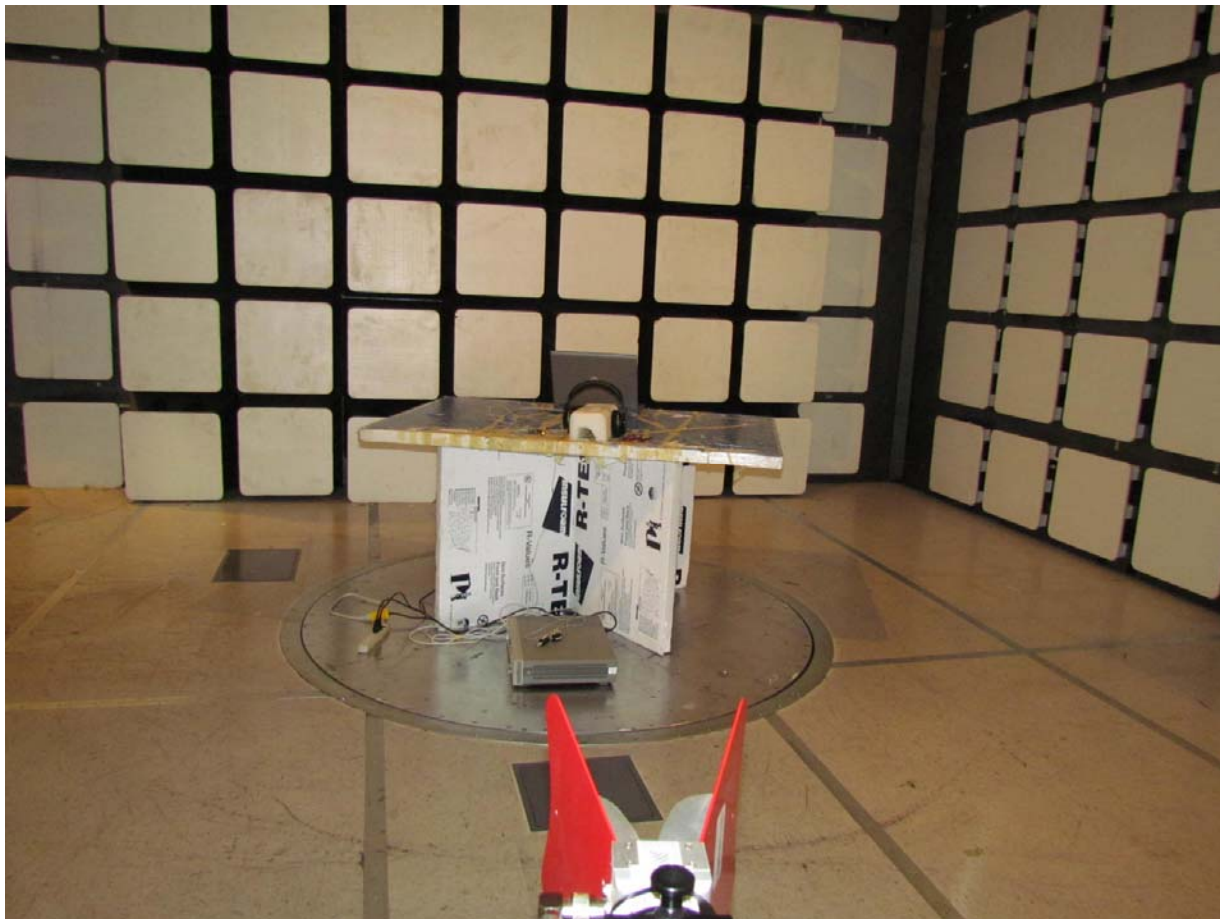

---

This test report may be reproduced in full only. The document may only be updated by MiCOM Labs personnel. Any changes will be noted in the Document History section of the report.



**Title:** Ear Force i30 Wireless Audio Headset  
**To:** FCC 47 CFR Part 15.247 & IC RSS-210  
**Serial #:** COMM37-U2 Rev A  
**Issue Date:** 25th September 2013  
**Page:** 78 of 127

## 8. TEST EQUIPMENT

Asset #	Instrument	Manufacturer	Part #	Serial #	Calibration Due Date
0070	Power Meter	Hewlett Packard	437B	3125U11552	28 <sup>th</sup> Nov 13
0117	Power Sensor	Hewlett Packard	8487D	3318A00371	15 <sup>th</sup> Nov 13
0223	Power Meter	Hewlett Packard	EPM-442A	US37480256	15 <sup>th</sup> Nov 13
0374	Power Sensor	Hewlett Packard	8485A	3318A19694	29 <sup>th</sup> Nov 13
0376	Power Sensor	Agilent	U2000A	MY51440005	8 <sup>th</sup> Dec 13
0158	Barometer /Thermometer	Control Co.	4196	E2846	8 <sup>th</sup> Dec 13
0193	EMI Receiver	Rhode & Schwartz	ESI 7	838496/007	2 <sup>nd</sup> Dec 13
0287	EMI Receiver	Rhode & Schwartz	ESIB40	100201	16 <sup>th</sup> Nov 13
0338	30 - 3000 MHz Antenna	Sunol	JB3	A052907	8 <sup>th</sup> Nov 13
0335	1-18 GHz Horn Antenna	EMCO	3117	00066580	7 <sup>th</sup> Nov 13
0252	SMA Cable	Megaphase	Sucoflex 104	None	N/A
0293	BNC Cable	Megaphase	1689 1GVT4	15F50B001	N/A
0307	BNC Cable	Megaphase	1689 1GVT4	15F50B002	N/A
0310	2m SMA Cable	Micro-Coax	UFA210A-0-0787-3G03G0	209089-001	N/A
0312	3m SMA Cable	Micro-Coax	UFA210A-1-1181-3G0300	209092-001	N/A
0314	30dB N-Type Attenuator	ARRA	N9444-30	1623	N/A
	EMC Test Software	EMISoft	Vasona	5.0051	N/A
	RF Conducted Test Software	National Instruments	Labview	Version 8.2	N/A
	RF Conducted Test Software	MiCOM Labs ATS		Version 1.5	N/A

This test report may be reproduced in full only. The document may only be updated by MiCOM Labs personnel. Any changes will be noted in the Document History section of the report.



**Title:** Ear Force i30 Wireless Audio Headset  
**To:** FCC 47 CFR Part 15.247 & IC RSS-210  
**Serial #:** COMM37-U2 Rev A  
**Issue Date:** 25th September 2013  
**Page:** 79 of 127

---

## **APPENDIX**

### **A. SUPPORTING INFORMATION**

#### **A.1. CONDUCTED TEST PLOTS**

---

This test report may be reproduced in full only. The document may only be updated by MiCOM Labs personnel. Any changes will be noted in the Document History section of the report.



**Title:** Ear Force i30 Wireless Audio Headset  
**To:** FCC 47 CFR Part 15.247 & IC RSS-210  
**Serial #:** COMM37-U2 Rev A  
**Issue Date:** 25th September 2013  
**Page:** 80 of 127

**A.1.1. 6 dB & 99% Bandwidth**



**6 dB & 20 dB BANDWIDTH**

Variant: 802.15 DH1, Channel: 2402.00 MHz, Chain a, Temp: Ambient, Voltage: 3.7 Vdc

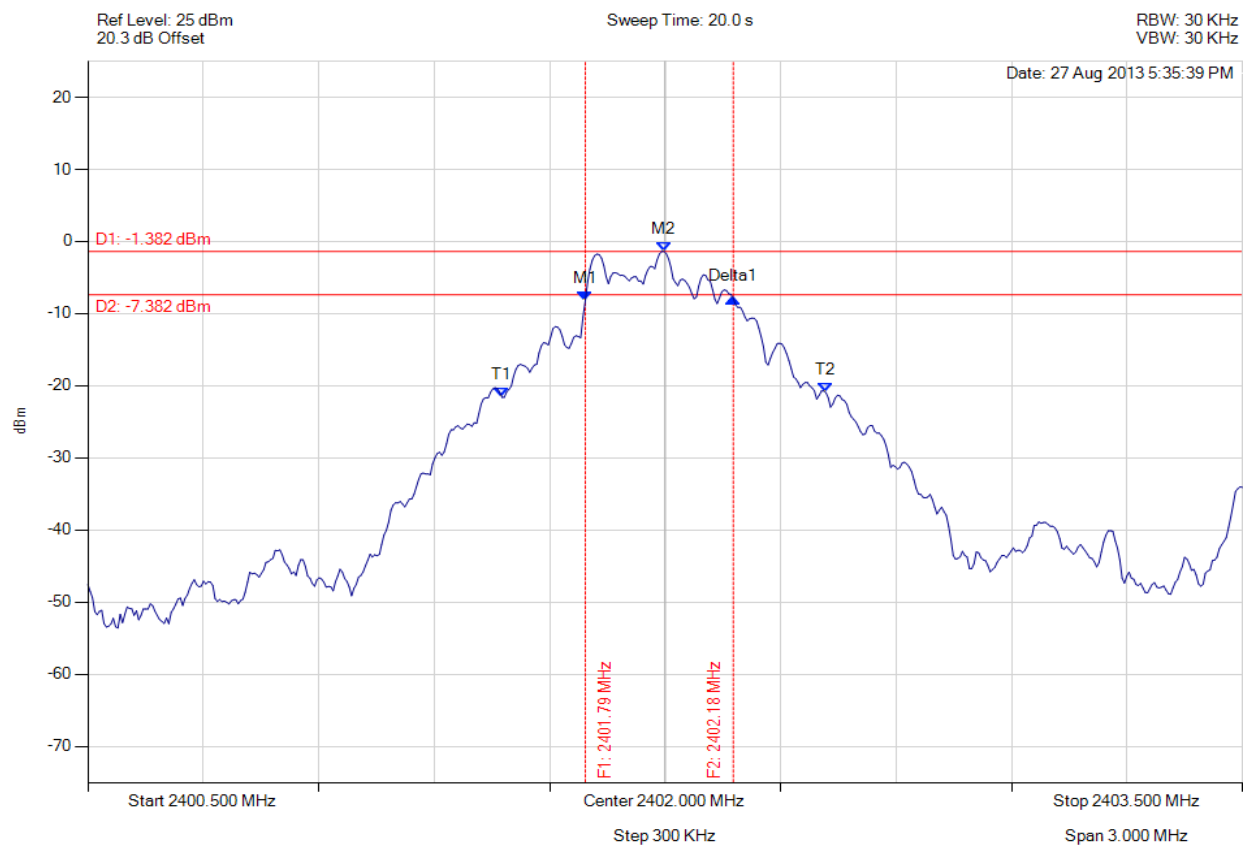

Analyser Setup	Marker : Frequency : Amplitude	Test Results
Detector = MAX PEAK Sweep Count = 0 RF Atten (dB) = 20 Trace Mode = VIEW	M1 : 2401.793 MHz : -8.233 dBm M2 : 2401.997 MHz : -1.382 dBm Delta1 : 385 KHz : 0.338 dB T1 : 2401.576 MHz : -21.605 dBm T2 : 2402.418 MHz : -20.959 dBm OBW : 842 KHz	Measured 6 dB Bandwidth: 0.385 MHz Limit: ≥500.0 kHz Margin: 0.11 MHz

[Back to the Matrix](#)

This test report may be reproduced in full only. The document may only be updated by MiCOM Labs personnel. Any changes will be noted in the Document History section of the report.





**Title:** Ear Force i30 Wireless Audio Headset  
**To:** FCC 47 CFR Part 15.247 & IC RSS-210  
**Serial #:** COMM37-U2 Rev A  
**Issue Date:** 25th September 2013  
**Page:** 81 of 127



**6 dB & 20 dB BANDWIDTH**

Variant: 802.15 DH1, Channel: 2441.00 MHz, Chain a, Temp: Ambient, Voltage: 3.7 Vdc

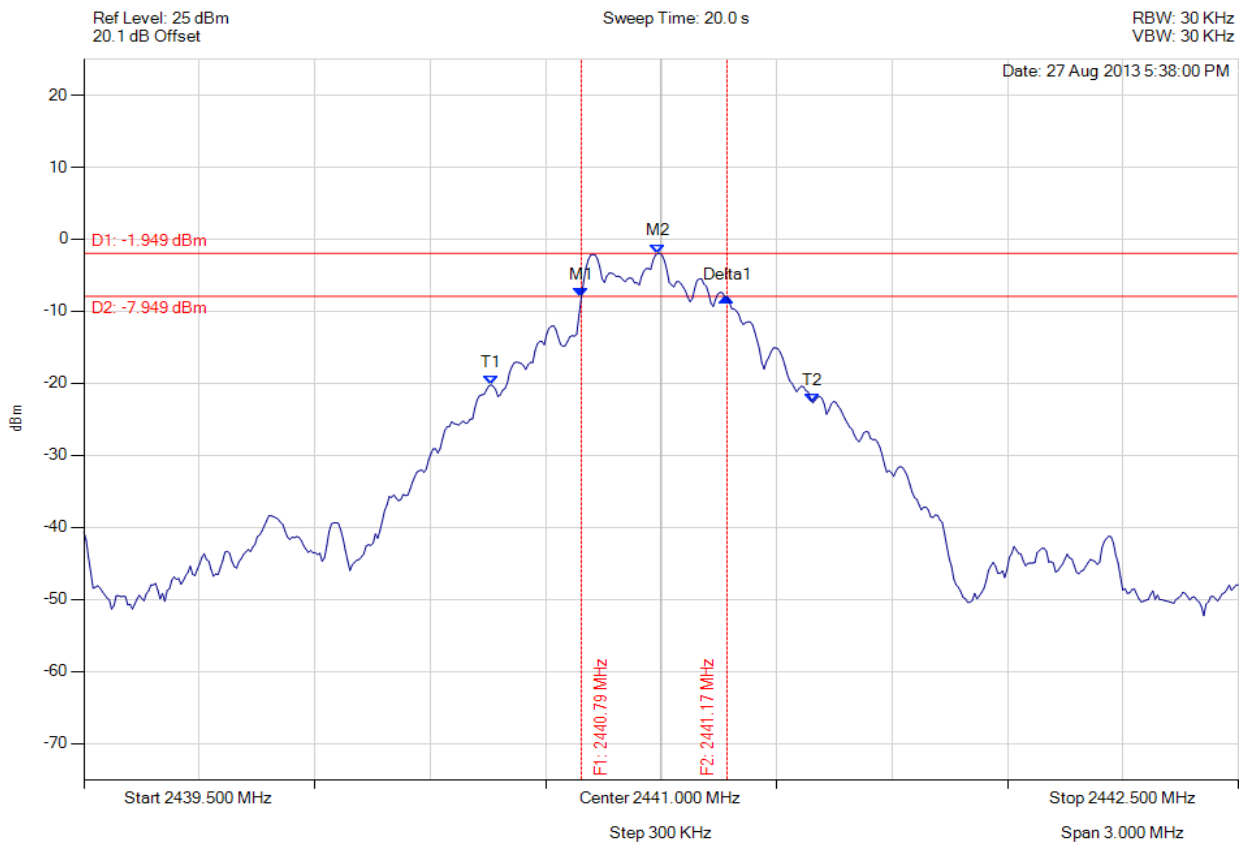

Analyser Setup	Marker : Frequency : Amplitude	Test Results
Detector = MAX PEAK Sweep Count = 0 RF Atten (dB) = 20 Trace Mode = VIEW	M1 : 2440.793 MHz : -8.103 dBm M2 : 2440.991 MHz : -1.949 dBm Delta1 : 379 KHz : 0.031 dB T1 : 2440.558 MHz : -20.228 dBm T2 : 2441.394 MHz : -22.730 dBm OBW : 836 KHz	Measured 6 dB Bandwidth: 0.379 MHz Limit: ≥500.0 kHz Margin: 0.12 MHz

[Back to the Matrix](#)

This test report may be reproduced in full only. The document may only be updated by MiCOM Labs personnel. Any changes will be noted in the Document History section of the report.



### 6 dB & 20 dB BANDWIDTH

Variant: 802.15 DH1, Channel: 2480.00 MHz, Chain a, Temp: Ambient, Voltage: 3.7 Vdc

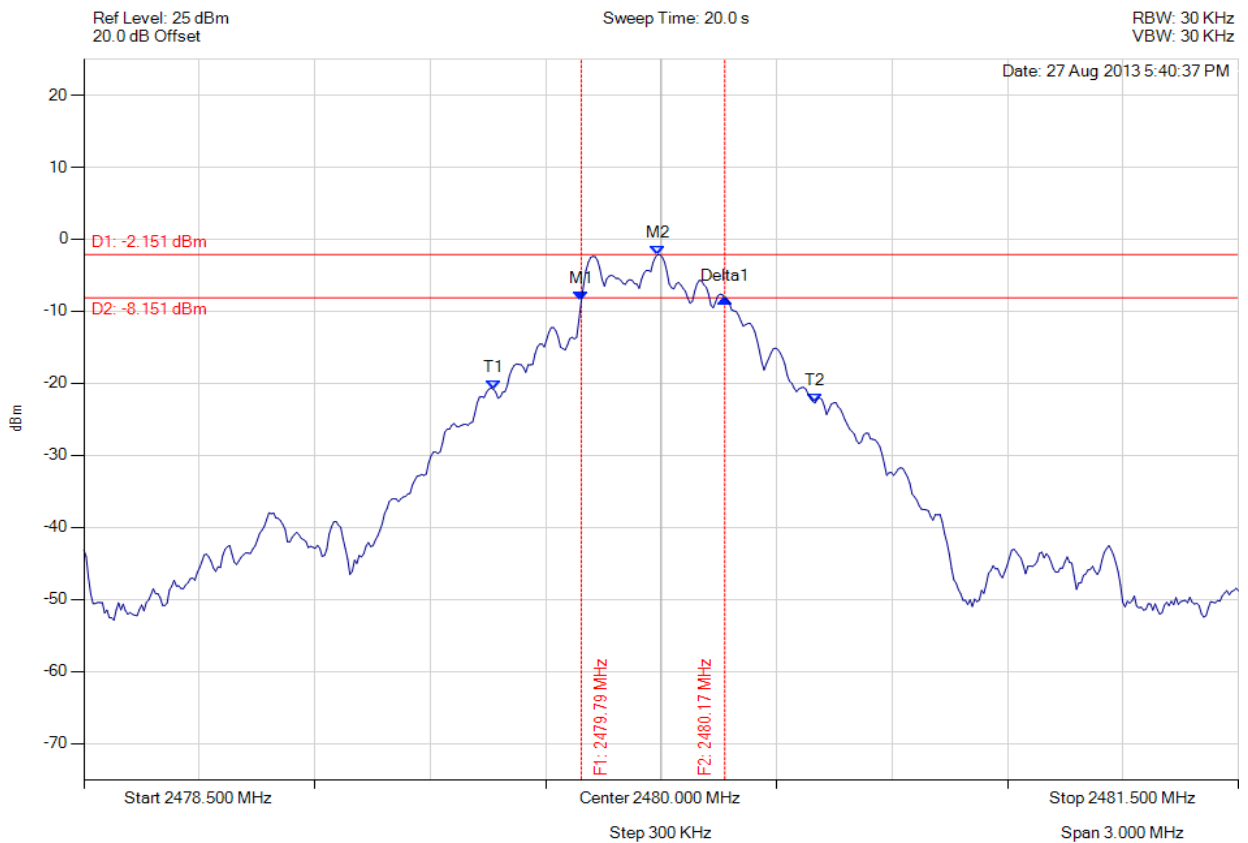

Analyser Setup	Marker : Frequency : Amplitude	Test Results
Detector = MAX PEAK Sweep Count = 0 RF Atten (dB) = 20 Trace Mode = VIEW	M1 : 2479.793 MHz : -8.555 dBm M2 : 2479.991 MHz : -2.151 dBm Delta1 : 373 KHz : 0.317 dB T1 : 2479.564 MHz : -20.812 dBm T2 : 2480.400 MHz : -22.736 dBm OBW : 836 KHz	Measured 6 dB Bandwidth: 0.373 MHz Limit: ≥500.0 kHz Margin: 0.13 MHz

[Back to the Matrix](#)

This test report may be reproduced in full only. The document may only be updated by MiCOM Labs personnel. Any changes will be noted in the Document History section of the report.



### 6 dB & 20 dB BANDWIDTH

Variant: 802.15 DH5, Channel: 2402.00 MHz, Chain a, Temp: Ambient, Voltage: 3.7 Vdc

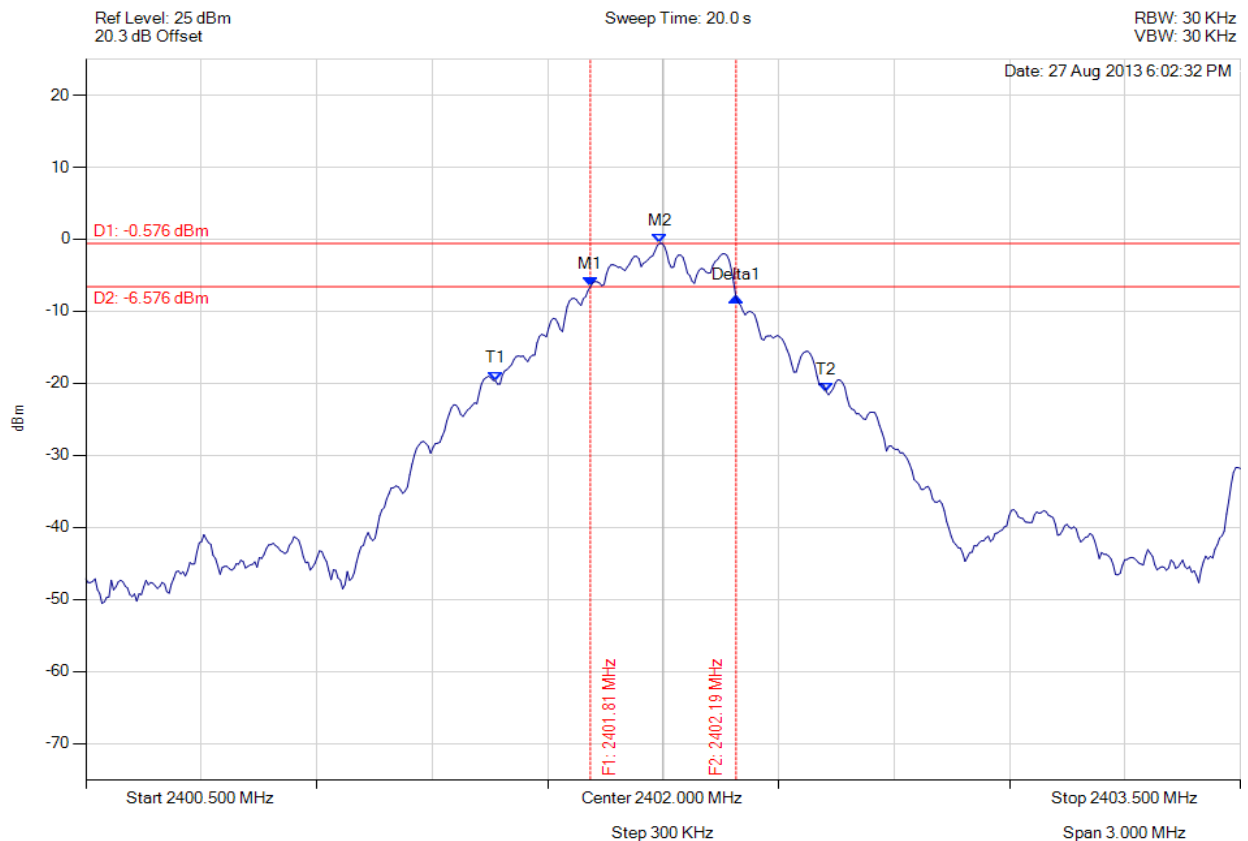

Analyser Setup	Marker : Frequency : Amplitude	Test Results
Detector = MAX PEAK Sweep Count = 0 RF Atten (dB) = 20 Trace Mode = VIEW	M1 : 2401.811 MHz : -6.608 dBm M2 : 2401.991 MHz : -0.576 dBm Delta1 : 379 KHz : -1.501 dB T1 : 2401.564 MHz : -19.637 dBm T2 : 2402.424 MHz : -21.174 dBm OBW : 860 KHz	Measured 6 dB Bandwidth: 0.379 MHz Limit: ≥500.0 kHz Margin: 0.12 MHz

[Back to the Matrix](#)

This test report may be reproduced in full only. The document may only be updated by MiCOM Labs personnel. Any changes will be noted in the Document History section of the report.

### 6 dB & 20 dB BANDWIDTH

Variant: 802.15 DH5, Channel: 2441.00 MHz, Chain a, Temp: Ambient, Voltage: 3.7 Vdc

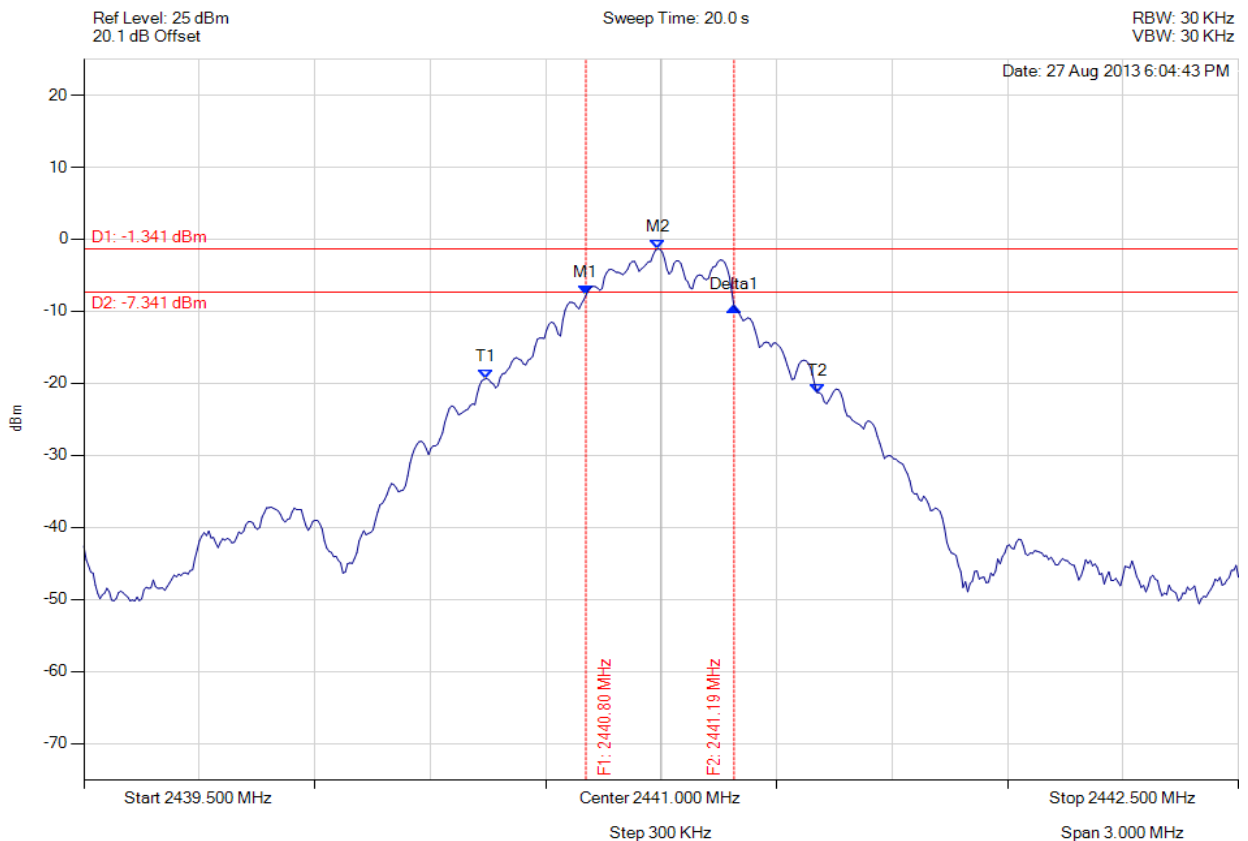

Analyser Setup	Marker : Frequency : Amplitude	Test Results
Detector = MAX PEAK Sweep Count = 0 RF Atten (dB) = 20 Trace Mode = VIEW	M1 : 2440.805 MHz : -7.764 dBm M2 : 2440.991 MHz : -1.341 dBm Delta1 : 385 KHz : -1.580 dB T1 : 2440.546 MHz : -19.342 dBm T2 : 2441.406 MHz : -21.312 dBm OBW : 860 KHz	Measured 6 dB Bandwidth: 0.385 MHz Limit: ≥500.0 kHz Margin: 0.11 MHz

[Back to the Matrix](#)

This test report may be reproduced in full only. The document may only be updated by MiCOM Labs personnel. Any changes will be noted in the Document History section of the report.



### 6 dB & 20 dB BANDWIDTH

Variant: 802.15 DH5, Channel: 2480.00 MHz, Chain a, Temp: Ambient, Voltage: 3.7 Vdc

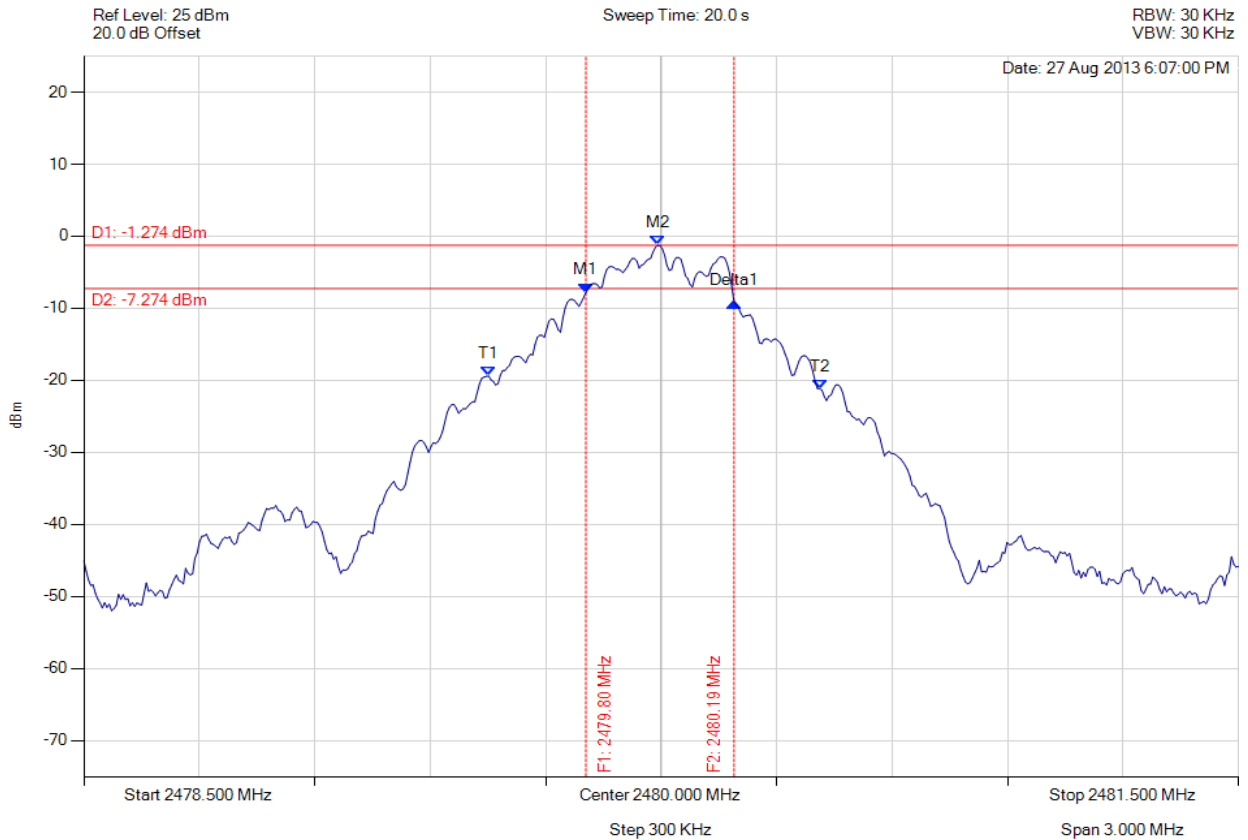

Analyser Setup	Marker : Frequency : Amplitude	Test Results
Detector = MAX PEAK Sweep Count = 0 RF Atten (dB) = 20 Trace Mode = VIEW	M1 : 2479.805 MHz : -7.788 dBm M2 : 2479.991 MHz : -1.274 dBm Delta1 : 385 KHz : -1.375 dB T1 : 2479.552 MHz : -19.419 dBm T2 : 2480.412 MHz : -21.174 dBm OBW : 860 KHz	Measured 6 dB Bandwidth: 0.385 MHz Limit: $\geq 500.0$ kHz Margin: 0.11 MHz

[Back to the Matrix](#)

This test report may be reproduced in full only. The document may only be updated by MiCOM Labs personnel. Any changes will be noted in the Document History section of the report.



**Title:** Ear Force i30 Wireless Audio Headset  
**To:** FCC 47 CFR Part 15.247 & IC RSS-210  
**Serial #:** COMM37-U2 Rev A  
**Issue Date:** 25th September 2013  
**Page:** 86 of 127



**6 dB & 20 dB BANDWIDTH**

Variant: 802.15 3-DH1, Channel: 2402.00 MHz, Chain a, Temp: Ambient, Voltage: 3.7 Vdc

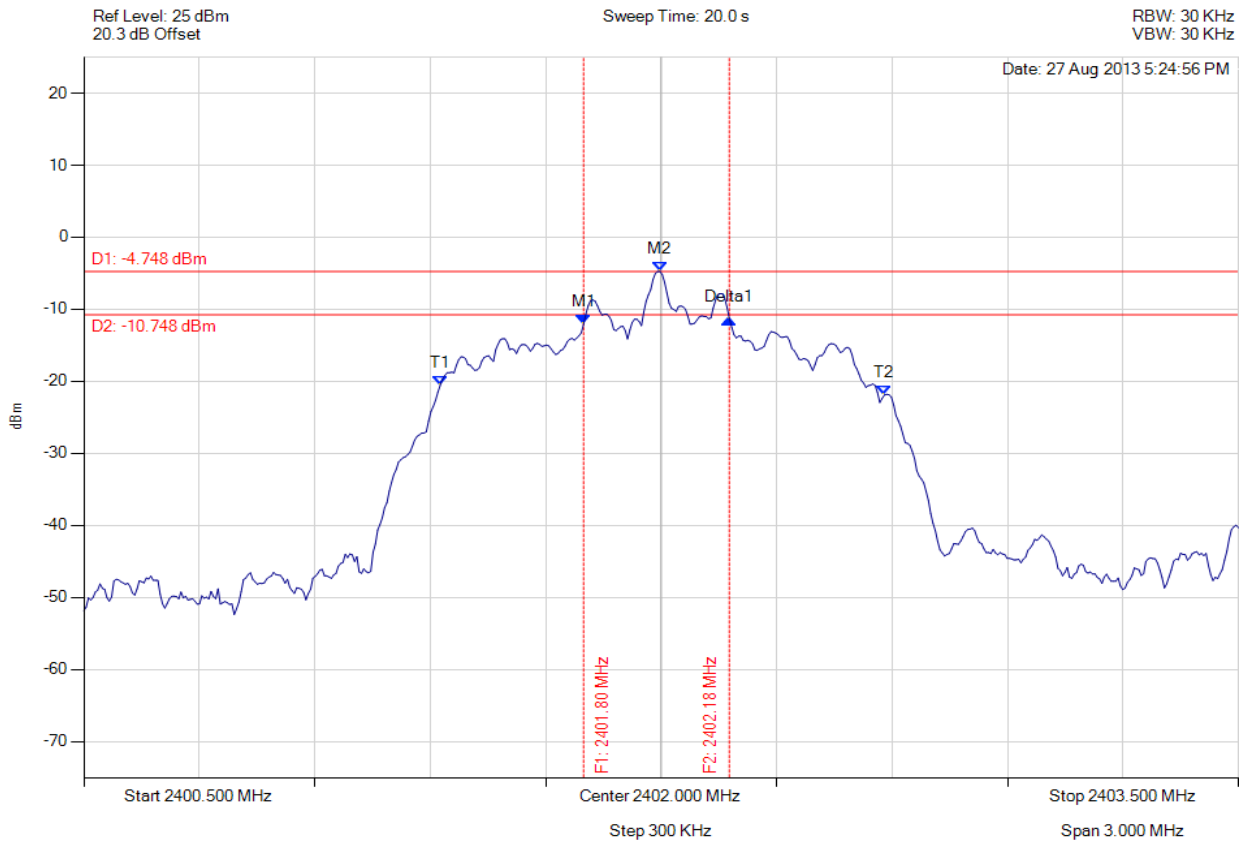

Analyser Setup	Marker : Frequency : Amplitude	Test Results
Detector = MAX PEAK Sweep Count = 0 RF Atten (dB) = 20 Trace Mode = VIEW	M1 : 2401.799 MHz : -12.026 dBm M2 : 2401.997 MHz : -4.748 dBm Delta1 : 379 KHz : 0.704 dB T1 : 2401.426 MHz : -20.590 dBm T2 : 2402.580 MHz : -21.898 dBm OBW : 1.154 MHz	Measured 6 dB Bandwidth: 0.379 MHz Limit: ≥500.0 kHz Margin: 0.12 MHz

[Back to the Matrix](#)

This test report may be reproduced in full only. The document may only be updated by MiCOM Labs personnel. Any changes will be noted in the Document History section of the report.



### 6 dB & 20 dB BANDWIDTH

Variant: 802.15 3-DH1, Channel: 2441.00 MHz, Chain a, Temp: Ambient, Voltage: 3.7 Vdc

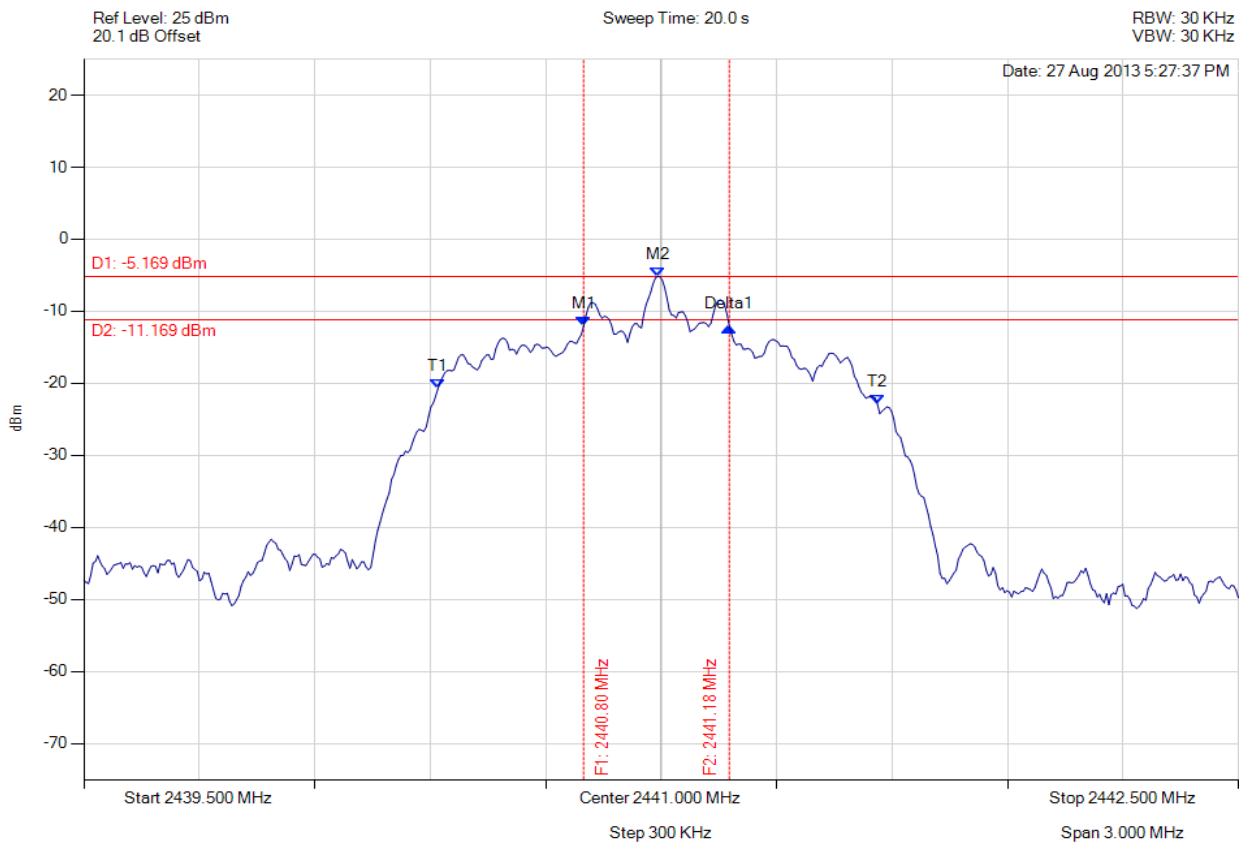

Analyser Setup	Marker : Frequency : Amplitude	Test Results
Detector = MAX PEAK Sweep Count = 0 RF Atten (dB) = 20 Trace Mode = VIEW	M1 : 2440.799 MHz : -12.059 dBm M2 : 2440.991 MHz : -5.169 dBm Delta1 : 379 KHz : -0.073 dB T1 : 2440.420 MHz : -20.776 dBm T2 : 2441.562 MHz : -22.909 dBm OBW : 1.142 MHz	Measured 6 dB Bandwidth: 0.379 MHz Limit: ≥500.0 kHz Margin: 0.12 MHz

[Back to the Matrix](#)

This test report may be reproduced in full only. The document may only be updated by MiCOM Labs personnel. Any changes will be noted in the Document History section of the report.



**Title:** Ear Force i30 Wireless Audio Headset  
**To:** FCC 47 CFR Part 15.247 & IC RSS-210  
**Serial #:** COMM37-U2 Rev A  
**Issue Date:** 25th September 2013  
**Page:** 88 of 127



**6 dB & 20 dB BANDWIDTH**

Variant: 802.15 3-DH1, Channel: 2480.00 MHz, Chain a, Temp: Ambient, Voltage: 3.7 Vdc

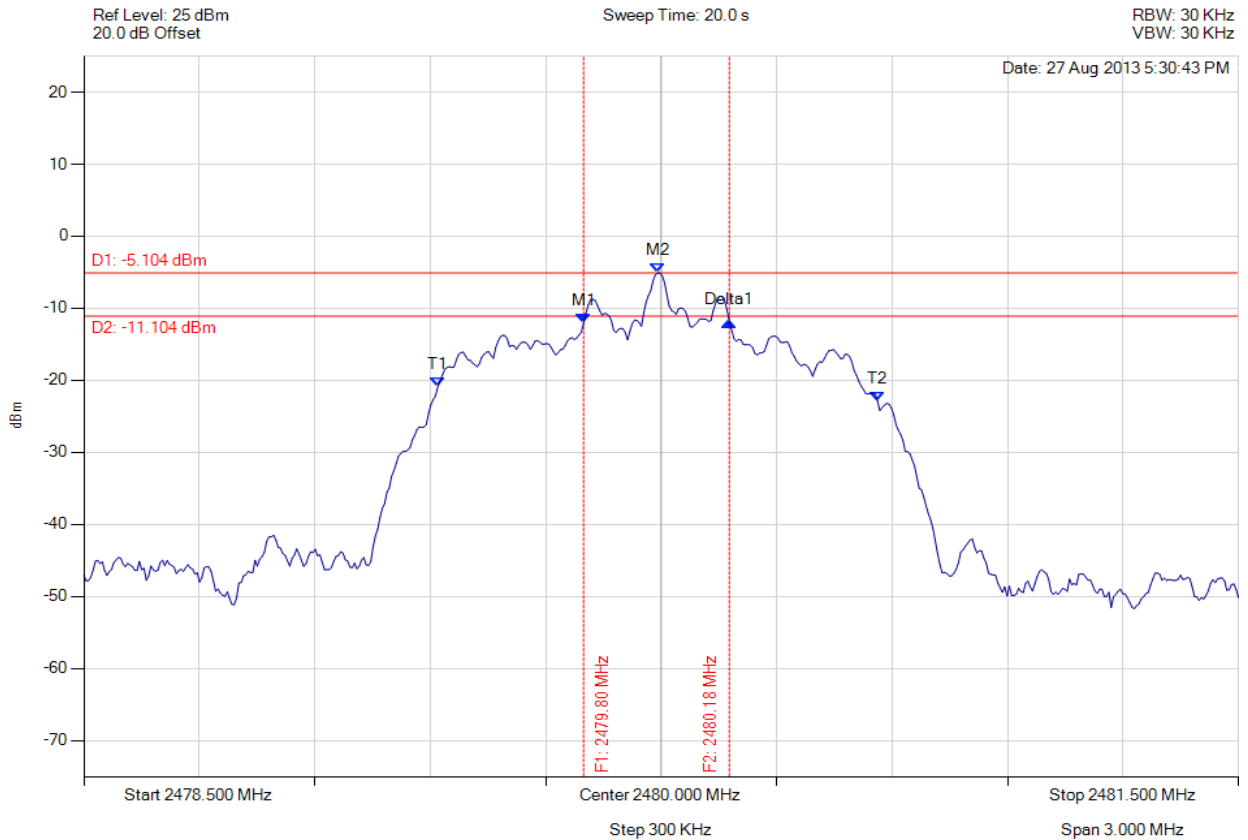

Analyser Setup	Marker : Frequency : Amplitude	Test Results
Detector = MAX PEAK Sweep Count = 0 RF Atten (dB) = 20 Trace Mode = VIEW	M1 : 2479.799 MHz : -12.041 dBm M2 : 2479.991 MHz : -5.104 dBm Delta1 : 379 KHz : 0.124 dB T1 : 2479.420 MHz : -20.877 dBm T2 : 2480.562 MHz : -22.856 dBm OBW : 1.142 MHz	Measured 6 dB Bandwidth: 0.379 MHz Limit: ≥500.0 kHz Margin: 0.12 MHz

[Back to the Matrix](#)

This test report may be reproduced in full only. The document may only be updated by MiCOM Labs personnel. Any changes will be noted in the Document History section of the report.



### 6 dB & 20 dB BANDWIDTH

Variant: 802.15, Channel: 2402.00 MHz, Chain a, Temp: Ambient, Voltage: 3.7 Vdc

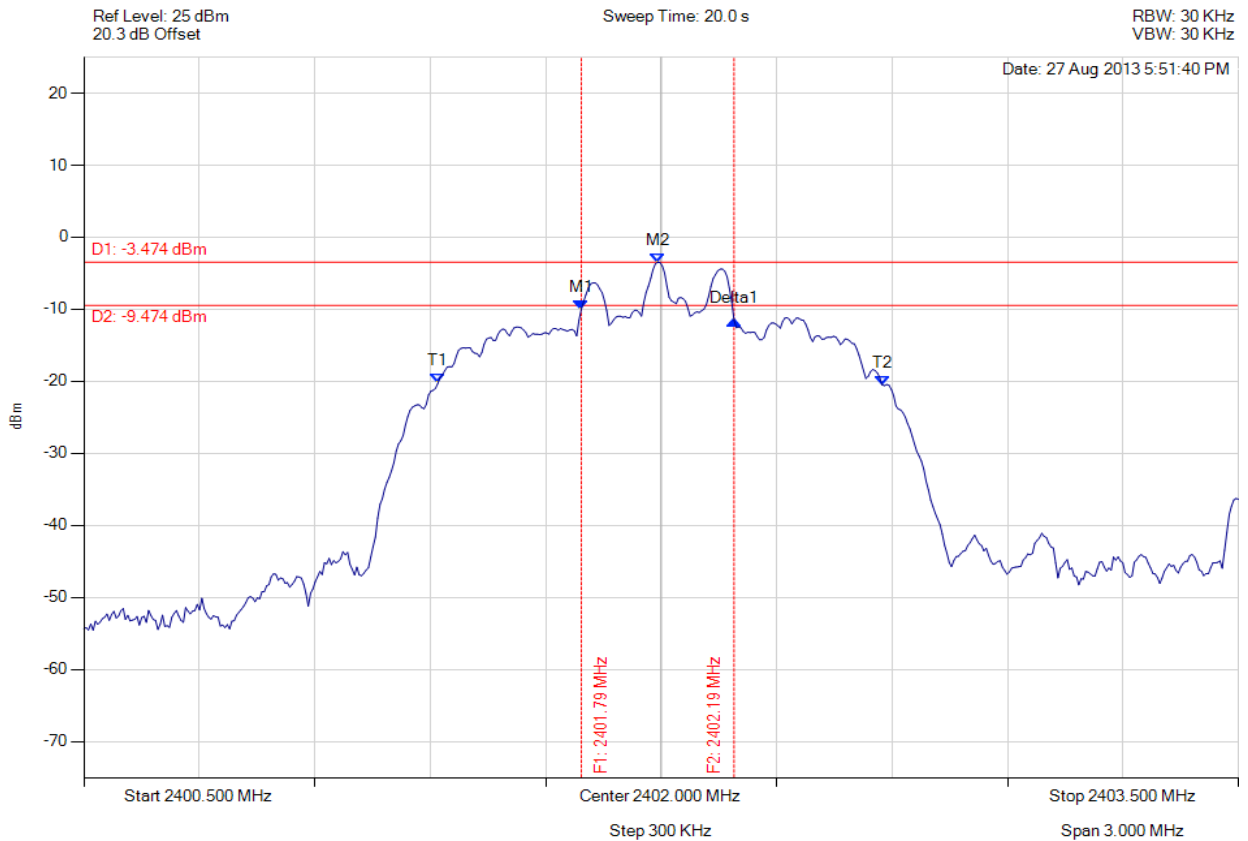

Analyser Setup	Marker : Frequency : Amplitude	Test Results
Detector = MAX PEAK Sweep Count = 0 RF Atten (dB) = 20 Trace Mode = VIEW	M1 : 2401.793 MHz : -9.991 dBm M2 : 2401.991 MHz : -3.474 dBm Delta1 : 397 KHz : -1.493 dB T1 : 2401.420 MHz : -20.289 dBm T2 : 2402.574 MHz : -20.493 dBm OBW : 1.154 MHz	Measured 6 dB Bandwidth: 0.397 MHz Limit: ≥500.0 kHz Margin: 0.10 MHz

[Back to the Matrix](#)

This test report may be reproduced in full only. The document may only be updated by MiCOM Labs personnel. Any changes will be noted in the Document History section of the report.



**Title:** Ear Force i30 Wireless Audio Headset  
**To:** FCC 47 CFR Part 15.247 & IC RSS-210  
**Serial #:** COMM37-U2 Rev A  
**Issue Date:** 25th September 2013  
**Page:** 90 of 127



### 6 dB & 20 dB BANDWIDTH

Variant: 802.15, Channel: 2441.00 MHz, Chain a, Temp: Ambient, Voltage: 3.7 Vdc

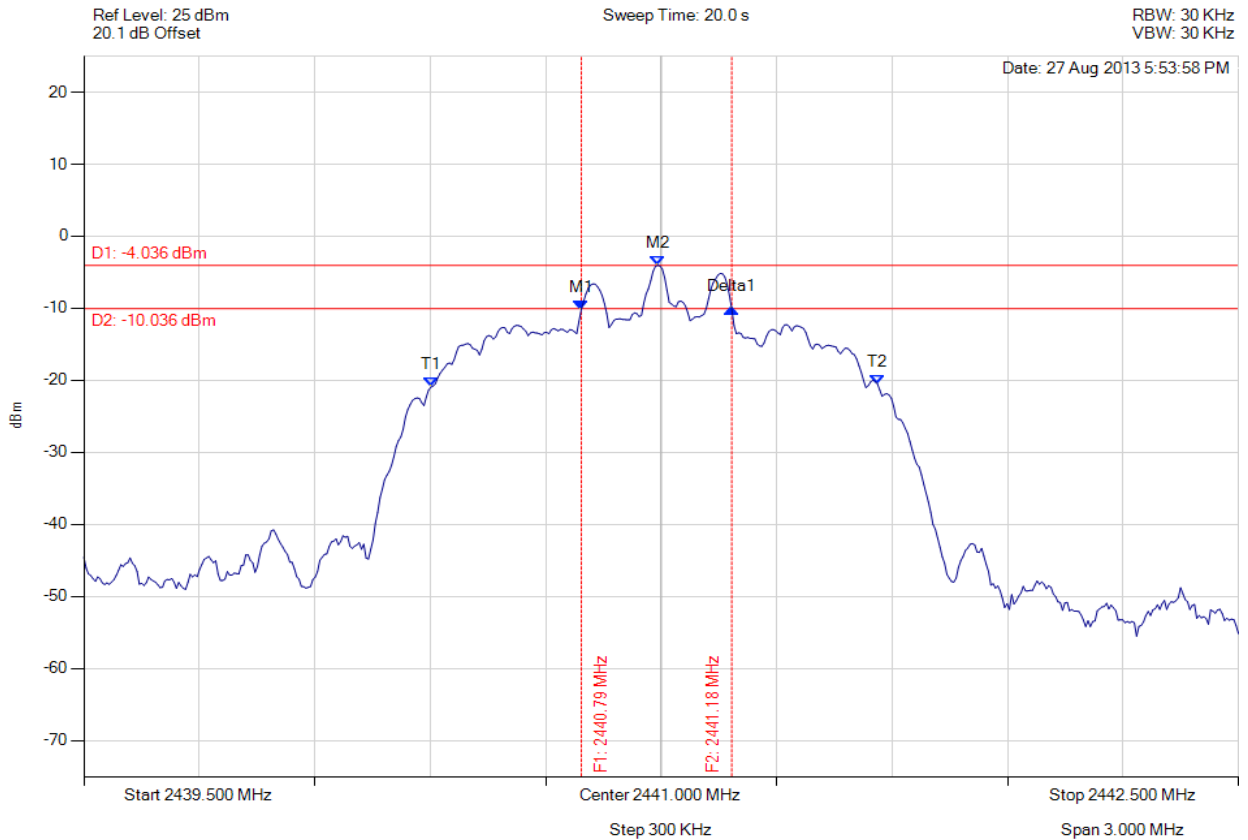

Analyser Setup	Marker : Frequency : Amplitude	Test Results
Detector = MAX PEAK Sweep Count = 0 RF Atten (dB) = 20 Trace Mode = VIEW	M1 : 2440.793 MHz : -10.157 dBm M2 : 2440.991 MHz : -4.036 dBm Delta1 : 391 KHz : 0.077 dB T1 : 2440.402 MHz : -20.938 dBm T2 : 2441.562 MHz : -20.501 dBm OBW : 1.160 MHz	Measured 6 dB Bandwidth: 0.391 MHz Limit: ≥500.0 kHz Margin: 0.11 MHz

[Back to the Matrix](#)

This test report may be reproduced in full only. The document may only be updated by MiCOM Labs personnel. Any changes will be noted in the Document History section of the report.



### 6 dB & 20 dB BANDWIDTH

Variant: 802.15, Channel: 2480.00 MHz, Chain a, Temp: Ambient, Voltage: 3.7 Vdc

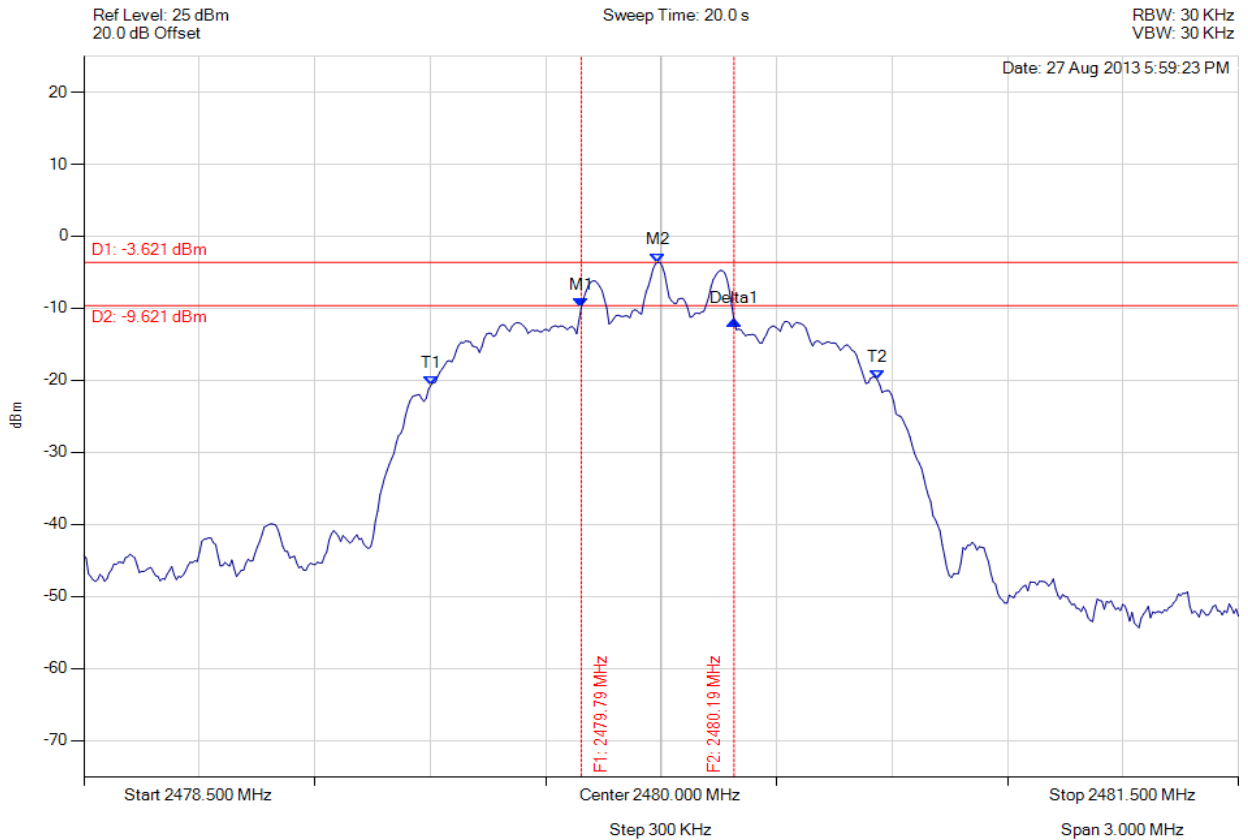

Analyser Setup	Marker : Frequency : Amplitude	Test Results
Detector = MAX PEAK Sweep Count = 0 RF Atten (dB) = 20 Trace Mode = VIEW	M1 : 2479.793 MHz : -9.852 dBm M2 : 2479.991 MHz : -3.621 dBm Delta1 : 397 KHz : -1.822 dB T1 : 2479.402 MHz : -20.662 dBm T2 : 2480.562 MHz : -19.950 dBm OBW : 1.160 MHz	Measured 6 dB Bandwidth: 0.397 MHz Limit: ≥500.0 kHz Margin: 0.10 MHz

[Back to the Matrix](#)

This test report may be reproduced in full only. The document may only be updated by MiCOM Labs personnel. Any changes will be noted in the Document History section of the report.



### A.1.2. Channel Separation



#### Channel Separation DH1

Variant: 802.15 DH1, Channel: 2441.00 MHz, Chain a, Temp: Ambient, Voltage: 3.7 Vdc

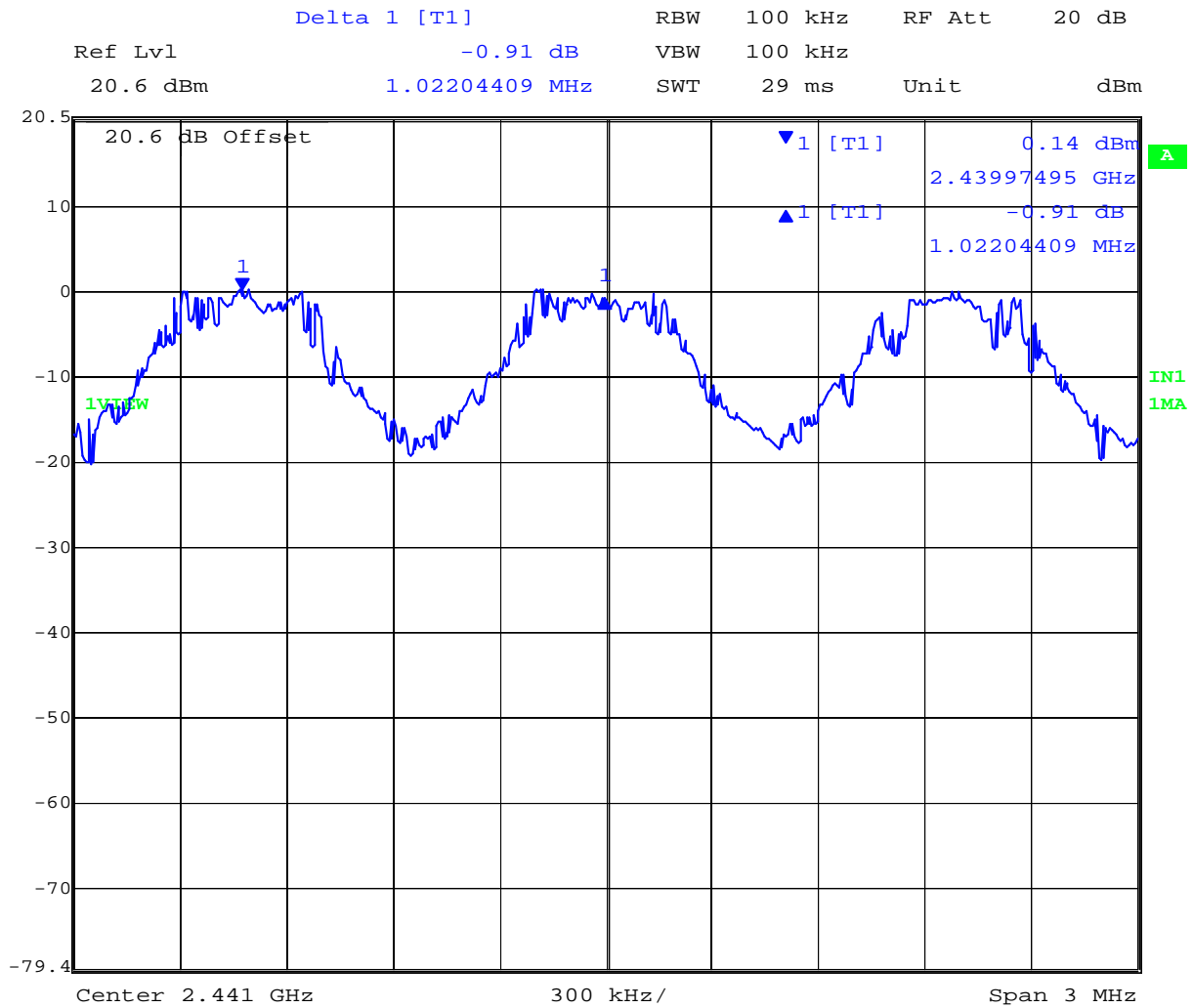

Date: 27.AUG.2013 19:07:50

Analyser Setup	Marker : Frequency : Amplitude	Test Results
Detector = Max Peak Sweep Count = 0 RF Atten (dB) = 20 Trace Mode = VIEW	M1 : 2441.00 MHz : 0.14 dBm	Channel Separation: 1.022 MHz Limit: > 1 MHz Margin: 0.022 MHz

[Back to the Matrix](#)

This test report may be reproduced in full only. The document may only be updated by MiCOM Labs personnel. Any changes will be noted in the Document History section of the report.



**Title:** Ear Force i30 Wireless Audio Headset  
**To:** FCC 47 CFR Part 15.247 & IC RSS-210  
**Serial #:** COMM37-U2 Rev A  
**Issue Date:** 25th September 2013  
**Page:** 93 of 127



**Channel Separation DH3**

Variant: 802.15 DH3, Channel: 2441.00 MHz, Chain a, Temp: Ambient, Voltage: 3.7 Vdc

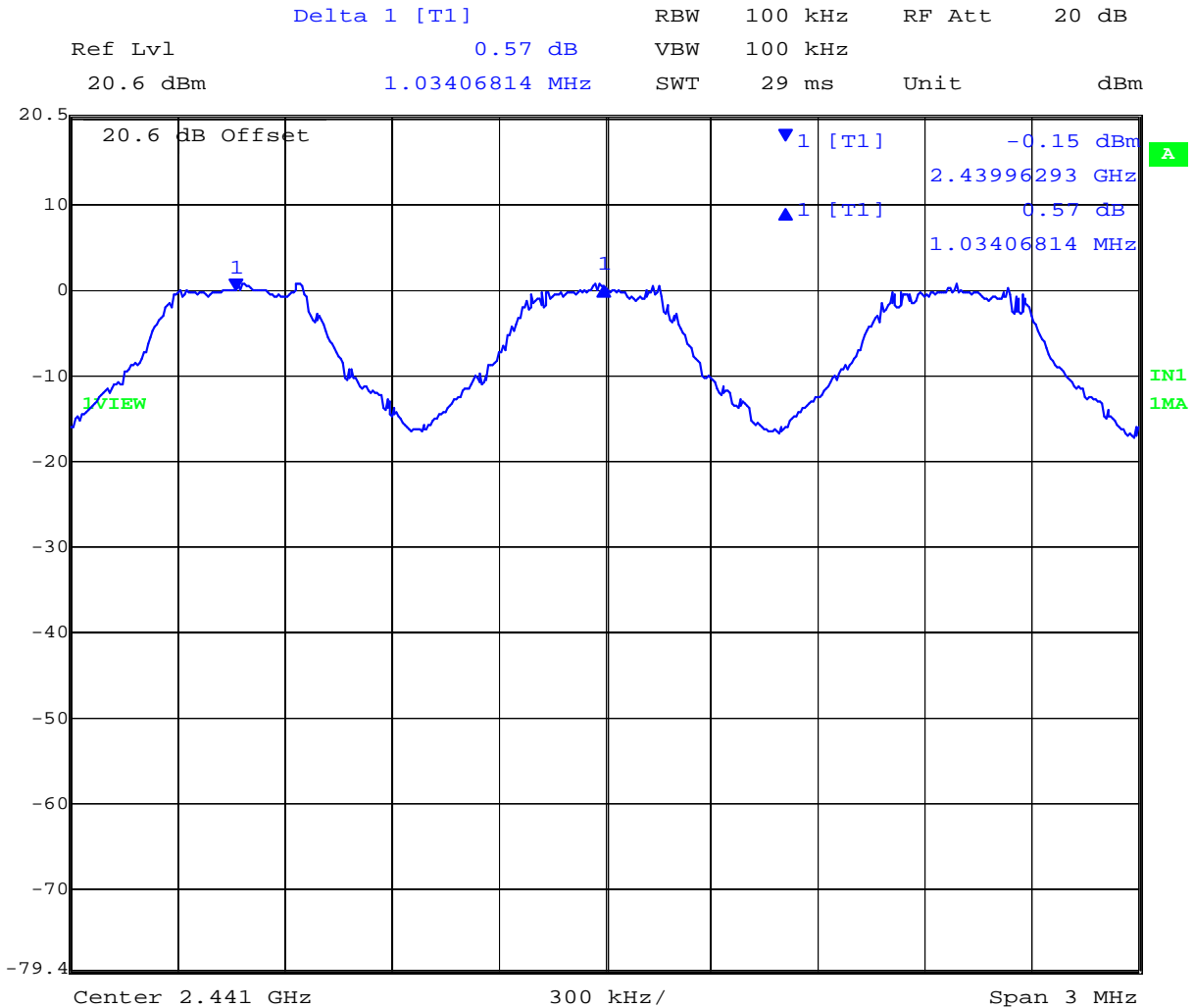

Date: 27.AUG.2013 19:11:06

Analyser Setup	Marker : Frequency : Amplitude	Test Results
Detector = Max Peak Sweep Count = 0 RF Atten (dB) = 20 Trace Mode = VIEW	M1 : 2441.00 MHz : -0.15 dBm	Channel Separation: 1.034 MHz Limit: > 1 MHz Margin: 0.034 MHz

[Back to the Matrix](#)

This test report may be reproduced in full only. The document may only be updated by MiCOM Labs personnel. Any changes will be noted in the Document History section of the report.



**Title:** Ear Force i30 Wireless Audio Headset  
**To:** FCC 47 CFR Part 15.247 & IC RSS-210  
**Serial #:** COMM37-U2 Rev A  
**Issue Date:** 25th September 2013  
**Page:** 94 of 127



**Channel Separation DH5**

Variant: 802.15 DH5, Channel: 2441.00 MHz, Chain a, Temp: Ambient, Voltage: 3.7 Vdc

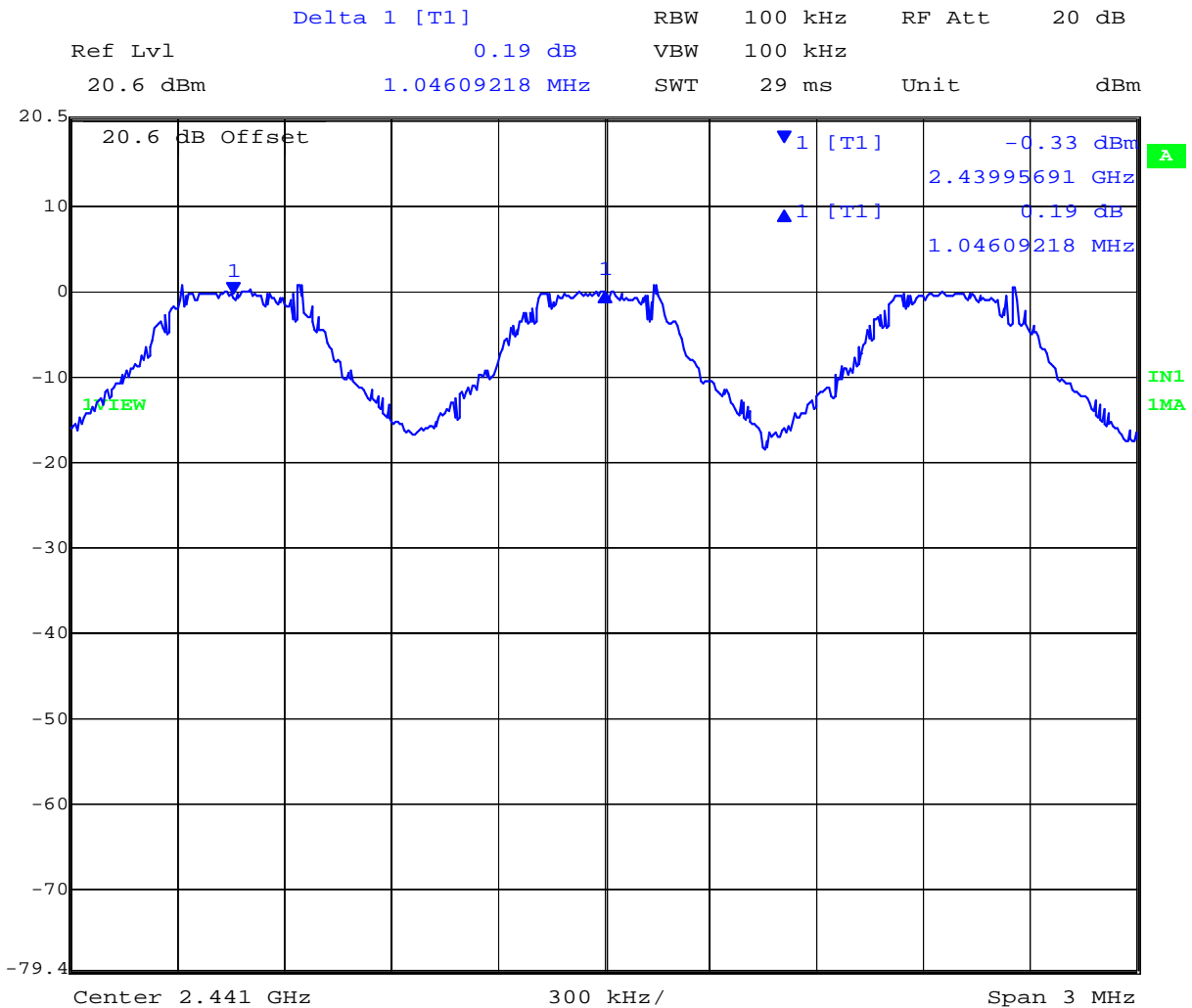

Date: 27.AUG.2013 19:13:01

Analyser Setup	Marker : Frequency : Amplitude	Test Results
Detector = Max Peak Sweep Count = 0 RF Atten (dB) = 20 Trace Mode = VIEW	M1 : 2441.00 MHz : -0.33 dBm	Channel Separation: 1.046 MHz Limit: > 1 MHz Margin: 0.046 MHz

[Back to the Matrix](#)

This test report may be reproduced in full only. The document may only be updated by MiCOM Labs personnel. Any changes will be noted in the Document History section of the report.



**Title:** Ear Force i30 Wireless Audio Headset  
**To:** FCC 47 CFR Part 15.247 & IC RSS-210  
**Serial #:** COMM37-U2 Rev A  
**Issue Date:** 25th September 2013  
**Page:** 95 of 127



**Channel Separation 2 DH1**

Variant: 802.15 2 DH1, Channel: 2441.00 MHz, Chain a, Temp: Ambient, Voltage: 3.7 Vdc

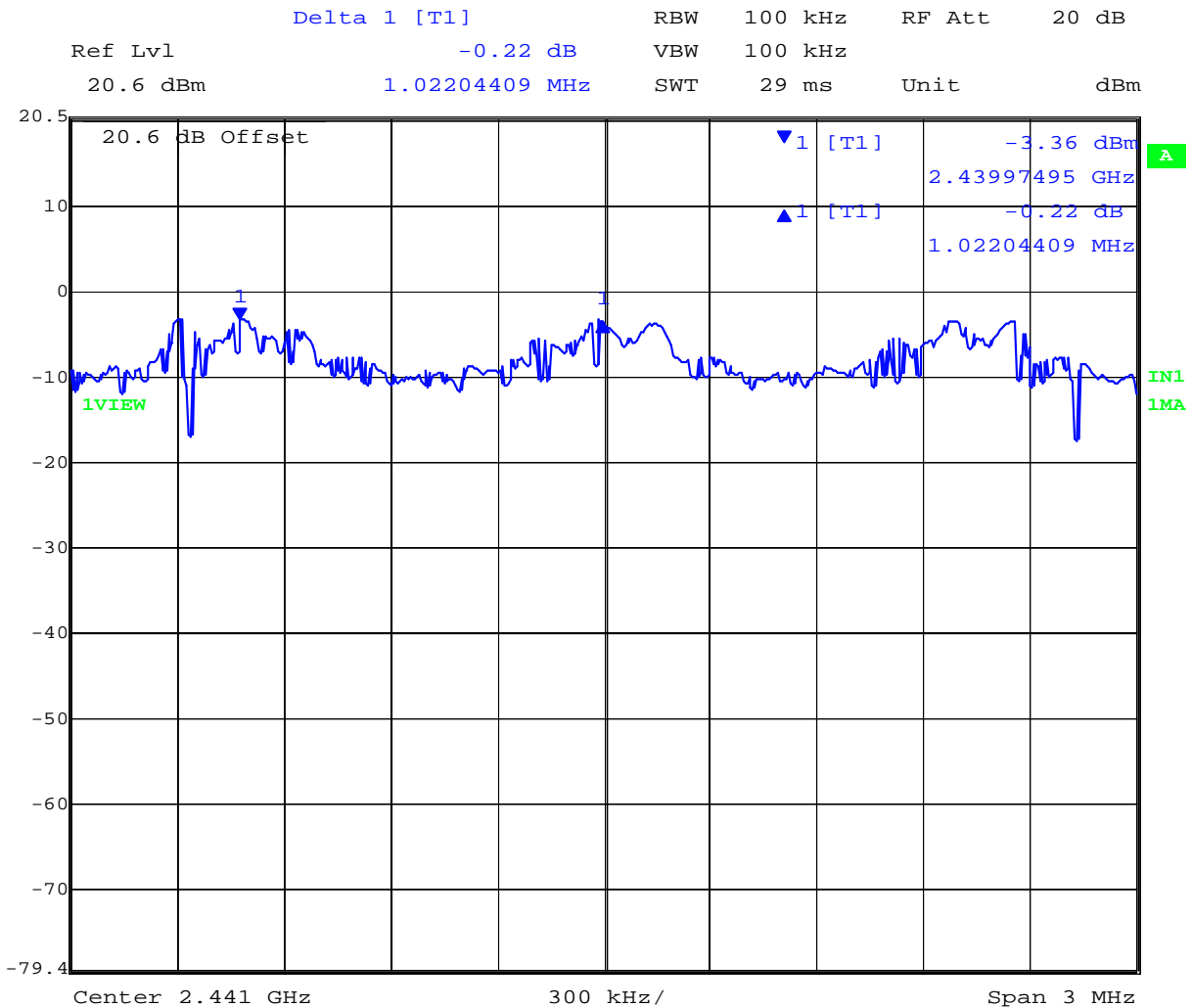

Date: 27.AUG.2013 19:15:52

Analyser Setup	Marker : Frequency : Amplitude	Test Results
Detector = Max Peak Sweep Count = 0 RF Atten (dB) = 20 Trace Mode = VIEW	M1 : 2441.00 MHz : -3.36 dBm	Channel Separation: 1.022 MHz Limit: > 1 MHz Margin: 0.022 MHz

[Back to the Matrix](#)

This test report may be reproduced in full only. The document may only be updated by MiCOM Labs personnel. Any changes will be noted in the Document History section of the report.



**Title:** Ear Force i30 Wireless Audio Headset  
**To:** FCC 47 CFR Part 15.247 & IC RSS-210  
**Serial #:** COMM37-U2 Rev A  
**Issue Date:** 25th September 2013  
**Page:** 96 of 127



**Channel Separation 2 DH5**

Variant: 802.15 2 DH5, Channel: 2441.00 MHz, Chain a, Temp: Ambient, Voltage: 3.7 Vdc

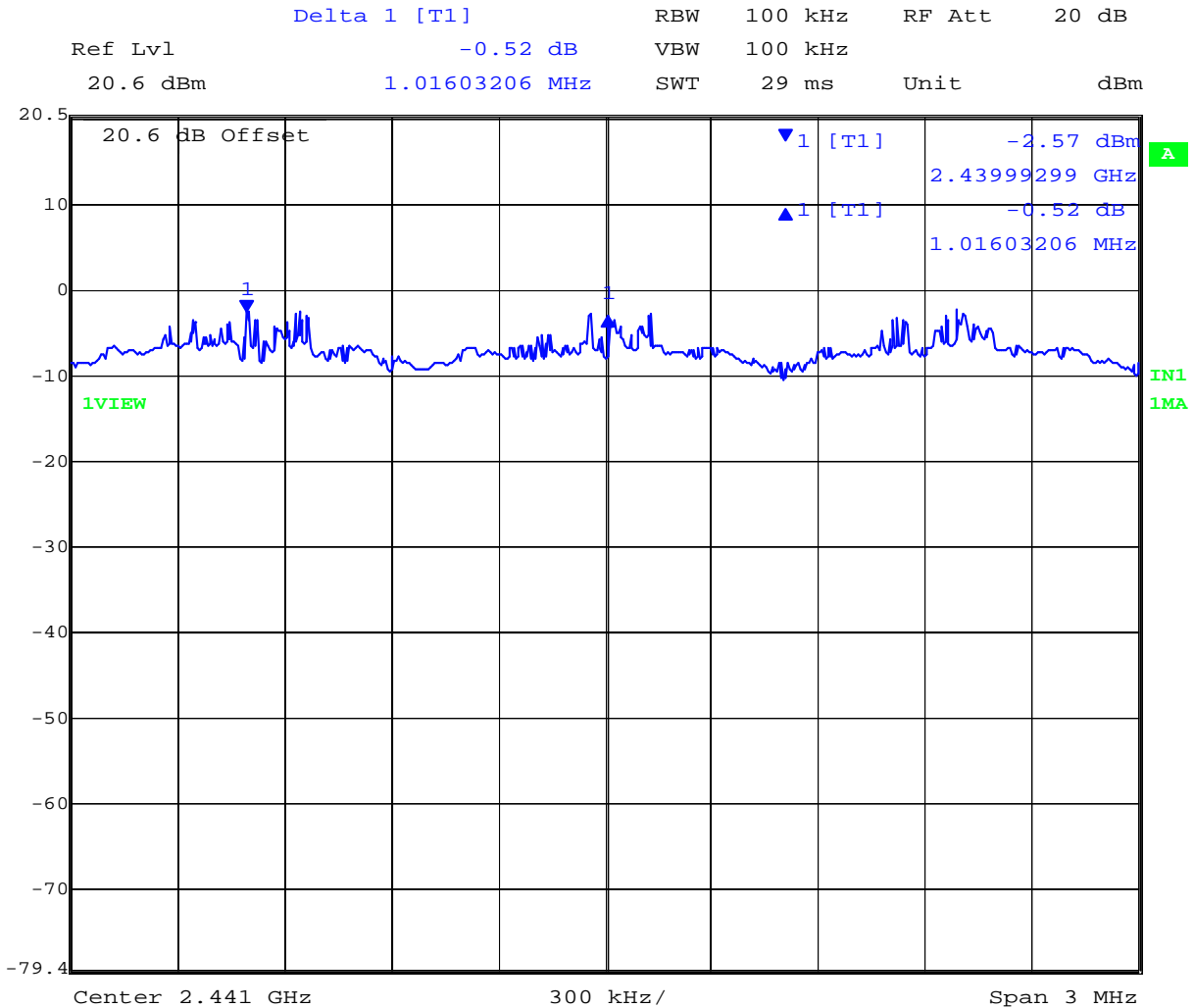

Date: 27.AUG.2013 19:18:10

Analyser Setup	Marker : Frequency : Amplitude	Test Results
Detector = Max Peak Sweep Count = 0 RF Atten (dB) = 20 Trace Mode = VIEW	M1 : 2441.00 MHz : -2.57 dBm	Channel Separation: 1.016 MHz Limit: > 1 MHz Margin: 0.016 MHz

[Back to the Matrix](#)

This test report may be reproduced in full only. The document may only be updated by MiCOM Labs personnel. Any changes will be noted in the Document History section of the report.





**Title:** Ear Force i30 Wireless Audio Headset  
**To:** FCC 47 CFR Part 15.247 & IC RSS-210  
**Serial #:** COMM37-U2 Rev A  
**Issue Date:** 25th September 2013  
**Page:** 97 of 127



**Channel Separation 3 DH1**

Variant: 802.15 3 DH1, Channel: 2441.00 MHz, Chain a, Temp: Ambient, Voltage: 3.7 Vdc

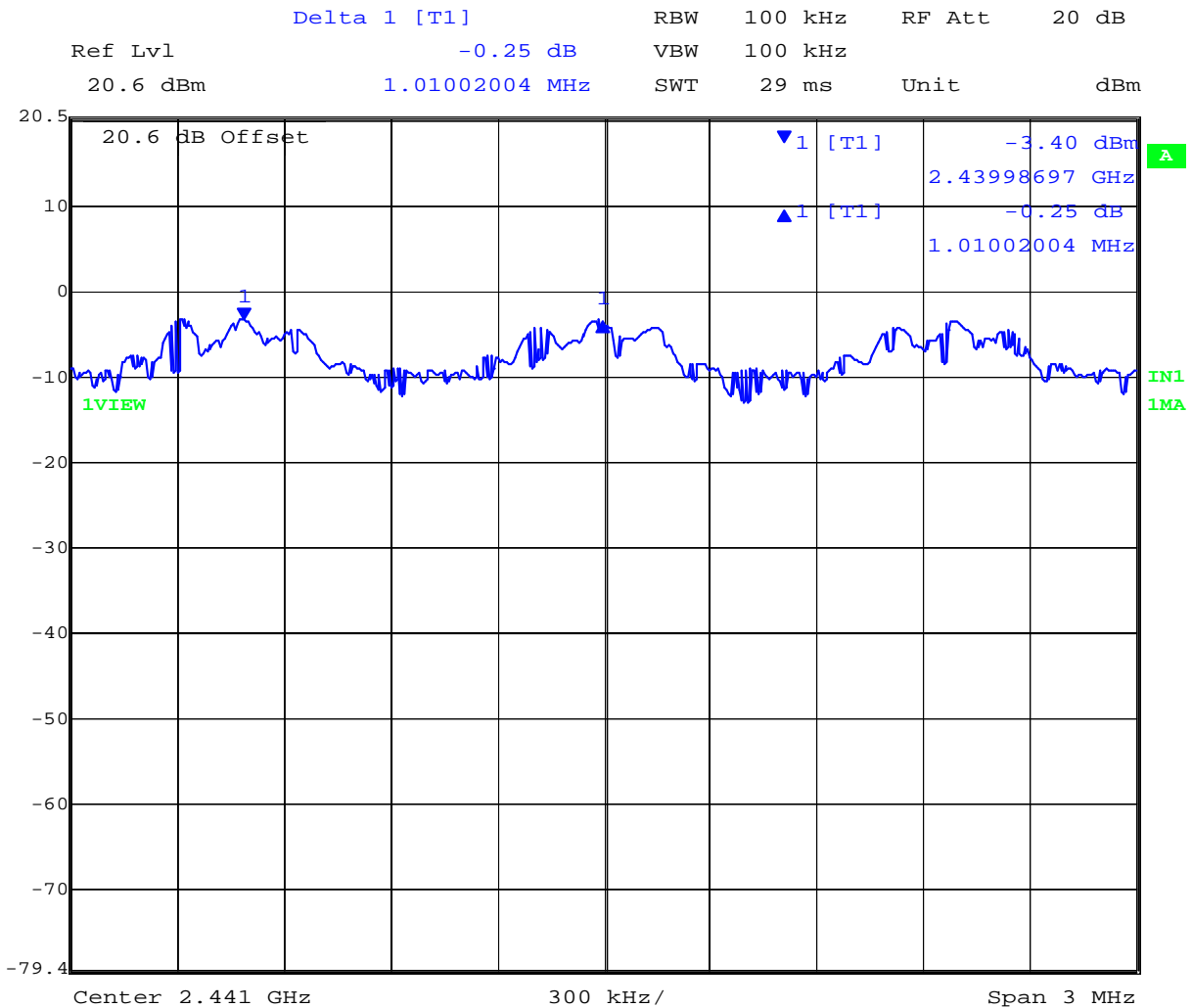

Date: 27.AUG.2013 19:21:06

Analyser Setup	Marker : Frequency : Amplitude	Test Results
Detector = Max Peak Sweep Count = 0 RF Atten (dB) = 20 Trace Mode = VIEW	M1 : 2441.00 MHz : -3.40 dBm	Channel Separation: 1.010 MHz Limit: > 1 MHz Margin: 0.010 MHz

[Back to the Matrix](#)

This test report may be reproduced in full only. The document may only be updated by MiCOM Labs personnel. Any changes will be noted in the Document History section of the report.



**Title:** Ear Force i30 Wireless Audio Headset  
**To:** FCC 47 CFR Part 15.247 & IC RSS-210  
**Serial #:** COMM37-U2 Rev A  
**Issue Date:** 25th September 2013  
**Page:** 98 of 127



**Channel Separation 3 DH5**

Variant: 802.15 3 DH5, Channel: 2441.00 MHz, Chain a, Temp: Ambient, Voltage: 3.7 Vdc

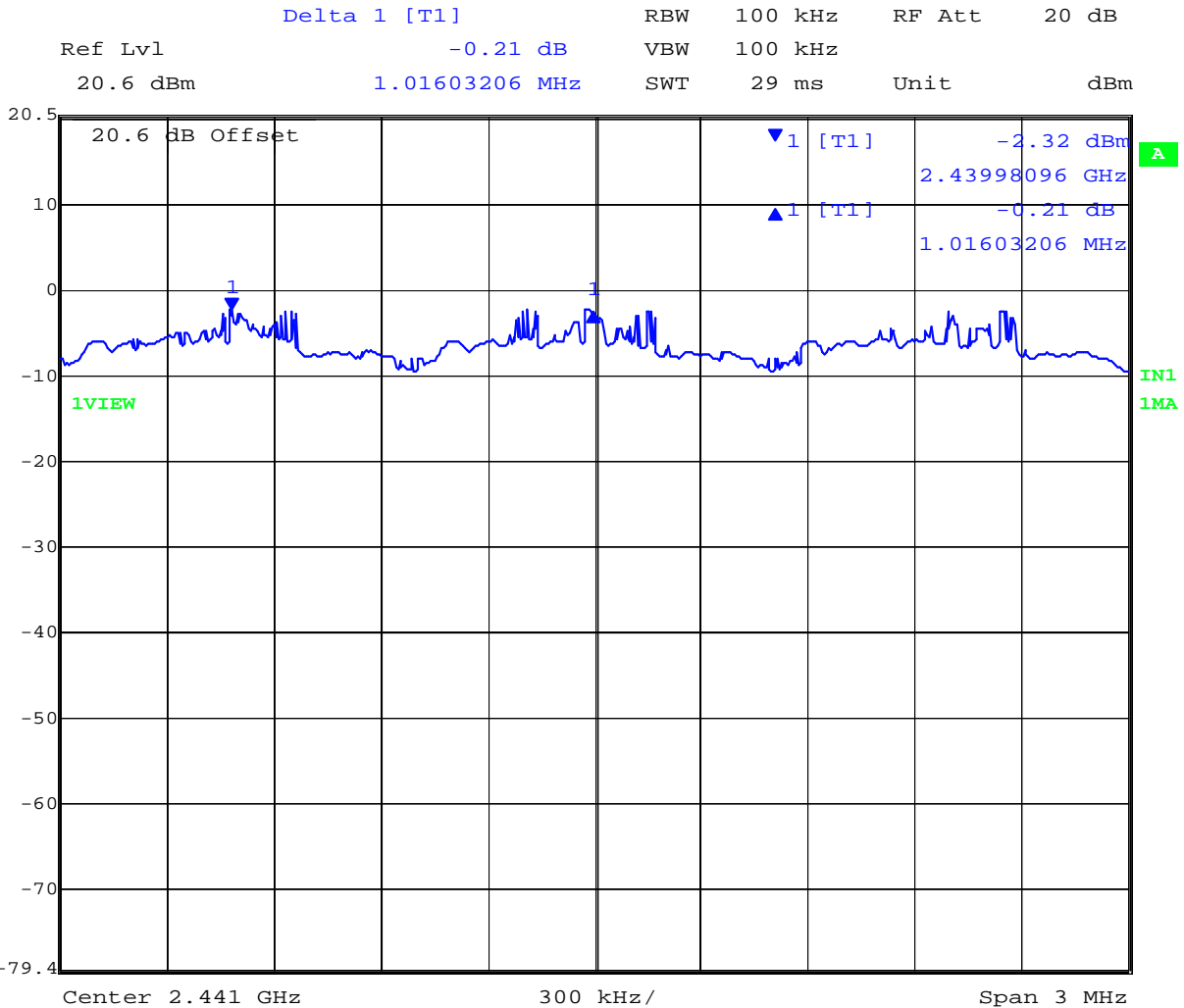

Date: 27.AUG.2013 19:24:19

Analyser Setup	Marker : Frequency : Amplitude	Test Results
Detector = Max Peak Sweep Count = 0 RF Atten (dB) = 20 Trace Mode = VIEW	M1 : 2441.00 MHz : -2.32 dBm	Channel Separation: 1.016 MHz Limit: > 1 MHz Margin: 0.016 MHz

[Back to the Matrix](#)

This test report may be reproduced in full only. The document may only be updated by MiCOM Labs personnel. Any changes will be noted in the Document History section of the report.



**Title:** Ear Force i30 Wireless Audio Headset  
**To:** FCC 47 CFR Part 15.247 & IC RSS-210  
**Serial #:** COMM37-U2 Rev A  
**Issue Date:** 25th September 2013  
**Page:** 99 of 127

### A.1.3. Number of Hopping Frequencies



#### Hopping Sequence Channel 0-39

Variant: 802.15.3 DH5, Channel: Hopping, Chain a, Temp: Ambient, Voltage: 3.7 Vdc

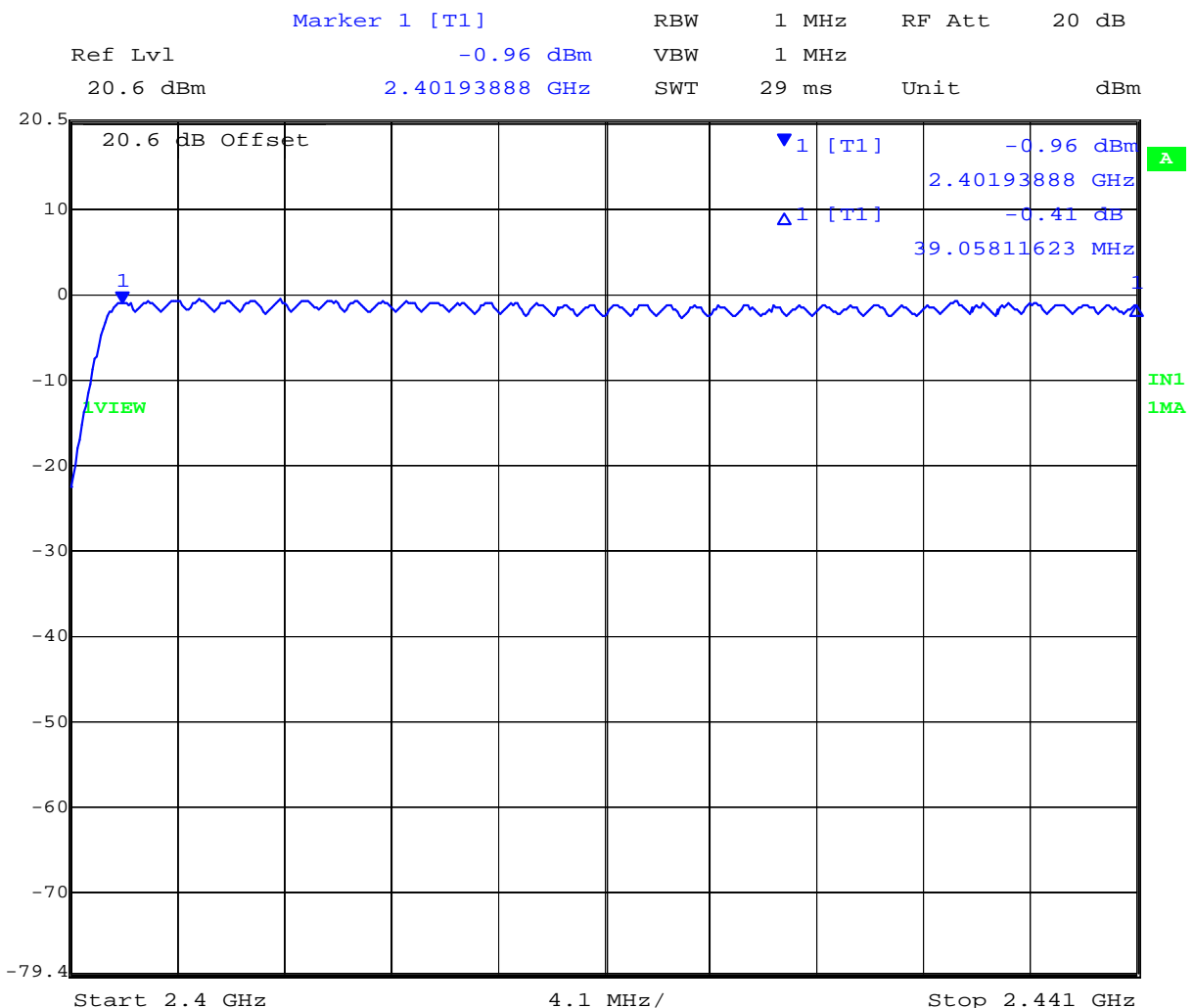

Date: 27.AUG.2013 19:27:10

Analyser Setup	Marker : Frequency : Amplitude	Test Results
Detector = Max Peak Sweep Count = 0 RF Atten (dB) = 20 Trace Mode = VIEW	M1 : 2441.00 MHz : -2.32 dBm	Channel Separation: 1.016 MHz Limit: > 1 MHz Margin: 0.016 MHz

[Back to the Matrix](#)

This test report may be reproduced in full only. The document may only be updated by MiCOM Labs personnel. Any changes will be noted in the Document History section of the report.



**Title:** Ear Force i30 Wireless Audio Headset  
**To:** FCC 47 CFR Part 15.247 & IC RSS-210  
**Serial #:** COMM37-U2 Rev A  
**Issue Date:** 25th September 2013  
**Page:** 100 of 127



**Hopping Sequence Channel 40-78**

Variant: 802.15 3 DH5, Channel: Hopping, Chain a, Temp: Ambient, Voltage: 3.7 Vdc

Delta 1 [T1]                      RBW    1 MHz    RF Att    20 dB  
 Ref Lvl                              0.59 dB    VBW    1 MHz  
 20.6 dBm                            38.88577154 MHz    SWT    29 ms    Unit            dBm

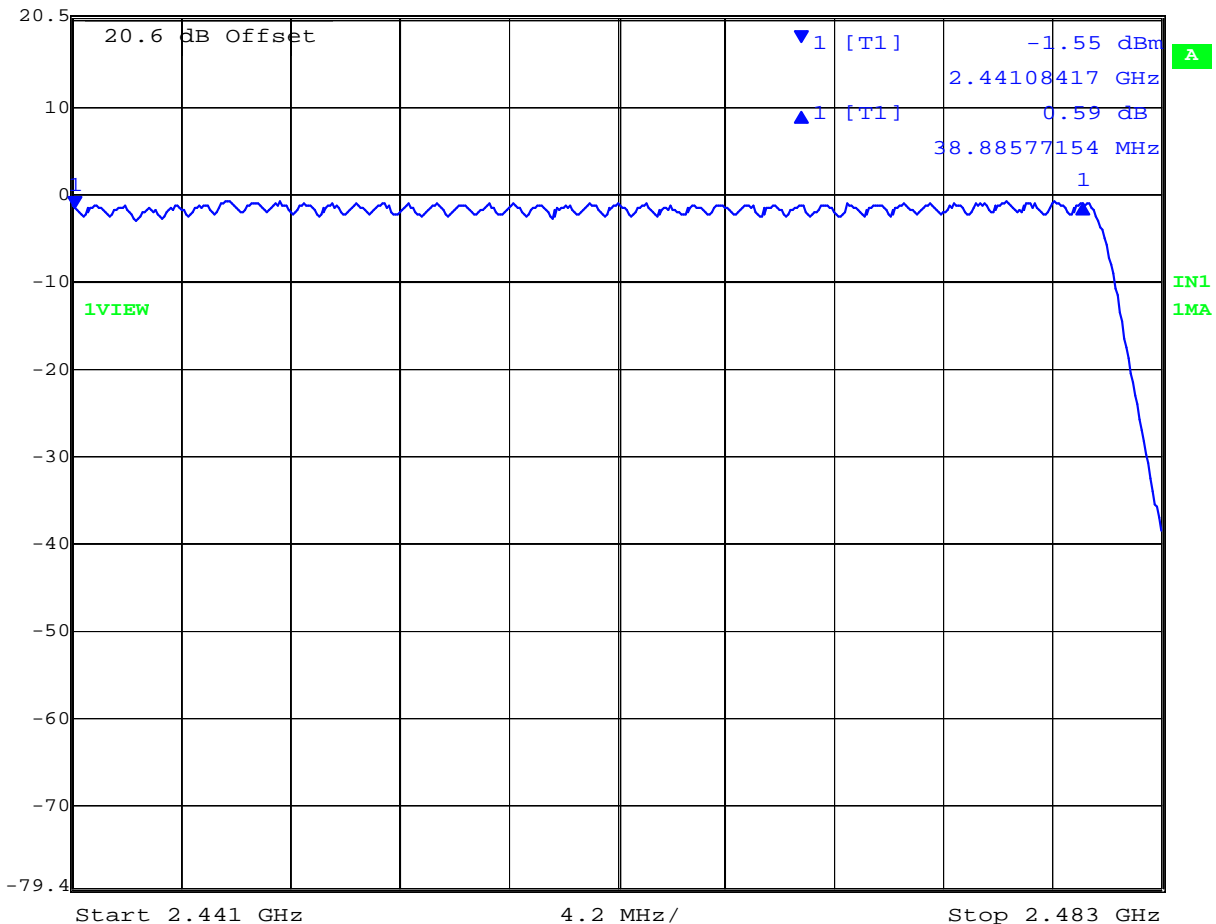

Date: 27.AUG.2013 19:29:29

Analyser Setup	Marker : Frequency : Amplitude	Test Results
Detector = Max Peak Sweep Count = 0 RF Atten (dB) = 20 Trace Mode = VIEW		

[Back to the Matrix](#)

This test report may be reproduced in full only. The document may only be updated by MiCOM Labs personnel. Any changes will be noted in the Document History section of the report.



**Title:** Ear Force i30 Wireless Audio Headset  
**To:** FCC 47 CFR Part 15.247 & IC RSS-210  
**Serial #:** COMM37-U2 Rev A  
**Issue Date:** 25th September 2013  
**Page:** 101 of 127

### A.1.4. Dwell Time



#### Dwell Time DH1

Variant: 802.15 DH1, Channel: 2402.00 MHz, Chain a, Temp: Ambient, Voltage: 3.7 Vdc

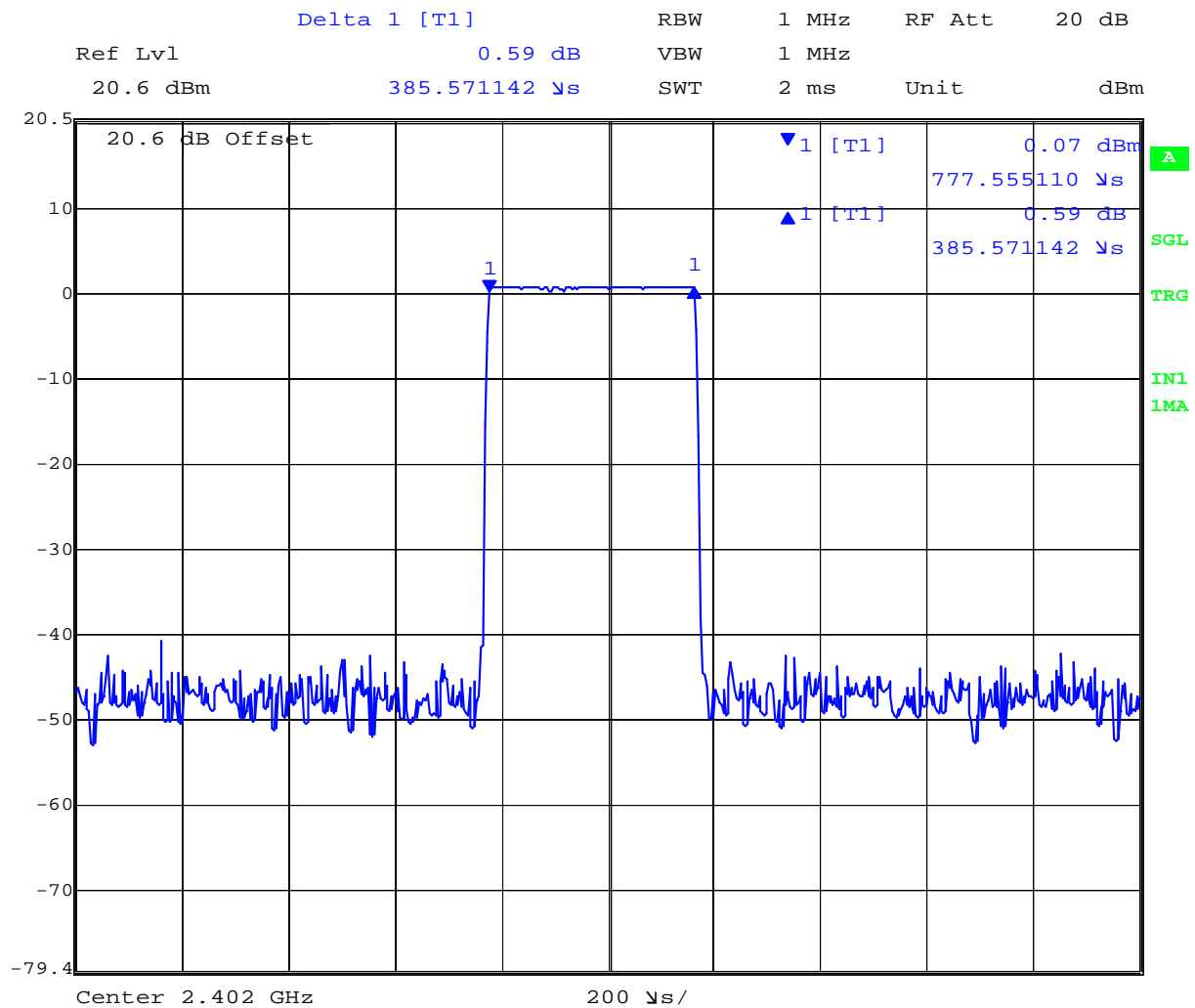

Date: 27.AUG.2013 18:25:36

Analyser Setup	Marker : Frequency : Amplitude	Test Results
Detector = Max Peak Sweep Count = 0 RF Atten (dB) = 20 Trace Mode = VIEW	M1 : 2402.00 MHz : 0.07 dBm	Dwell Time: 0.3857 mS Limit: 400 mS Margin: 399.62 mS

[Back to the Matrix](#)

This test report may be reproduced in full only. The document may only be updated by MiCOM Labs personnel. Any changes will be noted in the Document History section of the report.



**Title:** Ear Force i30 Wireless Audio Headset  
**To:** FCC 47 CFR Part 15.247 & IC RSS-210  
**Serial #:** COMM37-U2 Rev A  
**Issue Date:** 25th September 2013  
**Page:** 102 of 127



**Dwell Time DH3**

Variant: 802.15 DH3, Channel: 2402.00 MHz, Chain a, Temp: Ambient, Voltage: 3.7 Vdc

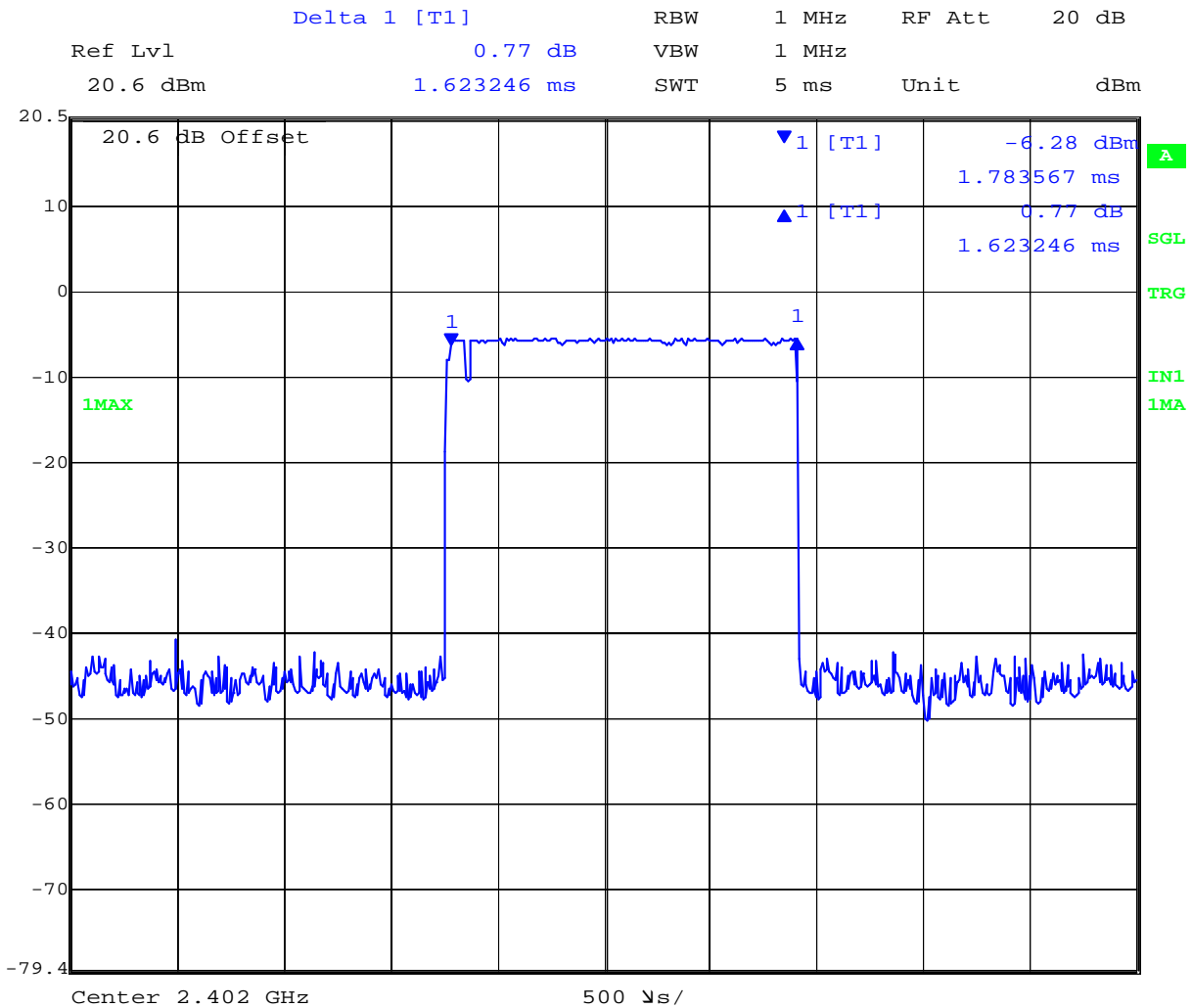

Date: 27.AUG.2013 18:33:14

Analyser Setup	Marker : Frequency : Amplitude	Test Results
Detector = Max Peak Sweep Count = 0 RF Atten (dB) = 20 Trace Mode = VIEW	M1 : 2402.00 MHz : -6.28 dBm	Dwell Time: 1.623 mS Limit: 400 mS Margin: 398.38 mS

[Back to the Matrix](#)

This test report may be reproduced in full only. The document may only be updated by MiCOM Labs personnel. Any changes will be noted in the Document History section of the report.



**Title:** Ear Force i30 Wireless Audio Headset  
**To:** FCC 47 CFR Part 15.247 & IC RSS-210  
**Serial #:** COMM37-U2 Rev A  
**Issue Date:** 25th September 2013  
**Page:** 103 of 127



**Dwell Time DH5**

Variant: 802.15 DH5, Channel: 2402.00 MHz, Chain a, Temp: Ambient, Voltage: 3.7 Vdc

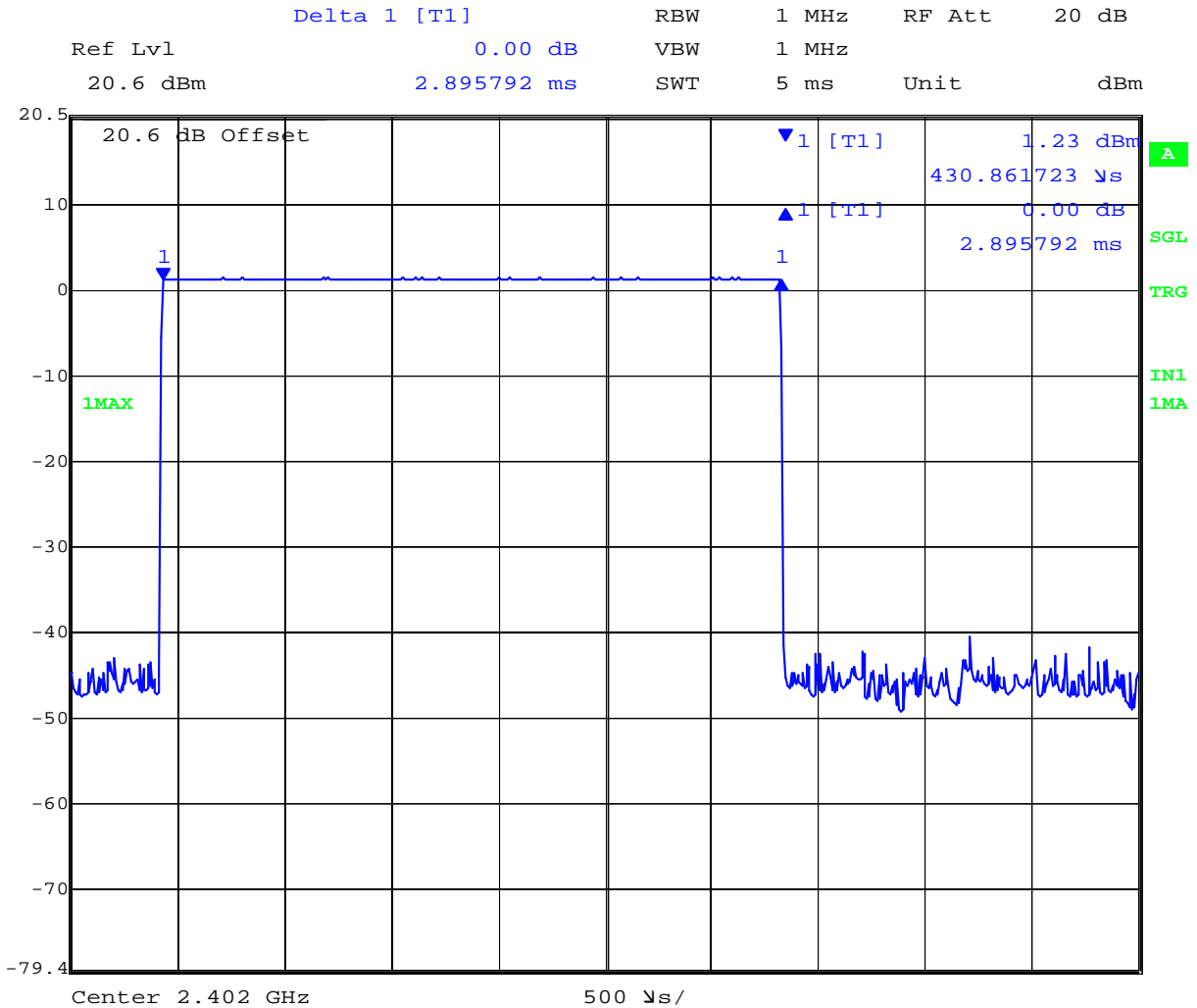

Date: 27.AUG.2013 18:39:49

Analyser Setup	Marker : Frequency : Amplitude	Test Results
Detector = Max Peak Sweep Count = 0 RF Atten (dB) = 20 Trace Mode = VIEW	M1 : 2402.00 MHz : 1.23 dBm	Dwell Time: 2.896 mS Limit: 400 mS Margin: 397.11 mS

[Back to the Matrix](#)

This test report may be reproduced in full only. The document may only be updated by MiCOM Labs personnel. Any changes will be noted in the Document History section of the report.



**Title:** Ear Force i30 Wireless Audio Headset  
**To:** FCC 47 CFR Part 15.247 & IC RSS-210  
**Serial #:** COMM37-U2 Rev A  
**Issue Date:** 25th September 2013  
**Page:** 104 of 127



**Dwell Time 2 DH1**

Variant: 802.15 2 DH1, Channel: 2402.00 MHz, Chain a, Temp: Ambient, Voltage: 3.7 Vdc

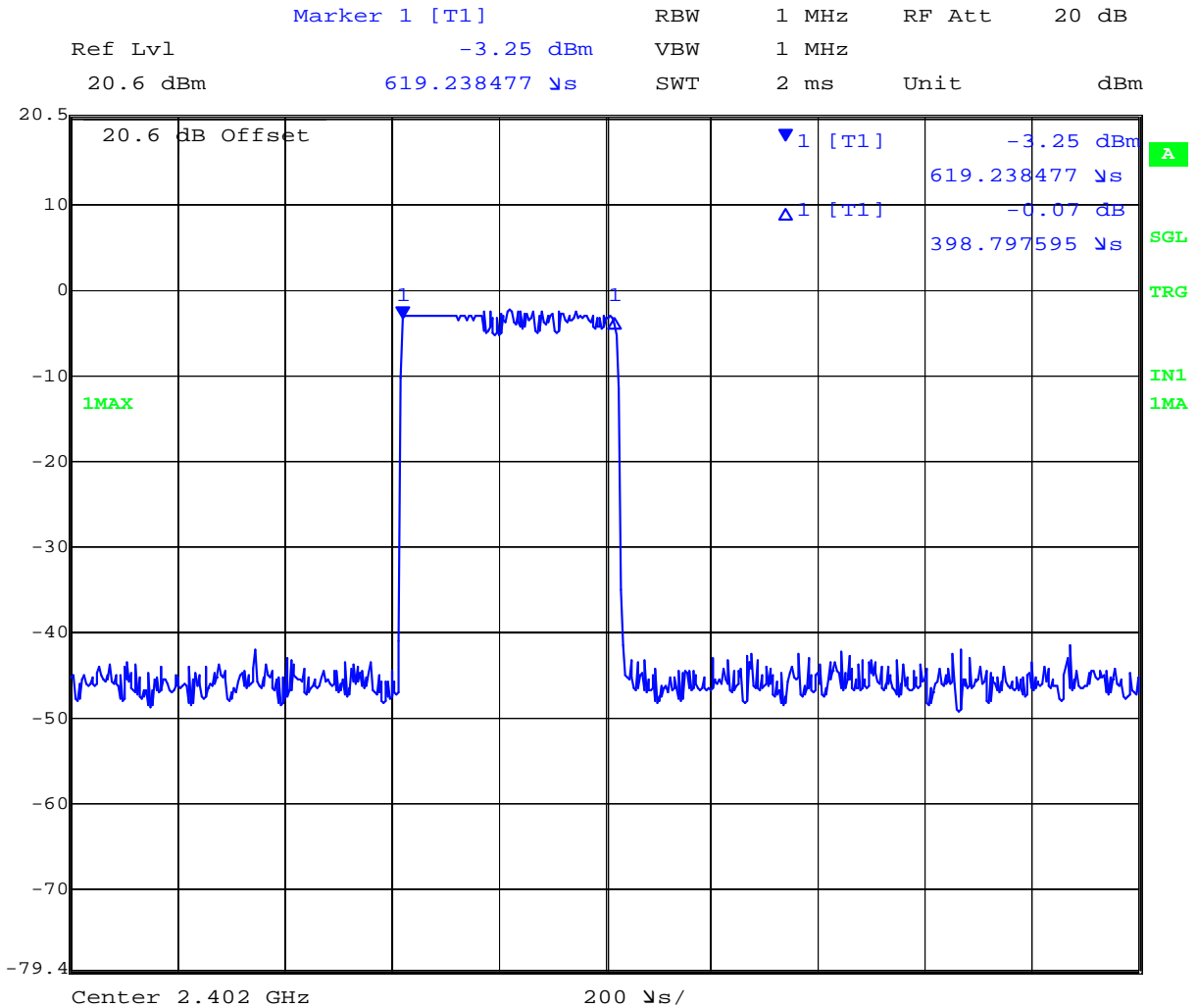

Date: 27.AUG.2013 18:42:13

Analyser Setup	Marker : Frequency : Amplitude	Test Results
Detector = Max Peak Sweep Count = 0 RF Atten (dB) = 20 Trace Mode = VIEW	M1 : 2402.00 MHz : -3.25 dBm	Dwell Time: 0.3987 mS Limit: 400 mS Margin: 399.60 mS

[Back to the Matrix](#)

This test report may be reproduced in full only. The document may only be updated by MiCOM Labs personnel. Any changes will be noted in the Document History section of the report.





**Title:** Ear Force i30 Wireless Audio Headset  
**To:** FCC 47 CFR Part 15.247 & IC RSS-210  
**Serial #:** COMM37-U2 Rev A  
**Issue Date:** 25th September 2013  
**Page:** 105 of 127



**Dwell Time 2 DH3**

Variant: 802.15 2 DH3, Channel: 2402.00 MHz, Chain a, Temp: Ambient, Voltage: 3.7 Vdc

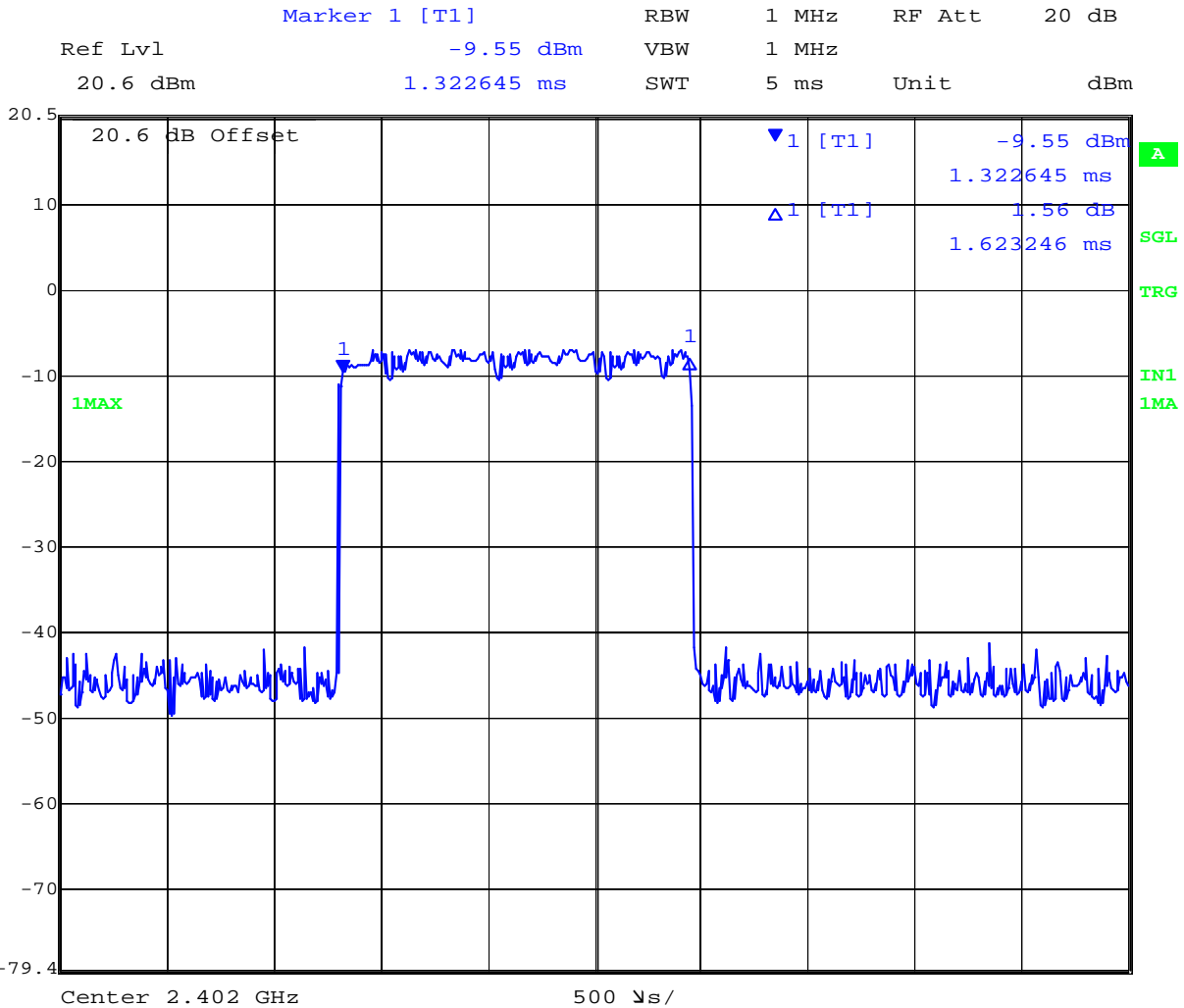

Date: 27.AUG.2013 18:54:29

Analyser Setup	Marker : Frequency : Amplitude	Test Results
Detector = Max Peak Sweep Count = 0 RF Atten (dB) = 20 Trace Mode = VIEW	M1 : 2402.00 MHz : -9.55 dBm	Dwell Time: 1.623 mS Limit: 400 mS Margin: 398.38 mS

[Back to the Matrix](#)

This test report may be reproduced in full only. The document may only be updated by MiCOM Labs personnel. Any changes will be noted in the Document History section of the report.



**Title:** Ear Force i30 Wireless Audio Headset  
**To:** FCC 47 CFR Part 15.247 & IC RSS-210  
**Serial #:** COMM37-U2 Rev A  
**Issue Date:** 25th September 2013  
**Page:** 106 of 127



**Dwell Time 2 DH5**

Variat: 802.15 2 DH5, Channel: 2402.00 MHz, Chain a, Temp: Ambient, Voltage: 3.7 Vdc

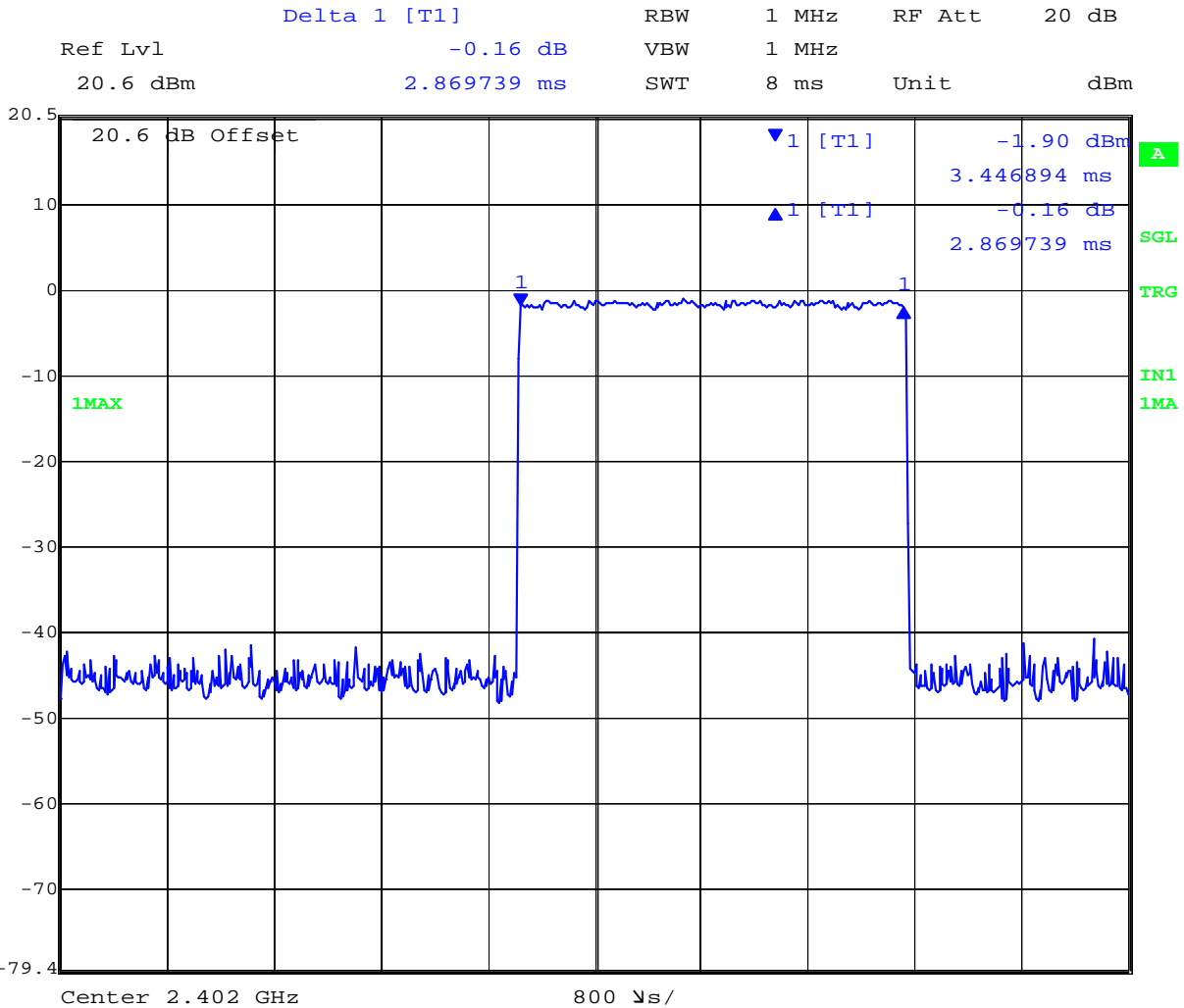

Date: 27.AUG.2013 18:51:28

Analyser Setup	Marker : Frequency : Amplitude	Test Results
Detector = Max Peak Sweep Count = 0 RF Atten (dB) = 20 Trace Mode = VIEW	M1 : 2402.00 MHz : -1.90 dBm	Dwell Time: 2.870 mS Limit: 400 mS Margin: 397.13 mS

[Back to the Matrix](#)

This test report may be reproduced in full only. The document may only be updated by MiCOM Labs personnel. Any changes will be noted in the Document History section of the report.



**Title:** Ear Force i30 Wireless Audio Headset  
**To:** FCC 47 CFR Part 15.247 & IC RSS-210  
**Serial #:** COMM37-U2 Rev A  
**Issue Date:** 25th September 2013  
**Page:** 107 of 127



**Dwell Time 3 DH1**

Variants: 802.15 3 DH1, Channel: 2402.00 MHz, Chain a, Temp: Ambient, Voltage: 3.7 Vdc

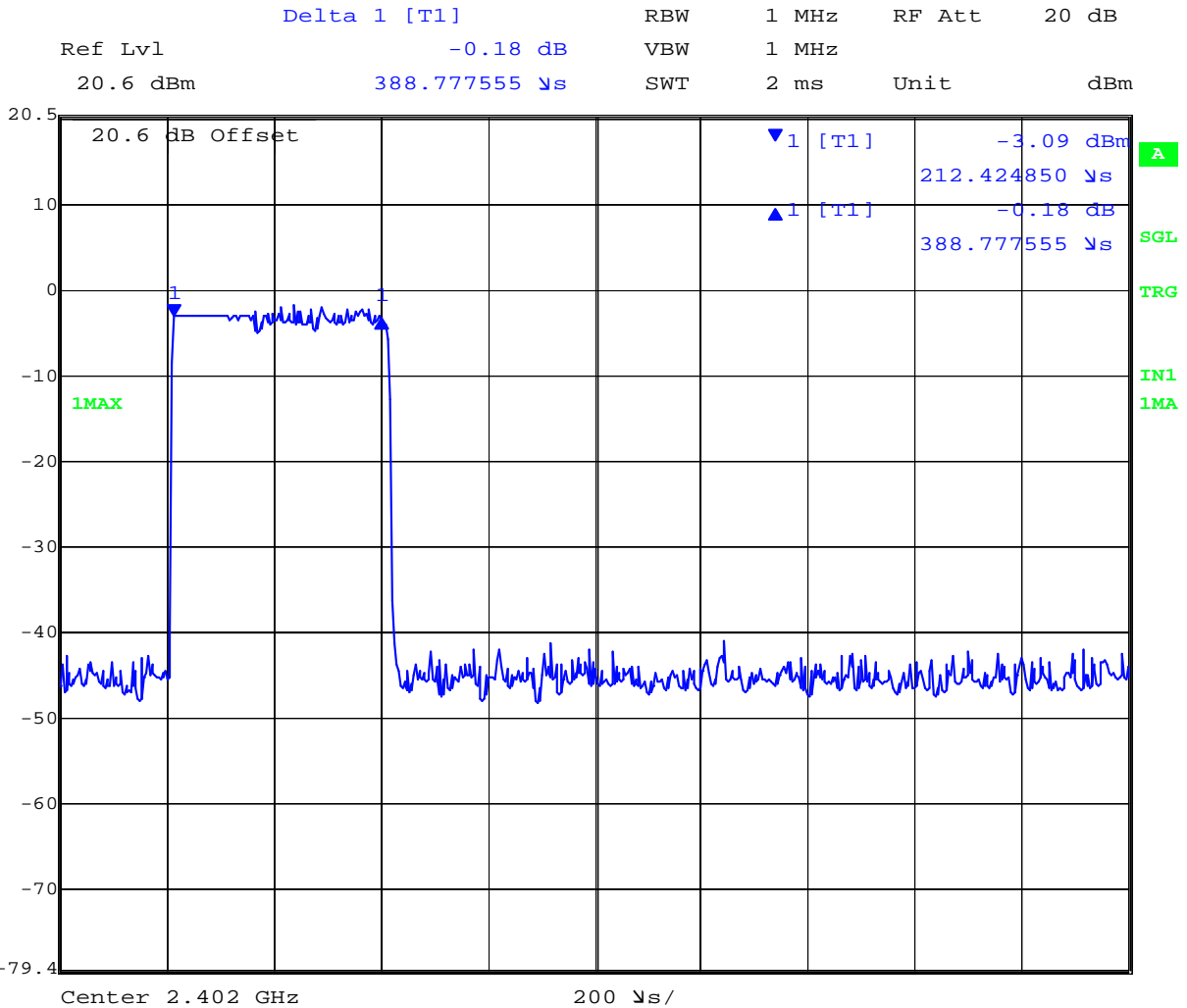

Date: 27.AUG.2013 18:56:35

Analyser Setup	Marker : Frequency : Amplitude	Test Results
Detector = Max Peak Sweep Count = 0 RF Atten (dB) = 20 Trace Mode = VIEW	M1 : 2402.00 MHz : -3.09 dBm	Dwell Time: 0.3887 mS Limit: 400 mS Margin: 399.61 mS

[Back to the Matrix](#)

This test report may be reproduced in full only. The document may only be updated by MiCOM Labs personnel. Any changes will be noted in the Document History section of the report.



**Title:** Ear Force i30 Wireless Audio Headset  
**To:** FCC 47 CFR Part 15.247 & IC RSS-210  
**Serial #:** COMM37-U2 Rev A  
**Issue Date:** 25th September 2013  
**Page:** 108 of 127



**Dwell Time 3 DH3**

Variants: 802.15 3 DH3, Channel: 2402.00 MHz, Chain a, Temp: Ambient, Voltage: 3.7 Vdc

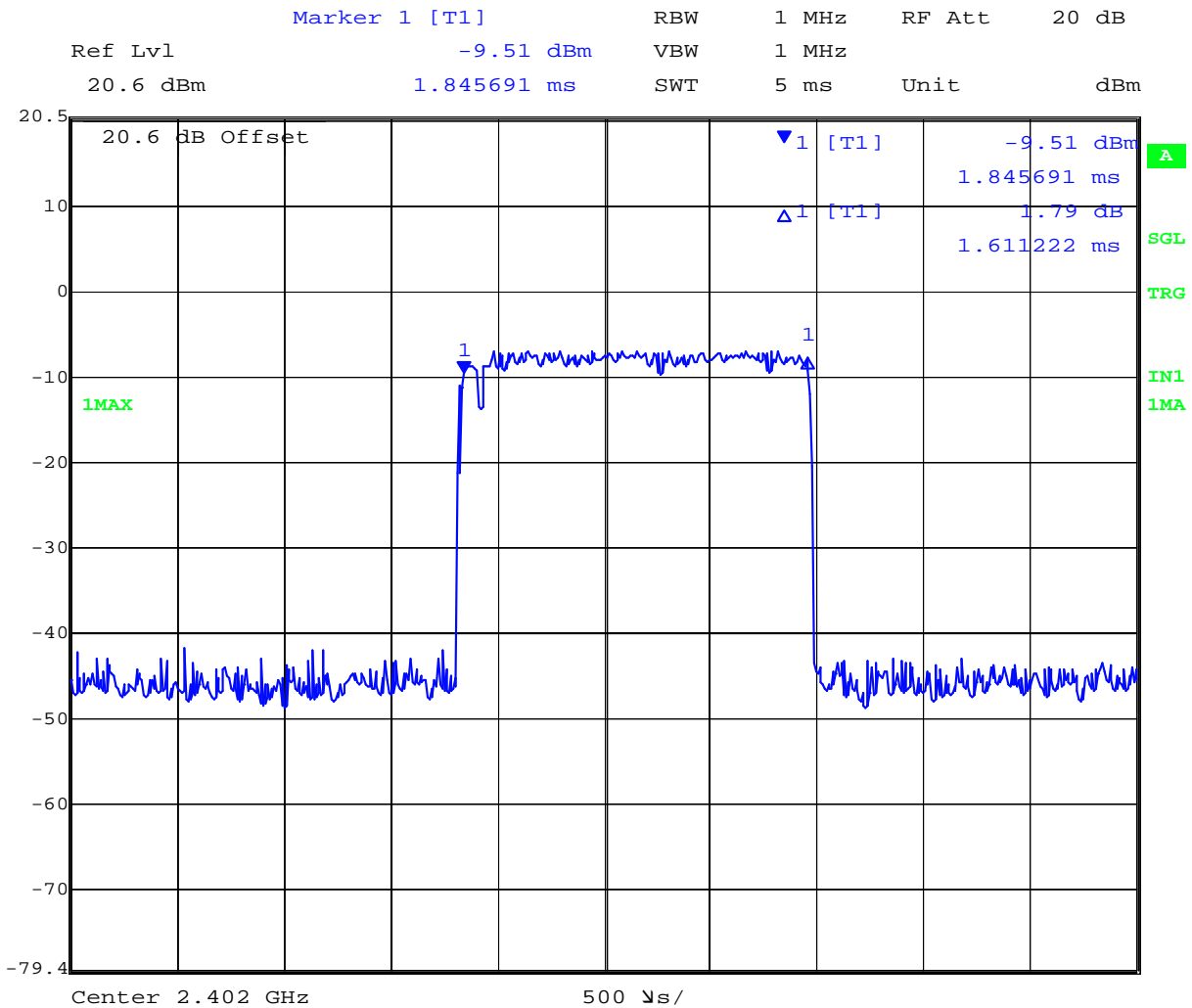

Date: 27.AUG.2013 18:59:09

Analyser Setup	Marker : Frequency : Amplitude	Test Results
Detector = Max Peak Sweep Count = 0 RF Atten (dB) = 20 Trace Mode = VIEW	M1 : 2402.00 MHz : -9.51 dBm	Dwell Time: 1.611 mS Limit: 400 mS Margin: 398.39 mS

[Back to the Matrix](#)

This test report may be reproduced in full only. The document may only be updated by MiCOM Labs personnel. Any changes will be noted in the Document History section of the report.



**Title:** Ear Force i30 Wireless Audio Headset  
**To:** FCC 47 CFR Part 15.247 & IC RSS-210  
**Serial #:** COMM37-U2 Rev A  
**Issue Date:** 25th September 2013  
**Page:** 109 of 127



**Dwell Time 3 DH5**

Variant: 802.15 DH5, Channel: 2402.00 MHz, Chain a, Temp: Ambient, Voltage: 3.7 Vdc

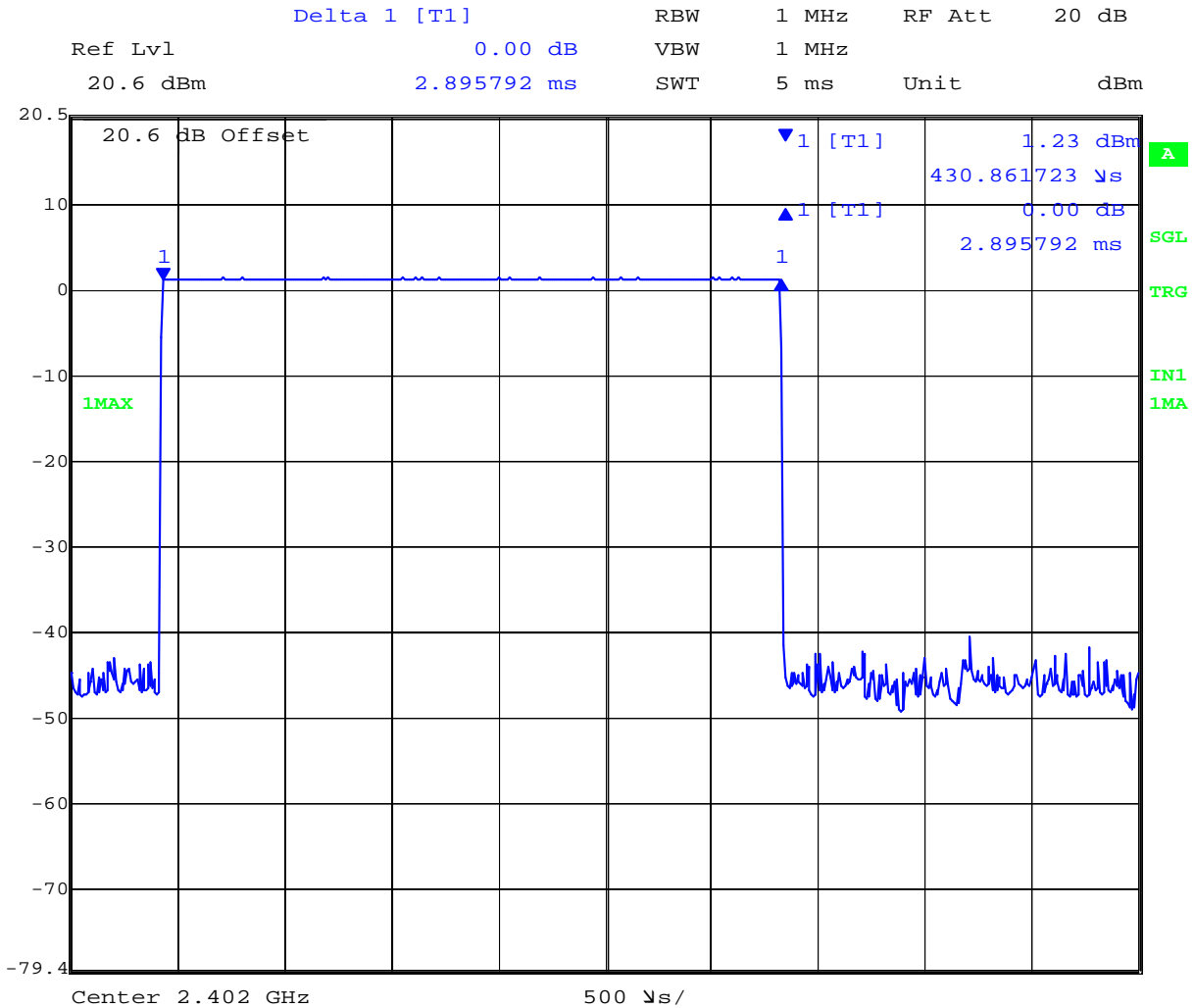

Date: 27.AUG.2013 18:39:49

Analyser Setup	Marker : Frequency : Amplitude	Test Results
Detector = Max Peak Sweep Count = 0 RF Atten (dB) = 20 Trace Mode = VIEW	M1 : 2402.00 MHz : 1.23 dBm	Dwell Time: 2.896 mS Limit: 400 mS Margin: 397.10 mS

[Back to the Matrix](#)

This test report may be reproduced in full only. The document may only be updated by MiCOM Labs personnel. Any changes will be noted in the Document History section of the report.



**Title:** Ear Force i30 Wireless Audio Headset  
**To:** FCC 47 CFR Part 15.247 & IC RSS-210  
**Serial #:** COMM37-U2 Rev A  
**Issue Date:** 25th September 2013  
**Page:** 110 of 127

### A.1.5. Peak Power Output



#### PEAK OUTPUT POWER

Variant: 802.15 DH1, Channel: 2402.00 MHz, Chain a, Temp: Ambient, Voltage: 3.7 Vdc

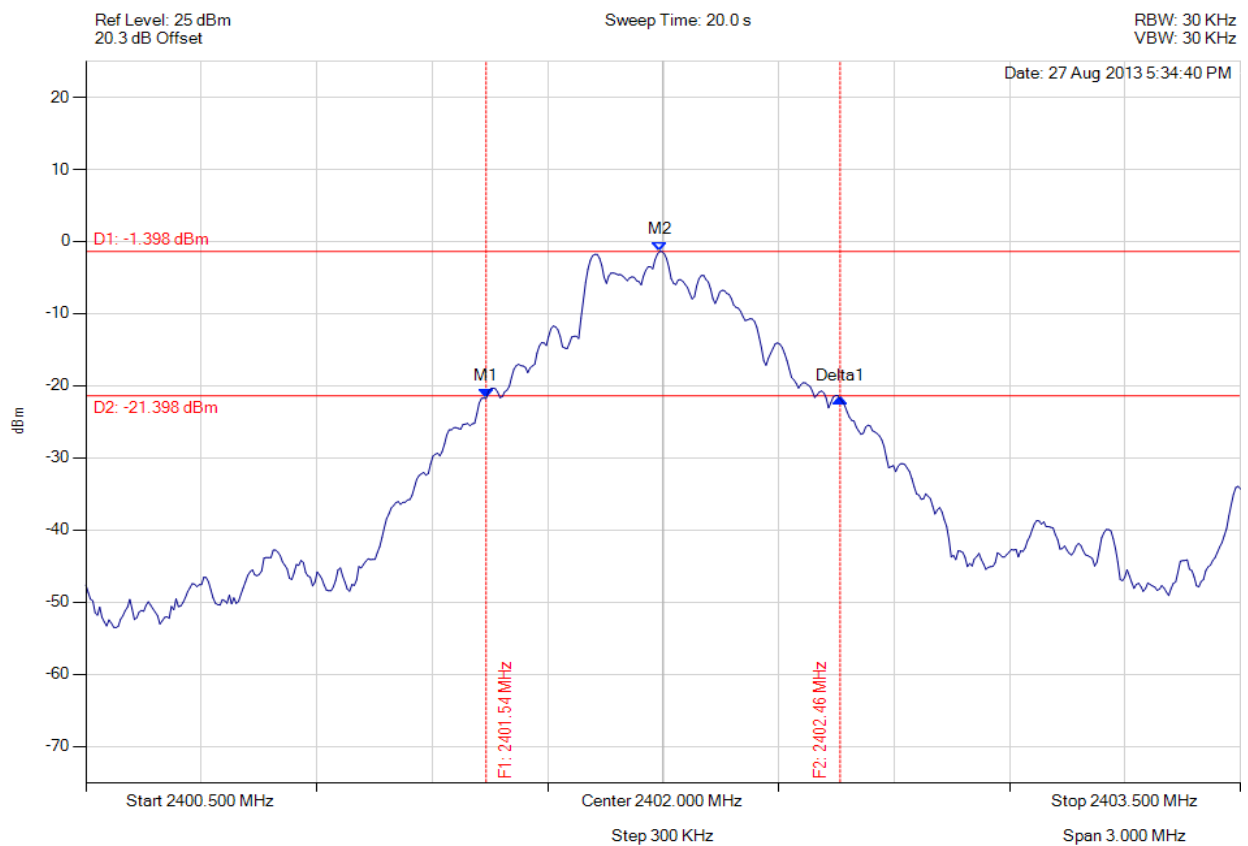

Analyser Setup	Marker : Frequency : Amplitude	Test Results
Detector = MAX PEAK Sweep Count = 0 RF Atten (dB) = 20 Trace Mode = VIEW	M1 : 2401.540 MHz : -21.754 dBm M2 : 2401.991 MHz : -1.398 dBm Delta1 : 920 KHz : -0.016 dB	Channel Power: 6.52 dBm Limit: 30.00 dBm Margin: -23.48 dB

[Back to the Matrix](#)

This test report may be reproduced in full only. The document may only be updated by MiCOM Labs personnel. Any changes will be noted in the Document History section of the report.



**Title:** Ear Force i30 Wireless Audio Headset  
**To:** FCC 47 CFR Part 15.247 & IC RSS-210  
**Serial #:** COMM37-U2 Rev A  
**Issue Date:** 25th September 2013  
**Page:** 111 of 127



**PEAK OUTPUT POWER**

Variant: 802.15 DH1, Channel: 2441.00 MHz, Chain a, Temp: Ambient, Voltage: 3.7 Vdc

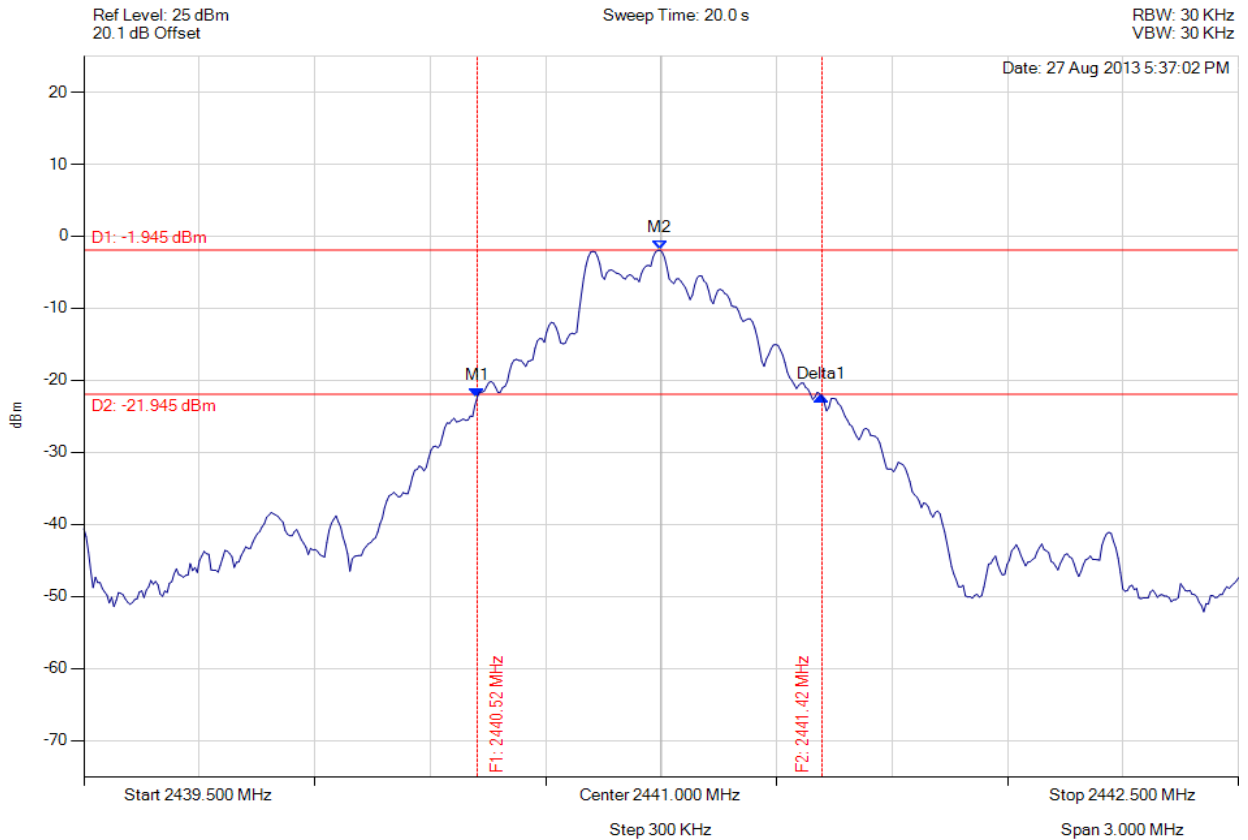

Analyser Setup	Marker : Frequency : Amplitude	Test Results
Detector = MAX PEAK Sweep Count = 0 RF Atten (dB) = 20 Trace Mode = VIEW	M1 : 2440.522 MHz : -22.360 dBm M2 : 2440.997 MHz : -1.945 dBm Delta1 : 896 KHz : 0.132 dB	Channel Power: 5.99 dBm Limit: 30.00 dBm Margin: -24.01 dB

[Back to the Matrix](#)

This test report may be reproduced in full only. The document may only be updated by MiCOM Labs personnel. Any changes will be noted in the Document History section of the report.



**Title:** Ear Force i30 Wireless Audio Headset  
**To:** FCC 47 CFR Part 15.247 & IC RSS-210  
**Serial #:** COMM37-U2 Rev A  
**Issue Date:** 25th September 2013  
**Page:** 112 of 127



### PEAK OUTPUT POWER

Variant: 802.15 DH1, Channel: 2480.00 MHz, Chain a, Temp: Ambient, Voltage: 3.7 Vdc

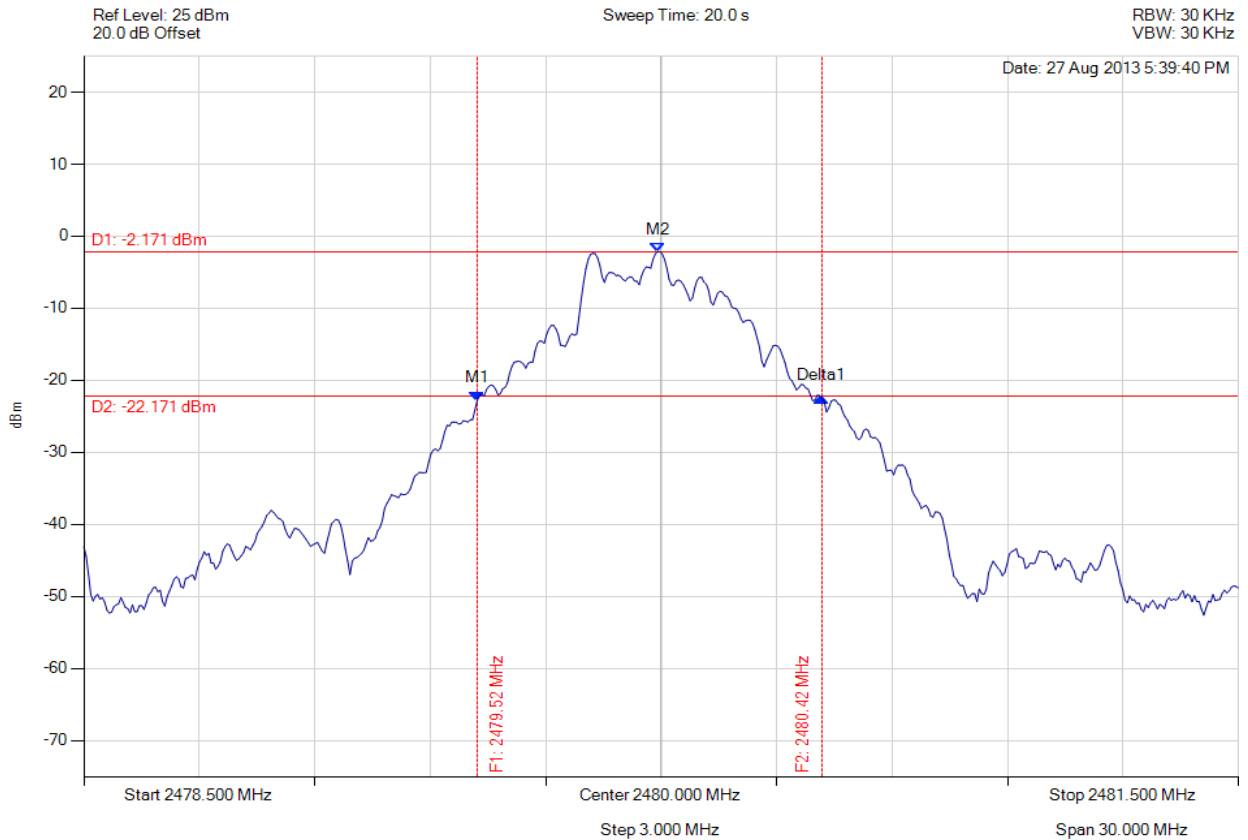

Analyser Setup	Marker : Frequency : Amplitude	Test Results
Detector = MAX PEAK Sweep Count = 0 RF Atten (dB) = 20 Trace Mode = VIEW	M1 : 2479.522 MHz : -22.799 dBm M2 : 2479.991 MHz : -2.171 dBm Delta1 : 896 KHz : 0.358 dB	Channel Power: 5.74 dBm Limit: 30.00 dBm Margin: -24.26 dB

[Back to the Matrix](#)

This test report may be reproduced in full only. The document may only be updated by MiCOM Labs personnel. Any changes will be noted in the Document History section of the report.





**Title:** Ear Force i30 Wireless Audio Headset  
**To:** FCC 47 CFR Part 15.247 & IC RSS-210  
**Serial #:** COMM37-U2 Rev A  
**Issue Date:** 25th September 2013  
**Page:** 113 of 127



**PEAK OUTPUT POWER**

Variant: 802.15 DH5, Channel: 2402.00 MHz, Chain a, Temp: Ambient, Voltage: 3.7 Vdc

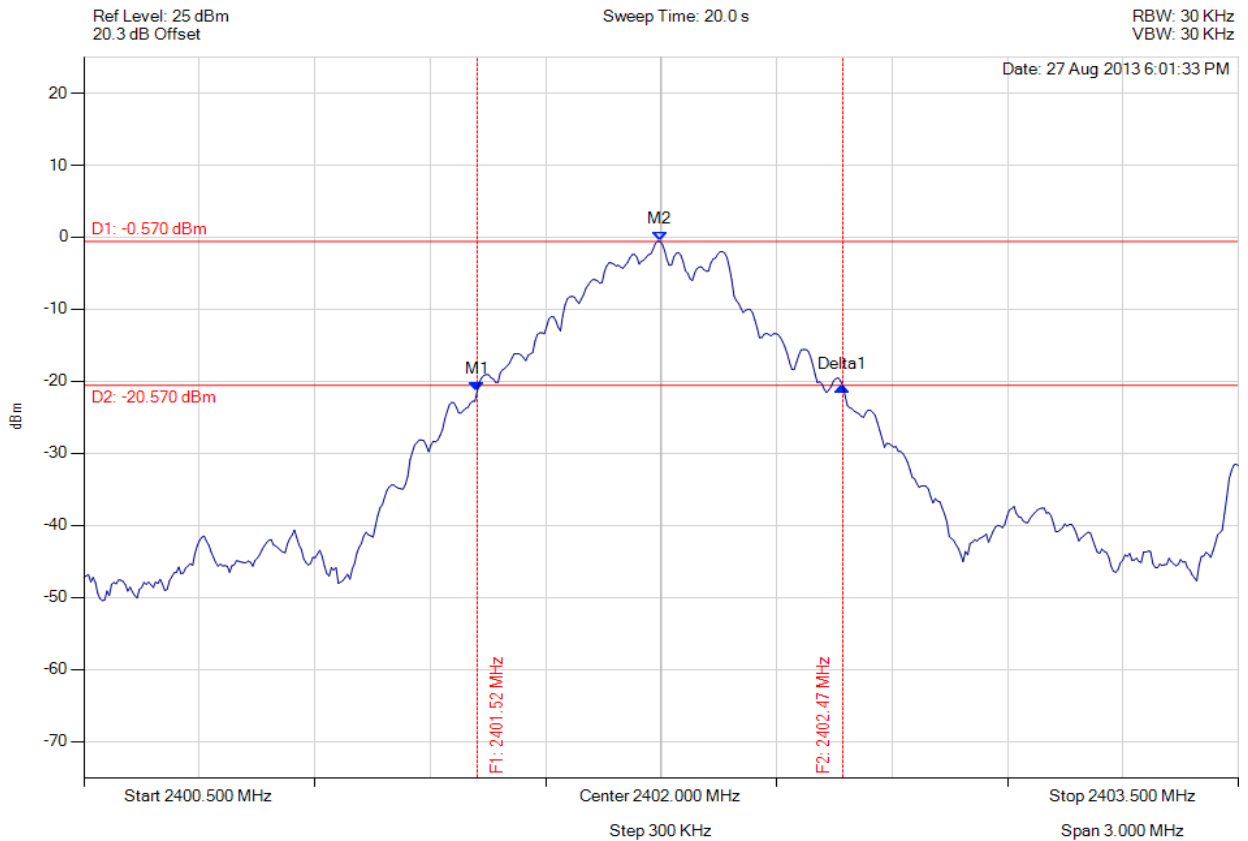

Analyser Setup	Marker : Frequency : Amplitude	Test Results
Detector = MAX PEAK Sweep Count = 0 RF Atten (dB) = 20 Trace Mode = VIEW	M1 : 2401.522 MHz : -21.371 dBm M2 : 2401.997 MHz : -0.570 dBm Delta1 : 950 KHz : 0.722 dB	Channel Power: 7.72 dBm Limit: 30.00 dBm Margin: -22.28 dB

[Back to the Matrix](#)

This test report may be reproduced in full only. The document may only be updated by MiCOM Labs personnel. Any changes will be noted in the Document History section of the report.



**Title:** Ear Force i30 Wireless Audio Headset  
**To:** FCC 47 CFR Part 15.247 & IC RSS-210  
**Serial #:** COMM37-U2 Rev A  
**Issue Date:** 25th September 2013  
**Page:** 114 of 127



### PEAK OUTPUT POWER

Variant: 802.15 DH5, Channel: 2441.00 MHz, Chain a, Temp: Ambient, Voltage: 3.7 Vdc

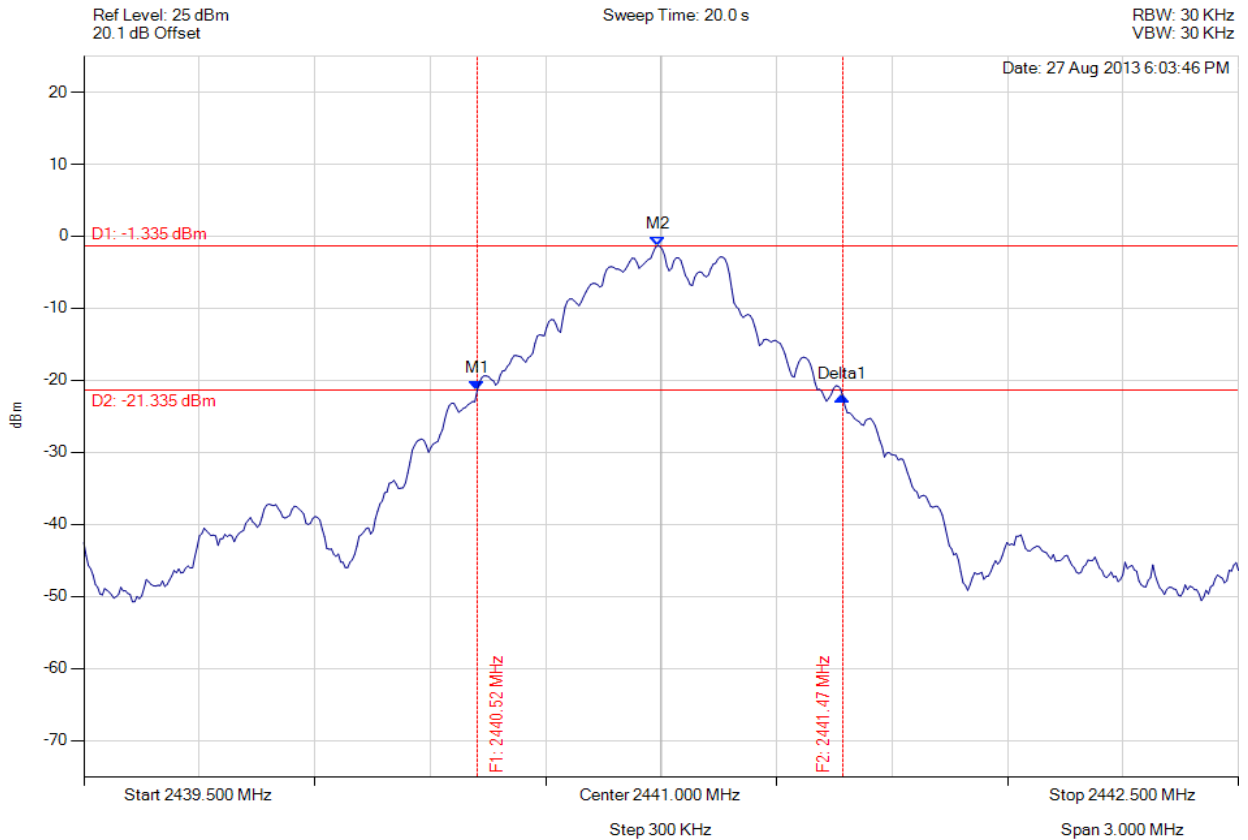

Analyser Setup	Marker : Frequency : Amplitude	Test Results
Detector = MAX PEAK Sweep Count = 0 RF Atten (dB) = 20 Trace Mode = VIEW	M1 : 2440.522 MHz : -21.404 dBm M2 : 2440.991 MHz : -1.335 dBm Delta1 : 950 KHz : -0.885 dB	Channel Power: 6.95 dBm Limit: 30.00 dBm Margin: -23.05 dB

[Back to the Matrix](#)

This test report may be reproduced in full only. The document may only be updated by MiCOM Labs personnel. Any changes will be noted in the Document History section of the report.



**Title:** Ear Force i30 Wireless Audio Headset  
**To:** FCC 47 CFR Part 15.247 & IC RSS-210  
**Serial #:** COMM37-U2 Rev A  
**Issue Date:** 25th September 2013  
**Page:** 115 of 127



### PEAK OUTPUT POWER

Variant: 802.15 DH5, Channel: 2480.00 MHz, Chain a, Temp: Ambient, Voltage: 3.7 Vdc

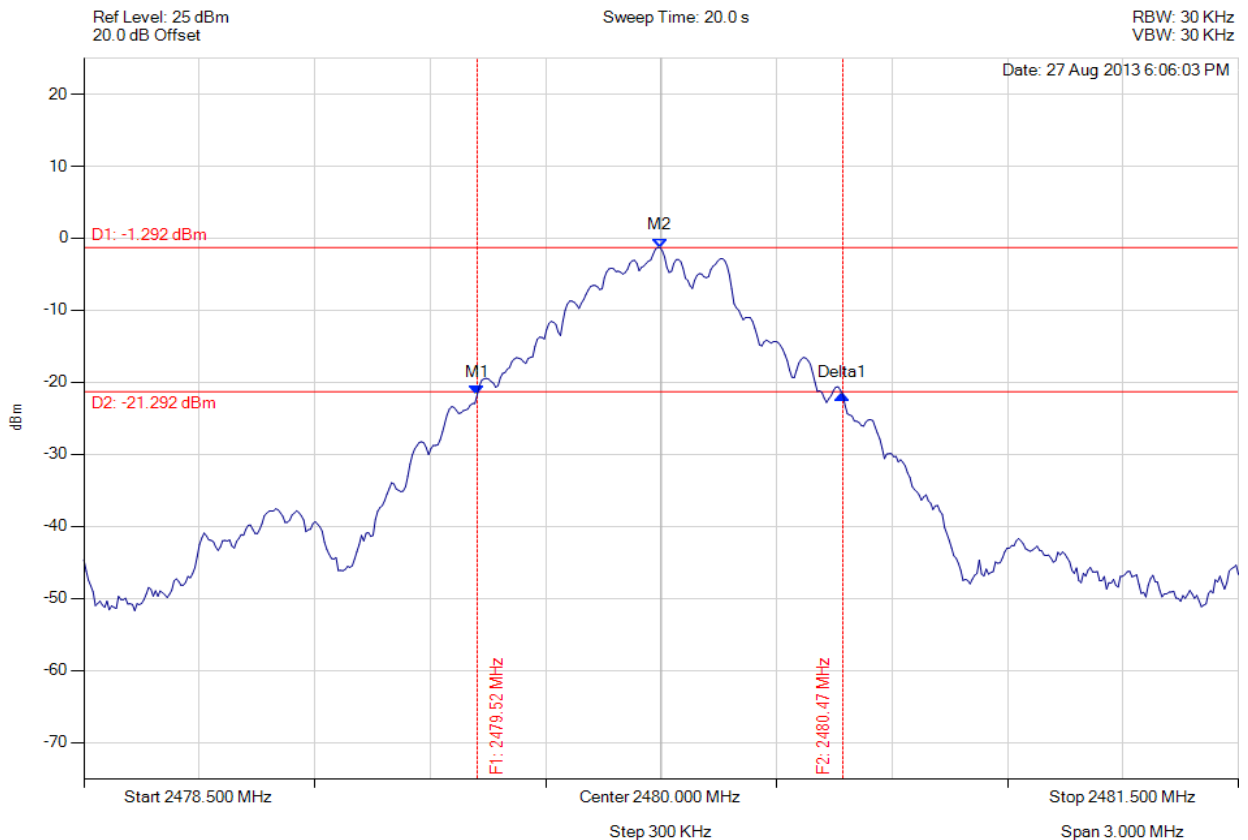

Analyser Setup	Marker : Frequency : Amplitude	Test Results
Detector = MAX PEAK Sweep Count = 0 RF Atten (dB) = 20 Trace Mode = VIEW	M1 : 2479.522 MHz : -21.721 dBm M2 : 2479.997 MHz : -1.292 dBm Delta1 : 950 KHz : 0.014 dB	Channel Power: 6.98 dBm Limit: 30.00 dBm Margin: -23.02 dB

[Back to the Matrix](#)

This test report may be reproduced in full only. The document may only be updated by MiCOM Labs personnel. Any changes will be noted in the Document History section of the report.



**Title:** Ear Force i30 Wireless Audio Headset  
**To:** FCC 47 CFR Part 15.247 & IC RSS-210  
**Serial #:** COMM37-U2 Rev A  
**Issue Date:** 25th September 2013  
**Page:** 116 of 127



**PEAK OUTPUT POWER**

Variant: 802.15 3-DH1, Channel: 2402.00 MHz, Chain a, Temp: Ambient, Voltage: 3.7 Vdc

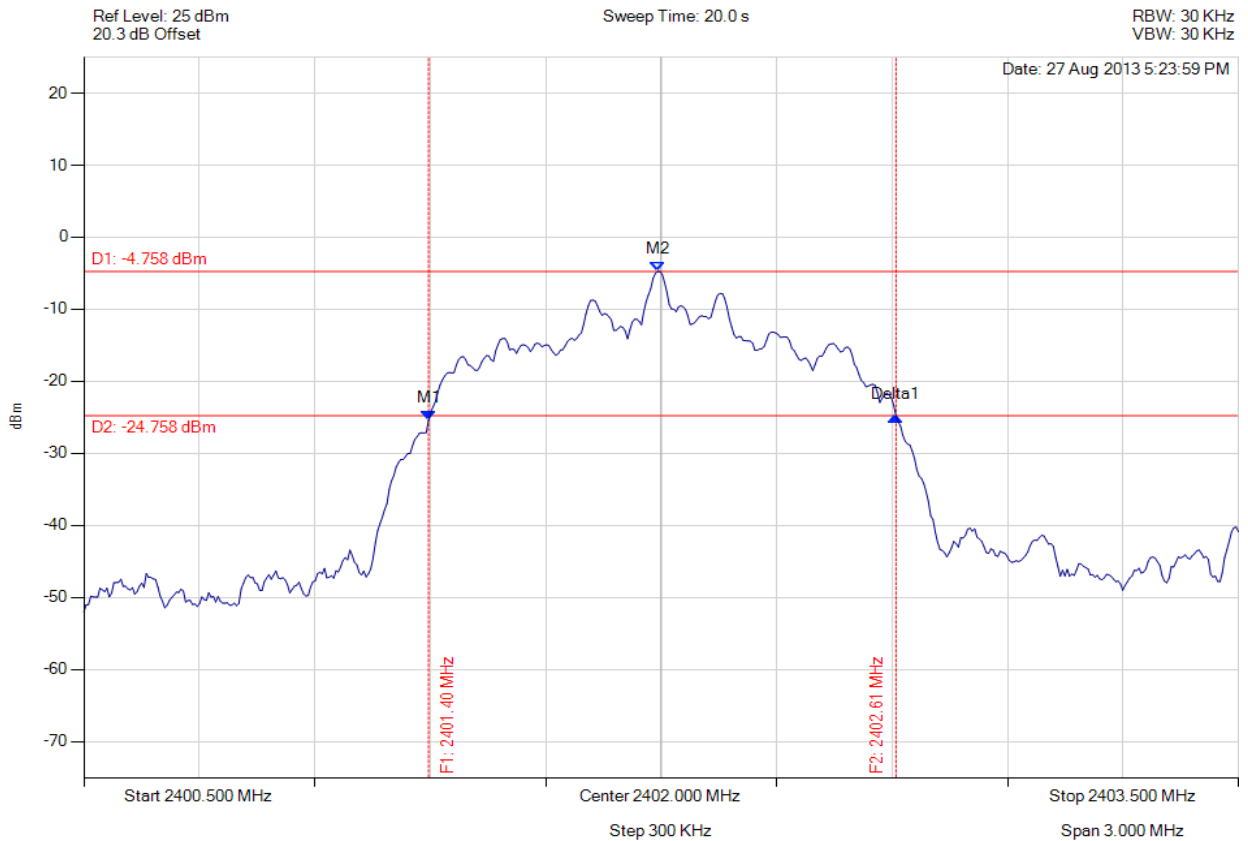

Analyser Setup	Marker : Frequency : Amplitude	Test Results
Detector = MAX PEAK Sweep Count = 0 RF Atten (dB) = 20 Trace Mode = VIEW	M1 : 2401.396 MHz : -25.398 dBm M2 : 2401.991 MHz : -4.758 dBm Delta1 : 1.214 MHz : 0.523 dB	Channel Power: 2.78 dBm Limit: 30.00 dBm Margin: -27.22 dB

[Back to the Matrix](#)

This test report may be reproduced in full only. The document may only be updated by MiCOM Labs personnel. Any changes will be noted in the Document History section of the report.



**Title:** Ear Force i30 Wireless Audio Headset  
**To:** FCC 47 CFR Part 15.247 & IC RSS-210  
**Serial #:** COMM37-U2 Rev A  
**Issue Date:** 25th September 2013  
**Page:** 117 of 127



**PEAK OUTPUT POWER**

Variant: 802.15 3-DH1, Channel: 2441.00 MHz, Chain a, Temp: Ambient, Voltage: 3.7 Vdc

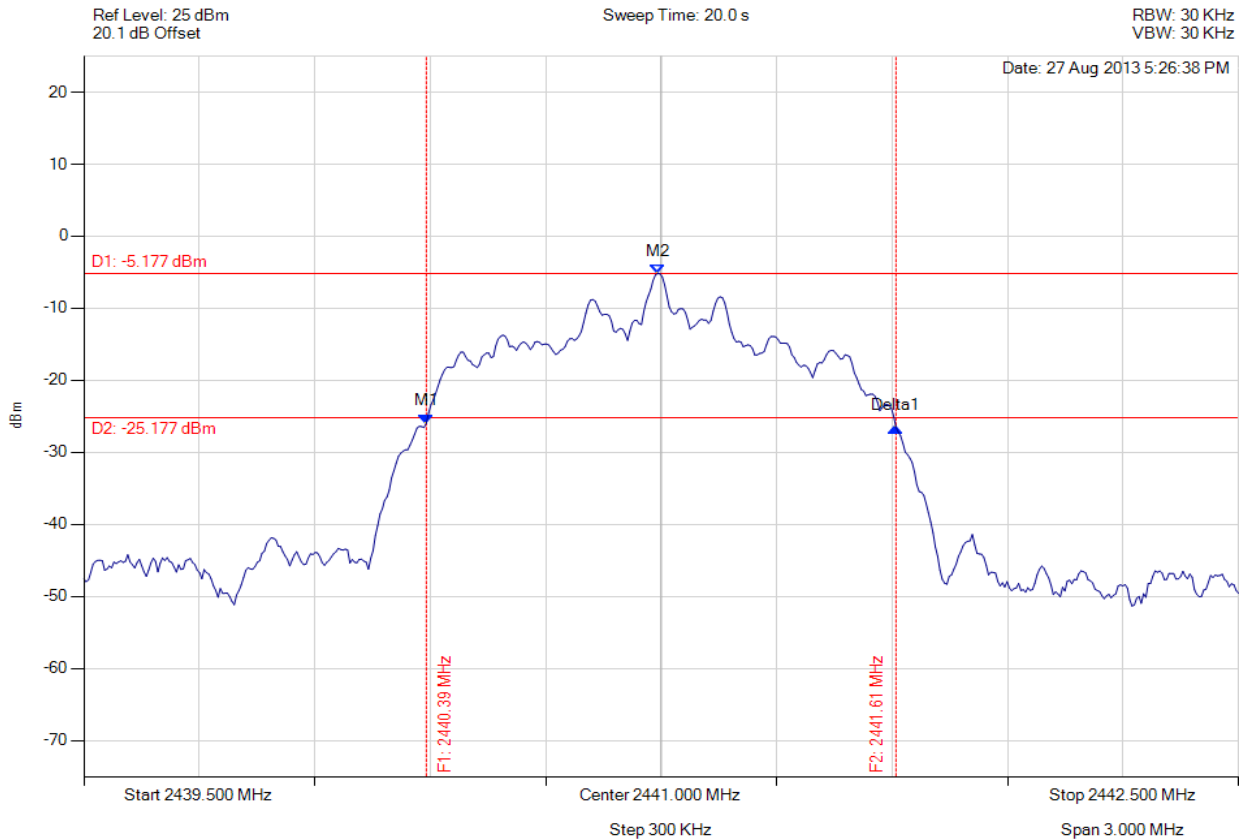

Analyser Setup	Marker : Frequency : Amplitude	Test Results
Detector = MAX PEAK Sweep Count = 0 RF Atten (dB) = 20 Trace Mode = VIEW	M1 : 2440.390 MHz : -25.966 dBm M2 : 2440.991 MHz : -5.177 dBm Delta1 : 1.220 MHz : -0.606 dB	Channel Power: 2.37 dBm Limit: 30.00 dBm Margin: -27.63 dB

[Back to the Matrix](#)

This test report may be reproduced in full only. The document may only be updated by MiCOM Labs personnel. Any changes will be noted in the Document History section of the report.



**Title:** Ear Force i30 Wireless Audio Headset  
**To:** FCC 47 CFR Part 15.247 & IC RSS-210  
**Serial #:** COMM37-U2 Rev A  
**Issue Date:** 25th September 2013  
**Page:** 118 of 127



### PEAK OUTPUT POWER

Variant: 802.15 3-DH1, Channel: 2480.00 MHz, Chain a, Temp: Ambient, Voltage: 3.7 Vdc

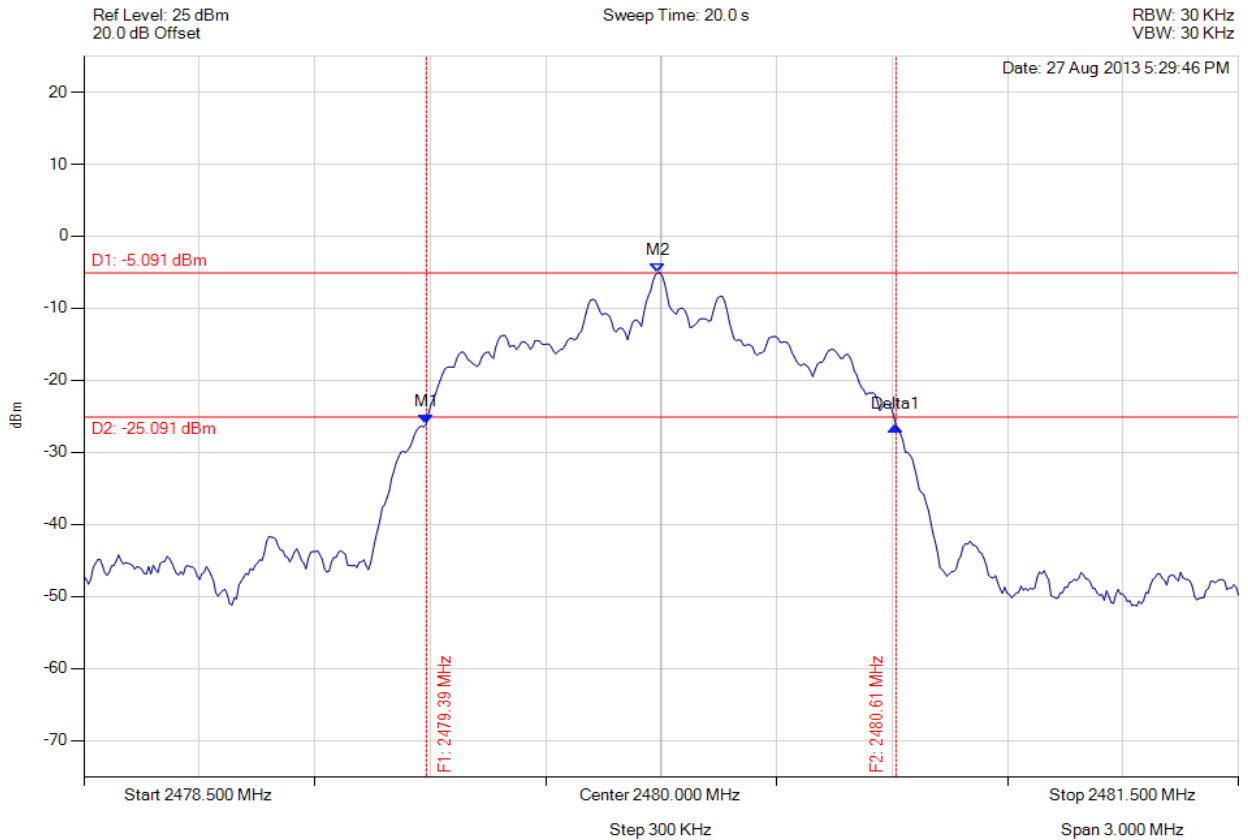

Analyser Setup	Marker : Frequency : Amplitude	Test Results
Detector = MAX PEAK Sweep Count = 0 RF Atten (dB) = 20 Trace Mode = VIEW	M1 : 2479.390 MHz : -26.075 dBm M2 : 2479.991 MHz : -5.091 dBm Delta1 : 1.220 MHz : -0.362 dB	Channel Power: 2.45 dBm Limit: 30.00 dBm Margin: -27.55 dB

[Back to the Matrix](#)

This test report may be reproduced in full only. The document may only be updated by MiCOM Labs personnel. Any changes will be noted in the Document History section of the report.



**Title:** Ear Force i30 Wireless Audio Headset  
**To:** FCC 47 CFR Part 15.247 & IC RSS-210  
**Serial #:** COMM37-U2 Rev A  
**Issue Date:** 25th September 2013  
**Page:** 119 of 127



**PEAK OUTPUT POWER**

Variant: 802.15, Channel: 2402.00 MHz, Chain a, Temp: Ambient, Voltage: 3.7 Vdc

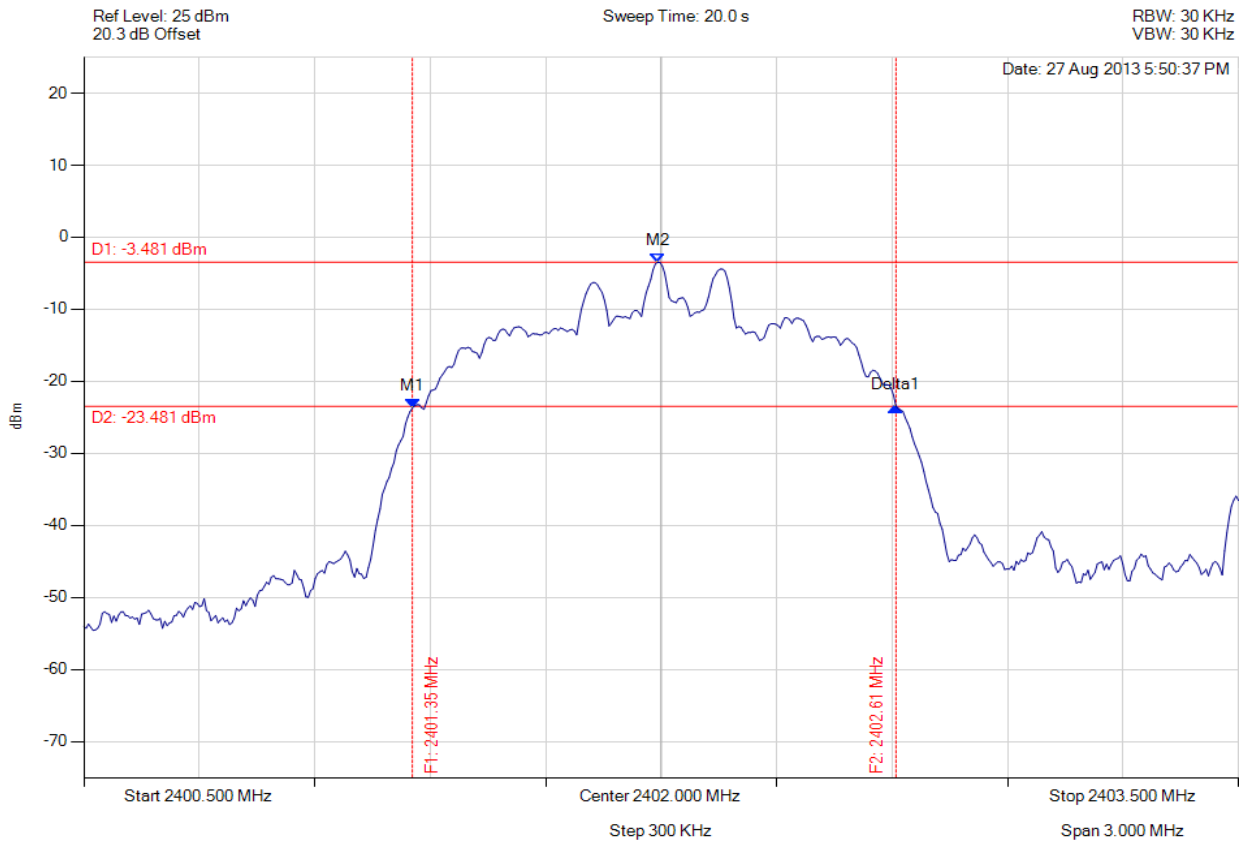

Analyser Setup	Marker : Frequency : Amplitude	Test Results
Detector = MAX PEAK Sweep Count = 0 RF Atten (dB) = 20 Trace Mode = VIEW	M1 : 2401.354 MHz : -23.708 dBm M2 : 2401.991 MHz : -3.481 dBm Delta1 : 1.257 MHz : 0.212 dB	Channel Power: 4.76 dBm Limit: 30.00 dBm Margin: -25.24 dB

[Back to the Matrix](#)

This test report may be reproduced in full only. The document may only be updated by MiCOM Labs personnel. Any changes will be noted in the Document History section of the report.



**Title:** Ear Force i30 Wireless Audio Headset  
**To:** FCC 47 CFR Part 15.247 & IC RSS-210  
**Serial #:** COMM37-U2 Rev A  
**Issue Date:** 25th September 2013  
**Page:** 120 of 127



### PEAK OUTPUT POWER

Variant: 802.15, Channel: 2441.00 MHz, Chain a, Temp: Ambient, Voltage: 3.7 Vdc

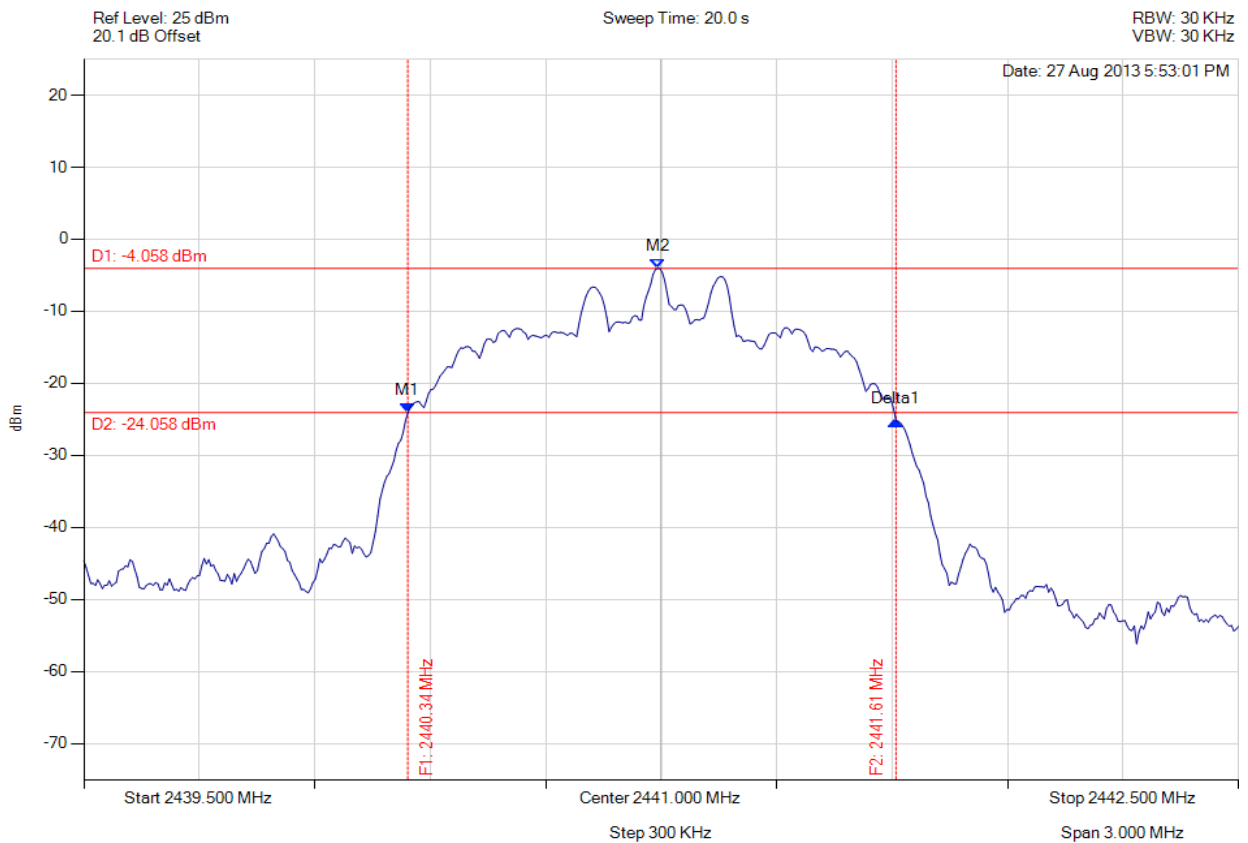

Analyser Setup	Marker : Frequency : Amplitude	Test Results
Detector = MAX PEAK Sweep Count = 0 RF Atten (dB) = 20 Trace Mode = VIEW	M1 : 2440.342 MHz : -24.125 dBm M2 : 2440.991 MHz : -4.058 dBm Delta1 : 1.269 MHz : -1.049 dB	Channel Power: 4.19 dBm Limit: 30.00 dBm Margin: -25.81 dB

[Back to the Matrix](#)

This test report may be reproduced in full only. The document may only be updated by MiCOM Labs personnel. Any changes will be noted in the Document History section of the report.





**Title:** Ear Force i30 Wireless Audio Headset  
**To:** FCC 47 CFR Part 15.247 & IC RSS-210  
**Serial #:** COMM37-U2 Rev A  
**Issue Date:** 25th September 2013  
**Page:** 121 of 127



**PEAK OUTPUT POWER**

Variant: 802.15, Channel: 2480.00 MHz, Chain a, Temp: Ambient, Voltage: 3.7 Vdc

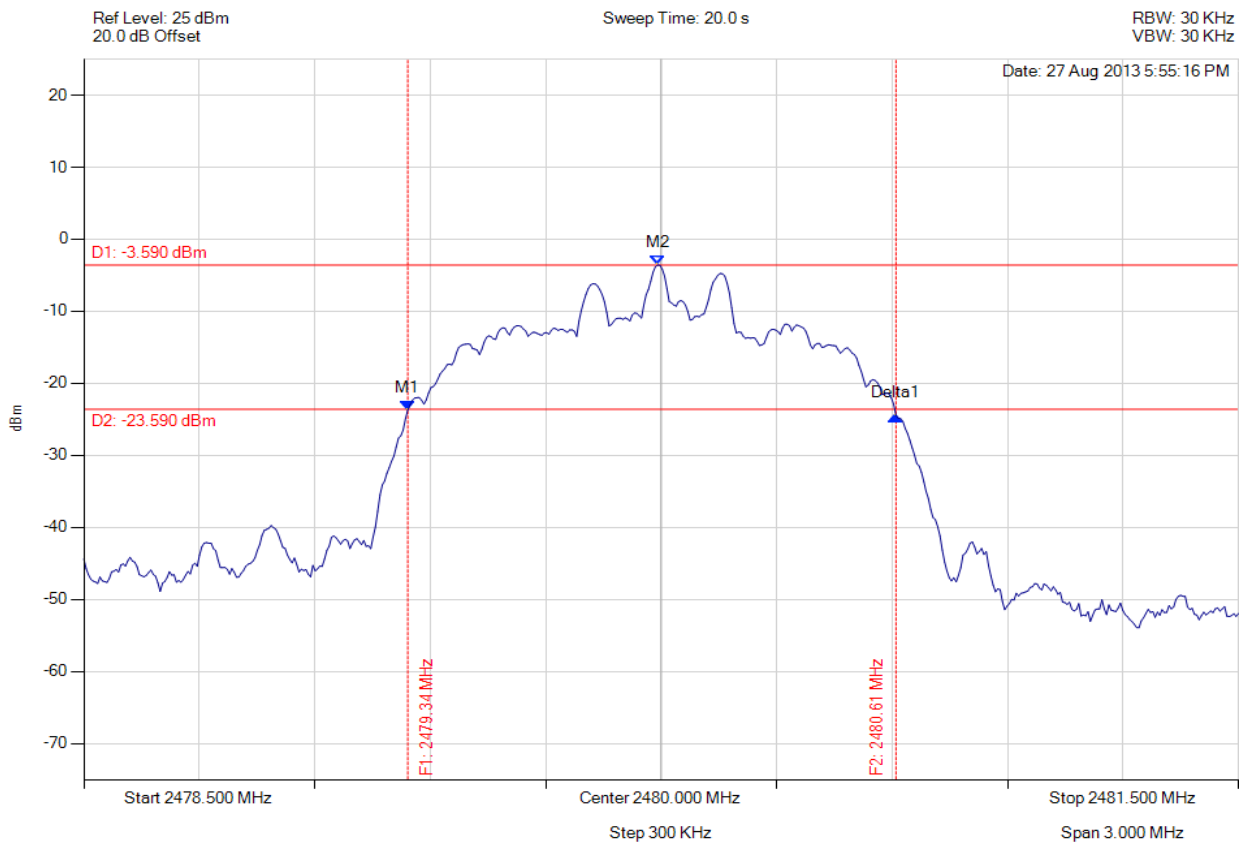

Analyser Setup	Marker : Frequency : Amplitude	Test Results
Detector = MAX PEAK Sweep Count = 0 RF Atten (dB) = 20 Trace Mode = VIEW	M1 : 2479.342 MHz : -23.696 dBm M2 : 2479.991 MHz : -3.590 dBm Delta1 : 1.269 MHz : -0.773 dB	Channel Power: 4.64 dBm Limit: 30.00 dBm Margin: -25.36 dB

[Back to the Matrix](#)

This test report may be reproduced in full only. The document may only be updated by MiCOM Labs personnel. Any changes will be noted in the Document History section of the report.

### A.1.6. Conducted Spurious Emissions



#### CONDUCTED LOW BAND-EDGE EMISSION - PEAK

Variant: 802.15, Channel: 2402.00 MHz, Chain a, Temp: Ambient, Voltage: 3.7 Vdc

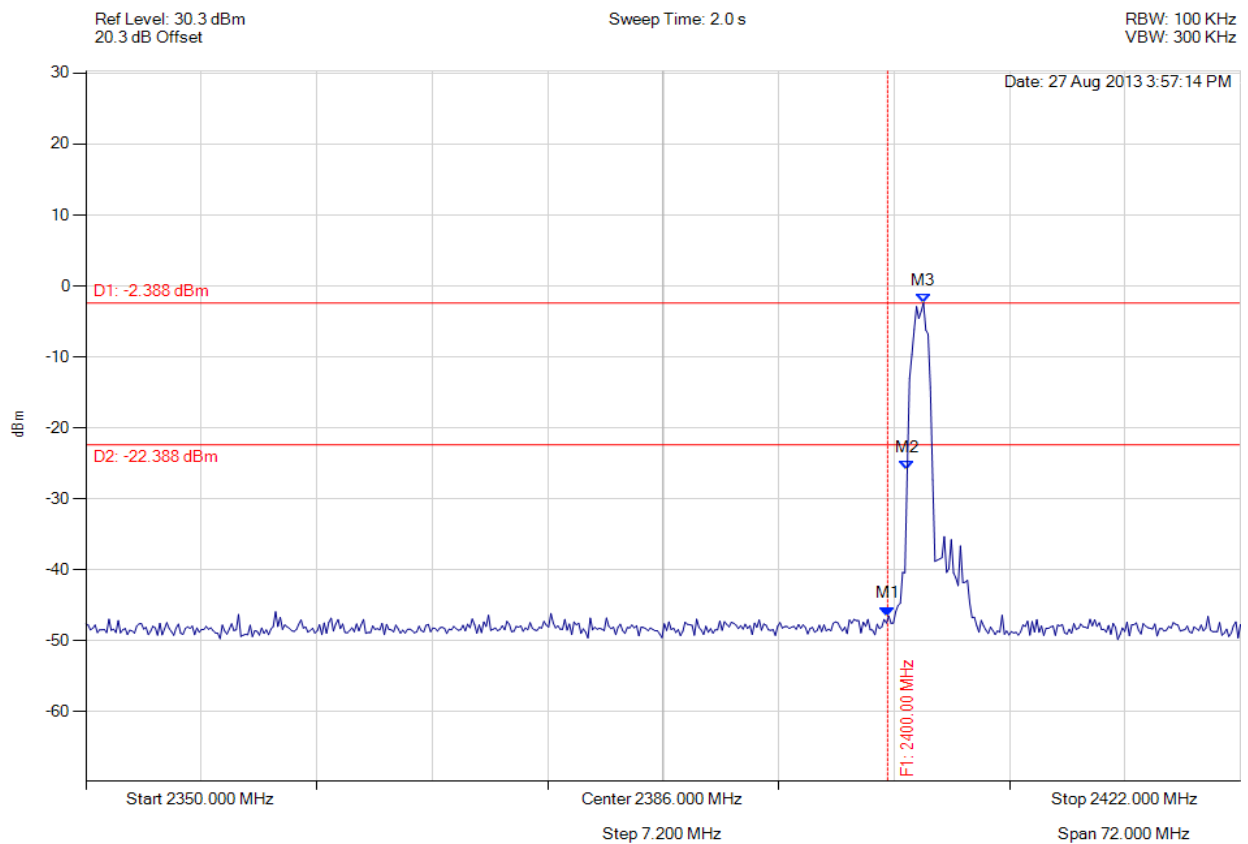

Analyser Setup	Marker : Frequency : Amplitude	Test Results
Detector = MAX PEAK Sweep Count = 0 RF Atten (dB) = 20 Trace Mode = VIEW	M1 : 2400.000 MHz : -46.508 dBm M2 : 2401.222 MHz : -25.960 dBm M3 : 2402.232 MHz : -2.388 dBm	Limit: -22.39 dBm Margin: -24.12 dB

[Back to the Matrix](#)

This test report may be reproduced in full only. The document may only be updated by MiCOM Labs personnel. Any changes will be noted in the Document History section of the report.



**Title:** Ear Force i30 Wireless Audio Headset  
**To:** FCC 47 CFR Part 15.247 & IC RSS-210  
**Serial #:** COMM37-U2 Rev A  
**Issue Date:** 25th September 2013  
**Page:** 123 of 127



### CONDUCTED SPURIOUS EMISSIONS - PEAK

Variant: 802.15, Channel: 2402.00 MHz, Chain a, Temp: Ambient, Voltage: 3.7 Vdc

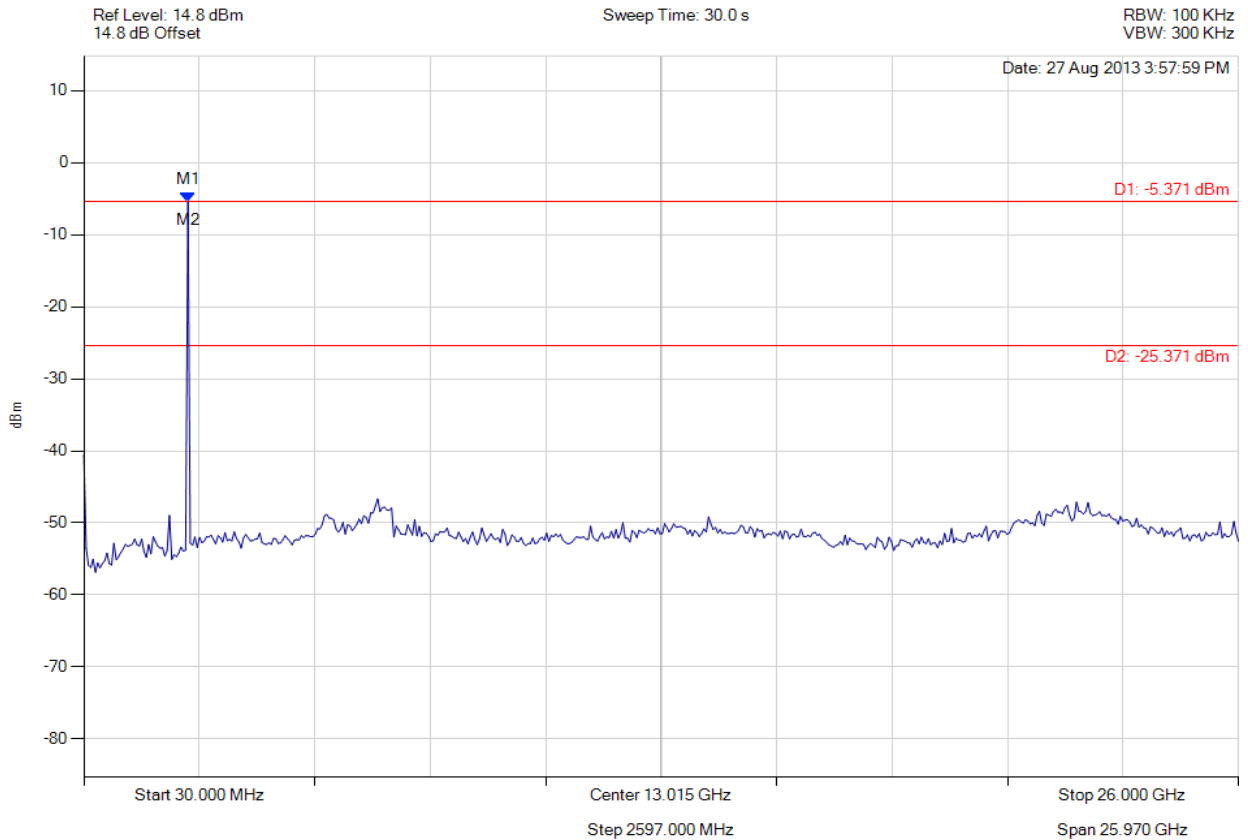

Analyser Setup	Marker : Frequency : Amplitude	Test Results
Detector = MAX PEAK Sweep Count = 0 RF Atten (dB) = 20 Trace Mode = VIEW	M1 : 2371.984 MHz : -5.371 dBm M2 : 6639.599 MHz : -46.650 dBm	Limit: -25.37 dBm Margin: -21.30 dB

[Back to the Matrix](#)

This test report may be reproduced in full only. The document may only be updated by MiCOM Labs personnel. Any changes will be noted in the Document History section of the report.



**Title:** Ear Force i30 Wireless Audio Headset  
**To:** FCC 47 CFR Part 15.247 & IC RSS-210  
**Serial #:** COMM37-U2 Rev A  
**Issue Date:** 25th September 2013  
**Page:** 124 of 127



### CONDUCTED SPURIOUS EMISSIONS - PEAK

Variant: 802.15, Channel: 2441.00 MHz, Chain a, Temp: Ambient, Voltage: 3.7 Vdc

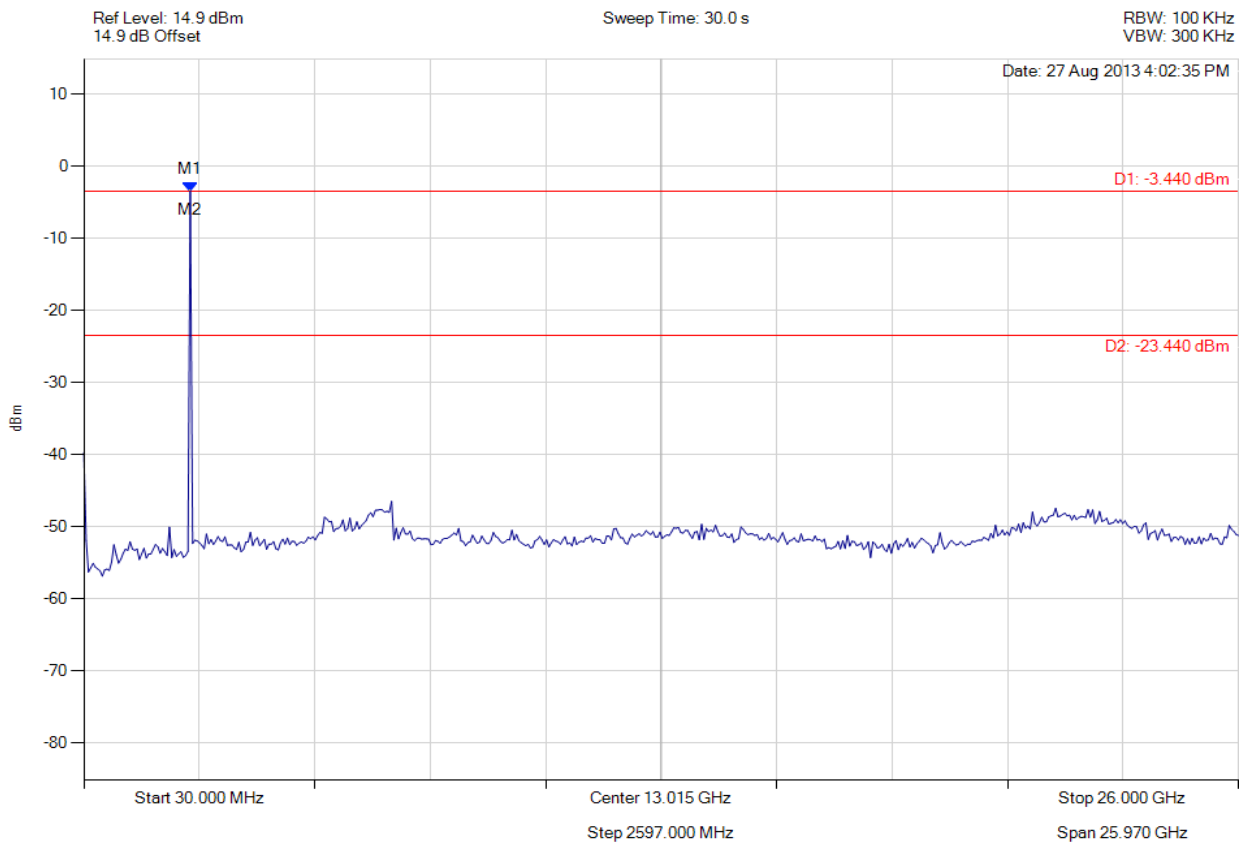

Analyser Setup	Marker : Frequency : Amplitude	Test Results
Detector = MAX PEAK Sweep Count = 0 RF Atten (dB) = 20 Trace Mode = VIEW	M1 : 2424.028 MHz : -3.440 dBm M2 : 6951.864 MHz : -46.493 dBm	Limit: -23.44 dBm Margin: -23.05 dB

[Back to the Matrix](#)

This test report may be reproduced in full only. The document may only be updated by MiCOM Labs personnel. Any changes will be noted in the Document History section of the report.



**Title:** Ear Force i30 Wireless Audio Headset  
**To:** FCC 47 CFR Part 15.247 & IC RSS-210  
**Serial #:** COMM37-U2 Rev A  
**Issue Date:** 25th September 2013  
**Page:** 125 of 127



### CONDUCTED SPURIOUS EMISSIONS - PEAK

Variant: 802.15, Channel: 2480.00 MHz, Chain a, Temp: Ambient, Voltage: 3.7 Vdc

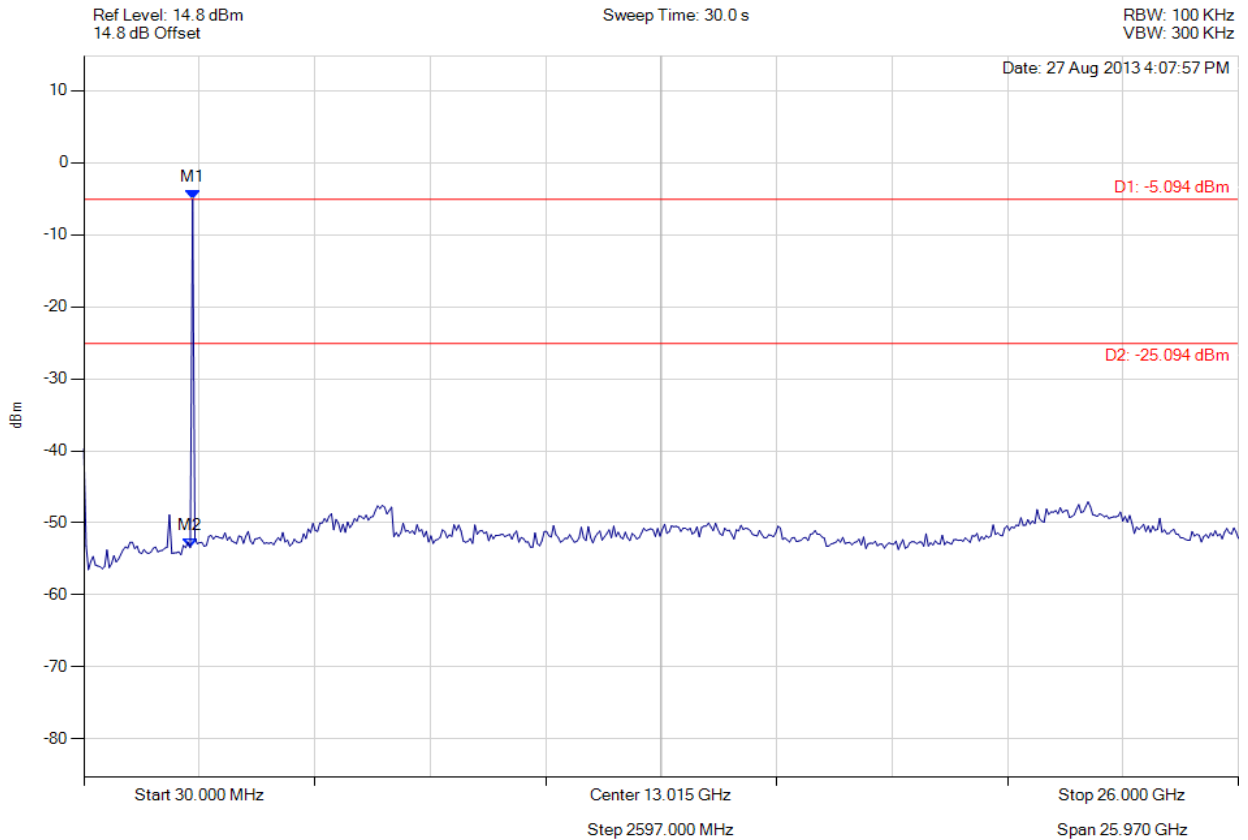

Analyser Setup	Marker : Frequency : Amplitude	Test Results
Detector = MAX PEAK Sweep Count = 0 RF Atten (dB) = 20 Trace Mode = VIEW	M1 : 2476.072 MHz : -5.094 dBm M2 : 6743.687 MHz : -47.553 dBm	Limit: -25.09 dBm Margin: -22.46 dB

[Back to the Matrix](#)

This test report may be reproduced in full only. The document may only be updated by MiCOM Labs personnel. Any changes will be noted in the Document History section of the report.



**Title:** Ear Force i30 Wireless Audio Headset  
**To:** FCC 47 CFR Part 15.247 & IC RSS-210  
**Serial #:** COMM37-U2 Rev A  
**Issue Date:** 25th September 2013  
**Page:** 126 of 127



**CONDUCTED HIGH BAND-EDGE EMISSION - PEAK**

Variant: 802.15, Channel: 2480.00 MHz, Chain a, Temp: Ambient, Voltage: 3.7 Vdc

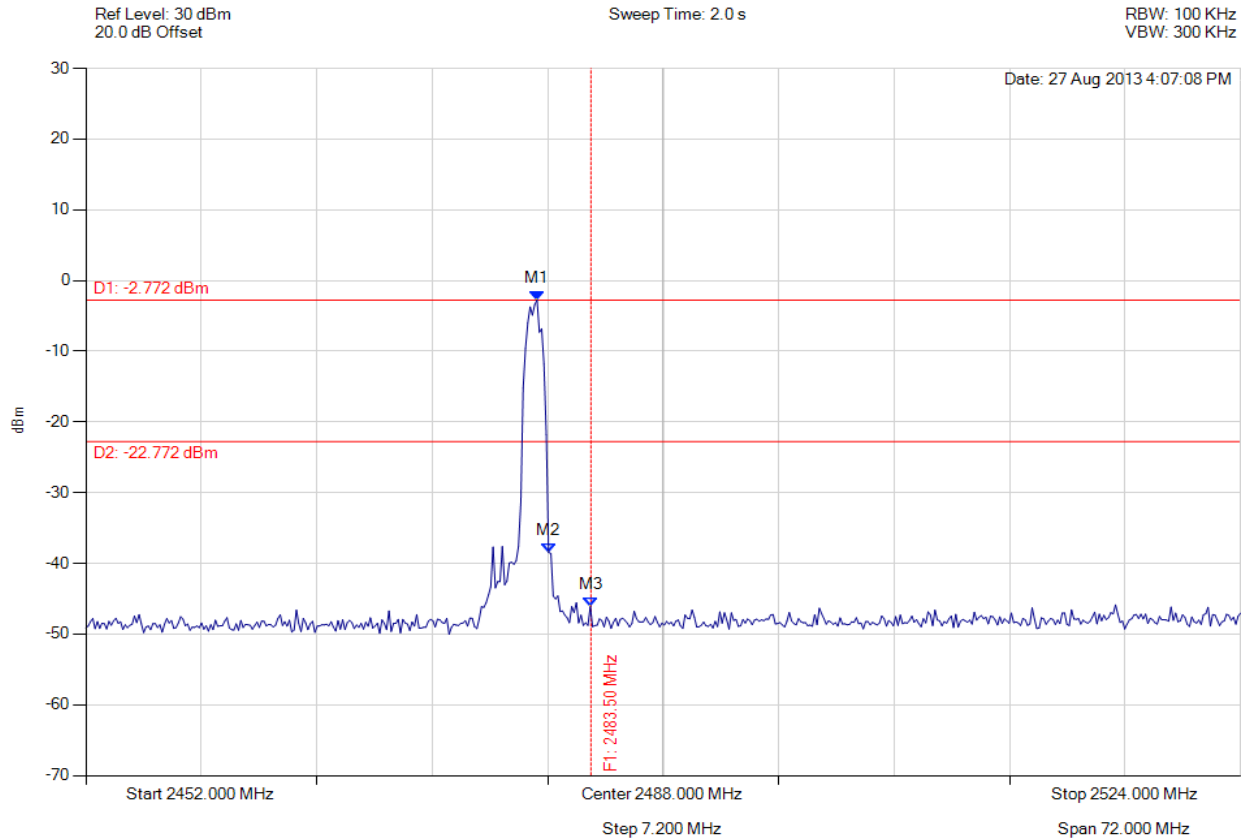

Analyser Setup	Marker : Frequency : Amplitude	Test Results
Detector = MAX PEAK Sweep Count = 0 RF Atten (dB) = 20 Trace Mode = VIEW	M1 : 2480.136 MHz : -2.772 dBm M2 : 2480.858 MHz : -38.466 dBm M3 : 2483.500 MHz : -46.115 dBm	Limit: -22.77 dBm Margin: -23.34 dB

[Back to the Matrix](#)

This test report may be reproduced in full only. The document may only be updated by MiCOM Labs personnel. Any changes will be noted in the Document History section of the report.



440 Boulder Court, Suite 200  
Pleasanton, CA 94566, USA  
Tel: 1.925.462.0304  
Fax: 1.925.462.0306  
[www.micomlabs.com](http://www.micomlabs.com)