

Test of
Ear Force Z300 RX Wireless Audio Headset
To: FCC 47 CFR Part 15.247 & IC RSS-210

Test Report Serial No.: COMM39-U2 Rev A



TEST REPORT

FROM



Test of Ear Force Z300 RX Wireless Audio Headset

to

To FCC 47 CFR Part 15.247 & IC RSS-210

Test Report Serial No.: COMM39-U2 Rev A

Note: this report contains data with regard to the 2400 to 2483.5 MHz Bluetooth operational modes of the Turtle Beach, Ear Force Z300 RX Wireless Audio Headset . 2400 to 2483.5 MHz Wi-Fi operational test data are reported in MiCOM Labs test report COMM39-U4, and 5150 - 5250 MHz test data are reported in MiCOM Labs test report COMM39-U6

This report supersedes: NONE

Applicant: Voyetra Turtle Beach Inc
100 Summit Lake Drive, Suite 100
Valhalla
New York, 10595, USA

Product Function: Wireless Audio Headset

Copy No: pdf Issue Date: 25th July 2013

This Test Report is Issued Under the Authority of:

MiCOM Labs, Inc.

440 Boulder Court, Suite 200

Pleasanton, CA 94566 USA

Phone: +1 (925) 462-0304

Fax: +1 (925) 462-0306

www.micomlabs.com



TEST CERTIFICATE #2381.01

MiCOM Labs is an ISO 17025 Accredited Testing Laboratory



Title: Ear Force Z300 RX Wireless Audio Headset
To: FCC 47 CFR Part 15.247 & IC RSS-210
Serial #: COMM39-U2 Rev A
Issue Date: 25th July 2013
Page: 3 of 145

This page has been left intentionally blank

This test report may be reproduced in full only. The document may only be updated by MiCOM Labs personnel. Any changes will be noted in the Document History section of the report.



Title: Ear Force Z300 RX Wireless Audio Headset
To: FCC 47 CFR Part 15.247 & IC RSS-210
Serial #: COMM39-U2 Rev A
Issue Date: 25th July 2013
Page: 4 of 145

TABLE OF CONTENTS

ACCREDITATION, LISTINGS & RECOGNITION	5
TESTING ACCREDITATION	5
RECOGNITION	6
PRODUCT CERTIFICATION	7
1. TEST RESULT CERTIFICATE	9
2. REFERENCES AND MEASUREMENT UNCERTAINTY	10
2.1. Normative References	10
2.2. Test and Uncertainty Procedures	11
3. PRODUCT DETAILS AND TEST CONFIGURATIONS	12
3.1. Technical Details	12
3.2. Scope of Test Program	13
3.3. Equipment Model(s) and Serial Number(s)	15
3.4. Antenna Details	15
3.5. Cabling and I/O Ports	15
3.6. Types of Modulation Supported	16
3.7. EUT Configurations	16
3.8. Equipment Modifications	16
3.9. Deviations from the Test Standard	16
4. TEST EQUIPMENT CONFIGURATION(S)	17
4.1. Conducted RF Emission Test Set-up	17
4.2. Radiated Spurious Emission Test Set-up > 1 GHz	18
4.3. Digital Emissions Test Set-up (0.03 – 1 GHz)	19
4.4. ac Wireline Emission Test Set-up	20
5. TEST SUMMARY	21
6. TEST RESULTS	23
6.1. Device Characteristics	23
6.1.1. <i>Conducted Testing</i>	23
6.1.2. <i>Radiated Emission Testing</i>	120
6.1.3. <i>AC Wireline Conducted Emissions (150 kHz – 30 MHz)</i>	140
7. PHOTOGRAPHS	142
7.1. Conducted Test Setup	142
7.2. Radiated Emissions Test Setup >1 GHz	143
8. TEST EQUIPMENT	144

This test report may be reproduced in full only. The document may only be updated by MiCOM Labs personnel. Any changes will be noted in the Document History section of the report.

ACCREDITATION, LISTINGS & RECOGNITION

TESTING ACCREDITATION

MiCOM Labs, Inc. is an accredited Electrical testing laboratory per the international standard EN ISO/IEC 17025. The company is accredited by the American Association for Laboratory Accreditation (A2LA) www.a2la.org test laboratory number 2381.01. MiCOM Labs test schedule is available at the following URL; <http://www.a2la.org/scopepdf/2381-01.pdf>



The American Association for Laboratory Accreditation

World Class Accreditation

Accredited Laboratory

A2LA has accredited

MICOM LABS

Pleasanton, CA

for technical competence in the field of

Electrical Testing

This laboratory is accredited in accordance with the recognized International Standard ISO/IEC 17025:2005 *General Requirements for the Competence of Testing and Calibration Laboratories*. This accreditation demonstrates technical competence for a defined scope and the operation of a laboratory quality management system (*refer to joint ISO-ILAC-IAF Communiqué dated 8 January 2009*).

Presented this 27th day of March 2012.



President & CEO
For the Accreditation Council
Certificate Number 2381.01
Valid to November 30, 2013

For the tests or types of tests to which this accreditation applies, please refer to the laboratory's Electrical Scope of Accreditation.

This test report may be reproduced in full only. The document may only be updated by MiCOM Labs personnel. Any changes will be noted in the Document History section of the report.



Title: Ear Force Z300 RX Wireless Audio Headset
To: FCC 47 CFR Part 15.247 & IC RSS-210
Serial #: COMM39-U2 Rev A
Issue Date: 25th July 2013
Page: 6 of 145

RECOGNITION

MiCOM Labs, Inc has widely recognized Electrical testing capabilities. Our international recognition includes Conformity Assessment Body designation by APEC MRA** countries. Our test reports are widely accepted for global type approvals.

Country	Recognition Body	Status	Phase	Identification No.
USA	Federal Communications Commission (FCC)	TCB	-	US0159 Listing #: 102167
Canada	Industry Canada (IC)	FCB	APEC MRA 2	US0159 Listing #: 4143A-2
Japan	MIC (Ministry of Internal Affairs and Communication)	CAB	APEC MRA 2	RCB 210
	VCCI	--	--	A-0012
Europe	European Commission	NB	EU MRA	NB 2280
Australia	Australian Communications and Media Authority (ACMA)	CAB	APEC MRA 1	US0159
Hong Kong	Office of the Telecommunication Authority (OFTA)	CAB	APEC MRA 1	
Korea	Ministry of Information and Communication Radio Research Laboratory (RRL)	CAB	APEC MRA 1	
Singapore	Infocomm Development Authority (IDA)	CAB	APEC MRA 1	
Taiwan	National Communications Commission (NCC) Bureau of Standards, Metrology and Inspection (BSMI)	CAB	APEC MRA 1	
Vietnam	Ministry of Communication (MIC)	CAB	APEC MRA 1	

**APEC MRA – Asia Pacific Economic Community Mutual Recognition Agreement.

Is a recognition agreement under which test lab is accredited to regulatory standards of the APEC member countries.

Phase I - recognition for product testing

Phase II – recognition for both product testing and certification

N/A – Not Applicable

**EU MRA – European Union Mutual Recognition Agreement.

Is a recognition agreement under which test lab is accredited to regulatory standards of the EU member countries.

**NB – Notified Body

This test report may be reproduced in full only. The document may only be updated by MiCOM Labs personnel. Any changes will be noted in the Document History section of the report.



Title: Ear Force Z300 RX Wireless Audio Headset
To: FCC 47 CFR Part 15.247 & IC RSS-210
Serial #: COMM39-U2 Rev A
Issue Date: 25th July 2013
Page: 7 of 145

PRODUCT CERTIFICATION

MiCOM Labs, Inc. is an accredited Product Certification Body per the international standard EN ISO/IEC Guide 65. The company is accredited by the American Association for Laboratory Accreditation (A2LA) www.a2la.org test laboratory number 2381.02. MiCOM Labs test schedule is available at the following URL; <http://www.a2la.org/scopepdf/2381-02.pdf>



The American Association for Laboratory Accreditation

"World Class Accreditation"

Accredited Product Certification Body

A2LA has accredited

MICOM LABS

Pleasanton, CA

for technical competence as a

Product Certification Body

This product certification body is accredited in accordance with the recognized International Standard ISO/IEC Guide 65:1996 *General requirements for bodies operating product certification systems*. This accreditation demonstrates technical competence for a defined scope and the operation of a quality management system.

Presented this 27th day of March 2012.



Peter Abney

President & CEO
For the Accreditation Council
Certificate Number 2381.02
Valid to November 30, 2013

For the product certification schemes to which this accreditation applies, please refer to the organization's Product Certification Scope of Accreditation

United States of America – Telecommunication Certification Body (TCB)

TCB Identifier – US0159

Industry Canada – Certification Body

CAB Identifier – US0159

Europe – Notified Body

Notified Body Identifier - 2280

Japan – Recognized Certification Body (RCB)

RCB Identifier - 210

This test report may be reproduced in full only. The document may only be updated by MiCOM Labs personnel. Any changes will be noted in the Document History section of the report.



Title: Ear Force Z300 RX Wireless Audio Headset
To: FCC 47 CFR Part 15.247 & IC RSS-210
Serial #: COMM39-U2 Rev A
Issue Date: 25th July 2013
Page: 8 of 145

DOCUMENT HISTORY

Document History		
Revision	Date	Comments
Draft		
Rev A	25 th July 2013	Initial release.

This test report may be reproduced in full only. The document may only be updated by MiCOM Labs personnel. Any changes will be noted in the Document History section of the report.



Title: Ear Force Z300 RX Wireless Audio Headset
To: FCC 47 CFR Part 15.247 & IC RSS-210
Serial #: COMM39-U2 Rev A
Issue Date: 25th July 2013
Page: 9 of 145

1. TEST RESULT CERTIFICATE

Manufacturer:	Voyetra Turtle Beach Inc 100 Summit Lake Drive, Suite 100 Valhalla New York, 10595, USA	Tested By:	MiCOM Labs, Inc. 440 Boulder Court Suite 200 Pleasanton California, 94566, USA
EUT:	Wireless Audio Headset	Telephone:	+1 925 462 0304
Model:	Ear Force Z300 RX (TB300-6060-01)	Fax:	+1 925 462 0306
S/N's:	Rad - G2290C5200063, Cond - G22900C5200134		
Test Date(s):	8th January to 29th January '13	Website:	www.micomlabs.com

STANDARD(S)	TEST RESULTS
FCC 47 CFR Part 15.247 & IC RSS-210	EQUIPMENT COMPLIES

MiCOM Labs, Inc. tested the equipment mentioned in accordance with the requirements set forth in the above standards. Test results indicate that the equipment tested is capable of demonstrating compliance with the requirements as documented within this report.

Notes:

1. This document reports conditions under which testing was conducted and the results of testing performed.
2. Details of test methods used have been recorded and kept on file by the laboratory.
3. Test results apply only to the item(s) tested.

Approved & Released for MiCOM Labs, Inc. by:



TEST CERTIFICATE #2381.01



Graeme Grieve
Quality Manager MiCOM Labs,

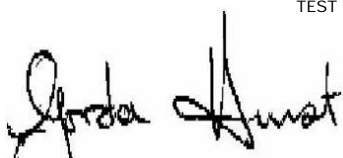

Gordon Hurst
President & CEO MiCOM Labs, Inc.

This test report may be reproduced in full only. The document may only be updated by MiCOM Labs personnel. Any changes will be noted in the Document History section of the report.

2. REFERENCES AND MEASUREMENT UNCERTAINTY

2.1. Normative References

REF.	PUBLICATION	YEAR	TITLE
i.	FCC 47 CFR Part 15, Subpart C	2012	Title 47: Telecommunication PART 15—RADIO FREQUENCY DEVICES Subpart C—Intentional Radiators
ii.	RSS-210 Annex 8	2010	Radio Standards Specification 210, Issue 8, Low-power Licence-exempt Radiocommunication Devices (All Frequency Bands): Category I Equipment
iii.	FCC OET KDB 662911	4 th April 2011	Emissions Testing of Transmitters with Multiple Outputs in the Same Band
iv.	DA 00-705	2000	FCC DA 00-705 "Filing and Measurement Guidelines for Frequency Hopping Spread Spectrum Systems" released March 30, 2000
v.	RSS-GEN	2010	Radio Standards Specification-Gen, Issue 3, General Requirements and Information for the Certification of Radiocommunication Equipment
vi.	FCC 47 CFR Part 15, Subpart B	2010	47 CFR Part 15, SubPart B; Unintentional Radiators
vii.	ICES-003	2004	Spectrum Management and Telecommunications Policy Interference-Causing Equipment Standard Digital Apparatus; Issue 4
viii.	ANSI C63.4	2009	American National Standards for Methods of Measurement of Radio-Noise Emissions from Low-Voltage Electrical and Electronic Equipment in the Range of 9 kHz to 40 GHz
ix.	CISPR 22/ EN 55022	2008 2006+A1:2007	Limits and Methods of Measurements of Radio Disturbance Characteristics of Information Technology Equipment
x.	M 3003	Edition 2 Jan. 2007	Expression of Uncertainty and Confidence in Measurements
xi.	LAB34	Edition 1 Aug 2002	The expression of uncertainty in EMC Testing
xii.	ETSI TR 100 028	2001	Parts 1 and 2 Electromagnetic compatibility and Radio Spectrum Matters (ERM); Uncertainties in the measurement of mobile radio equipment characteristics
xiii.	A2LA	July 2012	Reference to A2LA Accreditation Status – A2LA Advertising Policy

This test report may be reproduced in full only. The document may only be updated by MiCOM Labs personnel. Any changes will be noted in the Document History section of the report.



Title: Ear Force Z300 RX Wireless Audio Headset
To: FCC 47 CFR Part 15.247 & IC RSS-210
Serial #: COMM39-U2 Rev A
Issue Date: 25th July 2013
Page: 11 of 145

2.2. Test and Uncertainty Procedures

Conducted and radiated emission measurements were conducted in accordance with American National Standards Institute ANSI C63.4, listed in the Normative References section of this report.

Measurement uncertainty figures are calculated in accordance with ETSI TR 100 028 Parts 1 and 2.

Measurement uncertainties stated are based on a standard uncertainty multiplied by a coverage factor $k = 2$, providing a level of confidence of approximately 95 % in accordance with UKAS document M 3003 listed in the Normative References section of this report.

This test report may be reproduced in full only. The document may only be updated by MiCOM Labs personnel. Any changes will be noted in the Document History section of the report.



Title: Ear Force Z300 RX Wireless Audio Headset
To: FCC 47 CFR Part 15.247 & IC RSS-210
Serial #: COMM39-U2 Rev A
Issue Date: 25th July 2013
Page: 12 of 145

3. PRODUCT DETAILS AND TEST CONFIGURATIONS

3.1. Technical Details

Details	Description
Purpose:	Test of the Ear Force Z300 RX Wireless Audio Headset to FCC Part 15.247 and Industry Canada RSS-210 regulations.
Applicant:	Voyetra Turtle Beach Inc 100 Summit Lake Drive, Suite 100 Valhalla New York, 10595, USA
Manufacturer:	As applicant.
Laboratory performing the tests:	MiCOM Labs, Inc. 440 Boulder Court, Suite 200 Pleasanton, California 94566 USA
Test report reference number:	COMM39-U2 Rev A
Date EUT received:	8 th January 2013
Standard(s) applied:	FCC 47 CFR Part 15.247 & IC RSS-210
Dates of test (from - to):	8th January to 29th January '13
No of Units Tested:	Two
Type of Equipment:	Wireless Audio Headset
Manufacturers Trade Name:	Ear Force
Model(s):	Z300 RX (TB300-6060-01) XP510 RX (TB300-2290-01)*
Location for use:	Indoor
Declared Frequency Range(s):	2400 - 2483.5 MHz
Hardware Rev	1.0
Software Rev	3.5
Rated Input Voltage and Current:	3.7 Vdc (Battery)
Operating Temperature Range:	Declared range 0° to +50°C at 95% humidity non condensing
Equipment Dimensions:	9 x 6 x 3.5 inches
Weight:	7 oz
Primary function of equipment:	Wireless Audio Headset

* The Ear Force XP510 RX was used as the EUT for test program, the Bluetooth module in the XP510 RX is identical to the Ear Force Z300 RX and is mounted in the same host board in the same location. The test data in this test report was previously report in MiCOM Labs Test Report number COMM19-U1 Rev A dated 14th February 2013.

This test report may be reproduced in full only. The document may only be updated by MiCOM Labs personnel. Any changes will be noted in the Document History section of the report.

3.2. Scope of Test Program

Ear Force Z300 RX Wireless Audio Headset RF Testing

The scope of the test program was to test the Ear Force Z300 RX Wireless Audio Headset , in the frequency ranges 2400 - 2483.5 MHz for compliance against FCC 47 CFR Part 15.247 and Industry Canada RSS-210 specifications.

The Ear Force XP510 RX was used as the EUT for test program, the Bluetooth module in the XP510 RX is identical to the Ear Force Z300 RX and is mounted in the same host board in the same location. The test data in this test report was previously report in MiCOM Labs Test Report COMM19-U1 Rev A dated 14th February 2013.

Ear Force Z300 RX Wireless Audio Headset



This test report may be reproduced in full only. The document may only be updated by MiCOM Labs personnel. Any changes will be noted in the Document History section of the report.

Ear Force Z300 RX Wireless Audio Headset



This test report may be reproduced in full only. The document may only be updated by MiCOM Labs personnel. Any changes will be noted in the Document History section of the report.



Title: Ear Force Z300 RX Wireless Audio Headset
To: FCC 47 CFR Part 15.247 & IC RSS-210
Serial #: COMM39-U2 Rev A
Issue Date: 25th July 2013
Page: 15 of 145

3.3. Equipment Model(s) and Serial Number(s)

Equipment Type	Equipment Description (Including Brand Name)	Mfr	Model No.	Serial No.
EUT	Wireless Audio Headset	Voyetra Turtle Beach	Ear Force Z300 RX (XP510 RX)	Rad - G2290C5200063, Cond - G22900C5200134
Support	Laptop PC	IBM	Thinkpad	None

3.4. Antenna Details

Antenna Type	Manufacturer	Model Number	Antenna Gain (dBi)	
			2.4 GHz	5 GHz
On Board Folded F - Bluetooth	Turtle Beach	PCB	2.8	--
Chip	Fractus	FR05-S1-NO-1-004	-1.5	--
Chip	Fractus	FR05-S1-NO-1-004	--	3.3

3.5. Cabling and I/O Ports

Number and type of I/O ports

1. 1 x USB (charge only)
2. 1 x 2.5mm Analog Audio Input

This test report may be reproduced in full only. The document may only be updated by MiCOM Labs personnel. Any changes will be noted in the Document History section of the report.



Title: Ear Force Z300 RX Wireless Audio Headset
To: FCC 47 CFR Part 15.247 & IC RSS-210
Serial #: COMM39-U2 Rev A
Issue Date: 25th July 2013
Page: 16 of 145

3.6. Types of Modulation Supported

Operational Mode(s) (802.15.2)	Packet type	Data Rate (Mbits/s)	Frequencies (MHz)
FHSS: GFSK $\pi/4$ DQSK 8DPSK	DH1	1, 2, 3	2,402
	DH3	1, 2, 3	2,441
	DH5	1, 2, 3	2,480

3.7. EUT Configurations

Band (GHz)	Mode	Freq Band (MHz)	Freq Range (MHz)	Low Ch.	Mid Ch.	High Ch.	# Ch.	Ch. Spacing (MHz)
2.4	Bluetooth	2400-2483.5	2402-2480	2402	2441	2480	79	1 MHz

3.8. Equipment Modifications

None.

3.9. Deviations from the Test Standard

The following deviations from the test standard were required in order to complete the test program:

1. NONE

This test report may be reproduced in full only. The document may only be updated by MiCOM Labs personnel. Any changes will be noted in the Document History section of the report.

4. TEST EQUIPMENT CONFIGURATION(S)

4.1. Conducted RF Emission Test Set-up

The following tests were performed using the conducted test set-up shown in the diagram below.

1. Section 6.1.1.1. 20 dB Bandwidth
2. Section 6.1.1.2. Carrier Frequency Separation
3. Section 6.1.1.3. Number of Hopping Frequencies
4. Section 6.1.1.4. Time of Occupancy (Dwell Time)
5. Section 6.1.1.5 Channel Occupancy
6. Section 6.1.1.5 Peak Output Power
7. Section 6.1.1.7 Band-Edge
8. Section 6.1.1.8 Spurious RF Conducted – Transmitter
9. Section 6.1.1.9 Spurious RF Conducted - Receiver

Conducted Test Set-Up Pictorial Representation

Test Measurement set up

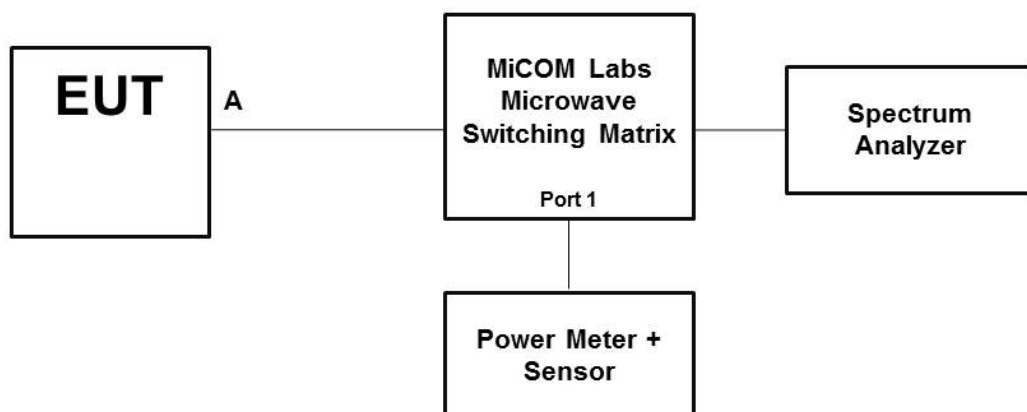

Conducted Test Measurement Setup

4.2. Radiated Spurious Emission Test Set-up > 1 GHz

The following tests were performed using the conducted test set-up shown in the diagram below.

1. Section 6.1.2.1. Patch PC.11
2. Section 6.1.2.2. Patch FXP.830
3. Section 6.1.2.3. Omni SA-006-1

Radiated Emission Measurement Setup – Above 1 GHz

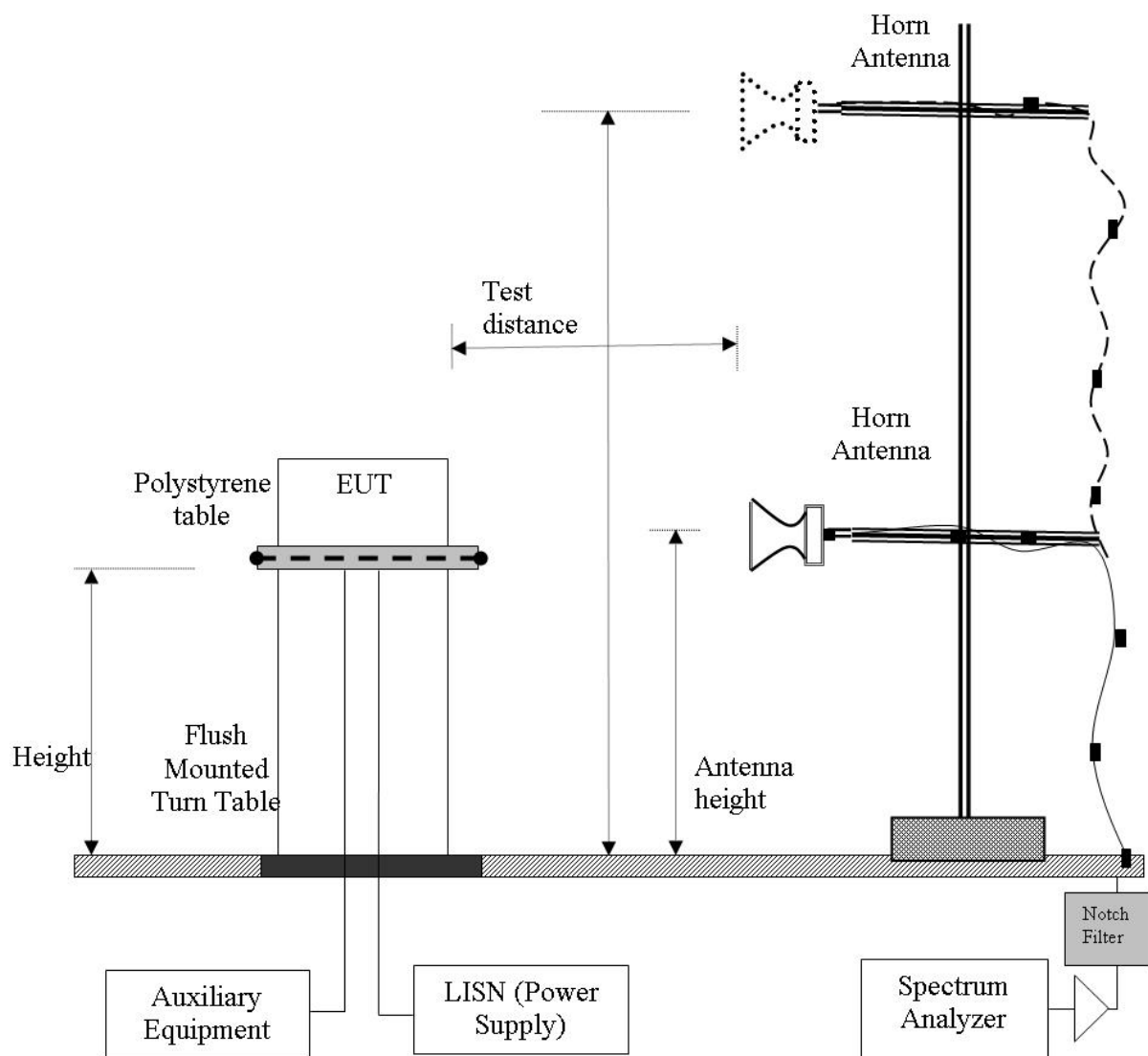

This test report may be reproduced in full only. The document may only be updated by MiCOM Labs personnel. Any changes will be noted in the Document History section of the report.

4.3. Digital Emissions Test Set-up (0.03 – 1 GHz)

The following tests were performed using the conducted test set-up shown in the diagram below.

1. Section 6.1.2.4. Patch PC.11

Digital Emission Measurement Setup – Below 1 GHz

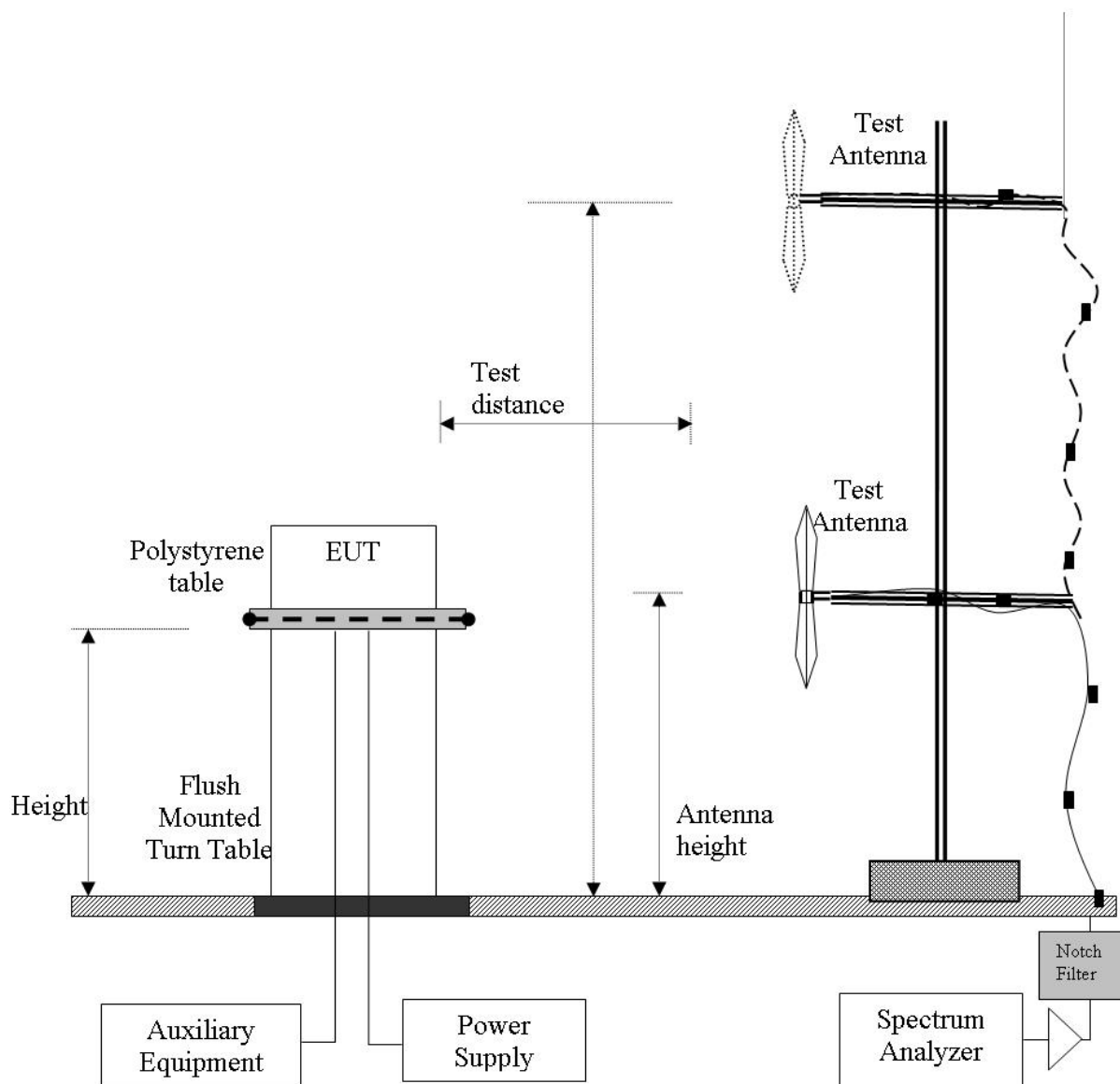

This test report may be reproduced in full only. The document may only be updated by MiCOM Labs personnel. Any changes will be noted in the Document History section of the report.

4.4. ac Wireline Emission Test Set-up

The following tests were performed using the conducted test set-up shown in the diagram below.

Not Required EUT not powered by AC.

1. Section 6.1.3 ac Wireline Conducted Emissions

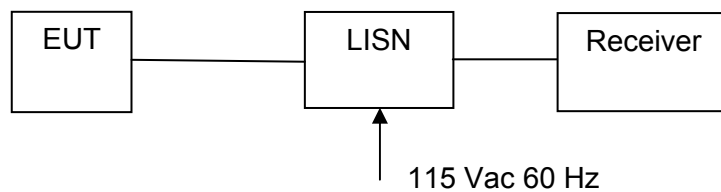

Measurement Setup for Conducted Emissions Test



Title: Ear Force Z300 RX Wireless Audio Headset
To: FCC 47 CFR Part 15.247 & IC RSS-210
Serial #: COMM39-U2 Rev A
Issue Date: 25th July 2013
Page: 21 of 145

5. TEST SUMMARY

List of Measurements - Conducted

The following table represents the list of measurements required under the **FCC CFR47 Part 15.247** and **Industry Canada RSS-210** and **Industry Canada RSS-Gen.**

Section(s)	Test Items / Description	Condition	Result	Test Report Section
15.247(a)(1) A8.1(a) 4.4	20 dB Bandwidths	Conducted	Complies	6.1.1.1
15.247(a)(1) A8.1(d)	Carrier Frequency Separation	Conducted	Complies	6.1.1.2
15.247(a)(1) A8.1(d)	Number of Hopping Frequencies	Conducted	Complies	6.1.1.3
15.247(a)(1)(iii) A8.1(d)	Time of Occupany (Dwell Time)	Conducted	Complies	6.1.1.4
15.247(a)(1)(iii) A8.1(d)	Channel Occupancy	Conducted	Complies	6.1.1.5
15.247(b)(2) A8.4(2)	Peak Output Power	Conducted	Complies	6.1.1.6
15.247(d) A8.5	Band-Edge	Conducted	Complies	6.1.1.7

This test report may be reproduced in full only. The document may only be updated by MiCOM Labs personnel. Any changes will be noted in the Document History section of the report.



Title: Ear Force Z300 RX Wireless Audio Headset
To: FCC 47 CFR Part 15.247 & IC RSS-210
Serial #: COMM39-U2 Rev A
Issue Date: 25th July 2013
Page: 22 of 145

List of Measurements (continued)

The following table represents the list of measurements required under the **FCC CFR47 Part 15.247**, **Industry Canada RSS-210**, and **Industry Canada RSS-Gen**.

Section(s)	Test Items	Description	Condition	Result	Test Report Section
15.247(d) 15.205 / 15.209 A8.5 2.2 2.6 4.7	Transmitter Radiated Spurious Emissions	Emissions above 1 GHz	Radiated	Complies	6.1.2.1
	Radiated Band Edge	Band-edge results	Radiated	Complies	
15.205 / 15.209 2.2	Radiated Spurious Emissions	Emissions <1 GHz (30M- 1 GHz)	Radiated	Complies	6.1.2.2
15.207 7.2.2	AC Wireline Conducted Emissions 150 kHz– 30 MHz	Conducted Emissions	Conducted	N/A EUT is DC powered	6.1.3

Note 1: Test results reported in this document relate only to the items tested

Note 2: The required tests demonstrated compliance as per client declaration of test configuration, monitoring methodology and associated pass/fail criteria

Note 3: Section 3.7 Equipment Modifications highlights the equipment modifications that were required to bring the product into compliance with the above test matrix

This test report may be reproduced in full only. The document may only be updated by MiCOM Labs personnel. Any changes will be noted in the Document History section of the report.



Title: Ear Force Z300 RX Wireless Audio Headset
To: FCC 47 CFR Part 15.247 & IC RSS-210
Serial #: COMM39-U2 Rev A
Issue Date: 25th July 2013
Page: 23 of 145

6. TEST RESULTS

6.1. Device Characteristics

6.1.1. Conducted Testing

6.1.1.1. 20 dB Bandwidth

Conducted Test Conditions for 20 dB Bandwidth			
Standard:	FCC CFR 47:15.247	Ambient Temp. (°C):	18.0 - 27.5
Test Heading:	20 dB Bandwidth	Rel. Humidity (%):	32 - 45
Standard Section(s):	15.247 (a)(2)	Pressure (mBars):	999 - 1001
Reference Document(s):	FCC DA 00-705 "Filing and Measurement Guidelines for Frequency Hopping Spread Spectrum Systems"		
Test Procedure for 20 dB Bandwidth Measurement The bandwidth at 20 dB was measured with a spectrum analyzer connected to the antenna terminal, while EUT is operating in transmission mode at the appropriate centre frequency. Although there are no limits for 20 dB bandwidth for frequency hopping systems in the 2400-2483.5 MHz band. The 20 dB bandwidth is required to calculate the carrier frequency separation limits.			

The EUT was tested at the highest data rate available (3 Mbits/s) for each packet type DH1, DH3 and DH5.

This test report may be reproduced in full only. The document may only be updated by MiCOM Labs personnel. Any changes will be noted in the Document History section of the report.



Title: Ear Force Z300 RX Wireless Audio Headset
To: FCC 47 CFR Part 15.247 & IC RSS-210
Serial #: COMM39-U2 Rev A
Issue Date: 25th July 2013
Page: 24 of 145

3-DH1, 3 Mbs/sec

Equipment Configuration for 6 dB & 99% Bandwidth			
Variant:	802.15.2	Duty Cycle (%):	100%
Data Rate:	3 Mbit/s	Antenna Gain (dBi):	2.8
Modulation:	8DPSK,	Beam Forming Gain (Y):	Not Applicable
TPC:	N/A		
Engineering Test Notes:	3 Mbit/s (8DPSK) has the widest span, Widest Span for each packet type reported		

Test Measurement Results				
Packet Type	Measured 20 dB Bandwidth (MHz)			
	Port(s)			
MHz	a	b	c	d
2,402	1.160	--	--	--
2,441	1.154	--	--	--
2,480	1.154	--	--	--

Traceability to Industry Recognized Test Methodologies	
Work Instruction:	WI-03 MEASURING RF SPECTRUM MASK
Measurement Uncertainty:	±2.81 dB

This test report may be reproduced in full only. The document may only be updated by MiCOM Labs personnel. Any changes will be noted in the Document History section of the report.



20 dB Bandwidth Channel 0, 3-DH1, 3 Mbs/sec

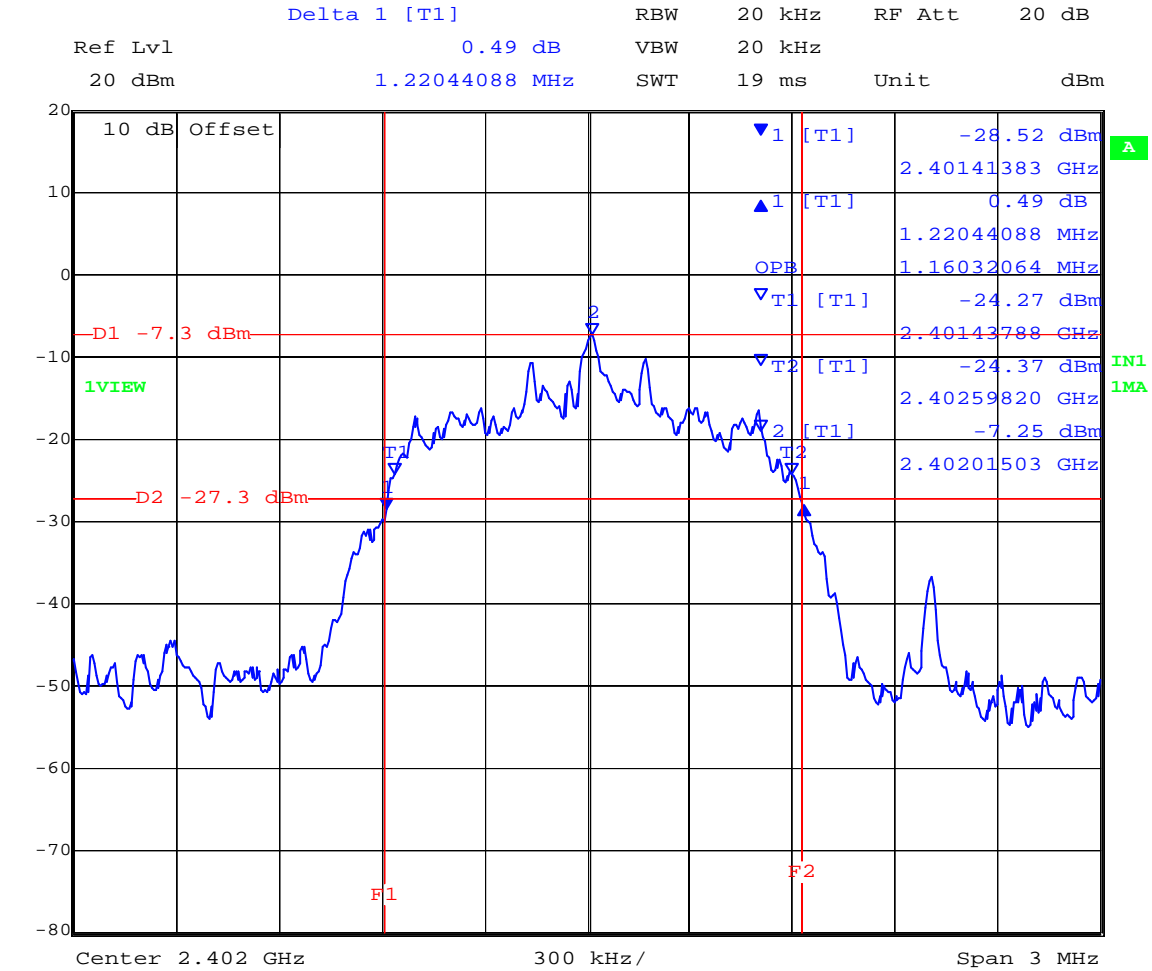

Date: 17.JAN.2013 10:08:47

This test report may be reproduced in full only. The document may only be updated by MiCOM Labs personnel. Any changes will be noted in the Document History section of the report.



Title: Ear Force Z300 RX Wireless Audio Headset
To: FCC 47 CFR Part 15.247 & IC RSS-210
Serial #: COMM39-U2 Rev A
Issue Date: 25th July 2013
Page: 26 of 145

20 dB Bandwidth Channel 39, 3-DH1, 3 Mbs/sec

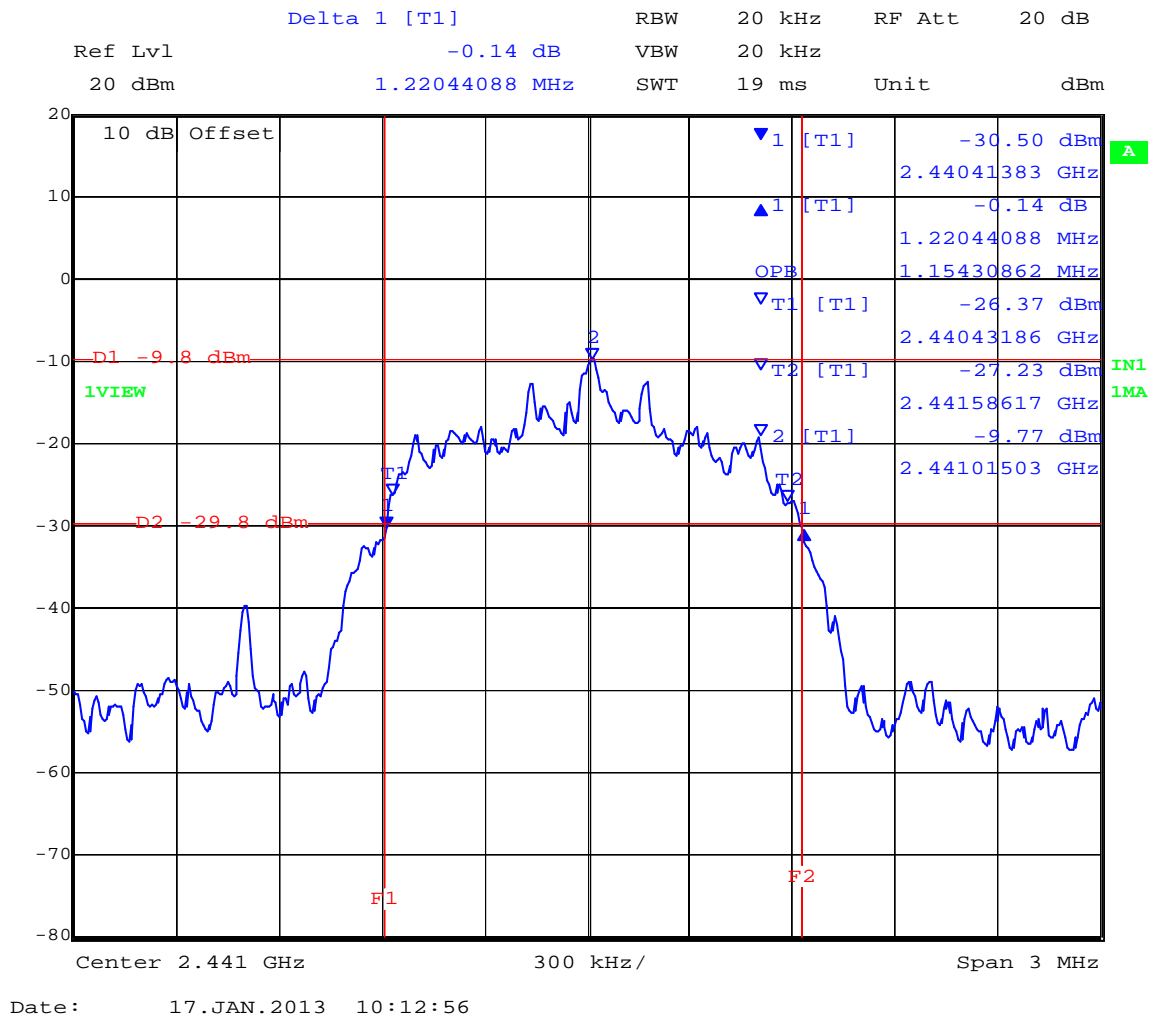

This test report may be reproduced in full only. The document may only be updated by MiCOM Labs personnel. Any changes will be noted in the Document History section of the report.



Title: Ear Force Z300 RX Wireless Audio Headset
To: FCC 47 CFR Part 15.247 & IC RSS-210
Serial #: COMM39-U2 Rev A
Issue Date: 25th July 2013
Page: 27 of 145

20 dB Bandwidth Channel 78, 3-DH1, 3 Mbs/sec

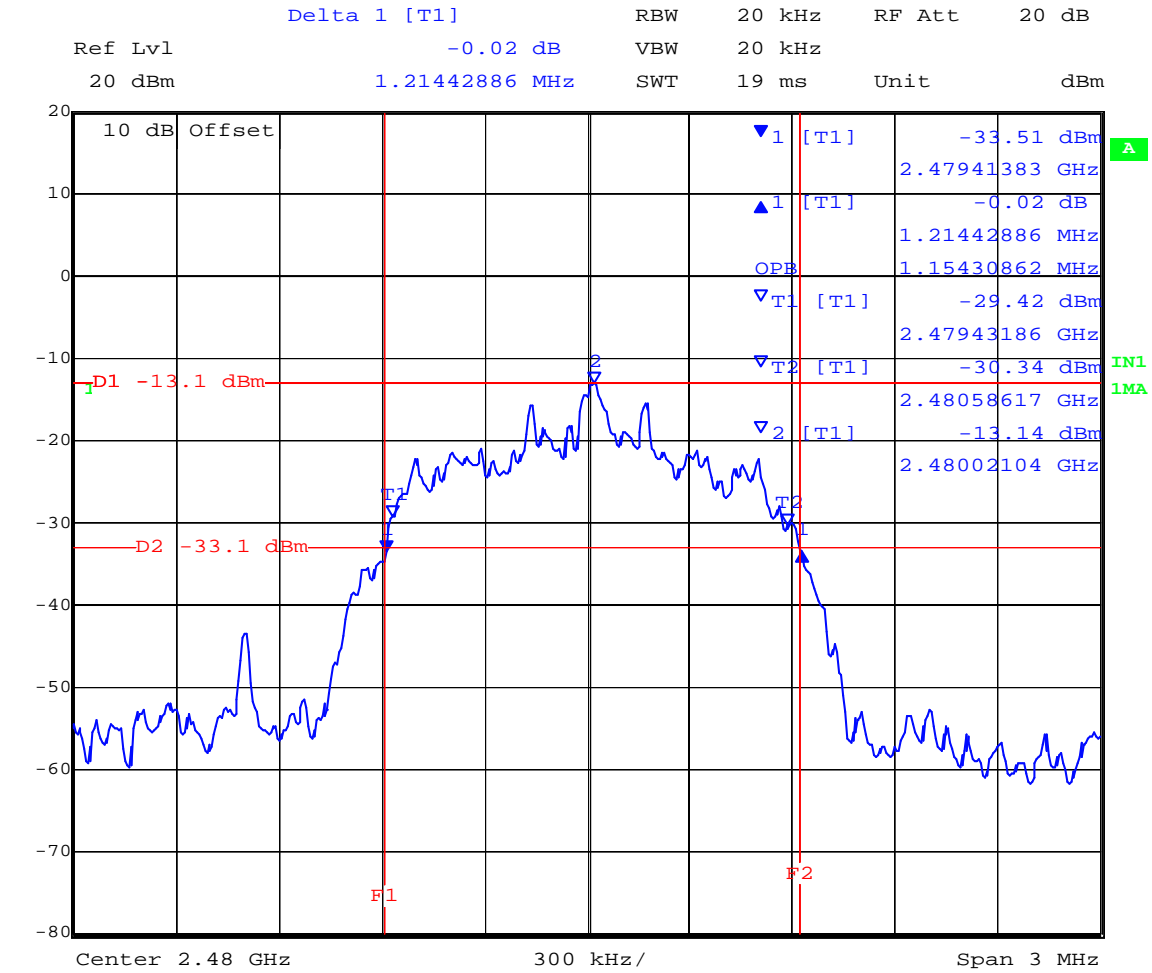

Date: 17.JAN.2013 10:21:43

This test report may be reproduced in full only. The document may only be updated by MiCOM Labs personnel. Any changes will be noted in the Document History section of the report.



Title: Ear Force Z300 RX Wireless Audio Headset
To: FCC 47 CFR Part 15.247 & IC RSS-210
Serial #: COMM39-U2 Rev A
Issue Date: 25th July 2013
Page: 28 of 145

3-DH3, 3 Mbs/sec

Equipment Configuration for 6 dB & 99% Bandwidth			
Variant:	802.15.2	Duty Cycle (%):	100%
Data Rate:	3 Mbit/s	Antenna Gain (dBi):	2.8
Modulation:	8DPSK,	Beam Forming Gain (Y):	Not Applicable
TPC:	N/A		
Engineering Test Notes:	3 Mbit/s (8DPSK) has the widest span, Widest Span for each packet type reported		

Test Measurement Results				
Packet Type	Measured 20 dB Bandwidth (MHz)			
	Port(s)			
MHz	a	b	c	d
2,402	1.190	--	--	--
2,441	1.190	--	--	--
2,480	1.190	--	--	--

Traceability to Industry Recognized Test Methodologies	
Work Instruction:	WI-03 MEASURING RF SPECTRUM MASK
Measurement Uncertainty:	±2.81 dB

This test report may be reproduced in full only. The document may only be updated by MiCOM Labs personnel. Any changes will be noted in the Document History section of the report.



Title: Ear Force Z300 RX Wireless Audio Headset
To: FCC 47 CFR Part 15.247 & IC RSS-210
Serial #: COMM39-U2 Rev A
Issue Date: 25th July 2013
Page: 29 of 145

20 dB Bandwidth Channel 0, 3-DH3, 3 Mbs/sec

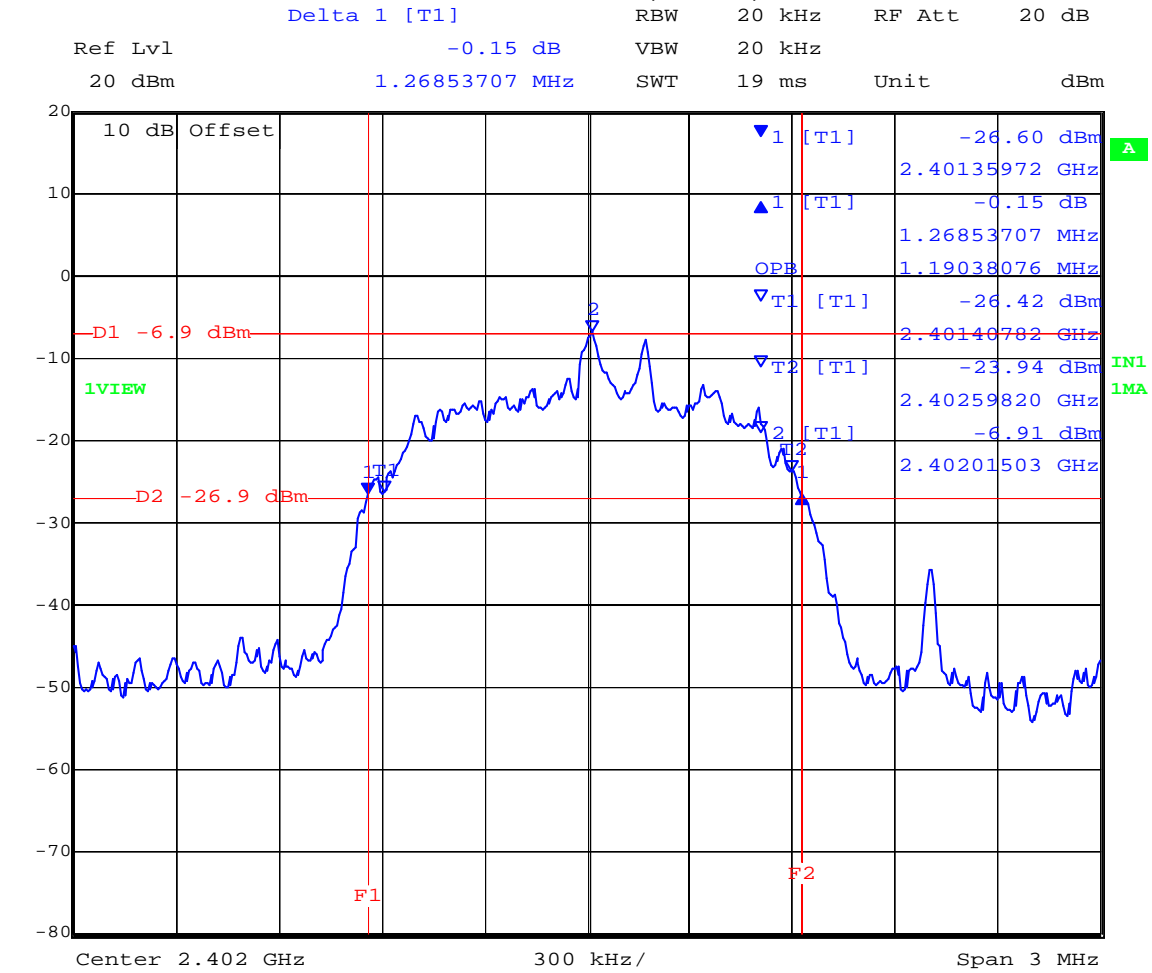

Date: 17.JAN.2013 10:38:29

This test report may be reproduced in full only. The document may only be updated by MiCOM Labs personnel. Any changes will be noted in the Document History section of the report.



Title: Ear Force Z300 RX Wireless Audio Headset
To: FCC 47 CFR Part 15.247 & IC RSS-210
Serial #: COMM39-U2 Rev A
Issue Date: 25th July 2013
Page: 30 of 145

20 dB Bandwidth Channel 39, 3-DH3, 3 Mbs/sec

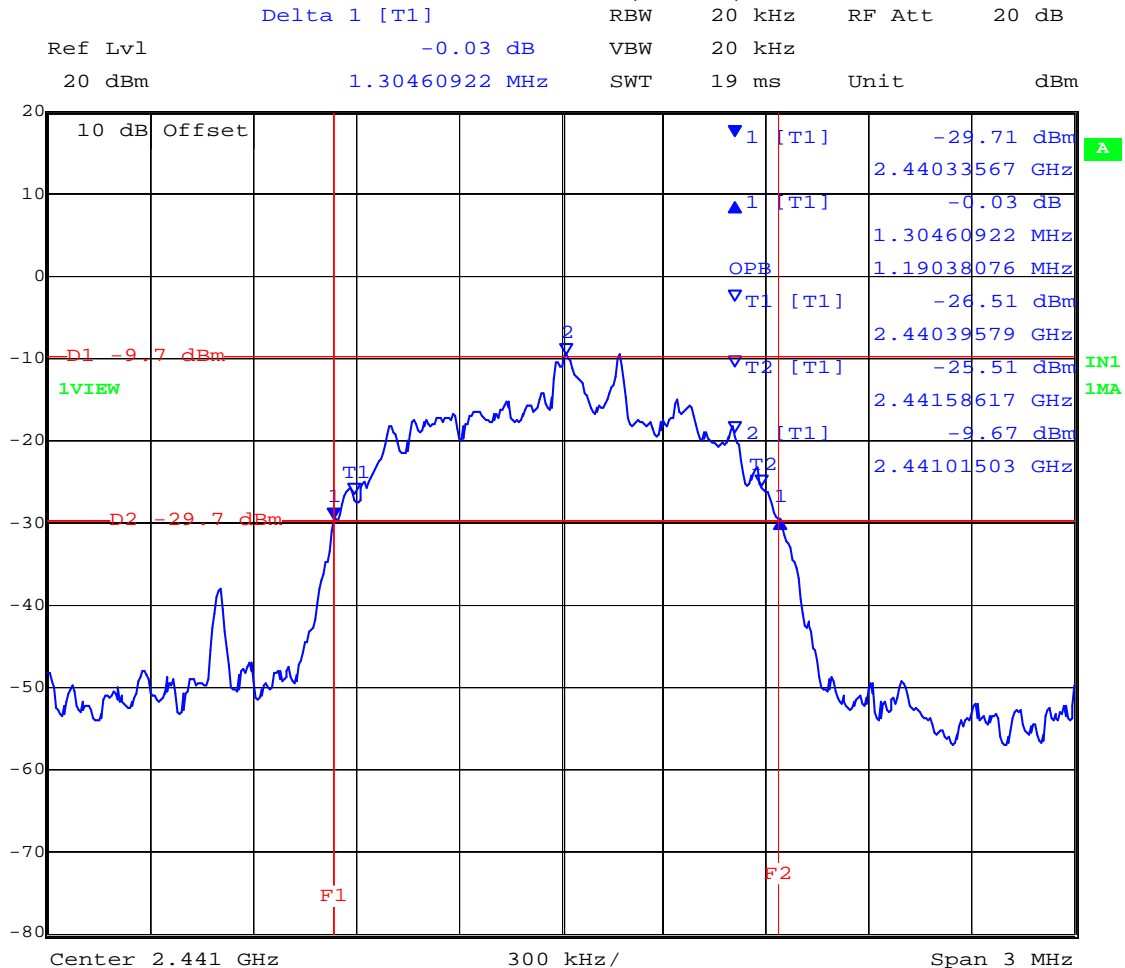

Date: 17.JAN.2013 10:33:40

This test report may be reproduced in full only. The document may only be updated by MiCOM Labs personnel. Any changes will be noted in the Document History section of the report.



20 dB Bandwidth Channel 78, 3-DH3, 3 Mbs/sec

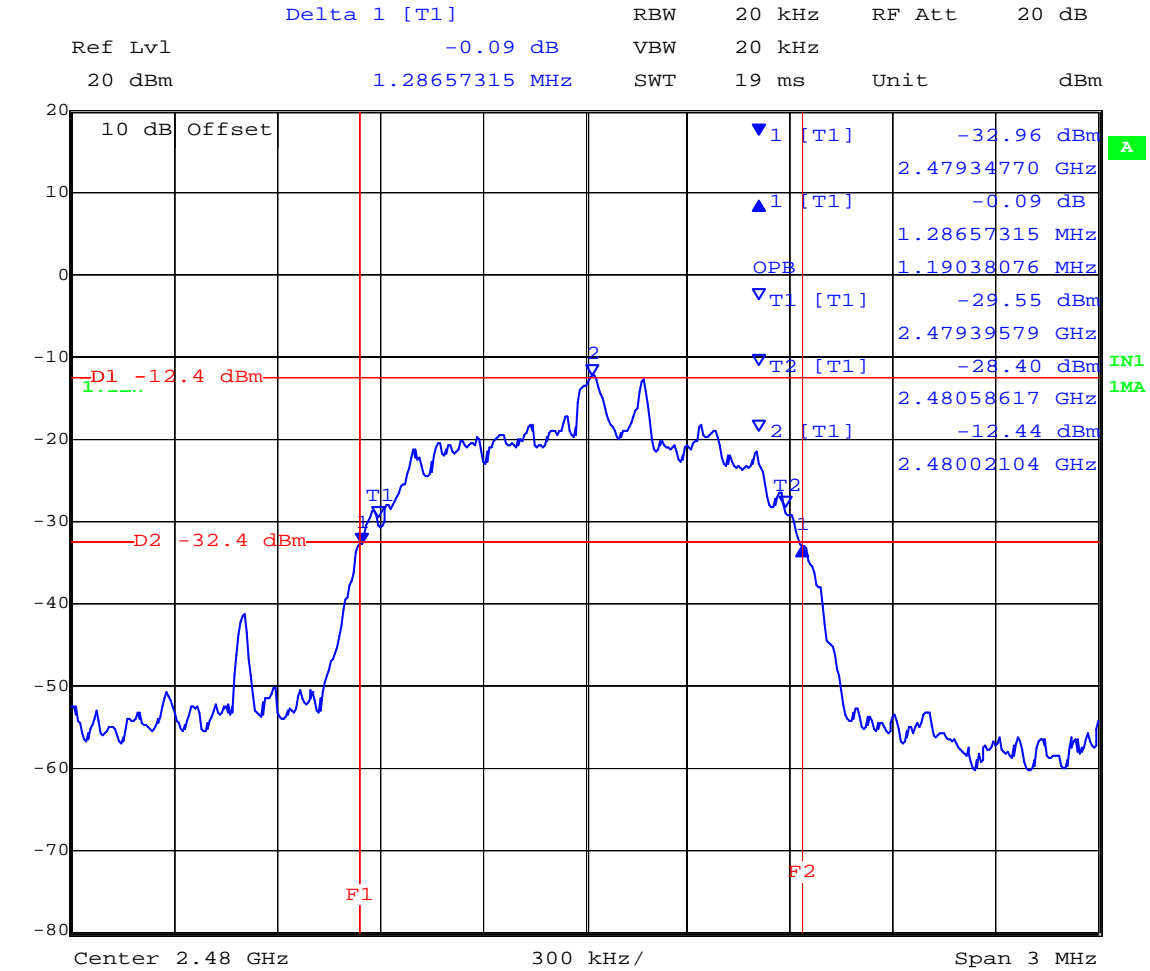

Date: 17.JAN.2013 10:28:46

This test report may be reproduced in full only. The document may only be updated by MiCOM Labs personnel. Any changes will be noted in the Document History section of the report.



Title: Ear Force Z300 RX Wireless Audio Headset
To: FCC 47 CFR Part 15.247 & IC RSS-210
Serial #: COMM39-U2 Rev A
Issue Date: 25th July 2013
Page: 32 of 145

3-DH5, 3 Mbs/sec

Equipment Configuration for 6 dB & 99% Bandwidth			
Variant:	802.15.2	Duty Cycle (%):	100%
Data Rate:	3 Mbit/s	Antenna Gain (dBi):	2.8
Modulation:	8DPSK,	Beam Forming Gain (Y):	Not Applicable
TPC:	N/A		
Engineering Test Notes:	3 Mbit/s (8DPSK) has the widest span, Widest Span for each packet type reported		

Test Measurement Results				
Packet Type	Measured 20 dB Bandwidth (MHz)			
	Port(s)			
MHz	a	b	c	d
2,402	1.184	--	--	--
2,441	1.280	--	--	--
2,480	1.208	--	--	--

Traceability to Industry Recognized Test Methodologies	
Work Instruction:	WI-03 MEASURING RF SPECTRUM MASK
Measurement Uncertainty:	±2.81 dB

This test report may be reproduced in full only. The document may only be updated by MiCOM Labs personnel. Any changes will be noted in the Document History section of the report.



Title: Ear Force Z300 RX Wireless Audio Headset
To: FCC 47 CFR Part 15.247 & IC RSS-210
Serial #: COMM39-U2 Rev A
Issue Date: 25th July 2013
Page: 33 of 145

20 dB Bandwidth Channel 0, 3-DH5, 3 Mbs/sec

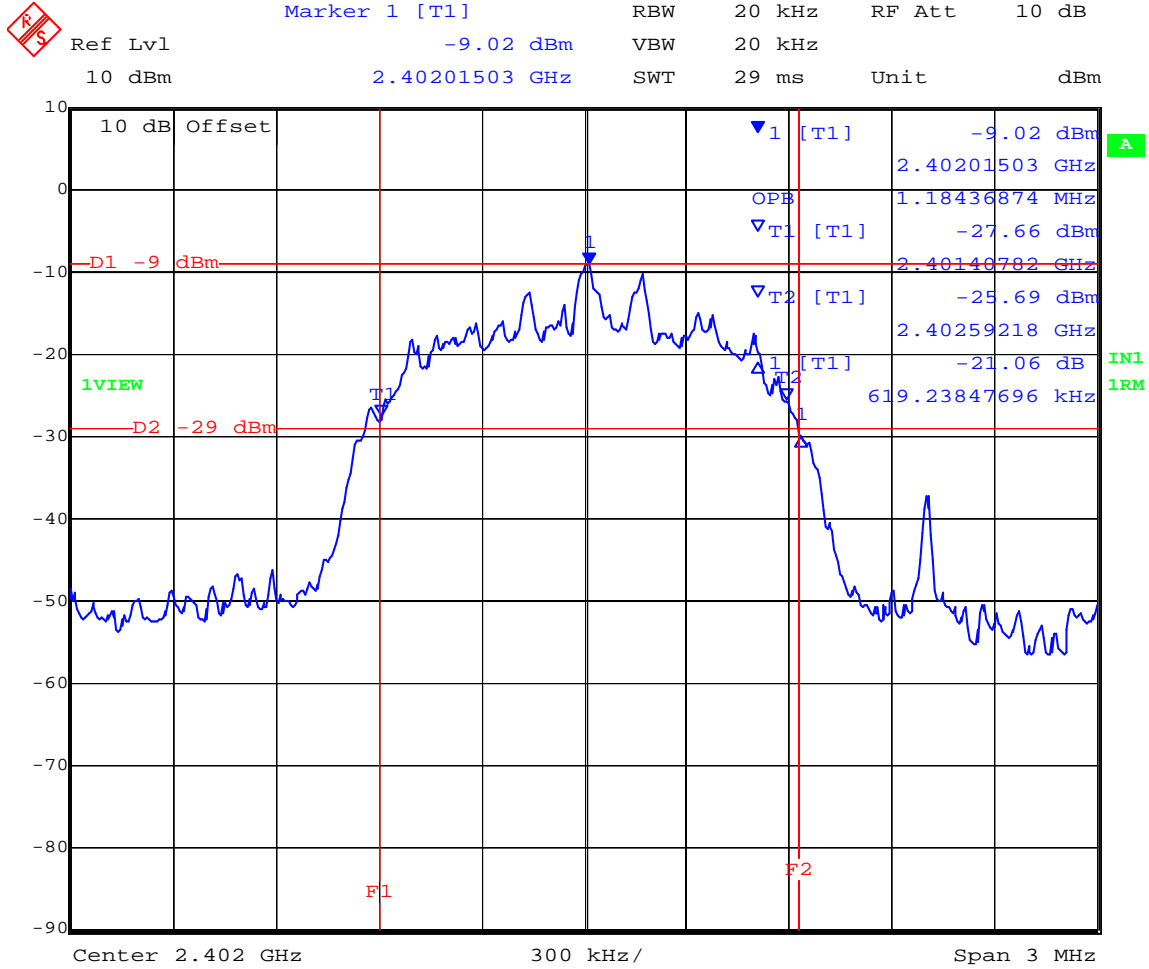

Date: 16.JAN.2013 16:58:14

This test report may be reproduced in full only. The document may only be updated by MiCOM Labs personnel. Any changes will be noted in the Document History section of the report.



Title: Ear Force Z300 RX Wireless Audio Headset
To: FCC 47 CFR Part 15.247 & IC RSS-210
Serial #: COMM39-U2 Rev A
Issue Date: 25th July 2013
Page: 34 of 145

20 dB Bandwidth Channel 39, 3-DH5, 3 Mbs/sec

 Ref Lvl 30 dBm
Marker 1 [T1] -29.44 dBm
RBW 20 kHz RF Att 40 dB
VBW 20 kHz
SWT 29 ms Unit dBm
2.44032966 GHz

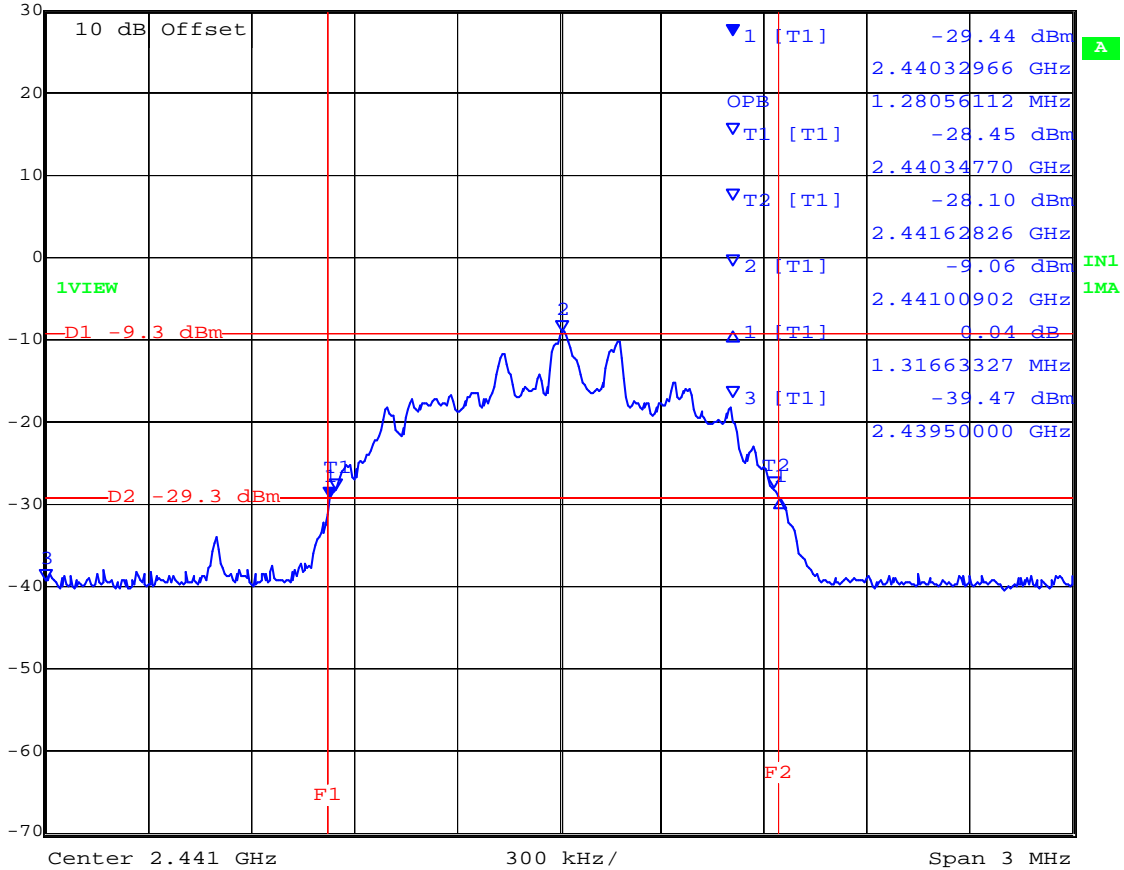

Date: 16.JAN.2013 19:28:58

This test report may be reproduced in full only. The document may only be updated by MiCOM Labs personnel. Any changes will be noted in the Document History section of the report.



Title: Ear Force Z300 RX Wireless Audio Headset
To: FCC 47 CFR Part 15.247 & IC RSS-210
Serial #: COMM39-U2 Rev A
Issue Date: 25th July 2013
Page: 35 of 145

20 dB Bandwidth Channel 78, 3-DH5, 3 Mbs/sec



Marker 1 [T1] RBW 20 kHz RF Att 40 dB
 Ref Lvl -33.05 dBm VBW 20 kHz
 30 dBm 2.47933567 GHz SWT 29 ms Unit dBm

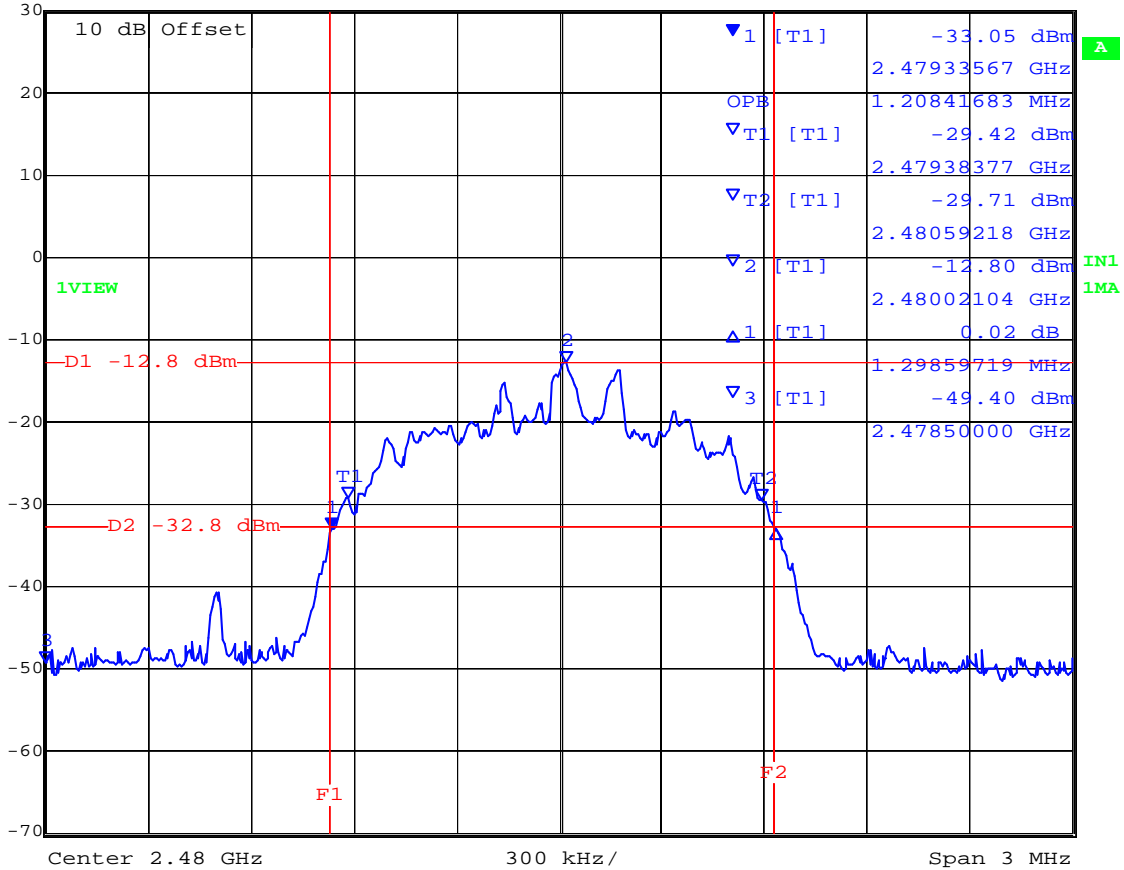

Date: 16.JAN.2013 19:33:00

This test report may be reproduced in full only. The document may only be updated by MiCOM Labs personnel. Any changes will be noted in the Document History section of the report.



Title: Ear Force Z300 RX Wireless Audio Headset
To: FCC 47 CFR Part 15.247 & IC RSS-210
Serial #: COMM39-U2 Rev A
Issue Date: 25th July 2013
Page: 36 of 145

Specification

Limits

§15.247 (a)

(1) Frequency hopping systems shall have hopping channel carrier frequencies separated by a minimum of 25 kHz or the 20 dB bandwidth of the hopping channel, whichever is greater. Alternatively, frequency hopping systems operating in the 2400-2483.5 MHz band may have hopping channel carrier frequencies that are separated by 25 kHz or two-thirds of the 20 dB bandwidth of the hopping channel, whichever is greater, provided the systems operate with an output power no greater than 125 mW. The system shall hop to channel frequencies that are selected at the system hopping rate from a pseudo randomly ordered list of hopping frequencies. Each frequency must be used equally on the average by each transmitter. The system receivers shall have input bandwidths that match the hopping channel bandwidths of their corresponding transmitters and shall shift frequencies in synchronization with the transmitted signals

RSS-210 §A8.1

a. The bandwidth of a frequency hopping channel is the -20 dB emission bandwidth, measured with the hopping stopped. The system radio frequency (RF) bandwidth is equal to the channel bandwidth multiplied by the number of channels in the hopset. The hopset shall be such that the near-term distribution of frequencies appears random, with sequential hops randomly distributed in both direction and magnitude of change in the hopset, while the long-term distribution appears evenly distributed.

b. Frequency hopping systems shall have hopping channel carrier frequencies separated by a minimum of 25 kHz or the -20 dB bandwidth of the hopping channel, whichever is greater. Alternatively, frequency hopping systems operating in the band 2400–2483.5 MHz may have hopping channel carrier frequencies that are separated by 25 kHz or two-thirds of the -20 dB bandwidth of the hopping channel, whichever is greater, provided that the systems operate with an output power no greater than 0.125 W. The system receivers shall have input bandwidths that match the hopping channel bandwidths of their corresponding transmitters and shall shift frequencies in synchronization with the transmitted signals.

Traceability

Test Equipment Used

0158, 0287, 0252, 0313, 0314, 0070, 0116, 0117

This test report may be reproduced in full only. The document may only be updated by MiCOM Labs personnel. Any changes will be noted in the Document History section of the report.



Title: Ear Force Z300 RX Wireless Audio Headset
To: FCC 47 CFR Part 15.247 & IC RSS-210
Serial #: COMM39-U2 Rev A
Issue Date: 25th July 2013
Page: 37 of 145

6.1.1.2. Carrier Frequency Separation

Conducted Test Conditions for Carrier Frequency Separation			
Standard:	FCC CFR 47:15.247	Ambient Temp. (°C):	18.0 – 24.0
Test Heading:	Carrier Frequency Separation	Rel. Humidity (%):	32 - 45
Standard Section(s):	15.247 (a)(1)	Pressure (mBars):	999 - 1004
Reference Document(s):	FCC DA 00-705 "Filing and Measurement Guidelines for Frequency Hopping Spread Spectrum Systems"		
Test Procedure for Carrier Frequency Separation Measurement The EUT must have its hopping function enabled. The transmitter terminal of EUT was connected to the input of the spectrum analyzer set to measure carrier frequency separation. The Span was set wide enough to capture two adjacent peaks. The resolution bandwidth (RBW) was set to $\geq 1\%$ of the span, video bandwidth (VBW) \geq RBW, peak detector selected and max hold trace selected. After the trace is stabilized use marker delta function to determine the separation between adjacent channels. The limit is $> 2/3$ of the 20 dB bandwidth.			

This test report may be reproduced in full only. The document may only be updated by MiCOM Labs personnel. Any changes will be noted in the Document History section of the report.



Title: Ear Force Z300 RX Wireless Audio Headset
To: FCC 47 CFR Part 15.247 & IC RSS-210
Serial #: COMM39-U2 Rev A
Issue Date: 25th July 2013
Page: 38 of 145

Equipment Configuration for Carrier Frequency Separation
--

Variant:	802.15.2	Duty Cycle (%):	100%
Data Rate:	1-3 Mbit/s	Antenna Gain (dBi):	2.8
Modulation:	GFSK, $\pi/4$ DQPSK, 8DPSK	Beam Forming Gain (Y):	Not Applicable
TPC:	N/A		
Engineering Test Notes:	all 3 supported modes were measured		

Test Measurement Results

Test Frequency	Measured Carrier Frequency Separation (MHz)				Maximum 20 dB Bandwidth	Specification	Results
	Port(s)						
MHz	a	b	c	d	MHz		
DH1 (CH 39)	1.016	--	--	--	1.220	> 2/3 of 20 dB Bandwidth	Pass
DH3 (CH 39)	1.040	--	--	--	1.304	> 2/3 of 20 dB Bandwidth	Pass
DH5 (CH 39)	1.006	--	--	--	1.317	> 2/3 of 20 dB Bandwidth	Pass

Traceability to Industry Recognized Test Methodologies
--

Work Instruction:	WI-03 MEASURING RF SPECTRUM MASK
Measurement Uncertainty:	± 2.81 dB

The EUT was tested at 1 Mbits/s, 2 Mbits/s, and 3 Mbits/s data rates for each packet type DH1, DH3 and DH5.

This test report may be reproduced in full only. The document may only be updated by MiCOM Labs personnel. Any changes will be noted in the Document History section of the report.



Channel Separation DH1, 1 Mbs/sec

 **Delta 1 [T1]** RBW 20 kHz RF Att 10 dB
Ref Lvl 0.43 dB VBW 20 kHz
10 dBm 1.01603206 MHz SWT 29 ms Unit dBm

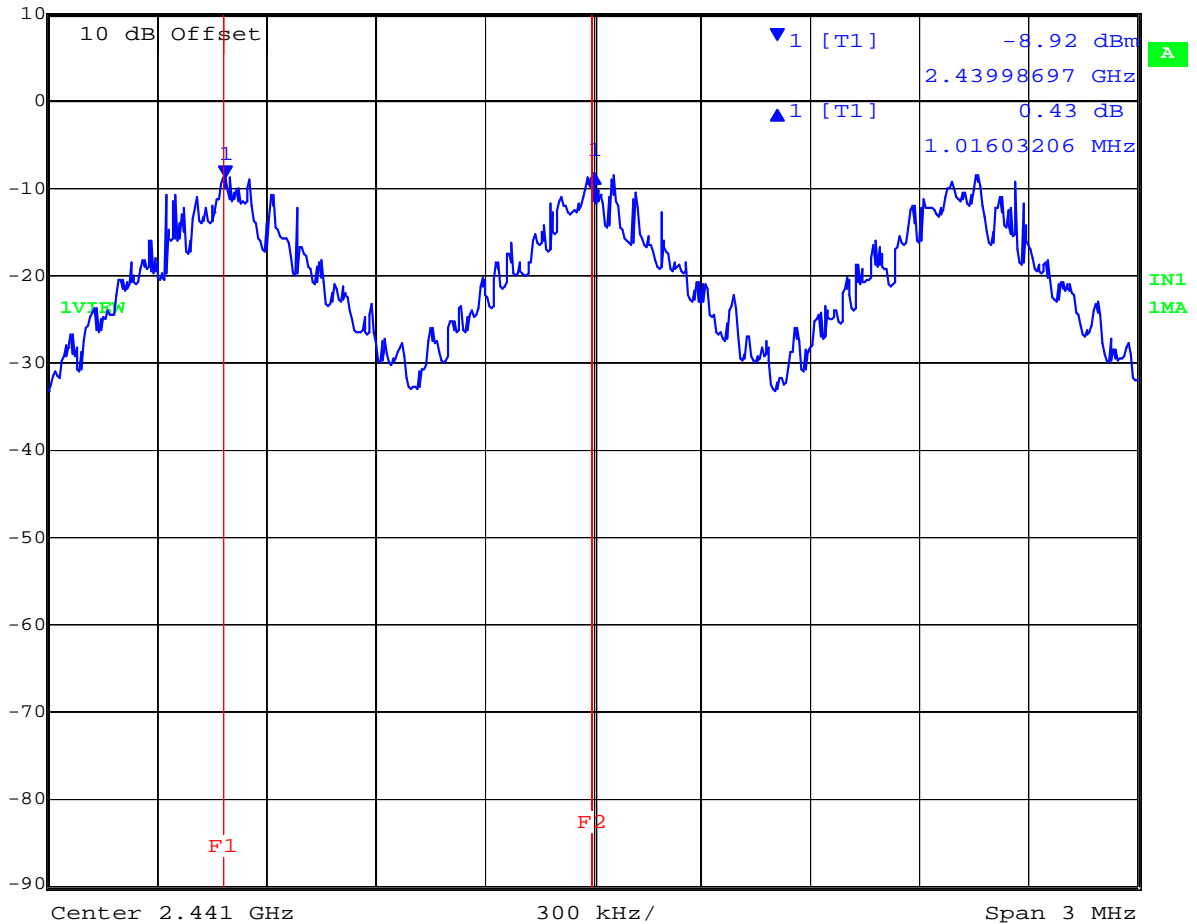

Date: 16.JAN.2013 17:15:14

This test report may be reproduced in full only. The document may only be updated by MiCOM Labs personnel. Any changes will be noted in the Document History section of the report.



Channel Separation DH3, 2 Mbs/sec

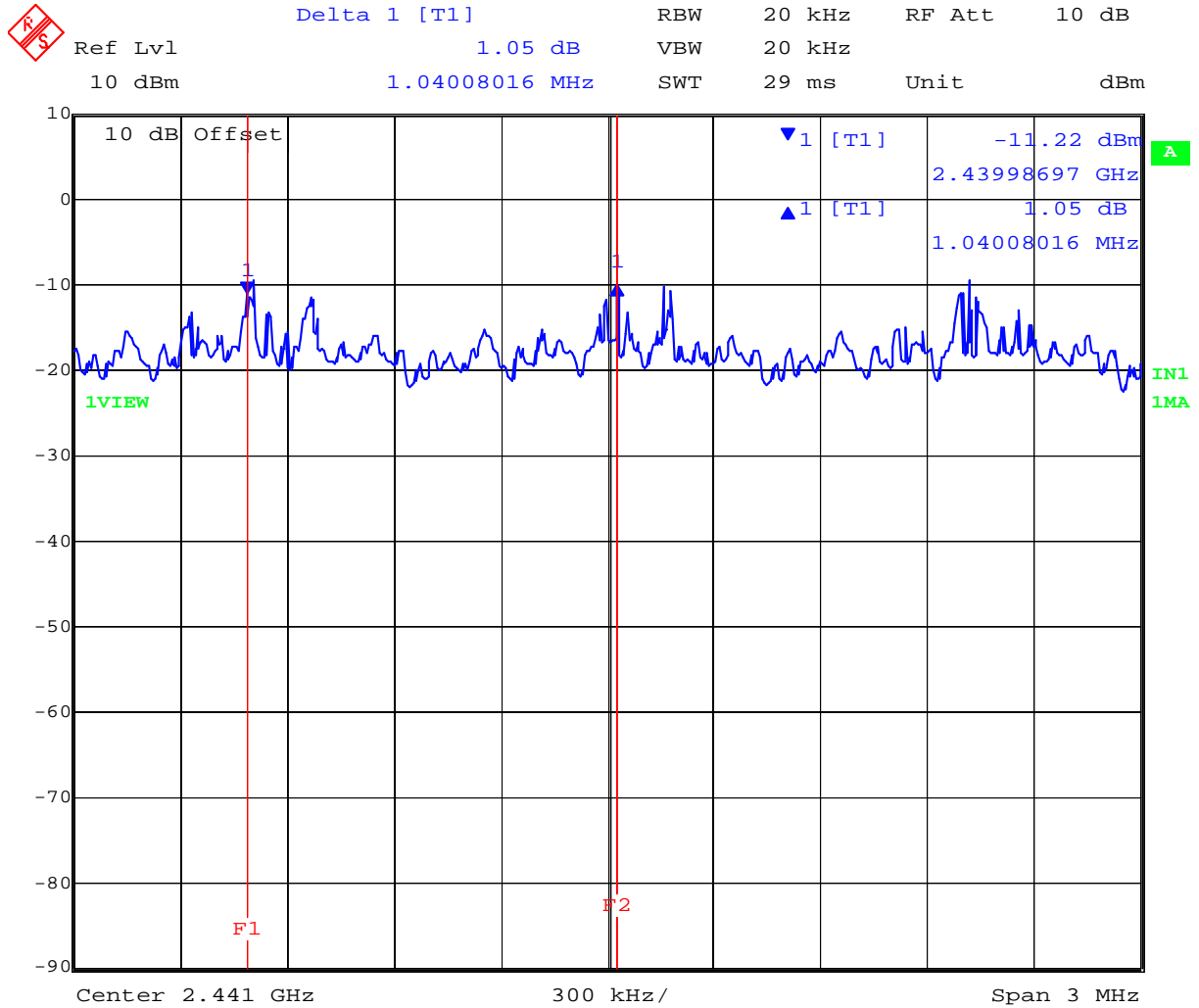

Date: 16.JAN.2013 17:22:55

This test report may be reproduced in full only. The document may only be updated by MiCOM Labs personnel. Any changes will be noted in the Document History section of the report.



Title: Ear Force Z300 RX Wireless Audio Headset
To: FCC 47 CFR Part 15.247 & IC RSS-210
Serial #: COMM39-U2 Rev A
Issue Date: 25th July 2013
Page: 41 of 145

Channel Separation DH5, 3 Mbs/sec

 **Delta 1 [T1]** RBW 30 kHz RF Att 10 dB
Ref Lvl -0.21 dB VBW 30 kHz
10 dBm 1.00651303 MHz SWT 29 ms Unit dBm

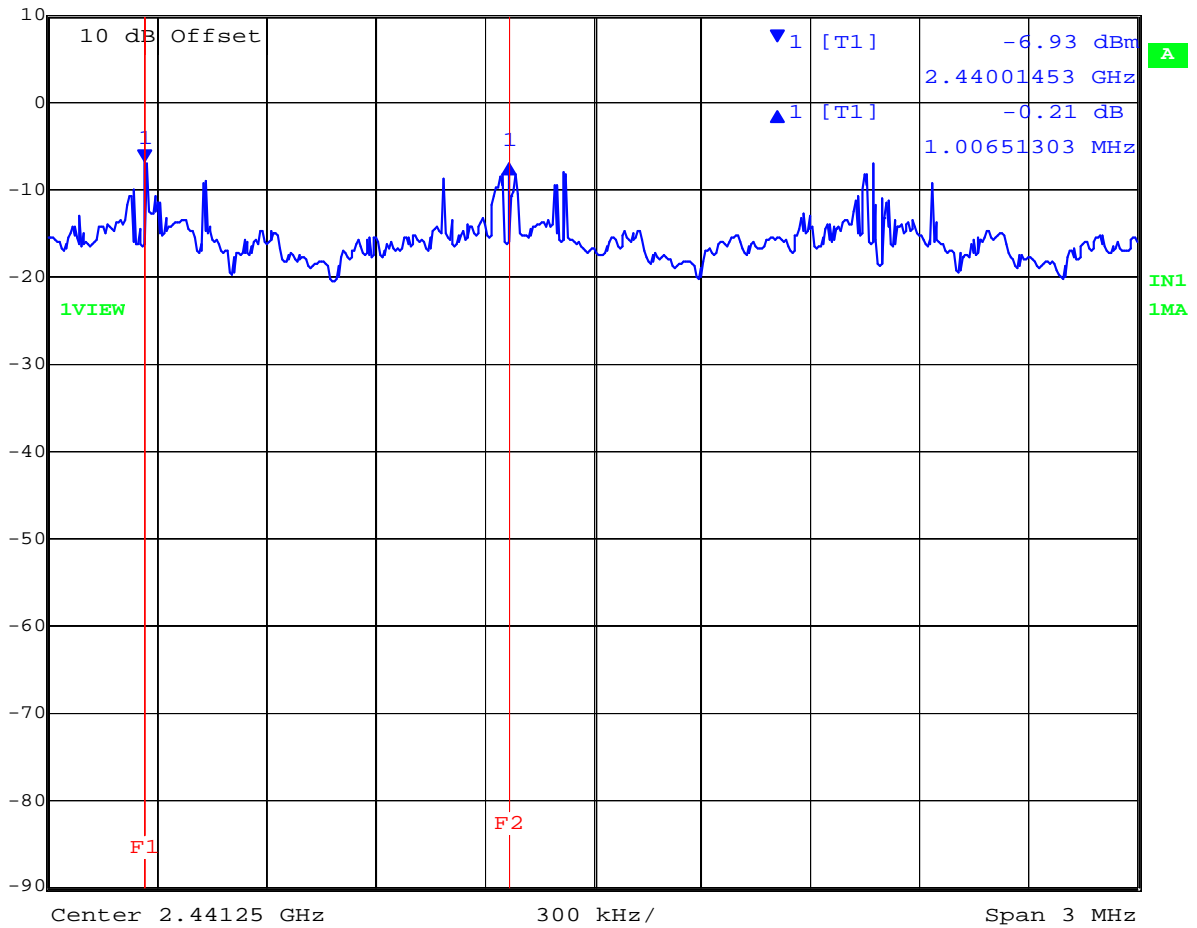

Date: 16.JAN.2013 17:35:36

This test report may be reproduced in full only. The document may only be updated by MiCOM Labs personnel. Any changes will be noted in the Document History section of the report.



Title: Ear Force Z300 RX Wireless Audio Headset
To: FCC 47 CFR Part 15.247 & IC RSS-210
Serial #: COMM39-U2 Rev A
Issue Date: 25th July 2013
Page: 42 of 145

Specification

Limits

§15.247 (a) Operation under the provisions of this Section is limited to frequency hopping and digitally modulated intentional radiators that comply with the following provisions:

(1) Frequency hopping systems shall have hopping channel carrier frequencies separated by a minimum of 25 kHz or the 20 dB bandwidth of the hopping channel, whichever is greater. Alternatively, frequency hopping systems operating in the 2400–2483.5 MHz band may have hopping channel carrier frequencies that are separated by 25 kHz or two-thirds of the 20 dB bandwidth of the hopping channel, whichever is greater, provided the systems operate with an output power no greater than 125 mW. The system shall hop to channel frequencies that are selected at the system hopping rate from a pseudo randomly ordered list of hopping frequencies. Each frequency must be used equally on the average by each transmitter. The system receivers shall have input bandwidths that match the hopping channel bandwidths of their corresponding transmitters and shall shift frequencies in synchronization with the transmitted signals.

RSS-210 §A8.1

b. Frequency hopping systems shall have hopping channel carrier frequencies separated by a minimum of 25 kHz or the -20 dB bandwidth of the hopping channel, whichever is greater. Alternatively, frequency hopping systems operating in the band 2400–2483.5 MHz may have hopping channel carrier frequencies that are separated by 25 kHz or two-thirds of the -20 dB bandwidth of the hopping channel, whichever is greater, provided that the systems operate with an output power no greater than 0.125 W. The system receivers shall have input bandwidths that match the hopping channel bandwidths of their corresponding transmitters and shall shift frequencies in synchronization with the transmitted signals.

Traceability

Test Equipment Used

0158, 0287, 0252, 0313, 0314, 0070, 0116, 0117

This test report may be reproduced in full only. The document may only be updated by MiCOM Labs personnel. Any changes will be noted in the Document History section of the report.



Title: Ear Force Z300 RX Wireless Audio Headset
To: FCC 47 CFR Part 15.247 & IC RSS-210
Serial #: COMM39-U2 Rev A
Issue Date: 25th July 2013
Page: 43 of 145

6.1.1.3. Number of Hopping Frequencies

Conducted Test Conditions for Number of Hopping Frequencies			
Standard:	FCC CFR 47:15.247	Ambient Temp. (°C):	18.0 - 27.5
Test Heading:	Carrier Hopping Frequencies	Rel. Humidity (%):	32 - 45
Standard Section(s):	15.247 (a)	Pressure (mBars):	999 - 1008
Reference Document(s):	FCC DA 00-705 "Filing and Measurement Guidelines for Frequency Hopping Spread Spectrum Systems"		
Test Procedure for Number of Hopping Frequencies The EUT must have its hopping function Enabled The transmitter output was connected to a spectrum analyzer and the span was set for the frequency of operation (Note 2 or more spans may be necessary for an accurate count). RBW ≥ 1% of the span, VBW ≥ RBW, Sweep = auto, detector function = peak, trace = max hold. Allow trace to stabilize. It may prove necessary to break the span up into sections to clearly show the hopping frequencies.			

This test report may be reproduced in full only. The document may only be updated by MiCOM Labs personnel. Any changes will be noted in the Document History section of the report.



Title: Ear Force Z300 RX Wireless Audio Headset
To: FCC 47 CFR Part 15.247 & IC RSS-210
Serial #: COMM39-U2 Rev A
Issue Date: 25th July 2013
Page: 44 of 145

Equipment Configuration for Number of Hopping Frequencies

Variant:	802.15.2	Duty Cycle (%):	100%
Data Rate:	1-3 Mbit/s	Antenna Gain (dBi):	2.8
Modulation:	GFSK, $\pi/4$ DQPSK, 8DPSK	Beam Forming Gain (Y):	Not Applicable
TPC:	N/A		
Engineering Test Notes:			

Test Measurement Results

Test Frequency	Number of Hopping Frequencies				Limit	Result
	Port(s)					
MHz	a	b	c	d	dBm	dB
NA	79	--	--	--	≥ 15	Pass

Traceability to Industry Recognized Test Methodologies

Work Instruction:	WI-03 MEASURING RF SPECTRUM MASK
Measurement Uncertainty:	± 2.81 dB

This test report may be reproduced in full only. The document may only be updated by MiCOM Labs personnel. Any changes will be noted in the Document History section of the report.



Title: Ear Force Z300 RX Wireless Audio Headset
To: FCC 47 CFR Part 15.247 & IC RSS-210
Serial #: COMM39-U2 Rev A
Issue Date: 25th July 2013
Page: 45 of 145

Number of Hopping Channels 2400 – 2441

 **UNCAL** Marker 2 [T1] RBW 30 kHz RF Att 50 dB
Ref Lvl -8.58 dBm VBW 30 kHz
30 dBm 2.44100000 GHz SWT 29 ms Unit dBm

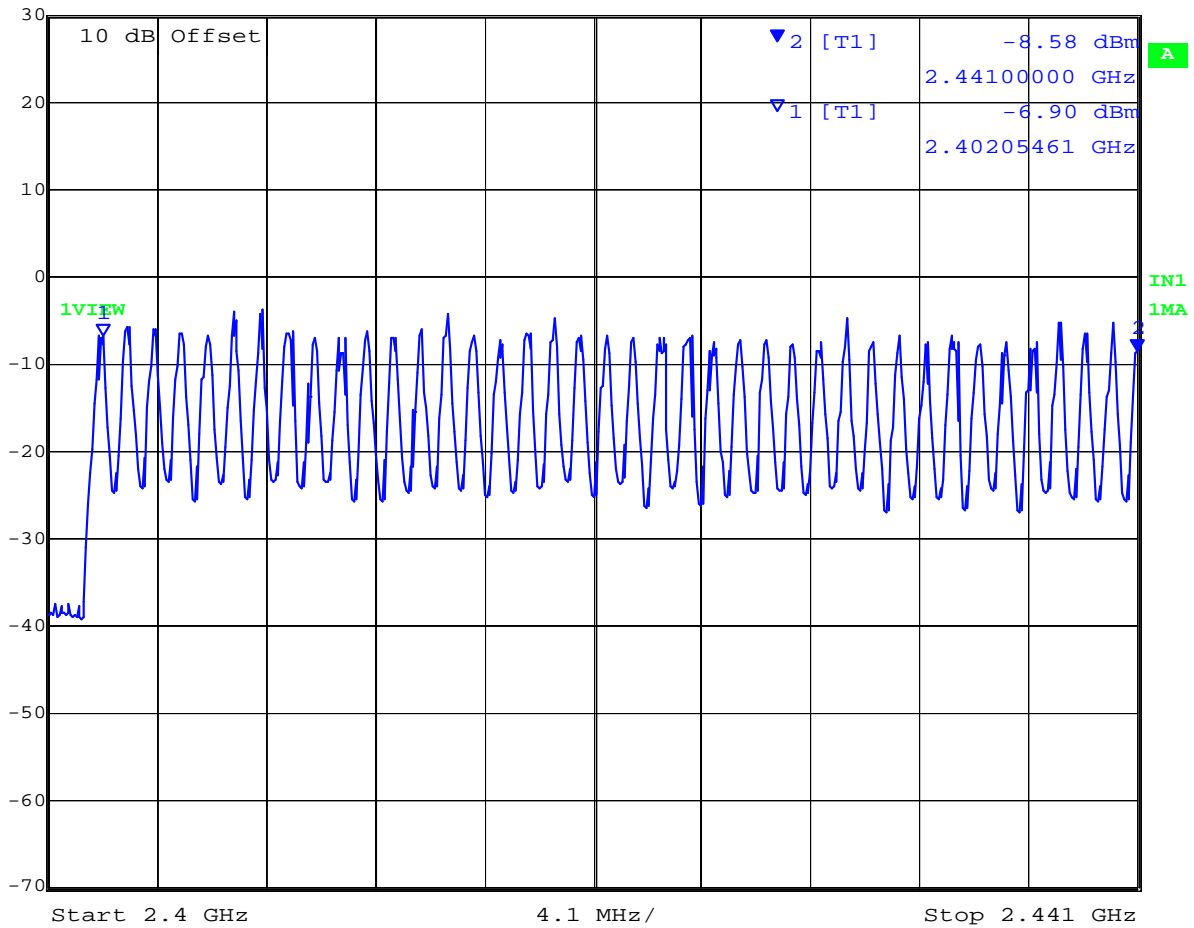

Date: 16.JAN.2013 17:41:29

This test report may be reproduced in full only. The document may only be updated by MiCOM Labs personnel. Any changes will be noted in the Document History section of the report.



Title: Ear Force Z300 RX Wireless Audio Headset
To: FCC 47 CFR Part 15.247 & IC RSS-210
Serial #: COMM39-U2 Rev A
Issue Date: 25th July 2013
Page: 46 of 145

Number of Hopping Channels 2441 – 2483.5

 **Marker 1 [T1]** RBW 100 kHz RF Att 50 dB
Ref Lvl -5.87 dBm VBW 100 kHz
30 dBm 2.44100000 GHz SWT 29 ms Unit dBm

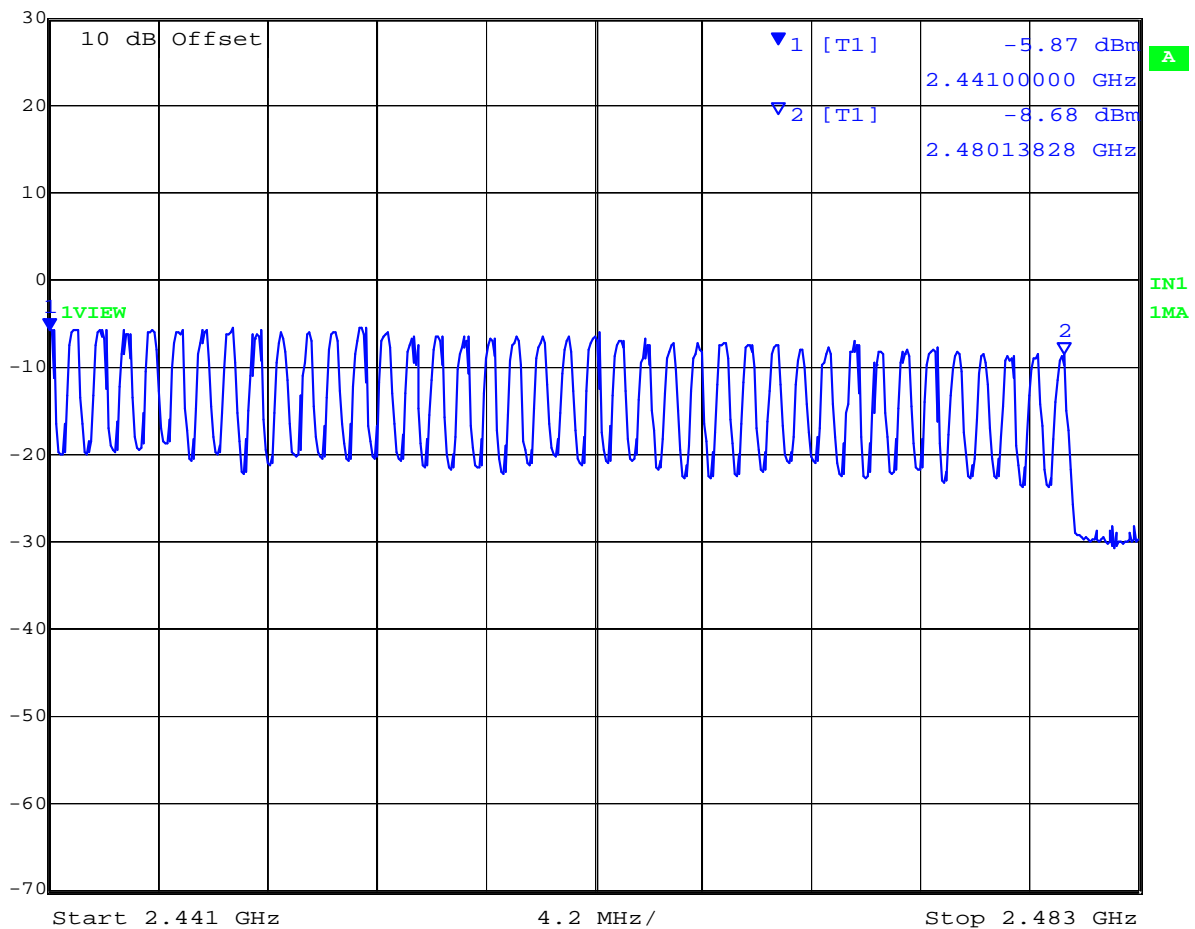

Date: 16.JAN.2013 17:51:37

This test report may be reproduced in full only. The document may only be updated by MiCOM Labs personnel. Any changes will be noted in the Document History section of the report.



Title: Ear Force Z300 RX Wireless Audio Headset
To: FCC 47 CFR Part 15.247 & IC RSS-210
Serial #: COMM39-U2 Rev A
Issue Date: 25th July 2013
Page: 47 of 145

Specification
Number of Hopping Frequencies

§15.247(a)(1)(iii) Frequency hopping systems in the 2400–2483.5 MHz band shall use at least 15 channels. The average time of occupancy on any channel shall not be greater than 0.4 seconds within a period of 0.4 seconds multiplied by the number of hopping channels employed. Frequency hopping systems may avoid or suppress transmissions on a particular hopping frequency provided that a minimum of 15 channels are used.

RSS-210 §A8.1 (d) Frequency hopping systems operating in the 2400–2483.5 MHz band shall use at least 15 hopping channels. The average time of occupancy on any channel shall not be greater than 0.4 seconds within a period of 0.4 seconds, multiplied by the number of hopping channels employed. Transmissions on particular frequencies may be avoided or suppressed provided that a minimum of 15 hopping channels are used.

Traceability

Method	Test Equipment Used
FCC DA 00-175	0078, 0134, 0158, 0184, 0193, 0287, 0250, 0252, 0310, 0312

This test report may be reproduced in full only. The document may only be updated by MiCOM Labs personnel. Any changes will be noted in the Document History section of the report.



Title: Ear Force Z300 RX Wireless Audio Headset
To: FCC 47 CFR Part 15.247 & IC RSS-210
Serial #: COMM39-U2 Rev A
Issue Date: 25th July 2013
Page: 48 of 145

6.1.1.4. Time of Occupancy (Dwell Time)

Conducted Test Conditions for Time of Occupancy (Dwell Time)			
Standard:	FCC CFR 47:15.247	Ambient Temp. (°C):	24.0 - 27.5
Test Heading:	Time of Occupancy (Dwell Time)	Rel. Humidity (%):	32 - 45
Standard Section(s):	15.247 (a)	Pressure (mBars):	999 - 1001
Reference Document(s):	FCC DA 00-705 "Filing and Measurement Guidelines for Frequency Hopping Spread Spectrum Systems"		
Test Procedure for Time of Occupancy (Dwell Time) The EUT must have its hopping function Enabled The transmitter output was connected to a spectrum analyzer and the span was set for the frequency of operation. RBW = 1 MHz, VBW ≥ RBW, Sweep = as necessary to capture the entire dwell time period, detector function = peak, trace = max hold. If possible use the marker-delta function to determine the dwell time. If this value varies with different modes of operation (e.g., data rate, modulation format, etc.), repeat this test for each variation.			

This test report may be reproduced in full only. The document may only be updated by MiCOM Labs personnel. Any changes will be noted in the Document History section of the report.



Title: Ear Force Z300 RX Wireless Audio Headset
To: FCC 47 CFR Part 15.247 & IC RSS-210
Serial #: COMM39-U2 Rev A
Issue Date: 25th July 2013
Page: 49 of 145

Equipment Configuration for Time of Occupancy (Dwell Time)

Variant:	802.15.2	Duty Cycle (%):	100%
Data Rate:	1-3 Mbit/s	Antenna Gain (dBi):	2.8
Modulation:	GFSK, $\pi/4$ DQPSK, 8DPSK	Beam Forming Gain (Y):	Not Applicable
TPC:	N/A		
Engineering Test Notes:			

Test Measurement Results

Centered on Channel	Center Frequency	Data Rate	Packet Type	Dwell Time (Single Channel)	Limit (Single Channel)	Result
	MHz	Mbs		mS	mS	
0	2402	1	DH1	0.397	400	Pass
0	2402	1	DH3	0.397	400	Pass
0	2402	1	DH5	2.862	400	Pass
0	2402	2	DH1	1.653	400	Pass
0	2402	2	DH3	1.653	400	Pass
0	2402	2	DH5	2.886	400	Pass
0	2402	3	DH1	1.653	400	Pass
0	2402	3	DH3	1.653	400	Pass
0	2402	3	DH5	2.862	400	Pass

Traceability to Industry Recognized Test Methodologies

Work Instruction:	FCC DA 00-0705
Measurement Uncertainty:	± 2.81 dB (Spectrum/Amplitude), ± 0.86 ppm (Frequency)

This test report may be reproduced in full only. The document may only be updated by MiCOM Labs personnel. Any changes will be noted in the Document History section of the report.



Title: Ear Force Z300 RX Wireless Audio Headset
To: FCC 47 CFR Part 15.247 & IC RSS-210
Serial #: COMM39-U2 Rev A
Issue Date: 25th July 2013
Page: 50 of 145

Time of Occupancy; Hopping On; 2402; 1 Mbs Data Rate; Packet Type DH1; Dwell Time 0.397 ms

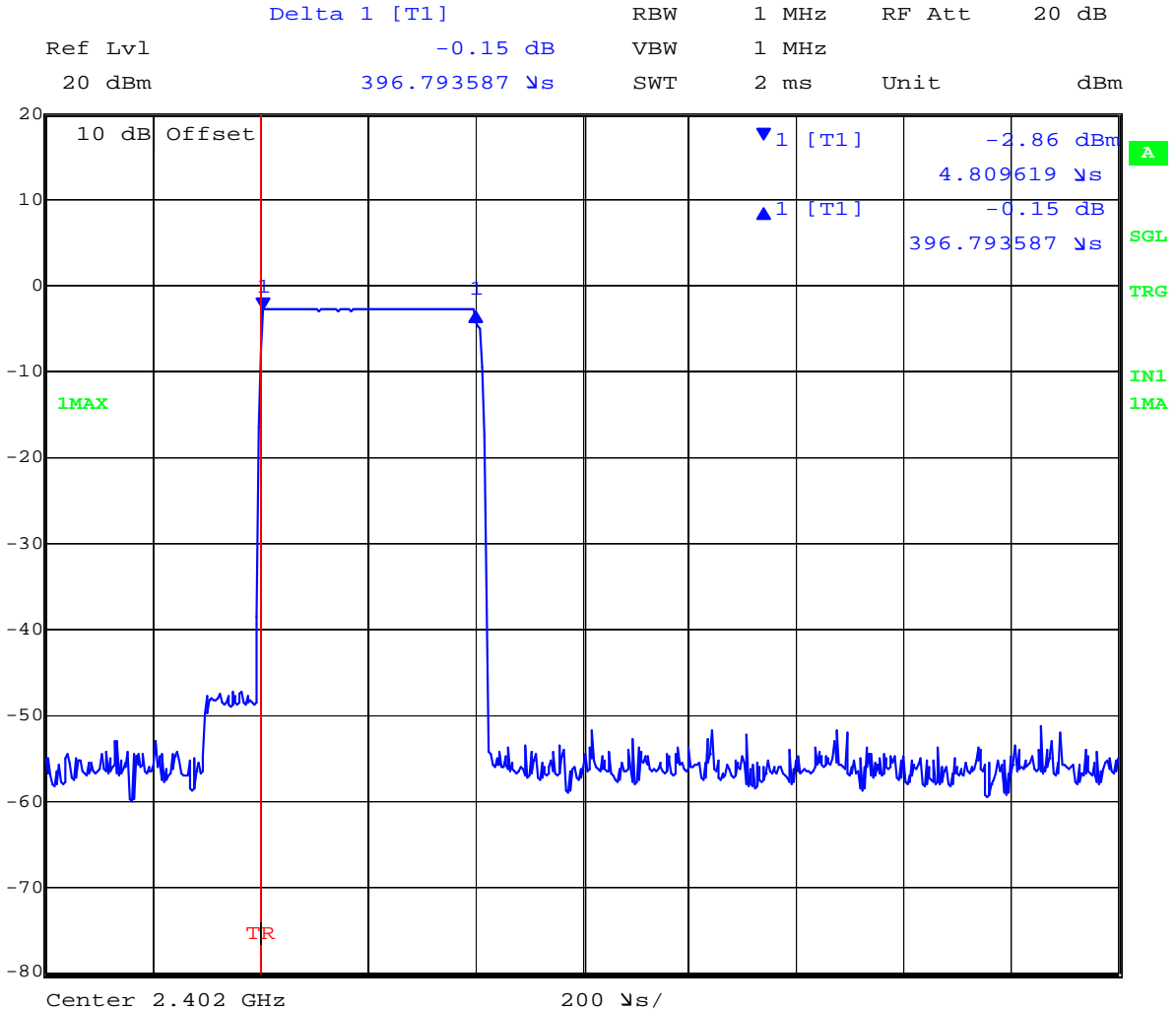

Date: 17.JAN.2013 11:01:20

This test report may be reproduced in full only. The document may only be updated by MiCOM Labs personnel. Any changes will be noted in the Document History section of the report.



Title: Ear Force Z300 RX Wireless Audio Headset
To: FCC 47 CFR Part 15.247 & IC RSS-210
Serial #: COMM39-U2 Rev A
Issue Date: 25th July 2013
Page: 51 of 145

Time of Occupancy; Hopping On; 2402; 1 Mbs Data Rate; Packet Type DH3; Dwell Time 0.397 ms

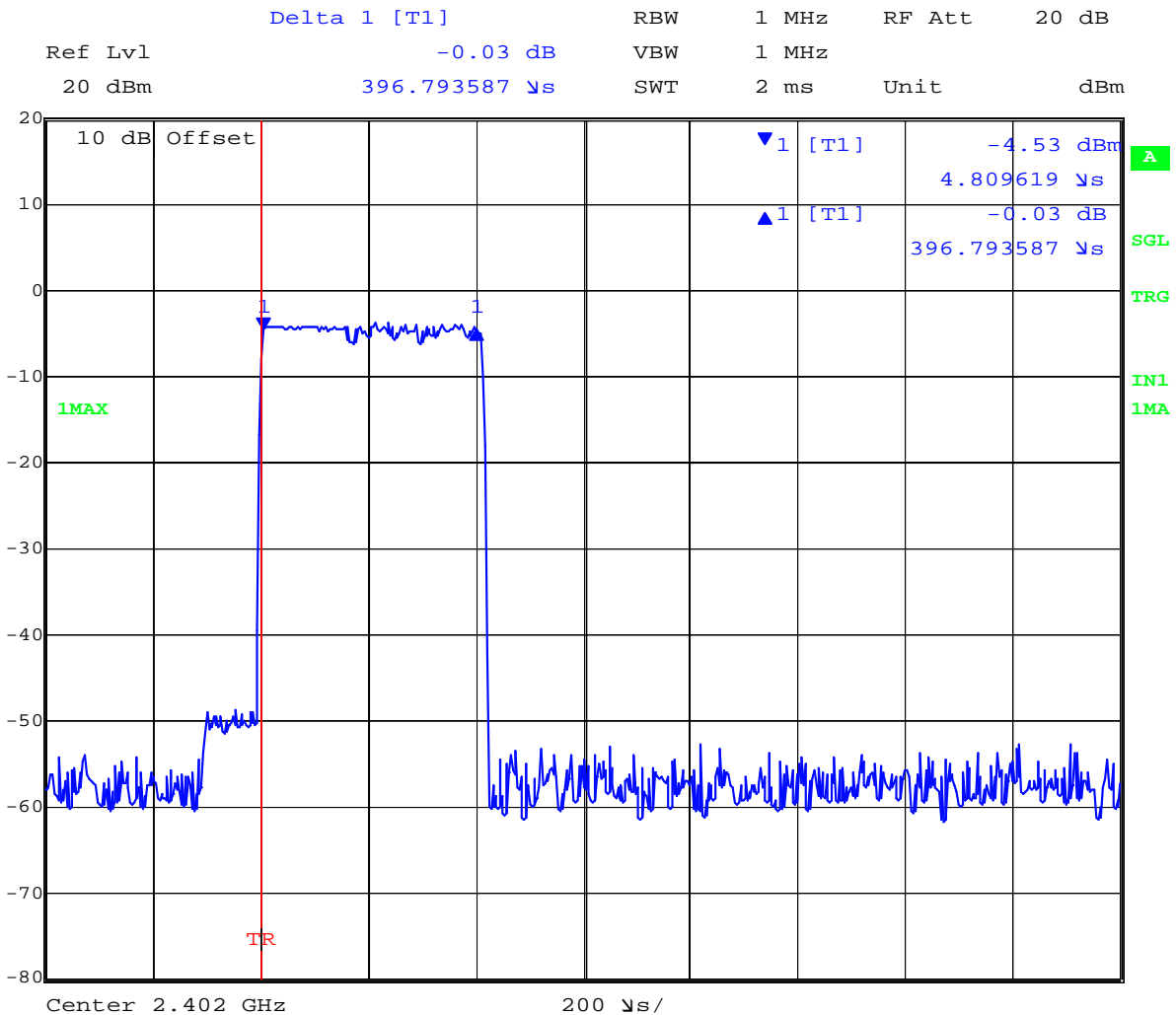

Date: 17.JAN.2013 11:03:06

This test report may be reproduced in full only. The document may only be updated by MiCOM Labs personnel. Any changes will be noted in the Document History section of the report.



Title: Ear Force Z300 RX Wireless Audio Headset
To: FCC 47 CFR Part 15.247 & IC RSS-210
Serial #: COMM39-U2 Rev A
Issue Date: 25th July 2013
Page: 52 of 145

Time of Occupancy; Hopping On; 2402; 1 Mbs Data Rate; Packet Type DH5; Dwell Time 2.862 ms

 **Marker 1 [T1]** RBW 1 MHz RF Att 50 dB
Ref Lvl -4.23 dBm VBW 1 MHz
30 dBm -18.990782 μ s SWT 12 ms Unit dBm

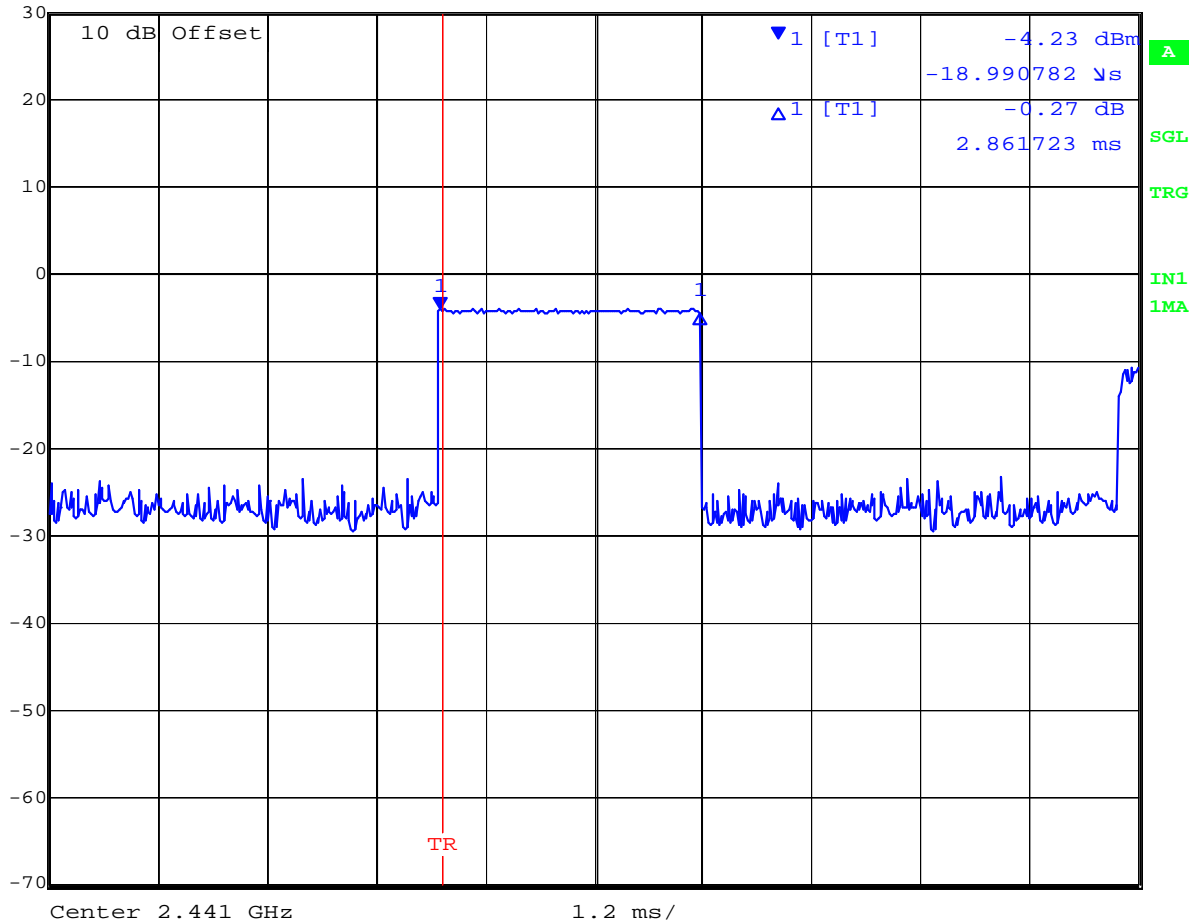

Date: 16.JAN.2013 18:16:24

This test report may be reproduced in full only. The document may only be updated by MiCOM Labs personnel. Any changes will be noted in the Document History section of the report.



Title: Ear Force Z300 RX Wireless Audio Headset
To: FCC 47 CFR Part 15.247 & IC RSS-210
Serial #: COMM39-U2 Rev A
Issue Date: 25th July 2013
Page: 53 of 145

Time of Occupancy; Hopping On; 2402; 2 Mbs Data Rate; Packet Type DH1; Dwell Time 1.653 ms

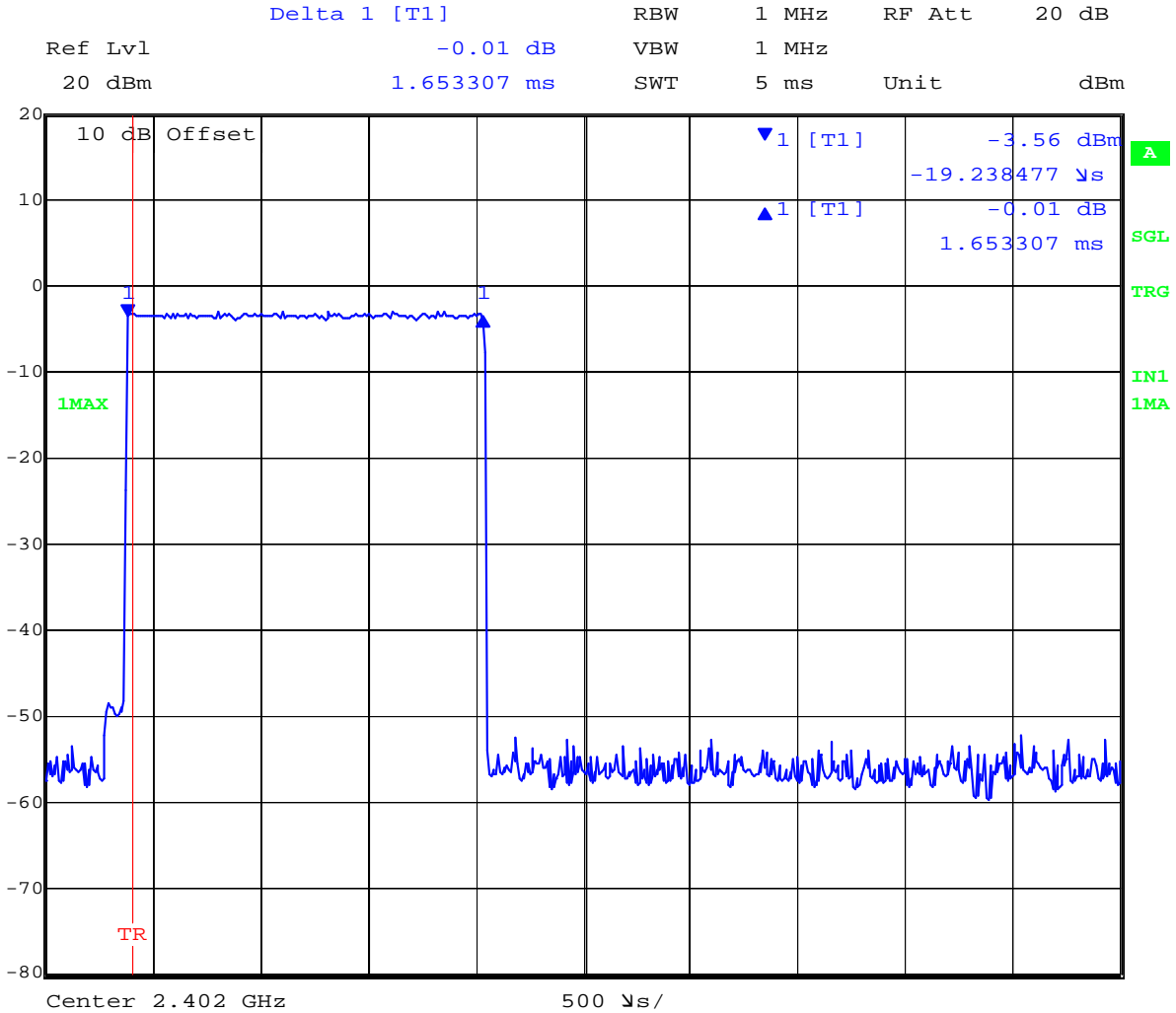

Date: 17.JAN.2013 10:55:32

This test report may be reproduced in full only. The document may only be updated by MiCOM Labs personnel. Any changes will be noted in the Document History section of the report.



Title: Ear Force Z300 RX Wireless Audio Headset
To: FCC 47 CFR Part 15.247 & IC RSS-210
Serial #: COMM39-U2 Rev A
Issue Date: 25th July 2013
Page: 54 of 145

Time of Occupancy; Hopping On; 2402; 2 Mbs Data Rate; Packet Type DH3; Dwell Time 1.653 ms

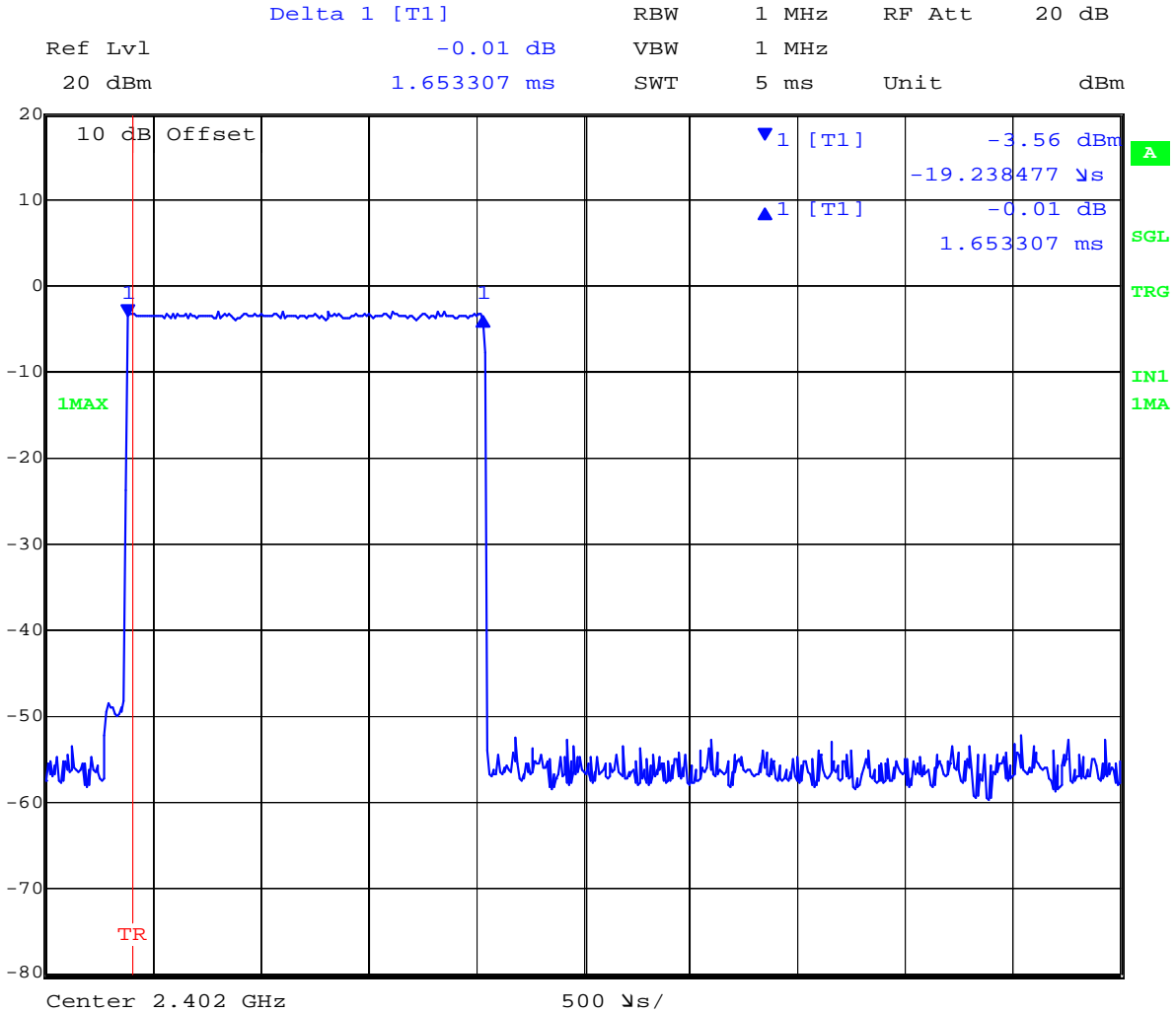

Date: 17.JAN.2013 10:55:32

This test report may be reproduced in full only. The document may only be updated by MiCOM Labs personnel. Any changes will be noted in the Document History section of the report.



Title: Ear Force Z300 RX Wireless Audio Headset
To: FCC 47 CFR Part 15.247 & IC RSS-210
Serial #: COMM39-U2 Rev A
Issue Date: 25th July 2013
Page: 55 of 145

Time of Occupancy; Hopping On; 2402; 2 Mbs Data Rate; Packet Type DH5; Dwell Time 2.886 ms

 Ref Lvl 30 dBm Delta 1 [T1] -0.49 dB RBW 1 MHz RF Att 50 dB
VBW 1 MHz
SWT 12 ms Unit dBm

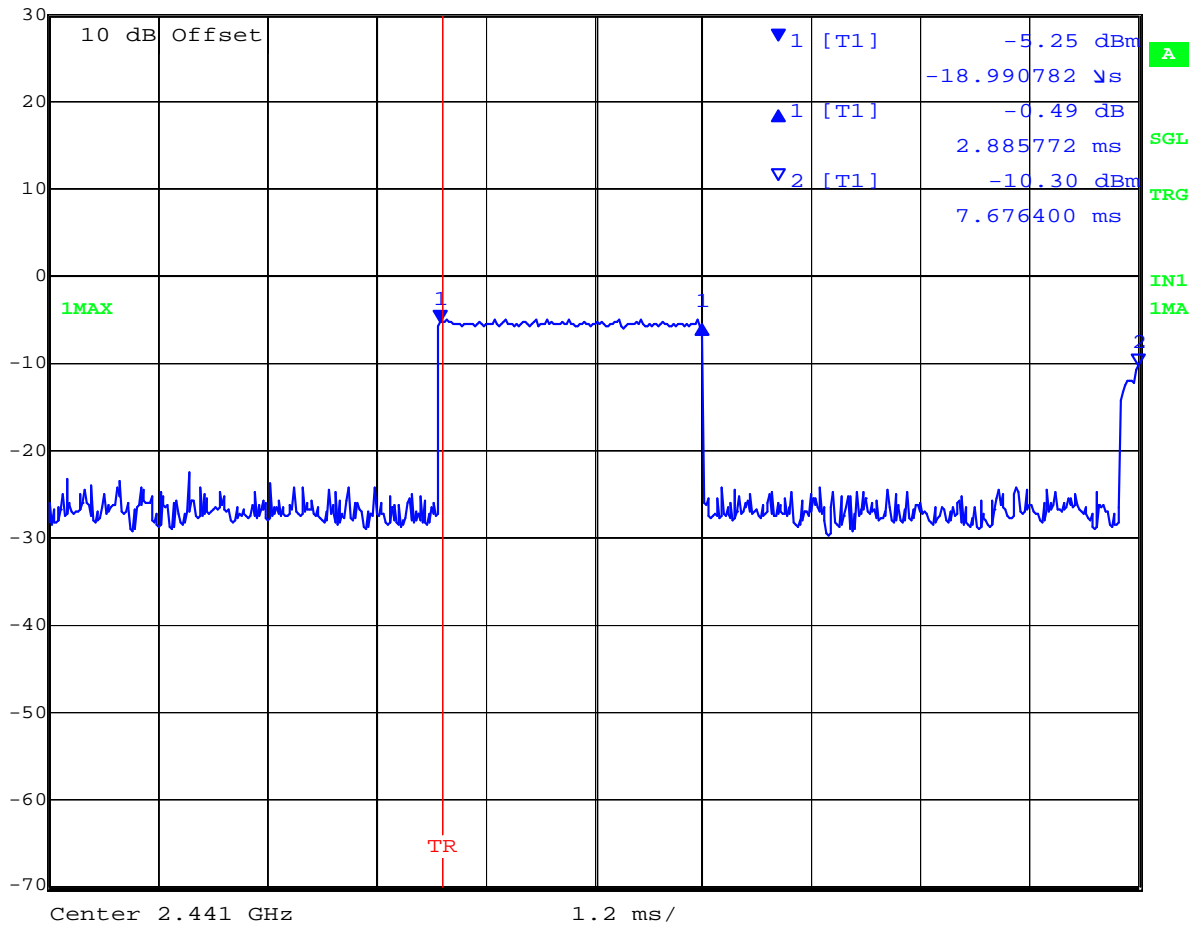

Date: 16.JAN.2013 18:08:32

This test report may be reproduced in full only. The document may only be updated by MiCOM Labs personnel. Any changes will be noted in the Document History section of the report.



Title: Ear Force Z300 RX Wireless Audio Headset
To: FCC 47 CFR Part 15.247 & IC RSS-210
Serial #: COMM39-U2 Rev A
Issue Date: 25th July 2013
Page: 56 of 145

Time of Occupancy; Hopping On; 2402; 3 Mbs Data Rate; Packet Type DH1; Dwell Time 1.653 ms

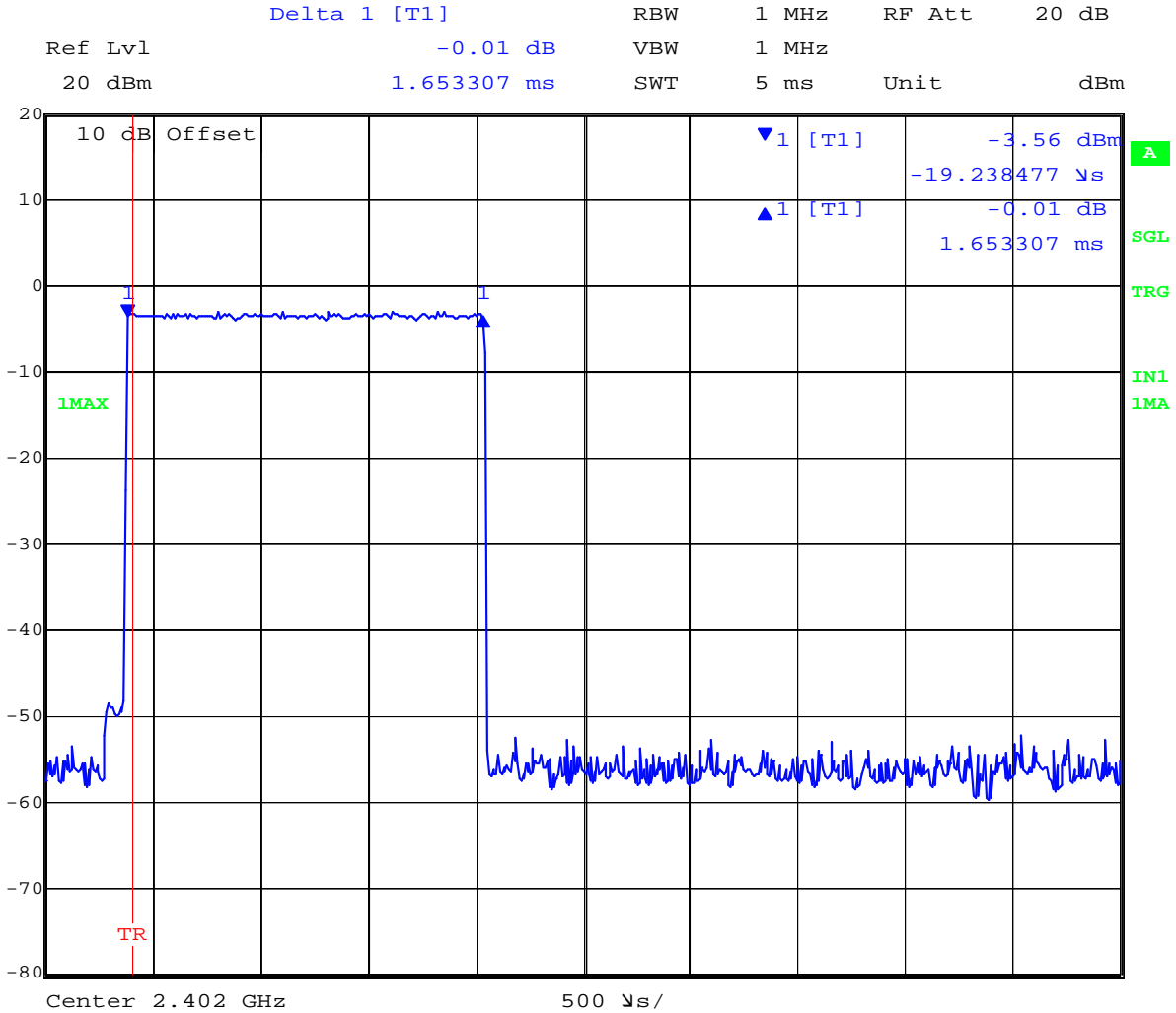

Date: 17.JAN.2013 10:55:32

This test report may be reproduced in full only. The document may only be updated by MiCOM Labs personnel. Any changes will be noted in the Document History section of the report.



Title: Ear Force Z300 RX Wireless Audio Headset
To: FCC 47 CFR Part 15.247 & IC RSS-210
Serial #: COMM39-U2 Rev A
Issue Date: 25th July 2013
Page: 57 of 145

Time of Occupancy; Hopping On; 2402; 3 Mbs Data Rate; Packet Type DH3; Dwell Time 1.653 ms

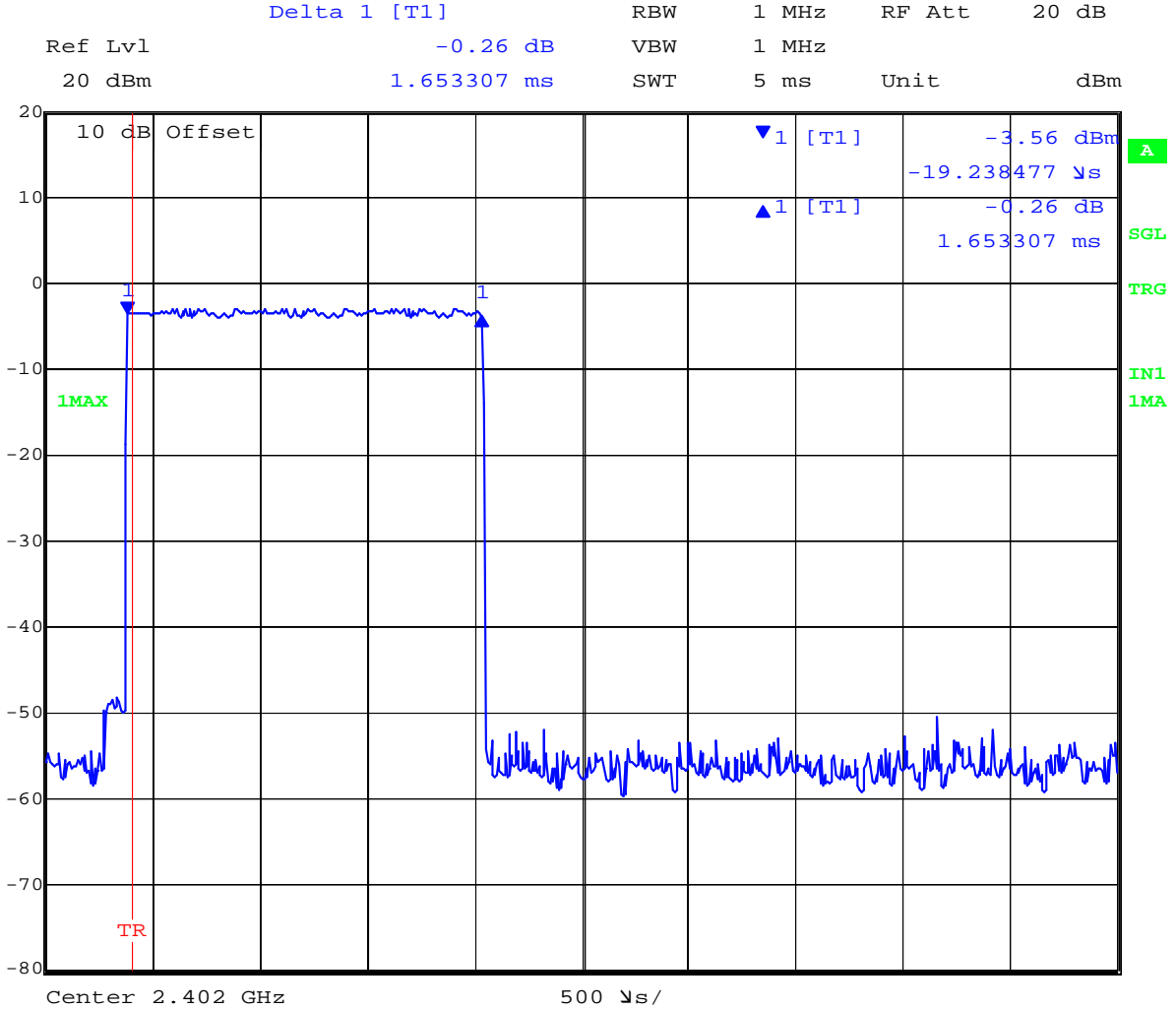

Date: 17.JAN.2013 10:57:33

This test report may be reproduced in full only. The document may only be updated by MiCOM Labs personnel. Any changes will be noted in the Document History section of the report.



Title: Ear Force Z300 RX Wireless Audio Headset
To: FCC 47 CFR Part 15.247 & IC RSS-210
Serial #: COMM39-U2 Rev A
Issue Date: 25th July 2013
Page: 58 of 145

Time of Occupancy; Hopping On; 2402; 3 Mbs Data Rate; Packet Type DH5; Dwell Time 2.862 ms

 Delta 1 [T1] RBW 1 MHz RF Att 50 dB
 Ref Lvl -0.03 dB VBW 1 MHz
 30 dBm 2.861723 ms SWT 12 ms Unit dBm

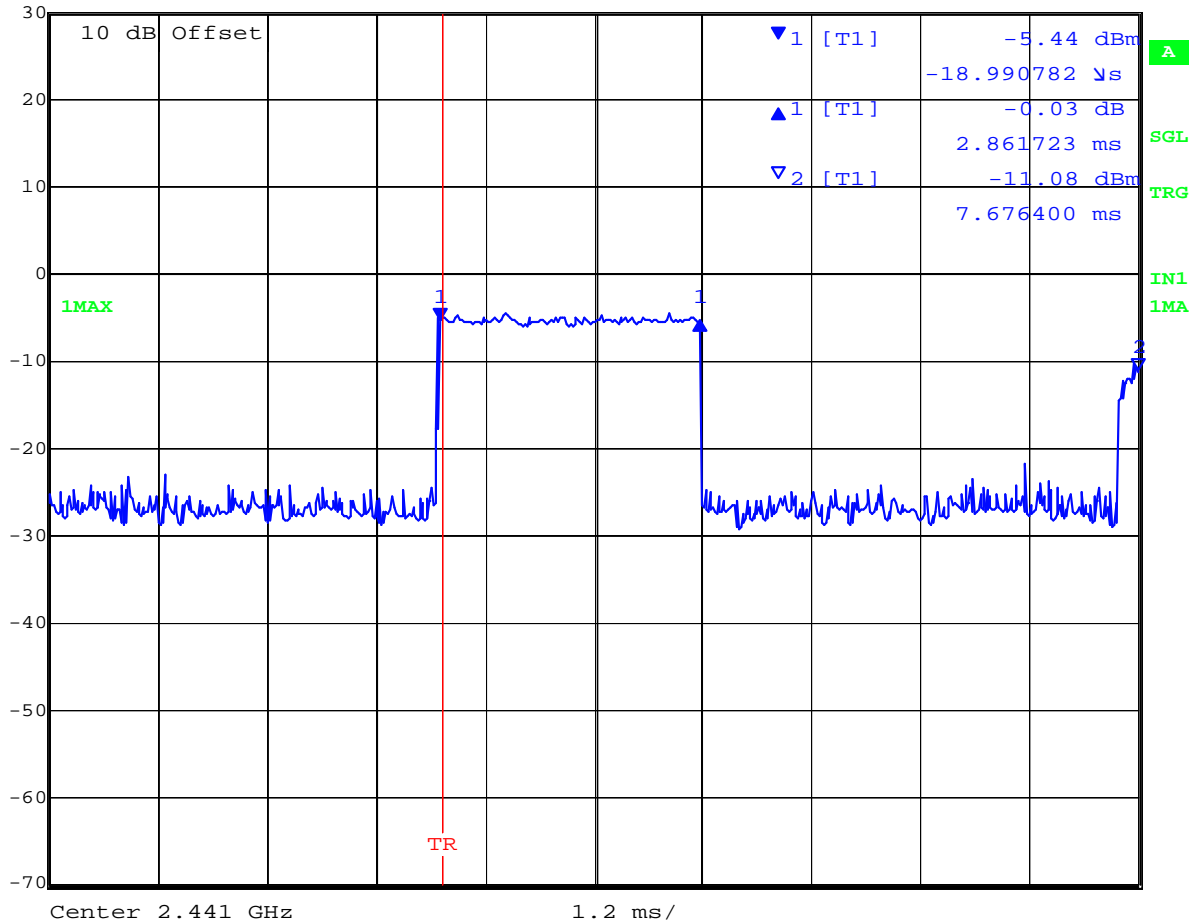

Date: 16.JAN.2013 18:13:26

This test report may be reproduced in full only. The document may only be updated by MiCOM Labs personnel. Any changes will be noted in the Document History section of the report.



Title: Ear Force Z300 RX Wireless Audio Headset
To: FCC 47 CFR Part 15.247 & IC RSS-210
Serial #: COMM39-U2 Rev A
Issue Date: 25th July 2013
Page: 59 of 145

Specification

Limits Channel Occupancy (Dwell Time)

§15.247(a)(1)(iii) Frequency hopping systems in the 2400–2483.5 MHz band shall use at least 15 channels. The average time of occupancy on any channel shall not be greater than 0.4 seconds within a period of 0.4 seconds multiplied by the number of hopping channels employed. Frequency hopping systems may avoid or suppress transmissions on a particular hopping frequency provided that a minimum of 15 channels are used.

RSS-210 §A8.1 (d) Frequency hopping systems operating in the 2400–2483.5 MHz band shall use at least 15 hopping channels. The average time of occupancy on any channel shall not be greater than 0.4 seconds within a period of 0.4 seconds, multiplied by the number of hopping channels employed. Transmissions on particular frequencies may be avoided or suppressed provided that a minimum of 15 hopping channels are used.

Traceability

Method	Test Equipment Used
FCC DA 00-175	0078, 0134, 0158, 0184, 0193, 0287, 0250, 0252, 0310, 0312

This test report may be reproduced in full only. The document may only be updated by MiCOM Labs personnel. Any changes will be noted in the Document History section of the report.



Title: Ear Force Z300 RX Wireless Audio Headset
To: FCC 47 CFR Part 15.247 & IC RSS-210
Serial #: COMM39-U2 Rev A
Issue Date: 25th July 2013
Page: 60 of 145

6.1.1.5. Channel Occupancy

Conducted Test Conditions for Channel Occupancy			
Standard:	FCC CFR 47:15.247	Ambient Temp. (°C):	24.0 - 27.5
Test Heading:	Channel Occupancy	Rel. Humidity (%):	32 - 45
Standard Section(s):	15.247 (a)	Pressure (mBars):	999 - 1001
Reference Document(s):	FCC DA 00-705 "Filing and Measurement Guidelines for Frequency Hopping Spread Spectrum Systems"		
Test Procedure for Time of Occupancy (Dwell Time) The EUT must have its hopping function Enabled The transmitter output was connected to a spectrum analyzer and the span was set for the frequency of operation. RBW = 1 MHz, VBW ≥ RBW, Sweep = Dwell time x number of hopping frequencies, detector function = peak, trace = max hold.			

This test report may be reproduced in full only. The document may only be updated by MiCOM Labs personnel. Any changes will be noted in the Document History section of the report.



Title: Ear Force Z300 RX Wireless Audio Headset
To: FCC 47 CFR Part 15.247 & IC RSS-210
Serial #: COMM39-U2 Rev A
Issue Date: 25th July 2013
Page: 61 of 145

Equipment Configuration for Channel Occupancy

Variant:	802.15.2	Duty Cycle (%):	100%
Data Rate:	1-3 Mbit/s	Antenna Gain (dBi):	2.8
Modulation:	GFSK, $\pi/4$ DQPSK, 8DPSK	Beam Forming Gain (Y):	Not Applicable
TPC:	N/A		
Engineering Test Notes:	DH5 Packet types give the highest Dwell time, varying packet length also varies occupancy time		

Test Measurement Results

Centered on Channel	Center Frequency	Data Rate	Packet Length	Dwell Time (Single Channel)	Number of Hops	Channel Occupancy	Limit	Result
	MHz	Mbs		mS		mS	mS	
0	2402	1	0	0.397	348	138.16	400	Pass
0	2402	2	510	1.653	190	363.99	400	Pass
0	2402	3	1021	2.886	126	364.79	400	Pass

Traceability to Industry Recognized Test Methodologies

Work Instruction:	FCC DA 00-0705
Measurement Uncertainty:	± 2.81 dB (Spectrum/Amplitude), ± 0.86 ppm (Frequency)

Channel Occupancy was performed using a sweep time of 32 seconds ($79 \times 0.4 = 31.6$ seconds) and the packet type with the highest dwell time (DH5).

All packet types were then checked with a sweep time of 1 second to verify the number of times the transmitter occupied Channel 0 (2402 MHz). Each packet type transmitted on channel 39 at the following rates:

DH5 packet length 0 = 11

DH5 packet length 510 = 6

DH5 packet length 1021 = 4

The number of hops = hops per one second \times 31.6 seconds

Finally the channel occupancy time = number of hops \times single channel dwell time

This test report may be reproduced in full only. The document may only be updated by MiCOM Labs personnel. Any changes will be noted in the Document History section of the report.



Title: Ear Force Z300 RX Wireless Audio Headset
To: FCC 47 CFR Part 15.247 & IC RSS-210
Serial #: COMM39-U2 Rev A
Issue Date: 25th July 2013
Page: 62 of 145

Specification Limits

§15.247 (b) The maximum peak output power of the intentional radiator shall not exceed the following:

(1) For frequency hopping systems operating in the 2400–2483.5 MHz band employing at least 75 non-overlapping hopping channels, and all frequency hopping systems in the 5725–5850 MHz band: 1 watt. For all other frequency hopping systems in the 2400–2483.5 MHz band: 0.125 watts.

RSS-210 §A8.4 (2) For frequency hopping systems operating in the band 2400-2483.5 MHz and employing at least 75 hopping channels, the maximum peak conducted output power shall not exceed 1 W; for all other frequency hopping systems in the band, the maximum peak conducted output power shall not exceed 0.125 W. Except as provided in Section A8.4 (5), the e.i.r.p. shall not exceed 4 W..

Laboratory Measurement Uncertainty for Power Measurements

Measurement uncertainty	±1.33 dB
-------------------------	----------

This test report may be reproduced in full only. The document may only be updated by MiCOM Labs personnel. Any changes will be noted in the Document History section of the report.



Title: Ear Force Z300 RX Wireless Audio Headset
To: FCC 47 CFR Part 15.247 & IC RSS-210
Serial #: COMM39-U2 Rev A
Issue Date: 25th July 2013
Page: 63 of 145

6.1.1.6. Peak Output Power

Conducted Test Conditions for Fundamental Emission Output Power			
Standard:	FCC CFR 47:15.247	Ambient Temp. (°C):	24.0 - 27.5
Test Heading:	Emission Output Power	Rel. Humidity (%):	32 - 45
Standard Section(s):	15.247 (d)	Pressure (mBars):	999 - 1004
Reference Document(s):	FCC DA 00-705 "Filing and Measurement Guidelines for Frequency Hopping Spread Spectrum Systems"		

Test Procedure for Fundamental Emission Output Power Measurement

The transmitter terminal of EUT was connected to the input of the spectrum analyzer set to measure peak power. The span was set to approximately 5 times the 20 dB bandwidth, centered on a hopping channel. RBW > 20 dB bandwidth of the emission being measured, VBW ≥ RBW, sweep = auto, detector function = peak and trace = max hold.

This test report may be reproduced in full only. The document may only be updated by MiCOM Labs personnel. Any changes will be noted in the Document History section of the report.



Title: Ear Force Z300 RX Wireless Audio Headset
To: FCC 47 CFR Part 15.247 & IC RSS-210
Serial #: COMM39-U2 Rev A
Issue Date: 25th July 2013
Page: 64 of 145

Equipment Configuration for Peak Output Power

Variant:	802.15.2	Duty Cycle (%):	100%
Data Rate:	1-3 Mbit/s	Antenna Gain (dBi):	2.8
Modulation:	GFSK, $\pi/4$ DQPSK, 8DPSK	Beam Forming Gain (Y):	Not Applicable
TPC:	N/A		
Engineering Test Notes:			

1 Mbs:

Test Measurement Results DH1								
Test Frequency	Measured Output Power (dBm)				Calculated Total Power (dBm)	Limit	Margin	EUT Power Setting
	Port(s)							
MHz	a	b	c	d	Σ Port(s)	dBm	dBm	
2402 (CH0)	0.67	--	--	--	0.67	30	-29.33	Max
2441 (CH39)	-0.67	--	--	--	-0.67	30	-30.67	Max
2480 (CH78)	-3.06	--	--	--	-3.06	30	-33.06	Max

Test Measurement Results DH3								
Test Frequency	Measured Output Power (dBm)				Calculated Total Power (dBm)	Limit	Margin	EUT Power Setting
	Port(s)							
MHz	a	b	c	d	Σ Port(s)	dBm	dBm	
2402 (CH0)	0.7	--	--	--	0.7	30	-29.3	Max
2441 (CH39)	-0.71	--	--	--	-0.71	30	-30.71	Max
2480 (CH78)	-3.08	--	--	--	-3.08	30	-33.08	Max

Test Measurement Results DH5								
Test Frequency	Measured Output Power (dBm)				Calculated Total Power (dBm)	Limit	Margin	EUT Power Setting
	Port(s)							
MHz	a	b	c	d	Σ Port(s)	dBm	dBm	
2402 (CH0)	0.67	--	--	--	0.67	30	-29.33	Max
2441 (CH39)	-0.68	--	--	--	-0.68	30	-30.68	Max
2480 (CH78)	-3.11	--	--	--	-3.11	30	-33.11	Max

Traceability to Industry Recognized Test Methodologies	
Work Instruction:	WI-01 MEASURING RF OUTPUT POWER
Measurement Uncertainty:	± 1.33 dB

The EUT was tested at the data rate with highest power density (1 Mbits/s) for each packet type DH1, DH3 and DH5.

This test report may be reproduced in full only. The document may only be updated by MiCOM Labs personnel. Any changes will be noted in the Document History section of the report.



Title: Ear Force Z300 RX Wireless Audio Headset
To: FCC 47 CFR Part 15.247 & IC RSS-210
Serial #: COMM39-U2 Rev A
Issue Date: 25th July 2013
Page: 65 of 145

Peak Power, Channel 0, DH1 Packet Type

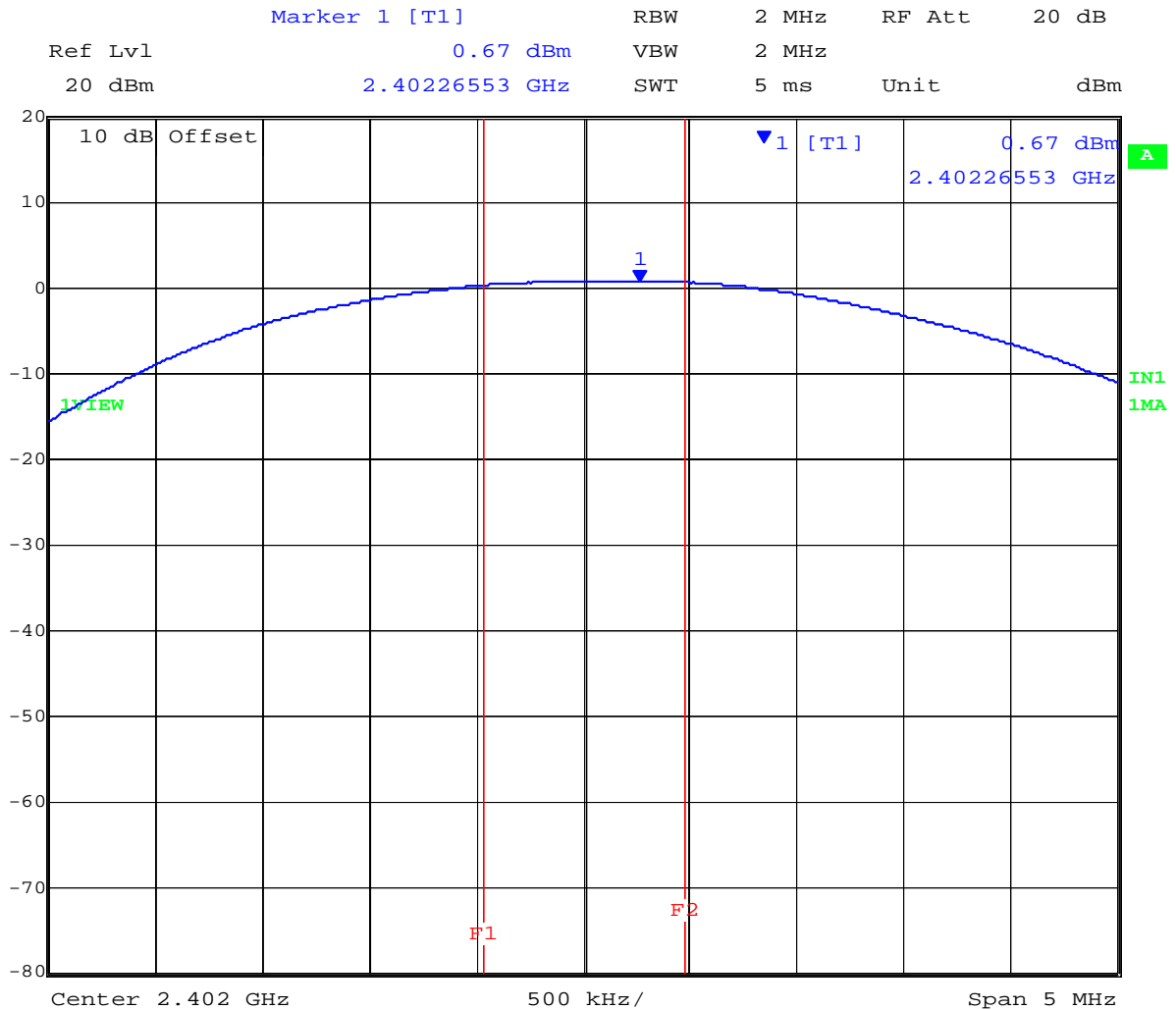

Date: 17.JAN.2013 11:39:11

This test report may be reproduced in full only. The document may only be updated by MiCOM Labs personnel. Any changes will be noted in the Document History section of the report.



Title: Ear Force Z300 RX Wireless Audio Headset
To: FCC 47 CFR Part 15.247 & IC RSS-210
Serial #: COMM39-U2 Rev A
Issue Date: 25th July 2013
Page: 66 of 145

Peak Power, Channel 39, DH1 Packet Type

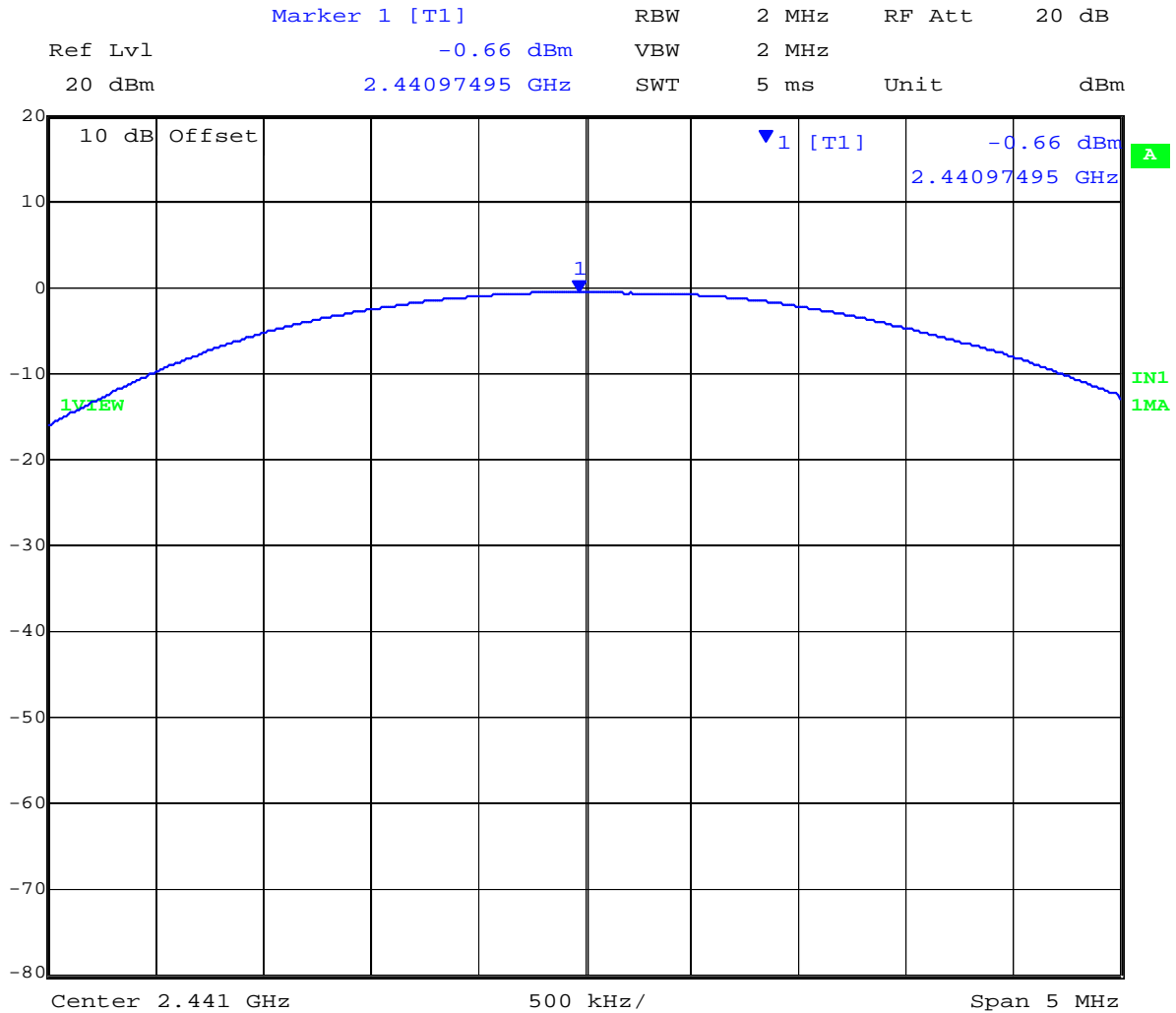

Date: 17.JAN.2013 11:52:17

This test report may be reproduced in full only. The document may only be updated by MiCOM Labs personnel. Any changes will be noted in the Document History section of the report.



Title: Ear Force Z300 RX Wireless Audio Headset
To: FCC 47 CFR Part 15.247 & IC RSS-210
Serial #: COMM39-U2 Rev A
Issue Date: 25th July 2013
Page: 67 of 145

Peak Power, Channel 78, DH1 Packet Type

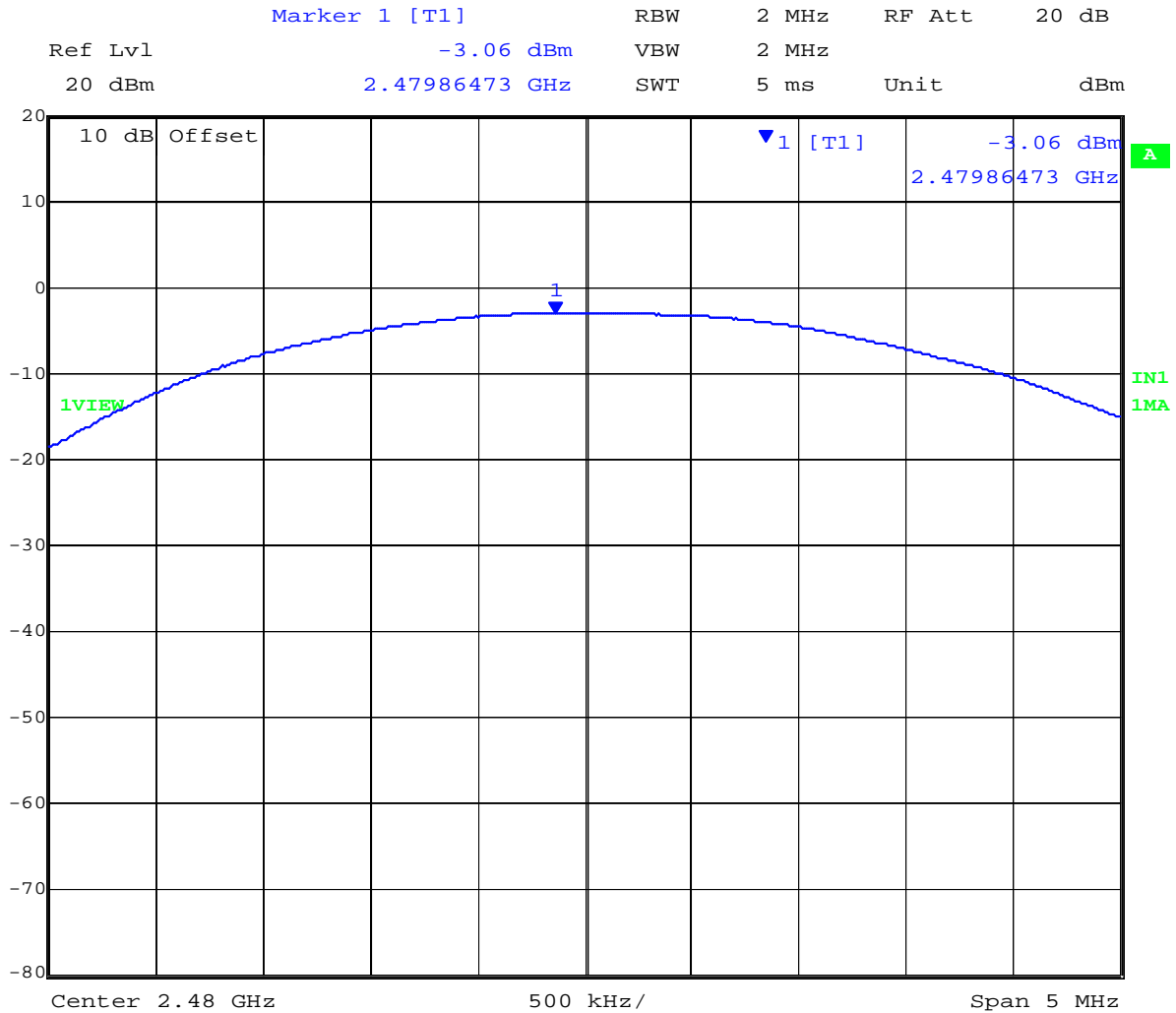

Date: 17.JAN.2013 12:01:13

This test report may be reproduced in full only. The document may only be updated by MiCOM Labs personnel. Any changes will be noted in the Document History section of the report.



Title: Ear Force Z300 RX Wireless Audio Headset
To: FCC 47 CFR Part 15.247 & IC RSS-210
Serial #: COMM39-U2 Rev A
Issue Date: 25th July 2013
Page: 68 of 145

Peak Power, Channel 0, DH3 Packet Type

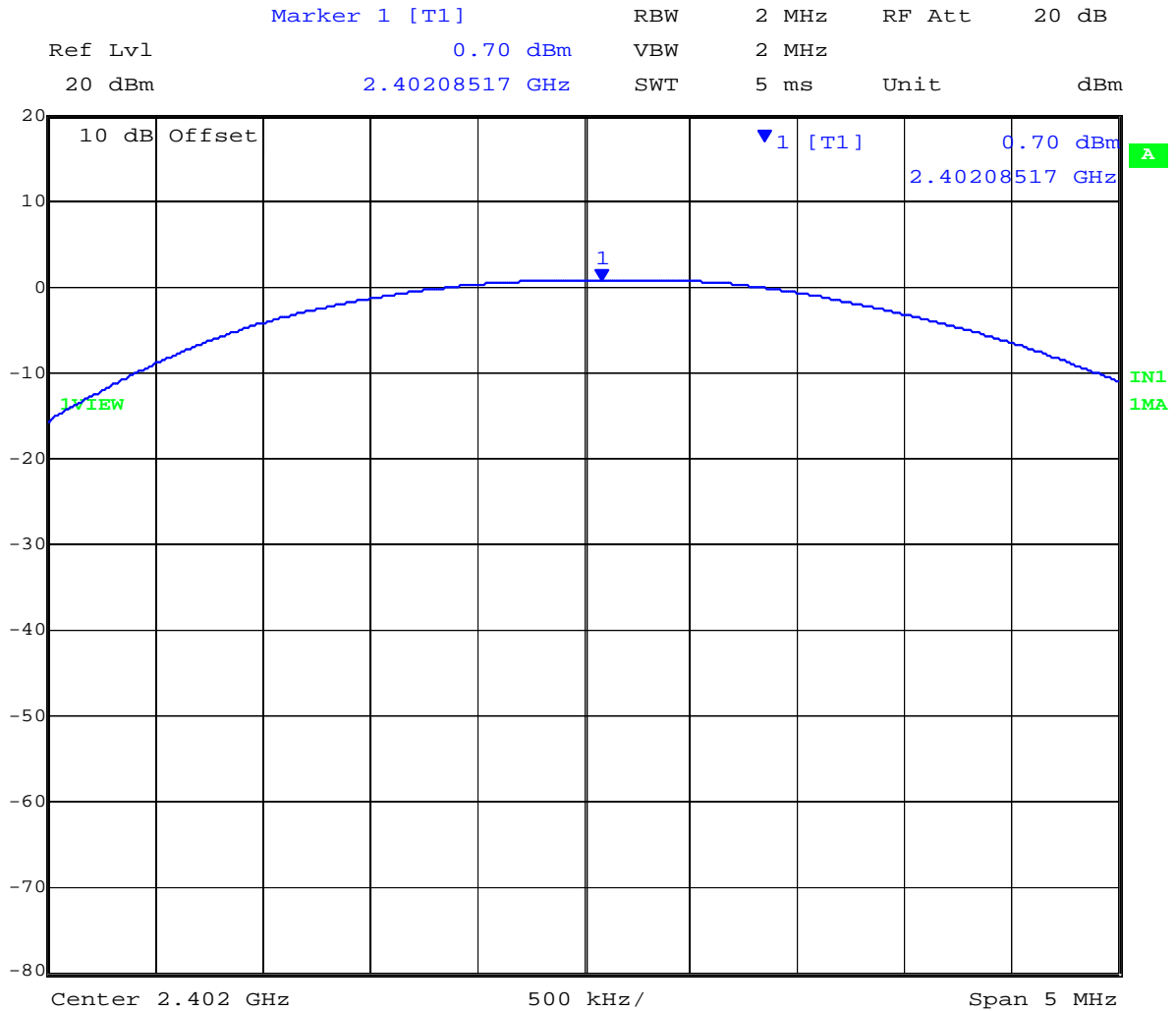

Date: 17.JAN.2013 11:45:19

This test report may be reproduced in full only. The document may only be updated by MiCOM Labs personnel. Any changes will be noted in the Document History section of the report.



Title: Ear Force Z300 RX Wireless Audio Headset
To: FCC 47 CFR Part 15.247 & IC RSS-210
Serial #: COMM39-U2 Rev A
Issue Date: 25th July 2013
Page: 69 of 145

Peak Power, Channel 39, DH3 Packet Type

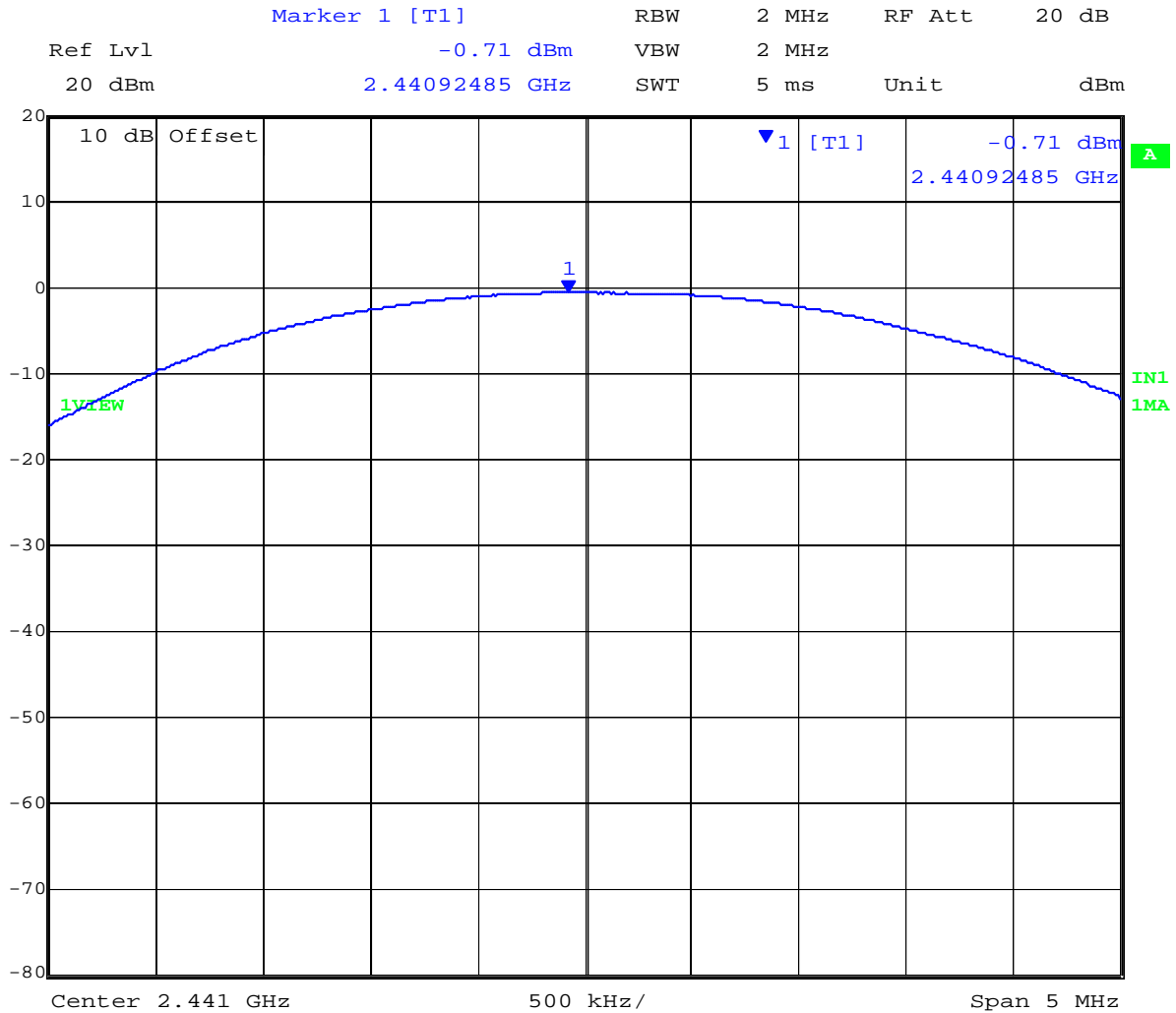

Date: 17.JAN.2013 11:56:13

This test report may be reproduced in full only. The document may only be updated by MiCOM Labs personnel. Any changes will be noted in the Document History section of the report.



Title: Ear Force Z300 RX Wireless Audio Headset
To: FCC 47 CFR Part 15.247 & IC RSS-210
Serial #: COMM39-U2 Rev A
Issue Date: 25th July 2013
Page: 70 of 145

Peak Power, Channel 78, DH3 Packet Type

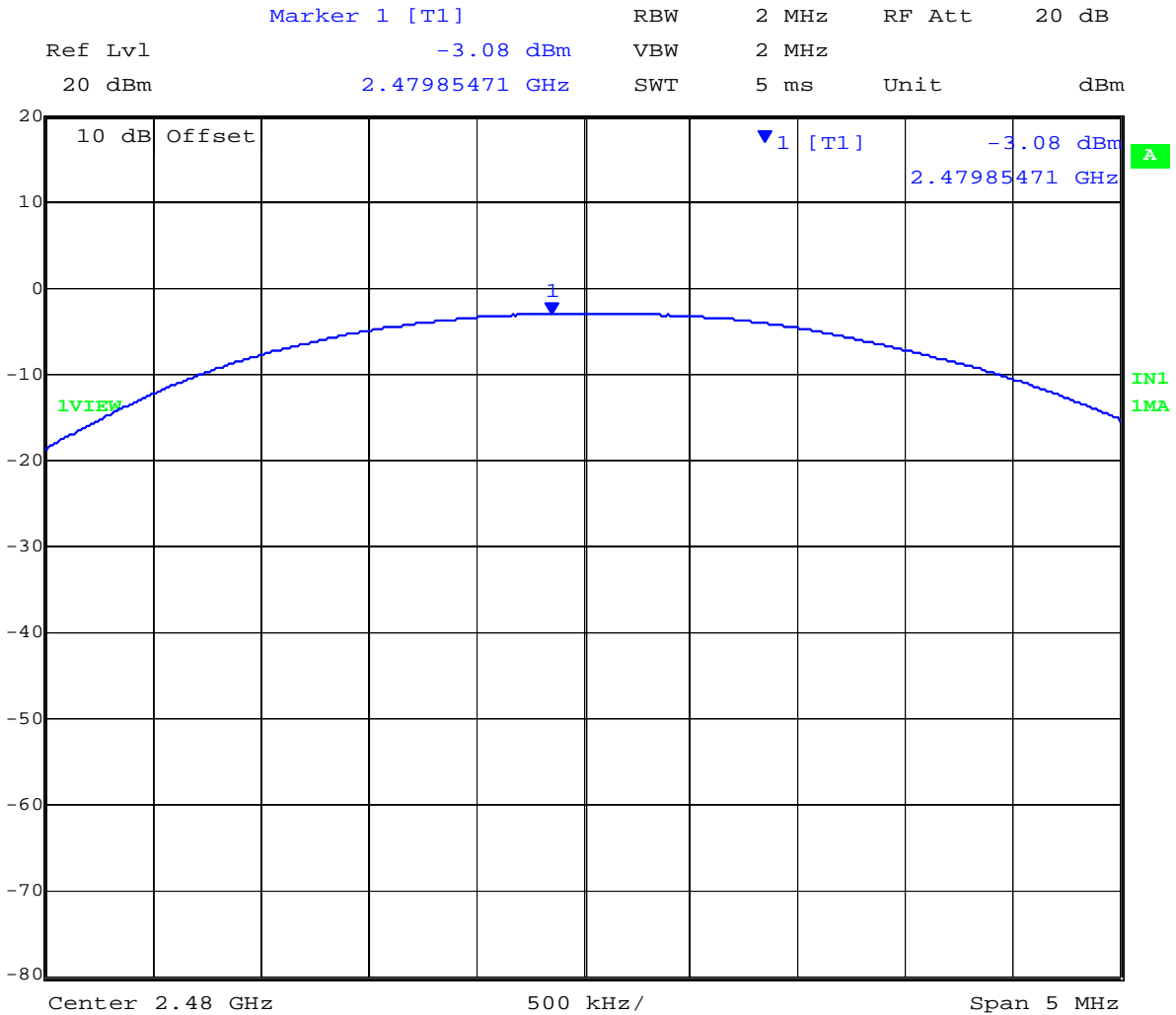

Date: 17.JAN.2013 12:04:35

This test report may be reproduced in full only. The document may only be updated by MiCOM Labs personnel. Any changes will be noted in the Document History section of the report.



Title: Ear Force Z300 RX Wireless Audio Headset
To: FCC 47 CFR Part 15.247 & IC RSS-210
Serial #: COMM39-U2 Rev A
Issue Date: 25th July 2013
Page: 71 of 145

Peak Power, Channel 0, DH5 Packet Type

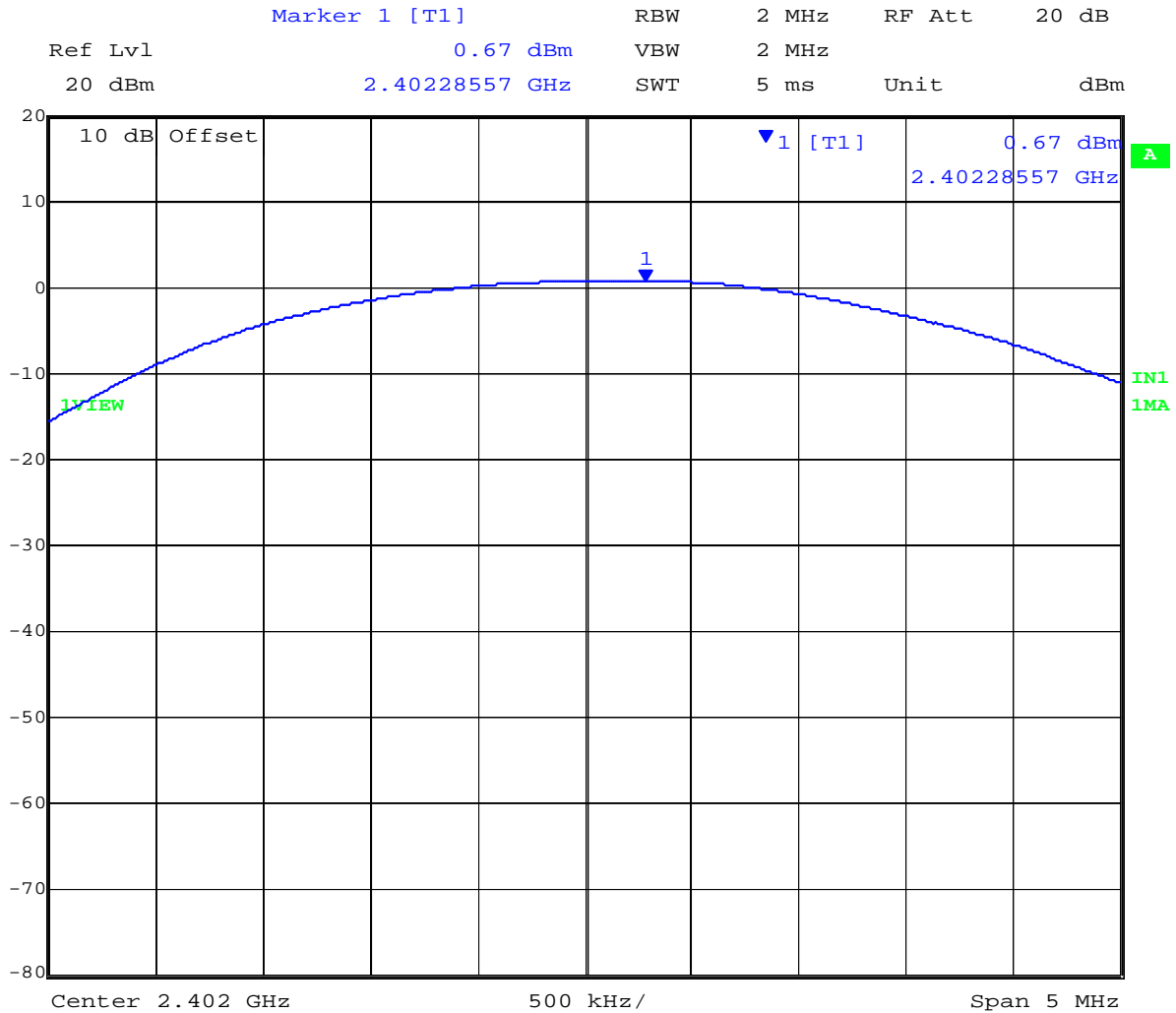

Date: 17.JAN.2013 11:48:31

This test report may be reproduced in full only. The document may only be updated by MiCOM Labs personnel. Any changes will be noted in the Document History section of the report.



Title: Ear Force Z300 RX Wireless Audio Headset
To: FCC 47 CFR Part 15.247 & IC RSS-210
Serial #: COMM39-U2 Rev A
Issue Date: 25th July 2013
Page: 72 of 145

Peak Power, Channel 39, DH5 Packet Type

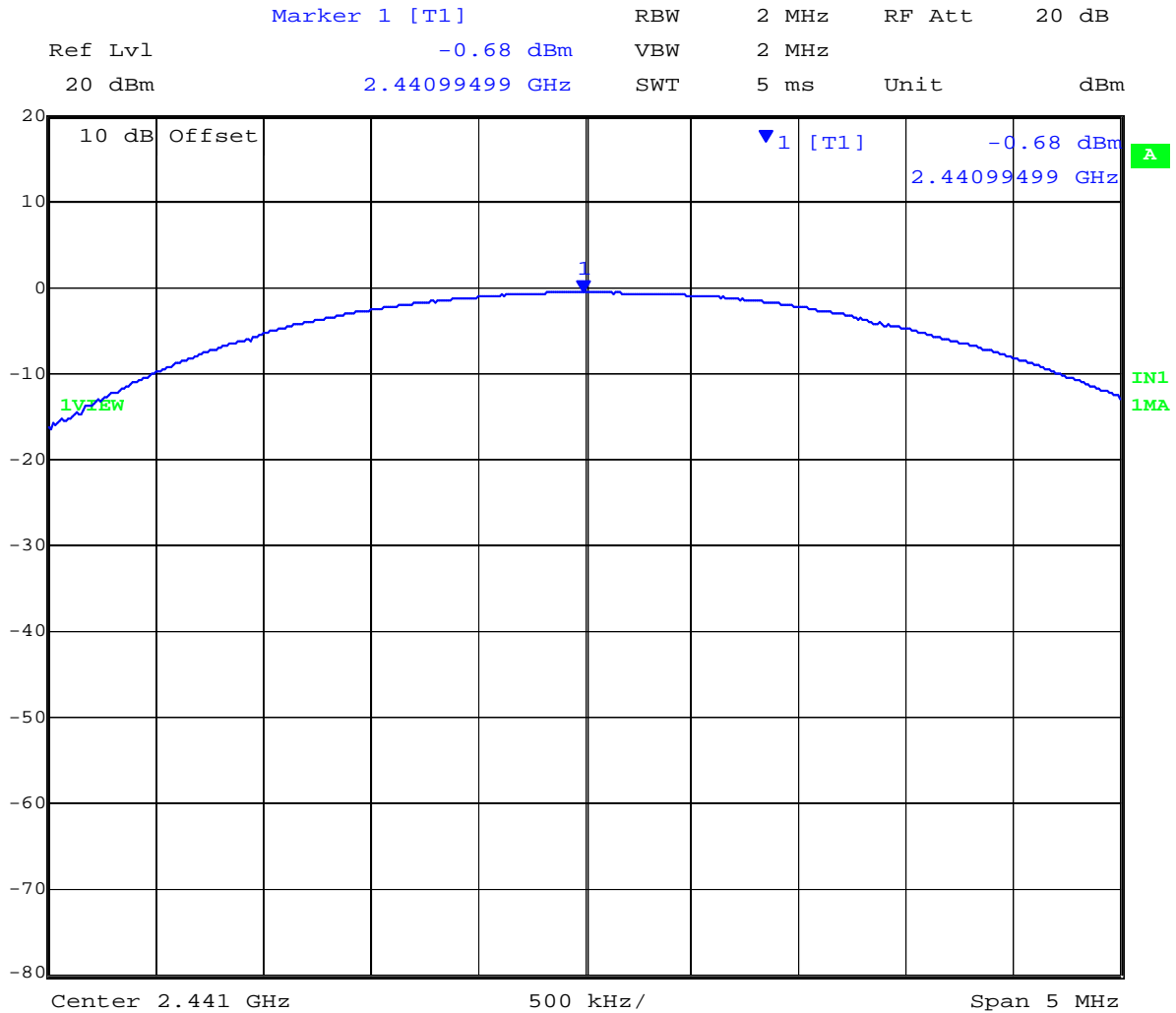

Date: 17.JAN.2013 11:58:43

This test report may be reproduced in full only. The document may only be updated by MiCOM Labs personnel. Any changes will be noted in the Document History section of the report.



Title: Ear Force Z300 RX Wireless Audio Headset
To: FCC 47 CFR Part 15.247 & IC RSS-210
Serial #: COMM39-U2 Rev A
Issue Date: 25th July 2013
Page: 73 of 145

Peak Power, Channel 78, DH5 Packet Type

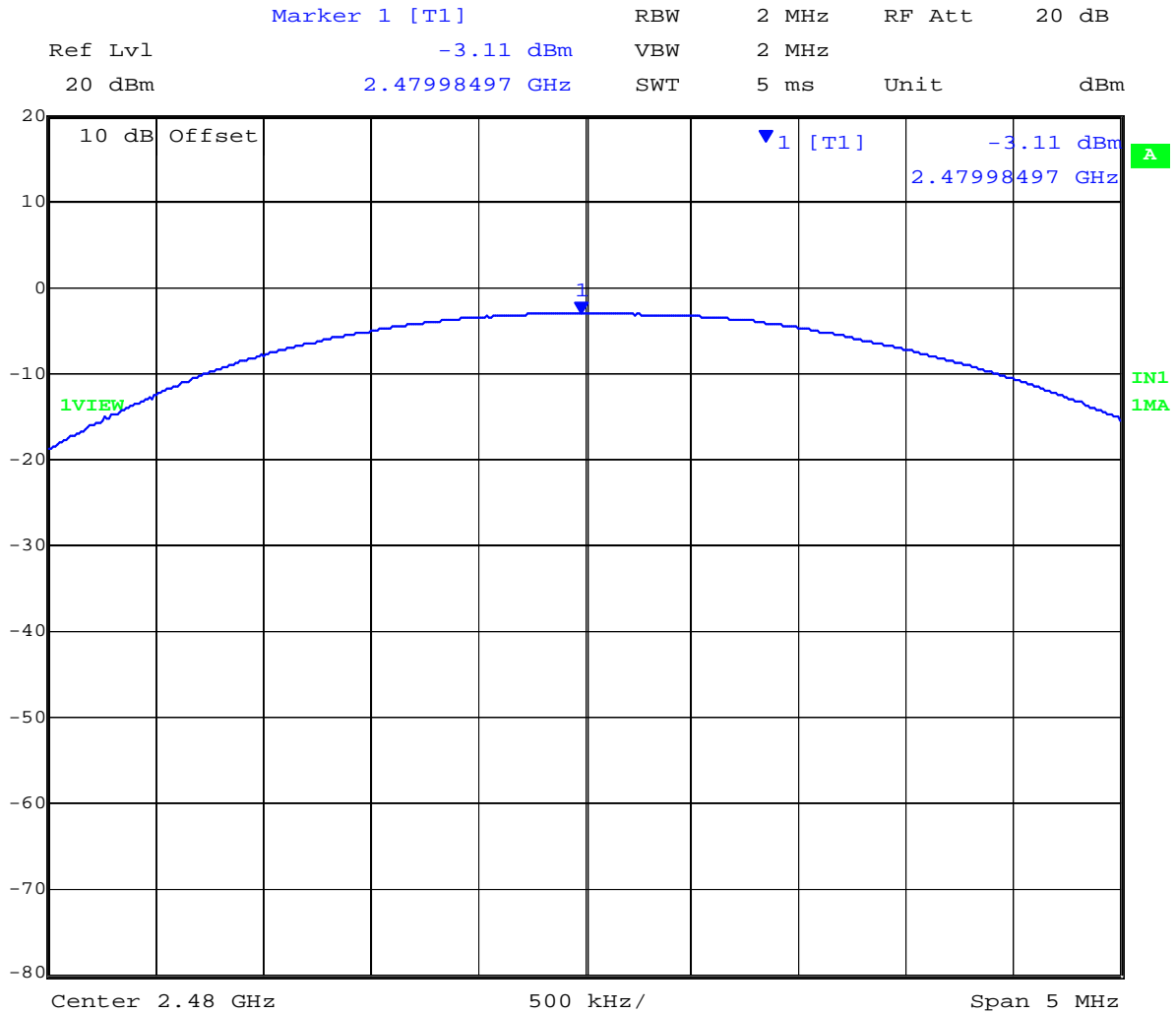

Date: 17.JAN.2013 12:07:01

This test report may be reproduced in full only. The document may only be updated by MiCOM Labs personnel. Any changes will be noted in the Document History section of the report.



Title: Ear Force Z300 RX Wireless Audio Headset
To: FCC 47 CFR Part 15.247 & IC RSS-210
Serial #: COMM39-U2 Rev A
Issue Date: 25th July 2013
Page: 74 of 145

2 Mbs:

Test Measurement Results DH1								
Test Frequency	Measured Output Power (dBm)				Calculated Total Power (dBm)	Limit	Margin	EUT Power Setting
	Port(s)							
MHz	a	b	c	d	Σ Port(s)	dBm	dBm	
2402 (CH0)	-0.95	--	--	--	-0.95	30	-30.95	Max
2441 (CH39)	-2.64	--	--	--	-2.64	30	-32.64	Max
2480 (CH78)	-5.26	--	--	--	-5.26	30	-35.26	Max

Test Measurement Results DH3								
Test Frequency	Measured Output Power (dBm)				Calculated Total Power (dBm)	Limit	Margin	EUT Power Setting
	Port(s)							
MHz	a	b	c	d	Σ Port(s)	dBm	dBm	
2402 (CH0)	-0.79	--	--	--	-0.79	30	-30.79	Max
2441 (CH39)	-2.55	--	--	--	-2.55	30	-32.55	Max
2480 (CH78)	-5.09	--	--	--	-5.09	30	-35.09	Max

Test Measurement Results DH5								
Test Frequency	Measured Output Power (dBm)				Calculated Total Power (dBm)	Limit	Margin	EUT Power Setting
	Port(s)							
MHz	a	b	c	d	Σ Port(s)	dBm	dBm	
2402 (CH0)	-0.94	--	--	--	-0.94	30	-30.94	Max
2441 (CH39)	-2.7	--	--	--	-2.7	30	-32.7	Max
2480 (CH78)	-5.33	--	--	--	-5.33	30	-35.33	Max

Traceability to Industry Recognized Test Methodologies	
Work Instruction:	WI-01 MEASURING RF OUTPUT POWER
Measurement Uncertainty:	±1.33 dB

This test report may be reproduced in full only. The document may only be updated by MiCOM Labs personnel. Any changes will be noted in the Document History section of the report.



Title: Ear Force Z300 RX Wireless Audio Headset
To: FCC 47 CFR Part 15.247 & IC RSS-210
Serial #: COMM39-U2 Rev A
Issue Date: 25th July 2013
Page: 75 of 145

Peak Power, Channel 0, DH1 Packet Type

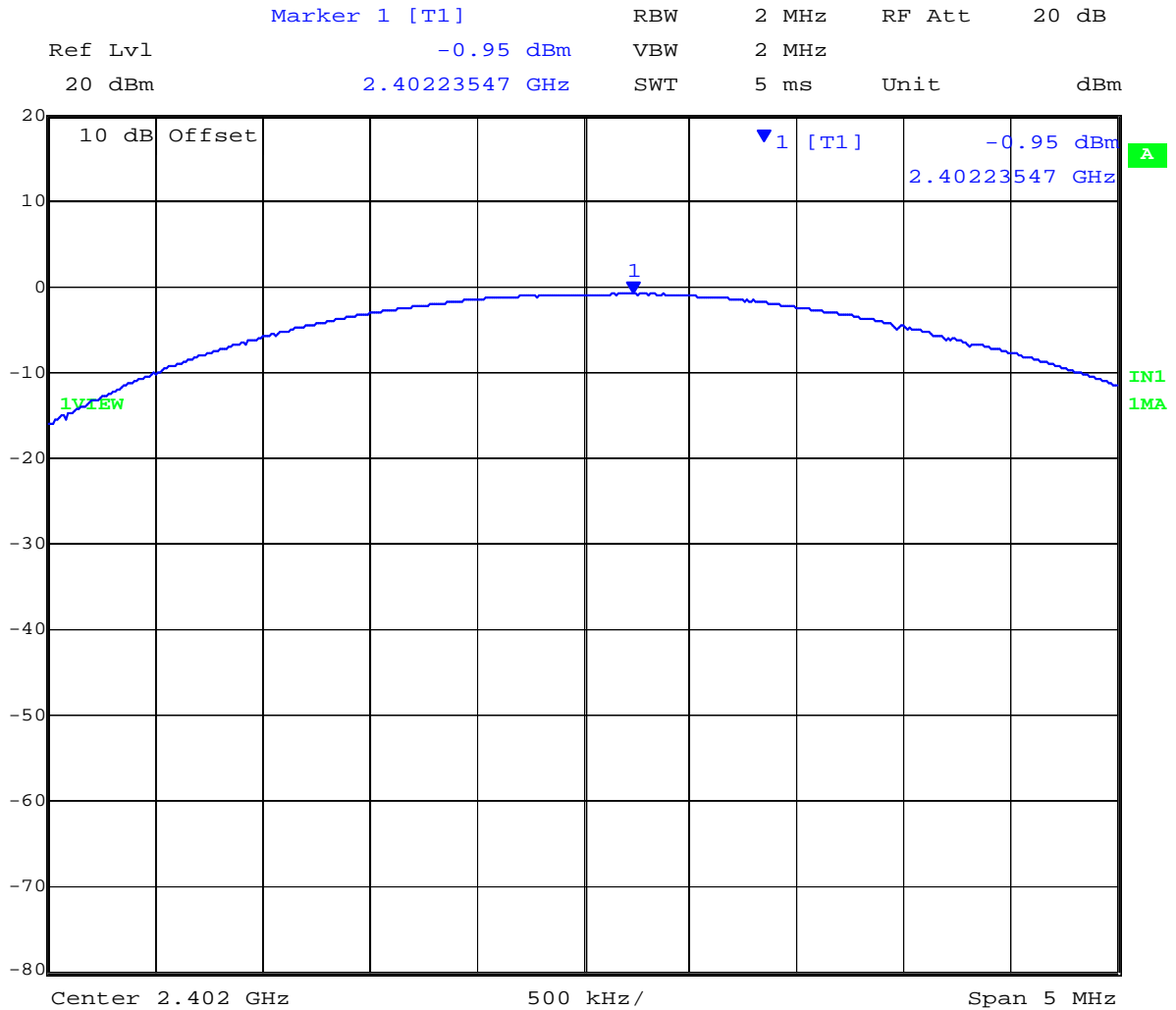

Date: 17.JAN.2013 11:42:39

This test report may be reproduced in full only. The document may only be updated by MiCOM Labs personnel. Any changes will be noted in the Document History section of the report.



Title: Ear Force Z300 RX Wireless Audio Headset
To: FCC 47 CFR Part 15.247 & IC RSS-210
Serial #: COMM39-U2 Rev A
Issue Date: 25th July 2013
Page: 76 of 145

Peak Power, Channel 39, DH1 Packet Type

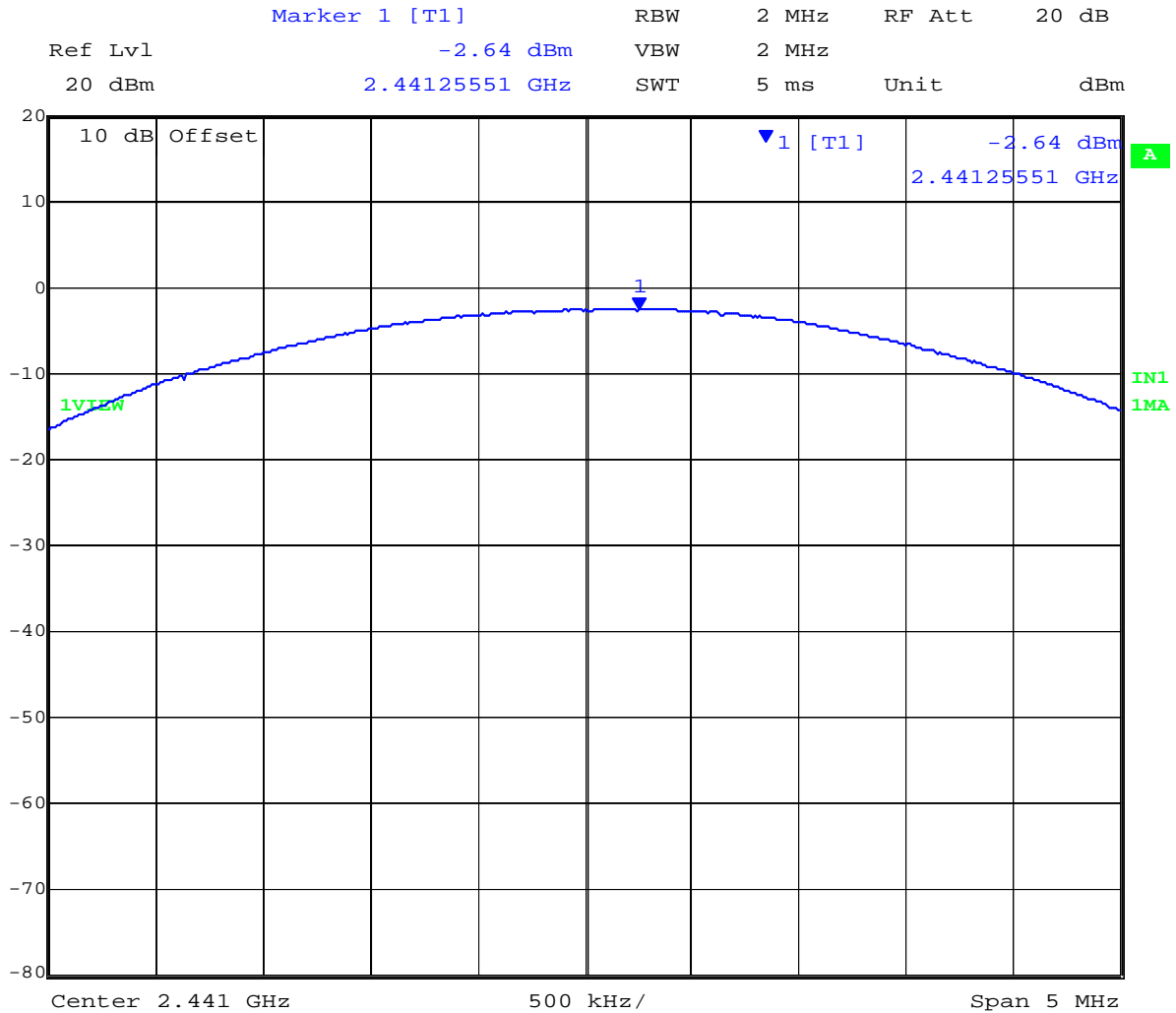

Date: 17.JAN.2013 11:53:22

This test report may be reproduced in full only. The document may only be updated by MiCOM Labs personnel. Any changes will be noted in the Document History section of the report.



Title: Ear Force Z300 RX Wireless Audio Headset
To: FCC 47 CFR Part 15.247 & IC RSS-210
Serial #: COMM39-U2 Rev A
Issue Date: 25th July 2013
Page: 77 of 145

Peak Power, Channel 78, DH1 Packet Type

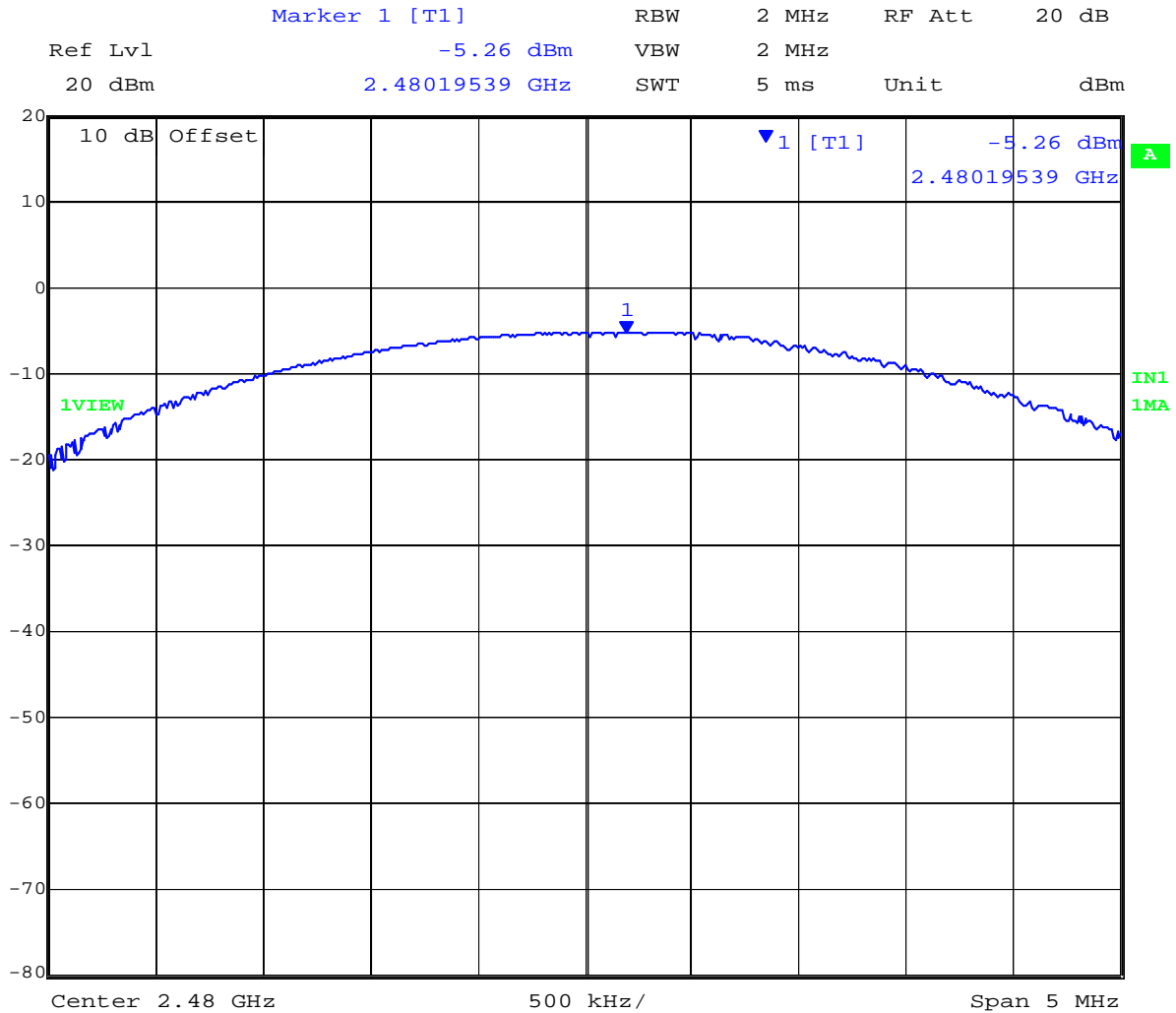

Date: 17.JAN.2013 12:02:18

This test report may be reproduced in full only. The document may only be updated by MiCOM Labs personnel. Any changes will be noted in the Document History section of the report.



Title: Ear Force Z300 RX Wireless Audio Headset
To: FCC 47 CFR Part 15.247 & IC RSS-210
Serial #: COMM39-U2 Rev A
Issue Date: 25th July 2013
Page: 78 of 145

Peak Power, Channel 0, DH3 Packet Type

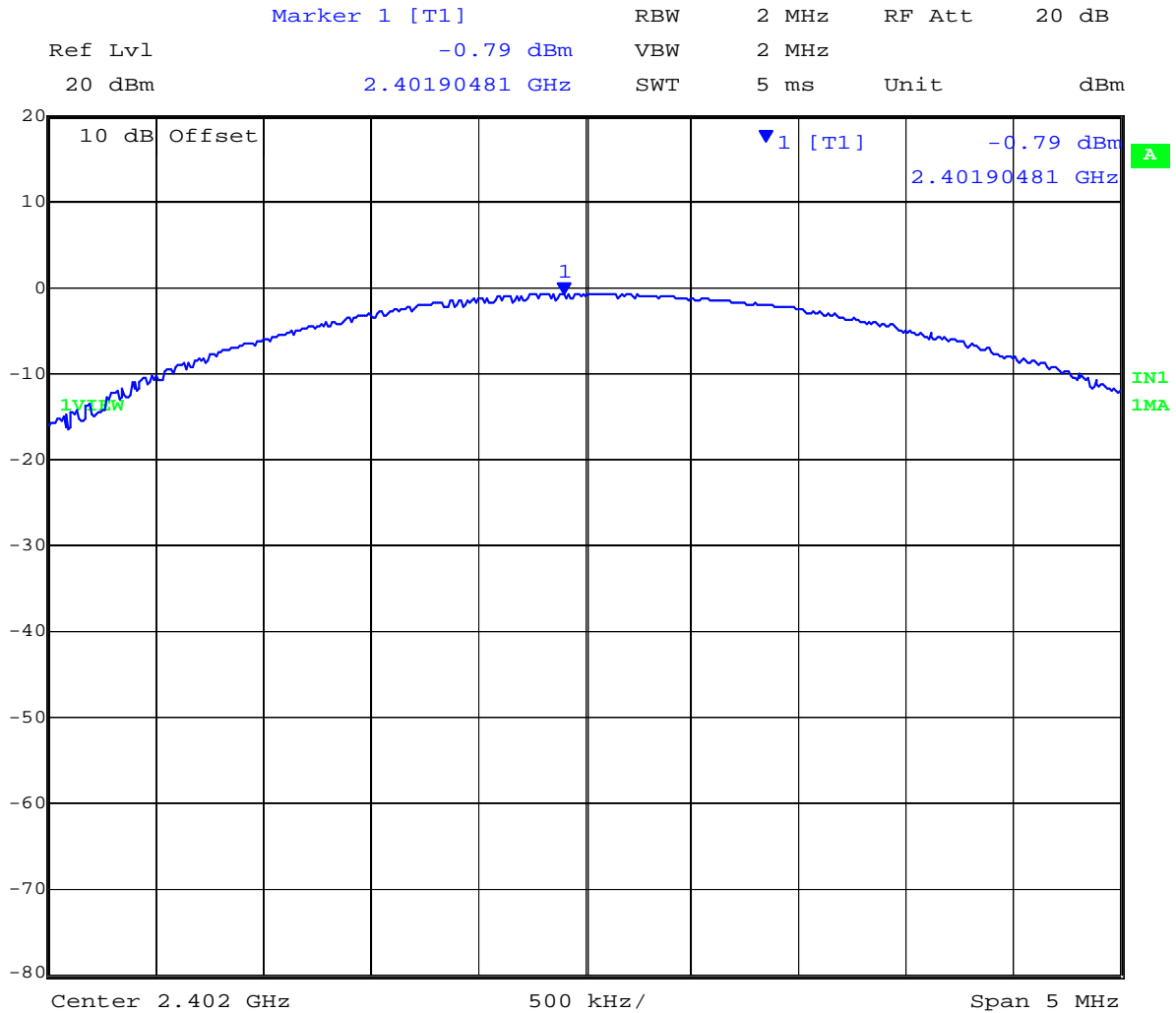

Date: 17.JAN.2013 11:46:38

This test report may be reproduced in full only. The document may only be updated by MiCOM Labs personnel. Any changes will be noted in the Document History section of the report.



Title: Ear Force Z300 RX Wireless Audio Headset
To: FCC 47 CFR Part 15.247 & IC RSS-210
Serial #: COMM39-U2 Rev A
Issue Date: 25th July 2013
Page: 79 of 145

Peak Power, Channel 39, DH3 Packet Type

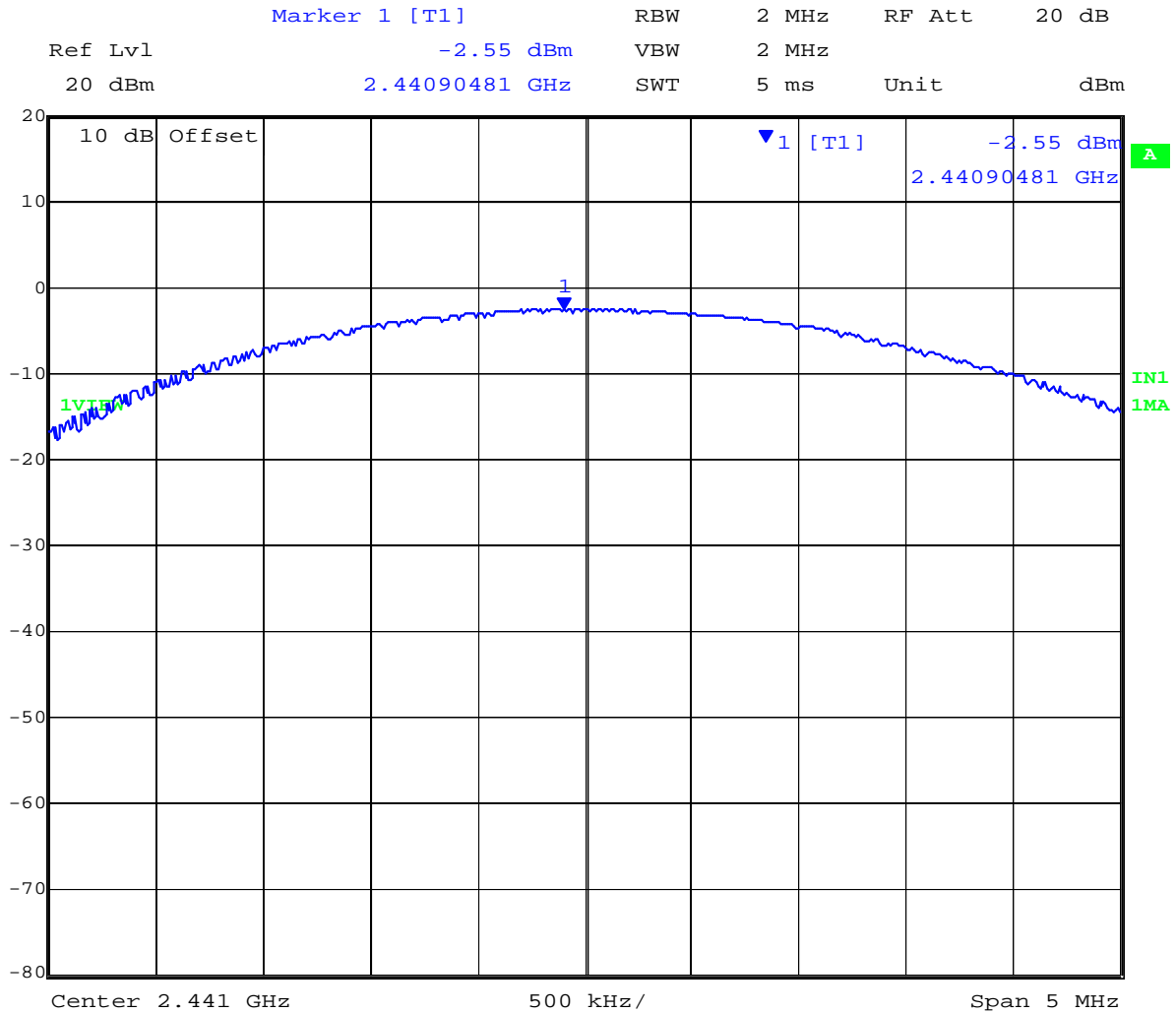

Date: 17.JAN.2013 11:57:12

This test report may be reproduced in full only. The document may only be updated by MiCOM Labs personnel. Any changes will be noted in the Document History section of the report.



Title: Ear Force Z300 RX Wireless Audio Headset
To: FCC 47 CFR Part 15.247 & IC RSS-210
Serial #: COMM39-U2 Rev A
Issue Date: 25th July 2013
Page: 80 of 145

Peak Power, Channel 78, DH3 Packet Type

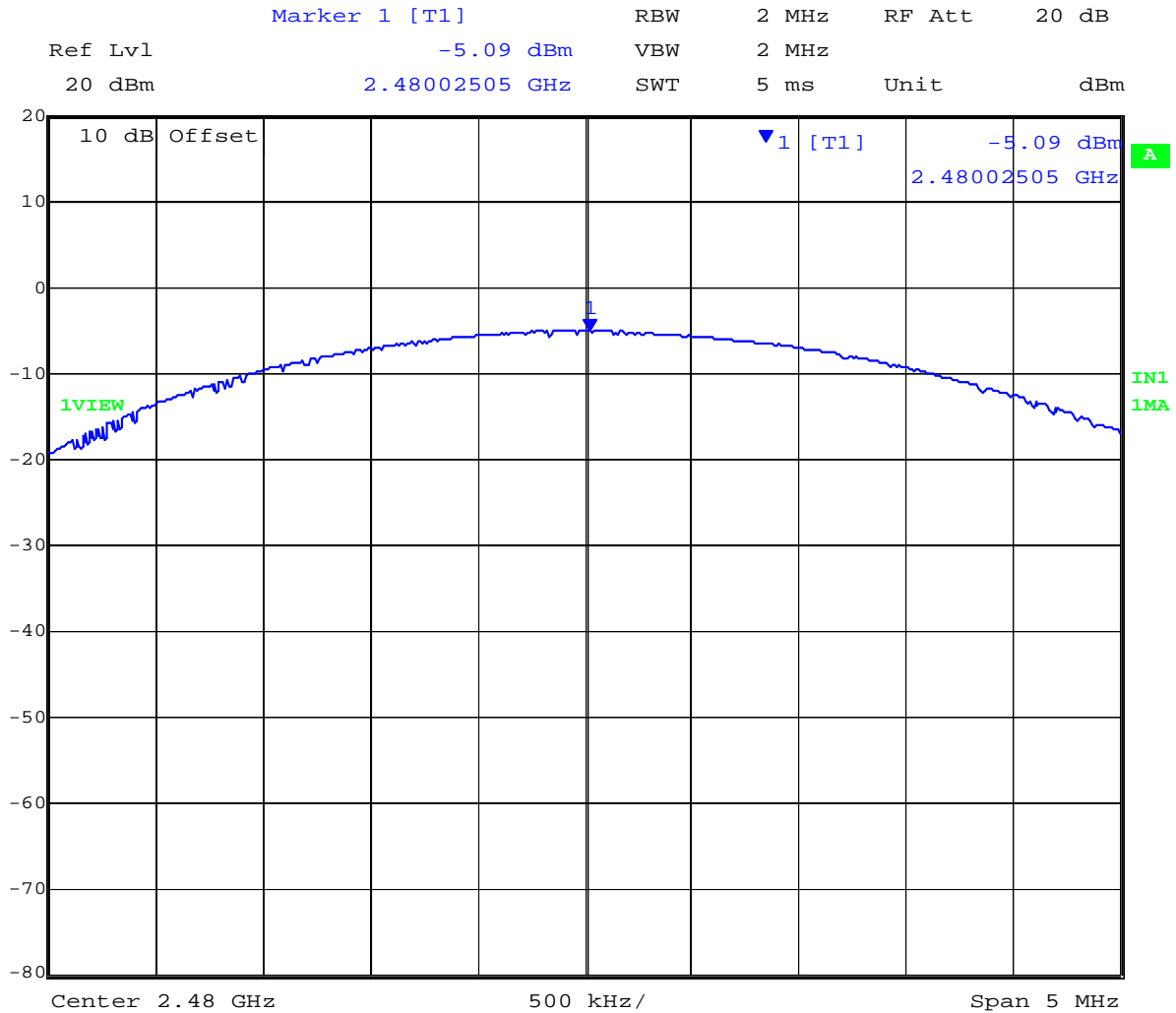

Date: 17.JAN.2013 12:05:30

This test report may be reproduced in full only. The document may only be updated by MiCOM Labs personnel. Any changes will be noted in the Document History section of the report.



Title: Ear Force Z300 RX Wireless Audio Headset
To: FCC 47 CFR Part 15.247 & IC RSS-210
Serial #: COMM39-U2 Rev A
Issue Date: 25th July 2013
Page: 81 of 145

Peak Power, Channel 0, DH5 Packet Type

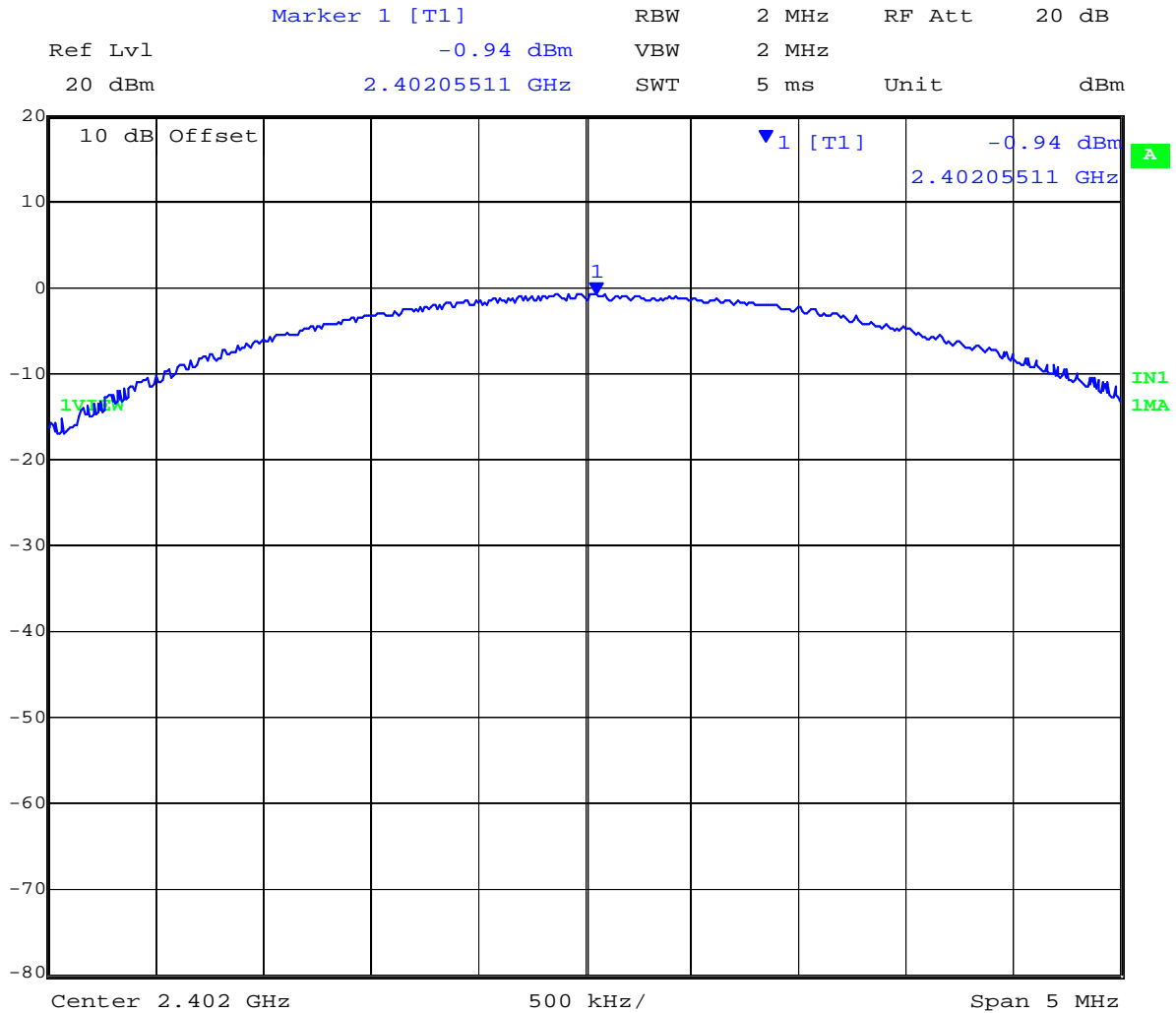

Date: 17.JAN.2013 11:49:19

This test report may be reproduced in full only. The document may only be updated by MiCOM Labs personnel. Any changes will be noted in the Document History section of the report.



Title: Ear Force Z300 RX Wireless Audio Headset
To: FCC 47 CFR Part 15.247 & IC RSS-210
Serial #: COMM39-U2 Rev A
Issue Date: 25th July 2013
Page: 82 of 145

Peak Power, Channel 39, DH5 Packet Type

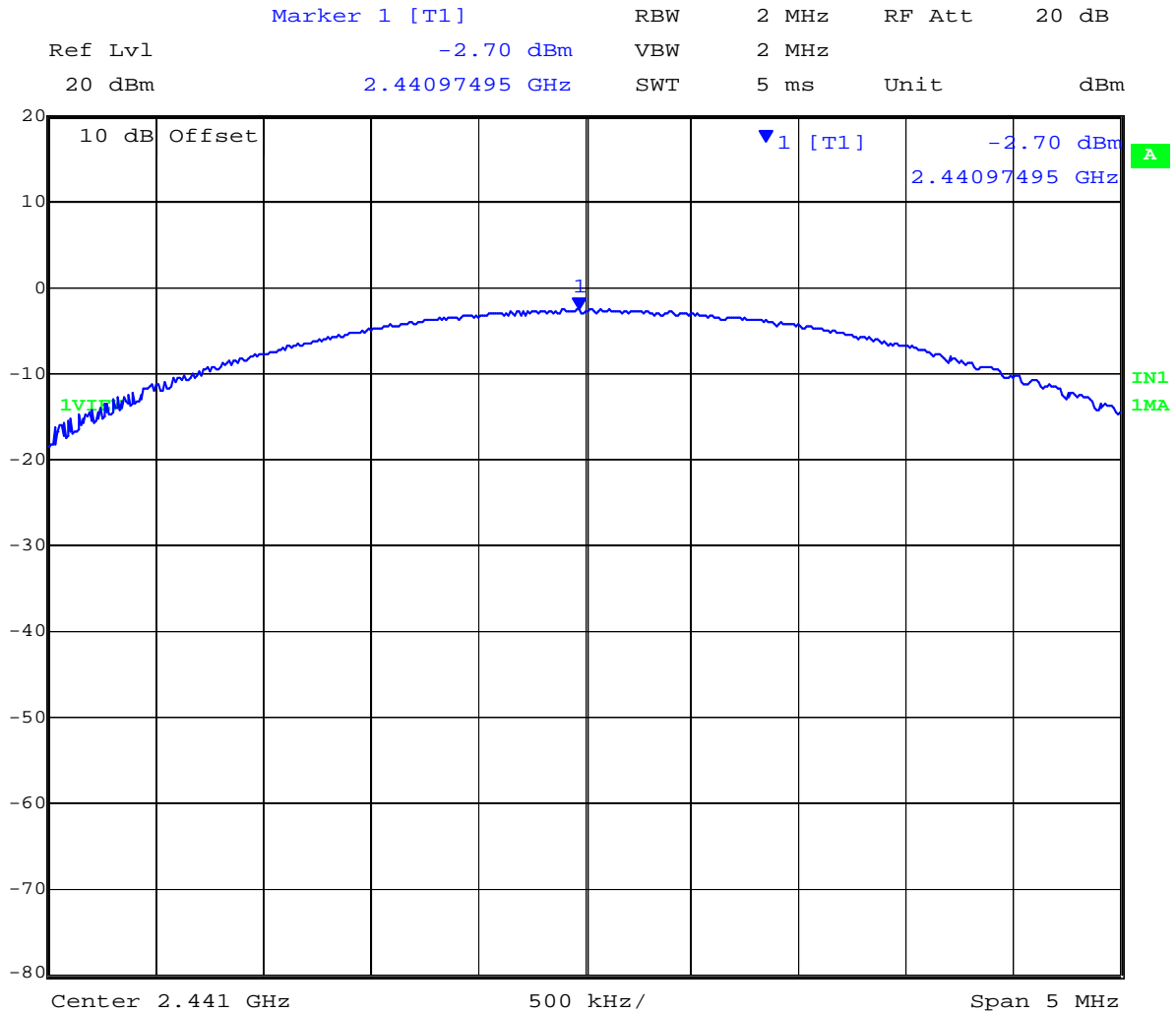

Date: 17.JAN.2013 11:59:34

This test report may be reproduced in full only. The document may only be updated by MiCOM Labs personnel. Any changes will be noted in the Document History section of the report.



Title: Ear Force Z300 RX Wireless Audio Headset
To: FCC 47 CFR Part 15.247 & IC RSS-210
Serial #: COMM39-U2 Rev A
Issue Date: 25th July 2013
Page: 83 of 145

Peak Power, Channel 78, DH5 Packet Type

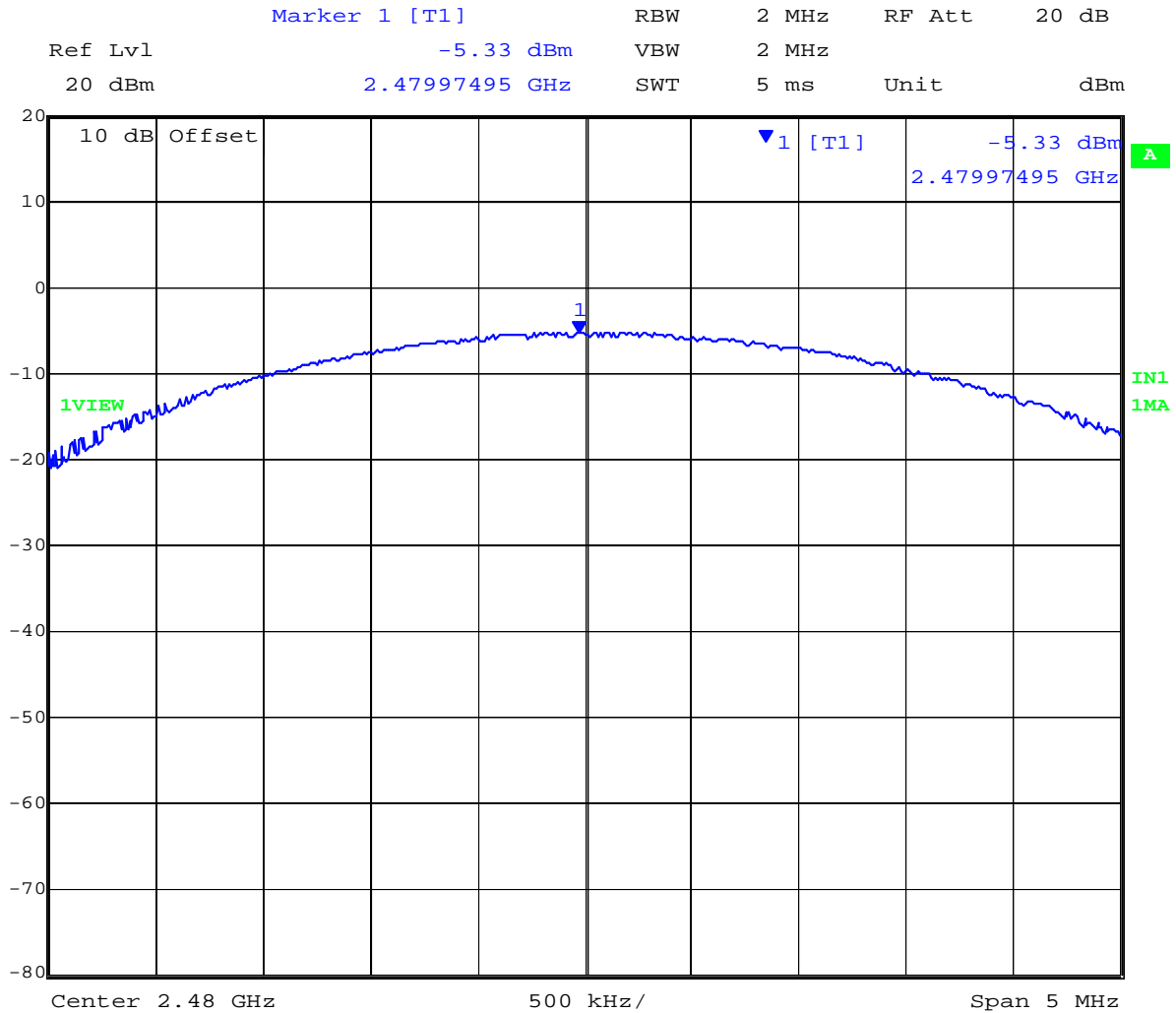

Date: 17.JAN.2013 12:07:47

This test report may be reproduced in full only. The document may only be updated by MiCOM Labs personnel. Any changes will be noted in the Document History section of the report.



Title: Ear Force Z300 RX Wireless Audio Headset
To: FCC 47 CFR Part 15.247 & IC RSS-210
Serial #: COMM39-U2 Rev A
Issue Date: 25th July 2013
Page: 84 of 145

3 Mbs:

Test Measurement Results DH1								
Test Frequency	Measured Output Power (dBm)				Calculated Total Power (dBm)	Limit	Margin	EUT Power Setting
	Port(s)							
MHz	a	b	c	d	Σ Port(s)	dBm	dBm	
2402 (CH0)	-1.05	--	--	--	-1.05	30	-31.05	Max
2441 (CH39)	-2.75	--	--	--	-2.75	30	-32.75	Max
2480 (CH78)	-5.36	--	--	--	-5.36	30	-35.36	Max

Test Measurement Results DH3								
Test Frequency	Measured Output Power (dBm)				Calculated Total Power (dBm)	Limit	Margin	EUT Power Setting
	Port(s)							
MHz	a	b	c	d	Σ Port(s)	dBm	dBm	
2402 (CH0)	-1.02	--	--	--	-1.02	30	-31.02	Max
2441 (CH39)	-2.82	--	--	--	-2.82	30	-32.82	Max
2480 (CH78)	-5.44	--	--	--	-5.44	30	-35.44	Max

Test Measurement Results DH5								
Test Frequency	Measured Output Power (dBm)				Calculated Total Power (dBm)	Limit	Margin	EUT Power Setting
	Port(s)							
MHz	a	b	c	d	Σ Port(s)	dBm	dBm	
2402 (CH0)	-0.91	--	--	--	-0.91	30	-30.91	Max
2441 (CH39)	-2.59	--	--	--	-2.59	30	-32.59	Max
2480 (CH78)	-5.19	--	--	--	-5.19	30	-35.19	Max

Traceability to Industry Recognized Test Methodologies	
Work Instruction:	WI-01 MEASURING RF OUTPUT POWER
Measurement Uncertainty:	±1.33 dB

This test report may be reproduced in full only. The document may only be updated by MiCOM Labs personnel. Any changes will be noted in the Document History section of the report.



Title: Ear Force Z300 RX Wireless Audio Headset
To: FCC 47 CFR Part 15.247 & IC RSS-210
Serial #: COMM39-U2 Rev A
Issue Date: 25th July 2013
Page: 85 of 145

Peak Power, Channel 0, DH1 Packet Type

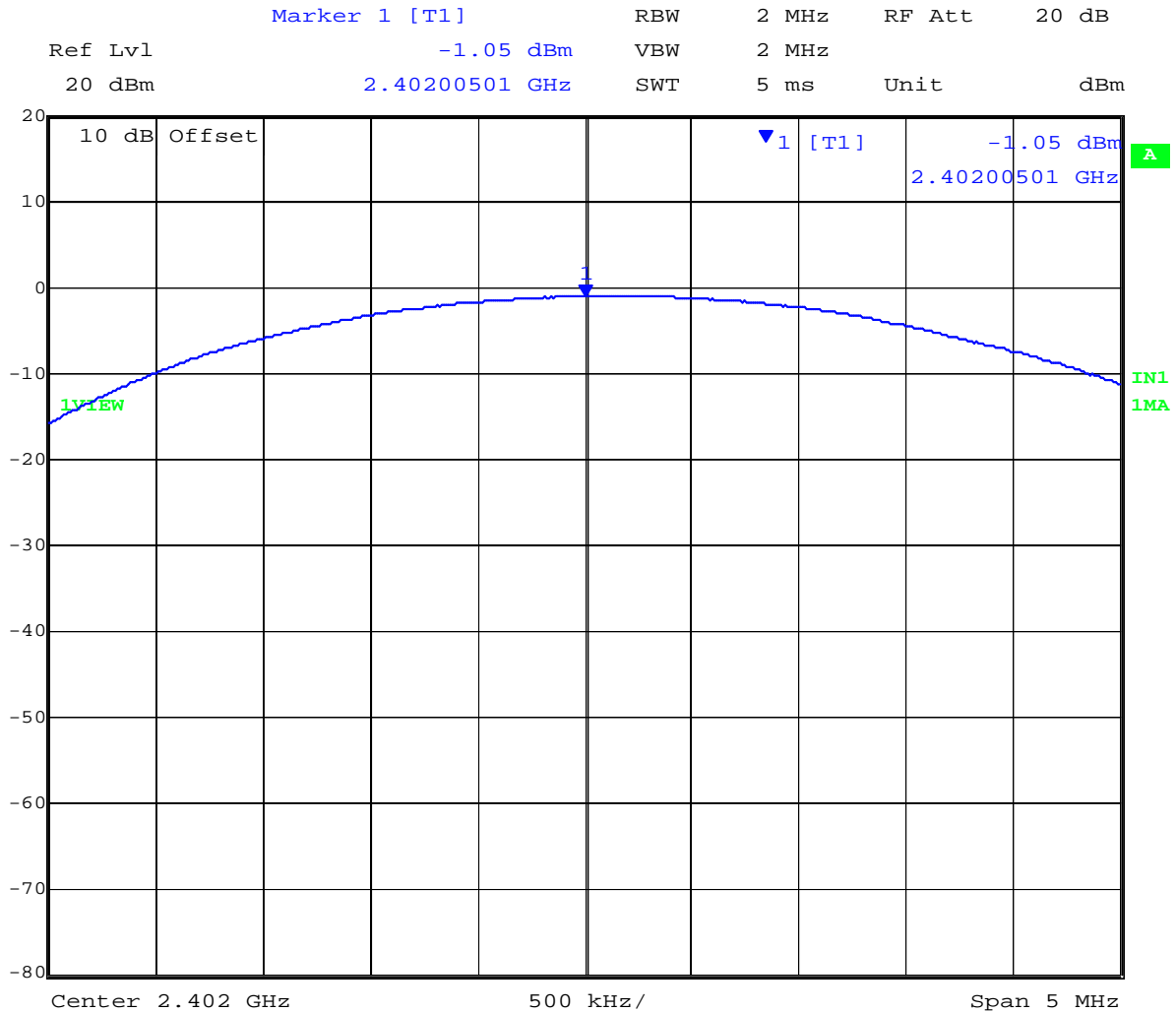

Date: 17.JAN.2013 11:44:19

This test report may be reproduced in full only. The document may only be updated by MiCOM Labs personnel. Any changes will be noted in the Document History section of the report.



Title: Ear Force Z300 RX Wireless Audio Headset
To: FCC 47 CFR Part 15.247 & IC RSS-210
Serial #: COMM39-U2 Rev A
Issue Date: 25th July 2013
Page: 86 of 145

Peak Power, Channel 39, DH1 Packet Type

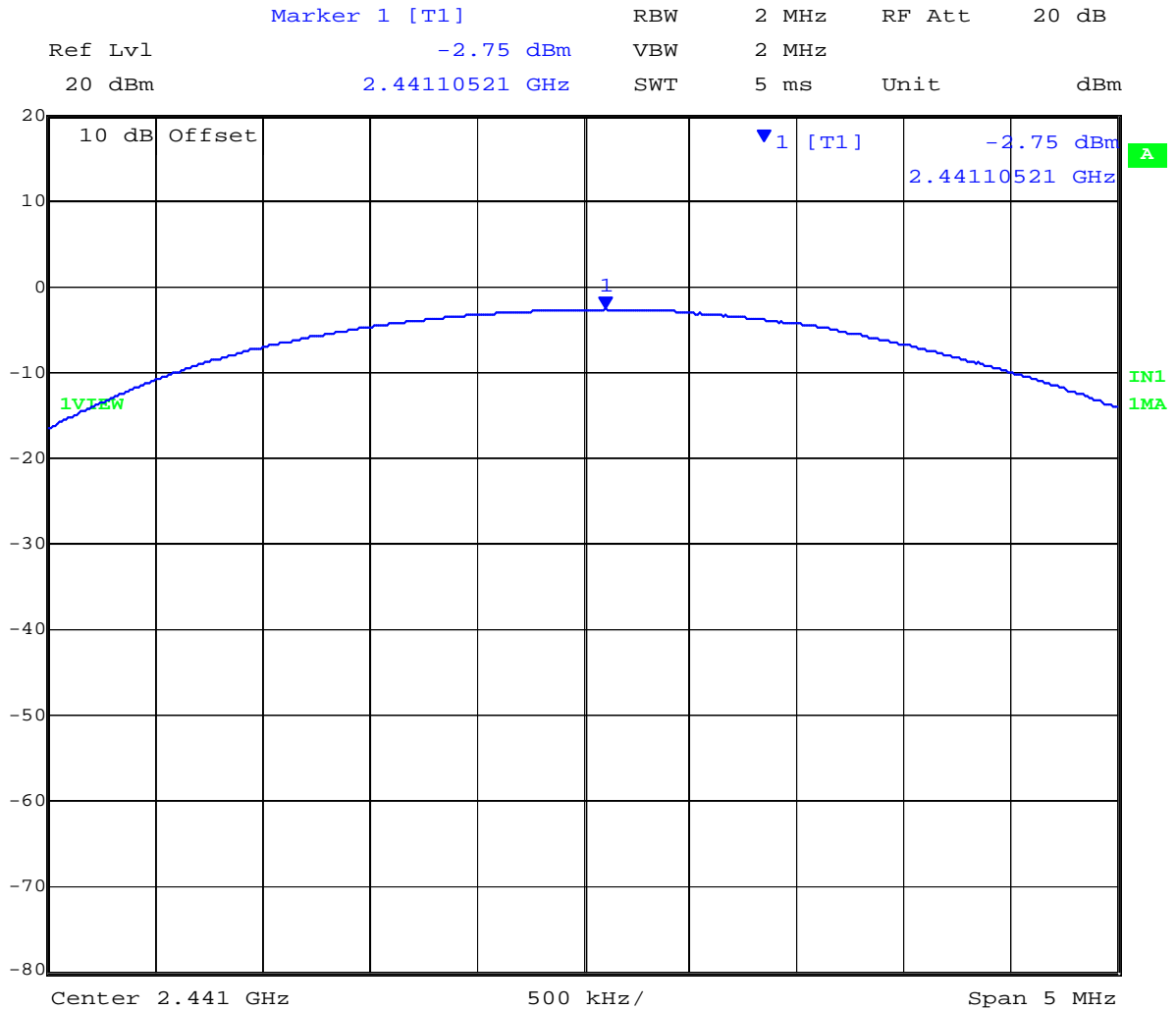

Date: 17.JAN.2013 11:54:20

This test report may be reproduced in full only. The document may only be updated by MiCOM Labs personnel. Any changes will be noted in the Document History section of the report.



Title: Ear Force Z300 RX Wireless Audio Headset
To: FCC 47 CFR Part 15.247 & IC RSS-210
Serial #: COMM39-U2 Rev A
Issue Date: 25th July 2013
Page: 87 of 145

Peak Power, Channel 78, DH1 Packet Type

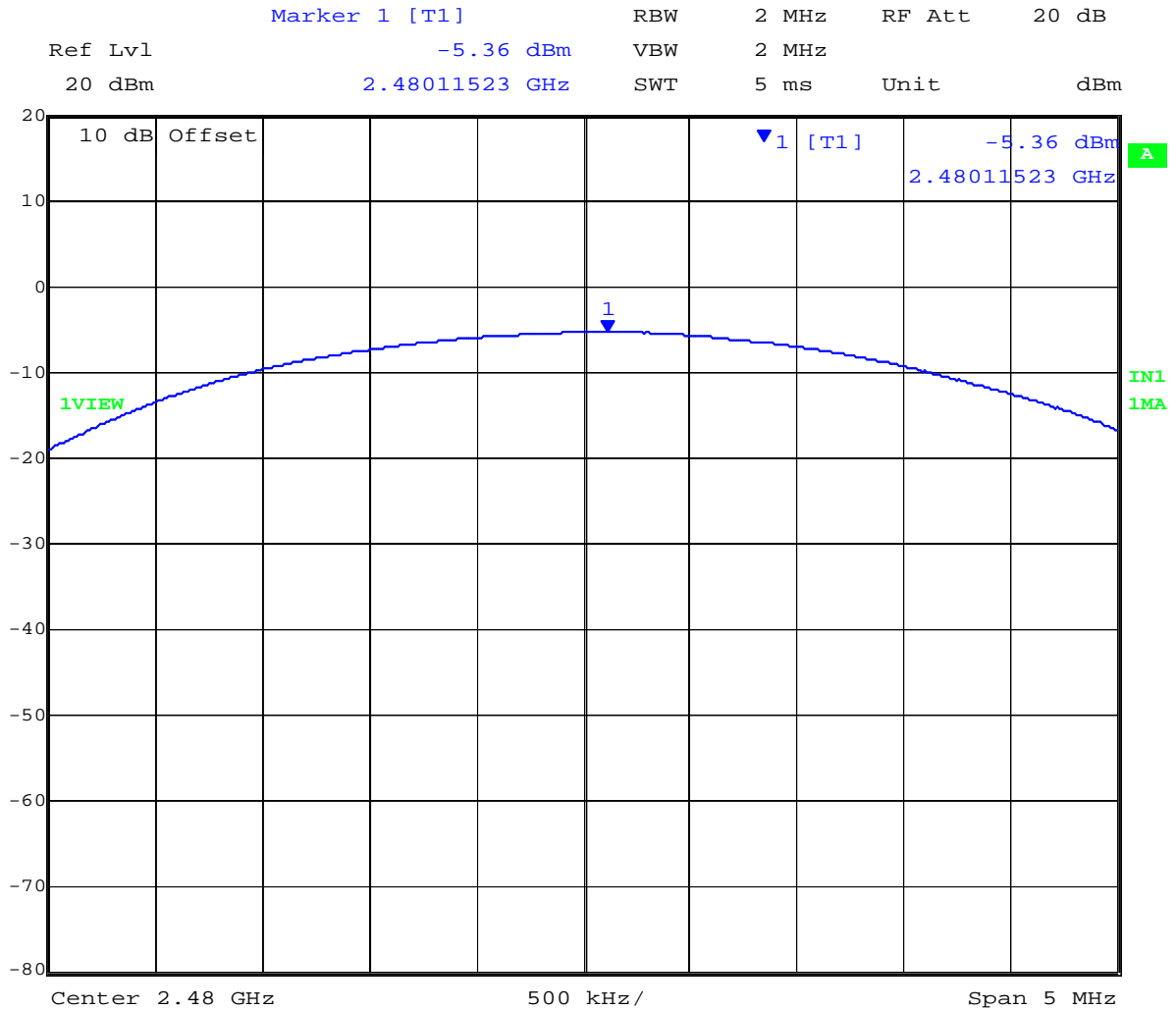

Date: 17.JAN.2013 12:03:46

This test report may be reproduced in full only. The document may only be updated by MiCOM Labs personnel. Any changes will be noted in the Document History section of the report.



Title: Ear Force Z300 RX Wireless Audio Headset
To: FCC 47 CFR Part 15.247 & IC RSS-210
Serial #: COMM39-U2 Rev A
Issue Date: 25th July 2013
Page: 88 of 145

Peak Power, Channel 0, DH3 Packet Type

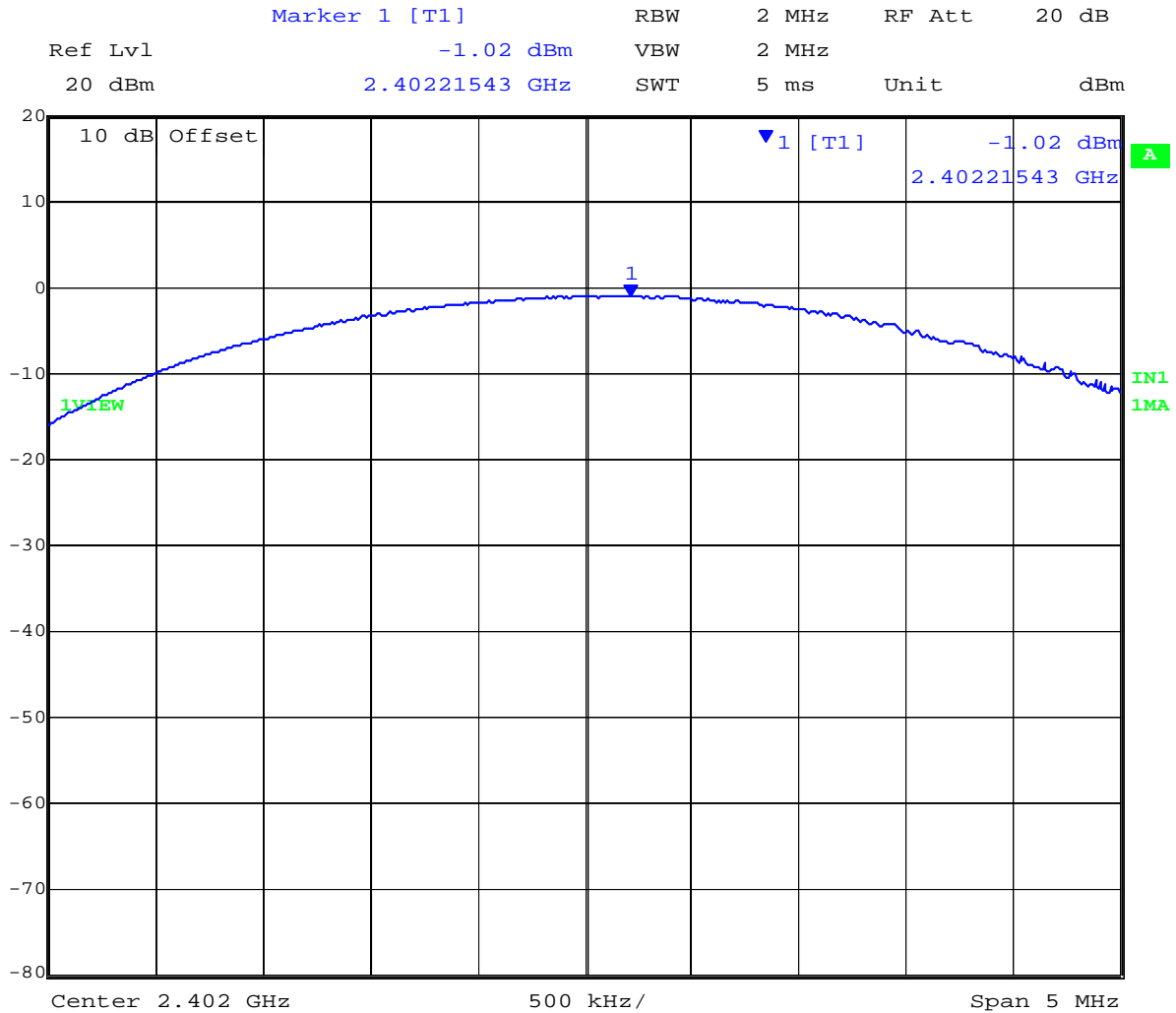

Date: 17.JAN.2013 11:47:36

This test report may be reproduced in full only. The document may only be updated by MiCOM Labs personnel. Any changes will be noted in the Document History section of the report.



Title: Ear Force Z300 RX Wireless Audio Headset
To: FCC 47 CFR Part 15.247 & IC RSS-210
Serial #: COMM39-U2 Rev A
Issue Date: 25th July 2013
Page: 89 of 145

Peak Power, Channel 39, DH3 Packet Type

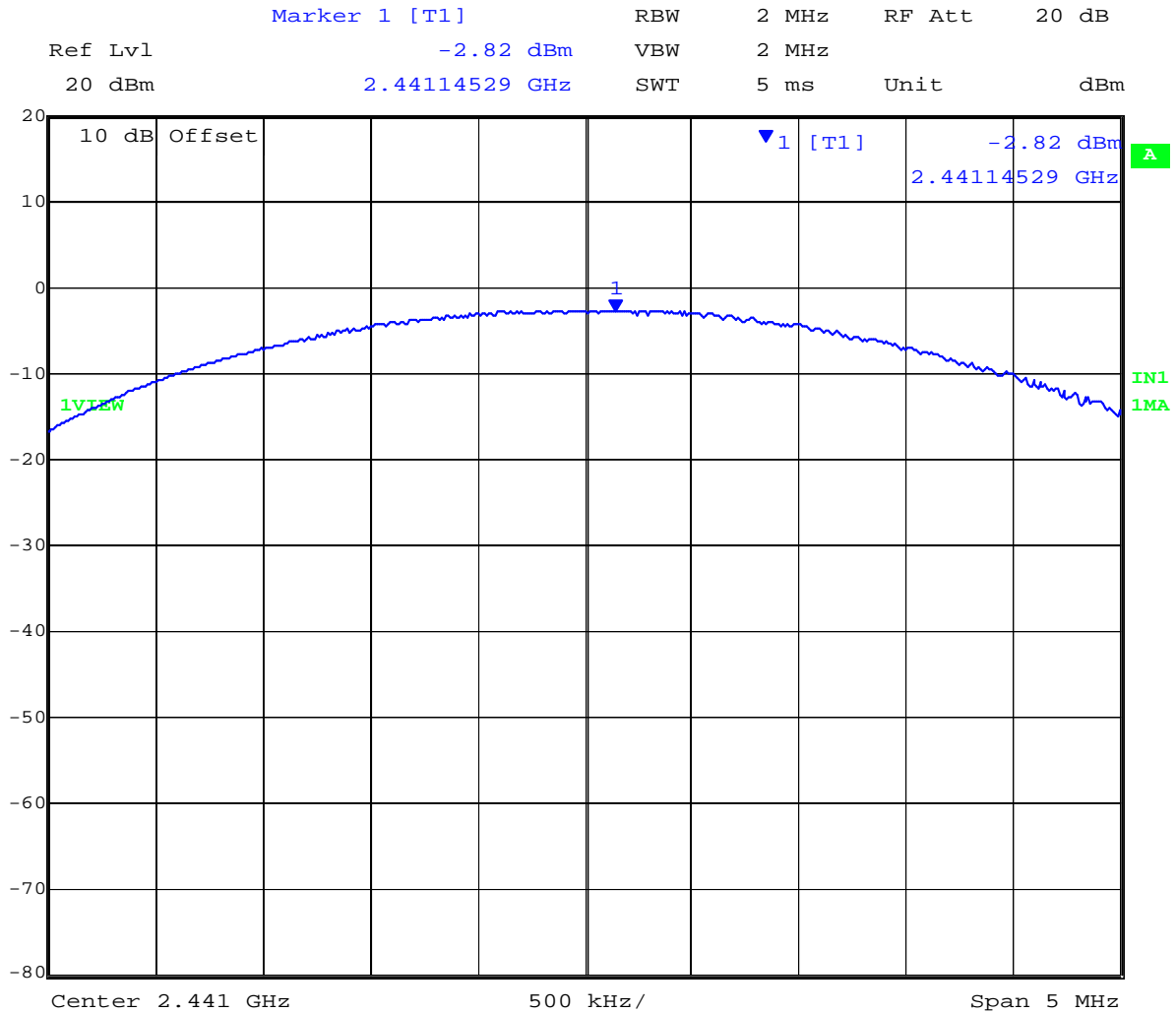

Date: 17.JAN.2013 11:57:50

This test report may be reproduced in full only. The document may only be updated by MiCOM Labs personnel. Any changes will be noted in the Document History section of the report.



Title: Ear Force Z300 RX Wireless Audio Headset
To: FCC 47 CFR Part 15.247 & IC RSS-210
Serial #: COMM39-U2 Rev A
Issue Date: 25th July 2013
Page: 90 of 145

Peak Power, Channel 78, DH3 Packet Type

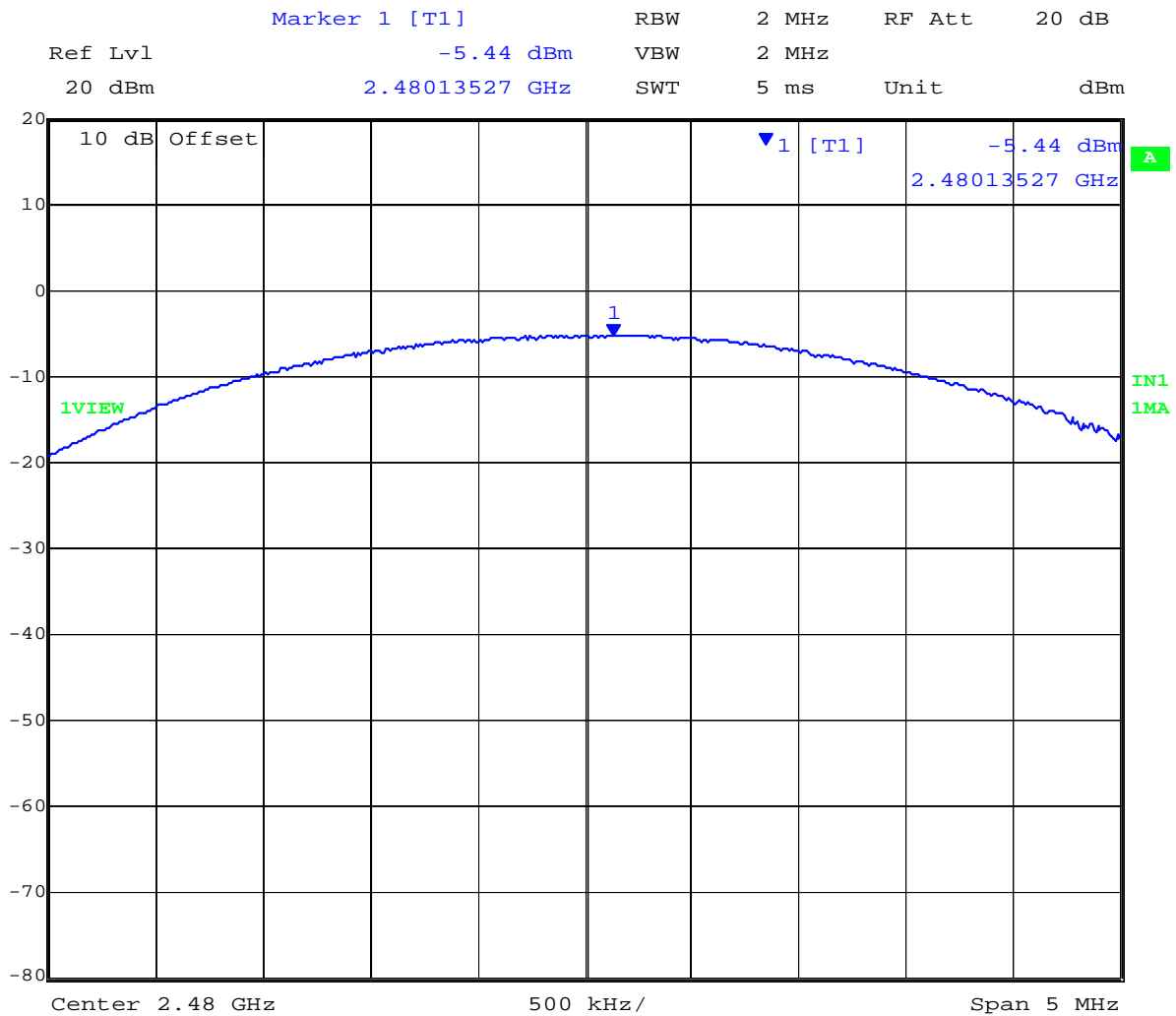

Date: 17.JAN.2013 12:06:19

This test report may be reproduced in full only. The document may only be updated by MiCOM Labs personnel. Any changes will be noted in the Document History section of the report.



Title: Ear Force Z300 RX Wireless Audio Headset
To: FCC 47 CFR Part 15.247 & IC RSS-210
Serial #: COMM39-U2 Rev A
Issue Date: 25th July 2013
Page: 91 of 145

Peak Power, Channel 0, DH5 Packet Type

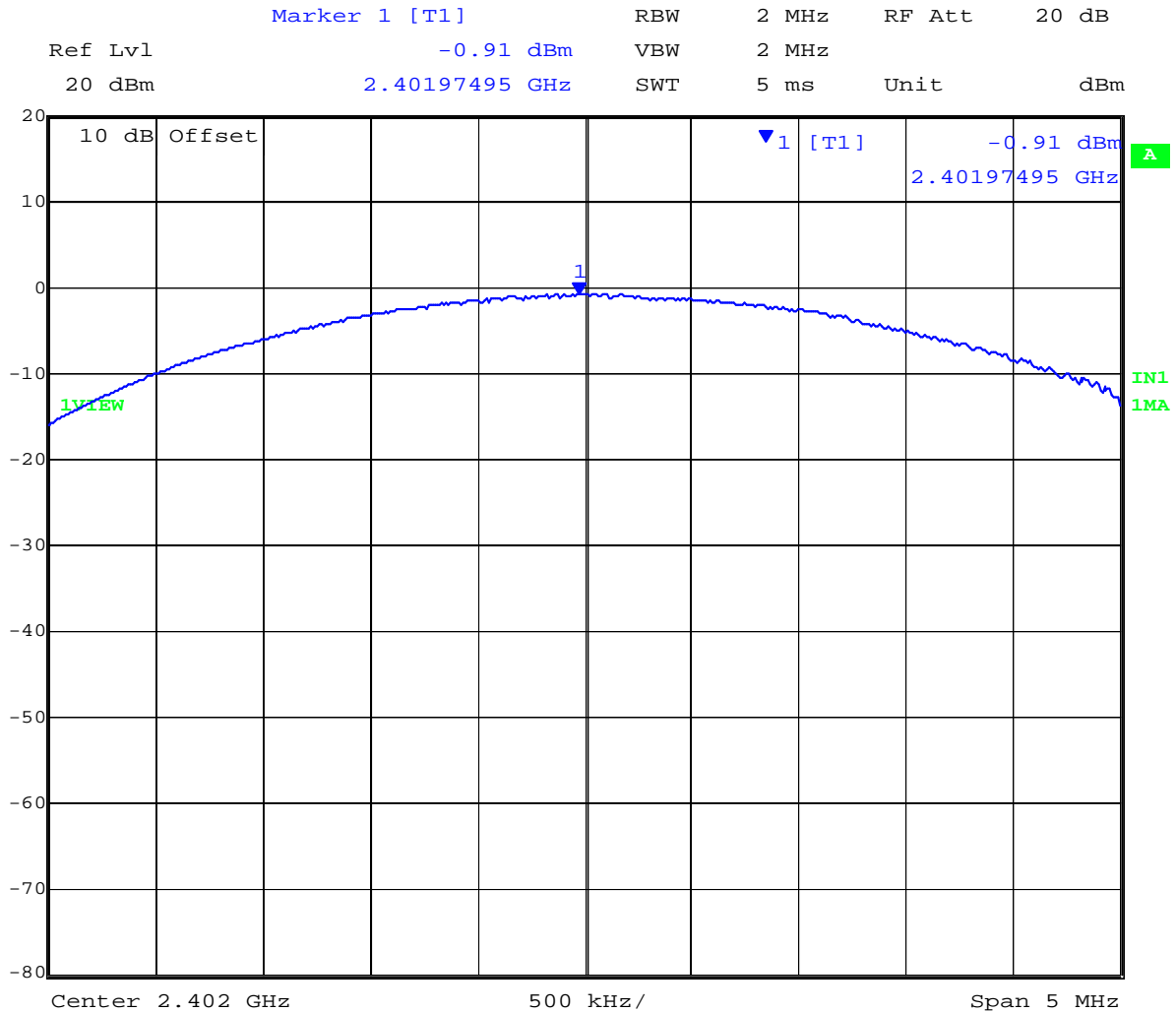

Date: 17.JAN.2013 11:50:16

This test report may be reproduced in full only. The document may only be updated by MiCOM Labs personnel. Any changes will be noted in the Document History section of the report.



Title: Ear Force Z300 RX Wireless Audio Headset
To: FCC 47 CFR Part 15.247 & IC RSS-210
Serial #: COMM39-U2 Rev A
Issue Date: 25th July 2013
Page: 92 of 145

Peak Power, Channel 39, DH5 Packet Type

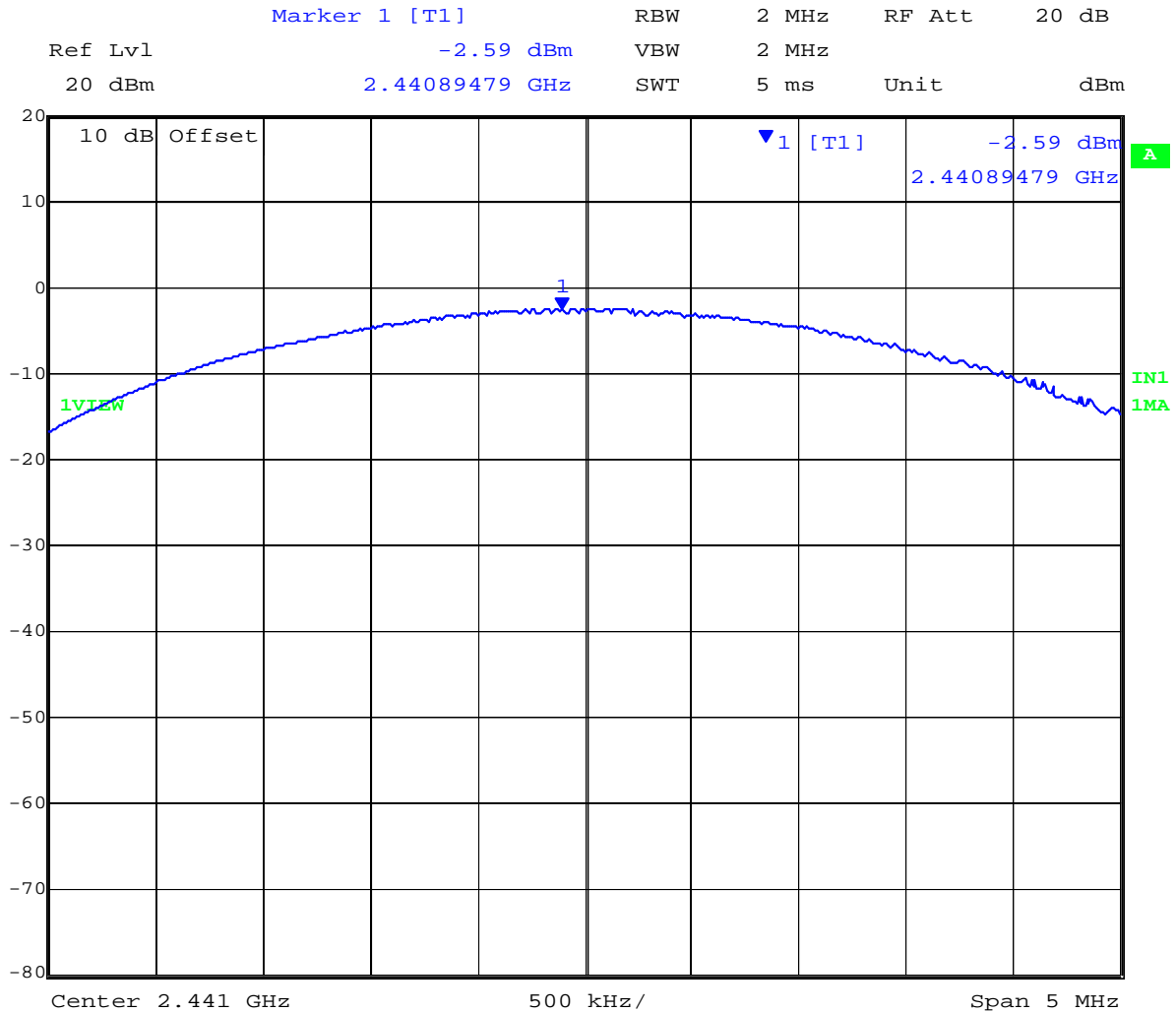

Date: 17.JAN.2013 12:00:15

This test report may be reproduced in full only. The document may only be updated by MiCOM Labs personnel. Any changes will be noted in the Document History section of the report.



Title: Ear Force Z300 RX Wireless Audio Headset
To: FCC 47 CFR Part 15.247 & IC RSS-210
Serial #: COMM39-U2 Rev A
Issue Date: 25th July 2013
Page: 93 of 145

Peak Power, Channel 78, DH5 Packet Type

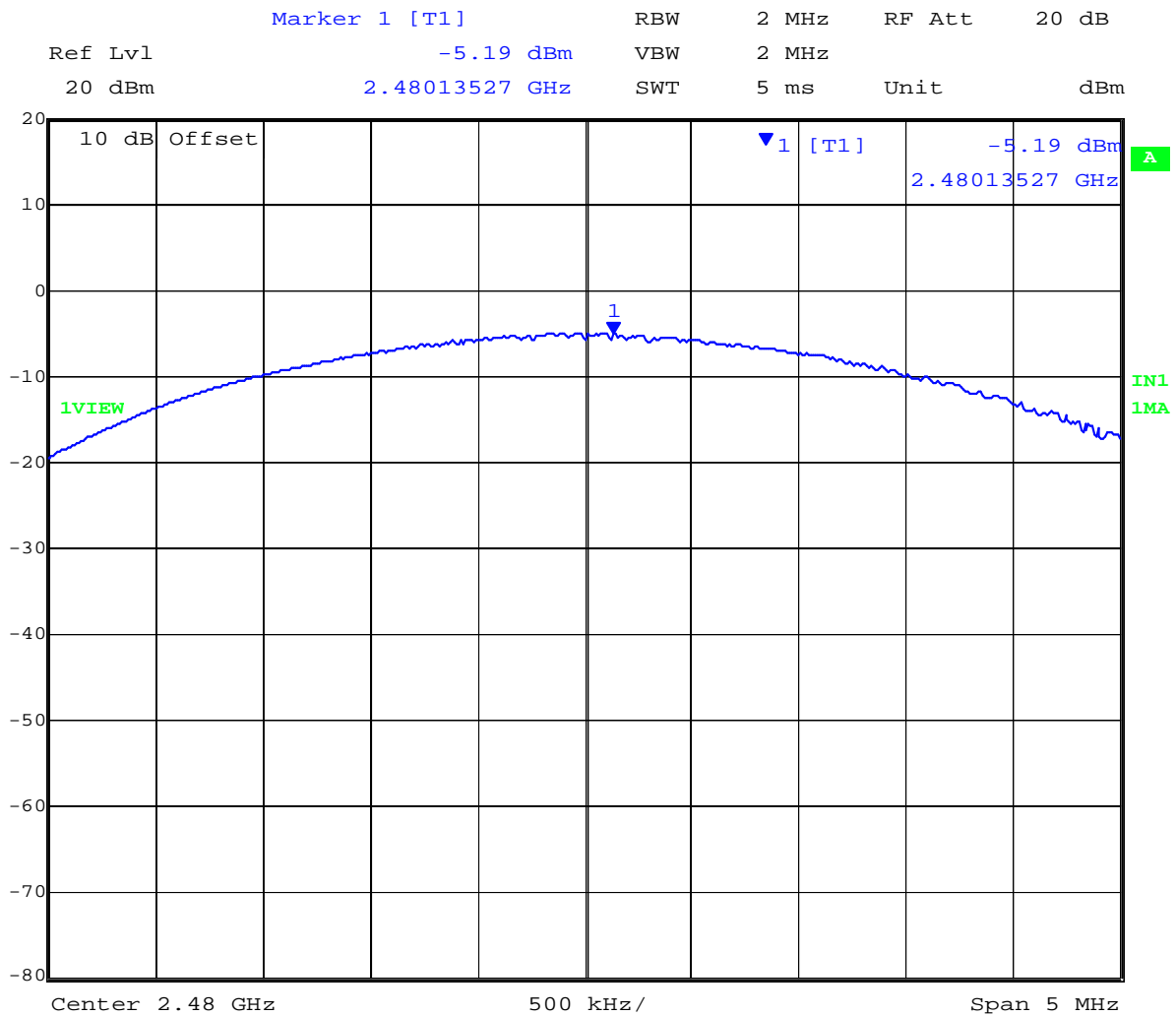

Date: 17.JAN.2013 12:08:26

This test report may be reproduced in full only. The document may only be updated by MiCOM Labs personnel. Any changes will be noted in the Document History section of the report.



Title: Ear Force Z300 RX Wireless Audio Headset
To: FCC 47 CFR Part 15.247 & IC RSS-210
Serial #: COMM39-U2 Rev A
Issue Date: 25th July 2013
Page: 94 of 145

Specification Limits

§15.247 (b)(1)

(b) The maximum peakconducted output power of the intentional radiator shall not exceed the following.

(1) For frequency hopping systems in the 2400 – 2483.5 MHz band employing at least 75 non-overlapping hopping channels, and all frequency hopping systems in the 5725-5850 MHz band: 1 watt. For all other frequency hopping systems in the 2400 – 2483.5 MHz band: 0.125 watts.

§ RSS-210 A8.4(2) For frequency hopping systems operating in the 2400-2483.5 MHz and employing at least 75 hopping channels, the maximum peak conducted power shall not exceed 1 W; for all other frequency hopping systems in the band, the maximum peak conducted power shall not exceed 0.125 W. Except as provided in Section A8.4 (5), the e.i.r.p. shall not exceed 4 W.

Frequency hopping systems operating in the band 2400 – 2483.5 MHz may have hopping channel carrier frequencies that are separated by 25 kHz or two-thirds of the -20 dB bandwidth of the hopping channel, whichever is greater, provided that the systems operate with an output power no greater than 0.125 W.

Traceability

Method	Test Equipment Used
FCC DA 00-0705	0158, 0193, 0287, 0252, 0313, 0314, 0070, 0116, 0117

This test report may be reproduced in full only. The document may only be updated by MiCOM Labs personnel. Any changes will be noted in the Document History section of the report.



Title: Ear Force Z300 RX Wireless Audio Headset
To: FCC 47 CFR Part 15.247 & IC RSS-210
Serial #: COMM39-U2 Rev A
Issue Date: 25th July 2013
Page: 95 of 145

6.1.1.7. Spurious RF Conducted Emissions –

Conducted Test Conditions for Transmitter Conducted Spurious and Band-Edge Emissions			
Standard:	FCC CFR 47:15.247	Ambient Temp. (°C):	18.0 - 27.5
Test Heading:	Max Unwanted Emission Levels	Rel. Humidity (%):	32 - 45
Standard Section(s):	15.247 (d)	Pressure (mBars):	999 - 1001
Reference Document(s):	KDB 558074 - D01 DTS Measurement Guidance v01: Section 5.4 Maximum Unwanted Emission Levels		
Test Procedure for Transmitter Conducted Spurious and Band-Edge Emissions Measurement Transmitter Conducted Spurious and Band-Edge emissions were measured at a limit of 20 dB below the highest in-band spectral density measured with a spectrum analyzer connected to the antenna terminal. Measurements were made while EUT was operating in transmit mode of operation at the appropriate centre frequency closest to the band-edge. Emissions were maximized during the measurement and limits derived from the peak spectral power and drawn on each plot.			

This test report may be reproduced in full only. The document may only be updated by MiCOM Labs personnel. Any changes will be noted in the Document History section of the report.



Title: Ear Force Z300 RX Wireless Audio Headset
To: FCC 47 CFR Part 15.247 & IC RSS-210
Serial #: COMM39-U2 Rev A
Issue Date: 25th July 2013
Page: 96 of 145

Equipment Configuration for Transmitter Conducted Spurious and Band-Edge Emissions

Variant:	802.15.2	Duty Cycle (%):	100%
Data Rate:	1-3 Mbit/s	Antenna Gain (dBi):	2.8
Modulation:	GFSK, $\pi/4$ DQPSK, 8DPSK	Beam Forming Gain (Y):	Not Applicable
TPC:	N/A		
Engineering Test Notes:	Smallest and largest packet types checked for each data rate		

Test Measurement Results DH1

Test Frequency	Frequency Range	Transmitter Conducted Spurious Emissions (dBm)							
		Port a		Port b		Port c		Port d	
		SE	Limit	SE	Limit	SE	Limit	SE	Limit
2402.0	30.0 - 26000.0	-48.0	-26.50	--	--	--	--	--	--
2480.0	30.0 - 26000.0	-47.8	-28.3						
Hopping	30.0 - 26000.0	-48.2	-25.00	--	--	--	--	--	--

SE - Maximum spurious emission found

Test Frequency	Band-Edge Frequency	Transmitter Conducted Band-Edge Emissions (dBm)							
		Port a		Port b		Port c		Port d	
		BE	Limit	BE	Limit	BE	Limit	BE	Limit
2402.0	2400.0	-41.07	-22.55	--	--	--	--	--	--
2480.0	2483.5	-46.56	-23.88						

BE - Maximum band-edge emission found

Traceability to Industry Recognized Test Methodologies

Work Instruction:	WI-05 MEASUREMENT OF SPURIOUS EMISSIONS
Measurement Uncertainty:	= 40 GHz ± 2.37 dB, > 40 GHz ± 4.6 dB

This test report may be reproduced in full only. The document may only be updated by MiCOM Labs personnel. Any changes will be noted in the Document History section of the report.



Title: Ear Force Z300 RX Wireless Audio Headset
To: FCC 47 CFR Part 15.247 & IC RSS-210
Serial #: COMM39-U2 Rev A
Issue Date: 25th July 2013
Page: 97 of 145

Test Results Transmitter Conducted Spurious Emissions CH0:

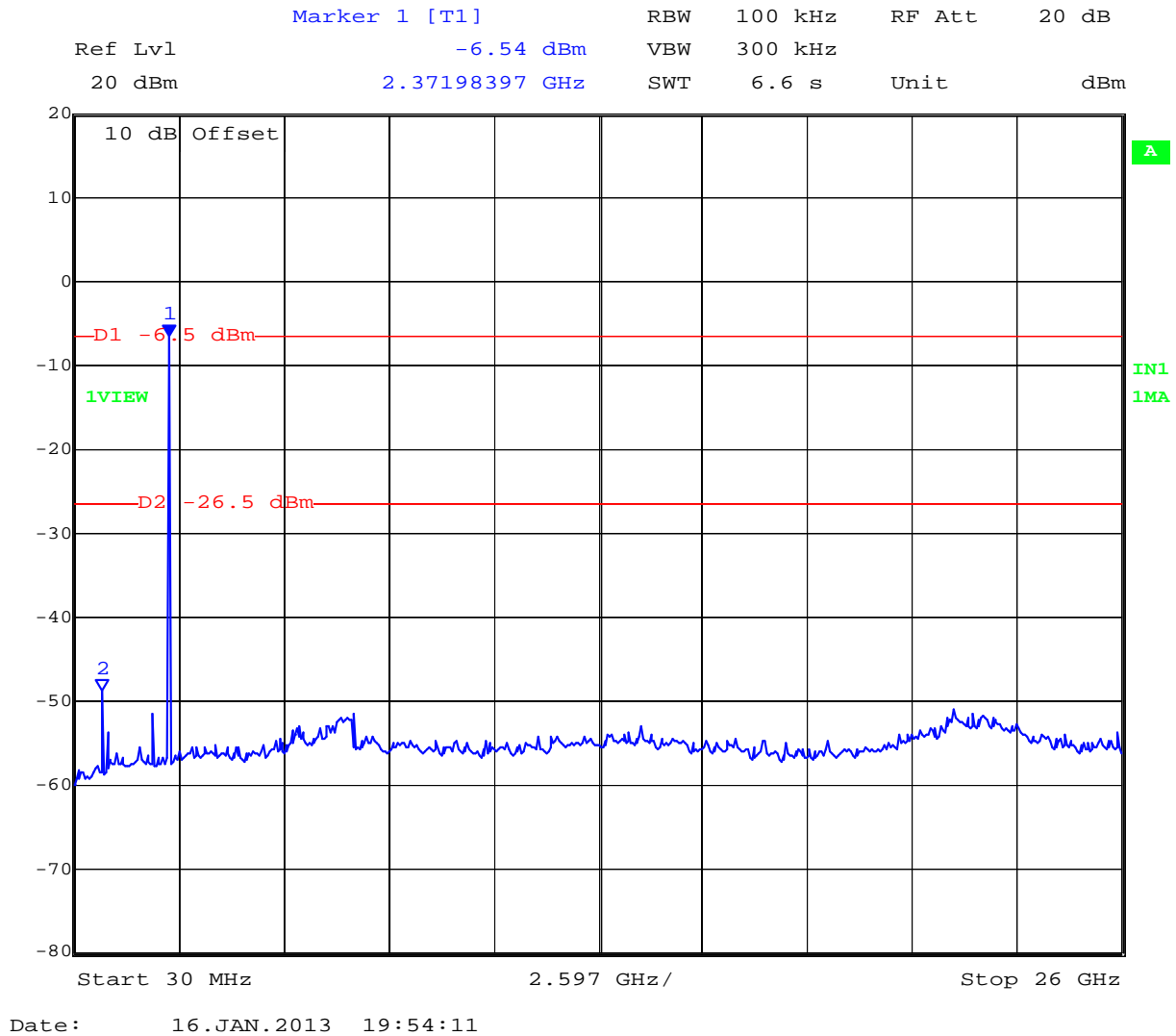

This test report may be reproduced in full only. The document may only be updated by MiCOM Labs personnel. Any changes will be noted in the Document History section of the report.



Title: Ear Force Z300 RX Wireless Audio Headset
To: FCC 47 CFR Part 15.247 & IC RSS-210
Serial #: COMM39-U2 Rev A
Issue Date: 25th July 2013
Page: 98 of 145

Test Results Transmitter Conducted Spurious Emissions CH78:

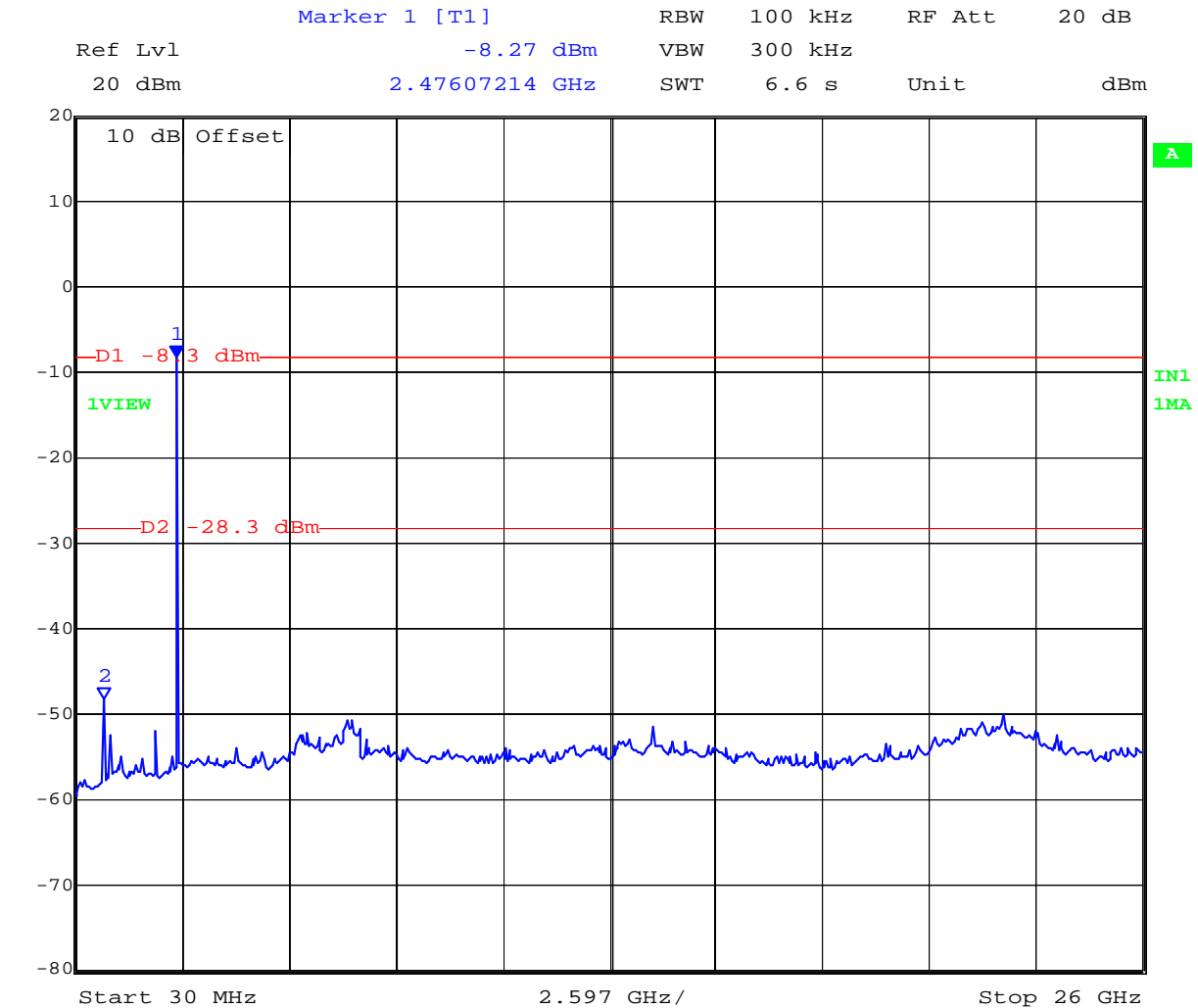

Date: 16.JAN.2013 19:49:34

This test report may be reproduced in full only. The document may only be updated by MiCOM Labs personnel. Any changes will be noted in the Document History section of the report.



Title: Ear Force Z300 RX Wireless Audio Headset
To: FCC 47 CFR Part 15.247 & IC RSS-210
Serial #: COMM39-U2 Rev A
Issue Date: 25th July 2013
Page: 99 of 145

Test Results Transmitter Conducted Spurious Emissions Hopping:

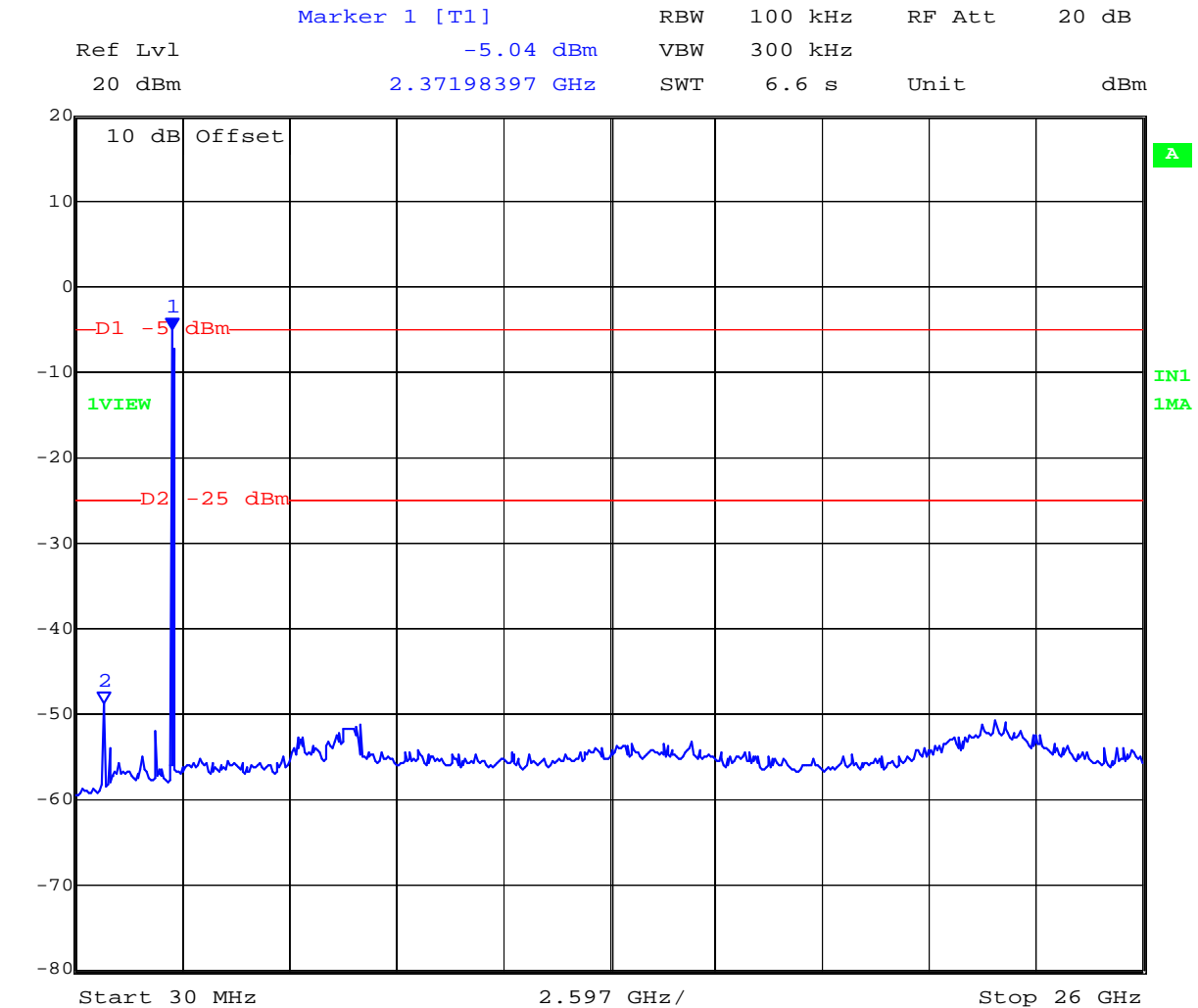

Date: 16.JAN.2013 19:56:25

This test report may be reproduced in full only. The document may only be updated by MiCOM Labs personnel. Any changes will be noted in the Document History section of the report.



Title: Ear Force Z300 RX Wireless Audio Headset
To: FCC 47 CFR Part 15.247 & IC RSS-210
Serial #: COMM39-U2 Rev A
Issue Date: 25th July 2013
Page: 100 of 145

Test Measurement Results 2 Mbs, DH3									
Test Frequency	Frequency Range	Transmitter Conducted Spurious Emissions (dBm)							
		Port a		Port b		Port c		Port d	
MHz	MHz	SE	Limit	SE	Limit	SE	Limit	SE	Limit
2402.0	30.0 - 26000.0	-46.0	-25.0	--	--	--	--	--	--
2480.0	30.0 - 26000.0	-48.5	-28.9						
Hopping	30.0 - 26000.0	-47.0	-25.2	--	--	--	--	--	--

SE - Maximum spurious emission found

This test report may be reproduced in full only. The document may only be updated by MiCOM Labs personnel. Any changes will be noted in the Document History section of the report.



Title: Ear Force Z300 RX Wireless Audio Headset
To: FCC 47 CFR Part 15.247 & IC RSS-210
Serial #: COMM39-U2 Rev A
Issue Date: 25th July 2013
Page: 101 of 145

Test Results Transmitter Conducted Spurious Emissions CH0:

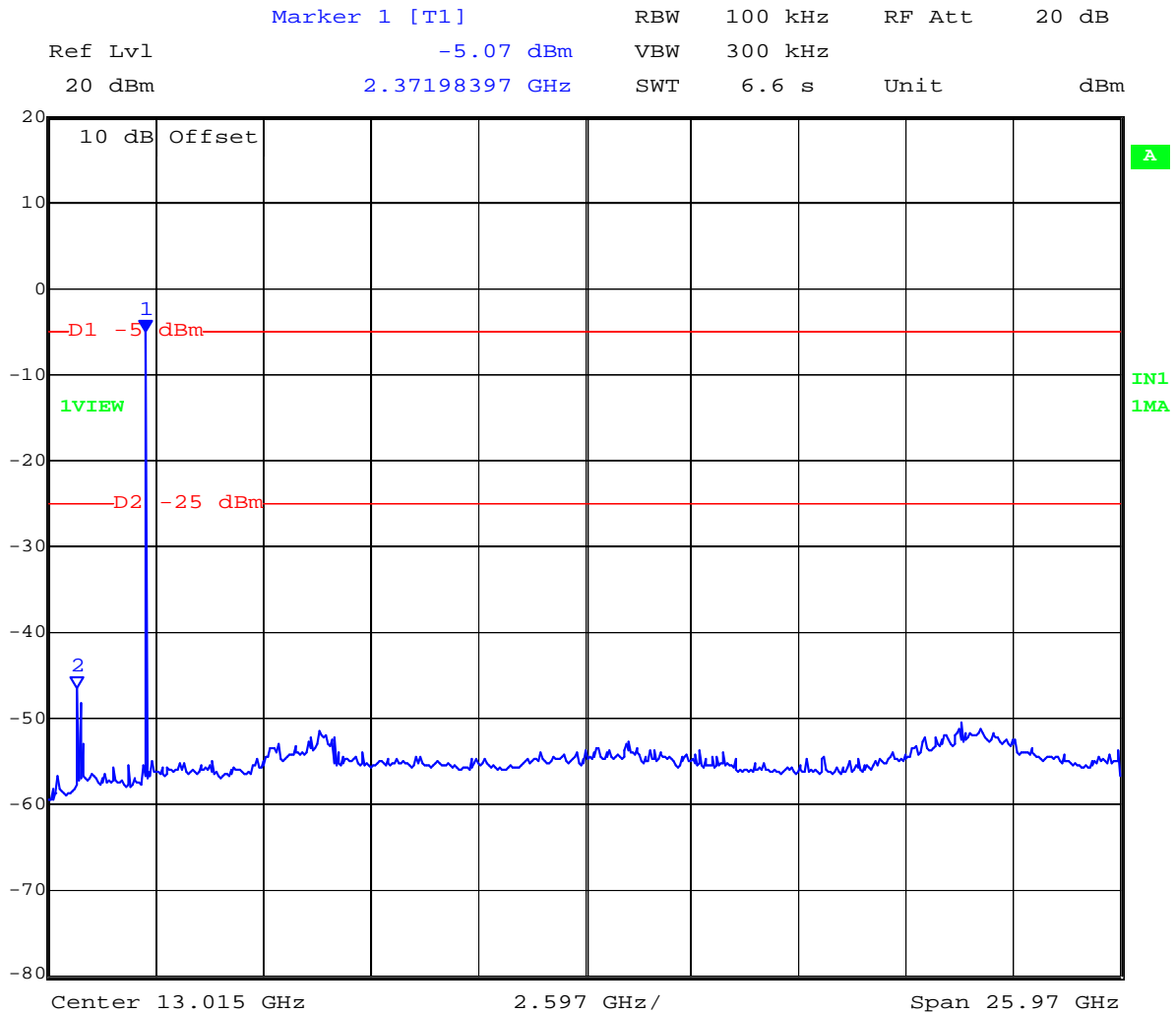

Date: 17.JAN.2013 09:21:53

This test report may be reproduced in full only. The document may only be updated by MiCOM Labs personnel. Any changes will be noted in the Document History section of the report.



Title: Ear Force Z300 RX Wireless Audio Headset
To: FCC 47 CFR Part 15.247 & IC RSS-210
Serial #: COMM39-U2 Rev A
Issue Date: 25th July 2013
Page: 102 of 145

Test Results Transmitter Conducted Spurious Emissions CH78:

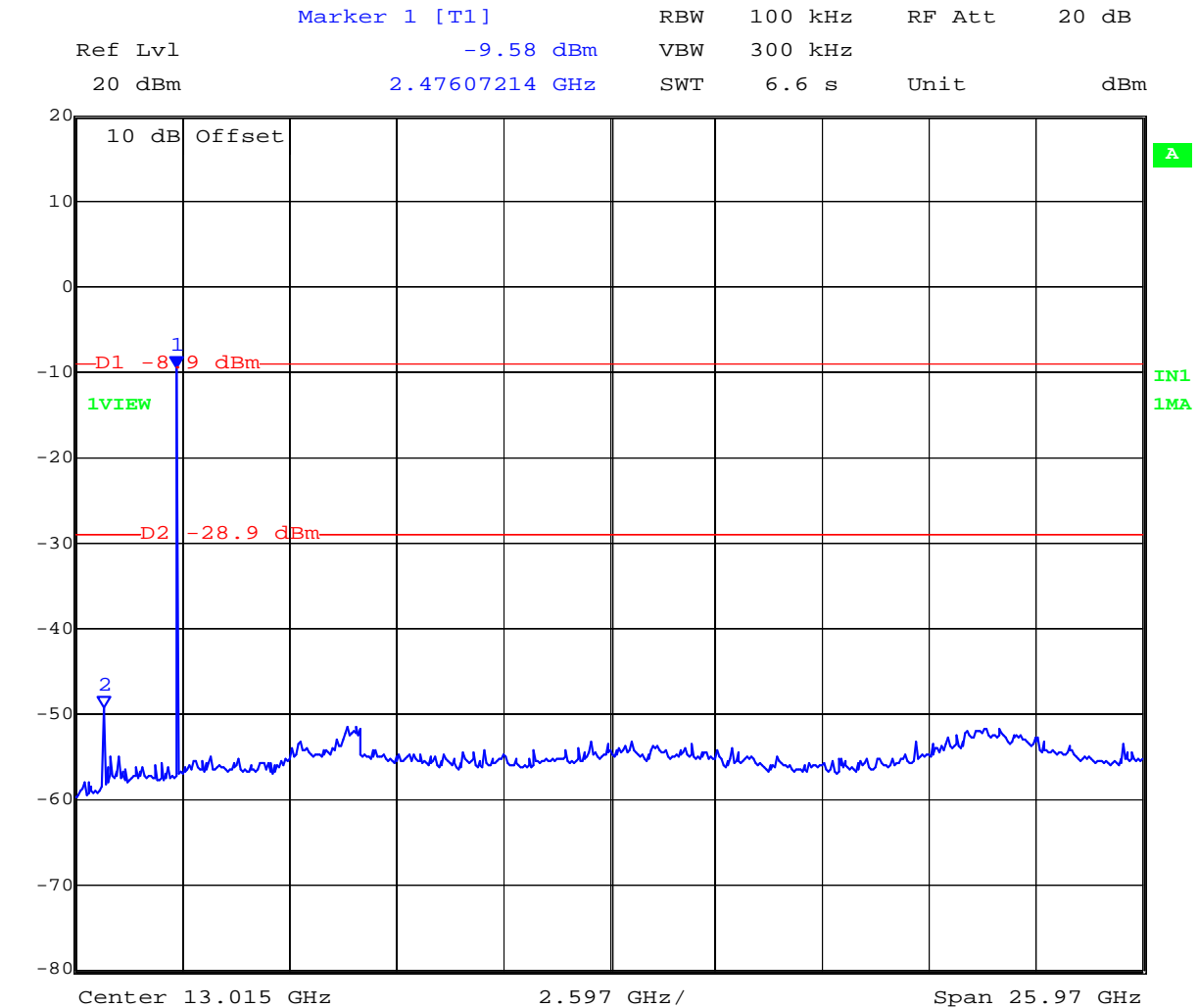

Date: 17.JAN.2013 09:24:22

This test report may be reproduced in full only. The document may only be updated by MiCOM Labs personnel. Any changes will be noted in the Document History section of the report.



Title: Ear Force Z300 RX Wireless Audio Headset
To: FCC 47 CFR Part 15.247 & IC RSS-210
Serial #: COMM39-U2 Rev A
Issue Date: 25th July 2013
Page: 103 of 145

Test Results Transmitter Conducted Spurious Emissions Hopping:

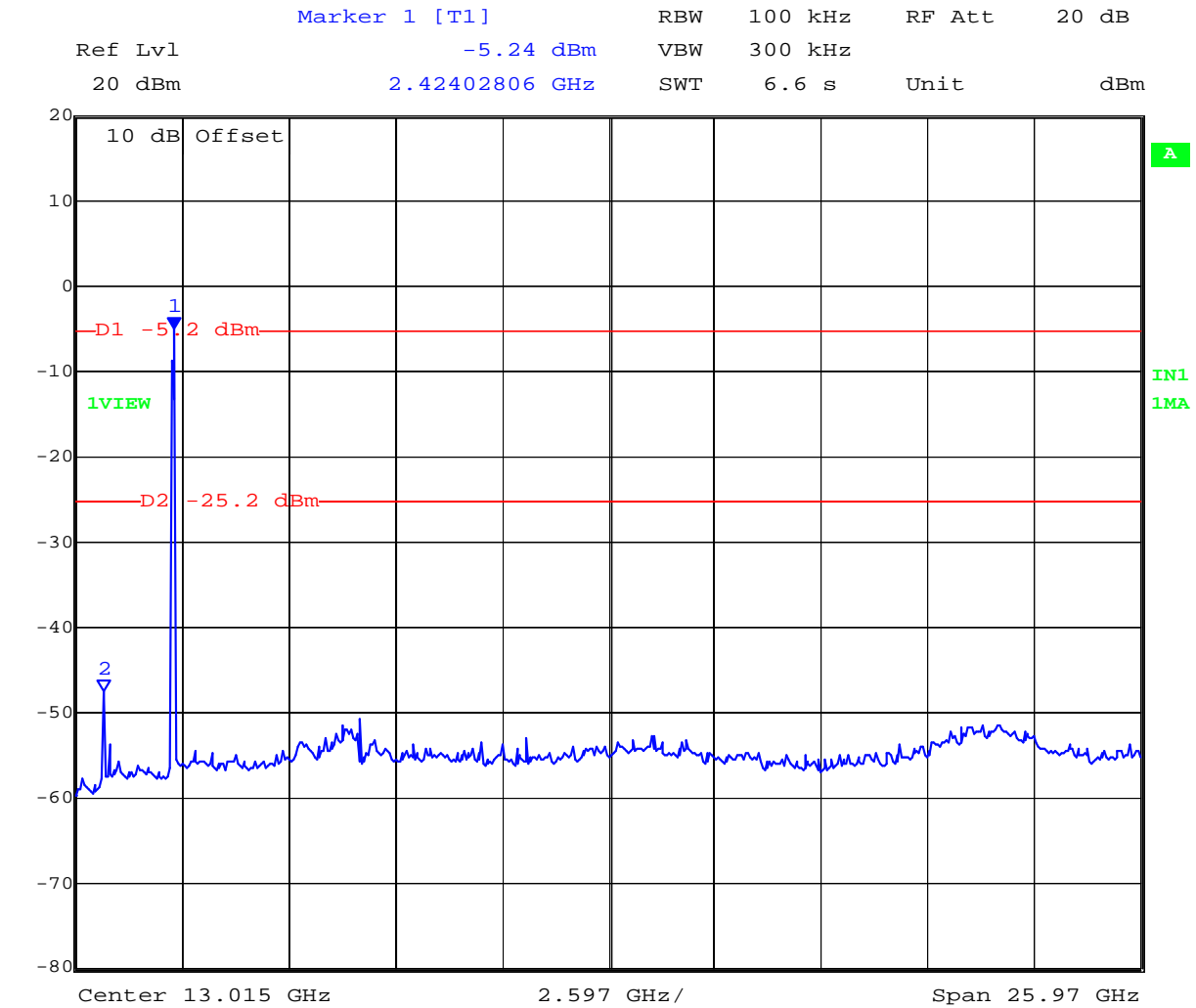

Date: 17.JAN.2013 09:27:03

This test report may be reproduced in full only. The document may only be updated by MiCOM Labs personnel. Any changes will be noted in the Document History section of the report.



Title: Ear Force Z300 RX Wireless Audio Headset
To: FCC 47 CFR Part 15.247 & IC RSS-210
Serial #: COMM39-U2 Rev A
Issue Date: 25th July 2013
Page: 104 of 145

Test Measurement Results 3 Mbs, DH5									
Test Frequency	Frequency Range	Transmitter Conducted Spurious Emissions (dBm)							
		Port a		Port b		Port c		Port d	
MHz	MHz	SE	Limit	SE	Limit	SE	Limit	SE	Limit
2402.0	30.0 - 26000.0	-47.1	-26.0	--	--	--	--	--	--
2480.0	30.0 - 26000.0	-47.5	-28.8						
Hopping	30.0 - 26000.0	-47.6	-26.2	--	--	--	--	--	--
SE - Maximum spurious emission found									
Test Frequency	Band-Edge Frequency	Transmitter Conducted Band-Edge Emissions (dBm)							
		Port a		Port b		Port c		Port d	
MHz	MHz	BE	Limit	BE	Limit	BE	Limit	BE	Limit
2402.0	2400.0	-45.14	-24.16	--	--	--	--	--	--
Hopping	2400.0	-28.69	-23.50						
2480.0	2483.5	-46.98	-25.25						
Hopping	2483.5	-45.68	-25.83	--	--	--	--	--	--
BE - Maximum band-edge emission found									

This test report may be reproduced in full only. The document may only be updated by MiCOM Labs personnel. Any changes will be noted in the Document History section of the report.



Title: Ear Force Z300 RX Wireless Audio Headset
To: FCC 47 CFR Part 15.247 & IC RSS-210
Serial #: COMM39-U2 Rev A
Issue Date: 25th July 2013
Page: 105 of 145

Test Results Transmitter Conducted Spurious Emissions CH0:

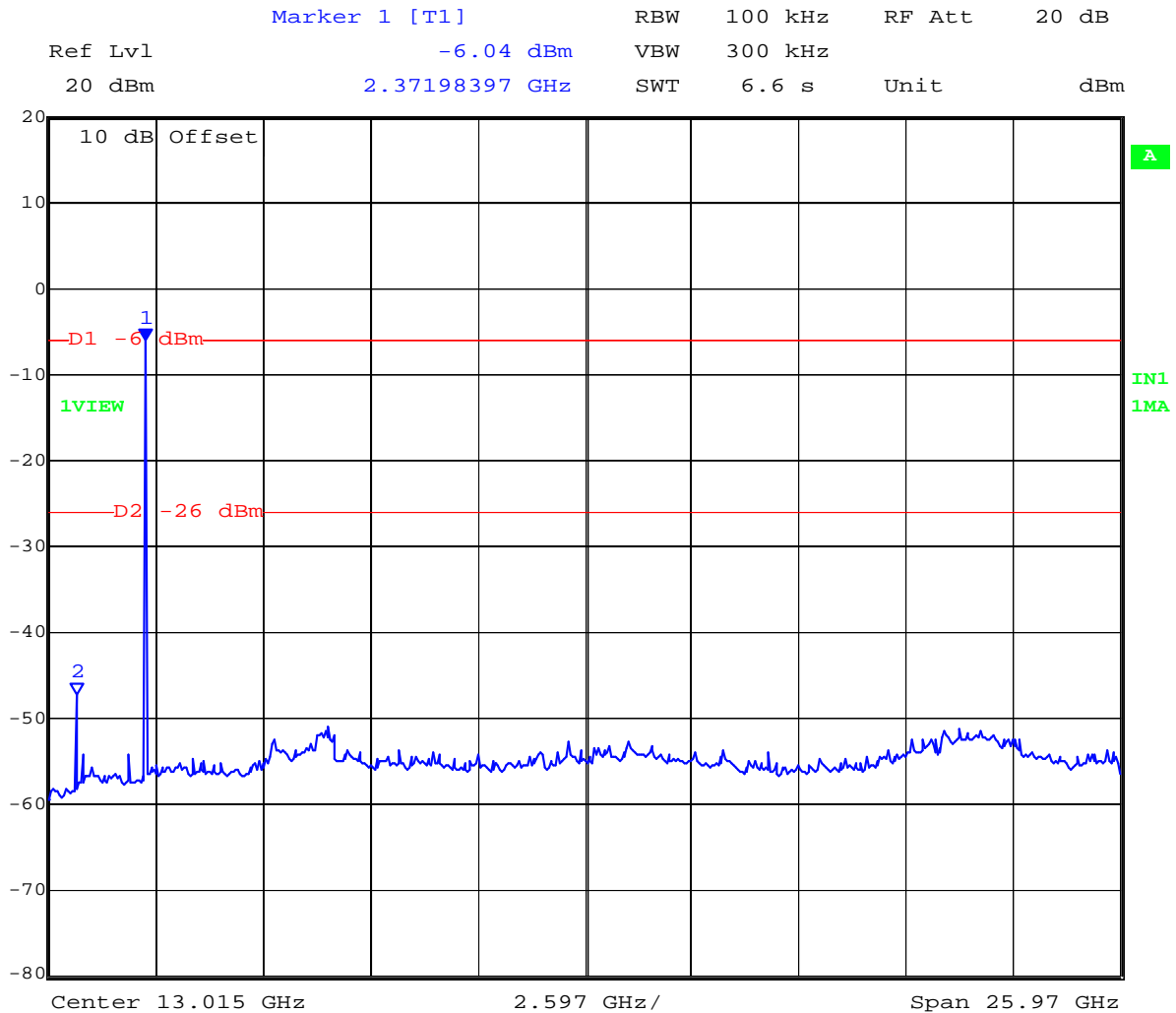

Date: 17.JAN.2013 09:29:27

This test report may be reproduced in full only. The document may only be updated by MiCOM Labs personnel. Any changes will be noted in the Document History section of the report.



Title: Ear Force Z300 RX Wireless Audio Headset
To: FCC 47 CFR Part 15.247 & IC RSS-210
Serial #: COMM39-U2 Rev A
Issue Date: 25th July 2013
Page: 106 of 145

Test Results Transmitter Conducted Spurious Emissions CH78:

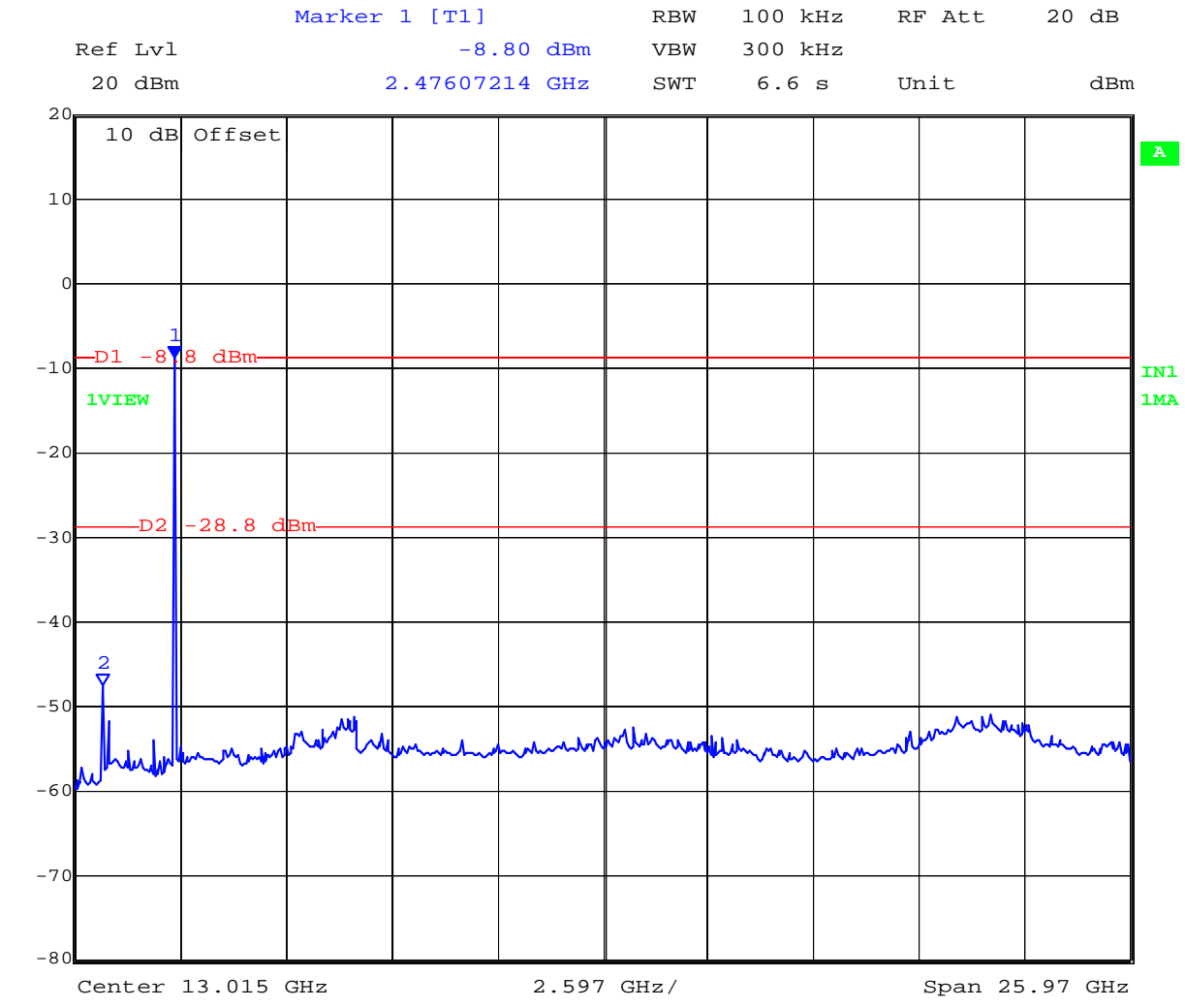

Date: 17.JAN.2013 09:31:37

This test report may be reproduced in full only. The document may only be updated by MiCOM Labs personnel. Any changes will be noted in the Document History section of the report.



Title: Ear Force Z300 RX Wireless Audio Headset
To: FCC 47 CFR Part 15.247 & IC RSS-210
Serial #: COMM39-U2 Rev A
Issue Date: 25th July 2013
Page: 107 of 145

Test Results Transmitter Conducted Spurious Emissions Hopping:

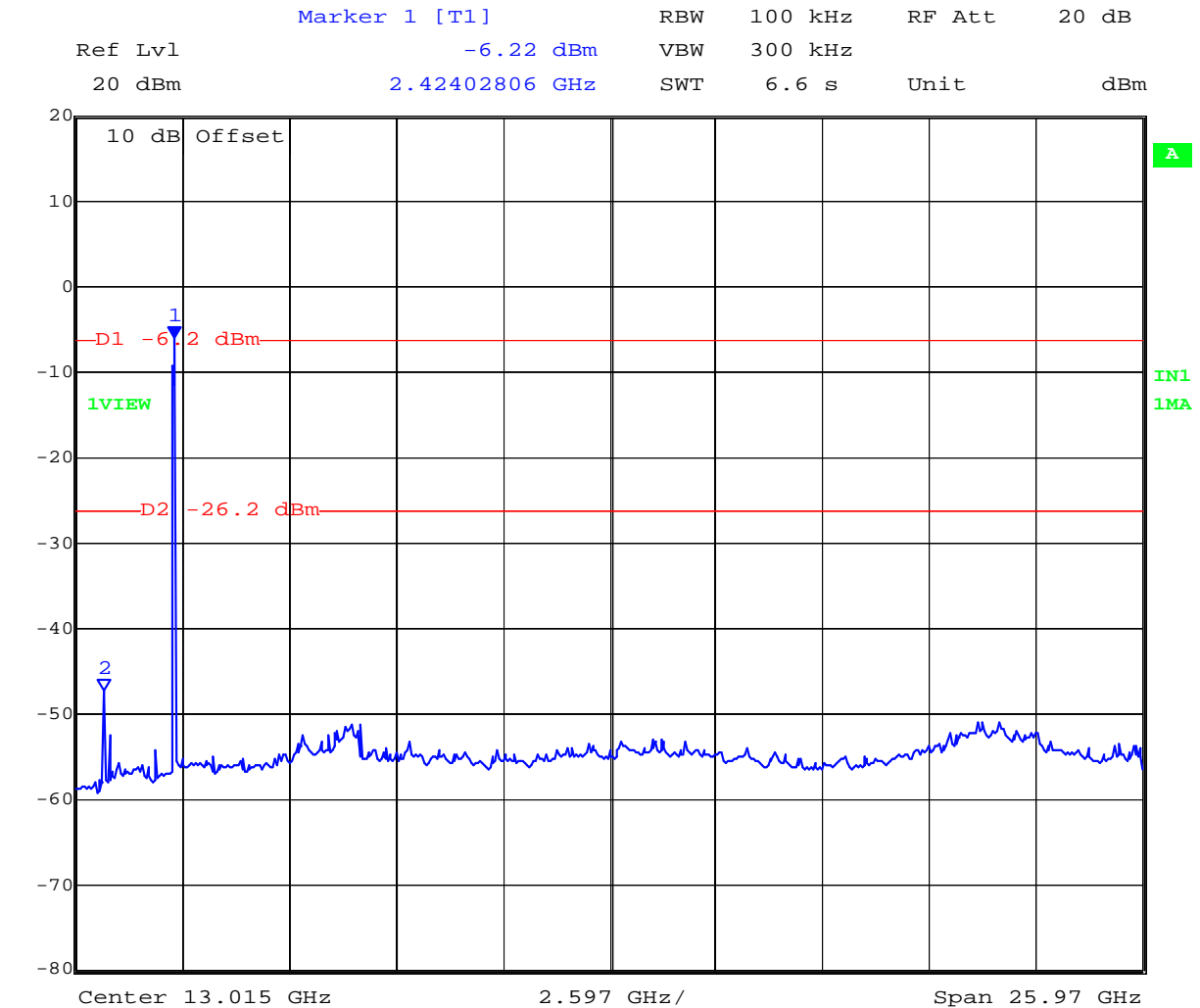

Date: 17.JAN.2013 09:34:03

This test report may be reproduced in full only. The document may only be updated by MiCOM Labs personnel. Any changes will be noted in the Document History section of the report.



Title: Ear Force Z300 RX Wireless Audio Headset
To: FCC 47 CFR Part 15.247 & IC RSS-210
Serial #: COMM39-U2 Rev A
Issue Date: 25th July 2013
Page: 108 of 145

Lower Band Edge; Channel 0 -2402; Hopping Off

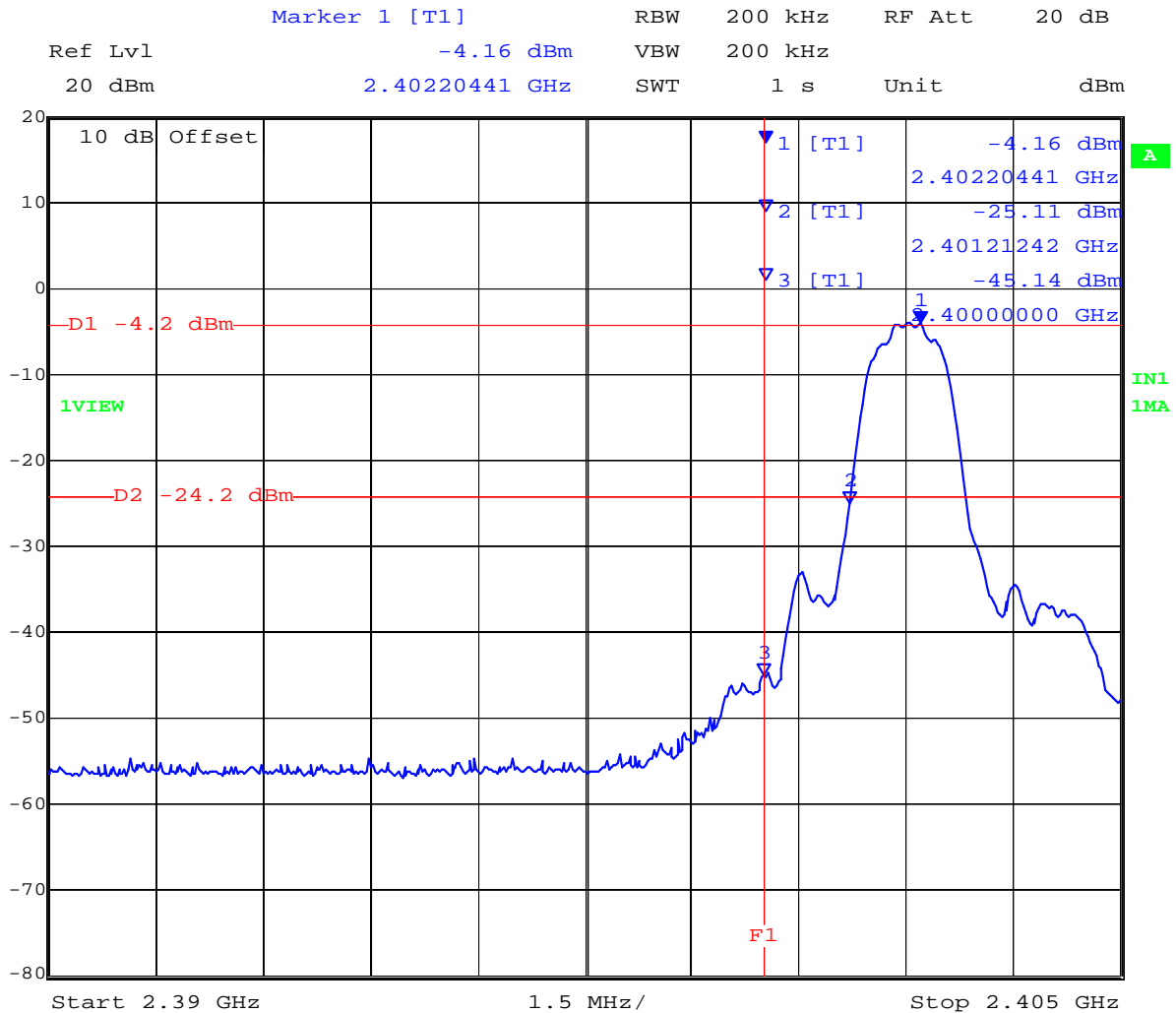

Date: 17.JAN.2013 09:48:10

This test report may be reproduced in full only. The document may only be updated by MiCOM Labs personnel. Any changes will be noted in the Document History section of the report.



Title: Ear Force Z300 RX Wireless Audio Headset
To: FCC 47 CFR Part 15.247 & IC RSS-210
Serial #: COMM39-U2 Rev A
Issue Date: 25th July 2013
Page: 109 of 145

Lower Band Edge; Channel 0 -2402; Hopping On

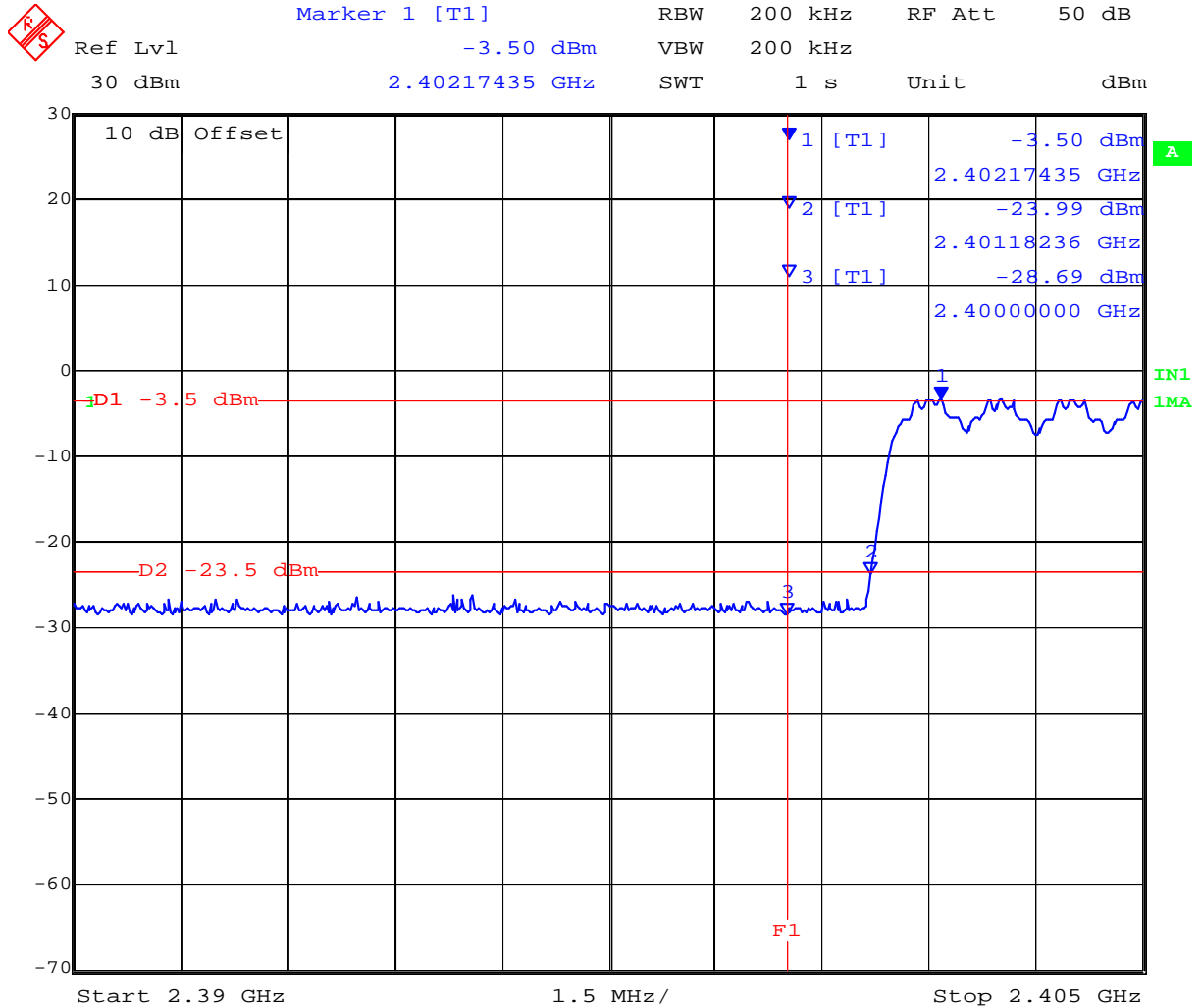

Date: 16.JAN.2013 19:13:55

This test report may be reproduced in full only. The document may only be updated by MiCOM Labs personnel. Any changes will be noted in the Document History section of the report.



Title: Ear Force Z300 RX Wireless Audio Headset
To: FCC 47 CFR Part 15.247 & IC RSS-210
Serial #: COMM39-U2 Rev A
Issue Date: 25th July 2013
Page: 110 of 145

Upper Band Edge; Channel 78 -2480; Hopping Off

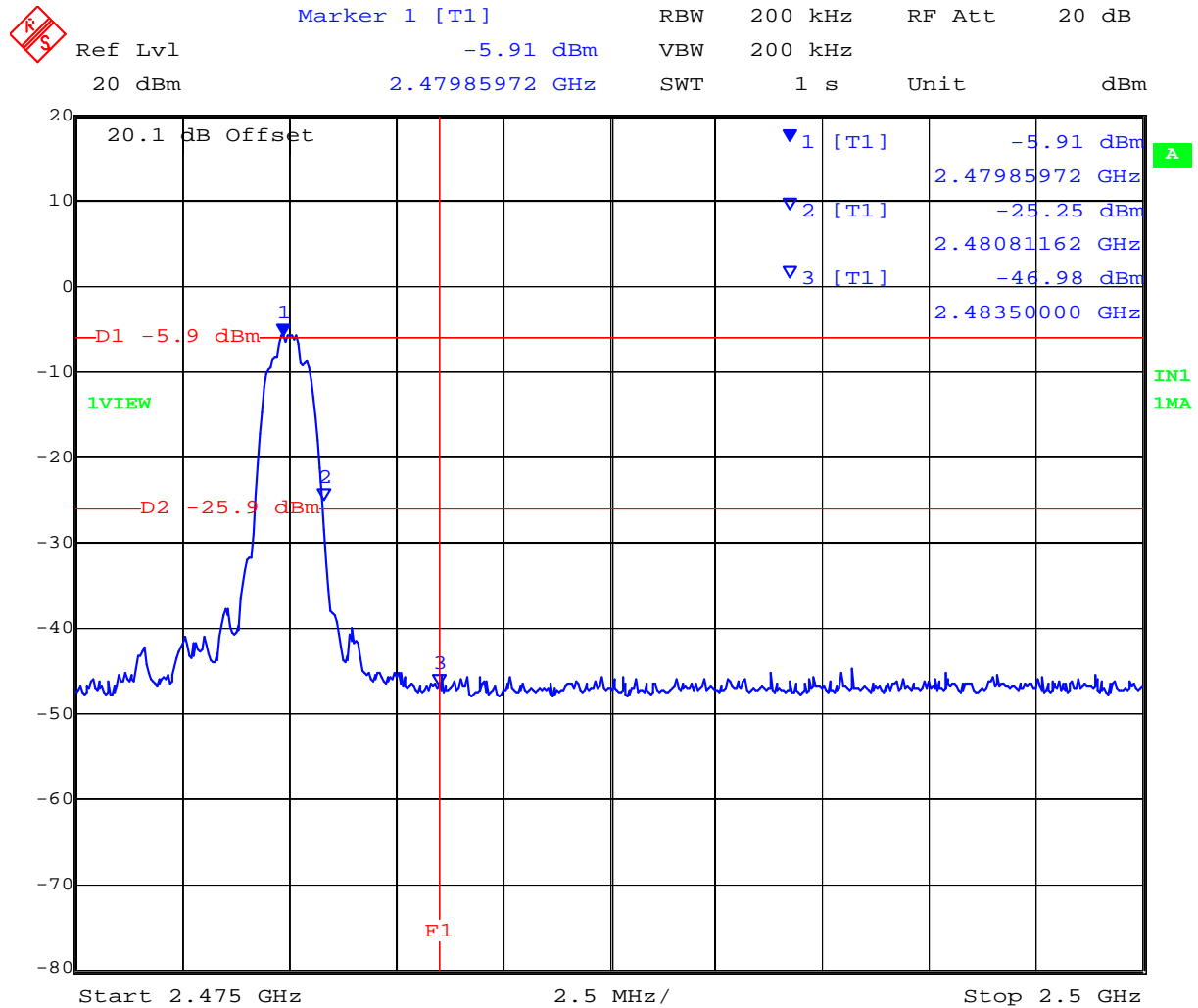

Date: 23.JAN.2013 15:18:45

This test report may be reproduced in full only. The document may only be updated by MiCOM Labs personnel. Any changes will be noted in the Document History section of the report.



Title: Ear Force Z300 RX Wireless Audio Headset
To: FCC 47 CFR Part 15.247 & IC RSS-210
Serial #: COMM39-U2 Rev A
Issue Date: 25th July 2013
Page: 111 of 145

Upper Band Edge; Channel 2480; Hopping On

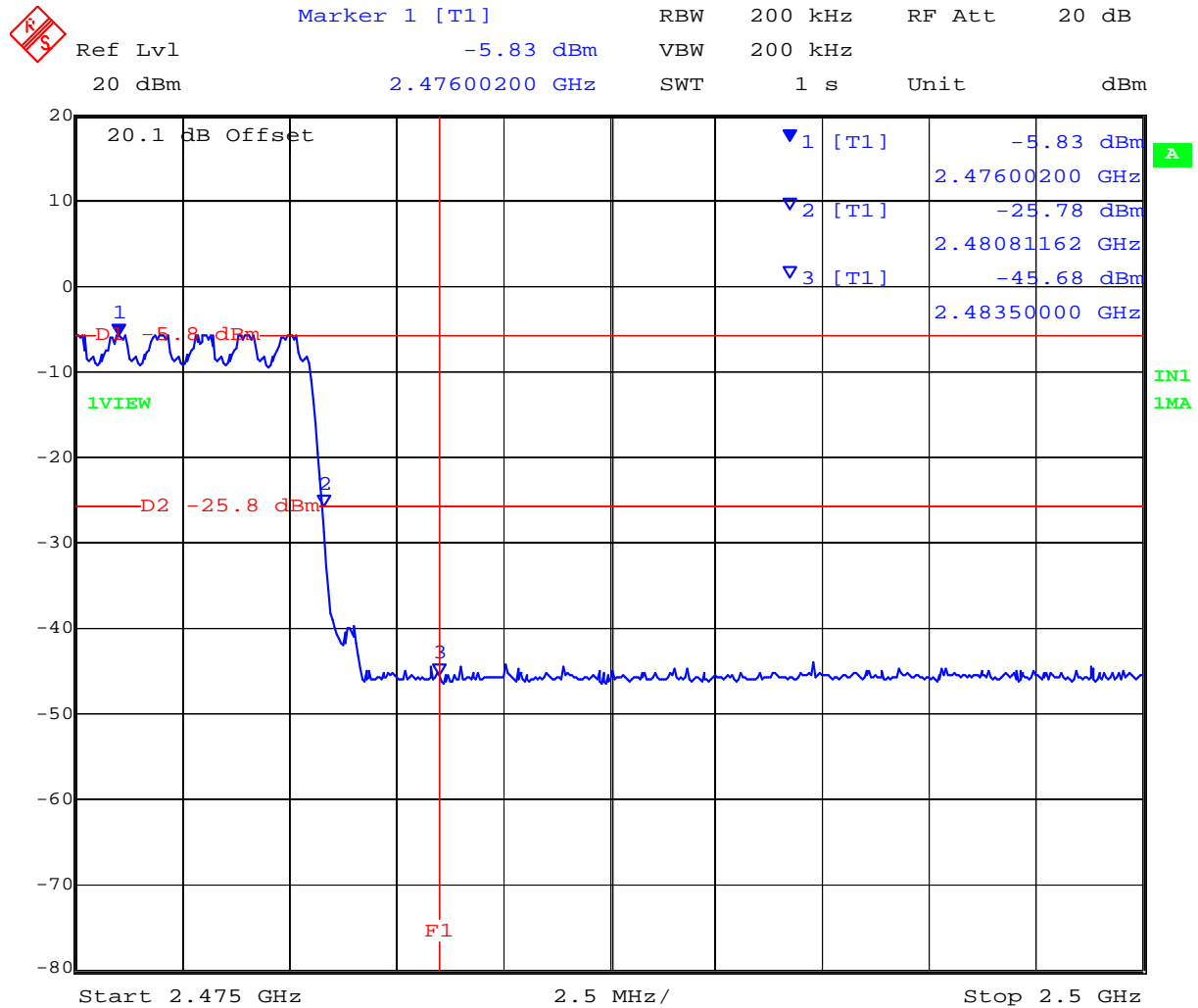

Date: 23.JAN.2013 15:24:44

This test report may be reproduced in full only. The document may only be updated by MiCOM Labs personnel. Any changes will be noted in the Document History section of the report.



Title: Ear Force Z300 RX Wireless Audio Headset
To: FCC 47 CFR Part 15.247 & IC RSS-210
Serial #: COMM39-U2 Rev A
Issue Date: 25th July 2013
Page: 112 of 145

§15.247 (d)

(d) In any 100 kHz bandwidth outside the frequency band in which the spread spectrum or digitally modulated intentional radiator is operating, the radio frequency power that is produced by the intentional radiator shall be at least 20 dB below that in the 100 kHz bandwidth within the band that contains the highest level of the desired power, based on either an RF conducted or a radiated measurement, provided the transmitter demonstrates compliance with the peak conducted power limits. If the transmitter complies with the conducted power limits based on the use of RMS averaging over a time interval, as permitted under paragraph (b)(3) of this section, the attenuation required shall be 30 dB instead of 20 dB. Attenuation below the general limits specified in §15.209(a) is not required. In addition, radiated emissions which fall into the restricted bands, as defined in §15.205(a), must also comply with the radiated emissions limits specified in §15.209(a) (see §15.205(c)).

§ RSS-210 A8.5 In any 100 kHz bandwidth outside the frequency band in which the spread spectrum or digitally modulated device is operating, the RF power that is produced shall be at least 20 dB below that in the 100 kHz bandwidth within the band that contains the highest level of the desired power, based on either an RF conducted or a radiated measurement, provided that the transmitter demonstrates compliance with the peak conducted power limits. If the transmitter complies with the conducted power limits based on the use or root-mean-square averaging over a time interval, as permitted under Section A8.4 (4), the attenuation required shall be 30 dB instead of 20 dB. Attenuation below the general field strength limits specified in RSS-GEN is not required.

§ RSS-GEN 6.2 If the receiver has a detachable antenna of known impedance, antenna conducted spurious emissions measurement is permitted as an alternative to the radiated measurement. However the radiated method of Section 6.1 is recommended

The antenna conducted test shall be performed with the antenna disconnected and the receiver antenna terminals connected to a measuring instrument having equal impedance to that specified for the antenna.

The receiver spurious emissions measured at the antenna terminals by the antenna conducted method shall then comply with the following limits:

Receiver spurious emissions at any discrete frequency shall not exceed 2 nanowatts in the band 30 – 1000 MHz, and 5 nanowatts above 1000 MHz.

Traceability

Method	Test Equipment Used
FCC DA 00-0705	0158, 0193, 0287, 0252, 0313, 0314, 0070, 0116, 0117

This test report may be reproduced in full only. The document may only be updated by MiCOM Labs personnel. Any changes will be noted in the Document History section of the report.



Title: Ear Force Z300 RX Wireless Audio Headset
To: FCC 47 CFR Part 15.247 & IC RSS-210
Serial #: COMM39-U2 Rev A
Issue Date: 25th July 2013
Page: 113 of 145

6.1.1.8. Pseudorandom Hopping Frequency Sequence

Test Conditions for Pseudorandom Hopping Frequency Sequence			
Standard:	FCC CFR 47:15.247	Ambient Temp. (°C):	18.0 - 27.5
Test Heading:	Pseudorandom Hopping Sequence	Rel. Humidity (%):	32 - 45
Standard Section(s):	15.247 (a)(1)	Pressure (mBars):	999 - 1004
Reference Document(s):	FCC DA 00-705 "Filing and Measurement Guidelines for Frequency Hopping Spread Spectrum Systems"		

Pseudorandom Frequency Hopping Sequence

Describe how the hopping sequence is generated. Provide an example of the hopping sequence channels, in order to demonstrate that the sequence meets the requirement specified in the definition of a frequency hopping spread spectrum system, found in Section (a)(1).

Declaration from the Manufacturer

The hopping sequence is selected according to the Bluetooth standard. There are a total of 79 channels available in the 2.4 GHz band. The Bluetooth standard defines an algorithmic basis for determining the pseudorandom sequence to use.

This test report may be reproduced in full only. The document may only be updated by MiCOM Labs personnel. Any changes will be noted in the Document History section of the report.



Title: Ear Force Z300 RX Wireless Audio Headset
To: FCC 47 CFR Part 15.247 & IC RSS-210
Serial #: COMM39-U2 Rev A
Issue Date: 25th July 2013
Page: 114 of 145

Specifications

§15.247 (a) (1)

(1) Frequency hopping systems shall have hopping channel carrier frequencies separated by a minimum of 25 kHz or the 20 dB bandwidth of the hopping channel, whichever is greater. Alternatively, frequency hopping systems operating in the 2400–2483.5 MHz band may have hopping channel carrier frequencies that are separated by 25 kHz or two-thirds of the 20 dB bandwidth of the hopping channel, whichever is greater, provided the systems operate with an output power no greater than 125 mW. The system shall hop to channel frequencies that are selected at the system hopping rate from a pseudo randomly ordered list of hopping frequencies. Each frequency must be used equally on the average by each transmitter. The system receivers shall have input bandwidths that match the hopping channel bandwidths of their corresponding transmitters and shall shift frequencies in synchronization with the transmitted signals.

This test report may be reproduced in full only. The document may only be updated by MiCOM Labs personnel. Any changes will be noted in the Document History section of the report.



Title: Ear Force Z300 RX Wireless Audio Headset
To: FCC 47 CFR Part 15.247 & IC RSS-210
Serial #: COMM39-U2 Rev A
Issue Date: 25th July 2013
Page: 115 of 145

6.1.1.9. Equal Hopping Frequency Use

Test Conditions for Equal Hopping Frequency Use			
Standard:	FCC CFR 47:15.247	Ambient Temp. (°C):	18.0 - 27.5
Test Heading:	Equal Hopping Frequency Use	Rel. Humidity (%):	32 - 45
Standard Section(s):	15.247 (a)(1)	Pressure (mBars):	999 - 1004
Reference Document(s):	FCC DA 00-705 "Filing and Measurement Guidelines for Frequency Hopping Spread Spectrum Systems"		

Equal Hopping Frequency Use

Describe how each individual EUT meets the requirement that each of its hopping channels is used equally on average (e.g., that each new transmission event begins on the next channel in the hopping sequence after the final channel used in the previous transmission event). See Section (a)(1).

Declaration from the Manufacturer

Bluetooth uses a packet based air interface with a fixed timing. Each packet goes out on a different channel in the sequence, so all frequencies in the hopping sequence get used equally.

Specifications

§15.247 (a) (1)

(1) Frequency hopping systems shall have hopping channel carrier frequencies separated by a minimum of 25 kHz or the 20 dB bandwidth of the hopping channel, whichever is greater. Alternatively, frequency hopping systems operating in the 2400–2483.5 MHz band may have hopping channel carrier frequencies that are separated by 25 kHz or two-thirds of the 20 dB bandwidth of the hopping channel, whichever is greater, provided the systems operate with an output power no greater than 125 mW. The system shall hop to channel frequencies that are selected at the system hopping rate from a pseudo randomly ordered list of hopping frequencies. Each frequency must be used equally on the average by each transmitter. The system receivers shall have input bandwidths that match the hopping channel bandwidths of their corresponding transmitters and shall shift frequencies in synchronization with the transmitted signals.

This test report may be reproduced in full only. The document may only be updated by MiCOM Labs personnel. Any changes will be noted in the Document History section of the report.



Title: Ear Force Z300 RX Wireless Audio Headset
To: FCC 47 CFR Part 15.247 & IC RSS-210
Serial #: COMM39-U2 Rev A
Issue Date: 25th July 2013
Page: 116 of 145

6.1.1.10. System Receiver Input Bandwidth

Test Conditions for System Receiver Input Bandwidth			
Standard:	FCC CFR 47:15.247	Ambient Temp. (°C):	18.0 - 27.5
Test Heading:	System Receiver Input Bandwidth	Rel. Humidity (%):	32 - 45
Standard Section(s):	15.247 (a)(1)	Pressure (mBars):	999 - 1004
Reference Document(s):	FCC DA 00-705 "Filing and Measurement Guidelines for Frequency Hopping Spread Spectrum Systems"		

System Receiver Input Bandwidth

Describe how each individual EUT meets the requirement that each of its hopping channels is used equally on average (e.g., that each new transmission event begins on the next channel in the hopping sequence after the final channel used in the previous transmission event). See Section (a)(1).

Declaration from the Manufacturer

Chipset by CSR BT is used in the design and complies with Bluetooth specifications. There are no external channel filters present, but filters are present in the chipset design in order to achieve the receiver sensitivity.

This test report may be reproduced in full only. The document may only be updated by MiCOM Labs personnel. Any changes will be noted in the Document History section of the report.



Title: Ear Force Z300 RX Wireless Audio Headset
To: FCC 47 CFR Part 15.247 & IC RSS-210
Serial #: COMM39-U2 Rev A
Issue Date: 25th July 2013
Page: 117 of 145

Specifications

§15.247 (a) (1)

(1) Frequency hopping systems shall have hopping channel carrier frequencies separated by a minimum of 25 kHz or the 20 dB bandwidth of the hopping channel, whichever is greater. Alternatively, frequency hopping systems operating in the 2400–2483.5 MHz band may have hopping channel carrier frequencies that are separated by 25 kHz or two-thirds of the 20 dB bandwidth of the hopping channel, whichever is greater, provided the systems operate with an output power no greater than 125 mW. The system shall hop to channel frequencies that are selected at the system hopping rate from a pseudo randomly ordered list of hopping frequencies. Each frequency must be used equally on the average by each transmitter. The system receivers shall have input bandwidths that match the hopping channel bandwidths of their corresponding transmitters and shall shift frequencies in synchronization with the transmitted signals.

§ RSS-210 A8.1 (b) (b) Frequency hopping systems shall have hopping channel carrier frequencies separated by a minimum of 25 kHz or the -20 dB bandwidth of the hopping channel, whichever is greater. Alternatively, frequency hopping systems operating in the band 2400-2483.5 MHz may have hopping channel carrier frequencies that are separated by 25 kHz or two-thirds of the -20 dB bandwidth of the hopping channel, whichever is greater, provided that the systems operate with an output power no greater than 0.125 W. The system receivers shall have input bandwidths that match the hopping channel bandwidths of their corresponding transmitters and shall shift frequencies in synchronization with the transmitted signals

This test report may be reproduced in full only. The document may only be updated by MiCOM Labs personnel. Any changes will be noted in the Document History section of the report.



Title: Ear Force Z300 RX Wireless Audio Headset
To: FCC 47 CFR Part 15.247 & IC RSS-210
Serial #: COMM39-U2 Rev A
Issue Date: 25th July 2013
Page: 118 of 145

6.1.1.11. System Receiver Hopping Capability

Test Conditions for System Receiver Hopping Capability			
Standard:	FCC CFR 47:15.247	Ambient Temp. (°C):	18.0 - 27.5
Test Heading:	System Receiver Hopping Capability	Rel. Humidity (%):	32 - 45
Standard Section(s):	15.247 (a)(1)	Pressure (mBars):	999 - 1004
Reference Document(s):	FCC DA 00-705 "Filing and Measurement Guidelines for Frequency Hopping Spread Spectrum Systems"		

System Receiver Hopping Capability

Describe how the associated receiver(s) has the ability to shift frequencies in synchronization with the transmitted signals. See Section (a)(1).

Declaration from the Manufacturer

A slave device follows the master device's hopping sequence by quickly scanning through channels to find the master's transmission (this is called discovery). It then uses information in that packet and the same algorithmic process described in the standard to determine what the hopping sequence is that the master is using. The slave also synchronizes to the master's transmit packet timing so it knows when to hop.

This test report may be reproduced in full only. The document may only be updated by MiCOM Labs personnel. Any changes will be noted in the Document History section of the report.



Title: Ear Force Z300 RX Wireless Audio Headset
To: FCC 47 CFR Part 15.247 & IC RSS-210
Serial #: COMM39-U2 Rev A
Issue Date: 25th July 2013
Page: 119 of 145

Specifications

§15.247 (a) (1)

(1) Frequency hopping systems shall have hopping channel carrier frequencies separated by a minimum of 25 kHz or the 20 dB bandwidth of the hopping channel, whichever is greater. Alternatively, frequency hopping systems operating in the 2400–2483.5 MHz band may have hopping channel carrier frequencies that are separated by 25 kHz or two-thirds of the 20 dB bandwidth of the hopping channel, whichever is greater, provided the systems operate with an output power no greater than 125 mW. The system shall hop to channel frequencies that are selected at the system hopping rate from a pseudo randomly ordered list of hopping frequencies. Each frequency must be used equally on the average by each transmitter. The system receivers shall have input bandwidths that match the hopping channel bandwidths of their corresponding transmitters and shall shift frequencies in synchronization with the transmitted signals.

§ RSS-210 A8.1 (b) (b) Frequency hopping systems shall have hopping channel carrier frequencies separated by a minimum of 25 kHz or the -20 dB bandwidth of the hopping channel, whichever is greater. Alternatively, frequency hopping systems operating in the band 2400-2483.5 MHz may have hopping channel carrier frequencies that are separated by 25 kHz or two-thirds of the -20 dB bandwidth of the hopping channel, whichever is greater, provided that the systems operate with an output power no greater than 0.125 W. The system receivers shall have input bandwidths that match the hopping channel bandwidths of their corresponding transmitters and shall shift frequencies in synchronization with the transmitted signals

This test report may be reproduced in full only. The document may only be updated by MiCOM Labs personnel. Any changes will be noted in the Document History section of the report.



Title: Ear Force Z300 RX Wireless Audio Headset
To: FCC 47 CFR Part 15.247 & IC RSS-210
Serial #: COMM39-U2 Rev A
Issue Date: 25th July 2013
Page: 120 of 145

6.1.2. Radiated Emission Testing

Transmitter Radiated Spurious Emissions (above 1 GHz); Peak Field Strength Measurements; and Radiated Band Edge Measurements – Restricted Bands

FCC, Part 15 Subpart C §15.247(d) 15.205; 15.209
Industry Canada RSS-210 §A8.5,
Industry Canada RSS-Gen §4.10

Test Procedure

The worst case highest spectral density radiated emissions above 1 GHz are measured in the anechoic chamber at a 3-meter distance on every azimuth in both horizontal and vertical polarities. The emissions are recorded and maximized as a function of azimuth by rotation through 360° with a spectrum analyzer in peak hold mode. Depending on the frequency band spanned a notch filter and waveguide filter was used to remove the fundamental frequency. The highest emissions relative to the limit are listed for each frequency spanned.

All measurements on any frequency or frequencies over 1 MHz are based on the use of measurement instrumentation employing an average detector function. All measurements above 1 GHz were performed using a minimum resolution bandwidth of 1 MHz.

Field Strength Calculation

The field strength is calculated by adding the Antenna Factor and Cable Loss, and subtracting Amplifier Gain from the measured reading. All factors are included in the reported data.

$$FS = R + AF + CORR - FO$$

where: FS = Field Strength

R = Measured Spectrum analyzer Input Amplitude

AF = Antenna Factor

CORR = Correction Factor = CL – AG + NFL

CL = Cable Loss

AG = Amplifier Gain

FO = Distance Falloff Factor

NFL = Notch Filter Loss or Waveguide Loss

For example:

Given receiver input reading of 51.5 dB μ V; Antenna Factor of 8.5 dB; Cable Loss of 1.3 dB; Falloff Factor of 0 dB, an Amplifier Gain of 26 dB and Notch Filter Loss of 1 dB. The Field Strength of the measured emission is:

$$FS = 51.5 + 8.5 + 1.3 - 26.0 + 1 = 36.3 \text{ dB}\mu\text{V/m}$$

Conversion between dB μ V/m (or dB μ V) and μ V/m (or μ V) are done as:

$$\text{Level (dB}\mu\text{V/m)} = 20 * \text{Log (level (\mu\text{V/m}))}$$

$$40 \text{ dB}\mu\text{V/m} = 100 \mu\text{V/m}$$

$$48 \text{ dB}\mu\text{V/m} = 250 \mu\text{V/m}$$

This test report may be reproduced in full only. The document may only be updated by MiCOM Labs personnel. Any changes will be noted in the Document History section of the report.



Title: Ear Force Z300 RX Wireless Audio Headset
To: FCC 47 CFR Part 15.247 & IC RSS-210
Serial #: COMM39-U2 Rev A
Issue Date: 25th July 2013
Page: 121 of 145

6.1.2.1. Test Results

Test Freq.	2402	Engineer	JMH
Variant	802.15.2 BDR GFSK	Temp (°C)	17.5
Freq. Range	1000 MHz - 18000 MHz	Rel. Hum.(%)	36
Power Setting		Press. (mBars)	1011
Antenna	Integral 2.8	Duty Cycle (%)	100
Test Notes 1	XP510RX Headphones		
Test Notes 2			

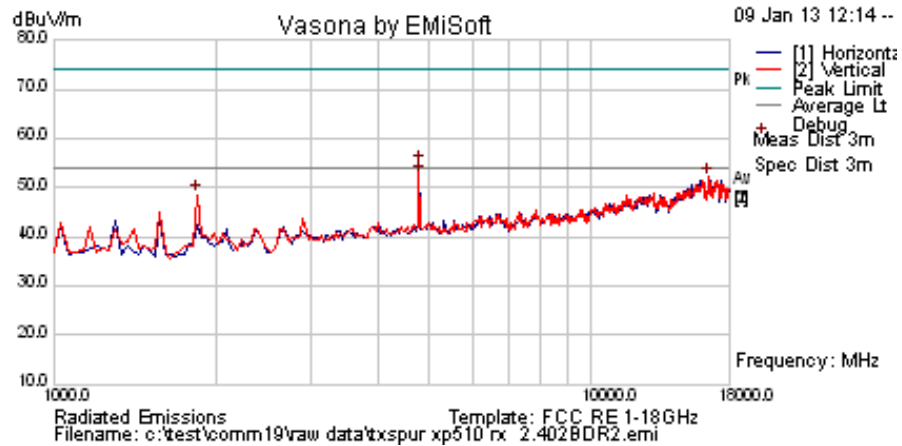

Formally measured emission peaks

Frequency MHz	Raw dBuV	Cable Loss	AF dB	Level dBuV/m	Measurement Type	Pol	Hgt cm	Azt Deg	Limit dBuV/m	Margin dB	Pass /Fail	Comments
16501.002	43.0	8.8	0.3	52.2	Peak [Scan]	V	100	0	54.0	-1.8	Pass	Noise
1851.70341	58.2	2.7	-12.4	48.5	Peak [Scan]	V						NRB
4804.084	60.0	4.5	-9.7	54.8	Peak Max	H	149	299	74	-19.2	Pass	RB
4804.084	57.5	4.5	-9.7	52.3	Average Max	H	149	299	54	-1.7	Pass	RB
Legend: TX = Transmitter Emissions; DIG = Digital Emissions; FUND = Fundamental; WB = Wideband Emission RB = Restricted Band (15.209 Limits); NRB = Non Restricted Band, Limit is 20dB below fundamental peak												

This test report may be reproduced in full only. The document may only be updated by MiCOM Labs personnel. Any changes will be noted in the Document History section of the report.



Title: Ear Force Z300 RX Wireless Audio Headset
To: FCC 47 CFR Part 15.247 & IC RSS-210
Serial #: COMM39-U2 Rev A
Issue Date: 25th July 2013
Page: 122 of 145

Test Freq.	2441	Engineer	JMH
Variant	802.15.2 BDR GFSK	Temp (°C)	17.5
Freq. Range	1000 MHz - 18000 MHz	Rel. Hum.(%)	36
Power Setting		Press. (mBars)	1011
Antenna	Integral 2.8	Duty Cycle (%)	100
Test Notes 1	XP510RX Headphones		
Test Notes 2	BDR		

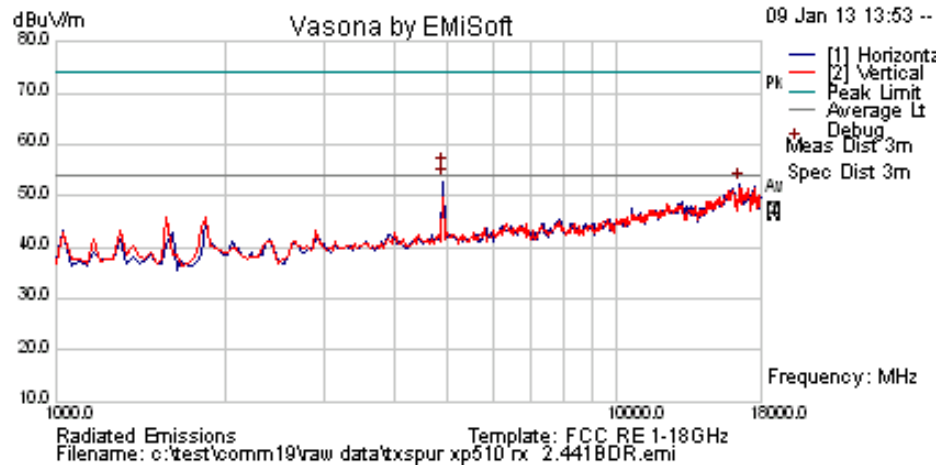

Formally measured emission peaks

Frequency MHz	Raw dBuV	Cable Loss	AF dB	Level dBuV/m	Measurement Type	Pol	Hgt cm	Azt Deg	Limit dBuV/m	Margin dB	Pass /Fail	Comments
4882.044	60.9	4.5	-9.7	55.7	Peak Max	H	147	299	74.0	-18.3	Pass	RB
4882.044	58.5	4.5	-9.7	53.3	Average Max	H	147	299	54.0	-0.7	Pass	RB
16501.002	43.2	8.8	0.3	52.3	Peak [Scan]	H	150	0	54	-1.7	Pass	Noise

Legend: TX = Transmitter Emissions; DIG = Digital Emissions; FUND = Fundamental; WB = Wideband Emission
 RB = Restricted Band (15.209 Limits); NRB = Non Restricted Band, Limit is 20dB below fundamental peak

This test report may be reproduced in full only. The document may only be updated by MiCOM Labs personnel. Any changes will be noted in the Document History section of the report.



Title: Ear Force Z300 RX Wireless Audio Headset
To: FCC 47 CFR Part 15.247 & IC RSS-210
Serial #: COMM39-U2 Rev A
Issue Date: 25th July 2013
Page: 123 of 145

Test Freq.	2480	Engineer	JMH
Variant	802.15.2 BDR GFSK	Temp (°C)	17.5
Freq. Range	1000 MHz - 18000 MHz	Rel. Hum.(%)	36
Power Setting		Press. (mBars)	1011
Antenna	Integral 2.8	Duty Cycle (%)	100
Test Notes 1	XP510RX Headphones		
Test Notes 2	BDR		

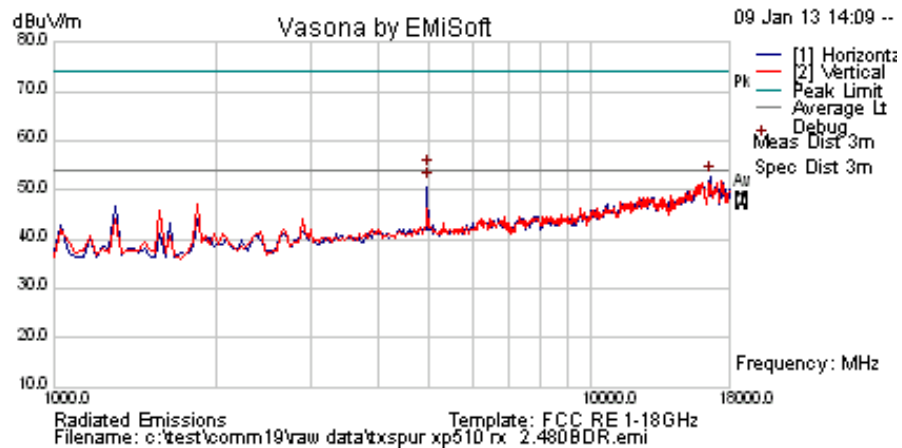

Formally measured emission peaks

Frequency MHz	Raw dBuV	Cable Loss	AF dB	Level dBuV/m	Measurement Type	Pol	Hgt cm	Azt Deg	Limit dBuV/m	Margin dB	Pass /Fail	Comments
16569.138	43.6	8.8	0.5	52.8	Peak [Scan]	H	100	0	54.0	-1.2	Pass	Noise
4960.12	59.4	4.6	-9.9	54.1	Peak Max	H	160	301	74.0	-19.9	Pass	RB
4960.120	56.8	4.6	-9.9	51.6	Average Max	H	160	301	54	-2.4	Pass	RB

Legend: TX = Transmitter Emissions; DIG = Digital Emissions; FUND = Fundamental; WB = Wideband Emission
 RB = Restricted Band (15.209 Limits); NRB = Non Restricted Band, Limit is 20dB below fundamental peak

This test report may be reproduced in full only. The document may only be updated by MiCOM Labs personnel. Any changes will be noted in the Document History section of the report.



Title: Ear Force Z300 RX Wireless Audio Headset
To: FCC 47 CFR Part 15.247 & IC RSS-210
Serial #: COMM39-U2 Rev A
Issue Date: 25th July 2013
Page: 124 of 145

Test Freq.	2402	Engineer	JMH
Variant	802.15.2 EDR pi/4-DQPSK	Temp (°C)	17.5
Freq. Range	1000 MHz - 18000 MHz	Rel. Hum.(%)	36
Power Setting	0 dBm	Press. (mBars)	1011
Antenna	Integral 2.8	Duty Cycle (%)	100
Test Notes 1	XP510RX Headphones		
Test Notes 2	EDR		

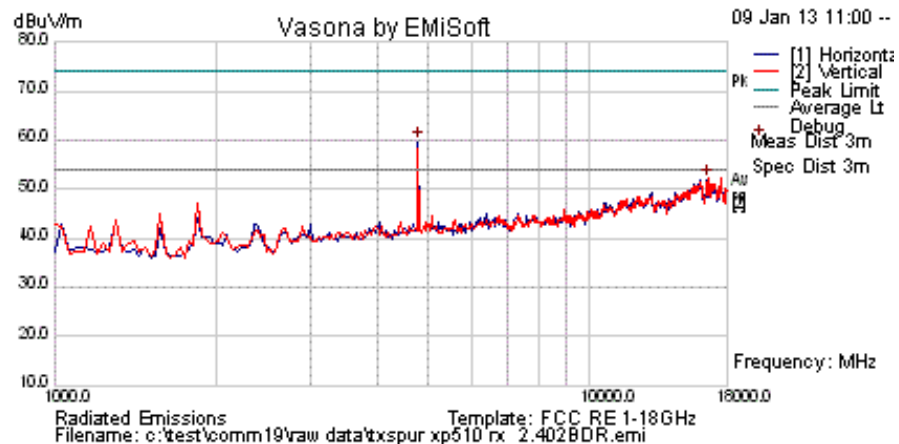

Formally measured emission peaks

Frequency MHz	Raw dBuV	Cable Loss	AF dB	Level dBuV/m	Measurement Type	Pol	Hgt cm	Azt Deg	Limit dBuV/m	Margin dB	Pass /Fail	Comments
16535.070	42.3	8.8	0.4	51.5	Peak [Scan]	V	150	0	54.0	-2.5	Pass	Noise
4803.928	60.0	4.5	-9.7	54.8	Peak Max	H	154	299	74.0	-19.2	Pass	RB
4803.928	57.7	4.5	-9.7	52.5	Average Max	H	154	299	54	-1.5	Pass	RB

Legend: TX = Transmitter Emissions; DIG = Digital Emissions; FUND = Fundamental; WB = Wideband Emission
 RB = Restricted Band (15.209 Limits); NRB = Non Restricted Band, Limit is 20dB below fundamental peak

This test report may be reproduced in full only. The document may only be updated by MiCOM Labs personnel. Any changes will be noted in the Document History section of the report.



Title: Ear Force Z300 RX Wireless Audio Headset
To: FCC 47 CFR Part 15.247 & IC RSS-210
Serial #: COMM39-U2 Rev A
Issue Date: 25th July 2013
Page: 125 of 145

Test Freq.	2441	Engineer	JMH
Variant	802.15.2 EDR pi/4-DQPSK	Temp (°C)	17.5
Freq. Range	1000 MHz - 18000 MHz	Rel. Hum.(%)	36
Power Setting	0 dBm	Press. (mBars)	1011
Antenna	Integral 2.8	Duty Cycle (%)	100
Test Notes 1	XP510RX Headphones		
Test Notes 2	EDR		

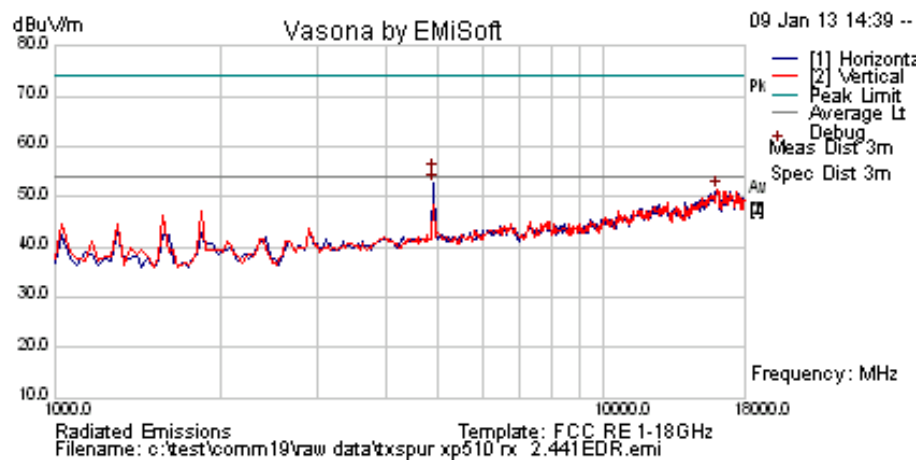

Formally measured emission peaks

Frequency MHz	Raw dBuV	Cable Loss	AF dB	Level dBuV/m	Measurement Type	Pol	Hgt cm	Azt Deg	Limit dBuV/m	Margin dB	Pass /Fail	Comments
16058.116	42.1	9.0	0.3	51.3	Peak [Scan]	H	150	0	54.0	-2.7	Pass	Noise
4881.964	60.1	4.5	-9.7	54.9	Peak Max	H	152	297	74.0	-19.2	Pass	RB
4881.964	57.6	4.5	-9.7	52.4	Average Max	H	152	297	54	-1.6	Pass	RB

Legend: TX = Transmitter Emissions; DIG = Digital Emissions; FUND = Fundamental; WB = Wideband Emission
 RB = Restricted Band (15.209 Limits); NRB = Non Restricted Band, Limit is 20dB below fundamental peak

This test report may be reproduced in full only. The document may only be updated by MiCOM Labs personnel. Any changes will be noted in the Document History section of the report.



Title: Ear Force Z300 RX Wireless Audio Headset
To: FCC 47 CFR Part 15.247 & IC RSS-210
Serial #: COMM39-U2 Rev A
Issue Date: 25th July 2013
Page: 126 of 145

Test Freq.	2480 MHz	Engineer	JMH
Variant	802.15.2 EDR pi/4-DQPSK	Temp (°C)	17.5
Freq. Range	1000 MHz - 18000 MHz	Rel. Hum.(%)	36
Power Setting	0 dBm	Press. (mBars)	1011
Antenna	Integral 2.8	Duty Cycle (%)	100
Test Notes 1			
Test Notes 2	EDR		

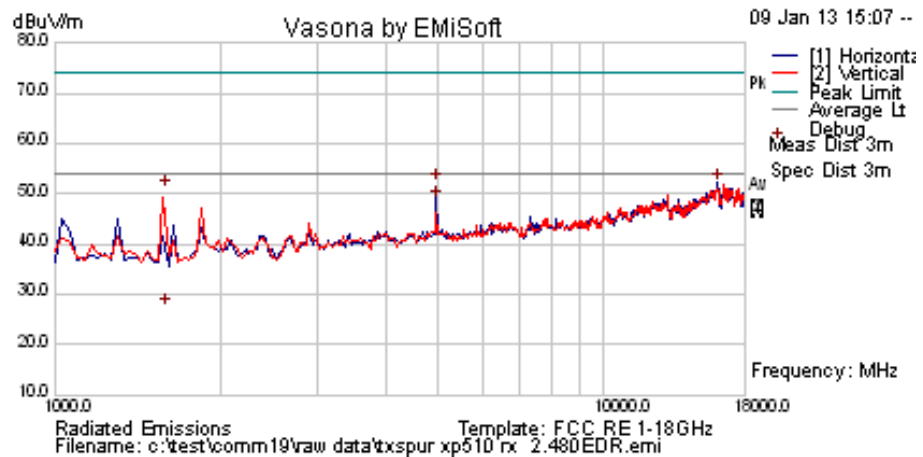

Formally measured emission peaks

Frequency MHz	Raw dBuV	Cable Loss	AF dB	Level dBuV/m	Measurement Type	Pol	Hgt cm	Azt Deg	Limit dBuV/m	Margin dB	Pass /Fail	Comments
16092.184	42.9	9.0	0.3	52.2	Peak [Scan]	H	100	0	54.0	-1.8	Pass	Noise
4960.111	54.1	4.6	-9.9	48.8	Average Max	H	124	260	54.0	-5.2	Pass	RB
4960.111	57.4	4.6	-9.9	52.1	Peak Max	H	124	260	74	-21.9	Pass	RB
1598.477	63.7	2.5	-15.3	50.9	Peak Max	V	182	155	74	-23.1	Pass	RB
1598.477	40.1	2.5	-15.3	27.3	Average Max	V	182	155	54	-26.7	Pass	RB
Legend: TX = Transmitter Emissions; DIG = Digital Emissions; FUND = Fundamental; WB = Wideband Emission RB = Restricted Band (15.209 Limits); NRB = Non Restricted Band, Limit is 20dB below fundamental peak												

This test report may be reproduced in full only. The document may only be updated by MiCOM Labs personnel. Any changes will be noted in the Document History section of the report.



Title: Ear Force Z300 RX Wireless Audio Headset
To: FCC 47 CFR Part 15.247 & IC RSS-210
Serial #: COMM39-U2 Rev A
Issue Date: 25th July 2013
Page: 127 of 145

Test Freq.	2402	Engineer	JMH
Variant	802.15.2	Temp (°C)	17.5
Freq. Range	1000 MHz - 18000 MHz	Rel. Hum.(%)	36
Power Setting	0 dBm	Press. (mBars)	1011
Antenna	Integral 2.8	Duty Cycle (%)	100
Test Notes 1	XP510RX Headphones		
Test Notes 2	EDR 8 DPSK		

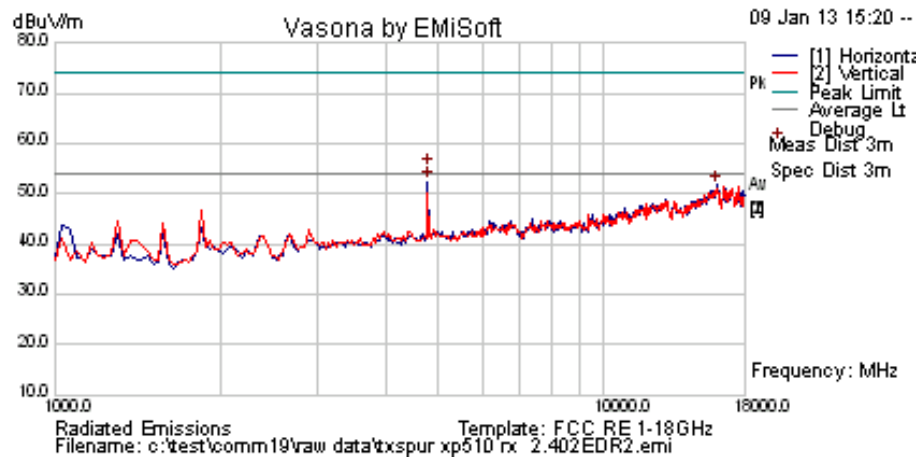

Formally measured emission peaks

Frequency MHz	Raw dBuV	Cable Loss	AF dB	Level dBuV/m	Measurement Type	Pol	Hgt cm	Azt Deg	Limit dBuV/m	Margin dB	Pass /Fail	Comments
16058.116	42.4	9.0	0.3	51.6	Peak [Scan]	H	100	0	54.0	-2.4	Pass	Noise
4803.928	60.2	4.5	-9.7	54.9	Peak Max	H	153	297	74.0	-19.1	Pass	RB
4803.928	57.8	4.5	-9.7	52.6	Average Max	H	153	297	54	-1.5	Pass	RB

Legend: TX = Transmitter Emissions; DIG = Digital Emissions; FUND = Fundamental; WB = Wideband Emission
 RB = Restricted Band (15.209 Limits); NRB = Non Restricted Band, Limit is 20dB below fundamental peak

This test report may be reproduced in full only. The document may only be updated by MiCOM Labs personnel. Any changes will be noted in the Document History section of the report.



Title: Ear Force Z300 RX Wireless Audio Headset
To: FCC 47 CFR Part 15.247 & IC RSS-210
Serial #: COMM39-U2 Rev A
Issue Date: 25th July 2013
Page: 128 of 145

Band Edge

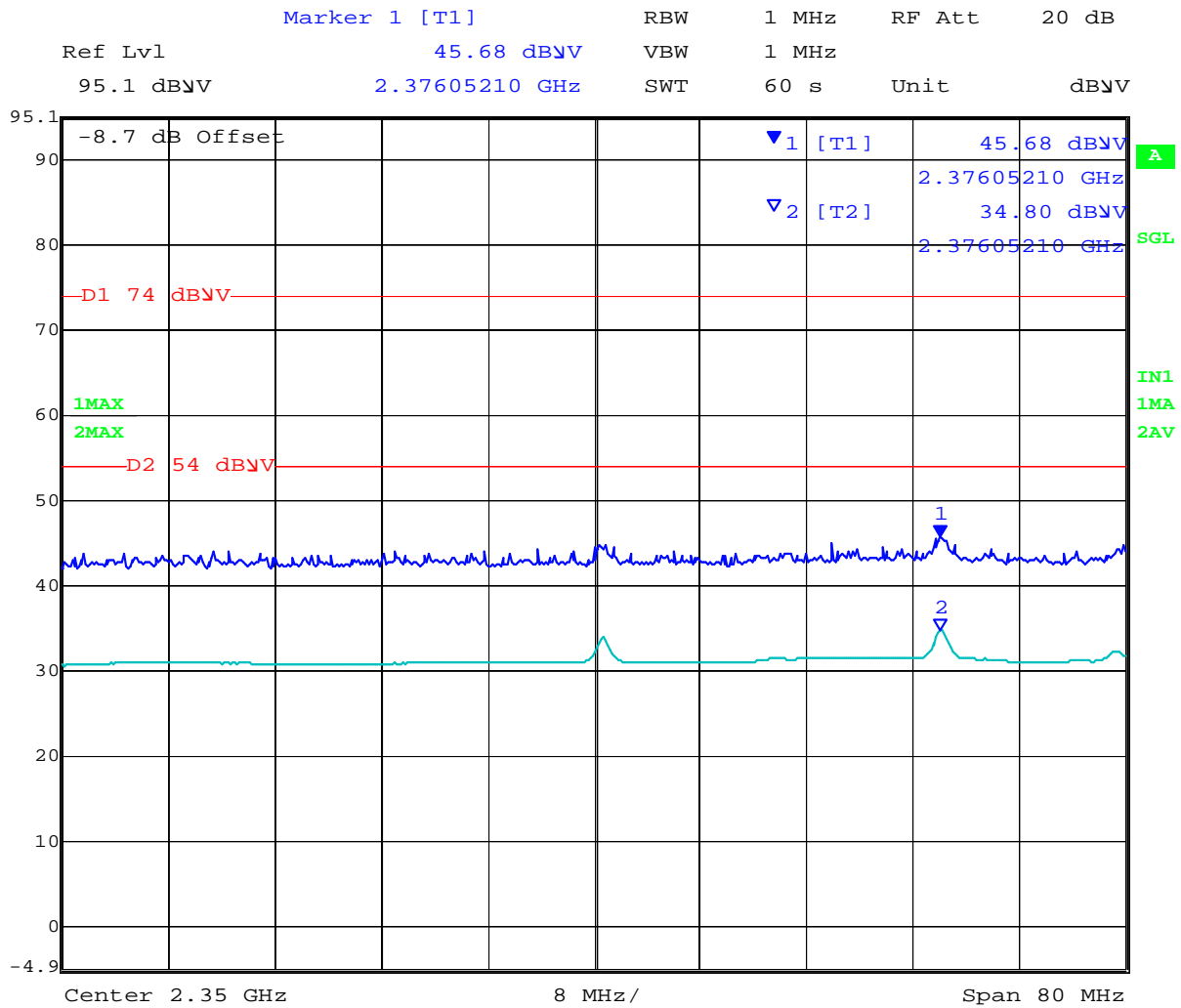

Date: 9.JAN.2013 21:13:56

This test report may be reproduced in full only. The document may only be updated by MiCOM Labs personnel. Any changes will be noted in the Document History section of the report.



Title: Ear Force Z300 RX Wireless Audio Headset
To: FCC 47 CFR Part 15.247 & IC RSS-210
Serial #: COMM39-U2 Rev A
Issue Date: 25th July 2013
Page: 129 of 145

Test Freq.	2441	Engineer	JMH
Variant	802.15.2	Temp (°C)	17.5
Freq. Range	1000 MHz - 18000 MHz	Rel. Hum.(%)	36
Power Setting	0 dBm	Press. (mBars)	1011
Antenna	Integral 2.8	Duty Cycle (%)	100
Test Notes 1	XP510RX Headphones		
Test Notes 2	EDR 8 DPSK		

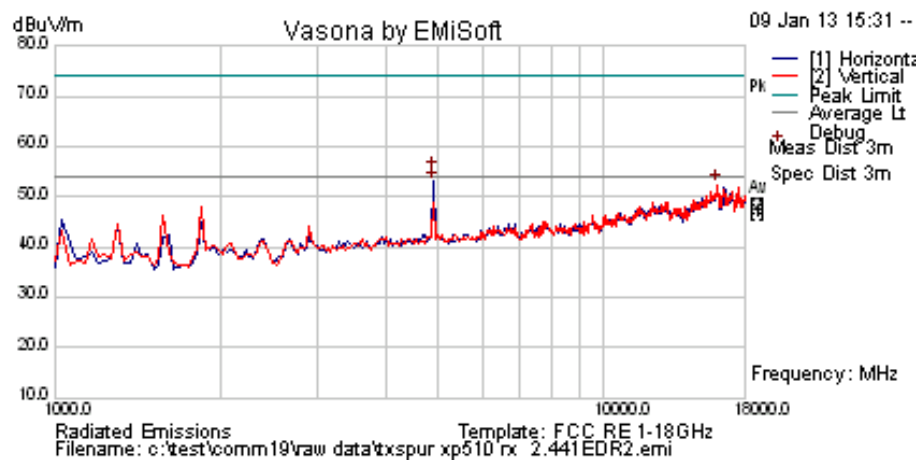

Formally measured emission peaks

Frequency MHz	Raw dBuV	Cable Loss	AF dB	Level dBuV/m	Measurement Type	Pol	Hgt cm	Azt Deg	Limit dBuV/m	Margin dB	Pass /Fail	Comments
16024.048	43.2	9.0	0.2	52.4	Peak [Scan]	V	150	0	54.0	-1.6	Pass	Noise
4881.9638	60.3	4.5	-9.7	55.1	Peak Max	H	151	298	74.0	-18.9	Pass	RB
4881.964	58.1	4.5	-9.7	52.9	Average Max	H	151	298	54	-1.2	Pass	RB

Legend: TX = Transmitter Emissions; DIG = Digital Emissions; FUND = Fundamental; WB = Wideband Emission
 RB = Restricted Band (15.209 Limits); NRB = Non Restricted Band, Limit is 20dB below fundamental peak

This test report may be reproduced in full only. The document may only be updated by MiCOM Labs personnel. Any changes will be noted in the Document History section of the report.



Title: Ear Force Z300 RX Wireless Audio Headset
To: FCC 47 CFR Part 15.247 & IC RSS-210
Serial #: COMM39-U2 Rev A
Issue Date: 25th July 2013
Page: 130 of 145

Test Freq.	2480	Engineer	JMH
Variant	802.15.2	Temp (°C)	17.5
Freq. Range	1000 MHz - 18000 MHz	Rel. Hum.(%)	36
Power Setting	0 dBm	Press. (mBars)	1011
Antenna	Integral 2.8	Duty Cycle (%)	100
Test Notes 1			
Test Notes 2	EDR 8 DPSK		

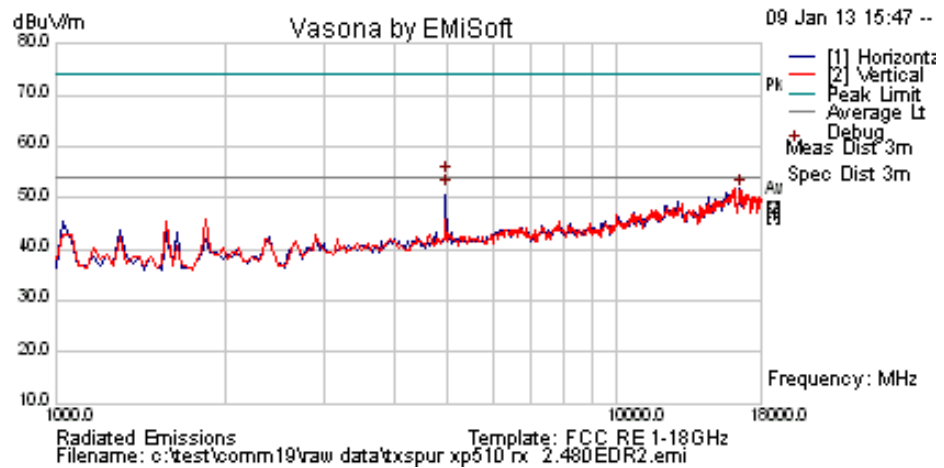

Formally measured emission peaks

Frequency MHz	Raw dBuV	Cable Loss	AF dB	Level dBuV/m	Measurement Type	Pol	Hgt cm	Azt Deg	Limit dBuV/m	Margin dB	Pass /Fail	Comments
16543.263	42.3	8.8	0.4	51.5	Peak [Scan]	H	98	337	54.0	-2.5	Pass	Noise
4960	59.5	4.6	-9.9	54.2	Peak Max	H	144	300	74.0	-19.8	Pass	RB
4960.000	57.1	4.6	-9.9	51.8	Average Max	H	144	300	54	-2.2	Pass	RB

Legend: TX = Transmitter Emissions; DIG = Digital Emissions; FUND = Fundamental; WB = Wideband Emission
 RB = Restricted Band (15.209 Limits); NRB = Non Restricted Band, Limit is 20dB below fundamental peak

This test report may be reproduced in full only. The document may only be updated by MiCOM Labs personnel. Any changes will be noted in the Document History section of the report.



Title: Ear Force Z300 RX Wireless Audio Headset
To: FCC 47 CFR Part 15.247 & IC RSS-210
Serial #: COMM39-U2 Rev A
Issue Date: 25th July 2013
Page: 131 of 145

Test Freq.	2402 MHz	Engineer	0
Variant	0	Temp (°C)	0
Freq. Range	1000 MHz - 18000 MHz	Rel. Hum.(%)	0
Power Setting	Receiver	Press. (mBars)	0
Antenna	Integral 2.8	Duty Cycle (%)	100
Test Notes 1			
Test Notes 2	1000 MHz - 18000 MHz		

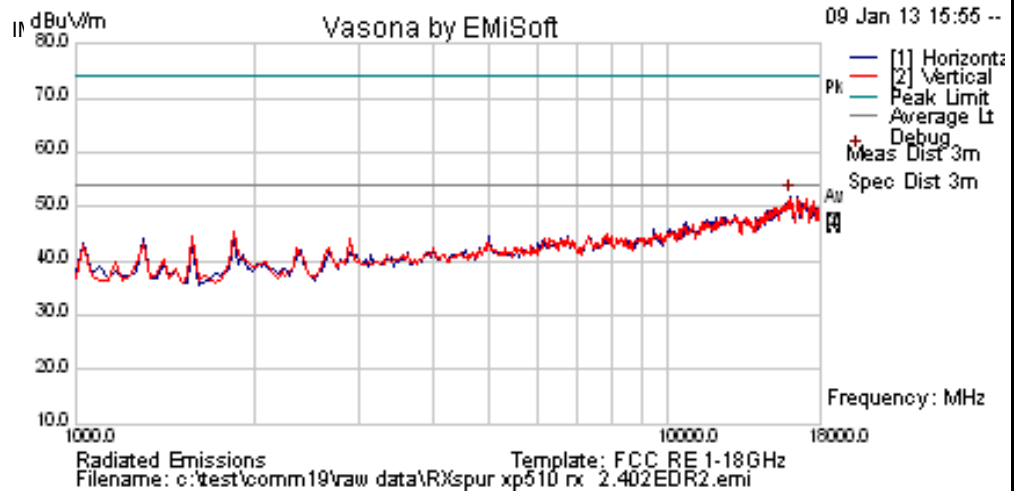

Formally measured emission peaks

Frequency MHz	Raw dBuV	Cable Loss	AF dB	Level dBuV/m	Measurement Type	Pol	Hgt cm	Azt Deg	Limit dBuV/m	Margin dB	Pass /Fail	Comments
15989.980	42.8	9.0	0.1	51.9	Peak [Scan]	H	100	0	54.0	-2.1	Pass	Noise

Legend: TX = Transmitter Emissions; DIG = Digital Emissions; FUND = Fundamental; WB = Wideband Emission
 RB = Restricted Band (15.209 Limits); NRB = Non Restricted Band, Limit is 20dB below fundamental peak

This test report may be reproduced in full only. The document may only be updated by MiCOM Labs personnel. Any changes will be noted in the Document History section of the report.



Title: Ear Force Z300 RX Wireless Audio Headset
To: FCC 47 CFR Part 15.247 & IC RSS-210
Serial #: COMM39-U2 Rev A
Issue Date: 25th July 2013
Page: 132 of 145

Band Edge:

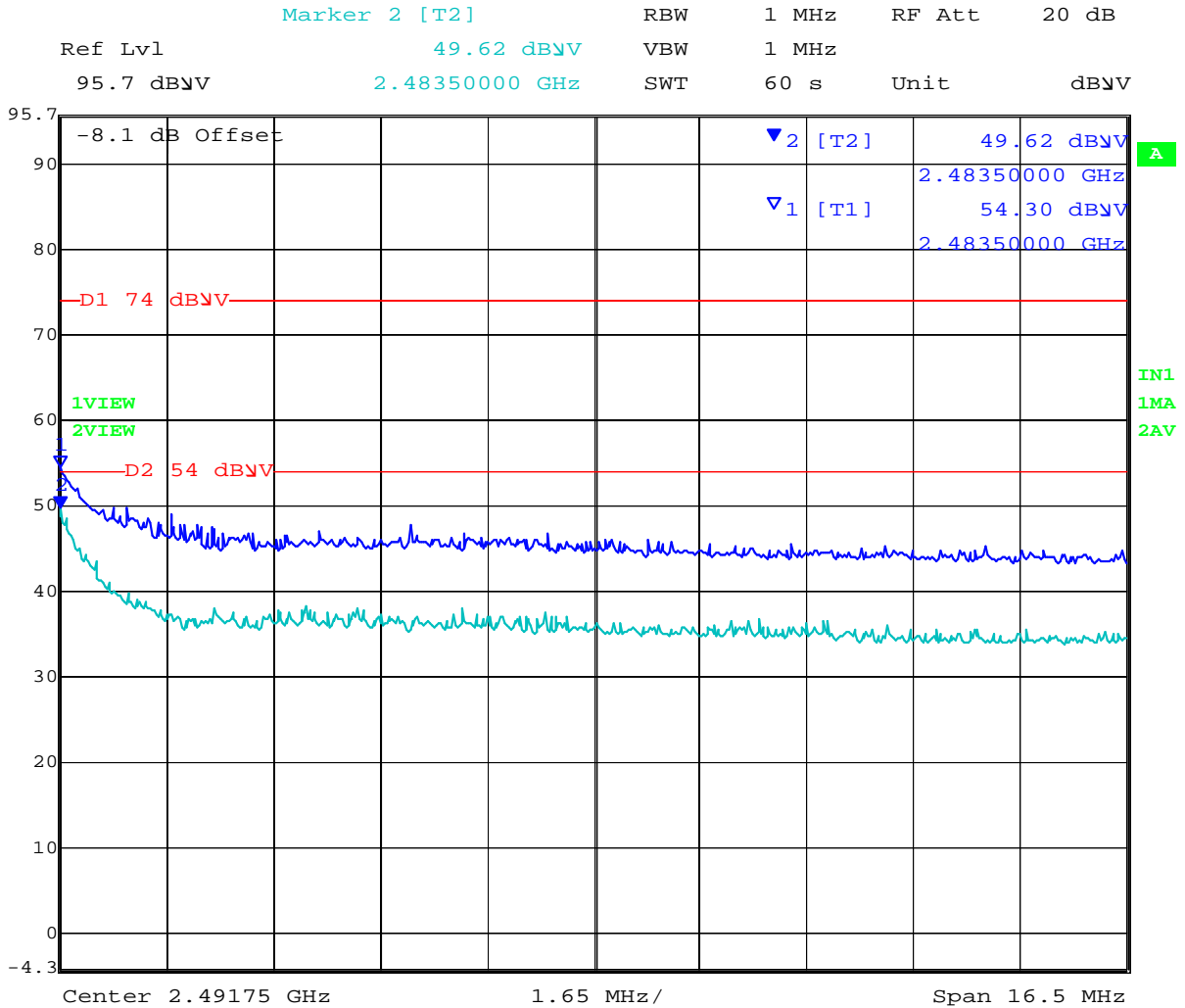

Date: 9.JAN.2013 21:29:28

This test report may be reproduced in full only. The document may only be updated by MiCOM Labs personnel. Any changes will be noted in the Document History section of the report.



Title: Ear Force Z300 RX Wireless Audio Headset
To: FCC 47 CFR Part 15.247 & IC RSS-210
Serial #: COMM39-U2 Rev A
Issue Date: 25th July 2013
Page: 133 of 145

Hopping Band Edge: 2390-2400

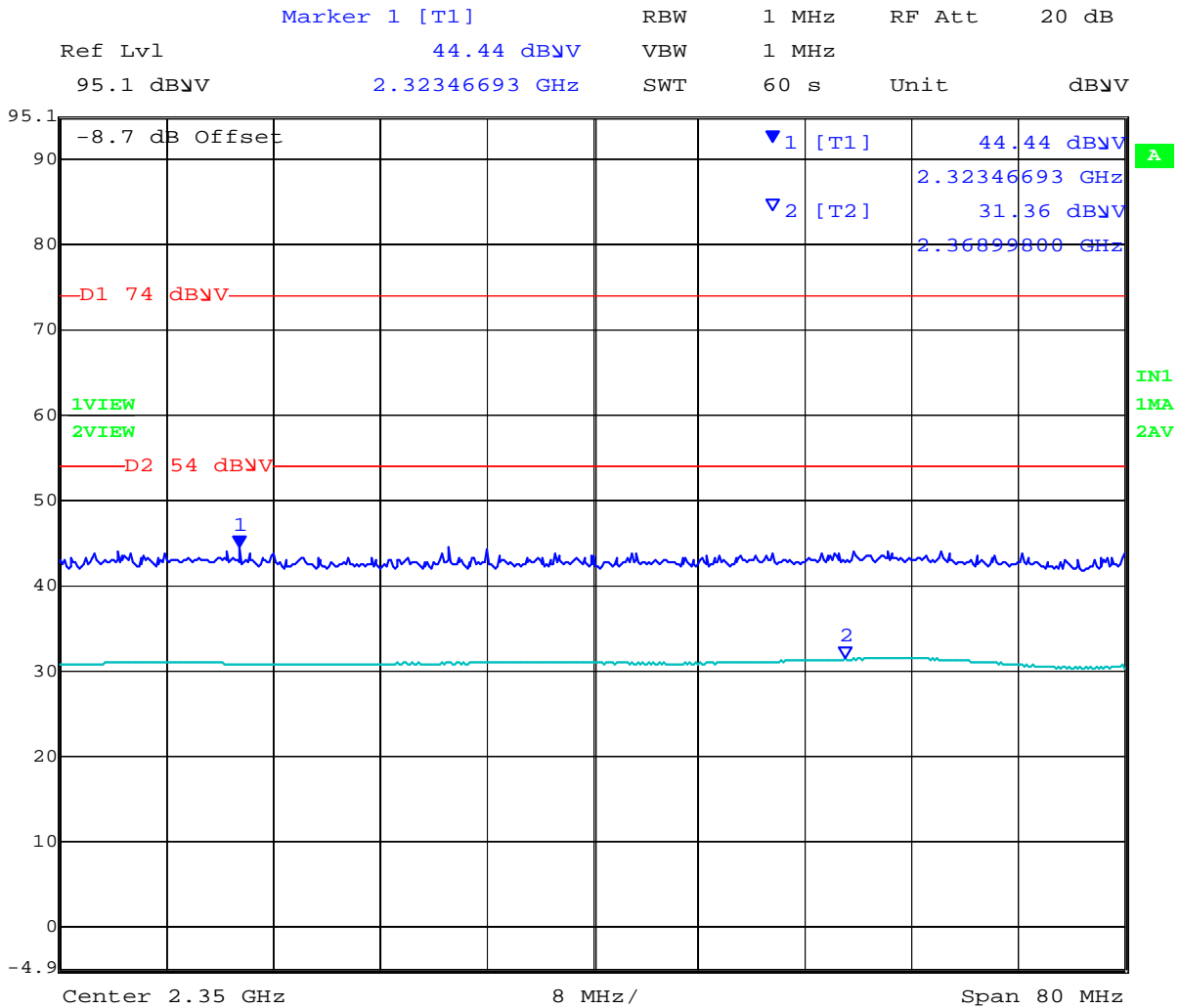

Date: 9.JAN.2013 21:34:26

This test report may be reproduced in full only. The document may only be updated by MiCOM Labs personnel. Any changes will be noted in the Document History section of the report.



Title: Ear Force Z300 RX Wireless Audio Headset
To: FCC 47 CFR Part 15.247 & IC RSS-210
Serial #: COMM39-U2 Rev A
Issue Date: 25th July 2013
Page: 134 of 145

Hopping Band Edge: 2483.5-2500

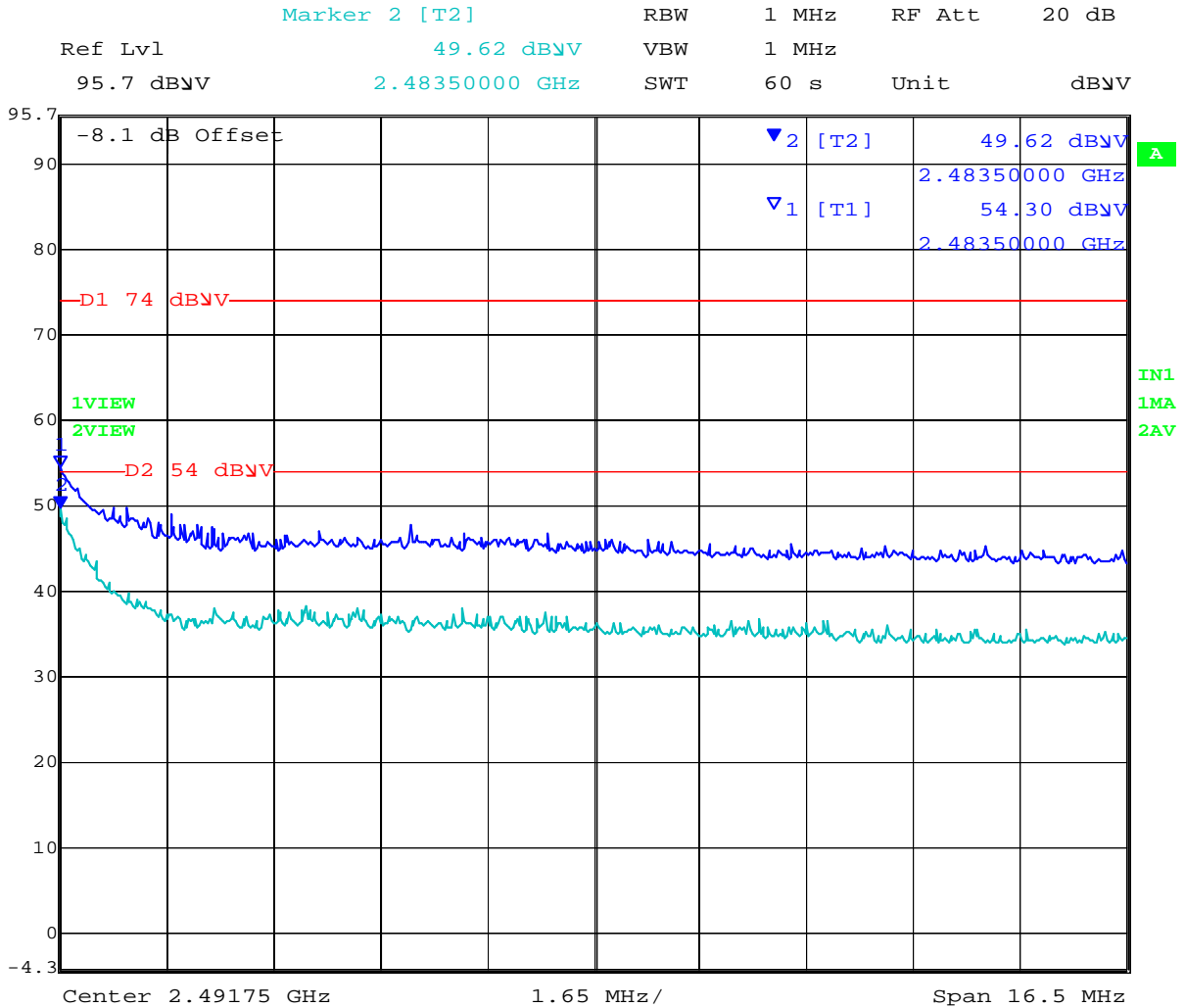

Date: 9.JAN.2013 21:29:28

This test report may be reproduced in full only. The document may only be updated by MiCOM Labs personnel. Any changes will be noted in the Document History section of the report.



Title: Ear Force Z300 RX Wireless Audio Headset
To: FCC 47 CFR Part 15.247 & IC RSS-210
Serial #: COMM39-U2 Rev A
Issue Date: 25th July 2013
Page: 135 of 145

Specification Limits

FCC §15.247(d) In any 100 kHz bandwidth outside the frequency band in which the spread spectrum or digitally modulated intentional radiator is operating, the radio frequency power that is produced by the intentional radiator shall be at least 20 dB below that in the 100 kHz bandwidth within the band that contains the highest level of the desired power, based on either an RF conducted or radiated measurement, provided the transmitter demonstrates compliance with the peak conducted power limits.

If the transmitter complies with the conducted power limits based on the use of RMS averaging over a time interval, as permitted under paragraph (b)(3) of this section, the attenuation required under this paragraph shall be 30 dB instead of 20 dB. Attenuation below the general limits specified §15.209(a) is not required. In addition, radiated emissions which fall in the restricted bands, as defined in Section §15.205(a), must also comply with the radiated emission limits specified in Section 15.209(a) (see Section 15.205(a)).

IC RSS-210 §A8.5 In any 100 kHz bandwidth outside the frequency band in which the spread spectrum or digitally modulated device is operating, the RF power that is produced shall be at least 20 dB below that in the 100 kHz bandwidth within the band that contains the highest level of the desired power, based on either an RF conducted or a radiated measurement, provided that the transmitter demonstrates compliance with the peak conducted power limits. If the transmitter complies with the conducted power limits based on the use of root-mean-square averaging over a time interval, as permitted under Section A8.4 (4), the attenuation required shall be 30 dB instead of 20 dB. Attenuation below the general field strength limits specified in RSS-Gen is not required

FCC §15.205 (a) Except as shown in paragraph (d) of 15.205 (a), only spurious emissions are permitted in any of the frequency bands listed.

FCC §15.205 (a) Except as shown in paragraphs (d) and (e) of this section, the field strength of emissions appearing within these frequency bands shall not exceed the limits shown in Section §15.209. At frequencies equal to or less than 1000 MHz, compliance with the limits in Section 15.209 shall be demonstrated using measurement instrumentation employing a CISPR quasi-peak detector. Above 1000 MHz, compliance with the emission limits in Section 15.209 shall be demonstrated based on the average value of the measured emissions. The provisions in Section 15.35 apply to these measurements.

FCC §15.209 (a) Except as provided elsewhere in this subpart, the emissions from an intentional radiator shall not exceed the field strength levels specified in the following table.

This test report may be reproduced in full only. The document may only be updated by MiCOM Labs personnel. Any changes will be noted in the Document History section of the report.



Title: Ear Force Z300 RX Wireless Audio Headset
To: FCC 47 CFR Part 15.247 & IC RSS-210
Serial #: COMM39-U2 Rev A
Issue Date: 25th July 2013
Page: 136 of 145

§15.209 (a) Limit Matrix

Frequency(MHz)	Field Strength ($\mu\text{V}/\text{m}$)	Field Strength ($\text{dB}\mu\text{V}/\text{m}$)	Measurement Distance (meters)
30-88	100	40.0	3
88-216	150	43.5	3
216-960	200	46.0	3
Above 960	500	54.0	3

Laboratory Measurement Uncertainty for Radiated Emissions

Measurement uncertainty	+5.6/ -4.5 dB
-------------------------	---------------

Traceability

Method	Test Equipment Used
Measurements were made per work instruction WI-03 'Measurement of Radiated Emissions'	0088, 0158, 0134, 0304, 0311, 0315, 0310, 0312

This test report may be reproduced in full only. The document may only be updated by MiCOM Labs personnel. Any changes will be noted in the Document History section of the report.



Title: Ear Force Z300 RX Wireless Audio Headset
To: FCC 47 CFR Part 15.247 & IC RSS-210
Serial #: COMM39-U2 Rev A
Issue Date: 25th July 2013
Page: 137 of 145

6.1.2.2. Digital Emissions (0.03-1 GHz)

FCC, Part 15 Subpart C §15.205/ §15.209
Industry Canada RSS-Gen §7.2.5

Test Procedure

Testing 30M-1 GHz was performed in a 3-meter anechoic chamber using a CISPR compliant receiver. Preliminary radiated emissions were measured on every azimuth and with the receiving antenna in both horizontal and vertical polarizations. To further maximize emissions the receive antenna was varied between 1 and 4 meters. The emissions are recorded with receiver in peak hold mode. Emissions closest to the limits are measured in the quasi-peak mode with the tuned receiver using a bandwidth of 120 kHz. Only the highest emissions relative to the limit are listed. The anechoic chamber test set-up is identified in Section 6 Test Set-Up Photographs.

The EUT had two methods of powering on ac/dc converter and Power over Ethernet (POE). Both modes were tested for emissions below 1GHz.

Field Strength Calculation

The field strength is calculated by adding the Antenna Factor and Cable Loss, and subtracting Amplifier Gain from the measured reading. In this test facility, the Antenna Factor, Cable Loss, and Amplifier Gains are loaded into the Rohde & Schwarz Receiver and the corrected field strength can be read directly on the receiver.

$$FS = R + AF + CORR$$

where:

FS = Field Strength
R = Measured Receiver Input Amplitude
AF = Antenna Factor
CORR = Correction Factor = CL – AG + NFL
CL = Cable Loss
AG = Amplifier Gain

For example:

Given a Receiver input reading of 51.5dB μ V; Antenna Factor of 8.5dB; Cable Loss of 1.3dB; Falloff Factor of 0dB, an Amplifier Gain of 26dB and Notch Filter Loss of 1dB. The Field Strength of the measured emission is:

$$FS = 51.5 + 8.5 + 1.3 - 26.0 + 1 = 36.3\text{dB}\mu\text{V/m}$$

Conversion between dB μ V/m (or dB μ V) and μ V/m (or μ V) are done as:

$$\text{Level (dB}\mu\text{V/m)} = 20 * \text{Log (level (\mu\text{V/m}))}$$

$$\begin{aligned} 40 \text{ dB}\mu\text{V/m} &= 100\mu\text{V/m} \\ 48 \text{ dB}\mu\text{V/m} &= 250\mu\text{V/m} \end{aligned}$$

This test report may be reproduced in full only. The document may only be updated by MiCOM Labs personnel. Any changes will be noted in the Document History section of the report.



Title: Ear Force Z300 RX Wireless Audio Headset
To: FCC 47 CFR Part 15.247 & IC RSS-210
Serial #: COMM39-U2 Rev A
Issue Date: 25th July 2013
Page: 138 of 145

Test Freq.	NA	Engineer	JMH
Variant	Digital Emissions	Temp (°C)	19
Freq. Range	30 MHz - 1000 MHz	Rel. Hum.(%)	36
Power Setting		Press. (mBars)	1002
Antenna			
Test Notes 1	XP510RX		
Test Notes 2			

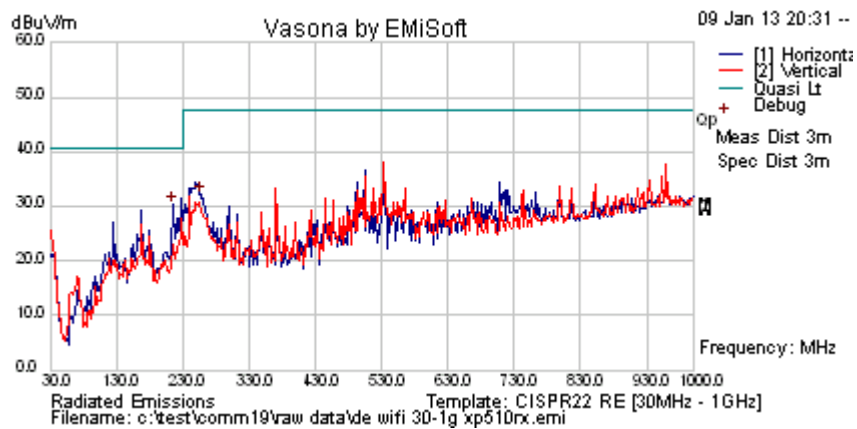

Formally measured emission peaks

Frequency MHz	Raw dBuV	Cable Loss	AF dB	Level dBuV/m	Measurement Type	Pol	Hgt cm	Azt Deg	Limit dBuV/m	Margin dB	Pass /Fail	Comments
215.27	45.54	4.7	-20.0	30.29	Peak [Scan]	H	98	0	40.5	-10.21	Pass	
257.465	45.81	4.9	-18.7	32.03	Peak [Scan]	H	98	0	47.5	-15.47	Pass	

Legend: DIG = Digital Device Emission; TX = Transmitter Emission; FUND = Fundamental Frequency
 NRB = Non-Restricted Band, Limit is 20 dB below Fundamental; RB = Restricted Band

This test report may be reproduced in full only. The document may only be updated by MiCOM Labs personnel. Any changes will be noted in the Document History section of the report.



Title: Ear Force Z300 RX Wireless Audio Headset
To: FCC 47 CFR Part 15.247 & IC RSS-210
Serial #: COMM39-U2 Rev A
Issue Date: 25th July 2013
Page: 139 of 145

Specification

Limits

§15.205 (a) Except as shown in paragraph (d) of 15.205 (a), only spurious emissions are permitted in any of the frequency bands listed.

§15.205 (a) Except as shown in paragraphs (d) and (e) of this section, the field strength of emissions appearing within these frequency bands shall not exceed the limits shown in Section §15.209. At frequencies equal to or less than 1000 MHz, compliance with the limits in Section 15.209 shall be demonstrated using measurement instrumentation employing a CISPR quasi-peak detector. Above 1000 MHz, compliance with the emission limits in Section 15.209 shall be demonstrated based on the average value of the measured emissions. The provisions in Section 15.35 apply to these measurements.

§15.209 (a) Except as provided elsewhere in this subpart, the emissions from an intentional radiator shall not exceed the field strength levels specified in the following table.

§15.209 (a) and Industry Canada RSS-Gen §7.2.5 Limit Matrix

Frequency(MHz)	Field Strength (μV/m)	Field Strength (dBμV/m)	Measurement Distance (meters)
30-88	100	40.0	3
88-216	150	43.5	3
216-960	200	46.0	3
Above 960	500	54.0	3

Laboratory Measurement Uncertainty for Radiated Emissions

Measurement uncertainty	+5.6/ -4.5 dB
-------------------------	---------------

Traceability

Method	Test Equipment Used
Measurements were made per work instruction WI-03 'Measurement of Radiated Emissions'	0088, 0158, 0134, 0304, 0311, 0315, 0310, 0312

This test report may be reproduced in full only. The document may only be updated by MiCOM Labs personnel. Any changes will be noted in the Document History section of the report.

6.1.3. AC Wireline Conducted Emissions (150 kHz – 30 MHz)

Not required - EUT is power by DC only.

FCC, Part 15 Subpart C §15.207
Industry Canada RSS-Gen §7.2.4

Test Procedure

The EUT is configured in accordance with ANSI C63.4. The conducted emissions are measured in a shielded room with a spectrum analyzer in peak hold in the first instance. Emissions closest to the limit are measured in the quasi-peak mode (QP) with the tuned receiver using a bandwidth of 9 kHz. The emissions are maximized further by cable manipulation. The highest emissions relative to the limit are listed.

Test Measurement Set up

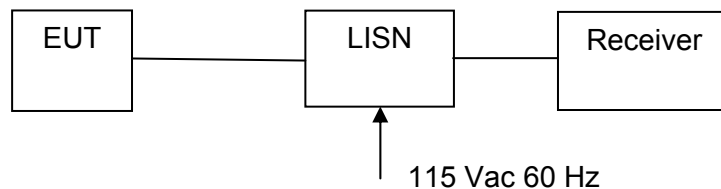

Measurement set up for AC Wireline Conducted Emissions Test

Measurement Results for AC Wireline Conducted Emissions (150 kHz – 30 MHz)

Ambient conditions.

Temperature: 17 to 23 °C Relative humidity: 31 to 57 % Pressure: 999 to 1012 mbar

Not required - EUT is power by DC only.



Title: Ear Force Z300 RX Wireless Audio Headset
To: FCC 47 CFR Part 15.247 & IC RSS-210
Serial #: COMM39-U2 Rev A
Issue Date: 25th July 2013
Page: 141 of 145

Specification

Limit

§15.207 (a) Except as shown in paragraphs (b) and (c) of this section, for an intentional radiator that is designed to be connected to the public utility (AC) power line, the radio frequency voltage that is conducted back onto the AC power line on any frequency or frequencies within the band 150 kHz to 30 MHz shall not exceed the limits in the following table, as measured using a 50 $\mu\Omega$ line impedance stabilization network (LISN), see §15.207 (a) matrix below. Compliance with the provisions of this paragraph shall be based on the measurement of the radio frequency voltage between each power line and ground at the power terminal.

RSS-Gen §7.2.4

Except when the requirements applicable to a given device state otherwise, for any radio apparatus equipped to operate from the public utility AC power supply, either directly or indirectly (such as with a battery charger), the radio frequency voltage of emissions conducted back onto the AC power lines in the frequency range of 0.15 MHz to 30 MHz shall not exceed the limits shown in the table below. The more stringent limit applies at the frequency range boundaries. The conducted emissions shall be measured with a 50 ohm/50 microhenry line impedance stabilization network (LISN).

§15.207 (a) and RSS-Gen §7.2.4 Limit Matrix

The lower limit applies at the boundary between frequency ranges

Frequency of Emission (MHz)	Conducted Limit (dB μ V)	
	Quasi-peak	Average
0.15-0.5	66 to 56*	56 to 46*
0.5-5	56	46
5-30	60	50

* Decreases with the logarithm of the frequency

Laboratory Measurement Uncertainty for Conducted Emissions

Measurement uncertainty	± 2.64 dB
-------------------------	---------------

Traceability

Method	Test Equipment Used
Measurements were made per work instruction WI-EMC-01 'Measurement of Conducted Emissions'	0158, 0184, 0287, 0190, 0293, 0307

This test report may be reproduced in full only. The document may only be updated by MiCOM Labs personnel. Any changes will be noted in the Document History section of the report.

7. PHOTOGRAPHS

7.1. Conducted Test Setup

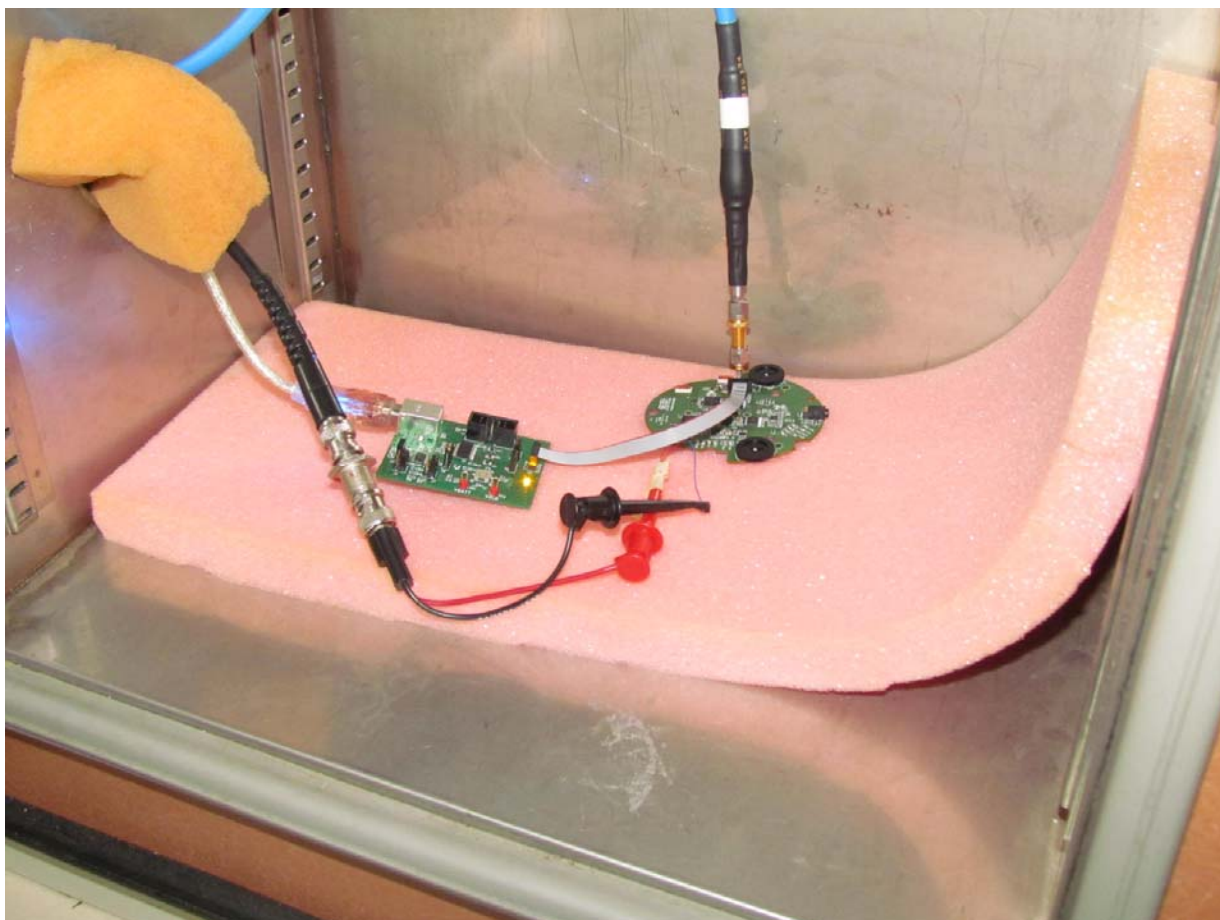

This test report may be reproduced in full only. The document may only be updated by MiCOM Labs personnel. Any changes will be noted in the Document History section of the report.

7.2. Radiated Emissions Test Setup >1 GHz

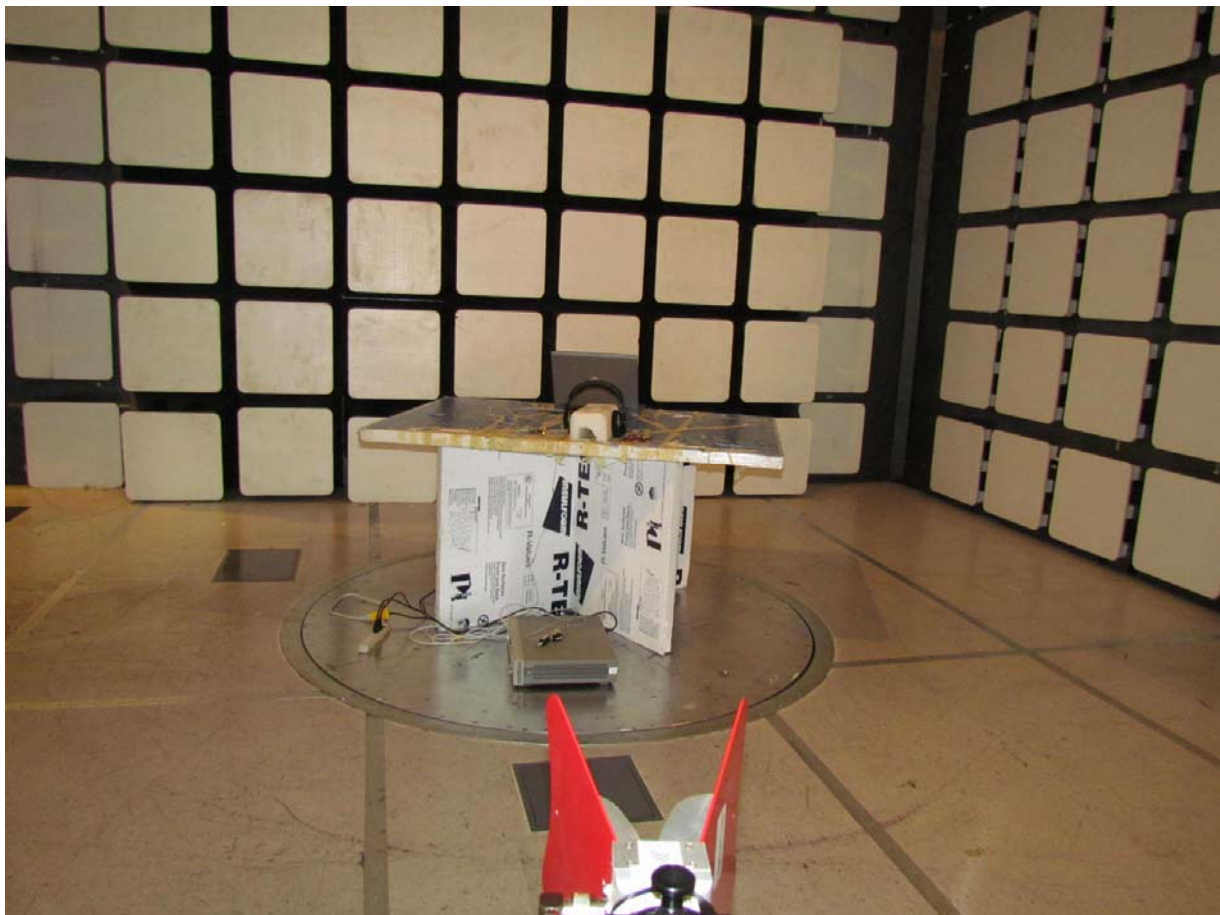

This test report may be reproduced in full only. The document may only be updated by MiCOM Labs personnel. Any changes will be noted in the Document History section of the report.



Title: Ear Force Z300 RX Wireless Audio Headset
To: FCC 47 CFR Part 15.247 & IC RSS-210
Serial #: COMM39-U2 Rev A
Issue Date: 25th July 2013
Page: 144 of 145

8. TEST EQUIPMENT

Asset #	Instrument	Manufacturer	Part #	Serial #	Calibration Due Date
0070	Power Meter	Hewlett Packard	437B	3125U11552	28 th Nov 13
0117	Power Sensor	Hewlett Packard	8487D	3318A00371	15 th Nov 13
0223	Power Meter	Hewlett Packard	EPM-442A	US37480256	15 th Nov 13
0374	Power Sensor	Hewlett Packard	8485A	3318A19694	29 th Nov 13
0376	Power Sensor	Agilent	U2000A	MY51440005	8 th Dec 13
0158	Barometer /Thermometer	Control Co.	4196	E2846	8 th Dec 13
0193	EMI Receiver	Rhode & Schwartz	ESI 7	838496/007	2 nd Dec 13
0287	EMI Receiver	Rhode & Schwartz	ESIB40	100201	16 th Nov 13
0338	30 - 3000 MHz Antenna	Sunol	JB3	A052907	8 th Nov 13
0335	1-18 GHz Horn Antenna	EMCO	3117	00066580	7 th Nov 13
0252	SMA Cable	Megaphase	Sucoflex 104	None	N/A
0293	BNC Cable	Megaphase	1689 1GVT4	15F50B001	N/A
0307	BNC Cable	Megaphase	1689 1GVT4	15F50B002	N/A
0310	2m SMA Cable	Micro-Coax	UFA210A-0-0787-3G03G0	209089-001	N/A
0312	3m SMA Cable	Micro-Coax	UFA210A-1-1181-3G0300	209092-001	N/A
0314	30dB N-Type Attenuator	ARRA	N9444-30	1623	N/A
	EMC Test Software	EMISoft	Vasona	5.0051	N/A
	RF Conducted Test Software	National Instruments	Labview	Version 8.2	N/A
	RF Conducted Test Software	MiCOM Labs ATS		Version 1.5	N/A

This test report may be reproduced in full only. The document may only be updated by MiCOM Labs personnel. Any changes will be noted in the Document History section of the report.



440 Boulder Court, Suite 200
Pleasanton, CA 94566, USA
Tel: 1.925.462.0304
Fax: 1.925.462.0306
www.micomlabs.com