

# Emissions Test Report

**EUT Name:** USB Wireless Audio Transmitter

**Model No.:** Stealth 700P Gen 2 TX

CFR 47 Part 15.247: 2020 and RSS 247 Issue 2, 2017

*Prepared for:*

Voyetra Turtle Beach, Inc.  
100 Summit Lake Drive, Suite 100  
Valhalla, New York 10595 USA

*Prepared by:*

TUV Rheinland of North America, Inc.  
1279 Quarry Lane  
Pleasanton, CA 94566  
Tel: (925) 249-9123  
Fax: (925) 249-9124  
<http://www.tuv.com/>

*Report/Issue Date:* September 15, 2020  
*Revision Number* 0  
*Project Number:* 234157758  
*Report Number:* 32063527.001



# Statement of Compliance

*Manufacturer:* Voyetra Turtle Beach, Inc.  
100 Summit Lake Drive, Suite 100  
Valhalla, New York 10595 USA

*Requester / Applicant:* Tim Blaney  
(530) 277-3482

*Name of Equipment:* USB Wireless Audio Transmitter  
*Model No 's:* Stealth 700P Gen 2 TX (TB300-3781-01)

*Type of Equipment:* Intentional Radiator  
*Application of Regulations:* CFR 47 Part 15.247: 2020 and RSS 247 Issue 2, 2017  
*Test Dates:* September 6, 2020 to September 12, 2020

## Guidance Documents:

Emissions: ANSI C63.10-2013, KDB 558074 D01 DTS Measurement Guidance v05r02

## Test Methods:

Emissions: ANSI C63.10-2013, KDB 558074 D01 DTS Measurement Guidance v05r02

The electromagnetic compatibility test and documented data described in this report has been performed and recorded by TUV Rheinland, in accordance with the standards and procedures listed herein. As the responsible authorized agent of the EMC laboratory, I hereby declare that the equipment described above has been shown to be compliant with the EMC requirements of the stated regulations and standards based on these results. If any special accessories and/or modifications were required for compliance, they are listed in the Executive Summary of this report.

This report must not be used to claim product endorsement by A2LA or any agency of the U.S. Government. This report contains data that are not covered by A2LA accreditation. This report shall not be reproduced except in full, without the written authorization of TUV Rheinland of North America.



Jeremy Luong

Kerwinn Corpuz

Test Engineer

Date September 15, 2020

Reviewer Signatory

Date September 15, 2020



Industry  
Canada

Industrie  
Canada

**Testing Cert #3331.02**

**US1131**

**2932M**

Table of Contents

<b>1</b>	<b>Executive Summary</b>	<b>7</b>
1.1	Scope	7
1.2	Purpose	7
1.3	Summary of Test Results	8
1.4	Special Accessories	8
1.5	Equipment Modifications	8
<b>2</b>	<b>Laboratory Information</b>	<b>9</b>
2.1	Accreditations & Endorsements	9
2.1.1	US Federal Communications Commission	9
2.1.2	NIST / A2LA	9
2.1.3	Canada	9
2.1.4	Japan – VCCI	9
2.1.5	Acceptance by Mutual Recognition Arrangement	9
2.2	Test Facilities	10
2.2.1	Emission Test Facility	10
2.2.2	Immunity Test Facility	10
2.3	Measurement Uncertainty	10
2.3.1	Sample Calculation – radiated & conducted emissions	11
2.3.2	Measurement Uncertainty	11
2.4	Calibration Traceability	12
<b>3</b>	<b>Product Information</b>	<b>13</b>
3.1	Product Description	13
3.2	Equipment Configuration	13
3.3	Operating Mode	13
3.4	Unique Antenna Connector	14
3.4.1	Results	14
3.5	Duty Cycle	15
3.5.1	Results	15
<b>4</b>	<b>Emissions</b>	<b>16</b>
4.1	Output Power Requirements	16
4.1.1	Test Method	16
4.1.2	Results	17
4.2	Occupied Bandwidth	20
4.2.1	Test Method	20
4.2.2	Results	20
4.3	Peak Power Spectral Density	25
4.3.1	Test Method	25
4.3.2	Results	25
4.4	Out of Band Emissions	29

## Table of Contents

4.4.1	Test Method	29
4.4.2	Results	30
<b>4.5</b>	<b>Transmit Spurious Emissions</b>	<b>34</b>
4.5.1	Test Methodology	34
4.5.2	Transmitter Spurious Emission Limit	35
4.5.3	Test Results	35
4.5.4	Sample Calculation	47
<b>4.6</b>	<b>AC Conducted Emissions</b>	<b>48</b>
4.6.1	Test Methodology	48
4.6.2	Test Results	48
<b>5</b>	<b>Test Equipment List</b>	<b>53</b>
<b>5.1</b>	<b>Equipment List</b>	<b>53</b>
<b>6</b>	<b>EMC Test Plan</b>	<b>54</b>
<b>6.1</b>	<b>Introduction</b>	<b>54</b>
<b>6.2</b>	<b>Customer</b>	<b>54</b>
<b>6.3</b>	<b>Equipment Under Test (EUT)</b>	<b>55</b>
<b>6.4</b>	<b>Test Specifications</b>	<b>58</b>

Index of Tables

**Table 1:** Summary of Test Results ..... 8  
**Table 2:** RF Output Power at the Antenna Port – Test Results ..... 17  
**Table 3:** Occupied Bandwidth – Test Results ..... 21  
**Table 4:** Peak Power Spectral Density – Test Results ..... 26  
**Table 5:** Out of Band Emissions – Test Results ..... 30  
**Table 6:** Transmit Spurious Emission at Band-Edge Requirements ..... 36  
**Table 7:** AC Conducted Emissions – Test Results ..... 48  
**Table 8:** Customer Information ..... 54  
**Table 9:** Technical Contact Information ..... 54  
**Table 10:** EUT Specifications ..... 55  
**Table 11:** Interface Specifications ..... 56  
**Table 12:** Supported Equipment ..... 56  
**Table 13:** Description of Sample used for Testing ..... 56  
**Table 14:** Description of Test Configuration used for Radiated Measurement. .... 56  
**Table 15:** Final Test Mode for 2402 MHz to 2480MHz Band ..... 57  
**Table 16:** Test Specifications ..... 58

---

# 1 Executive Summary

## 1.1 Scope

This report is intended to document the status of conformance with the requirements of the CFR 47 Part 15.247: 2020 and RSS 247 Issue 2, 2017 based on the results of testing performed on September 6, 2020 to September 12, 2020 on the USB Wireless Audio Transmitter Model Stealth 700P Gen 2 TX manufactured by Voyetra Turtle Beach, Inc. This report only applies to the specific samples tested under the stated test conditions. It is the responsibility of the manufacturer to assure that additional production units of this model are manufactured with identical or EMI equivalent electrical and mechanical components. This report is further intended to document changes and modifications to the EUT throughout its life cycle. All documentation will be included as a supplement.

## 1.2 Purpose

Testing was performed to evaluate the EMC performance of the EUT in accordance with the applicable requirements, procedures, and criteria defined in the application of regulations and application of standards listed in this report. The 2402 MHz to 2480 MHz frequency band is covered in this document.

### 1.3 Summary of Test Results

**Table 1:** Summary of Test Results

Test	Test Method ANSI C63.4	Test Parameters	Measured Value	Result
Spurious Emission in Transmitted Mode	CFR47 15.209, CFR47 15.247 (d) RSS GEN Sect.8.9	Class B	-8.71 dB (Margin)	<b>Complied</b>
Restricted Bands of Operation	CFR47 15.205, RSS GEN Sect.8.10	Class B		<b>Complied</b>
AC Power Conducted Emission	CFR47 15.207, RSS-GEN Sect.8.8	Class B	-16.36 dB (Margin)	<b>Complied</b>
Occupied Bandwidth	CFR47 15.247 (a2), RSS GEN Sect.6.7, RSS 247 Sect. 5.2 (a)	≥ 500 kHz	0.732 MHz (DTS) 1.035 MHz (99%)	<b>Complied</b>
Maximum Output Power	CFR47 15.247 (b), RSS 247 Sect. 5.4 (d)	30 dBm w/ 6 dBi antenna	+4.48 dBm	<b>Complied</b>
Peak Power Spectral Density	CFR47 15.247 (e), RSS 247 Sect. 5.2 (b)	8 dBm/ 3 kHz	-17.47 dBm	<b>Complied</b>
Out of Band Emission	CFR47 15.247 (d), RSS 247 Sect.5.5	-30 dB	-7.52 dB (Margin)	<b>Complied</b>

### 1.4 Special Accessories

No special accessories were necessary in order to achieve compliance.

### 1.5 Equipment Modifications

None



## 2 Laboratory Information

### 2.1 Accreditations & Endorsements

#### 2.1.1 US Federal Communications Commission



TUV Rheinland of North America at 1279 Quarry Ln, Pleasanton, CA 94566 is recognized by the commission for performing testing services for the general public on a fee basis. These laboratory test facilities have been fully described in reports submitted to and accepted by the FCC (US1131). The laboratory scope of accreditation includes: Title 47 CFR Parts 15, 18, and 90. The accreditation is updated every 3 years.

#### 2.1.2 NIST / A2LA



TUV Rheinland of North America is accredited by the National Voluntary Laboratory Accreditation Program, which is administered under the auspices of the National Institute of Standards and Technology. The laboratory has been assessed and accredited in accordance with ISO Guide 17025:2017 and ISO 9002 (Lab Code Testing Cert #3331.02). The scope of laboratory accreditation includes emission and immunity testing. The accreditation is updated annually.

#### 2.1.3 Canada



TUV Rheinland of North America at the 1279 Quarry Ln, Pleasanton, CA 94566 address is accredited by Industry Canada for performing testing services for the general public on a fee basis. This laboratory test facilities have been fully described in reports submitted to and accepted by Industry Canada (File Number 2932M). This reference number is the indication to the Industry Canada Certification Officers that the site meets the requirements of RSS 212, Issue 1 (Provisional). The accreditation is updated every 3 years.

#### 2.1.4 Japan – VCCI



The Voluntary Control Council for Interference by Information Technology Equipment (VCCI) is a group that consists of Information Technology Equipment (ITE) manufacturers and EMC test laboratories. The purpose of the Council is to take voluntary control measures against electromagnetic interference from Information Technology Equipment, and thereby contribute to the development of a socially beneficial and responsible state of affairs in the realm of Information Technology Equipment in Japan. TUV Rheinland of North America at 1279 Quarry Ln, Pleasanton, CA 94566 has been assessed and approved in accordance with the Regulations for Voluntary Control Measures.

VCCI Registration No. for Pleasanton: A-0326

#### 2.1.5 Acceptance by Mutual Recognition Arrangement



The United States has an established agreement with specific countries under the Asia Pacific Laboratory Accreditation Corporation (APLAC) Mutual Recognition Arrangement. Under this agreement, all TUV Rheinland at 1279 Quarry Ln, Pleasanton, CA 94566 test results and test reports within the scope of the laboratory NIST / A2LA accreditation will be accepted by each member country.

---

## 2.2 Test Facilities

All of the test facilities are located at 1279 Quarry Lane, Pleasanton, California 94566, USA.

### 2.2.1 Emission Test Facility

The Semi-Anechoic chamber and AC Line Conducted measurement facility used to collect the radiated and conducted data has been constructed in accordance with ANSI C63.7:1992. The site has been measured in accordance with and verified to comply with the theoretical normalized site attenuation requirements of ANSI C63.4-2014, at a test distance of 3 and 5 meters. The site is listed with the FCC and accredited by A2LA (Lab Code Testing Cert #3331.02). The 3/5-meter semi-anechoic chamber used to collect the radiated data has been verified to comply with the theoretical normalized site attenuation requirements of ANSI C63.4-2014, at a test distance of 3 meter and 5 meters. A report detailing this site can be obtained from TUV Rheinland of North America.

### 2.2.2 Immunity Test Facility

ESD, EFT, Surge, PQF: These tests are performed in an environmentally controlled room with a 3.7 m x 4.8 m x 3.175 mm thick aluminum floor connected to PE ground.

For ESD testing, tabletop equipment is placed on an insulated mat with a surface resistivity of  $10^9$  Ohms/square on a 1.6 m x 0.8 m x 0.8 m high non-conductive table with a 3.175 mm aluminum top (Horizontal Coupling Plane). The HCP is connected to the main ground plane via a low impedance ground strap through two 470-k $\Omega$  resistors. The Vertical Coupling Plane consists of an aluminum plate 50 cm x 50 cm x 3.175 mm thick. The VCP is connected to the main ground plane via a low impedance ground strap through two 470-k $\Omega$  resistors.

For EFT, Surge, PQF, the HCP and VCP are removed.

RF Field Immunity testing is performed in a 7.3m x 4.3m x 4.1m anechoic chamber.

RF Conducted and Magnetic Field Immunity testing is performed on a 4.8m x 3.7m x 3.175mm thick aluminum ground plane.

All test areas allow a minimum distance of 1 meter from the EUT to walls or conducting objects.

## 2.3 Measurement Uncertainty

Two types of measurement uncertainty are expressed in this report, per *ISO Guide To The Expression Of Uncertainty In Measurement*, 1<sup>st</sup> Edition, 1995.

*The Combined Standard Uncertainty* is the standard uncertainty of the result of a measurement when that result is obtained from the values of a number of other quantities; it is equal to the positive square root of the sum of the variances or co-variances of these other quantities, weighted according to how the measurement result varies with changes in these quantities. The term *standard uncertainty* is the result of a measurement expressed as a standard deviation.

### 2.3.1 Sample Calculation – radiated & conducted emissions

The field strength is calculated by subtracting the Amplifier Gain and adding the Cable Loss and Antenna Correction Factor to the measured reading. The basic equation is as follows:

$$\text{Field Strength (dB}\mu\text{V/m)} = \text{RAW} - \text{AMP} + \text{CBL} + \text{ACF}$$

Where: RAW = Measured level before correction (dBμV)

AMP = Amplifier Gain (dB)

CBL = Cable Loss (dB)

ACF = Antenna Correction Factor (dB/m)

$$\mu\text{V/m} = 10^{\frac{\text{dB}\mu\text{V} / \text{m}}{20}}$$

#### Sample radiated emissions calculation @ 30 MHz

**Measurement +Antenna Factor–Amplifier Gain+Cable loss=Radiated Emissions (dBuV/m)**

$$25 \text{ dBuV/m} + 17.5 \text{ dB} - 20 \text{ dB} + 1.0 \text{ dB} = 23.5 \text{ dBuV/m}$$

### 2.3.2 Measurement Uncertainty

Per CISPR 16-4-2	U <sub>lab</sub>	U <sub>cispr</sub>
<b>Radiated Disturbance @ 10 meters</b>		
30 – 1,000 MHz	2.25 dB	4.51 dB
<b>Radiated Disturbance @ 3 meters</b>		
30 – 1,000 MHz	2.26 dB	4.52 dB
1 – 6 GHz	2.12 dB	4.25 dB
6 – 40 GHz	2.47 dB	4.93 dB
<b>Conducted Disturbance @ Mains Terminals</b>		
150 kHz – 30 MHz	1.09 dB	2.18 dB
<b>Disturbance Power</b>		
30 MHz – 300 MHz	3.92 dB	4.3 dB

**Voltech PM6000A**

The estimated combined standard uncertainty for harmonic current and flicker measurements is $\pm 5.0\%$ .	Per CISPR 16-4-2 Methods
--	--------------------------

**Measurement Uncertainty - EMC Immunity**

The estimated combined standard uncertainty for ESD immunity measurements is $\pm 8.2\%$ .	Per IEC 61000-4-2
The estimated combined standard uncertainty for radiated immunity measurements is $\pm 4.10$ dB.	Per IEC 61000-4-3
The estimated combined standard uncertainty for conducted immunity measurements with CDN is $\pm 3.66$ dB	Per IEC 61000-4-6
The estimated combined standard uncertainty for power frequency magnetic field immunity is $\pm 2.9\%$ .	Per IEC 61000-4-8
The estimated combined standard uncertainty for EFT fast transient immunity measurements is $\pm 2.6\%$ .	Per IEC 61000-4-4
The estimated combined standard uncertainty for surge immunity measurements is $\pm 2.6\%$ .	Per IEC 61000-4-5
The estimated combined standard uncertainty for voltage variation and interruption measurements is $\pm 1.74\%$ .	Per IEC 61000-4-11

**Measurement Uncertainty – Radio Testing**

The estimated combined standard uncertainty for frequency error measurements is $\pm 3.88$ Hz
The estimated combined standard uncertainty for carrier power measurements is $\pm 0.70$ dB.
The estimated combined standard uncertainty for adjacent channel power measurements is $\pm 1.47$ dB.
The estimated combined standard uncertainty for modulation frequency response measurements is $\pm 0.46$ dB.
The estimated combined standard uncertainty for transmitter conducted emission measurements is $\pm 2.06$ dB

The expanded uncertainty at a level of 95% confidence is obtained by multiplying the combined standard uncertainty by a coverage factor of 2. Compliance criteria are not based on measurement uncertainty.

**2.4 Calibration Traceability**

All measurement instrumentation is traceable to the National Institute of Standards and Technology (NIST). Measurement method complies with ANSI/NCSL Z540-1-1994 and ISO Standard 17025:2017. Equipment calibration records are kept on file at the test facility.

---

## 3 Product Information

### 3.1 Product Description

The Stealth 700P Gen 2 Wireless Gaming System consists of two main communication modules, the Stealth 700P Gen 2 RX (“Headset”) and the Stealth 700P Gen 2 TX (“Transmitter”). These two modules comprise a closed-loop wireless audio gaming system that utilize a proprietary 2.4 GHz communication technology to offer wireless streaming audio and chat/talkback capabilities. The devices are designed to operate with a PS4 gaming console or PC-based system.

### 3.2 Equipment Configuration

A description of the equipment configuration is given in the Test Plan Section. The EUT was tested as called for in the test standard and was configured and operated in a manner consistent with its intended use. The EUT was connected to rated power and allowed to reach intended operating conditions. The placement of the EUT system components was guided by the test standard and selected to represent typical installation conditions.

In the case of an EUT that can operate in more than one configuration, preliminary testing was performed to determine the configuration that produced maximum radiation.

The final configuration was selected to produce the worst case radiation for emissions testing and to place the EUT in the most susceptible state for immunity testing.

### 3.3 Operating Mode

A description of the operation mode is given in the Test Plan Section. In the case of an EUT that can operate in more than one state, preliminary testing was performed to determine the operating mode that produced maximum radiation.

The final operating mode was selected to produce the worst case radiation for emissions testing and to place the EUT in the most susceptible state for immunity testing.

### 3.4 Unique Antenna Connector

An intentional radiator shall be designed to ensure that no antenna other than that furnished by the responsible party shall be used with the device. The use of a permanently attached antenna or of an antenna that uses a unique coupling to the intentional radiator shall be considered sufficient to comply with the provisions of this Section. The manufacturer may design the unit so that a broken antenna can be replaced by the user, but the use of a standard antenna jack or electrical connector is prohibited. This requirement does not apply to carrier current devices or to devices operated under the provisions of CFR47 Parts 15.211, 15.213, 15.217, 15.219, or 15.221.

#### 3.4.1 Results

The Stealth 700P Gen 2 TX uses the permanently integrated PCB trace antenna inside the device. See EUT Photo for details.

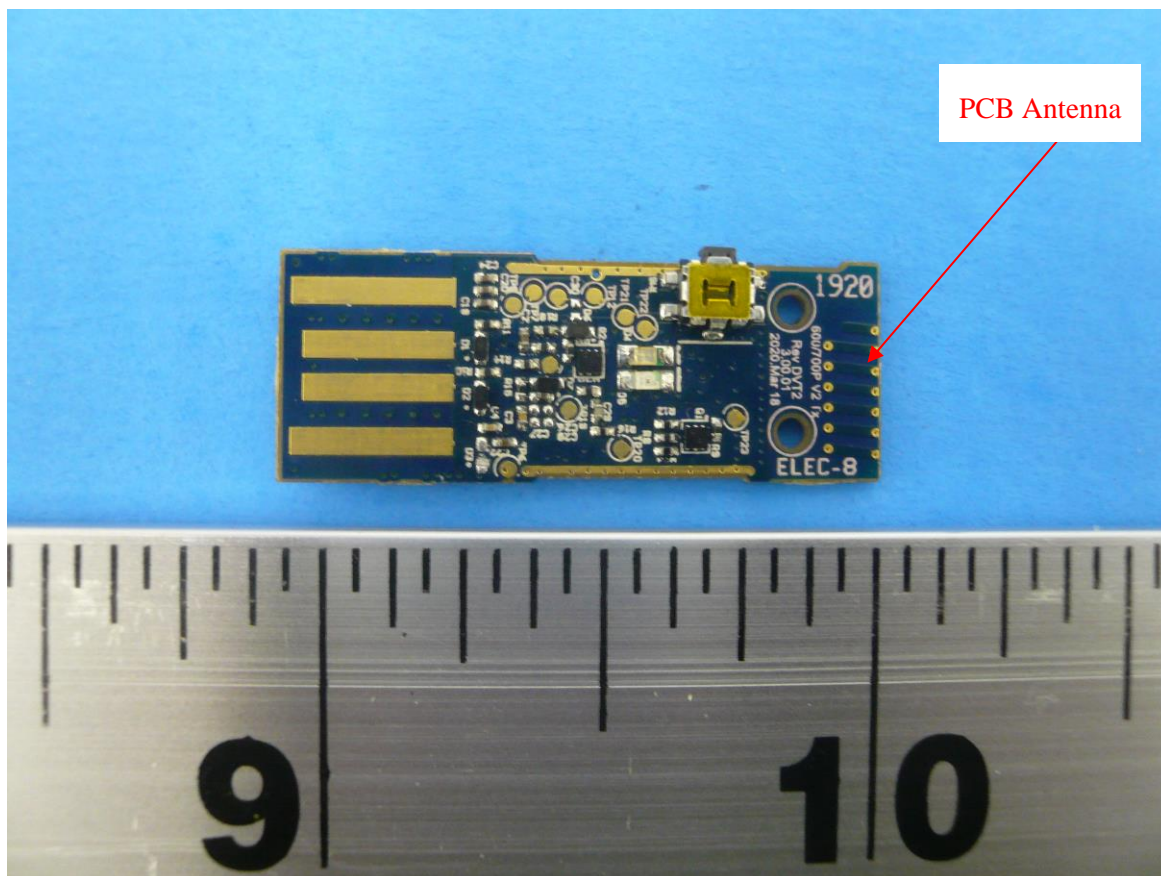

### 3.5 Duty Cycle

The Stealth 700P Gen 2 TX, SN: PP #1 was measured.

#### 3.5.1 Results

Mode	On Time (ms)	Period (ms)	Duty Cycle (%)	Duty Factor (dB)
Standard	100	0	100	0

**Notes:** EUT was configured and measured for the duty cycle. All measurements use 100% duty cycle.

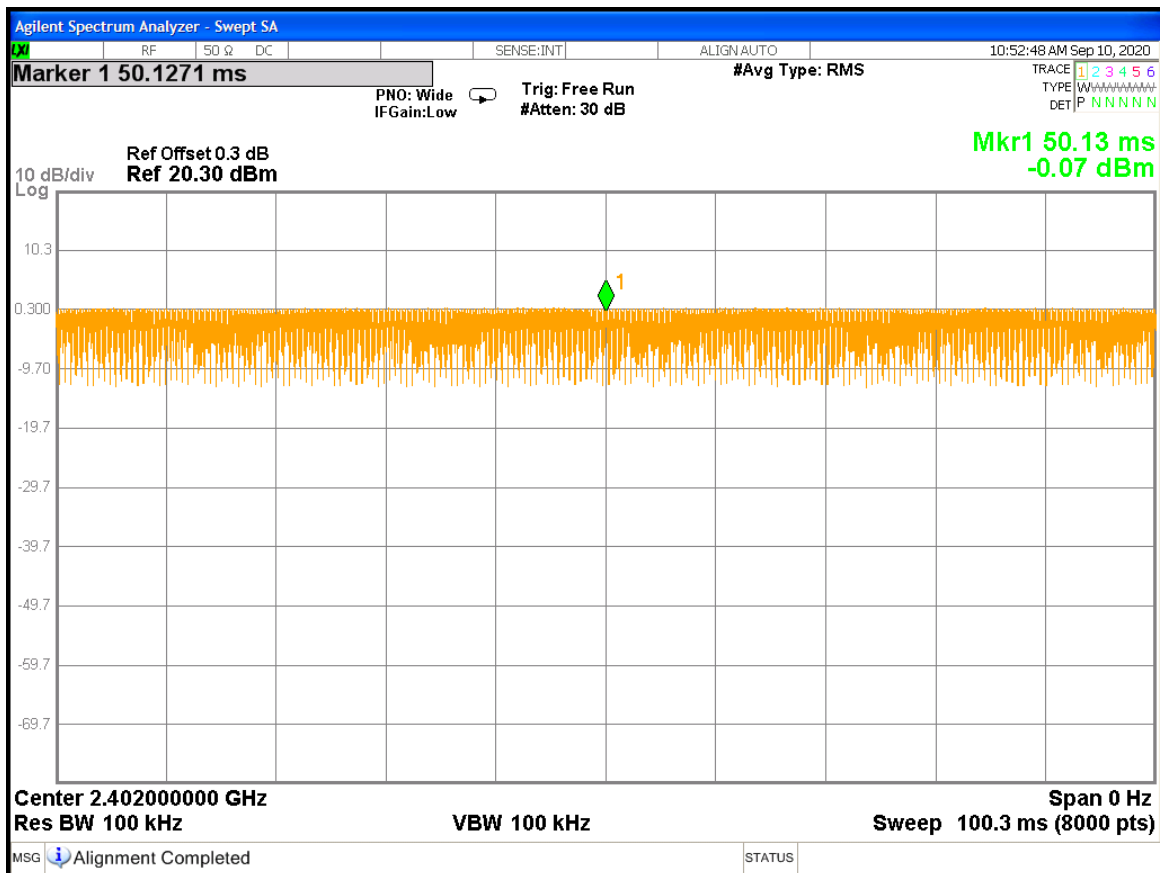

Figure 1: Duty Cycle



## 4 Emissions

Testing was performed in accordance with CFR 47 Part 15.247: 2020 and RSS 247 Issue 2, 2017. These test methods are listed under the laboratory's A2LA Scope of Accreditation. This test measures the levels emanating from the EUT, thus evaluating the potential for the EUT to cause radio frequency interference to other electronic devices. Procedures described in section 8 of the standard were used.

### 4.1 Output Power Requirements

*The maximum output power requirement is the maximum equivalent isotropic radiated power delivering at the transmitting antenna under specified conditions of measurements in the presence of modulation.*

*The maximum output power and harmonics shall not exceed CFR47 Part 15.247 (b):2020 and RSS 247: 2017 Sect. 5.4 (d).*

*The maximum transmitted powers are*

*Band 2400-2483.5 MHz: 1 W*

#### 4.1.1 Test Method

The ANSI C63.10-2013 Section 11.9.2.2.2 conducted method was used to measure the channel power output. The preliminary investigation was performed at different data rate/ chain to determine the highest power output for each mode. The worst findings were conducted on 3 channels in each operating range per CFR47 Part 15.247(b): 2018 and RSS 247 Sect. 5.4 (d). This test was conducted on 3 channels of Sample, S/N PP #1. The worst mode result indicated below.

Test Setup:

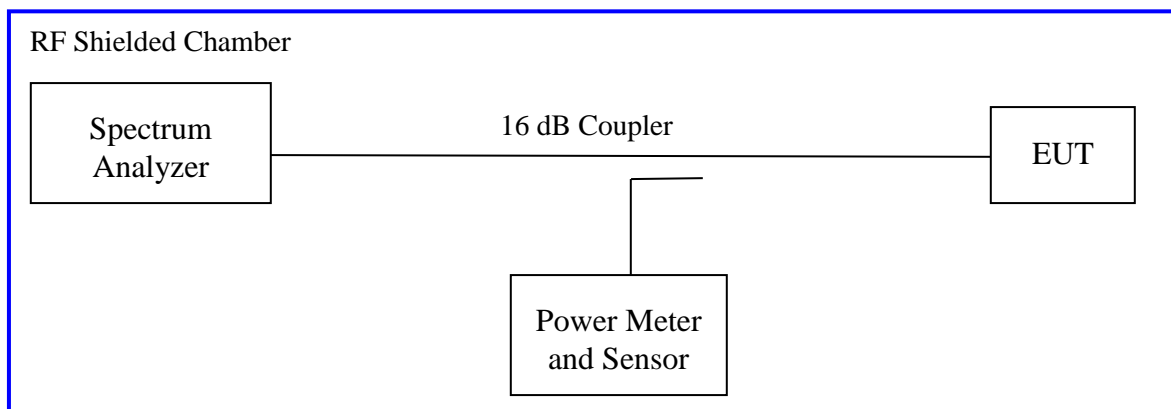

*Method AVGSA-1 of "KDB 558074 – DTS Measurement Guidance v05r02" applies since the EUT continuously transmits with duty cycle greater than 98%. Sample detector was used.*



## 4.1.2 Results

As originally tested, the EUT was found to be compliant to the requirements of the test standard(s).

**Table 2: RF Output Power at the Antenna Port – Test Results**

<b>Test Date:</b> September 8, 2020			<b>Test By:</b> Jeremy Luong		
<b>Test Method:</b> Conducted Measurements			<b>Power Setting:</b> Fixed at 4 dBm		
<b>Antenna Type:</b> Integrated PCB			<b>Max. Antenna Gain:</b> -2.4 dBi		
<b>Operating Mode:</b> Uncorrelated			<b>Signal State:</b> Modulated at 1 Mbps		
<b>Ambient Temp.:</b> 23 °C			<b>Relative Humidity:</b> 39%		
<b>USB Wireless Audio Transmitter</b>					
<b>Frequency (MHz)</b>	<b>Limit [dBm]</b>	<b>Output [dBm]</b>	<b>Duty Cycle [dB]</b>	<b>∑ Power [dBm]</b>	<b>Margin [dB]</b>
2402	+30.00	4.48			-25.52
2442	+30.00	4.15			-25.85
2480	+30.00	4.00			-26.00
<b>Note:</b> The USB transmitter transmitted at 100% duty cycle. The highest power output observed was at 1 Mbps					

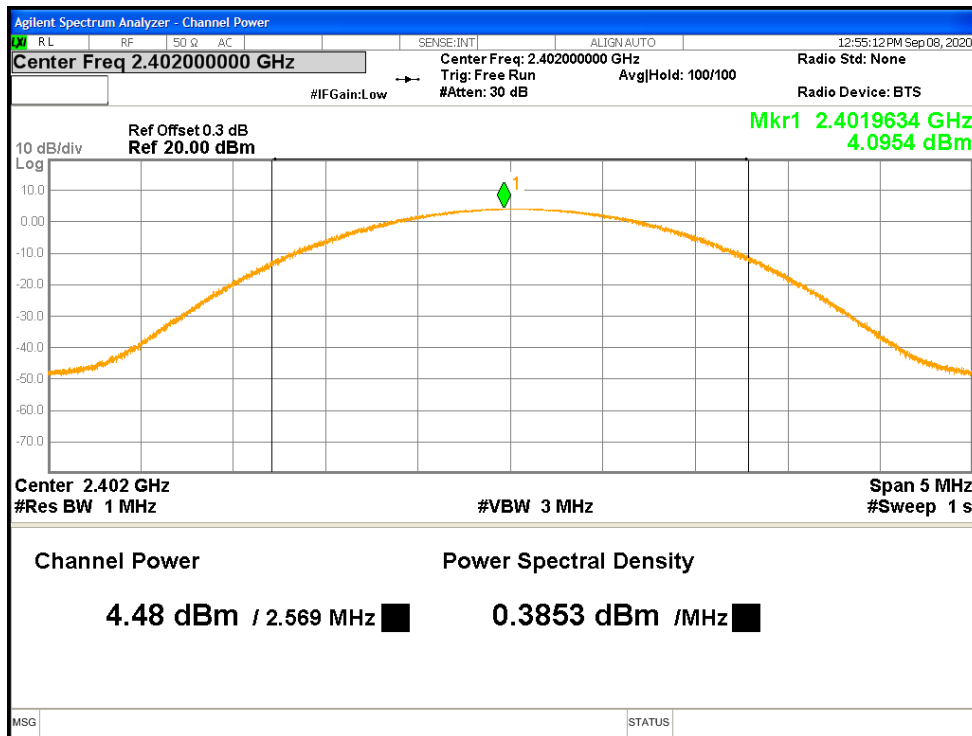

Figure 2: Maximum Conducted Output Power, 2402 MHz

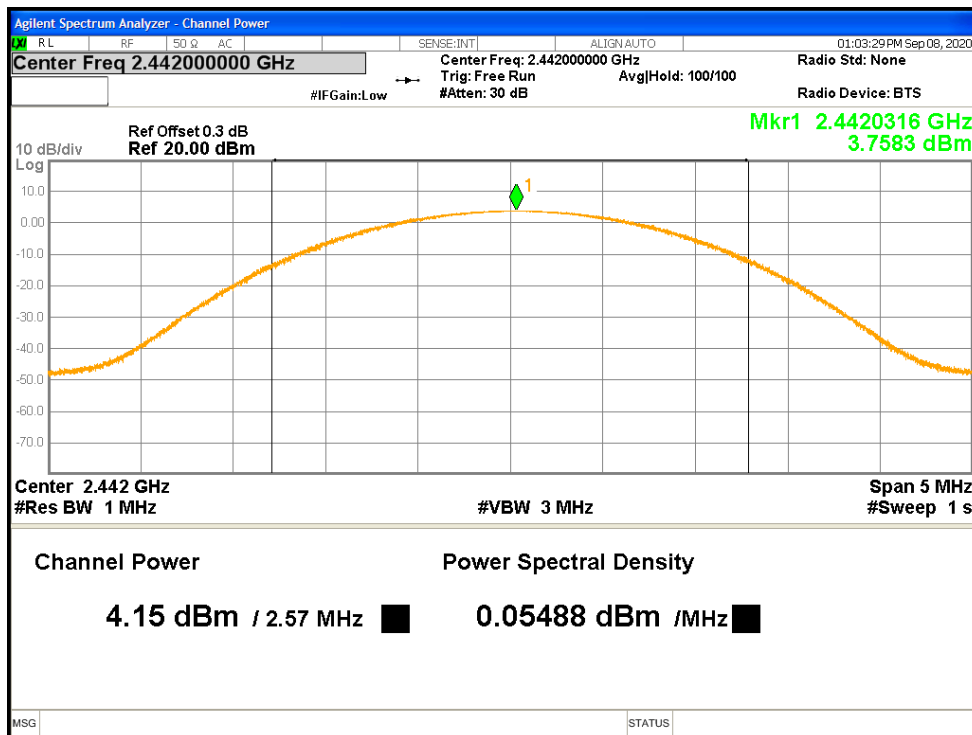

Figure 3: Maximum Conducted Output Power at 2442 MHz

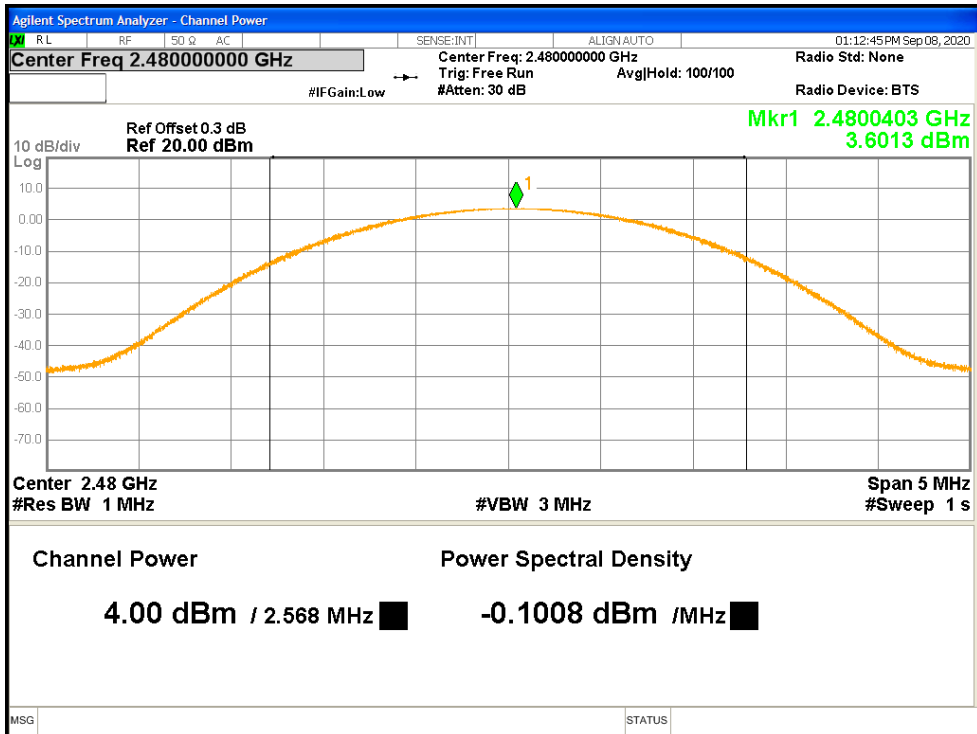

Figure 4: Maximum Conducted Output Power at 2480 MHz

## 4.2 Occupied Bandwidth

The occupied bandwidth is measured at an amplitude level reduced from the reference level by a specified ratio. The reference level is the level of the highest amplitude signal observed from the transmitter at the fundamental frequency.

The 99% bandwidth is the bandwidth in which 99% of the transmitted power occupied.

The minimum 6 dB bandwidth shall be at least 500 kHz.

The bandwidth shall be at least 500 kHz per Section CFR47 15.247(a2) 2020 and RSS 247 Sect.5.2 (a): 2017

### 4.2.1 Test Method

The conducted method was used to measure the occupied bandwidth according to ANSI C63.10:2013 Section 11.8.1. The measurement was performed with modulation per CFR47 15.247(a) (2) 2020 and RSS 247 Sect. 5.2 (a) 2017. The preliminary investigation was performed to find the narrowest 6 dB bandwidth for each operational mode at different data rates. This worst finding was performed on 3 channels in each operating frequency range; 2400 MHz to 2483.5 MHz. This test was conducted on 3 channels in each mode of Sample S/N PP #1. The worst sample result indicated below.

Test Setup:

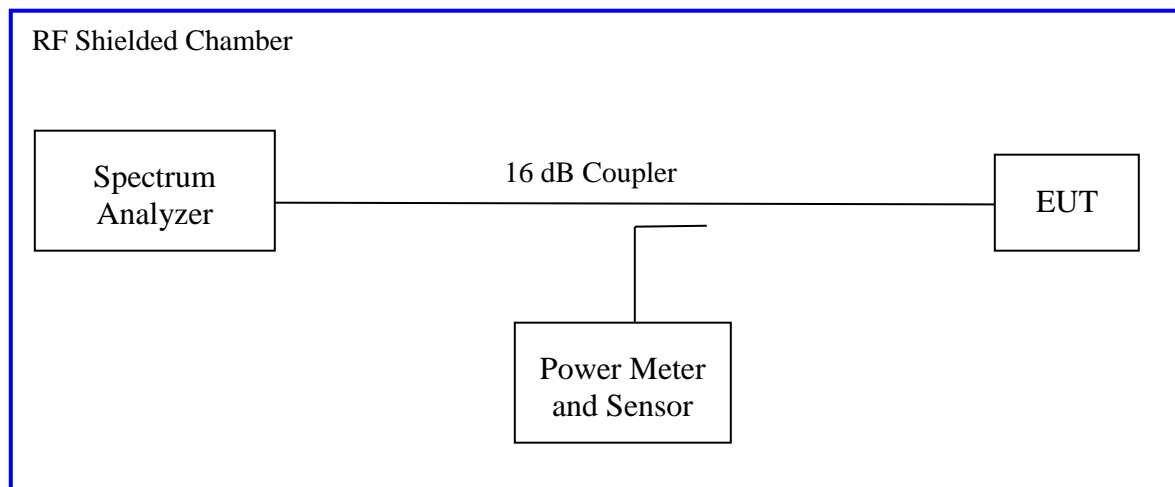

### 4.2.2 Results

As originally tested, the EUT was found to be compliant to the requirements of the test standard(s).

**Table 3: Occupied Bandwidth – Test Results**

<b>Test Date:</b> September 8, 2020		<b>Test By:</b> Jeremy Luong		
<b>Test Method:</b> Conducted Measurements		<b>Power Setting:</b> Fixed at 4 dBm		
<b>Antenna Type:</b> Integrated PCB		<b>Max. Antenna Gain:</b> -2.4 dBi		
<b>Operating Mode:</b> Uncorrelated		<b>Signal State:</b> Modulated at 1 Mbps		
<b>Ambient Temp.:</b> 23 °C		<b>Relative Humidity:</b> 39%		
<b>Bandwidth (MHz) for USB Wireless Audio Transmitter</b>				
<b>Frequency (MHz)</b>	<b>Limit (kHz)</b>	<b>99% Bandwidth</b>	<b>6 dB Bandwidth</b>	<b>Results</b>
2402	500	1.036	0.743	Pass
2442	500	1.035	0.737	Pass
2480	500	1.035	0.732	Pass
<b>Note:</b> The narrower bandwidth was measured at 1 Mbps and 100% duty cycle				

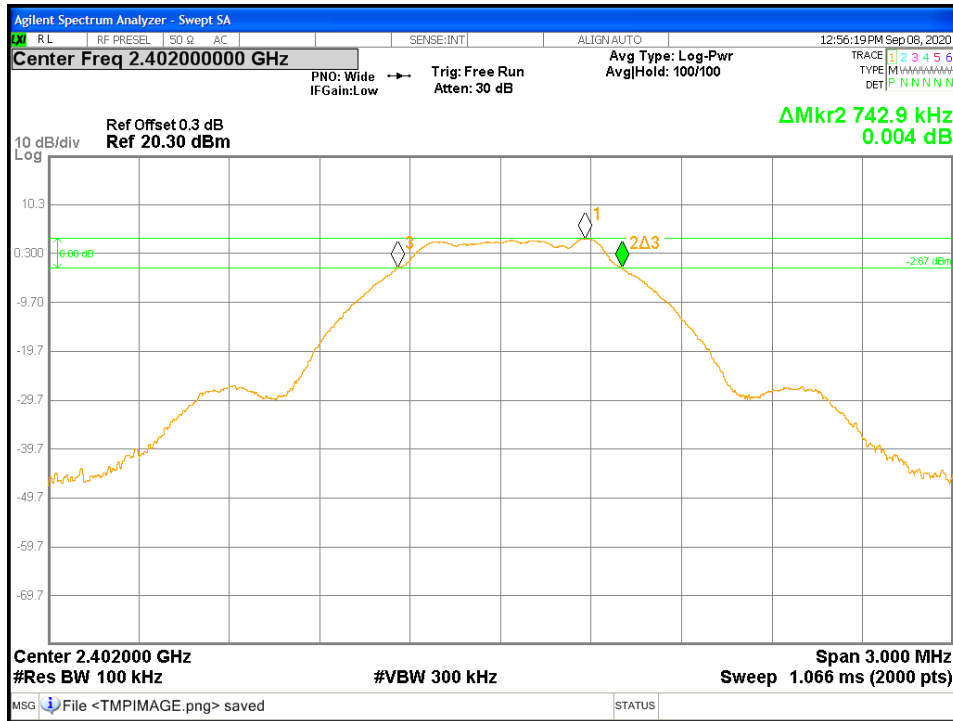

Figure 5: DTS Bandwidth-Transmitter -2402 MHz

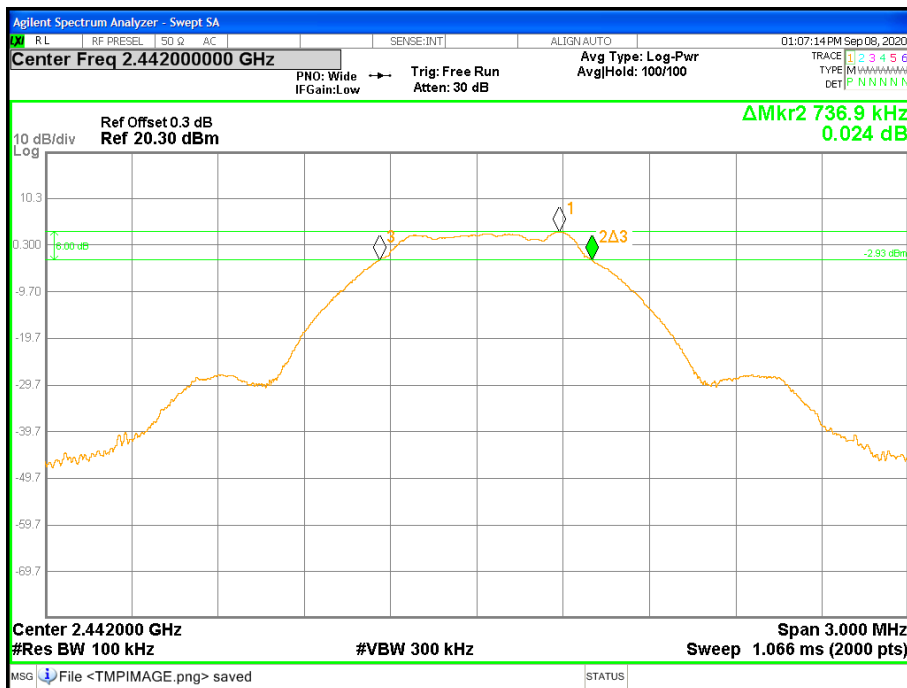

Figure 6: DTS Bandwidth-Transmitter -2442 MHz

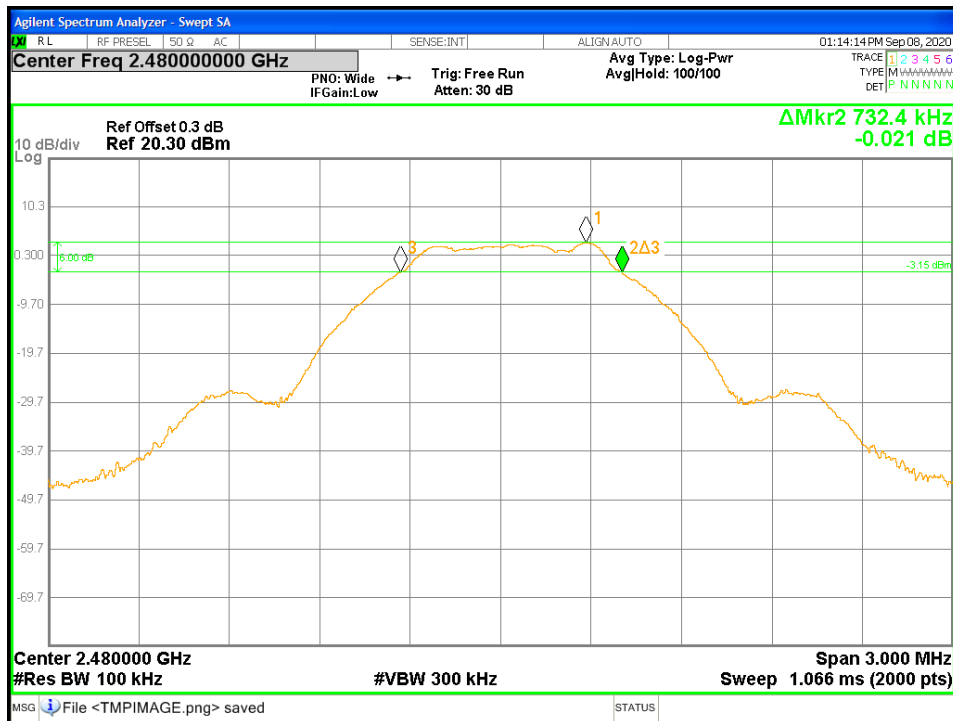

Figure 7: DTS Bandwidth-Transmitter -2480 MHz

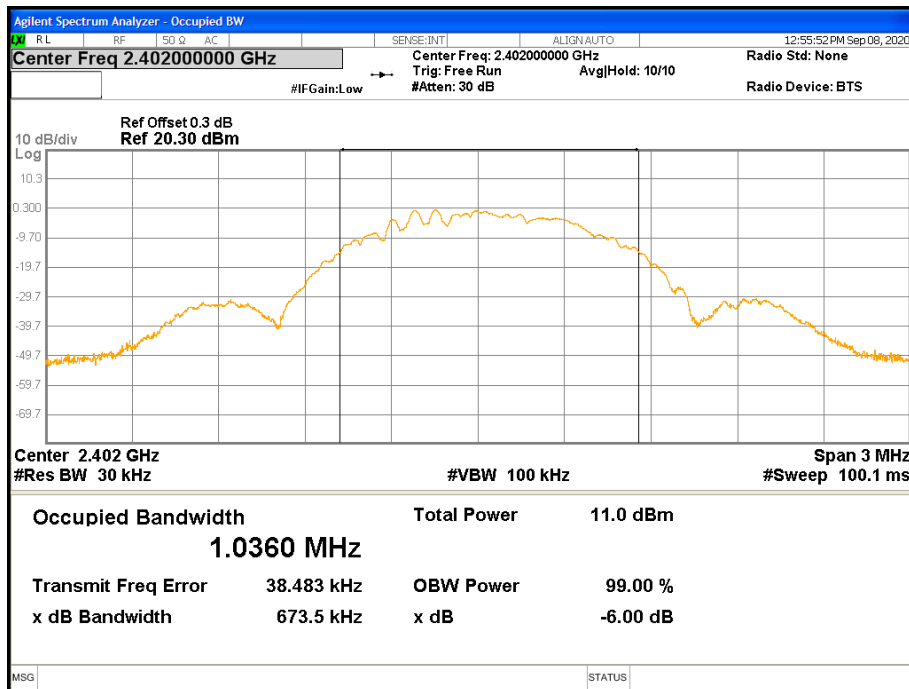

Figure 8: 99% Bandwidth-Transmitter -2402 MHz

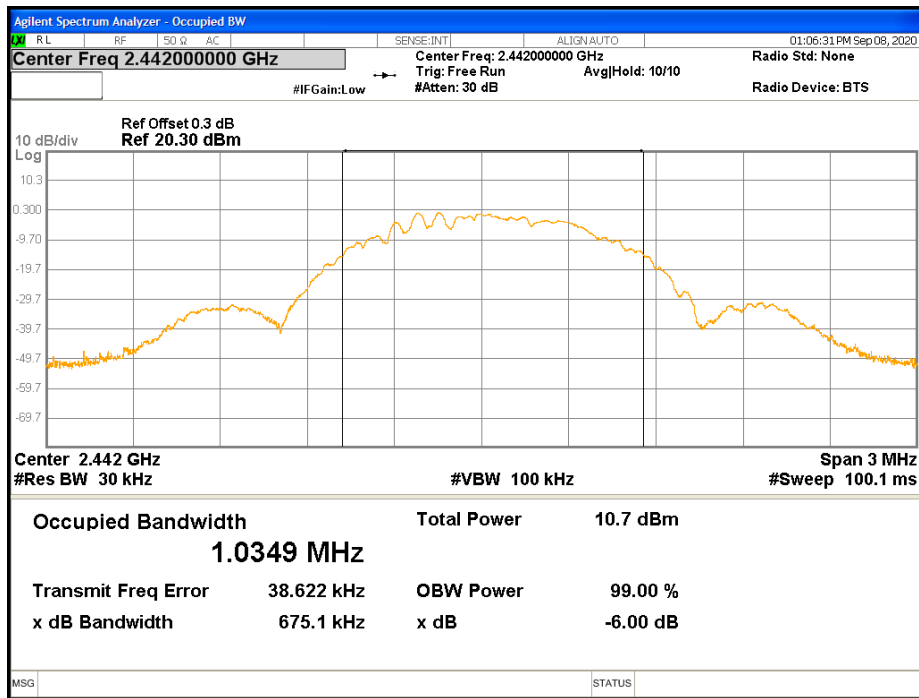

Figure 9: 99% Bandwidth-Transmitter -2442 MHz

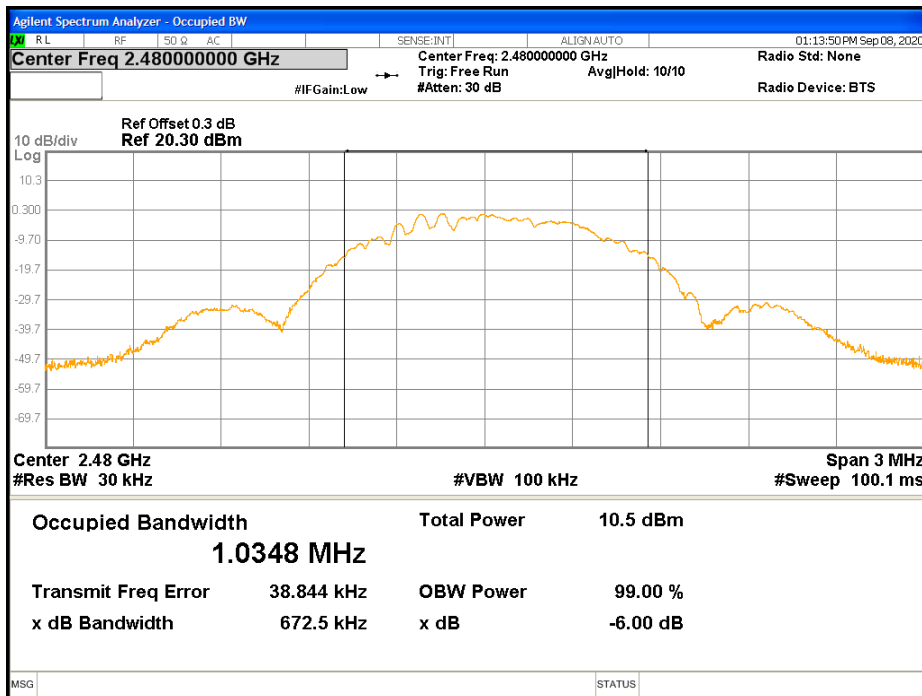

Figure 10: 99% Bandwidth-Transmitter -2480 MHz



### 4.3 Peak Power Spectral Density

According to the CFR47 Part 15.247 (e) and RSS 247 Sect.5.2 (b), the power spectral density conducted from the intentional radiator to the antenna shall not be greater than 8 dBm in any 3 kHz band during any time interval of continuous transmission.

#### 4.3.1 Test Method

The conducted method was used to measure the channel power output per ANSI C63.10-2013 Section 11.10.3. The measurement was performed with modulation per CFR47 Part 15.247 (e) and RSS 247 Sect.5.2 (b). The pre-evaluation was performed to find the worst modes. The worst findings were conducted on 3 channels in each operating frequency range of 2400 MHz to 2483.5 MHz. This test was conducted on 3 channels of Sample SN PP #1. The worst sample result indicated below.

Test Setup:

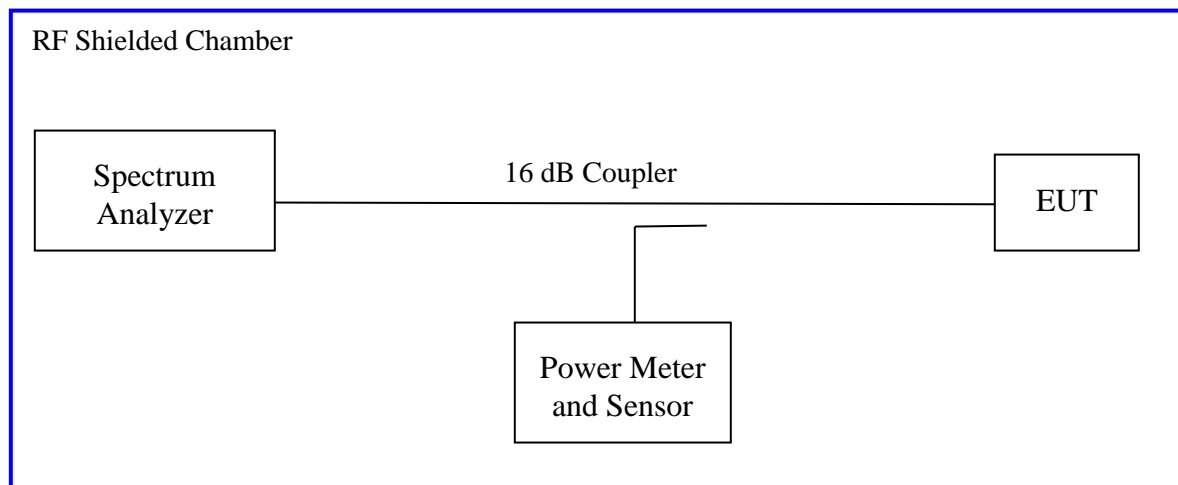

#### 4.3.2 Results

As originally tested, the EUT was found to be compliant to the requirements of the test standard(s).

**Table 4: Peak Power Spectral Density – Test Results**

<b>Test Date:</b> September 8, 2020			<b>Test By:</b> Jeremy Luong			
<b>Test Method:</b> Conducted Measurements			<b>Power Setting:</b> Fixed at 4 dBm			
<b>Antenna Type:</b> Integrated PCB			<b>Max. Antenna Gain:</b> -2.4 dBi			
<b>Operating Mode:</b> Uncorrelated			<b>Signal State:</b> Modulated at 1 Mbps			
<b>Ambient Temp.:</b> 23 °C			<b>Relative Humidity:</b> 39%			
Peak Power Spectral Density						
Freq. (MHz)	Config.	Output [dBm]	CF [dB]	Max. PPSD [dBm]	Limit [dBm]	Margin [dB]
2402	Transmitter	-2.24	-15.23	-17.47	8.00	-25.47
2442	Transmitter	-2.30	-15.23	-17.53	8.00	-25.53
2480	Transmitter	-2.79	-15.23	-18.02	8.00	-26.02
<p><b>Note:</b> CF accounted for the measured RBW.                  The bandwidth ratio is <math>10 \cdot \log(3\text{kHz}/100\text{kHz})</math> or -15.23 dB.                  USB Transmitter transmitted at 100% duty cycle.</p>						

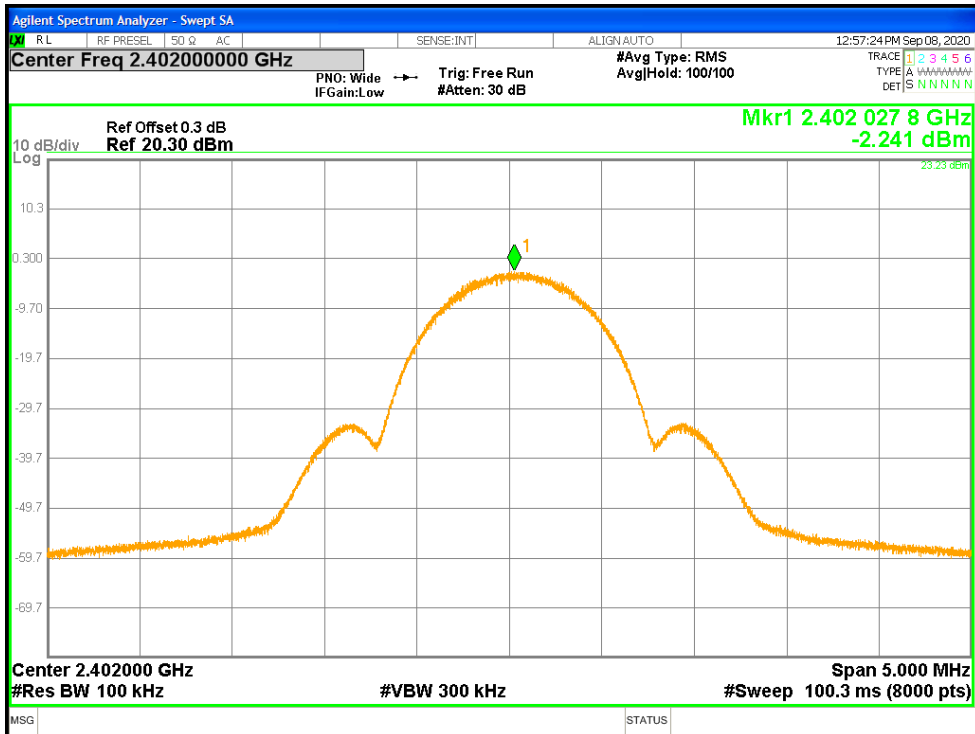

Figure 11: Maximum Power Spectral Density-2402 MHz

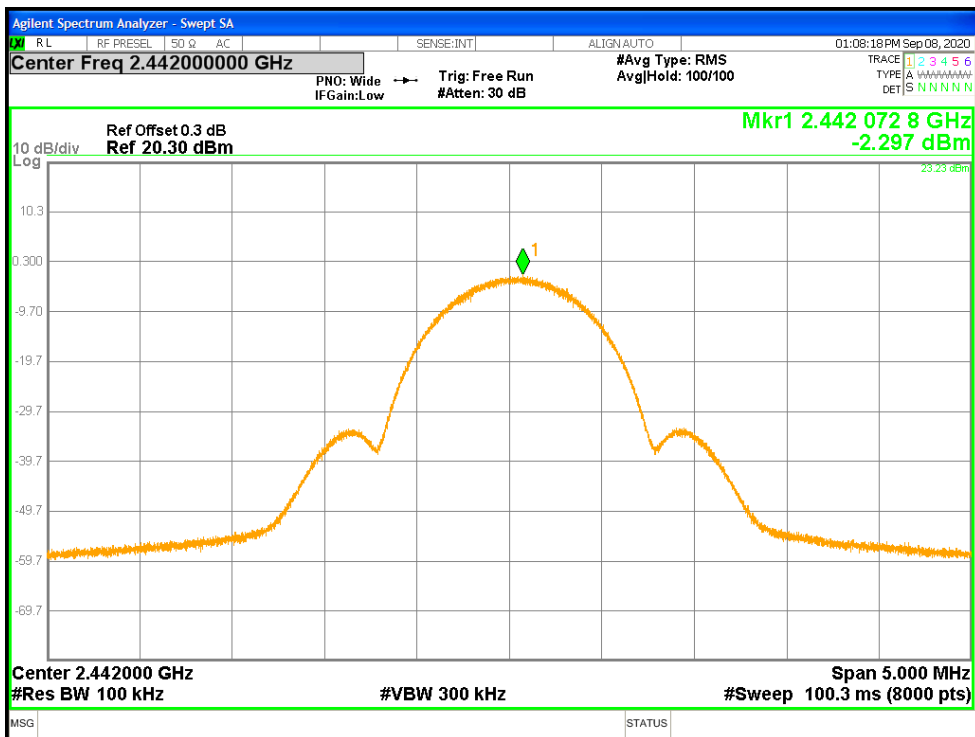

Figure 12: Maximum Power Spectral Density-2442 MHz

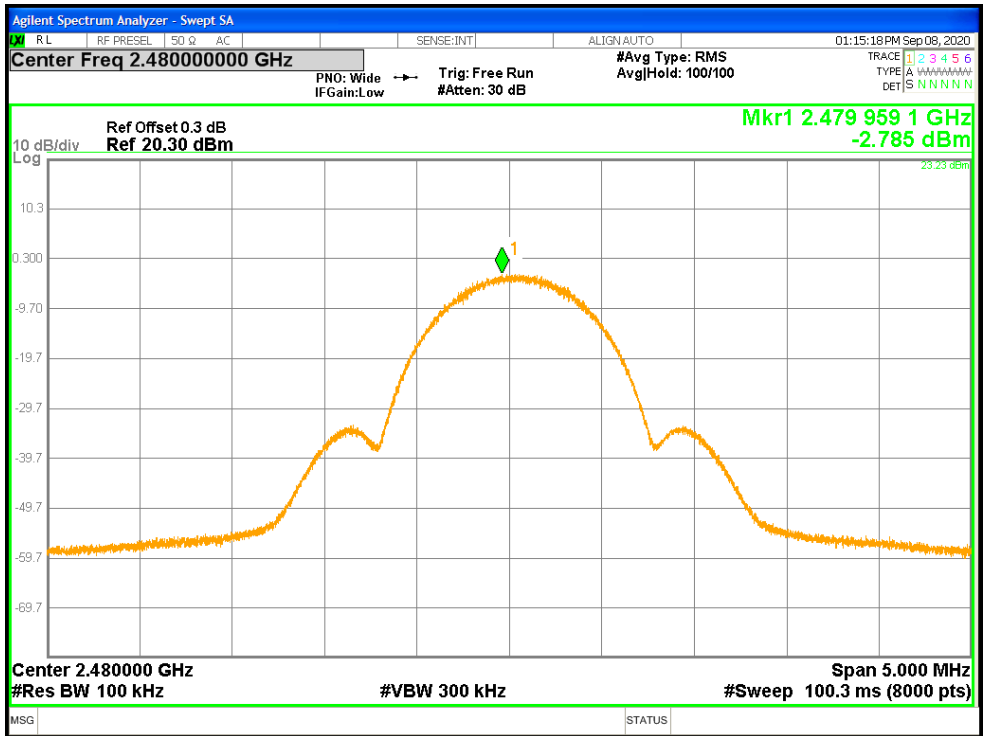

Figure 13: Maximum Power Spectral Density-2480 MHz

#### 4.4 Out of Band Emissions

The setup was identical to RF output power measurement. Intentional radiators operating under the alternative provisions to the general emission limits, must be designed to ensure that the 20 dB or 30 dB bandwidth of the emission, or whatever bandwidth may otherwise be specified in the specific rule section under which the equipment operates, is contained within the frequency band designated in the rule section under which the equipment is operated. The requirement to contain the designated bandwidth of the emission within the specified frequency band includes the effects from frequency sweeping, frequency hopping and other modulation techniques that may be employed as well as the frequency stability of the transmitter over expected variations in temperature and supply voltage. If the frequency stability is not specified in the regulations, it is recommended that the fundamental emission be kept within at least the central 80% of the permitted band in order to minimize the possibility of out-of-band operation.

*Since the transmitter complies with the conducted power limits base on the use of RMS averaging per CFR47 Part 15.247(b)(3), any frequency outside the band of 2400MHz to 2483.5MHz, the power output level must be below 30db from the in-band transmitting signal; CFR 47 Part 15.215, 15.247(d) and RSS-247 Sect.5.5..*

##### 4.4.1 Test Method

The conducted method was used to measure the out-of-band emission requirement. The measurement was performed with modulation per CFR47 15.247(4) (d) 2020 and RSS-247 Sect.5.5: 2017. This test was conducted on 3 channels of Sample S/N PP #1. The worst sample result indicated below.

Test Setup:

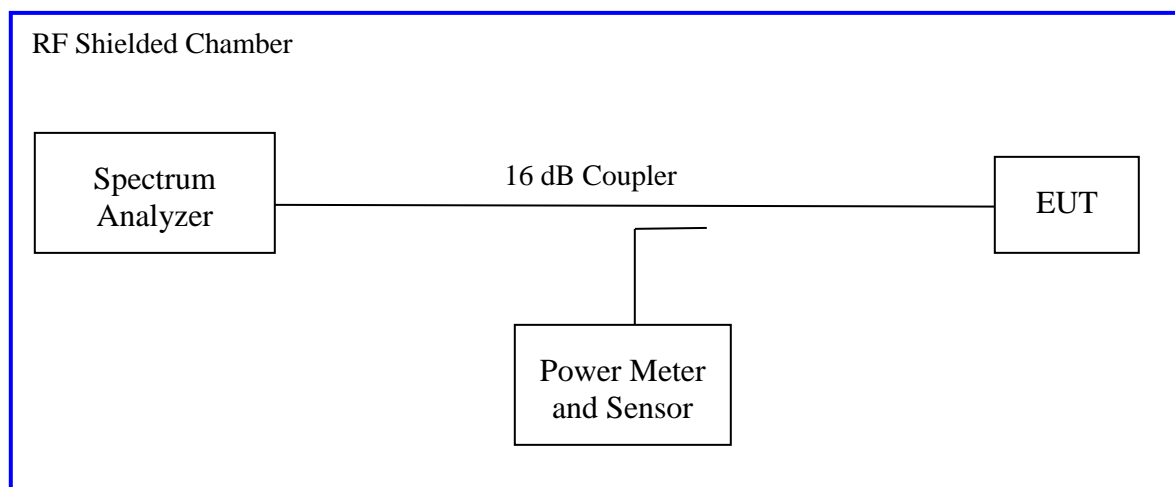

## 4.4.2 Results

As originally tested, the EUT was found to be compliant to the requirements of the test standard(s).

**Table 5:** Out of Band Emissions – Test Results

<b>Test Date:</b> September 8, 2020		<b>Test By:</b> Jeremy Luong	
<b>Test Method:</b> Conducted Measurements		<b>Power Setting:</b> Fixed at 4 dBm	
<b>Antenna Type:</b> Integrated PCB		<b>Max. Antenna Gain:</b> -2.4 dBi	
<b>Operating Mode:</b> Uncorrelated		<b>Signal State:</b> Modulated at 1 Mbps	
<b>Ambient Temp.:</b> 22 °C		<b>Relative Humidity:</b> 39%	
Out of Band Results for USB Wireless Audio Transmitter			
Operating Channel	Out of Band Level (dBm)	30 dBc Level (dBm)	Margin (dB)
2402 MHz	-33.90	-26.38	-7.52
2442 MHz	-36.58	-26.65	-9.93
2480 MHz	-34.57	-26.86	-7.71
<p>Note: dBc is defined as the level below the main carrier.          The band-edge level must be lower than the 30dBc level.          The maximum out of band emission on each individual output is at least 30 dB below the maximum in-band PSD on that output.          (*) The band-edge is compared to the highest -30dBc level of the test mode.</p>			

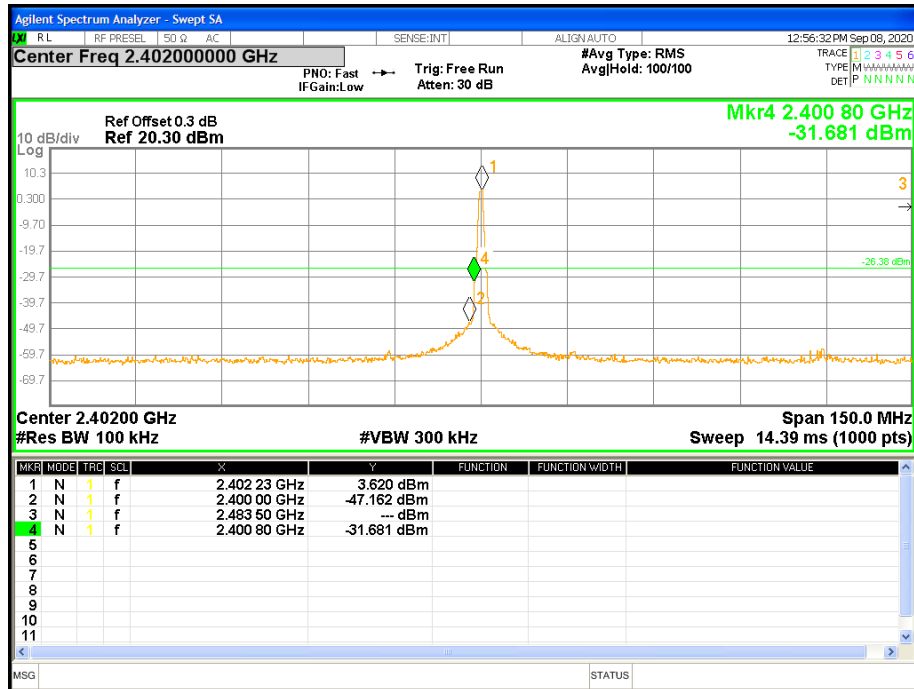

Figure 14: Conducted Band Edge at 2402 MHz

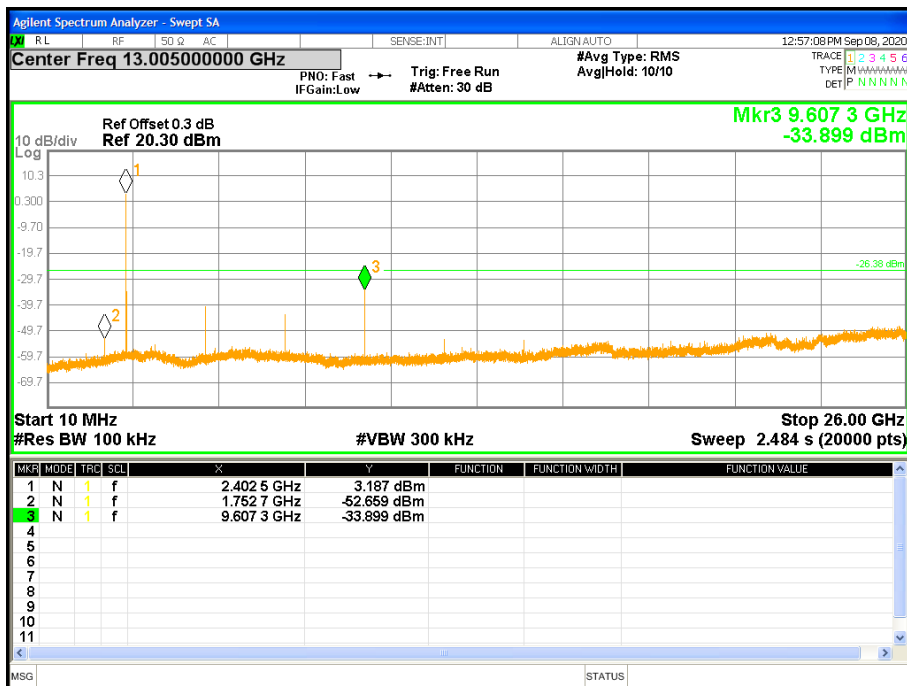

Figure 15: Out of band Emission at 2402 MHz

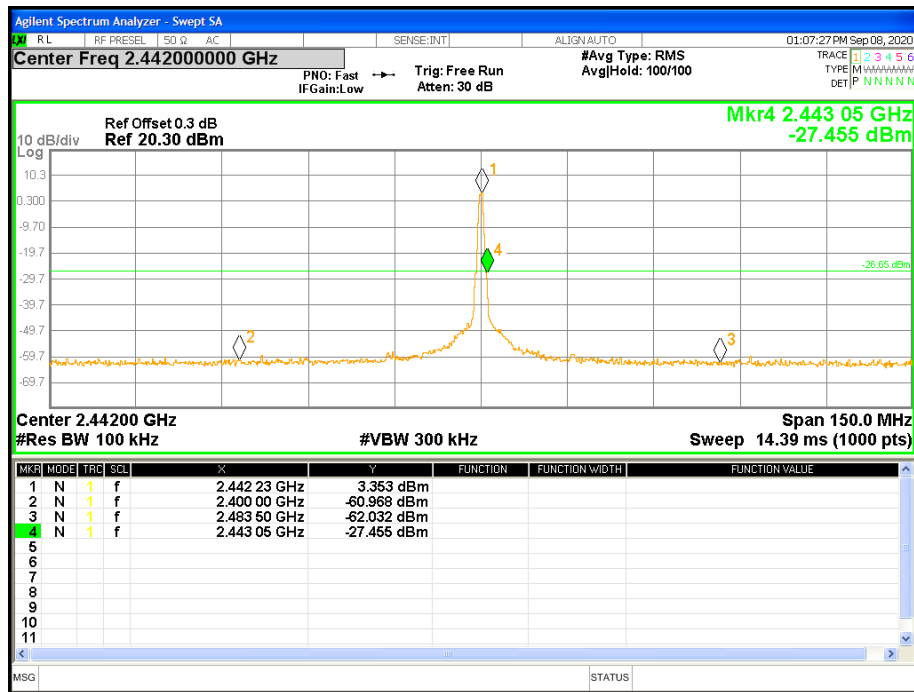

Figure 16: Conducted Band Edge at 2442 MHz

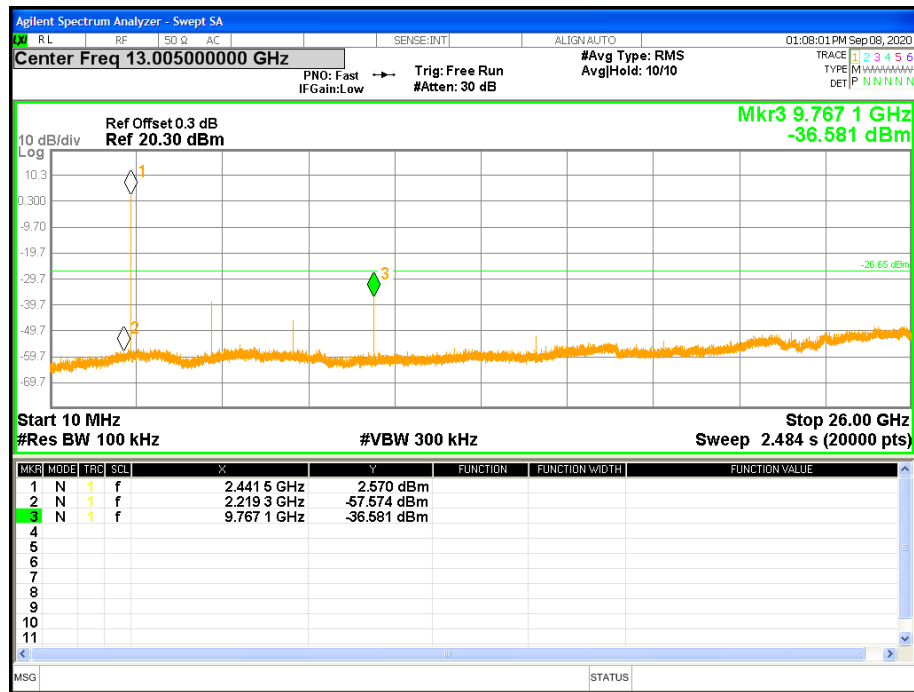

Figure 17: Out of band Emission at 2442 MHz



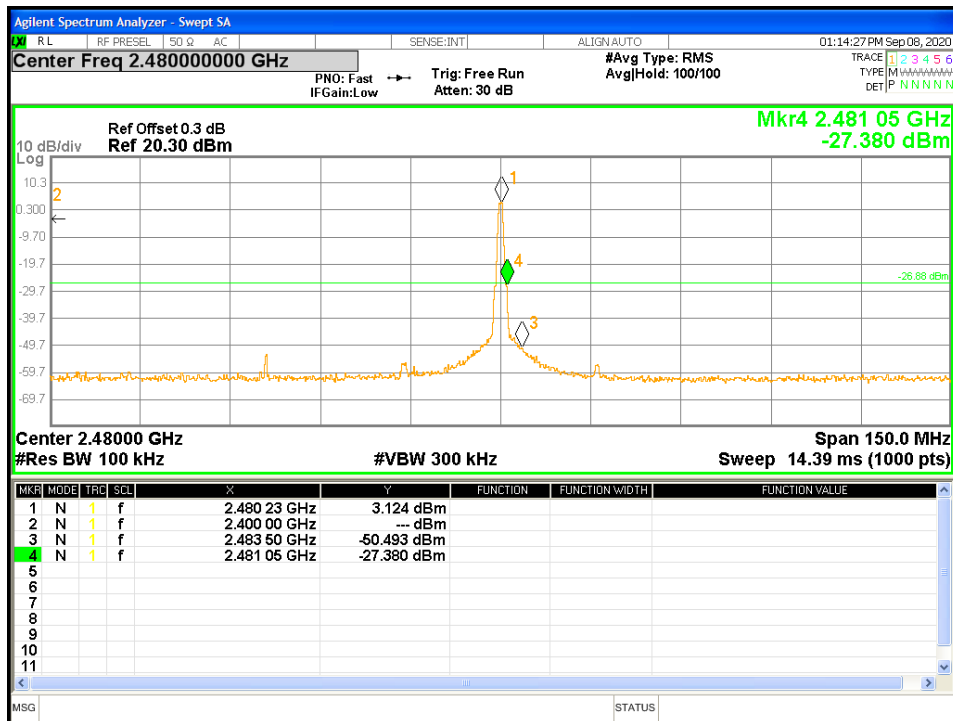

Figure 18: Conducted Band Edge at 2480 MHz

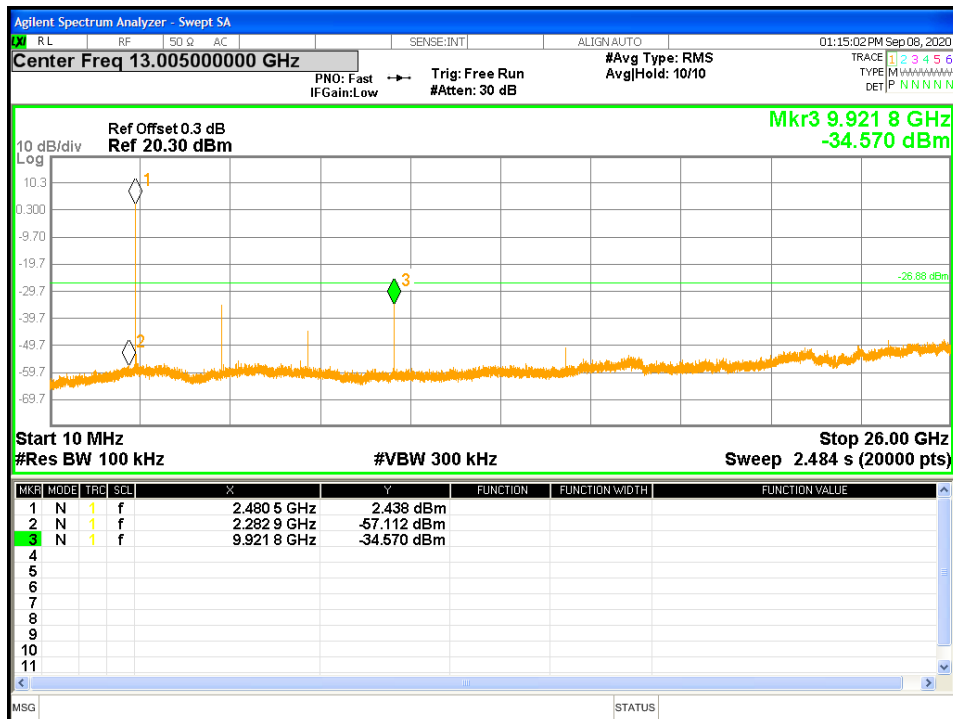

Figure 19: Out of band Emission at 2480 MHz

## **4.5 Transmit Spurious Emissions**

*Transmitter spurious emissions are emissions outside the frequency range of the equipment when the equipment is in transmit mode; per requirement of CFR47 15.205, 15.209, 15.247(d), RSS-Gen Sect. 8.9.*

### **4.5.1 Test Methodology**

#### **4.5.1.1 Preliminary Test**

A test program that controls instrumentation and data logging was used to automate the preliminary RF emission test procedure. The frequency range of interest was divided into sub-ranges to yield a frequency resolution of approximately 120 kHz and provide a reading at each frequency for no more than 12° of turntable rotation. For each frequency sub-range the turntable was rotated 360° while peak emission data was recorded and plotted over the frequency range of interest in horizontal and vertical antenna polarization's.

Preliminary emission profile testing was performed inside the anechoic chamber. The EUT was placed on a 1.0m x 1.5m non-conductive table 80cm (<1 GHz) and 150cm (>1 GHz) above the floor. The EUT was positioned as shown in the setup photographs. The receiving antenna was placed at a distance of 3m at a fixed height of 1m. Measurement equipment was located outside of the chamber. A video camera was placed inside the chamber to view the EUT.

Pres-scans were performed to determine the worst case configuration for data rate; 1 Mbps and 2 Mbps

#### **4.5.1.2 Final Test**

For each frequency measured, the peak emission was maximized by manipulating the receiving antenna from 1 to 4 meters above the ground plane and placing it at the position that produced the maximum signal strength reading. The turntable was then rotated through 360° while observing the peak signal and placing the EUT at the position that produced maximum radiation. The six highest emissions relative to the limit were measured unless such emissions were more than 20 dB below the limit. If less than six emissions are within 20 dB of the limit, than the noise level of the receiver is measured at frequencies where emissions are expected. Multiples of all oscillator and microprocessor frequencies were also checked.

Final testing was performed on an NSA compliant test site. The EUT was placed on a 1.0m x 1.5m non-conductive table 80cm (<1 GHz) and 150cm (>1 GHz) above the ground plane. The placement of EUT and cables were the same as for preliminary testing and is shown in the setup photographs.

The final scans performed on the worst axis, Y-Axis, for three operating channels in each operating mode;

2402 MHz, 2442 MHz, and 2480 MHz

#### **4.5.1.3 Deviations**

None.

**Test Setup:**

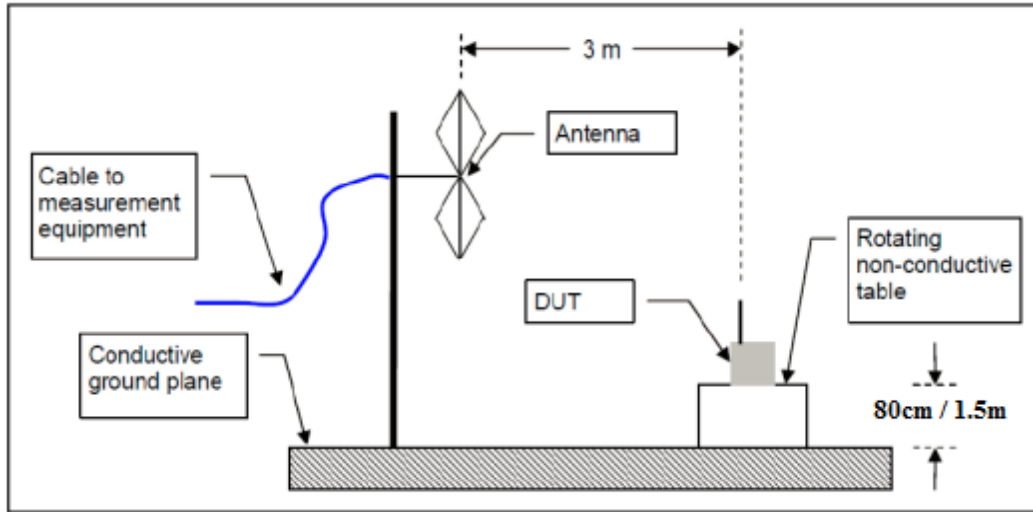

**4.5.2 Transmitter Spurious Emission Limit**

The spurious emissions of the transmitter shall not exceed the values in CFR47 Part 15.205, 15.209: 2020 and RSS Gen Sect. 8.10: 2019.

Frequency (MHz)	Field strength (microvolts/meter)	Measurement distance (meters)
0.009-0.490	2400/F (kHz)	300
0.490-1.705	24000/F (kHz)	30
1.705-30.0	30	30
30-88	100 **	3
88-216	150 **	3
216-960	200 **	3
Above 960	500	3

All harmonics and spurious emission which are outside of the restricted band shall be 20dB below the in-band emission.

**4.5.3 Test Results**

The final measurement data was taken under the worst case operating modes, configurations, and/or cable positions. It also reflects the results including any modifications and/or special accessories listed in Sections 1.4 and test plan.

As originally tested, the EUT was found to be compliant to the requirements of the test standard(s).

**Table 6: Transmit Spurious Emission at Band-Edge Requirements**

<b>Test Date:</b> September 9, 2020					<b>Test By:</b> Jeremy Luong				
<b>Test Method:</b> Radiated Measurements					<b>Power Setting:</b> Fixed at 4 dBm				
<b>Antenna Type:</b> Integrated PCB					<b>Max. Antenna Gain:</b> -2.4 dBi				
<b>Operating Mode:</b> Uncorrelated					<b>Signal State:</b> Modulated at 2 Mbps				
<b>Ambient Temp.:</b> 22 °C					<b>Relative Humidity:</b> 41%				
Band-Edge Results									
Freq.	Edge Freq.	Pol	Ant.	Tbl.	Det.	Level	Limit	Margin	Note
MHz	MHz	V/H	cm	Deg	Pk/Avg	dBuV/m	dBuV/m	dB	
2402	2390.00	H	94	189	Pk	56.14	74.00	-17.86	2402MHz, Z-Axis
2402	2390.00	H	94	189	Ave	42.96	54.00	-11.04	2402MHz, Z-Axis
2402	2390.00	V	125	189	Pk	56.88	74.00	-17.12	2402MHz, Z-Axis
2402	2390.00	V	125	189	Ave	42.99	54.00	-11.01	2402MHz, Z-Axis
2480	2483.50	V	0	107	Pk	58.17	74.00	-15.83	2480MHz, Z-Axis
2480	2483.50	V	0	107	Ave	45.29	54.00	-8.71	2480MHz, Z-Axis
2480	2483.50	H	70	213	Pk	55.97	74.00	-18.03	2480MHz, Z-Axis
2480	2483.50	H	70	213	Ave	44.06	54.00	-9.94	2480MHz, Z-Axis
Note: The emissions were measured at the adjacent restricted band of the fundamental signal. All the band-edge measurements met the restricted band requirements of CFR47 15.205 Band-edge measurement plots use a wider span than 2 MHz to evaluate additional spectrum bands for in-band leakage and spurious emissions.									

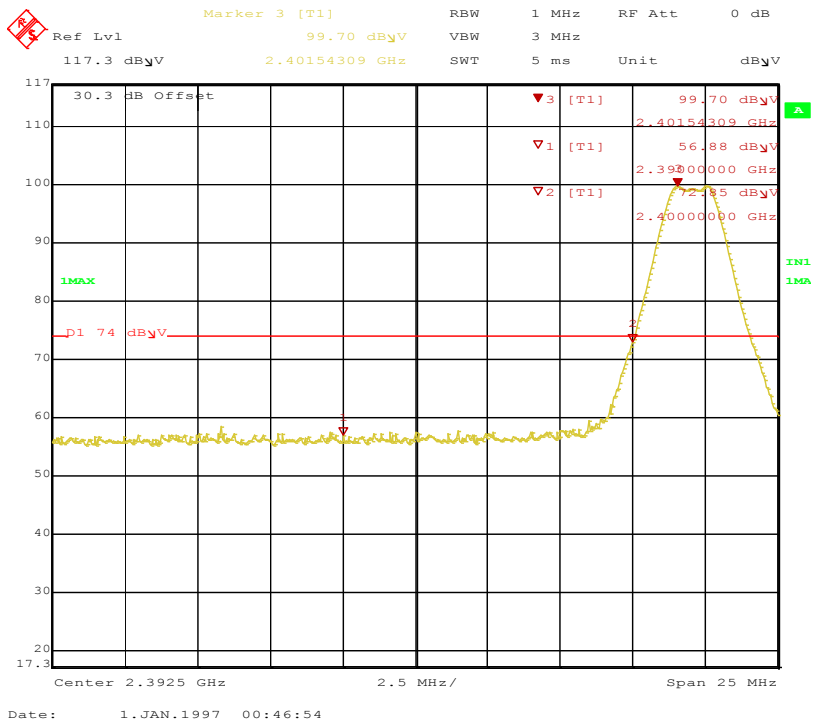

Figure 20: Band-edge-2402 MHz-V-Pk

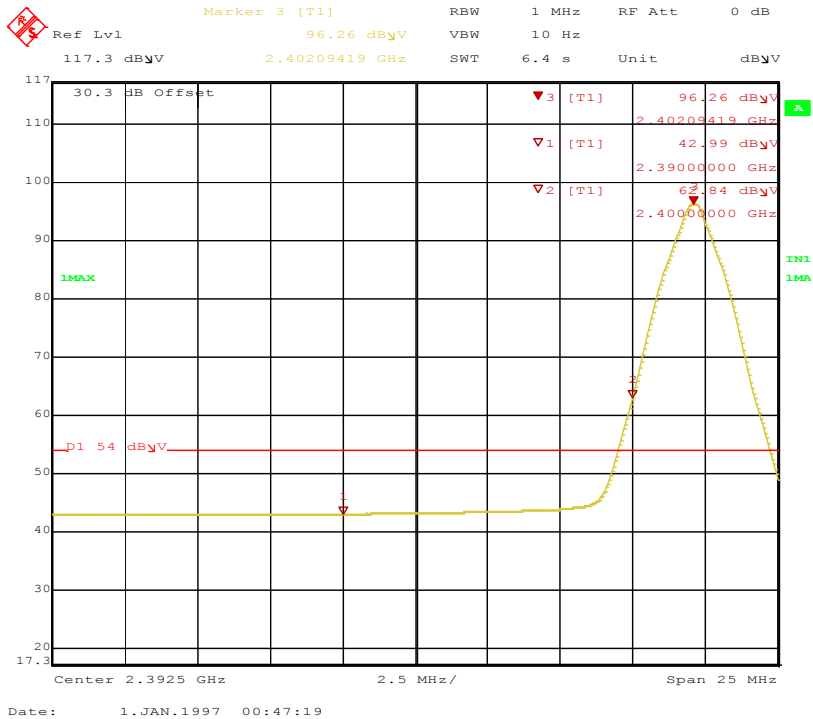

Figure 21: Band-edge-2402 MHz-V-Ave

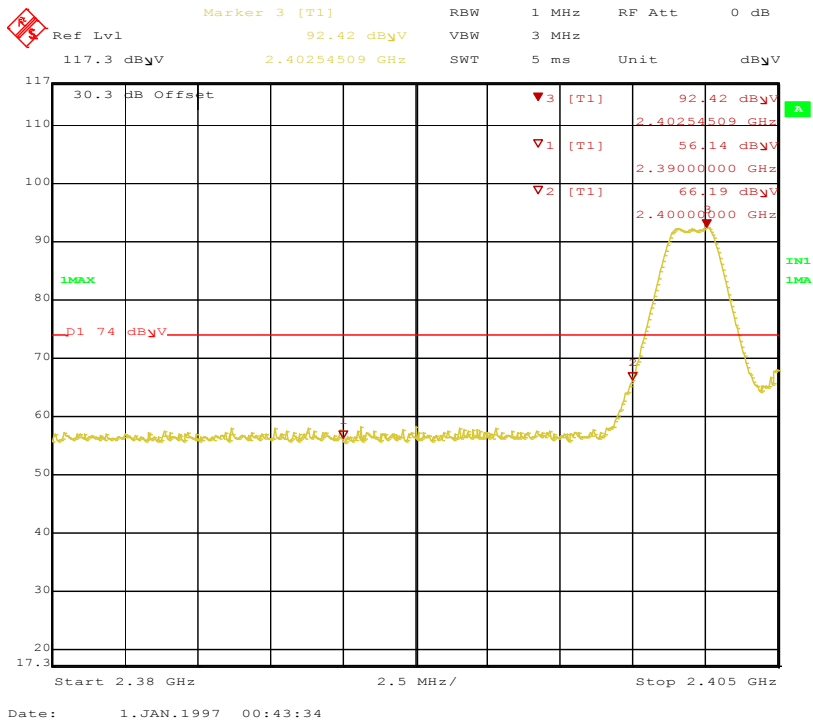

Figure 22: Band-edge-2402 MHz-H-Pk

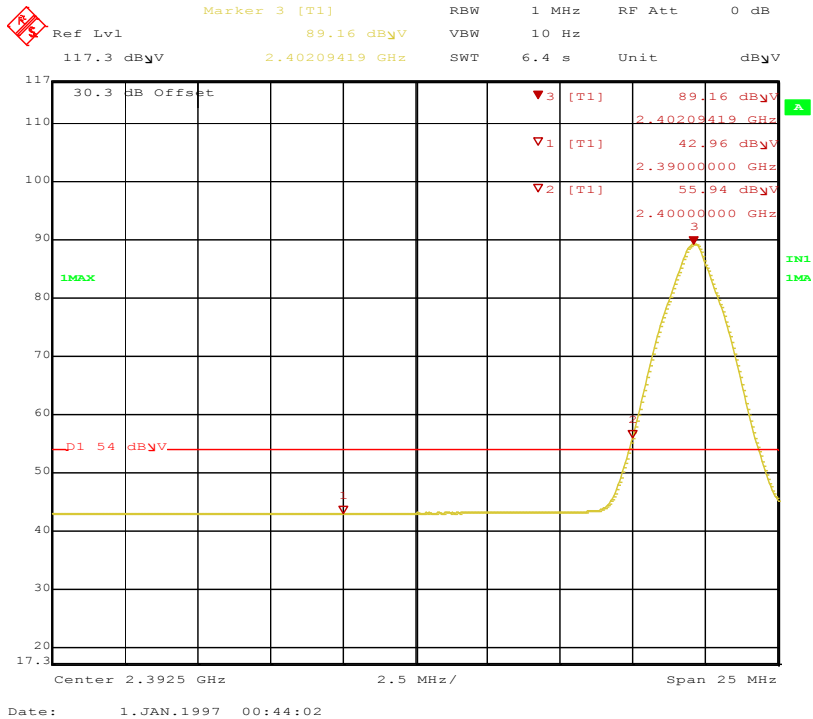

Figure 23: Band-edge-2402 MHz-H-Ave

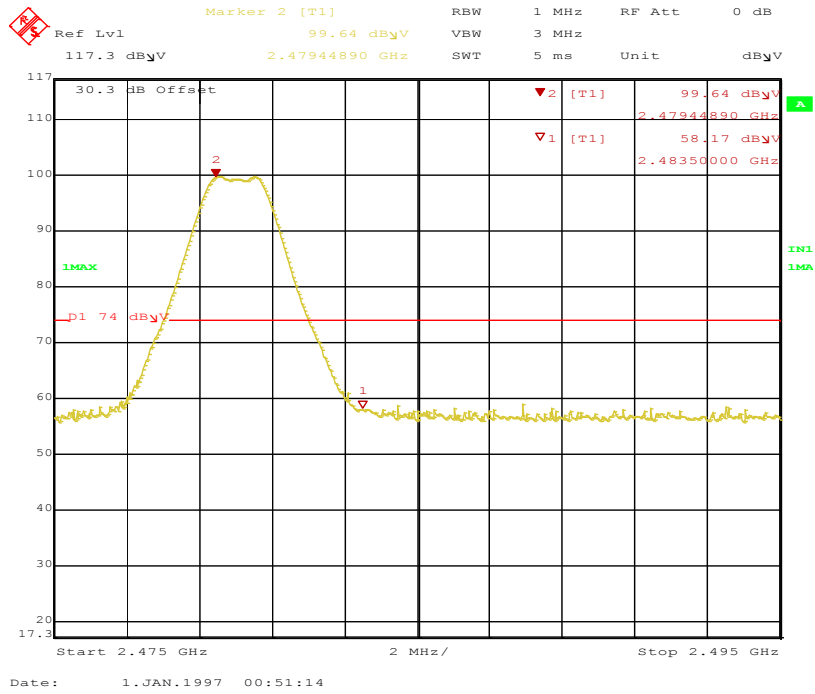

Figure 24: Band-edge-2480 MHz-V-Pk

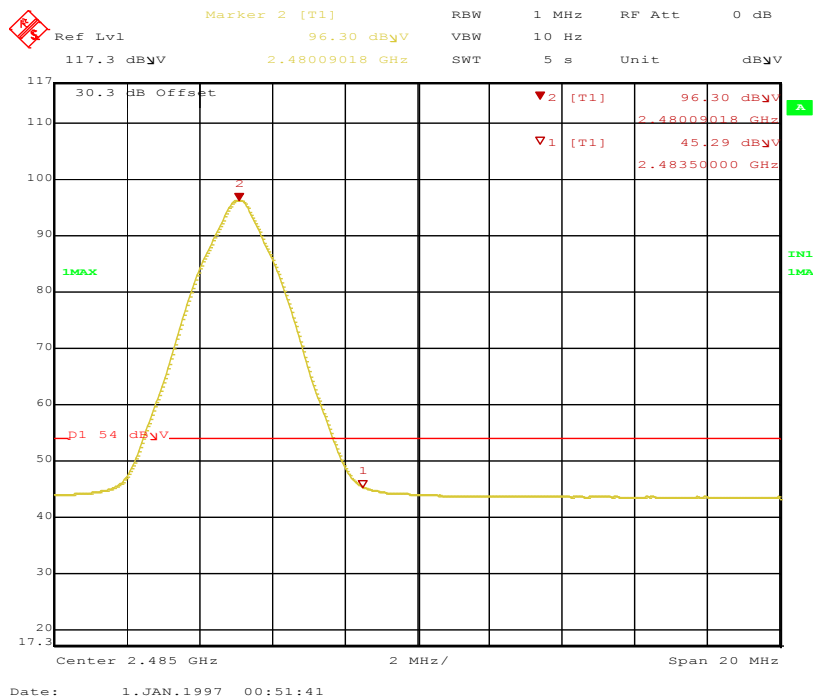

Figure 25: Band-edge-2480 MHz-V-Ave

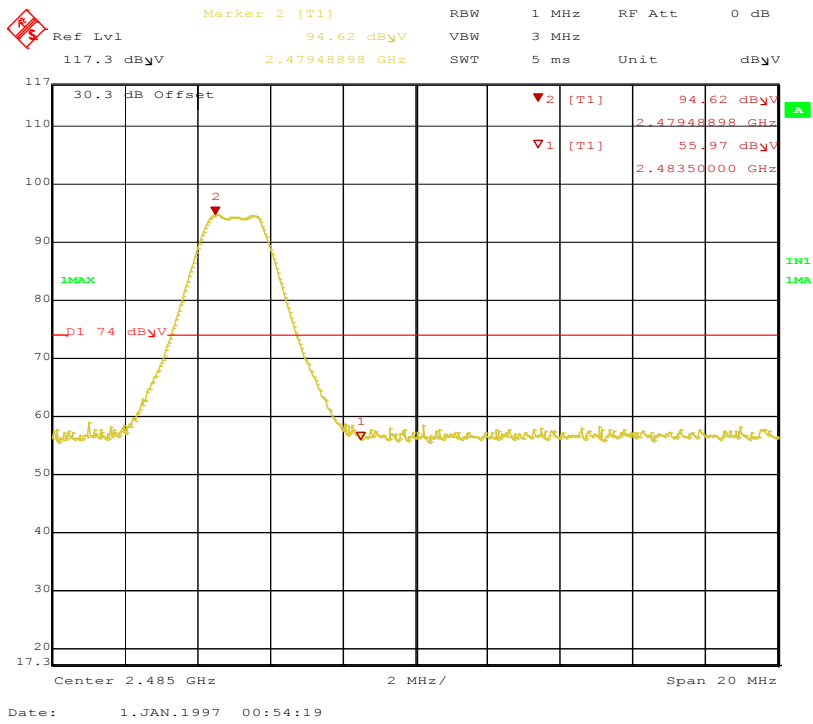

Figure 26: Band-edge-2480 MHz-H-Pk

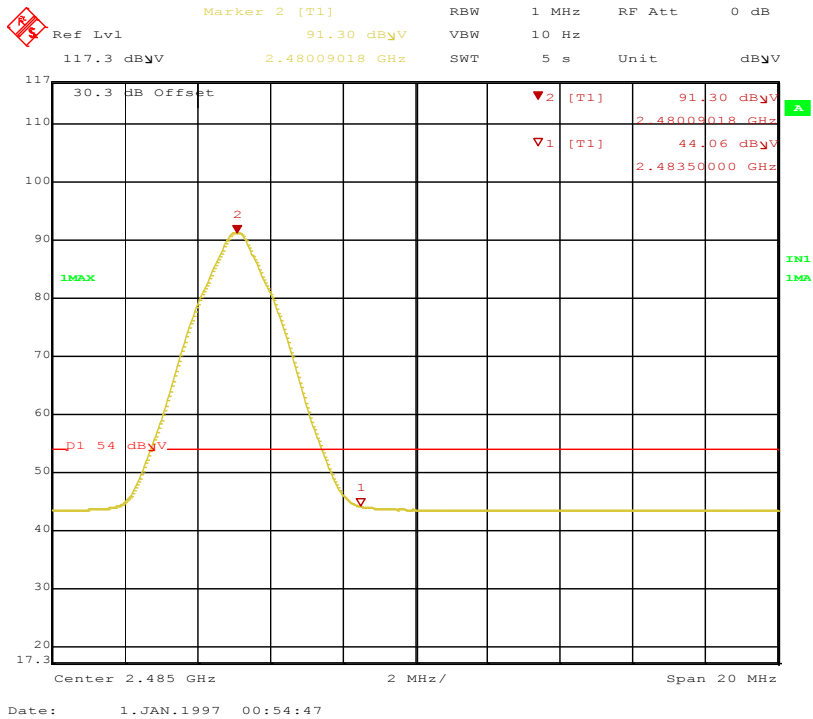

Figure 27: Band-edge-2480 MHz-H-Ave



SOP 1 Radiated Emissions											Tracking # 32063527.001 Page 1 of 6	
<b>EUT Name</b>		USB Wireless Audio Transmitter					<b>Date</b>		September 8, 2020			
<b>EUT Model</b>		Stealth 700P Gen 2 TX					<b>Temp / Hum in</b>		23°C / 36%rh			
<b>EUT Serial</b>		PP #2					<b>Temp / Hum out</b>		N/A			
<b>EUT Config.</b>		1 Mbps on Z-Axis					<b>Line AC / Freq</b>		5.0 VDC			
<b>Standard</b>		CFR47 Part 15 Subpart C					<b>RBW / VBW</b>		See Note			
<b>Dist/Ant Used</b>		3m / JB3 and EMCO 6502					<b>Performed by</b>		Jeremy Luong			
Freq.	Raw	Cbl	AF	Level	Det.	Pol.	Hght.	Azt	Limit	Margin	Result	
MHz	dBuV/m	dB	dB	dBuV/m		H/V	cm	deg	dBuV/m	dB		
9 kHz to 1 GHz, Transmitted Data at 2402 MHz												
40.00	38.96	2.56	-13.99	27.53	QP	V	113	90	40.00	-12.47	Pass	
50.49	45.47	2.63	-19.92	28.18	QP	V	104	100	40.00	-11.82	Pass	
51.42	41.35	2.64	-20.15	23.83	QP	V	105	234	40.00	-16.17	Pass	
67.69	45.21	2.73	-20.17	27.77	QP	V	104	182	40.00	-12.23	Pass	
72.03	42.86	2.76	-20.07	25.55	QP	V	111	0	40.00	-14.45	Pass	
98.11	48.72	2.87	-18.50	33.09	QP	V	112	108	43.50	-10.41	Pass	
Spec Margin = Level - Limit, Level = Raw+ Cbl+ CF ± Uncertainty CF= Amp Gain + ANT Factor												
Combined Standard Uncertainty $u_c(y) = \pm 3.2$ dB Expanded Uncertainty $U = ku_c(y)$ $k = 2$ for 95% confidence												
<b>Note:</b> The worst case emission was observed on Channel 2402 MHz. RBW and VBW set per ANSI C63.4 and C63.10.												

SOP 1 Radiated Emissions											Tracking # 32063527.001 Page 2 of 6	
<b>EUT Name</b>		USB Wireless Audio Transmitter					<b>Date</b>		September 9, 2020			
<b>EUT Model</b>		Stealth 700P Gen 2 TX					<b>Temp / Hum in</b>		23°C / 41%rh			
<b>EUT Serial</b>		PP #2					<b>Temp / Hum out</b>		N/A			
<b>EUT Config.</b>		1 Mbps on Z-Axis					<b>Line AC / Freq</b>		5.0 VDC			
<b>Standard</b>		CFR47 Part 15 Subpart C					<b>RBW / VBW</b>		1 MHz / 3 MHz			
<b>Dist/Ant Used</b>		3m / EMCO-3115, 1m / ComPower-AHA840					<b>Performed by</b>		Jeremy Luong			
Freq	Raw	Cbl	AF	Level	Det	Pol	Hght	Azt	Limit	Margin	Comment	
MHz	dBuV/m	dB	dB	dBuV/m		H/V	cm	deg	dBuV/m	dB		
Transmitted Data at 2402 MHz												
9609.11	65.98	2.78	-16.05	52.71	Pk	V	251	214	74.00	-21.29	Harmonics	
9609.11	55.97	2.78	-16.05	42.70	Ave	V	251	214	54.00	-11.30	Harmonics	
19214.23	45.33	7.20	-9.42	43.11	Pk	H	152	192	74.00	-30.89	Harmonics	
19214.23	35.34	7.20	-9.42	33.12	Ave	H	152	192	63.50	-30.38	Harmonics	
25554.92	43.03	8.10	-7.49	43.64	Pk	H	128	168	74.00	-30.36	Harmonics	
25554.92	31.41	8.10	-7.49	32.02	Ave	H	128	168	63.50	-31.48	Harmonics	
Transmitted Data at 2442 MHz												
9767.06	66.79	2.87	-15.76	53.91	Pk	V	188	200	74.00	-20.09	Harmonics	
9767.06	57.25	2.87	-15.76	44.37	Ave	V	188	200	54.00	-9.64	Harmonics	
19538.17	44.80	7.22	-8.65	43.37	Pk	H	153	196	74.00	-30.63	Harmonics	
19538.17	33.88	7.22	-8.65	32.46	Ave	H	153	196	63.50	-31.04	Harmonics	
Transmitted Data at 2480 MHz												
4959.52	65.60	1.85	-23.10	44.35	Pk	H	263	164	74.00	-29.65	Harmonics	
4959.52	56.79	1.85	-23.10	35.54	Ave	H	263	164	54.00	-18.47	Harmonics	
9921.11	65.77	2.96	-15.63	53.11	Pk	V	240	198	74.00	-20.89	Harmonics	
9921.11	55.91	2.96	-15.63	43.25	Ave	V	240	198	54.00	-10.75	Harmonics	
19838.05	46.23	7.30	-8.56	44.97	Pk	H	153	200	74.00	-29.03	Harmonics	
19838.05	35.47	7.30	-8.56	34.21	Ave	H	153	200	63.50	-29.29	Harmonics	
Spec Margin = Level - Limit, Level = Raw+ Cbl+ CF ± Uncertainty												
CF= Amp Gain + ANT Factor												
Combined Standard Uncertainty $u_c(y) = \pm 3.2\text{dB}$ Expanded Uncertainty $U = ku_c(y)$ $k = 2$ for 95% confidence												
Notes: All emissions passed the spurious emission limit.												
(*) Non-restricted band emission.												

**SOP 1 Radiated Emissions**

Tracking # 32063527.001 Page 3 of 6

<b>EUT Name</b>	USB Wireless Audio Transmitter	<b>Date</b>	September 8, 2020
<b>EUT Model</b>	Stealth 700P Gen 2 TX	<b>Temp / Hum in</b>	23°C / 36%rh
<b>EUT Serial</b>	PP #2	<b>Temp / Hum out</b>	N/A
<b>EUT Config.</b>	1 Mbps on Z-Axis	<b>Line AC / Freq</b>	5.0 VDC
<b>Standard</b>	CFR47 Part 15 Subpart C	<b>RBW / VBW</b>	See Note
<b>Dist/Ant Used</b>	3m / 6502 & JB3	<b>Date</b>	Jeremy Luong

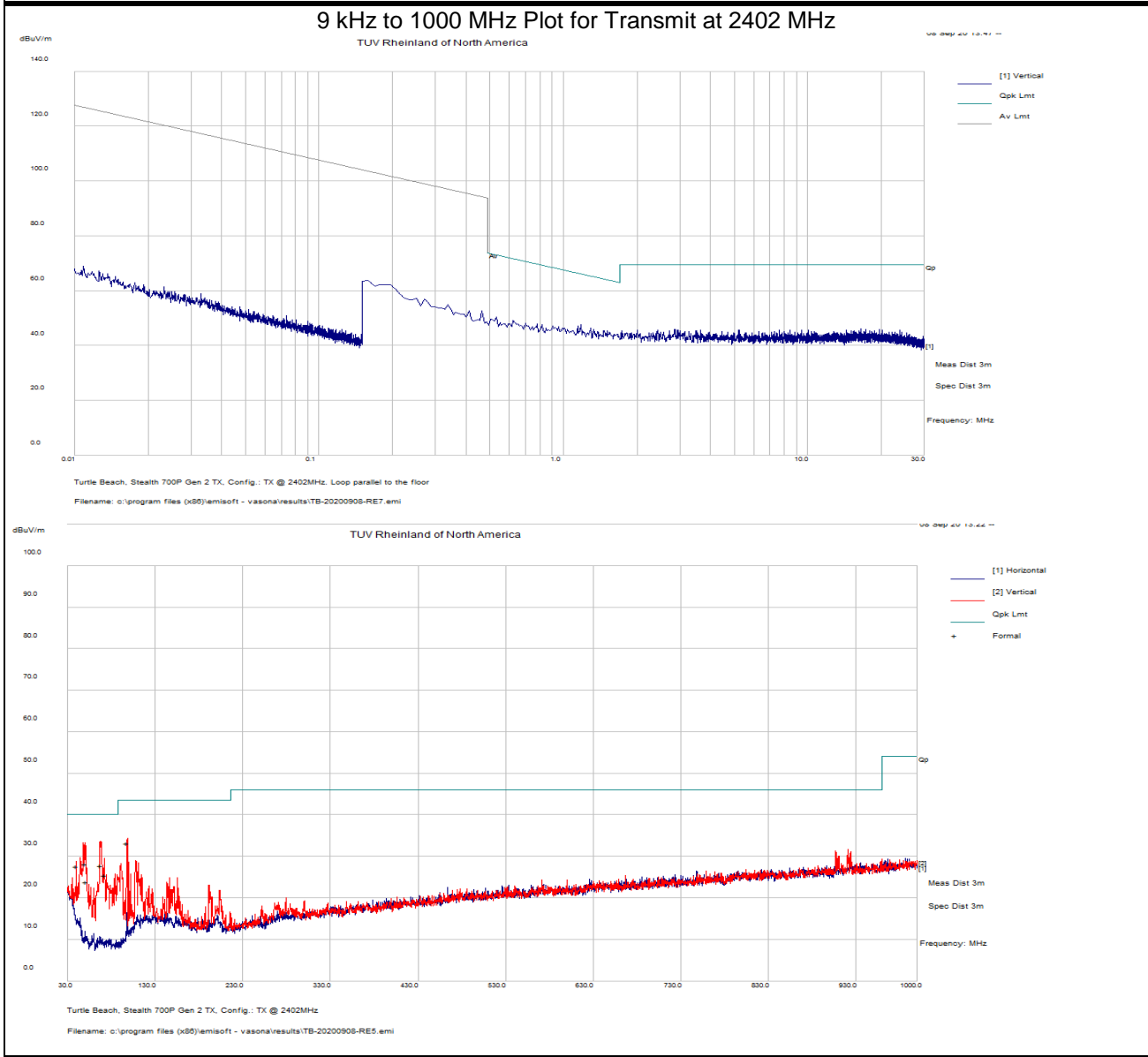

Notes: RBW and VBW set per ANSI C63.4 and C63.10.

**SOP 1 Radiated Emissions**

Tracking # 32063527.001 Page 4 of 6

<b>EUT Name</b>	USB Wireless Audio Transmitter	<b>Date</b>	September 9, 2020
<b>EUT Model</b>	Stealth 700P Gen 2 TX	<b>Temp / Hum in</b>	23°C / 41%rh
<b>EUT Serial</b>	PP #2	<b>Temp / Hum out</b>	N/A
<b>EUT Config.</b>	1 Mbps on Z-Axis	<b>Line AC / Freq</b>	5.0 VDC
<b>Standard</b>	CFR47 Part 15 Subpart C	<b>RBW / VBW</b>	1 MHz / 3 MHz
<b>Dist/Ant Used</b>	3m / EMCO-3115, 1m / ComPower-AHA840	<b>Performed by</b>	Jeremy Luong

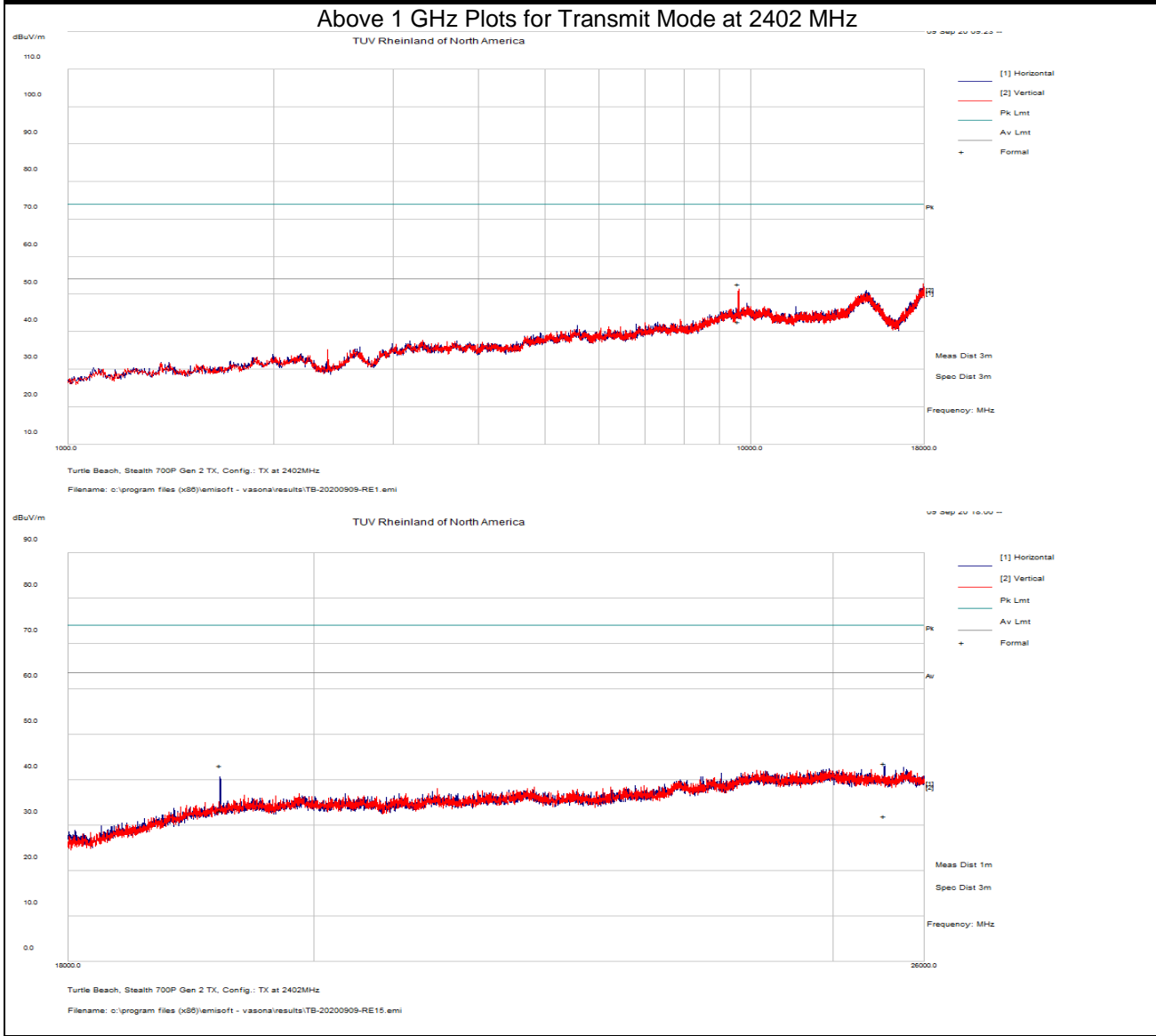

Notes: None.

**SOP 1 Radiated Emissions**

Tracking # 32063527.001 Page 5 of 6

<b>EUT Name</b>	USB Wireless Audio Transmitter	<b>Date</b>	September 9, 2020
<b>EUT Model</b>	Stealth 700P Gen 2 TX	<b>Temp / Hum in</b>	23°C / 41%rh
<b>EUT Serial</b>	PP #2	<b>Temp / Hum out</b>	N/A
<b>EUT Config.</b>	1 Mbps on Z-Axis	<b>Line AC / Freq</b>	5.0 VDC
<b>Standard</b>	CFR47 Part 15 Subpart C	<b>RBW / VBW</b>	1 MHz / 3 MHz
<b>Dist/Ant Used</b>	3m / EMCO-3115, 1m / ComPower-AHA840	<b>Performed by</b>	Jeremy Luong

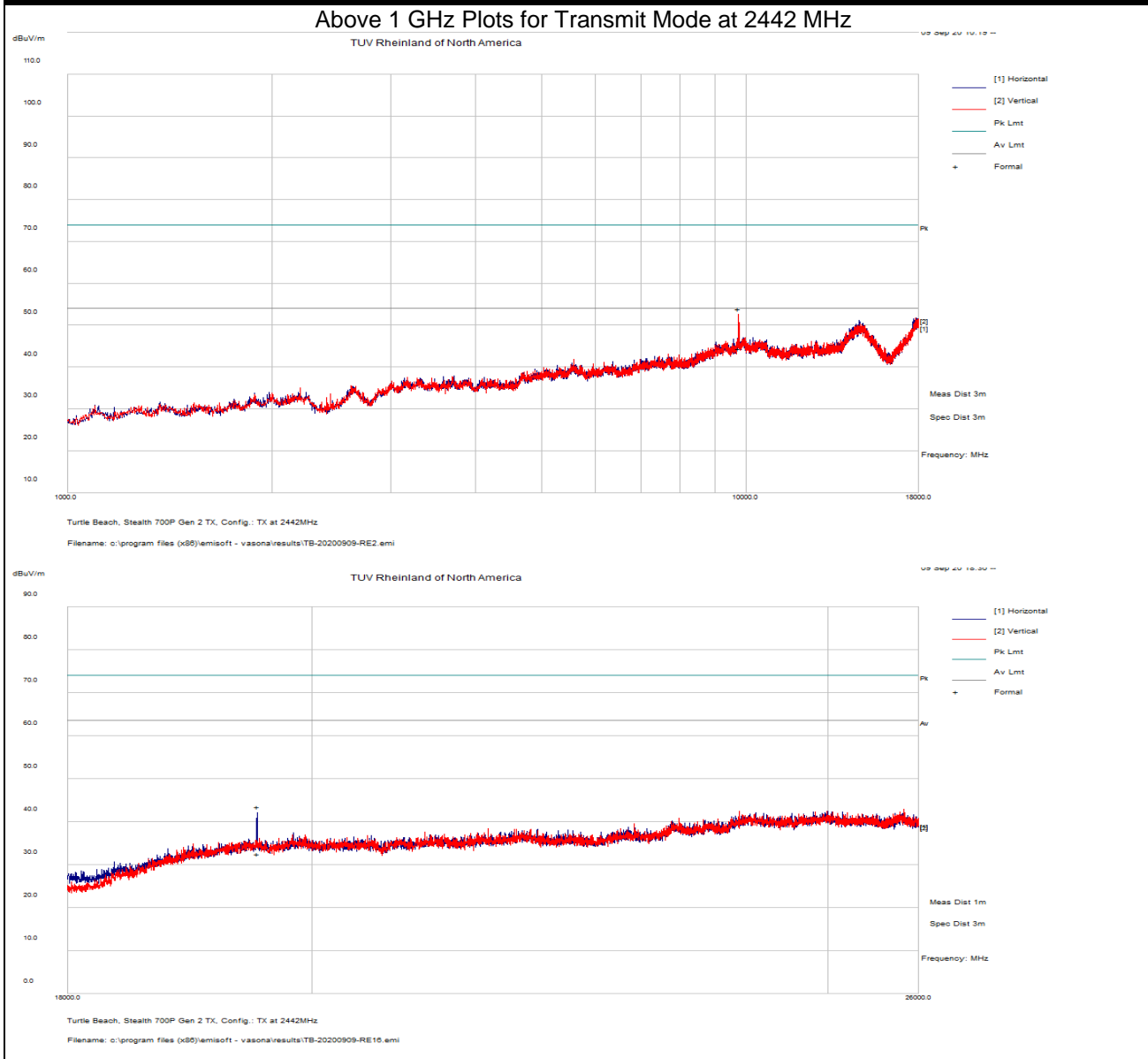

Notes: None.

**SOP 1 Radiated Emissions**

Tracking # 32063527.001 Page 6 of 6

<b>EUT Name</b>	USB Wireless Audio Transmitter	<b>Date</b>	September 9, 2020
<b>EUT Model</b>	Stealth 700P Gen 2 TX	<b>Temp / Hum in</b>	23°C / 41%rh
<b>EUT Serial</b>	PP #2	<b>Temp / Hum out</b>	N/A
<b>EUT Config.</b>	1 Mbps on Z-Axis	<b>Line AC / Freq</b>	5.0 VDC
<b>Standard</b>	CFR47 Part 15 Subpart C	<b>RBW / VBW</b>	1 MHz / 3 MHz
<b>Dist/Ant Used</b>	3m / EMCO-3115, 1m / ComPower-AHA840	<b>Performed by</b>	Jeremy Luong

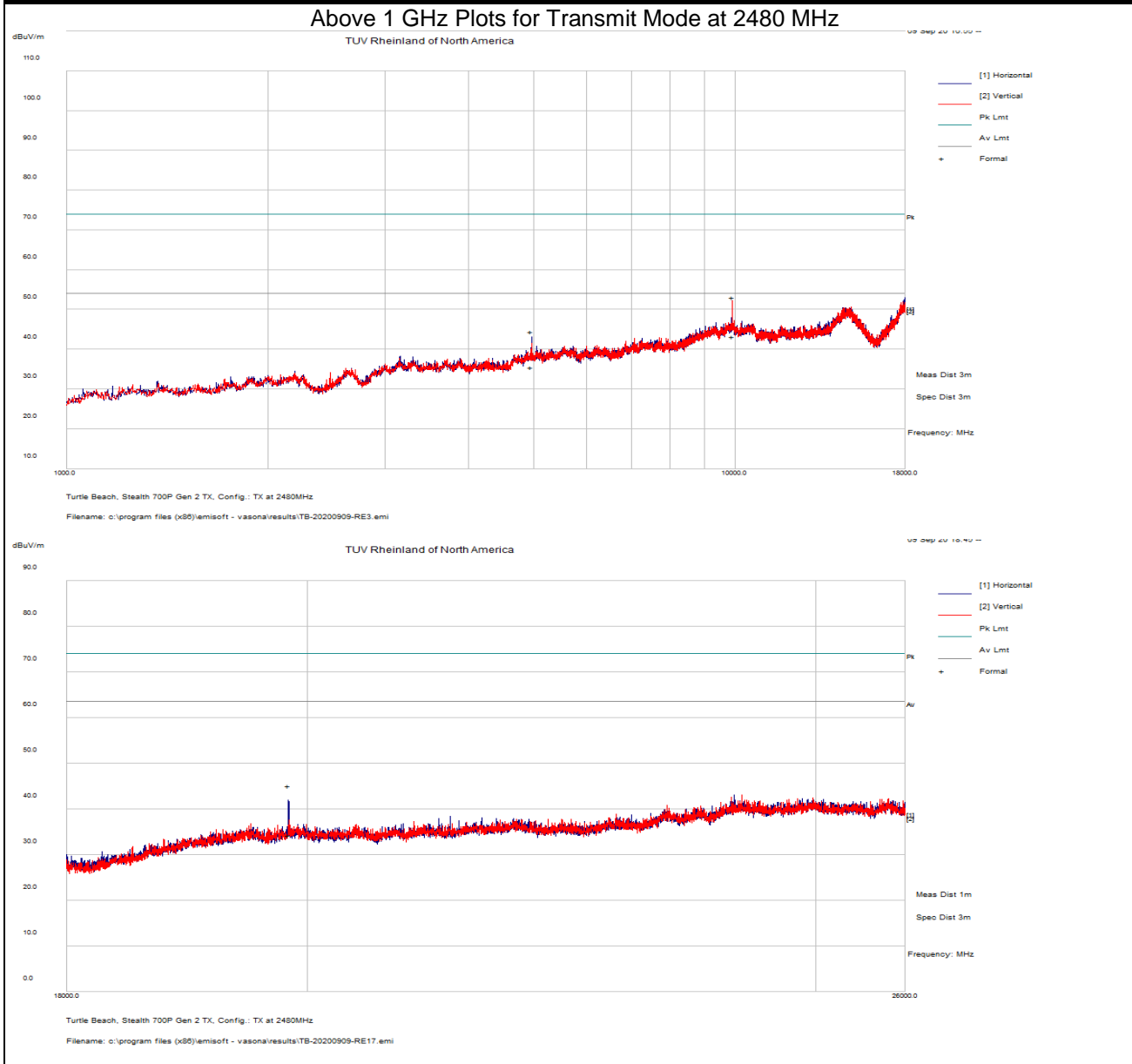

Notes: None.

#### 4.5.4 Sample Calculation

The field strength is calculated by subtracting the Amplifier Gain and adding the Cable Loss and Antenna Correction Factor to the measured reading. The basic equation is as follows:

$$\text{Field Strength (dB}\mu\text{V/m)} = \text{FIM} - \text{AMP} + \text{CBL} + \text{ACF}$$

Where: FIM = Field Intensity Meter (dB $\mu$ V)

AMP = Amplifier Gain (dB)

CBL = Cable Loss (dB)

ACF = Antenna Correction Factor (dB/m)

$$\mu\text{V/m} = 10^{\frac{\text{dB}\mu\text{V/m}}{20}}$$

## 4.6 AC Conducted Emissions

Testing was performed in accordance with ANSI C63.10: 2013. These test methods are listed under the laboratory’s A2LA Scope of Accreditation.

This test measures the levels emanating from the EUT’s AC input port, thus evaluating the potential for the EUT to cause radio frequency interference to other electronic devices.

The AC conducted emissions of equipment under test shall not exceed the values in CFR47 Part 15.207: 2020 and RSS Gen: 2019 Sect. 8.8.

### 4.6.1 Test Methodology

A test program that controls instrumentation and data logging was used to automate the AC Power Line Conducted emission test procedure. The frequency range of interest was divided into sub-ranges such as to yield a frequency resolution of 9 kHz. Each phase and neutral of the AC power line were measured with respect to ground. Measurements were performed using a set of 50µH / 50Ω LISNs.

Testing is performed in Lab 5. The setup photographs clearly identify which site was used. The vertical ground plane used in the semi-anechoic chamber is a 2m x 2m solid aluminum frame and panel, and it is bonded to the horizontal ground plane.

In the case of tabletop equipment, the EUT is placed on a 1.0m x 1.5m non-conductive table 80cm above the ground plane and 40cm from a vertical ground reference plane. The rear of the EUT was positioned flush with the backside of the table and directly over the LISNs. The power and I/O cables were routed over the edge of the table and bundled approximately 40cm from the ground plane. Support equipment was powered from a separate LISN.

#### 4.6.1.1 Deviations

There were no deviations from this test methodology.

### 4.6.2 Test Results

As originally tested, the EUT was found to be compliant to the requirements of the test standard(s).

**Table 7: AC Conducted Emissions – Test Results**

<b>Test Conditions:</b> Conducted Measurement		<b>Test Date:</b> September 10, 2020
<b>Antenna Type:</b> Integrated		<b>Power Level:</b> See Test Plan
<b>AC Power:</b> USB Host Computer		<b>Configuration:</b> Tabletop
<b>Ambient Temperature:</b> 23° C		<b>Relative Humidity:</b> 37% RH
Configuration	Frequency Range	Test Result
Line 1 (Hot)	0.15 to 30 MHz	Pass
Line 2 (Neutral)	0.15 to 30 MHz	Pass



SOP 2 Conducted Emissions						Tracking # 32063527.001 Page 1 of 4			
<b>EUT Name</b>		USB Wireless Audio Transmitter			<b>Date</b>		September 10, 2020		
<b>EUT Model</b>		Stealth 700P Gen 2 TX			<b>Temp / Hum in</b>		23° C / 37% rh		
<b>EUT Serial</b>		PP #2			<b>Temp / Hum out</b>		N/A		
<b>EUT Config.</b>		Integrated Antenna			<b>Line AC / Freq</b>		110 Vac/60 Hz @ Host PC		
<b>Standard</b>		CFR47 Part 15.207			<b>RBW / VBW</b>		9 kHz / 30 kHz		
<b>Lab/LISN</b>		Lab #2 /Com-Power, Line 1			<b>Performed by</b>		Jeremy Luong		
Frequency	Raw	Limit	Ins. Loss	Level	Detector	Line	Limit	Margin	Result
MHz	dBuV	dB	dB	dBuV		Line	dBuV	dB	
0.487	26.24	9.98	0.04	36.26	QP	Live	56.23	-19.97	Pass
0.487	9.22	9.98	0.04	19.24	Ave	Live	46.23	-26.98	Pass
0.513	25.35	9.98	0.04	35.37	QP	Live	56.00	-20.63	Pass
0.513	10.67	9.98	0.04	20.69	Ave	Live	46.00	-25.31	Pass
0.565	28.85	9.98	0.04	38.87	QP	Live	56.00	-17.13	Pass
0.565	19.62	9.98	0.04	29.64	Ave	Live	46.00	-16.36	Pass
0.593	27.26	9.98	0.04	37.28	QP	Live	56.00	-18.72	Pass
0.593	13.10	9.98	0.04	23.12	Ave	Live	46.00	-22.88	Pass
0.617	25.85	9.98	0.04	35.87	QP	Live	56.00	-20.13	Pass
0.617	9.68	9.98	0.04	19.70	Ave	Live	46.00	-26.30	Pass
0.638	26.63	9.98	0.04	36.65	QP	Live	56.00	-19.35	Pass
0.638	15.24	9.98	0.04	25.26	Ave	Live	46.00	-20.74	Pass
0.692	23.23	9.98	0.04	33.25	QP	Live	56.00	-22.75	Pass
0.692	11.92	9.98	0.04	21.94	Ave	Live	46.00	-24.06	Pass
Spec Margin = QP./Ave. - Limit, ± Uncertainty									
Combined Standard Uncertainty $u_c(y) = \pm 2.18$ dB Expanded Uncertainty $U = ku_c(y)$ $k = 2$ for 95% confidence									
Notes: EUT was setup as table top equipment and transmitted at 2402 MHz									

**SOP 2** Conducted Emissions

Tracking # 32063527.001 Page 2 of 4

<b>EUT Name</b>	USB Wireless Audio Transmitter	<b>Date</b>	September 10, 2020
<b>EUT Model</b>	Stealth 700P Gen 2 TX	<b>Temp / Hum in</b>	23° C / 37% rh
<b>EUT Serial</b>	PP #2	<b>Temp / Hum out</b>	N/A
<b>EUT Config.</b>	Integrated Antenna	<b>Line AC</b>	120 Vac/60 Hz @ PC
<b>Standard</b>	CFR47 Part 15.207	<b>RBW / VBW</b>	9 kHz / 30 kHz
<b>Lab/LISN</b>	Lab #2 /Com-Power, Line 1	<b>Performed by</b>	Jeremy Luong

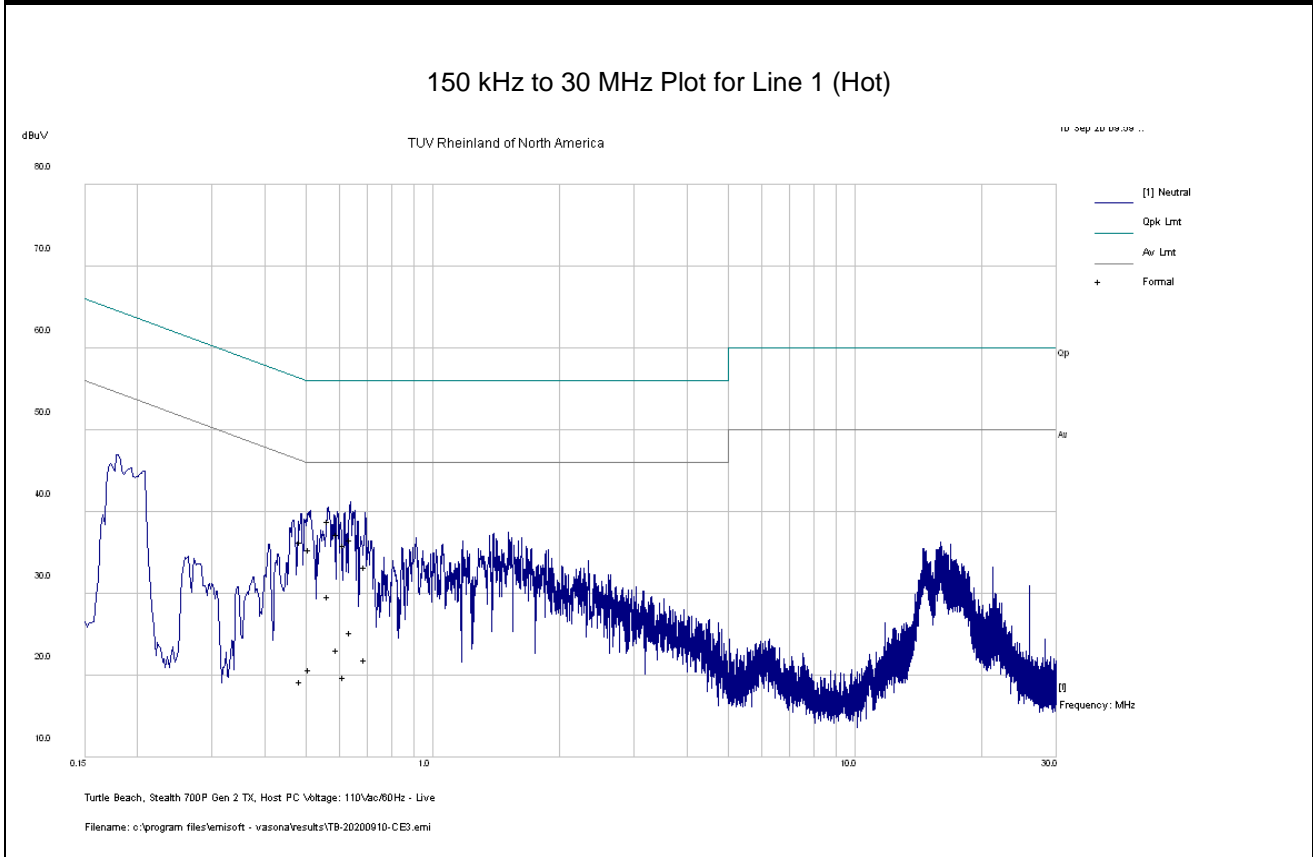

Notes: Meets FCC Class B limit.

SOP 2 Conducted Emissions						Tracking # 32063527.001 Page 3 of 4				
<b>EUT Name</b>	USB Wireless Audio Transmitter					<b>Date</b>	September 10, 2020			
<b>EUT Model</b>	Stealth 700P Gen 2 TX					<b>Temp / Hum in</b>	23° C / 37% rh			
<b>EUT Serial</b>	PP #2					<b>Temp / Hum out</b>	N/A			
<b>EUT Config.</b>	Integrated Antenna					<b>Line AC / Freq</b>	110 Vac/60 Hz @ Host PC			
<b>Standard</b>	CFR47 Part 15.207					<b>RBW / VBW</b>	9 kHz / 30 kHz			
<b>Lab/LISN</b>	Lab #2 /Com-Power, Line 2					<b>Performed by</b>	Jeremy Luong			
Frequency	Raw	Limiter	Ins. Loss	Level	Detector	Line	Limit	Margin	Result	
MHz	dBuV	dB	dB	dBuV		Line	dBuV	dB		
0.174	32.35	9.95	0.08	42.38	QP	Neutral	64.75	-22.38	Pass	
0.174	17.57	9.95	0.08	27.60	Ave	Neutral	54.75	-27.15	Pass	
0.191	31.86	9.95	0.07	41.88	QP	Neutral	63.99	-22.11	Pass	
0.191	20.08	9.95	0.07	30.10	Ave	Neutral	53.99	-23.89	Pass	
0.509	26.32	9.98	0.04	36.34	QP	Neutral	56.00	-19.66	Pass	
0.509	14.24	9.98	0.04	24.26	Ave	Neutral	46.00	-21.74	Pass	
0.569	24.21	9.98	0.04	34.23	QP	Neutral	56.00	-21.77	Pass	
0.569	15.08	9.98	0.04	25.10	Ave	Neutral	46.00	-20.90	Pass	
0.645	26.19	9.98	0.04	36.21	QP	Neutral	56.00	-19.79	Pass	
0.645	11.80	9.98	0.04	21.82	Ave	Neutral	46.00	-24.18	Pass	
0.666	25.10	9.98	0.04	35.12	QP	Neutral	56.00	-20.88	Pass	
0.666	9.38	9.98	0.04	19.40	Ave	Neutral	46.00	-26.60	Pass	
1.629	19.05	10.00	0.04	29.09	QP	Neutral	56.00	-26.91	Pass	
1.629	4.22	10.00	0.04	14.26	Ave	Neutral	46.00	-31.74	Pass	
Spec Margin = QP./Ave. - Limit, ± Uncertainty										
Combined Standard Uncertainty $u_c(y) = \pm 2.18$ dB Expanded Uncertainty $U = k u_c(y)$ $k = 2$ for 95% confidence										
Notes: EUT was setup as table top equipment and transmitted at 2402 MHz										

**SOP 2** Conducted Emissions

Tracking # 32063527.001 Page 4 of 4

<b>EUT Name</b>	USB Wireless Audio Transmitter	<b>Date</b>	September 10, 2020
<b>EUT Model</b>	Stealth 700P Gen 2 TX	<b>Temp / Hum in</b>	23° C / 37% rh
<b>EUT Serial</b>	PP #2	<b>Temp / Hum out</b>	N/A
<b>EUT Config.</b>	Integrated Antenna	<b>Line AC / Freq</b>	120 Vac/60 Hz @ PC
<b>Standard</b>	CFR47 Part 15.207	<b>RBW / VBW</b>	9 kHz / 30 kHz
<b>Lab/LISN</b>	Lab #2 /Com-Power, Line 2	<b>Performed by</b>	Jeremy Luong

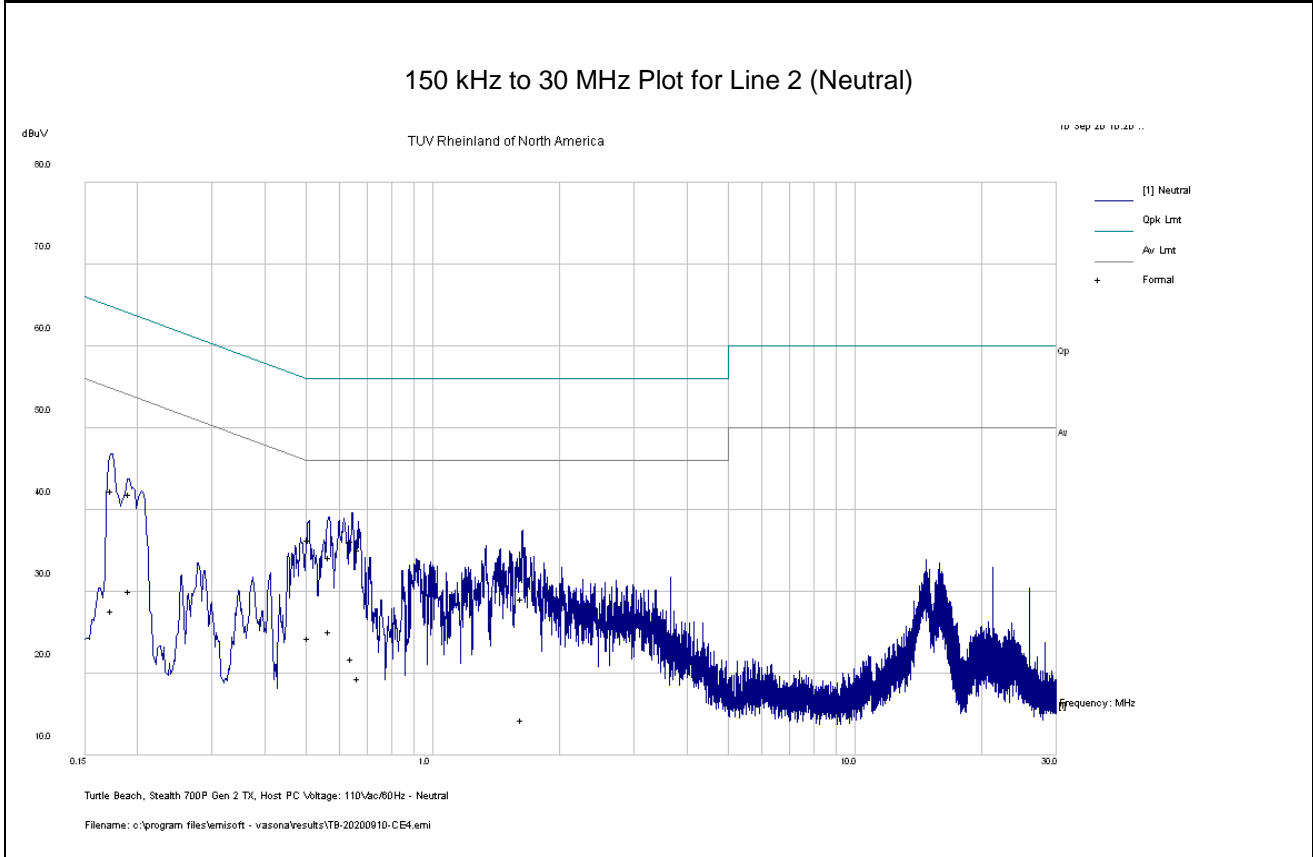

Note: Meets FCC Class B Limit.

## 5 Test Equipment List

### 5.1 Equipment List

Equipment	Manufacturer	Model #	Serial/Inst #	Last Cal mm/dd/yyyy	Next Cal mm/dd/yyyy
Loop Antenna	EMCO	6502	62531	07/01/2019	07/01/2021
Bilog Antenna	Sunol Sciences	JB3	A020502	03/12/2020	03/12/2022
Horn Ant. (1-18GHz)	Sunol Sciences	3115	9211-3969	06/20/2019	06/20/2021
Horn Ant. (18-40GHz)	Com-Power	AHA-840	105005	08/26/2019	08/26/2021
EMI Receiver	Agilent	N9038A	MY52260210	02/15/2020	02/15/2021
Spectrum Analyzer	Agilent	N9030A	MY52350885	10/26/2019	10/26/2020
EMI Receiver	Rohde & Schwarz	ESIB40	100180	09/20/2019	09/20/2020
Preamplifier	Sonoma Inst.	310	185516	02/12/2020	02/12/2021
Preamplifier	Miteq	TTA1800-30-HG	184252	02/12/2020	02/12/2021
RF Power Meter	Agilent	E4418A	MY45103902	02/13/2020	02/13/2021
Power Sensor	Agilent	8481A	US37295801	02/13/2020	02/13/2021
Thermometer	Extech Instruments	SD700	A095319	03/18/2020	03/18/2021
Thermo Chamber	Espec	BTZ-133	0613436	12/20/2019	12/20/2020
DC Power Supply	Agilent	E3634A	MY400004331	02/15/2020	02/15/2021
Signal Generator	Anritsu	MG3694A	042803	02/13/2020	02/13/2021
Notch Filter	Micro-Tronics	BRM50702	37	VBU	VBU

\* Calibration of equipment past due for re-calibration will be performed expeditiously. If any equipment is found to be out of tolerance at that time, affected customers will be notified accordingly.

---

## 6 EMC Test Plan

### 6.1 Introduction

This section provides a description of the Equipment Under Test (EUT), configurations, operating conditions, and performance acceptance criteria. It is an overview of information provided by the manufacturer so that the test laboratory may perform the requested testing.

### 6.2 Customer

**Table 8:** Customer Information

<b>Company Name</b>	Voyetra Turtle Beach, Inc.
<b>Address</b>	100 Summit Lake Drive, Suite 100
<b>City, State, Zip</b>	Valhalla, New York 10595 USA
<b>Country</b>	USA

**Table 9:** Technical Contact Information

<b>Name</b>	Tim Blaney
<b>E-mail</b>	tim@commcepts.net
<b>Phone</b>	(530) 277-3482

### 6.3 Equipment Under Test (EUT)

**Table 10:** EUT Specifications

<b>EUT Specification</b>	
Package Dimensions	31.5 mm (1.25") x 13.5 mm (0.5") x 6 mm (0.24")
Power Input	Transmitter Input Voltage: 5.0 Vdc (Host Computer)
Environment	Indoor
Operating Temperature Range:	0 to 50 degrees C
Multiple Feeds:	<input type="checkbox"/> Yes and how many <input checked="" type="checkbox"/> No
Product Marketing Name (PMN)	Stealth 700P Gen 2 TX
Hardware Version Identification Number (HVIN)	700P Gen 2 TX
Firmware Version Identification Number (FVIN)	1.0.9.0PIC32
Operating Mode	TestCommon Unit Test 1.0.1.7
Transmitter Frequency Band	2402 MHz to 2480 MHz
Max. Measured Power Output	+4.48 dBm
Power Setting @ Operating Channel	+4.0 dBm
Antenna Type	PCB Attached on board (-2.4 dBi)
Modulation Type	<input type="checkbox"/> AM <input type="checkbox"/> FM <input type="checkbox"/> DSSS <input type="checkbox"/> OFDM <input checked="" type="checkbox"/> Other describe: GFSK
Date Rate	1 Mbps and 2 Mbps
TX/RX Chain (s)	1
Directional Gain Type	<input checked="" type="checkbox"/> Uncorrelated <input checked="" type="checkbox"/> No Beam-Forming <input type="checkbox"/> Other describe:
Type of Equipment	<input type="checkbox"/> Table Top <input type="checkbox"/> Wall-mount <input type="checkbox"/> Floor standing cabinet <input checked="" type="checkbox"/> Other describe: <i>Table Top Device's accessory.</i>
Note: None	

**Table 11: Interface Specifications**

Interface Type	Cabled with what type of cable?	Is the cable shielded?	Maximum potential length of the cable?	Metallic (M), Coax (C), Fiber (F), or Not Applicable?
USB Connector	Terminated to Host USB Port	<input checked="" type="checkbox"/> Direct plug with no cable	<input checked="" type="checkbox"/> Metric:0m	<input checked="" type="checkbox"/> M

**Table 12: Supported Equipment**

Equipment	Manufacturer	Model	Serial	Used for
Laptop	Lenovo	T430	PB-8HBRR	Set test mode

**Table 13: Description of Sample used for Testing**

Device	Serial Number	Configuration	Used For
Stealth 700P Gen 2 TX	PP #2	Radiated Sample	Radiated Emissions, Conducted Emission
Stealth 700P Gen 2 TX	PP #1	Conducted Sample	Output Power, Occupied Bandwidth, Conducted Spurious Emissions, Peak Power Spectral Density
<b>Note:</b> None			

**Table 14: Description of Test Configuration used for Radiated Measurement.**

Device	Antenna	Mode	Setup Description
Stealth 700P Gen 2 TX	Integrated	Transmit & Receive	Stealth 700P Gen 2 TX positioned vertically; worst case.
<b>Note:</b> This is the final setup configuration used for testing. All other orientations were investigated for worst case configuration.			



**Table 15:** Final Test Mode for 2402 MHz to 2480MHz Band

<b>Test</b>	<b>Stealth 700P Gen 2 TX</b>
Occupied Bandwidth	2402, 2442, 2480 MHz @ 1 Mbps
Output Power	2402, 2442, 2480 MHz @ 1 Mbps
Peak Power Spectral Density	2402, 2442, 2480 MHz @ 2 Mbps
Out-of-Band (-30 dBr)	2402, 2442, 2480 MHz @ 1 Mbps
Band-Edge (Radiated)	2402, 2480 MHz @ 2 Mbps
Transmitted Spurious Emission	2402, 2442, 2480 MHz @ 1 Mbps
AC Conducted Emission	2402 MHz @ 1 Mbps
<b>Note:</b> EUT transmits at 100% duty cycle.	

---

## 6.4 Test Specifications

**Table 16:** Test Specifications

<b>Emissions and Immunity</b>	
<b>Rules &amp; Regulations / Standards</b>	<b>Requirement</b>
CFR 47 Part 15.247: 2020	All
RSS 247 Issue 2, 2017	All

**END OF REPORT**