

Emissions Test Report

EUT Name: Wireless Audio Transmitter

Model No.: Elite 800 TX

CFR 47 Part 15.407:2015 and RSS-247:2015

Prepared for:

Voyetra Turtle Beach, Inc.
100 Summit Lake Drive, Suite 100
Valhalla, New York, 10595 USA

Prepared by:

TUV Rheinland of North America, Inc.
1279 Quarry Lane, Ste. A
Pleasanton, CA 94566 U.S.A.
Tel: (925) 249-9123
Fax: (925) 249-9124
<http://www.tuv.com/>

Report/Issue Date: January 06, 2016
Report Number: 31563518.001
Project Number: 0000134928
Revision Number: 0

Statement of Compliance

Manufacturer: Voyetra Turtle Beach, Inc.
100 Summit Lake Drive, Suite 100
Valhalla, New York, 10595 USA

Requester / Applicant: Tim Blaney

Name of Equipment: Wireless Audio Transmitter
Model No. Elite 800 TX (TB300-3391-01)
Type of Equipment: Intentional Radiator
Application of Regulations: CFR 47 Part 15.407:2015 and RSS-247:2015
Test Dates: 20 October 2015 to 05 January 2016

Guidance Documents:

Emissions: ANSI C63.10-2013, KDB 789033 D02 General UNII Test Procedure New Rules v01

Test Methods:

Emissions: ANSI C63.10-2013, KDB 789033 D02 General UNII Test Procedure New Rules v01

The electromagnetic compatibility test and documented data described in this report has been performed and recorded by TUV Rheinland, in accordance with the standards and procedures listed herein. As the responsible authorized agent of the EMC laboratory, I hereby declare that the equipment described above has been shown to be compliant with the EMC requirements of the stated regulations and standards based on these results. If any special accessories and/or modifications were required for compliance, they are listed in the Executive Summary of this report.

This report must not be used to claim product endorsement by A2LA or any agency of the U.S. Government. This report contains data that are not covered by A2LA accreditation. This report shall not be reproduced except in full, without the written authorization of TUV Rheinland of North America.

Kerwinn Corpuz January 06, 2016

Test Engineer

Date

David Spencer

January 06, 2016

Laboratory Signature

Date



**INDUSTRY
CANADA**

Testing Cert #3331.02

US5254

2932M-1

Table of Contents

1	Executive Summary	7
1.1	Scope	7
1.2	Purpose	7
1.3	Summary of Test Results	8
1.4	Special Accessories	8
1.5	Equipment Modifications	8
2	Laboratory Information	9
2.1	Accreditations & Endorsements	9
2.1.1	US Federal Communications Commission	9
2.1.2	NIST / A2LA	9
2.1.3	Canada – Industry Canada	9
2.1.4	Japan – VCCI	9
2.1.5	Acceptance by Mutual Recognition Arrangement	9
2.2	Test Facilities	10
2.2.1	Emission Test Facility	10
2.2.2	Immunity Test Facility	10
2.3	Measurement Uncertainty	11
2.3.1	Sample Calculation – radiated & conducted emissions	11
2.3.2	Measurement Uncertainty Emissions	11
2.3.3	Measurement Uncertainty Immunity	12
2.4	Calibration Traceability	12
3	Product Information	13
3.1	Product Description	13
3.2	Equipment Configuration	13
3.3	Operating Mode	13
3.4	Unique Antenna Connector	14
3.4.1	Results	14
4	Emission Requirements - 5150 MHz to 5250 MHz Band	15
4.1	Output Power Requirements	15
4.1.1	Test Method	15
4.1.2	Results	16
4.2	Occupied Bandwidth	19
4.2.1	Test Method	19
4.2.2	Results	20
4.3	Peak Power Spectral Density	23
4.3.1	Test Method	23
4.3.2	Results	24
4.4	Undesirable Emission Limits	27
4.4.1	Test Method	27
4.4.2	Results	27

Table of Contents

4.5	Transmitter Spurious Emissions	33
4.5.1	Test Methodology	33
4.5.2	Transmitter Spurious Emission Limit	35
4.5.3	Test Results	35
4.5.4	Sample Calculation	48
4.6	AC Conducted Emissions	49
4.6.1	Test Methodology	49
4.6.2	Test Results	49
4.7	Frequency Stability	54
4.7.1	Test Methodology	54
4.7.2	Manufacturer Declaration	54
4.7.3	Limit	55
4.7.4	Test results	55
4.8	Voltage Variation	57
4.8.1	Test Methodology	57
4.8.2	Test results	57
4.9	Maximum Permissible Exposure	59
4.9.1	Test Methodology	59
4.9.2	FCC KDB 447498 D01 – General SAR Test Exclusion Guidance	59
4.9.3	EUT Operating Condition	59
4.9.4	Classification	60
4.9.5	SAR Test Exclusion Threshold	60
5	Test Equipment Use List	61
5.1	Equipment List	61
6	EMC Test Plan	62
6.1	Introduction	62
6.2	Customer	62
6.3	Equipment Under Test (EUT)	63
6.4	Test Specifications	66

Index of Tables

Table 1: Summary of Test Results 8
Table 2: RF Output Power at the Antenna Port – Test Results 16
Table 3: Occupied Bandwidth – Test Results 20
Table 4: Maximum Power Spectral Density – Test Results..... 24
Table 5: Emissions at the Band-Edge – Test Results..... 28
Table 6: Transmit Spurious Emission at Band-Edge Requirements 36
Table 7: AC Conducted Emissions – Test Results..... 49
Table 8: Frequency Stability – Test Results 55
Table 9: Voltage Variation – Test Results 57
Table 10: Customer Information 62
Table 11: Technical Contact Information 62
Table 12: EUT Specifications 63
Table 13: Interface Specifications..... 64
Table 14: Supported Equipment..... 64
Table 15: Description of Sample used for Testing..... 64
Table 16: Description of Test Configuration used for Radiated Measurement. 64
Table 17: Final Test Mode for 5150 - 5250 Bands 65
Table 18: Test Specifications 66

1 Executive Summary

1.1 Scope

This report is intended to document the status of conformance with the requirements of the CFR 47 Part 15.407:2015 and RSS-247:2015 based on the results of testing performed on 20 October 2015 to 05 January 2016 on the Wireless Audio Transmitter Model Elite 800 TX manufactured by Voyetra Turtle Beach, Inc. This report only applies to the specific samples tested under the stated test conditions. It is the responsibility of the manufacturer to assure that additional production units of this model are manufactured with identical or EMI equivalent electrical and mechanical components. This report is further intended to document changes and modifications to the EUT throughout its life cycle. All documentation will be included as a supplement.

1.2 Purpose

Testing was performed to evaluate the EMC performance of the EUT in accordance with the applicable requirements, procedures, and criteria defined in the application of regulations and application of standards listed in this report.

The report documents the 5 GHz radio characteristics inside the Elite 800 TX.

1.3 Summary of Test Results

Table 1: Summary of Test Results

Test	Test Method ANSI C63.4:2014/ ANSI C63.10:2013	Test Parameters	Measured Value	Result
5180 MHz to 5240 MHz Band				
Spurious Emission in Transmitted Mode	CFR47 15.209, CFR47 15.407 (b) RSS-GEN Sect.7.2.3, RSS-247 Sect.6.2.1.2	Class B	-0.16 dB (margin)	Complied
Restricted Bands of Operation	CFR47 15.205, RSS-GEN Sect.8.10	Class B		Complied
AC Power Conducted Emission	CFR47 15.207, RSS-GEN Sect.8.8	Class B	-3.25 dB (margin)	Complied
Occupied Bandwidth	CFR47 15.407 (a), RSS-GEN Sect.6.6	N/A	26dB BW: 34.39 MHz 99% BW: 18.756 MHz	Complied
Maximum Output Power	CFR47 15.407 (a) [see note 3]	22.73 dBm	8.85 dBm	Complied
Maximum Output Power	RSS 247 Sect.6.2.1.1 [see note 4]	19.23 dBm	8.85 dBm	Complied
Peak Power Spectral Density	CFR47 15.407 (a)	11 dBm/MHz	-3.423 dBm/MHz	Complied
Peak Power Spectral Density	RSS 247 Sect.6.2.1.1	6.5 dBm/MHz	-3.423 dBm/MHz	Complied
Conducted Emission – Antenna Port	CFR47 15.407 (b), RSS-247 Sect.6.2.2.2	< -27 dBm/MHz	-5.27 dB (margin)	Complied
Frequency Stability	CFR47 15.407 (g), RSS GEN Sect. 6.11	±20 ppm	17.668 ppm	Complied
Maximum Permissible Exposure	CFR47 2.1093 / KDB 447498 D01, RSS-102 Issue 5	≤ 3.0 for 1-g	1.968 for 1-g (SAR Exempted)	Complied

Note: 1. Meet restricted band emission requirements.
 2. This report is only documented for 5150 – 5250 MHz band.
 3. Measurement in conducted.
 4. Max power, 1 Spatial Stream, in E.I.R.P.

1.4 Special Accessories

No special accessories were necessary in order to achieve compliance.

1.5 Equipment Modifications

None

2 Laboratory Information

2.1 Accreditations & Endorsements

2.1.1 US Federal Communications Commission



TUV Rheinland of North America at 1279 Quarry Ln, Pleasanton, CA 94566 is recognized by the commission for performing testing services for the general public on a fee basis. These laboratory test facilities have been fully described in reports submitted to and accepted by the FCC (US5254). The laboratory scope of accreditation includes: Title 47 CFR Parts 15, 18, and 90. The accreditation is updated every 3 years.

2.1.2 NIST / A2LA



TUV Rheinland of North America is accredited by the National Voluntary Laboratory Accreditation Program, which is administered under the auspices of the National Institute of Standards and Technology. The laboratory has been assessed and accredited in accordance with ISO Guide 17025:2005 and ISO 9002 (Lab Code 3331.02). The scope of laboratory accreditation includes emission and immunity testing. The accreditation is updated annually.

2.1.3 Canada – Industry Canada



TUV Rheinland of North America at the 1279 Quarry Ln, Pleasanton, CA 94566 address is accredited by Industry Canada for performing testing services for the general public on a fee basis. This laboratory test facilities have been fully described in reports submitted to and accepted by Industry Canada (File Number 2932M). This reference number is the indication to the Industry Canada Certification Officers that the site meets the requirements of RSS 212, Issue 1 (Provisional). The accreditation is updated every 3 years.

2.1.4 Japan – VCCI



The Voluntary Control Council for Interference by Information Technology Equipment (VCCI) is a group that consists of Information Technology Equipment (ITE) manufacturers and EMC test laboratories. The purpose of the Council is to take voluntary control measures against electromagnetic interference from Information Technology Equipment, and thereby contribute to the development of a socially beneficial and responsible state of affairs in the realm of Information Technology Equipment in Japan. TUV Rheinland of North America at 1279 Quarry Ln, Pleasanton, CA 94566 has been assessed and approved in accordance with the Regulations for Voluntary Control Measures.

VCCI Registration No. for Pleasanton: A-0031

VCCI Registration No. for Santa Clara: A-0032

2.1.5 Acceptance by Mutual Recognition Arrangement



The United States has an established agreement with specific countries under the Asia Pacific Laboratory Accreditation Corporation (APLAC) Mutual Recognition Arrangement. Under this agreement, all TUV Rheinland at 1279 Quarry Ln, Pleasanton, CA 94566 test results and test reports within the scope of the laboratory NIST / A2LA accreditation will be accepted by each member country.

2.2 Test Facilities

All of the test facilities are located at 1279 Quarry Lane, Pleasanton, California 94566, USA. The 2305 Mission College, Santa Clara, 95054, USA location is considered a Pleasanton annex.

2.2.1 Emission Test Facility

The Semi-Anechoic chamber and AC Line Conducted measurement facility used to collect the radiated and conducted data has been constructed in accordance with ANSI C63.7:1992. The site has been measured in accordance with and verified to comply with the theoretical normalized site attenuation requirements of ANSI C63.4-2009, at a test distance of 3 and 5 meters. The site is listed with the FCC and accredited by A2LA (Lab Code 3331.02). The 3/5-meter semi-anechoic chamber used to collect the radiated data has been verified to comply with the theoretical normalized site attenuation requirements of ANSI C63.4-2009, at a test distance of 3 meter and 5 meters. A report detailing this site can be obtained from TUV Rheinland of North America.

2.2.2 Immunity Test Facility

ESD, EFT, Surge, PQF: These tests are performed in an environmentally controlled room with a 3.7 m x 4.8 m x 3.175 mm thick aluminum floor connected to PE ground.

For ESD testing, tabletop equipment is placed on an insulated mat with a surface resistivity of 10^9 Ohms/square on a 1.6 m x 0.8 m x 0.8 m high non-conductive table with a 3.175 mm aluminum top (Horizontal Coupling Plane). The HCP is connected to the main ground plane via a low impedance ground strap through two 470-k Ω resistors. The Vertical Coupling Plane consists of an aluminum plate 50 cm x 50 cm x 3.175 mm thick. The VCP is connected to the main ground plane via a low impedance ground strap through two 470-k Ω resistors.

For EFT, Surge, PQF, the HCP and VCP are removed.

RF Field Immunity testing is performed in a 7.3m x 4.3m x 4.1m anechoic chamber.

RF Conducted and Magnetic Field Immunity testing is performed on a 4.8m x 3.7m x 3.175mm thick aluminum ground plane.

All test areas allow a minimum distance of 1 meter from the EUT to walls or conducting objects.

2.3 Measurement Uncertainty

Two types of measurement uncertainty are expressed in this report, per *ISO Guide To The Expression Of Uncertainty In Measurement*, 1st Edition, 1995.

The Combined Standard Uncertainty is the standard uncertainty of the result of a measurement when that result is obtained from the values of a number of other quantities; it is equal to the positive square root of the sum of the variances or co-variances of these other quantities, weighted according to how the measurement result varies with changes in these quantities. The term *standard uncertainty* is the result of a measurement expressed as a standard deviation.

2.3.1 Sample Calculation – radiated & conducted emissions

The field strength is calculated by subtracting the Amplifier Gain and adding the Cable Loss and Antenna Correction Factor to the measured reading. The basic equation is as follows:

$$\text{Field Strength (dB}\mu\text{V/m)} = \text{RAW} - \text{AMP} + \text{CBL} + \text{ACF}$$

Where: RAW = Measured level before correction (dBμV)

AMP = Amplifier Gain (dB)

CBL = Cable Loss (dB)

ACF = Antenna Correction Factor (dB/m)

$$\mu\text{V/m} = 10^{\frac{\text{dB}\mu\text{V/m}}{20}}$$

Sample radiated emissions calculation @ 30 MHz

Measurement +Antenna Factor–Amplifier Gain+Cable loss=Radiated Emissions (dBuV/m)

$$25 \text{ dBuV/m} + 17.5 \text{ dB} - 20 \text{ dB} + 1.0 \text{ dB} = 23.5 \text{ dBuV/m}$$

2.3.2 Measurement Uncertainty Emissions

Per CISPR 16-4-2	U _{lab}	U _{cispr}
Radiated Disturbance @ 10 meters		
30 – 1,000 MHz	2.25 dB	4.51 dB
Radiated Disturbance @ 3 meters		
30 – 1,000 MHz	2.26 dB	4.52 dB
1 – 6 GHz	2.12 dB	4.25 dB
6 – 18 GHz	2.47 dB	4.93 dB
Conducted Disturbance @ Mains Terminals		
150 kHz – 30 MHz	1.09 dB	2.18 dB
Disturbance Power		
30 MHz – 300 MHz	3.92 dB	4.3 dB

Voltech PM6000A

The estimated combined standard uncertainty for harmonic current and flicker measurements is $\pm 5.0\%$.	Per CISPR 16-4-2 Methods
--	--------------------------

2.3.3 Measurement Uncertainty Immunity

The estimated combined standard uncertainty for ESD immunity measurements is $\pm 8.2\%$.	Per IEC 61000-4-2
The estimated combined standard uncertainty for radiated immunity measurements is ± 4.10 dB.	Per IEC 61000-4-3
The estimated combined standard uncertainty for conducted immunity measurements with CDN is ± 3.66 dB	Per IEC 61000-4-6
The estimated combined standard uncertainty for power frequency magnetic field immunity is $\pm 11.6\%$.	Per IEC 61000-4-8

Thermo KeyTek EMC Pro

The estimated combined standard uncertainty for EFT fast transient immunity measurements is $\pm 5.84\%$.
The estimated combined standard uncertainty for surge immunity measurements is $\pm 5.84\%$.
The estimated combined standard uncertainty for voltage variation and interruption measurements is $\pm 3.48\%$.

The expanded uncertainty at a level of 95% confidence is obtained by multiplying the combined standard uncertainty by a coverage factor of 2. Compliance criteria are not based on measurement uncertainty.

Measurement Uncertainty – Radio Testing

The estimated combined standard uncertainty for frequency error measurements is ± 3.88 Hz
The estimated combined standard uncertainty for carrier power measurements is ± 1.59 dB.
The estimated combined standard uncertainty for adjacent channel power measurements is ± 1.47 dB.
The estimated combined standard uncertainty for modulation frequency response measurements is ± 0.46 dB.
The estimated combined standard uncertainty for transmitter conducted emission measurements is ± 4.01 dB

The expanded uncertainty at a level of 95% confidence is obtained by multiplying the combined standard uncertainty by a coverage factor of 2. Compliance criteria are not based on measurement uncertainty.

2.4 Calibration Traceability

All measurement instrumentation is traceable to the National Institute of Standards and Technology (NIST). Measurement method complies with ANSI/NCSL Z540-1-1994 and ISO Standard 17025:2005.

3 Product Information

3.1 Product Description

The Elite 800 Wireless Gaming System consists of two main communication modules, the Elite 800 RX (“Headset”) and the Elite 800 TX (“Transmitter”). These two modules comprise a closed-loop wireless audio gaming system that utilize a Wi-Fi communication technology to offer wireless streaming audio and chat/talkback capabilities.

3.2 Equipment Configuration

A description of the equipment configuration is given in the Test Plan Section. The EUT was tested as called for in the test standard and was configured and operated in a manner consistent with its intended use. The EUT was connected to rated power and allowed to reach intended operating conditions. The placement of the EUT system components was guided by the test standard and selected to represent typical installation conditions.

In the case of a EUT that can operate in more than one configuration, preliminary testing was performed to determine the configuration that produced maximum radiation.

The final configuration was selected to produce the worst case radiation for emissions testing and to place the EUT in the most susceptible state for immunity testing.

3.3 Operating Mode

A description of the operation mode is given in the Test Plan Section. In the case of a EUT that can operate in more than one state, preliminary testing was performed to determine the operating mode that produced maximum radiation.

The final operating mode was selected to produce the worst case radiation for emissions testing and to place the EUT in the most susceptible state for immunity testing.

3.4 Unique Antenna Connector

An intentional radiator shall be designed to ensure that no antenna other than that furnished by the responsible party shall be used with the device. The use of a permanently attached antenna or of an antenna that uses a unique coupling to the intentional radiator shall be considered sufficient to comply with the provisions of this Section. The manufacturer may design the unit so that a broken antenna can be replaced by the user, but the use of a standard antenna jack or electrical connector is prohibited. This requirement does not apply to carrier current devices or to devices operated under the provisions of CFR47 Parts 15.211, 15.213, 15.217, 15.219, or 15.221.

3.4.1 Results

The Elite 800 TX uses the permanently attached PCB trace antenna inside the device. Refer to EUT Internal Photo for details. There is no external antenna connection available.

4 Emission Requirements - 5150 MHz to 5250 MHz Band

Testing was performed in accordance with CFR 47 Part 15.407: 2015 and RSS 247:2015. These test methods are listed under the laboratory's A2LA Scope of Accreditation. This test measures the levels emanating from the EUT, thus evaluating the potential for the EUT to cause radio frequency interference to other electronic devices. Procedures described in section 8 of the standard were used.

4.1 Output Power Requirements

The maximum output power requirement is the maximum equivalent isotropic radiated power delivering at the transmitting antenna under specified conditions of measurements in the presence of modulation.

The maximum output power and harmonics shall not exceed CFR47 Part 15.407 (a):2015 and RSS-247 Sect. 6.2.1.1: 2015.

The maximum transmitted powers for mobile and portable client device is

Band 5150-5250 MHz: 250 mW; per CFR47 Part 15.407

Band 5150-5250 MHz: 200 mW or $10+10\text{Log}(B)$; where B is 99% Bandwidth; per RSS-247 in E.I.R.P.

4.1.1 Test Method

The ANSI C63.10-2013 Section 6.10.3.1 conducted method was used to measure the channel power output. The preliminary investigation was performed at different data rate to determine the highest power output for each mode. The worst findings were conducted on 3 channels on the sample per CFR47 Part 15.407(a): 2015 and RSS-247 Sect. 6.2.1.1; 5150 MHz to 5250 MHz. The worst mode results indicated below.

Test Setup:

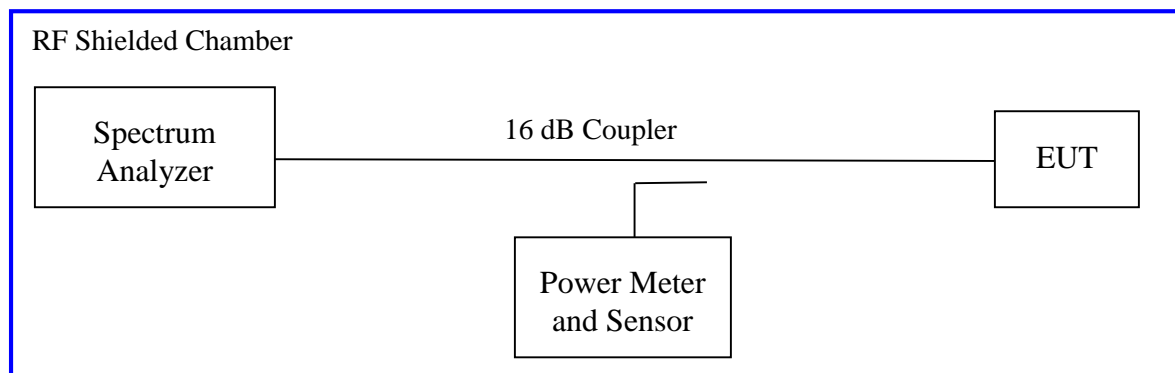

Method SA-2 of KDB 789033 D02 General UNII Test Procedure New Rules v01, "Guidelines for Compliance Testing of Unlicensed National Information Infrastructure (U-NII) Devices", applies since the EUT continuously transmit with duty cycle less 100%. The duty cycle, $CF = 10\text{Log}(1/\text{duty cycle})$, did not applied since EUT transmitted at 100% duty cycle.

4.1.2 Results

As originally tested, the EUT was found to be compliant to the requirements of the test standard(s).

Table 2: RF Output Power at the Antenna Port – Test Results

Test Conditions: Conducted Measurement		Test Date: November 17, 2015	
Antenna Type: Integrated		Power Setting: SPW 0	
Antenna Gain: +3.5 dBi		Signal State: Modulated	
Ambient Temp.: 23 °C		Relative Humidity: 34%	
Result			
Operating Channel	Limit in E.I.R.P. [dBm]	Output Power [dBm]	Margin [dB]
5180	19.23	8.35	-10.88
5200	19.23	8.28	-10.95
5240	19.23	8.85	-10.38
<p>Note: 1. The highest output power was observed at 802.11a, 6Mbps. 2. EUT is a portable device. The limit under CFR47 Part 15.407 (a)(1)(iv) is 250 mW or 23.98 dBm. RSS 247 Sect. 6.2.1.1 limit calculated using 99% bandwidth is 22.73 dBm. Since the calculated limit is more stricken, it is used to show compliance to both FCC and IC. 3. Measurements performed at 100% duty cycle; therefore, duty correction factor do not include to the final calculation. 4. Maximum antenna gain is less than 6 dBi; therefore, no antenna correction factor was applied.</p>			

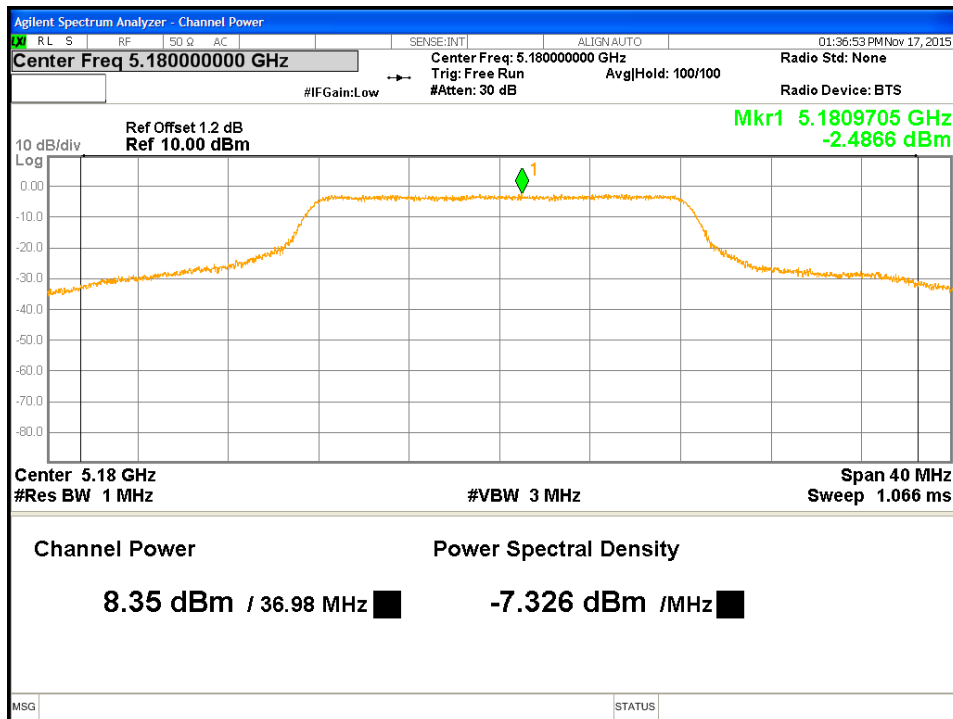

Figure 1: Maximum Conducted Output Power-5180 MHz-11a-6Mbps

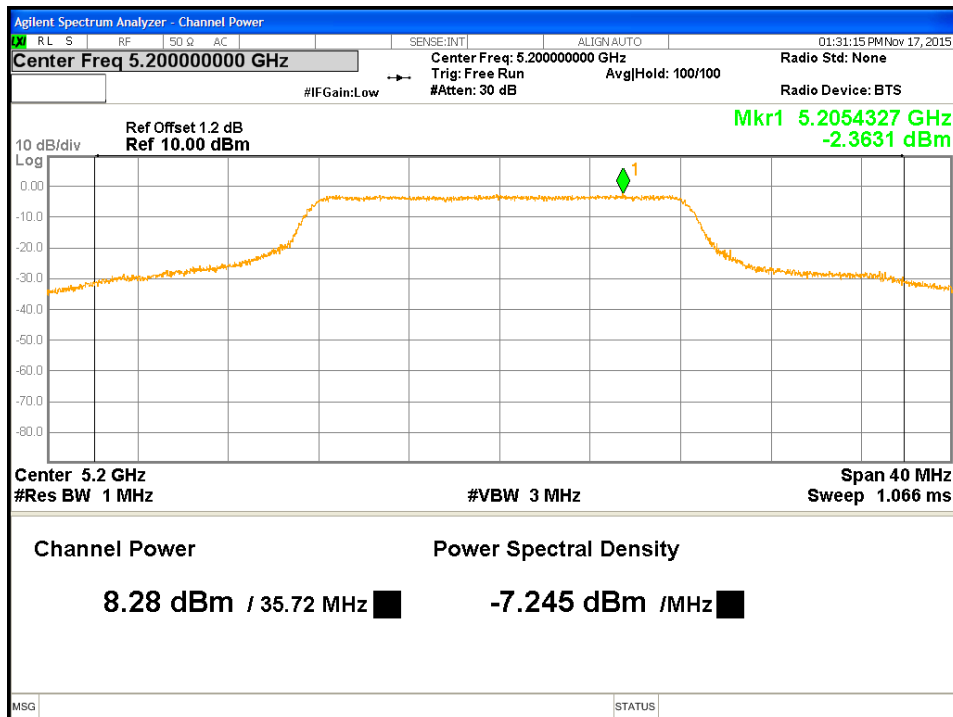

Figure 2: Maximum Conducted Output Power-5200 MHz-11a-6Mbps

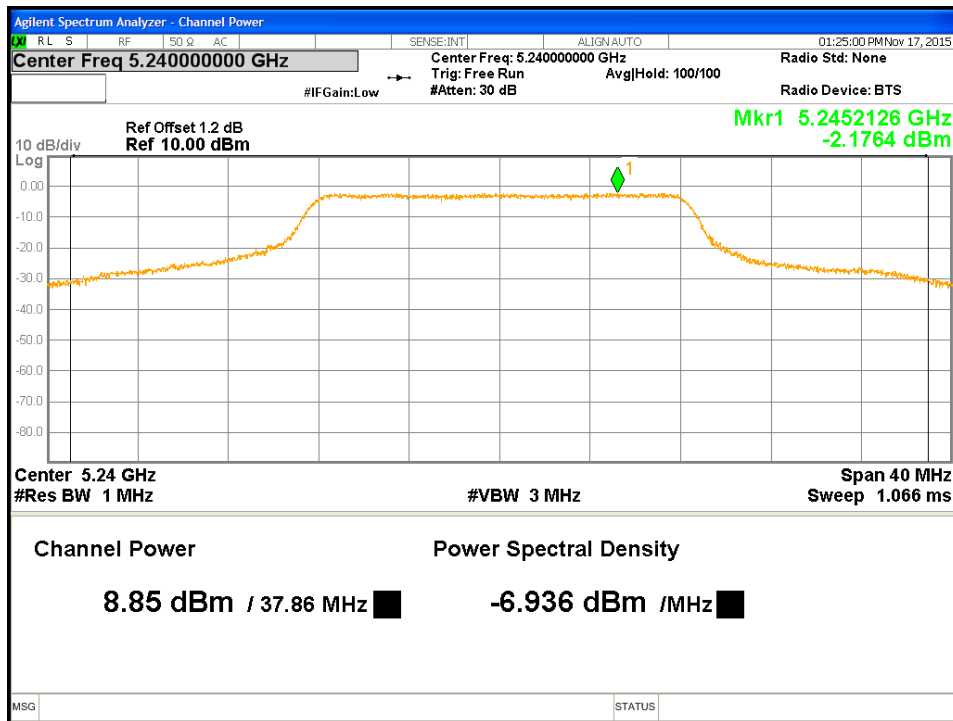

Figure 3: Maximum Conducted Output Power-5240 MHz-11a-6Mbps

4.2 Occupied Bandwidth

The occupied bandwidth is measured at an amplitude level reduced from the reference level by a specified ratio. The reference level is the level of the highest amplitude signal observed from the transmitter at the fundamental frequency.

The 99% bandwidth is the bandwidth in which 99% of the transmitted power occupied.

The 26 dB bandwidth is defined the bandwidth of 26 dB from highest transmitted level of the fundamental frequency.

There is no power limitation referencing to the 26 dB bandwidth under CFR47 Part 15.407 (a)(1)(iv).
The 26 dB bandwidth recorded for information only.

4.2.1 Test Method

The conducted method was used to measure the occupied bandwidth. The measurement was performed with modulation per CFR47 15.407(a) 2015 and RSS Gen Sect. 6.6:2014. The preliminary investigation was performed to find the narrowest 26 dB bandwidth for each operational mode at different data rates. This worst finding was performed on 3 channels in each operating frequency range; 5150 MHz to 5250 MHz on the sample. The results indicated below.

Test Setup:

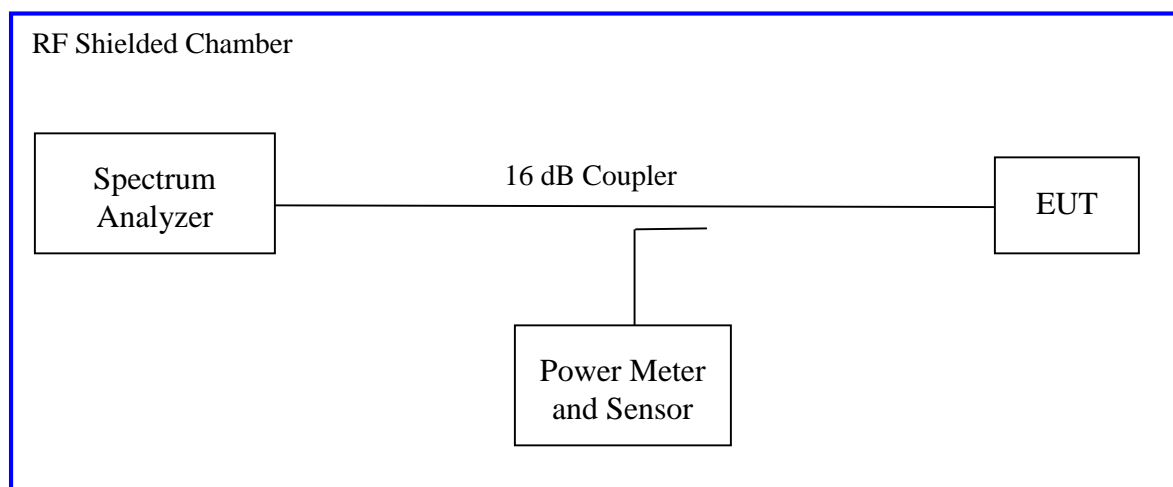

Method in Sect. C and D of KDB 789033 D02 General UNII Test Procedure New Rules v01, “Guidelines for Compliance Testing of Unlicensed National Information Infrastructure (U-NII) Devices”, used to perform measurements.

4.2.2 Results

These occupied bandwidth measurements were taken for references only.

Table 3: Occupied Bandwidth – Test Results

Test Conditions: Conducted Measurement		Test Date: November 17, 2015
Antenna Type: Integrated		Power Setting: SPW 0
Antenna Gain: +3.5 dBi		Signal State: Modulated
Ambient Temp.: 23 °C		Relative Humidity: 34%
Bandwidth for 802.11a		
Frequency (MHz)	99% Bandwidth (MHz)	26dB Bandwidth (MHz)
5180	18.756	34.390
5200	18.807	34.520
5240	19.835	36.830
Note: 1. The bandwidth was measured at 802.11a, 6Mbps. 2. The 18.756 MHz is used toward the maximum output power limit calculation per RSS247 Sect. 6.2.1.1.		

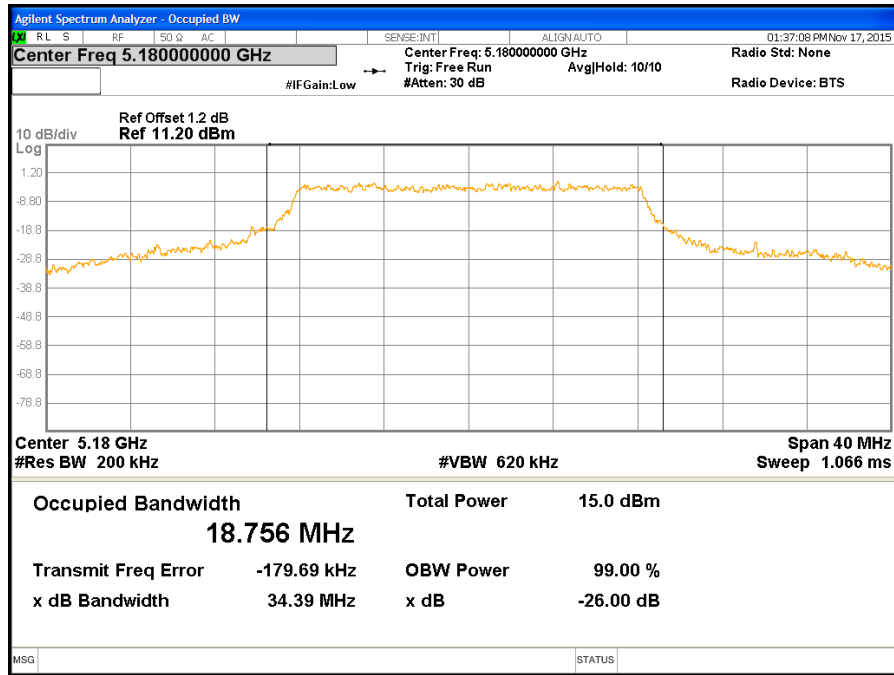

Figure 4: Occupied Bandwidth-5180 MHz-11a-6Mbps

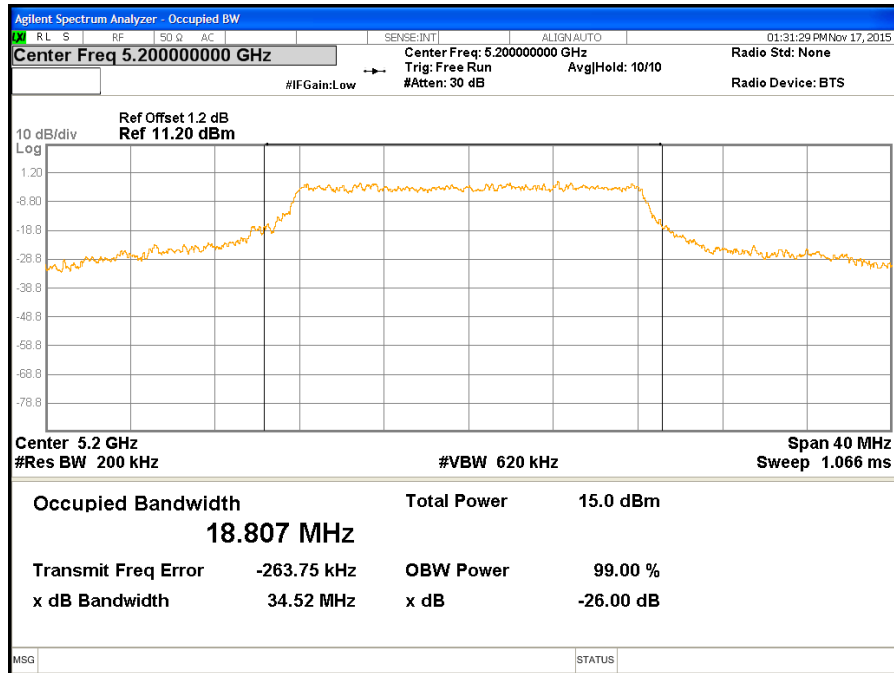

Figure 5: Occupied Bandwidth-5200 MHz-11a-6Mbps

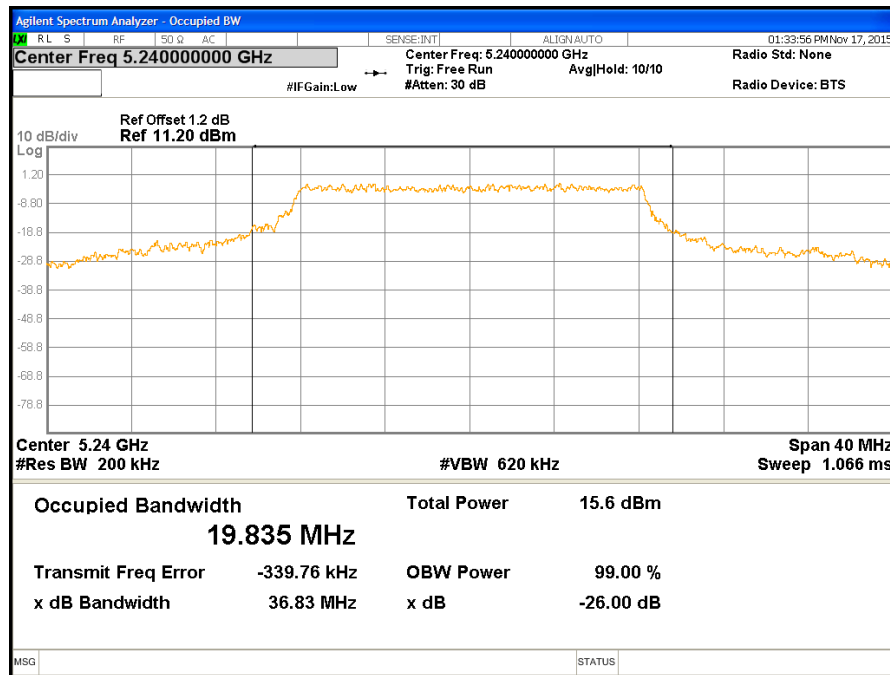

Figure 6: Occupied Bandwidth-5240 MHz-11a-6Mbps

4.3 Peak Power Spectral Density

According to the CFR47 Part 15.407 (a) (1)(iv) the spectral power density output of the antenna port shall be less than 11 dBm in any 1 MHz band during any time interval of continuous transmission. RSS-247 Sect. 6.2.1.1 has the e.i.r.p limit of 10.0 dBm in any 1 MHz.

4.3.1 Test Method

The conducted method was used to measure the peak power spectral density per ANSI C63.10-2013 Section 12.3.2.2. The measurement was performed with modulation per CFR47 Part 15.407 (a) and RSS-247 (6.2.1.1). The pre-evaluation was performed to find the worst modes. The worst findings were conducted on 3 channels in frequency range of 5150 MHz to 5250 MHz for the test sample. The result indicated below.

Test Setup:

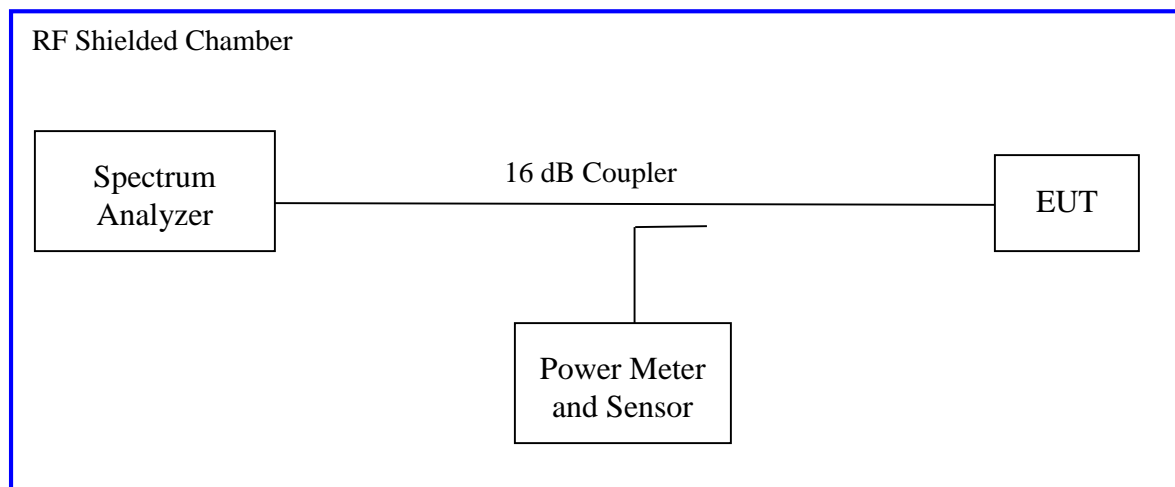

KDB 789033 D02 General UNII Test Procedure New Rules v01, “Guidelines for Compliance Testing of Unlicensed National Information Infrastructure (U-NII) Devices” Section F applies for measuring maximum power spectral density with duty cycle less than 100%. There was no duty cycle correction factor applied.

4.3.2 Results

As originally tested, the EUT was found to be compliant to the requirements of the test standard(s).

Table 4: Maximum Power Spectral Density – Test Results

Test Conditions: Conducted Measurement		Test Date: November 17, 2015	
Antenna Type: Integrated		Power Setting: SPW 0	
Antenna Gain: +3.5 dBi		Signal State: Modulated	
Ambient Temp.: 23 °C		Relative Humidity: 34%	
802.11a Mode			
Freq. [MHz]	Limit in E.I.R.P. [dBm]	Max. Power Spectral Density [dBm]	Margin [dB]
5180	6.500	-3.986	-10.486
5200	6.500	-4.179	-10.679
5240	6.500	-3.423	-9.923
<p>Note: 1. The maximum power spectral density was observed at 802.11a 6 Mbps at 100% duty cycle. 2. The conducted maximum spectral density limit with 6dBi antenna for CFR47 Part 15.407 (a)(1)(iv) is 11 dBm, and it is 10 dBm for RSS 247 Sect. 6.2.1.1. The 10 dBm limit is used to show compliance to both standards.</p>			

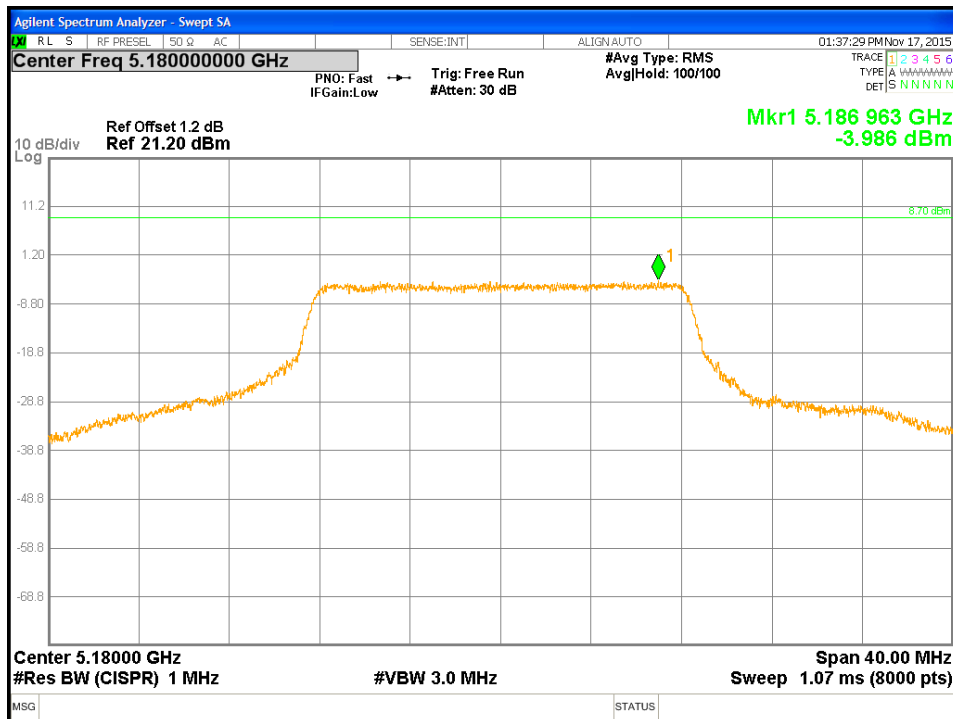

Figure 7: Maximum Power Spectral Density-5180 MHz-11a-6Mbps

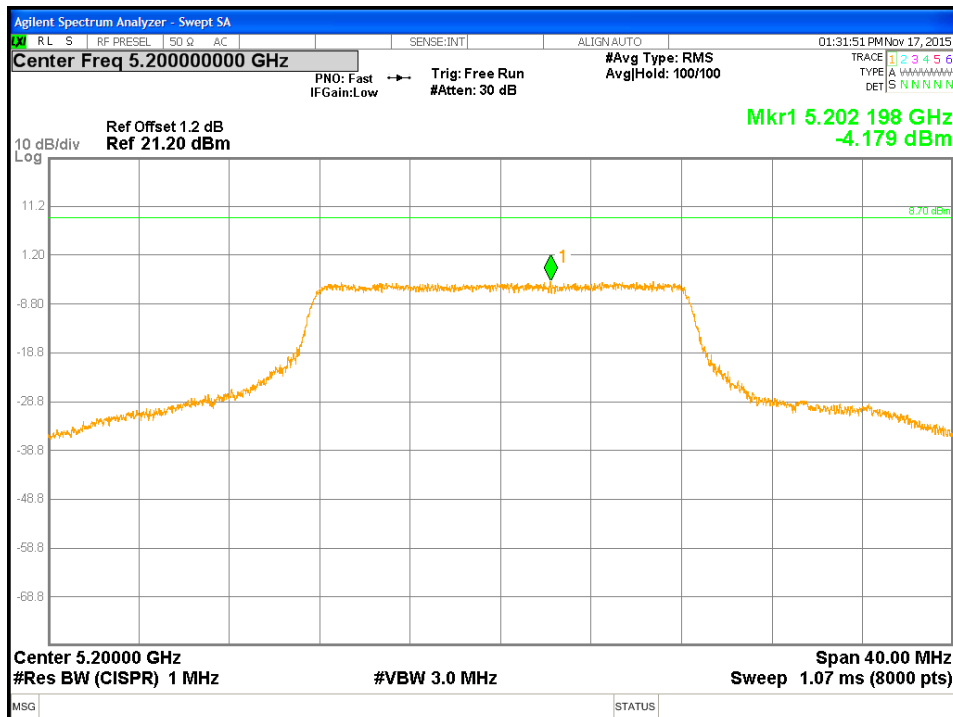

Figure 8: Maximum Power Spectral Density-5200 MHz-11a-6Mbps

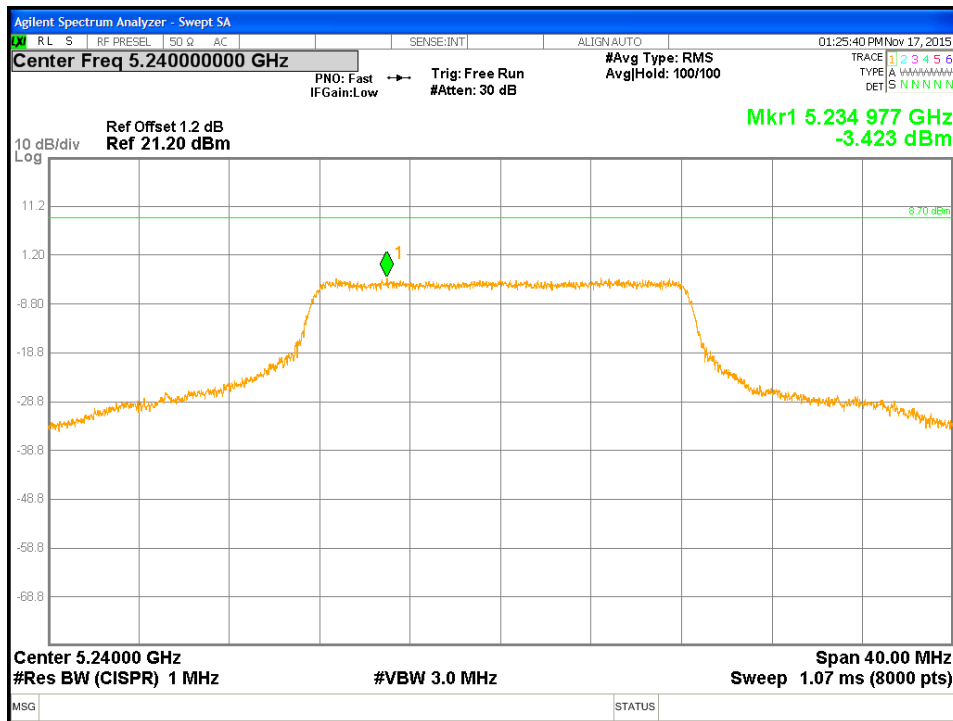

Figure 9: Maximum Power Spectral Density-5240 MHz-11a-6Mbps

4.4 Undesirable Emission Limits

CFR47 15.407 (b) and RSS 247 Sect.6: The maximum emissions outside of the frequency bands of operation shall be attenuated in accordance with the following limits:

For transmitters operating in the 5.15-5.25 GHz band: All emissions outside of the 5.15-5.35 GHz band shall not exceed an e.i.r.p. of -27 dBm/MHz.

4.4.1 Test Method

The conducted method was used to measure the undesirable emission requirement. The measurement was performed with modulation. This test was conducted on 3 channels of Sample in each mode on Sample. The worst sample result indicated below.

Test Setup:

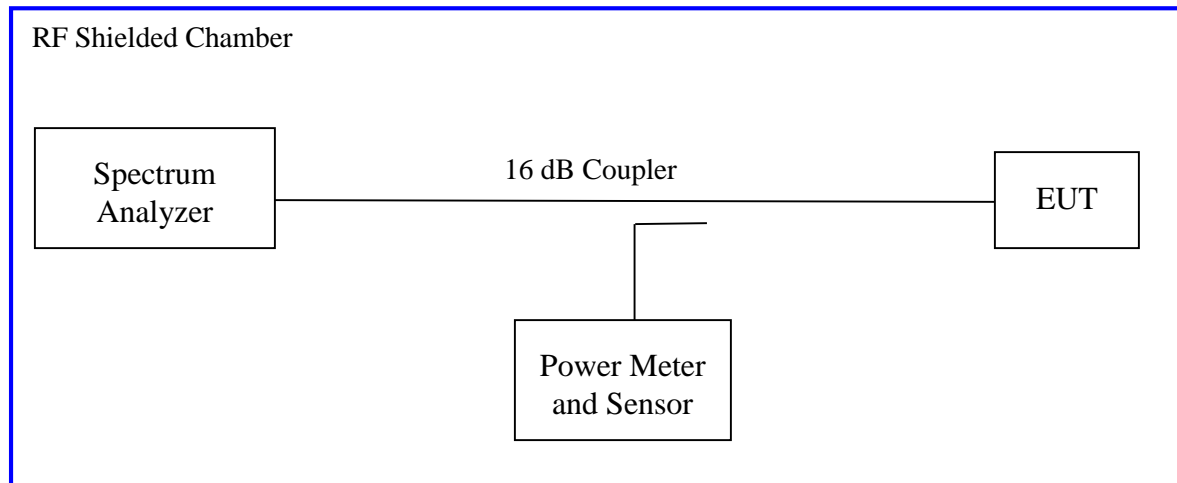

Measurement Procedure AVG2 of KDB 662911

4.4.2 Results

As originally tested, the EUT was found to be compliant to the requirements of the test standard(s).

Table 5: Emissions at the Band-Edge – Test Results

Test Conditions: Conducted Measurement			Test Date: November 17, 2015		
Antenna Type: Integrated			Power Setting: SPW 0		
Antenna Gain: +3.5 dBi			Signal State: Modulated		
Ambient Temp.: 23 °C			Relative Humidity: 34%		
Non-Restricted Frequency Band Emission					
Operating Channel (MHz)	Freq. (MHz)	Measured (dBm)	Limit (dBm)	Plots	Comments
5180	38453.1	-33.57	-27.00	Fig. 10, 11	Pass
5200	39161.9	-32.94	-27.00	Fig. 12, 13	Pass
5240	10482.5	-32.27	-27.00	Fig. 14, 15	Pass
5240	5249.58	N/A	N/A	Fig. 16	Pass 99% OBW In-band-edge. No DFS test needed.
<p>Note: 1. All out of band emissions are lower than the 27dB level. 2. The maximum out of band emission on each individual output is at least 27 dB below the maximum in-band PSD on that output per KDB 662911.</p>					

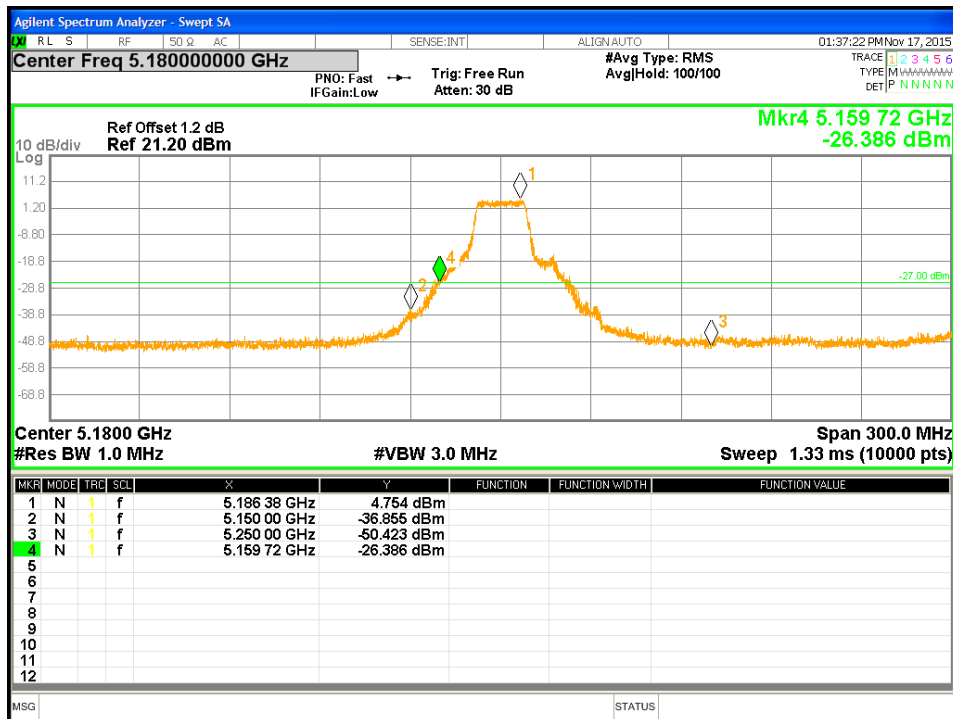

Figure 10: Measured Bandedge for 802.11a-6Mbps at 5180 MHz

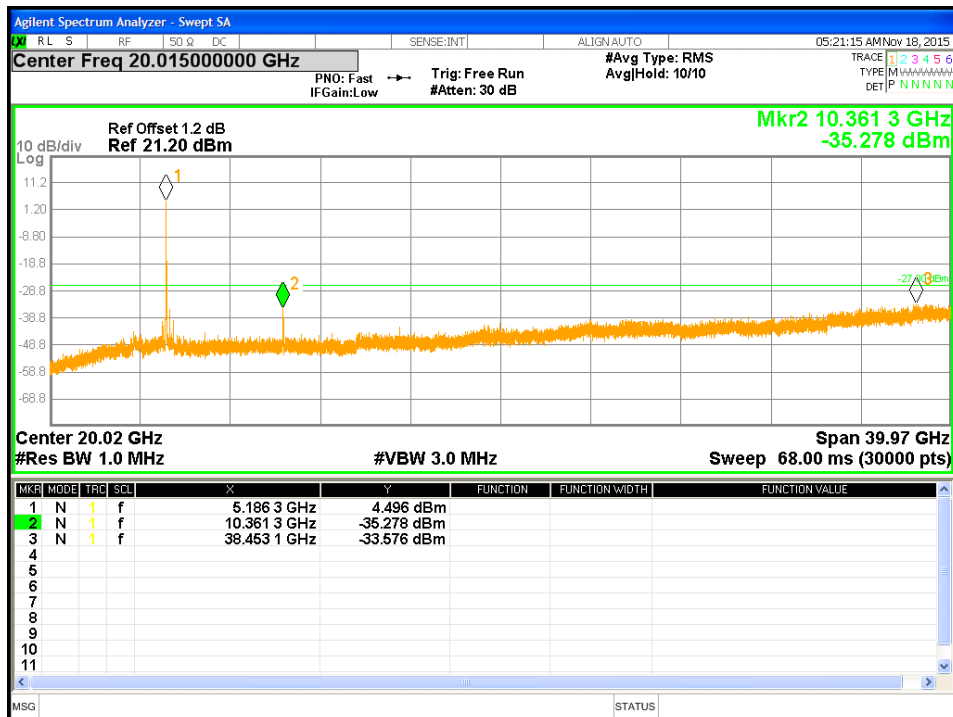

Figure 11: Undesirable Emission for 802.11a-6Mbps at 5180 MHz

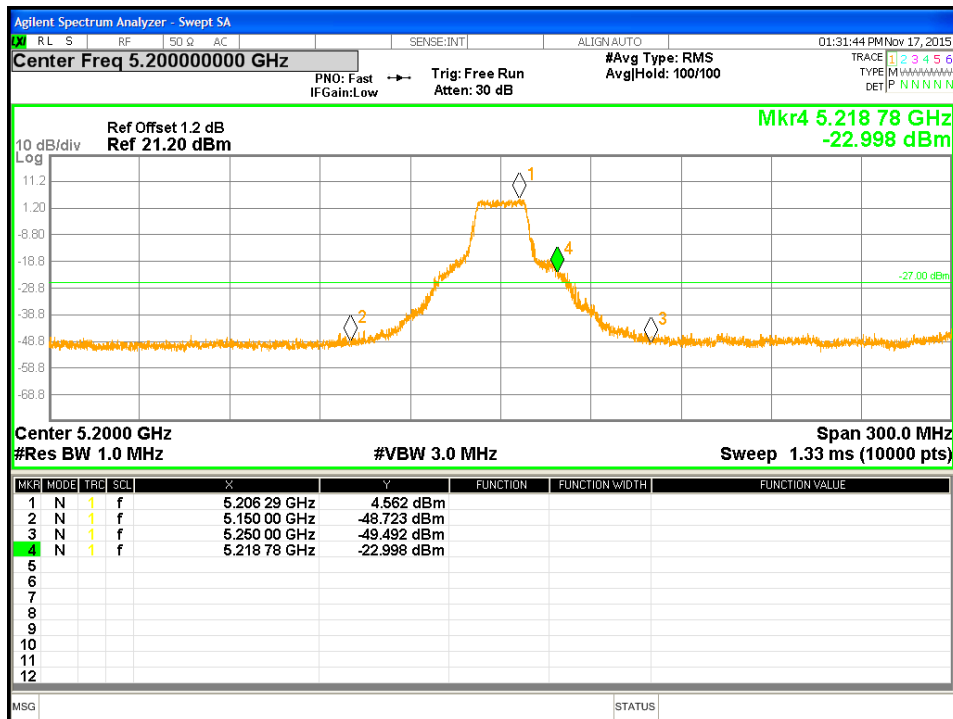

Figure 12: Measured Bandedge for 802.11a-6Mbps at 5200 MHz

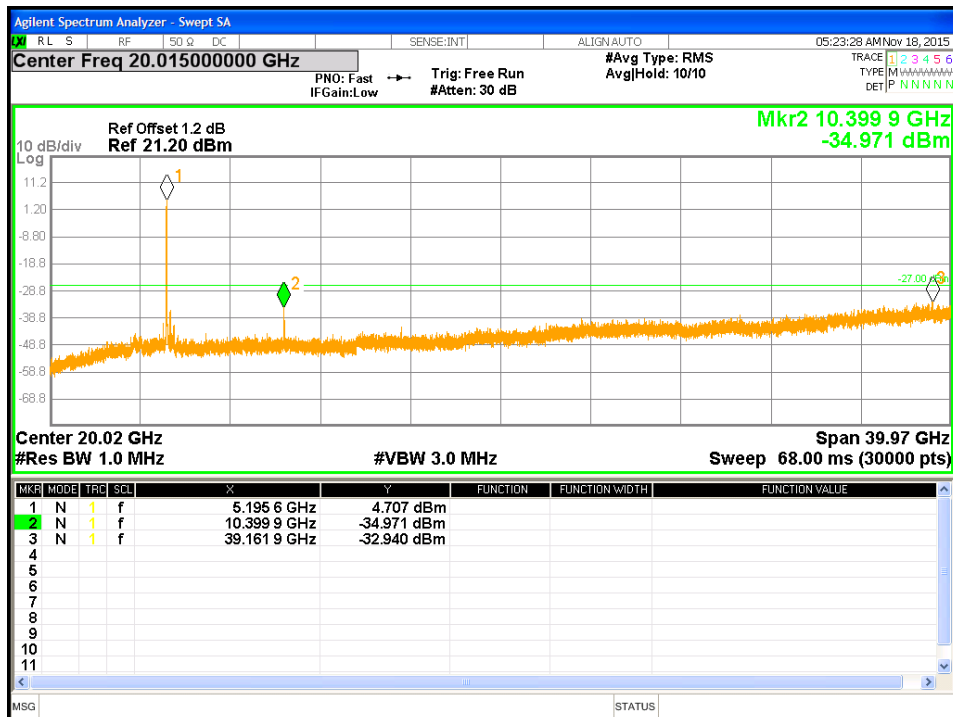

Figure 13: Undesirable Emission for 802.11a-6Mbps at 5200 MHz

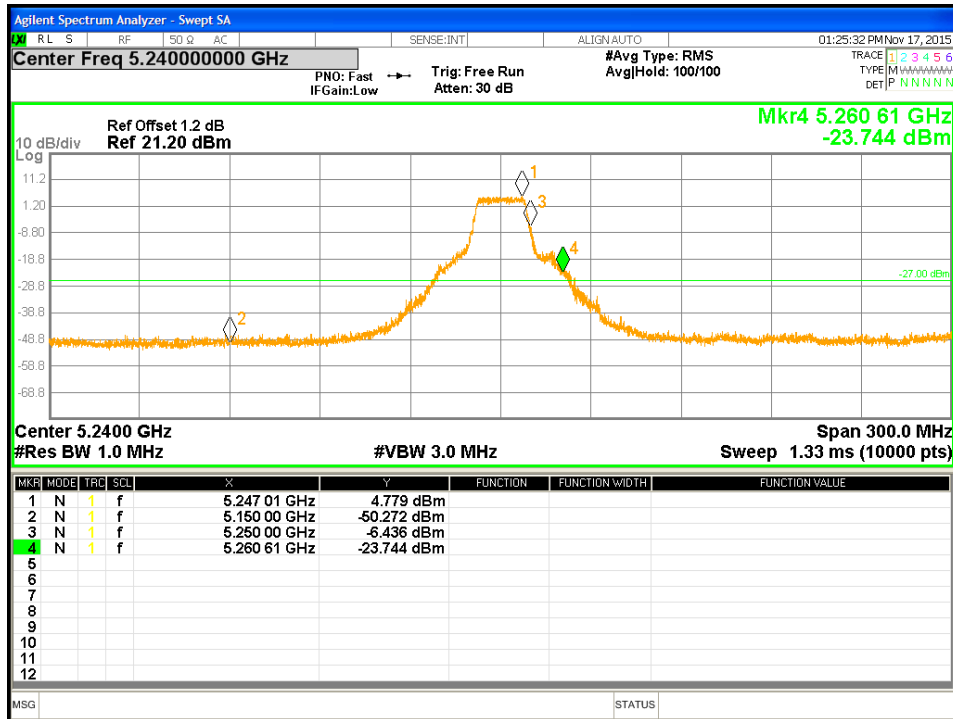

Figure 14: Measured Bandedge for 802.11a-6Mbps at 5240 MHz

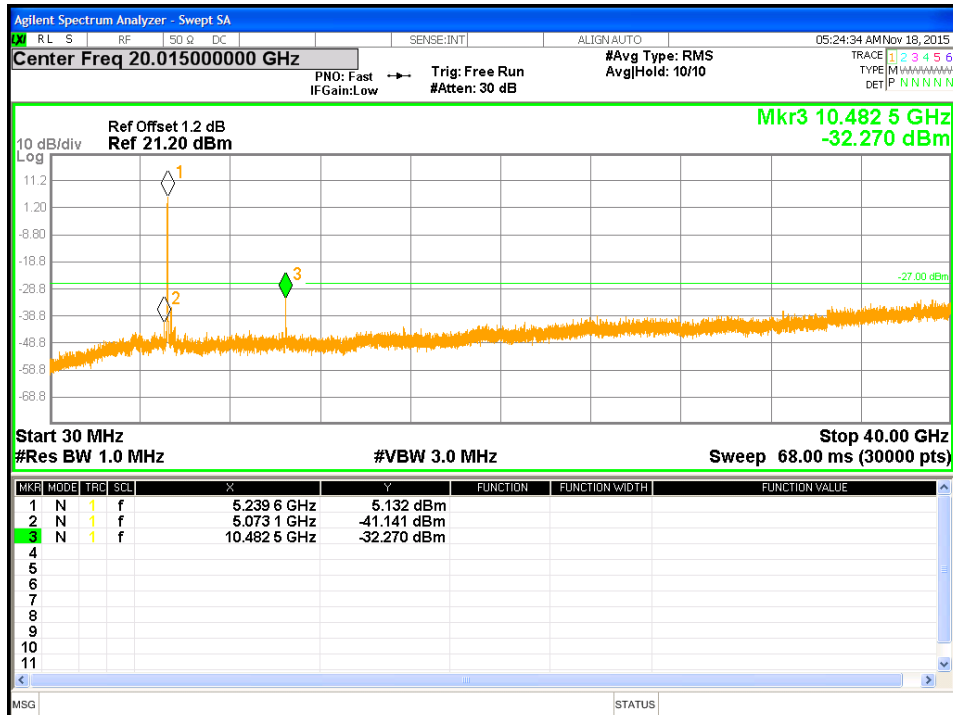

Figure 15: Undesirable Emission for 802.11a-6Mbps at 5240 MHz

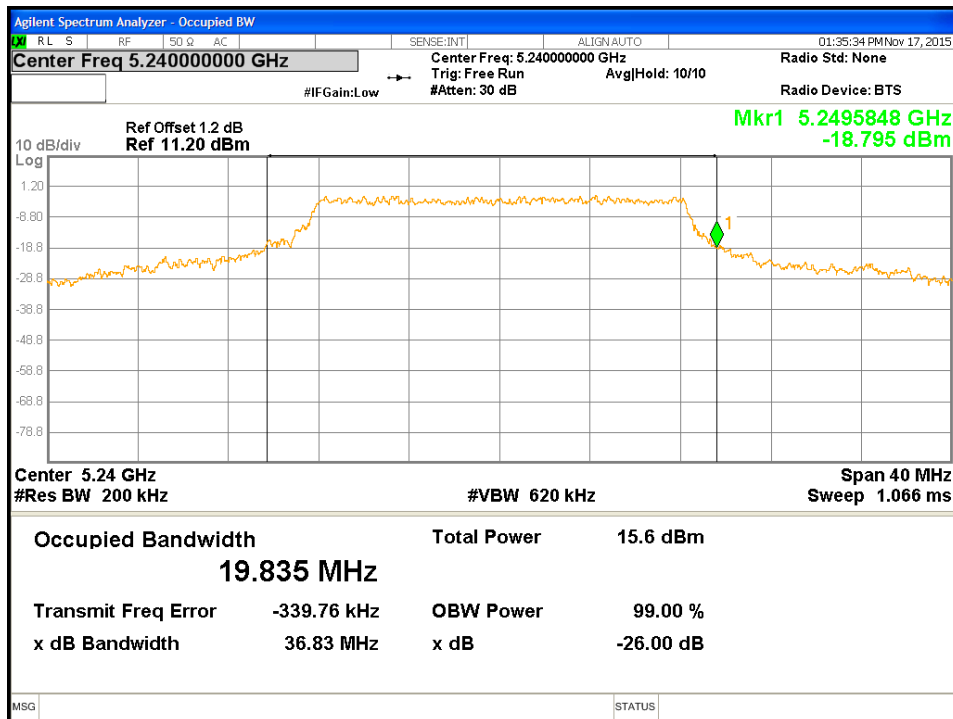

Figure 16: Measured In-Band edge for 802.11a-6Mbps at 5240 MHz

4.5 Transmitter Spurious Emissions

Transmitter spurious emissions are emissions outside the frequency range of the equipment when the equipment is in transmit mode; per requirement of CFR47 15.205, 15.209, 15.407(b), RSS-247 Sect. 6

4.5.1 Test Methodology

4.5.1.1 Preliminary Test

A test program that controls instrumentation and data logging was used to automate the preliminary RF emission test procedure. The frequency range of interest was divided into sub-ranges to yield a frequency resolution of approximately 120 kHz and provide a reading at each frequency for no more than 12° of turntable rotation. For each frequency sub-range the turntable was rotated 360° while peak emission data was recorded and plotted over the frequency range of interest in horizontal and vertical antenna polarization's.

Preliminary emission profile testing was performed inside the anechoic chamber. The EUT was placed on a 1.0m x 1.5m non-conductive table 80cm (<1 GHz) and 150cm (>1 GHz) above the floor. The EUT was positioned as shown in the setup photographs. The receiving antenna was placed at a distance of 3m at a fixed height of 1m. Measurement equipment was located outside of the chamber. A video camera was placed inside the chamber to view the EUT.

Pre-scans were performed to determine the worst axis, and data rate.

4.5.1.2 Final Test

For each frequency measured, the peak emission was maximized by manipulating the receiving antenna from 1 to 4 meters above the ground plane and placing it at the position that produced the maximum signal strength reading. The turntable was then rotated through 360° while observing the peak signal and placing the EUT at the position that produced maximum radiation. The six highest emissions relative to the limit were measured unless such emissions were more than 20 dB below the limit. If less than six emissions are within 20 dB of the limit, than the noise level of the receiver is measured at frequencies where emissions are expected. Multiples of all oscillator and microprocessor frequencies were also checked.

Final testing was performed on an NSA compliant test site. The EUT was placed on a 1.0m x 1.5m non-conductive table 80cm (<1 GHz) and 150cm (>1 GHz) above the ground plane. The placement of EUT and cables were the same as for preliminary testing and is shown in the setup photographs.

The final scans performed on the worst axis, Y-Axis, for three operating channels;

6 Mbps for 802.11a Mode: 5180 MHz, 5200 MHz, 5240 MHz

4.5.1.3 Deviations

None.

Test Setup:

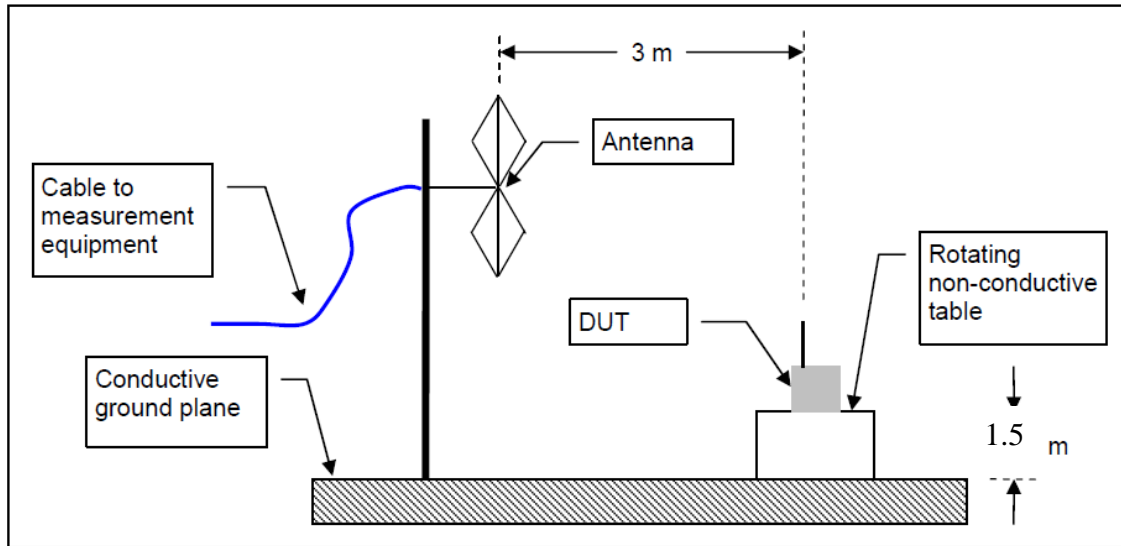

4.5.2 Transmitter Spurious Emission Limit

The spurious emissions of the transmitter shall not exceed the values in CFR47 Part 15.205, 15.209: 2015 and RSS-247 Sect. 6: 2015.

Frequency (MHz)	Field strength (microvolts/meter)	Measurement distance (meters)
0.009-0.490.....	2400/F (kHz)	300
0.490-1.705.....	24000/F (kHz)	30
1.705-30.0.....	30	30
30-88.....	100 **	3
88-216.....	150 **	3
216-960.....	200 **	3
Above 960.....	500	3

According to CFR47 15.407 (b), all harmonics and spurious emissions which are outside the 5150 MHz - 5350 MHz shall not exceed -27 dBm/MHz. This is equivalent to 68.2 dBuV/m at 3 meter distance.

4.5.3 Test Results

The final measurement data was taken under the worst case operating modes, configurations, and/or cable positions. It also reflects the results including any modifications and/or special accessories listed in Sections 1.4 and test plan.

This section also addressed the simultaneous transmission of both radio; Bluetooth and 802.11a.

As originally tested, the EUT was found to be compliant to the requirements of the test standard(s).

Table 6: Transmit Spurious Emission at Band-Edge Requirements

Test Conditions: Radiated Measurement					Test Date: October 21, 2015			
Antenna Type: Integrated					Power Setting: SPW 0			
Antenna Gain: +3.5 dBi					Signal State: Modulated			
Ambient Temp.: 23 °C					Relative Humidity: 34%			
Band-Edge Results								
Freq. (MHz)	Level (dBuV/m)	Polarit y (H/V)	Limit (dBuV/m)	Margin (dB)	Det.	Table Deg.	Tower (cm)	Note
5120.74	64.78	V	74.00	-9.22	Pk	317.75	218.17	Fig. 17: 5180 MHz-11a-6Mbps
5150.00	50.26	V	54.00	-3.74	Avg	317.75	218.17	Fig. 18: 5180 MHz-11a-6Mbps
5149.20	66.00	H	74.00	-8.00	Pk	12.25	104.86	Fig. 19: 5180 MHz-11a-6Mbps
5150.00	51.75	H	54.00	-2.25	Avg	12.25	104.86	Fig. 20: 5180 MHz-11a-6Mbps
5403.51	68.89	H	74.00	-5.11	Pk	1.00	100.00	Fig. 21: 5240 MHz-11a-6Mbps
5404.71	53.84	H	54.00	-0.16	Avg	1.00	100.00	Fig. 22: 5240 MHz-11a-6Mbps
5393.29	65.87	V	74.00	-8.13	Pk	280.00	208.52	Fig. 23: 5240 MHz-11a-6Mbps
5396.29	52.05	V	54.00	-1.95	Avg	280.00	208.52	Fig. 24: 5240 MHz-11a-6Mbps
<p>Note:</p> <ol style="list-style-type: none"> 1. All the band-edge measurements met the restricted band requirements of CFR47 15.205. 2. It is also complied with the -27 dBm/MHz (68.2dBuV/m at 3m) requirements as stated in CFR47 15.407 (b) (1). 3. It is also confirm that the 20dBr point of the highest channel in each mode is within the 5150-5250 MHz range. 								

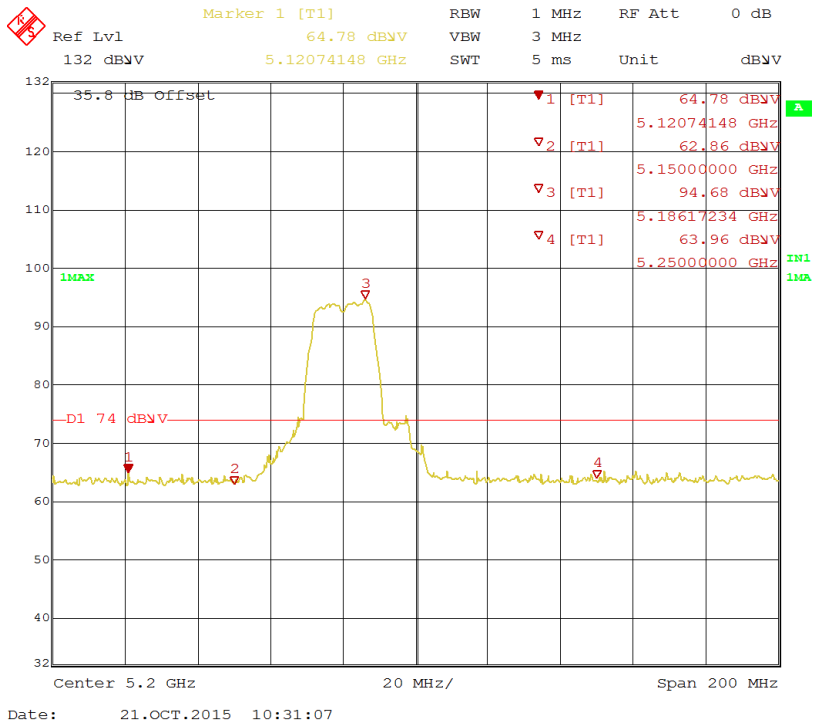

Figure 17: Radiated Emission 5150 MHz Edge for 11a 5180 MHz – Vert. (Pk)

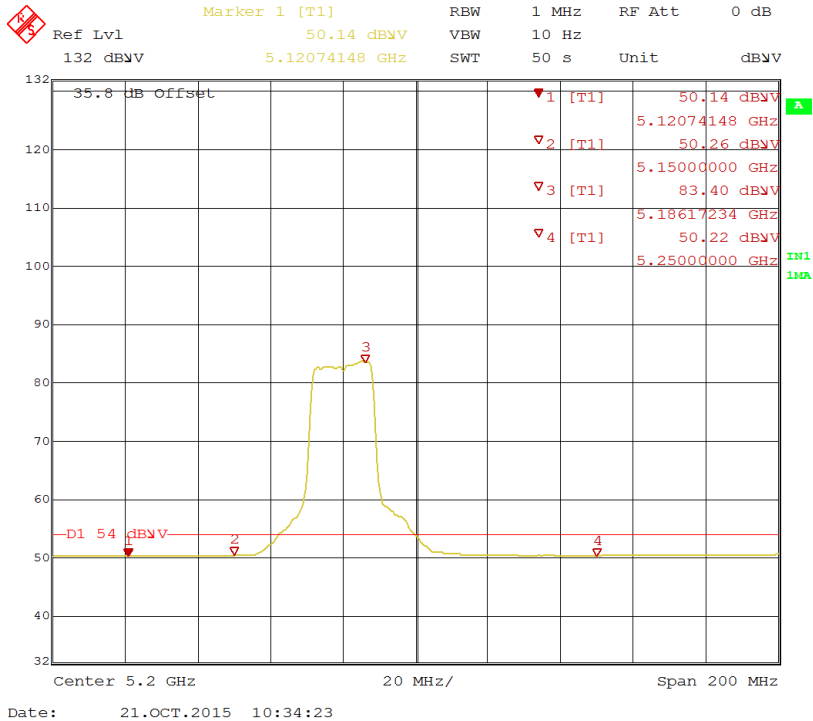

Figure 18: Radiated Emission 5150 MHz Edge for 11a 5180 MHz – Vert. (Avg)

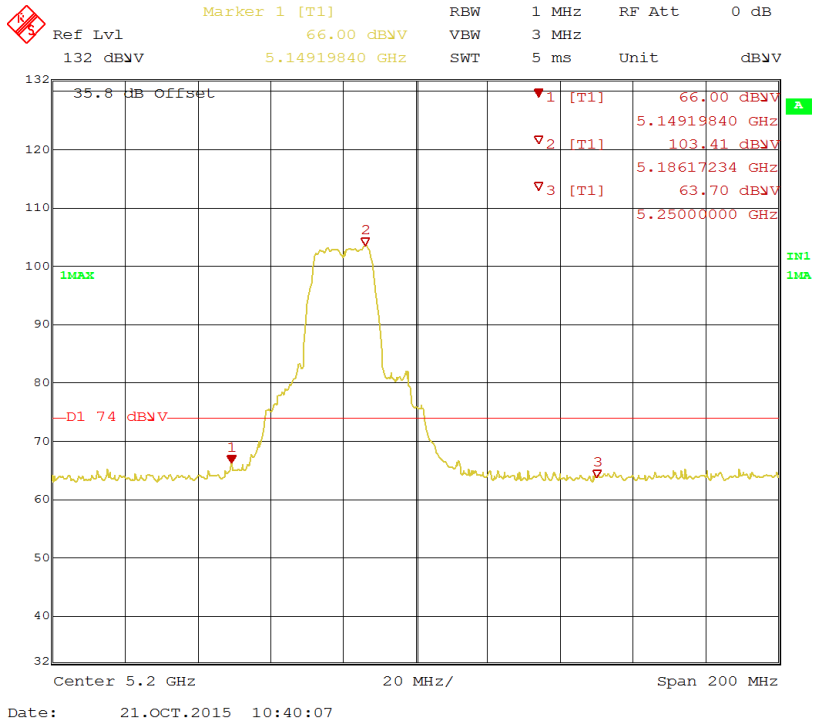

Figure 19: Radiated Emission 5150 MHz Edge for 11a 5180 MHz – Horz. (Pk)

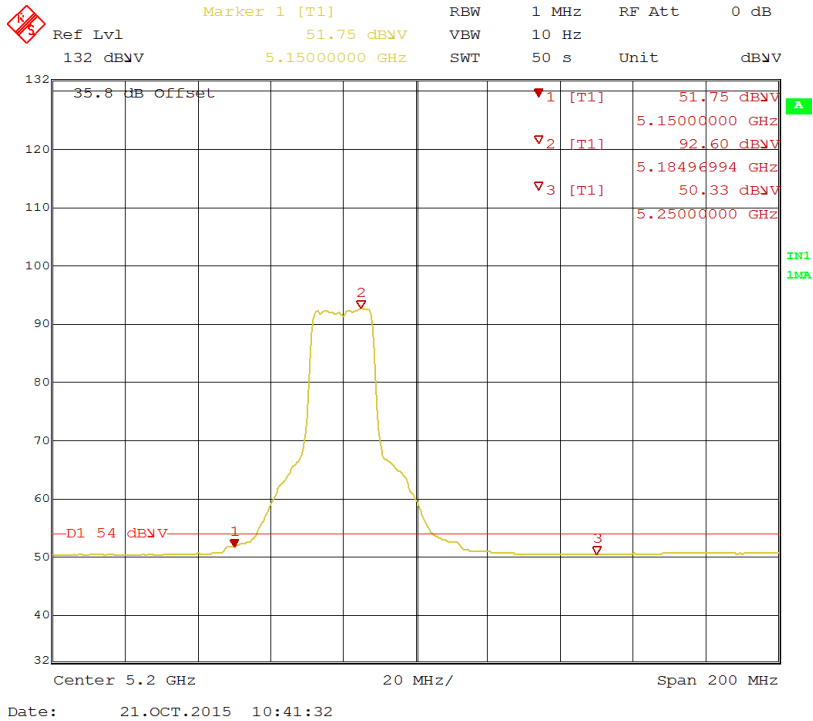

Figure 20: Radiated Emission 5150 MHz Edge for 11a 5180 MHz – Horz. (Avg)

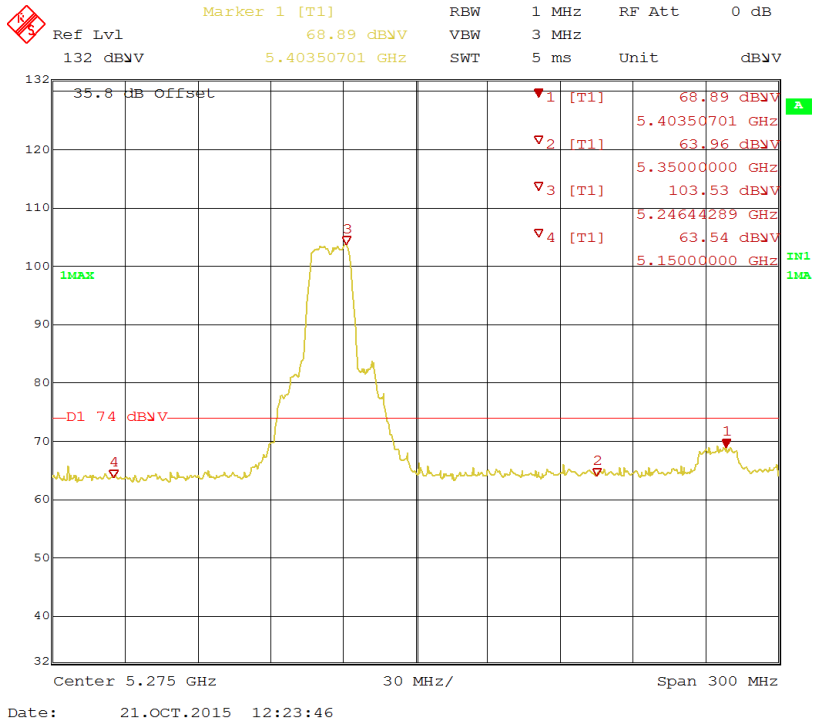

Figure 21: Radiated Emission 5350 MHz Edge for 11a 5240 MHz – Horz. (Pk)

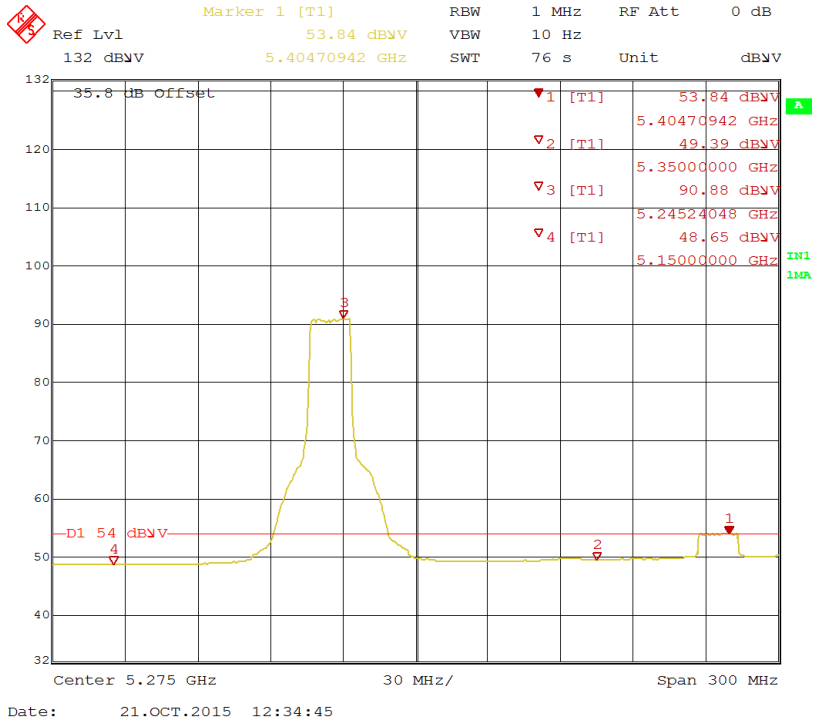

Figure 22: Radiated Emission 5350 MHz Edge for 11a 5240 MHz – Horz. (Avg)

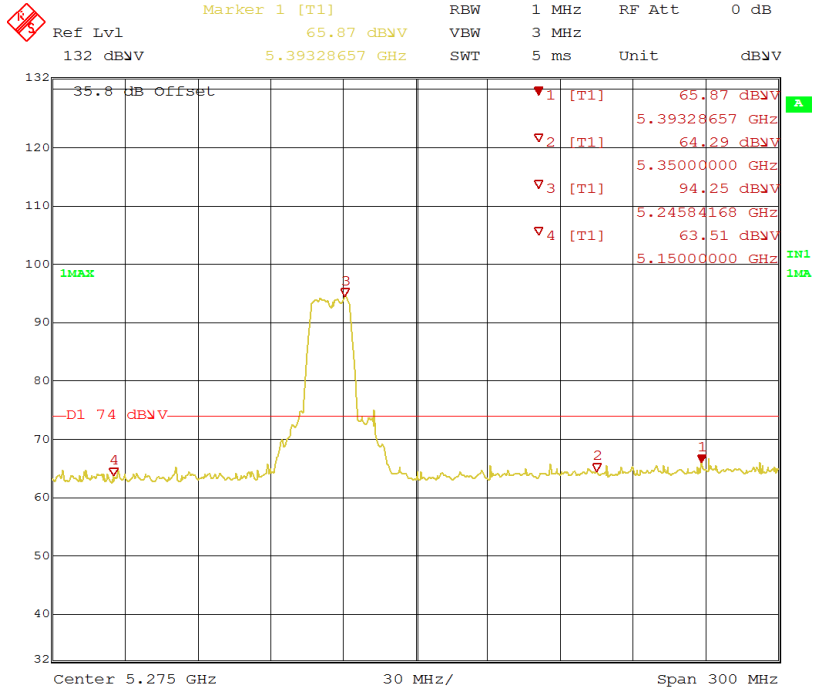

Figure 23: Radiated Emission 5350 MHz Edge for 11a 5240 MHz – Vert. (Pk)

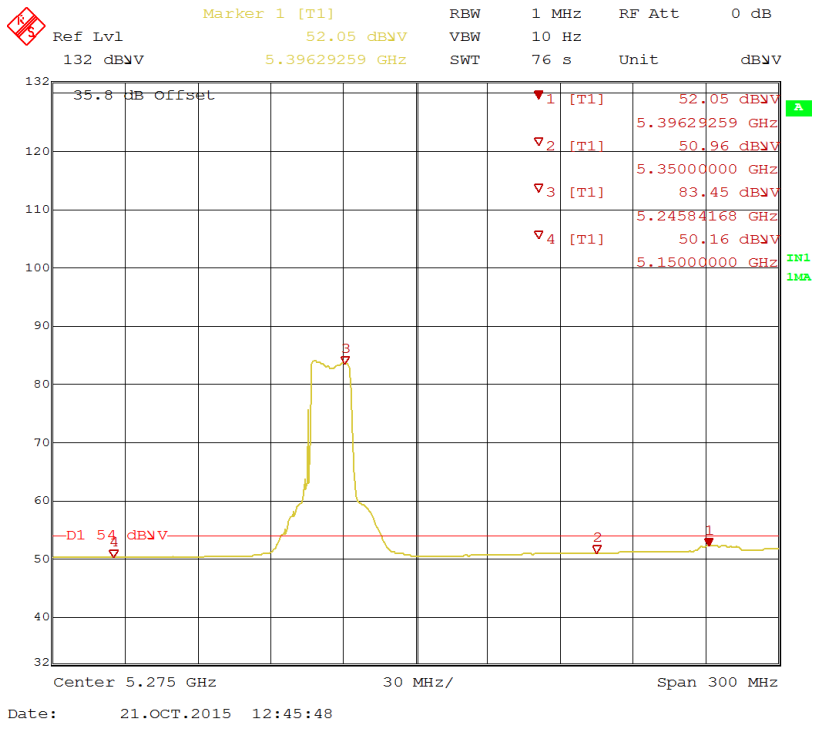
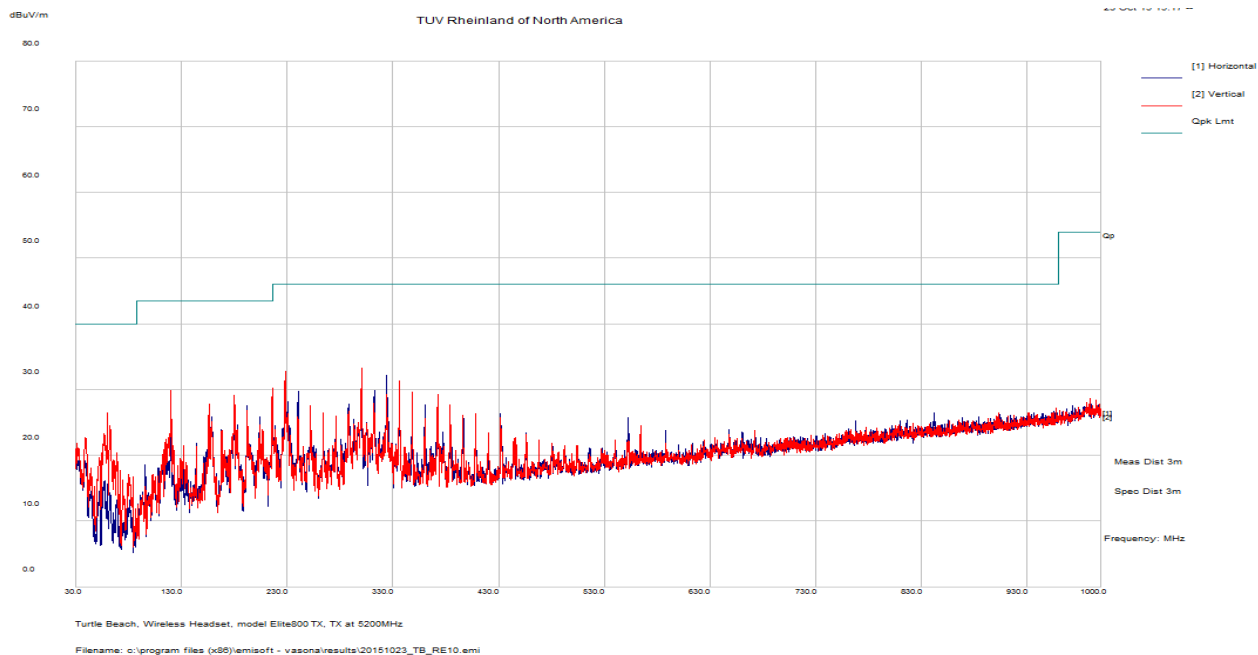

Figure 24: Radiated Emission 5350 MHz Edge for 11a 5240 MHz – Vert. (Avg)

SOP 1 Radiated Emissions				Tracking # 31563518.001 Page 1 of 7			
EUT Name	Wireless Audio Transmitter			Date	October 23, 2015		
EUT Model	Elite 800 TX			Temp / Hum in	23° C / 35%rh		
EUT Serial	Q2391F3900063			Temp / Hum out	N/A		
EUT Config.	802.11a on Y-Axis			Line AC / Freq	5.0 VDC		
Standard	CFR47 Part 15 Subpart C, RSS-247, RSS-GEN			RBW / VBW	120 kHz/ 300 kHz		
Dist/Ant Used	3m / JB3			Performed by	Kerwinn Corpuz		

30 MHz – 1 GHz Transmit at 5200 MHz

Frequency	Raw	Cable Loss	AF	Level	Detector	Polarity	Height	Azimuth	Limit	Margin
MHz	dBuV/m	dB	dB	dBuV/m		H/V	cm	deg	dBuV/m	dB
59.83	48.23	2.85	-24.62	26.47	Pk	V	300	0	40.00	-13.53
119.97	44.73	3.24	-18.06	29.91	Pk	V	300	0	43.50	-13.59
216.00	47.28	3.69	-20.77	30.20	Pk	V	100	0	43.50	-13.30
228.12	49.46	3.76	-20.44	32.77	Pk	V	100	0	46.00	-13.23
300.15	47.37	4.04	-18.12	33.29	Pk	V	100	0	46.00	-12.71
324.40	45.51	4.12	-17.45	32.18	Pk	H	100	0	46.00	-13.82



Spec Margin = Level - Limit, Level = Raw + Cbl + CF ± Uncertainty
 CF = Amp Gain + ANT Factor
 Combined Standard Uncertainty $u_c(y) = \pm 4.52$ dB Expanded Uncertainty $U = k u_c(y)$ $k = 2$ for 95% confidence
Note: The worst case was observed at mid channel of 802.11a.
 All other emissions passed Class B limit.

SOP 1 Radiated Emissions				Tracking # 31563518.001 Page 2 of 7			
EUT Name	Wireless Audio Transmitter			Date	October 20, 2015		
EUT Model	Elite 800 TX			Temp / Hum in	23° C / 37%rh		
EUT Serial	Q2391F3900063			Temp / Hum out	N/A		
EUT Config.	802.11a on Y-Axis			Line AC / Freq	5.0 VDC		
Standard	CFR47 Part 15 Subpart C, RSS-247, RSS-GEN			RBW / VBW	1 MHz/ 3 MHz		
Dist/Ant Used	3m / DRH-118 & 1m / AHA-840			Performed by	Kerwinn Corpuz		

1 – 18 GHz Transmit at 5180 MHz

Frequency	Raw	Cable Loss	AF	Level	Detector	Polarity	Height	Azimuth	Limit	Margin
MHz	dBuV/m	dB	dB	dBuV/m		H/V	cm	deg	dBuV/m	dB
6927.39	38.92	3.18	-11.70	30.40	Avg	H	115	310	54.00	-23.60
17982.79	38.11	5.03	2.06	45.20	Avg	H	183	194	54.00	-8.80
14644.36	40.32	4.41	-6.68	38.05	Avg	V	180	14	54.00	-15.95

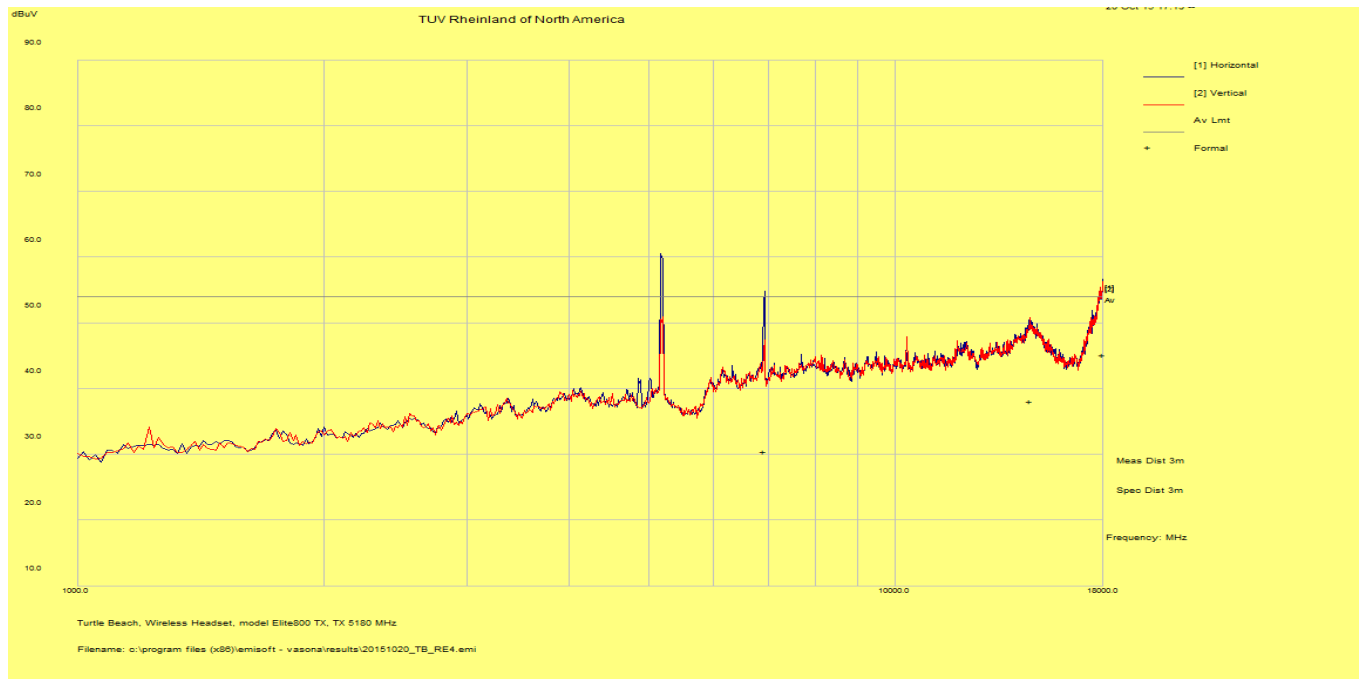

Spec Margin = Level - Limit, Level = Raw + Cbl + CF ± Uncertainty

CF = Amp Gain + ANT Factor

Combined Standard Uncertainty $u_c(y) = \pm 4.52$ dB Expanded Uncertainty $U = k u_c(y)$ $k = 2$ for 95% confidence

Note: All emissions passed the spurious emission limit. No significant emission was observed from 1GHz to 40GHz.

SOP 1 Radiated Emissions				Tracking # 31563518.001 Page 3 of 7			
EUT Name	Wireless Audio Transmitter			Date	October 23, 2015		
EUT Model	Elite 800 TX			Temp / Hum in	23° C / 35%rh		
EUT Serial	Q2391F3900063			Temp / Hum out	N/A		
EUT Config.	802.11a on Y-Axis			Line AC / Freq	5.0 VDC		
Standard	CFR47 Part 15 Subpart C, RSS-247, RSS-GEN			RBW / VBW	1 MHz/ 3 MHz		
Dist/Ant Used	3m / DRH-118 & 1m / AHA-840			Performed by	Kerwinn Corpuz		

18 – 40 GHz Transmit at 5180 MHz

Frequency	Raw	Cable Loss	AF	Level	Detector	Polarity	Height	Azimuth	Limit	Margin
MHz	dBuV/m	dB	dB	dBuV/m		H/V	cm	deg	dBuV/m	dB
38133.74	45.69	7.52	-12.02	41.19	Avg	H	160	-2	54.00	-12.81
39916.17	47.20	7.63	-13.52	41.31	Avg	H	169	152	54.00	-12.69
34157.21	43.34	6.97	-12.43	37.88	Avg	V	166	286	54.00	-16.12

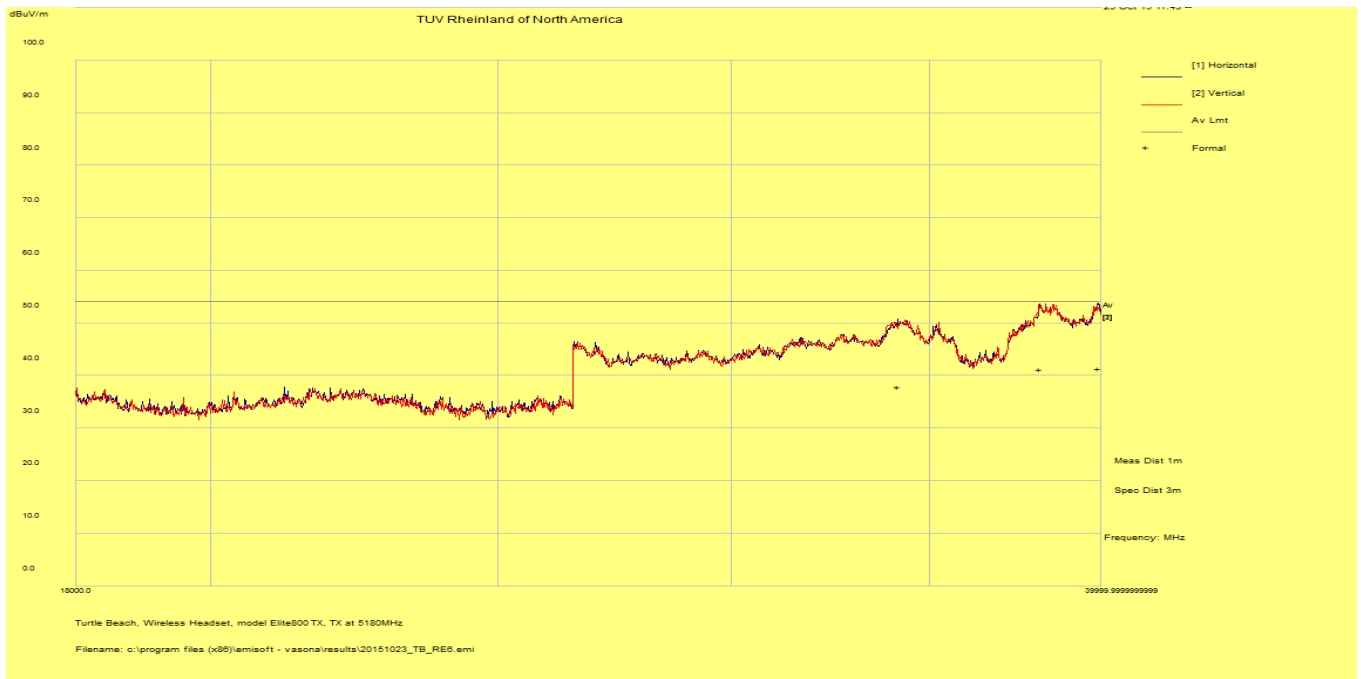

Spec Margin = Level - Limit, Level = Raw+ Cbl+ CF ± Uncertainty

CF= Amp Gain + ANT Factor

Combined Standard Uncertainty $u_c(y) = \pm 4.52$ dB Expanded Uncertainty $U = k u_c(y)$ $k = 2$ for 95% confidence

Note: All emissions passed the spurious emission limit. No significant emission was observed from 1GHz to 40GHz.

SOP 1 Radiated Emissions				Tracking # 31563518.001 Page 4 of 7			
EUT Name	Wireless Audio Transmitter			Date	October 20, 2015		
EUT Model	Elite 800 TX			Temp / Hum in	23° C / 37%rh		
EUT Serial	Q2391F3900063			Temp / Hum out	N/A		
EUT Config.	802.11a on Y-Axis			Line AC / Freq	5.0 VDC		
Standard	CFR47 Part 15 Subpart C, RSS-247, RSS-GEN			RBW / VBW	1 MHz/ 3 MHz		
Dist/Ant Used	3m / DRH-118 & 1m / AHA-840			Performed by	Kerwinn Corpuz		

1 – 18 GHz Transmit at 5200 MHz

Frequency	Raw	Cable Loss	AF	Level	Detector	Polarity	Height	Azimuth	Limit	Margin
MHz	dBuV/m	dB	dB	dBuV/m		H/V	cm	deg	dBuV/m	dB
6926.54	47.03	3.18	-11.71	38.50	Avg	H	122	347	54.00	-15.50
14626.66	40.11	4.43	-6.77	37.77	Avg	H	207	82	54.00	-16.23
17982.67	38.08	5.03	2.05	45.16	Avg	H	239	260	54.00	-8.84

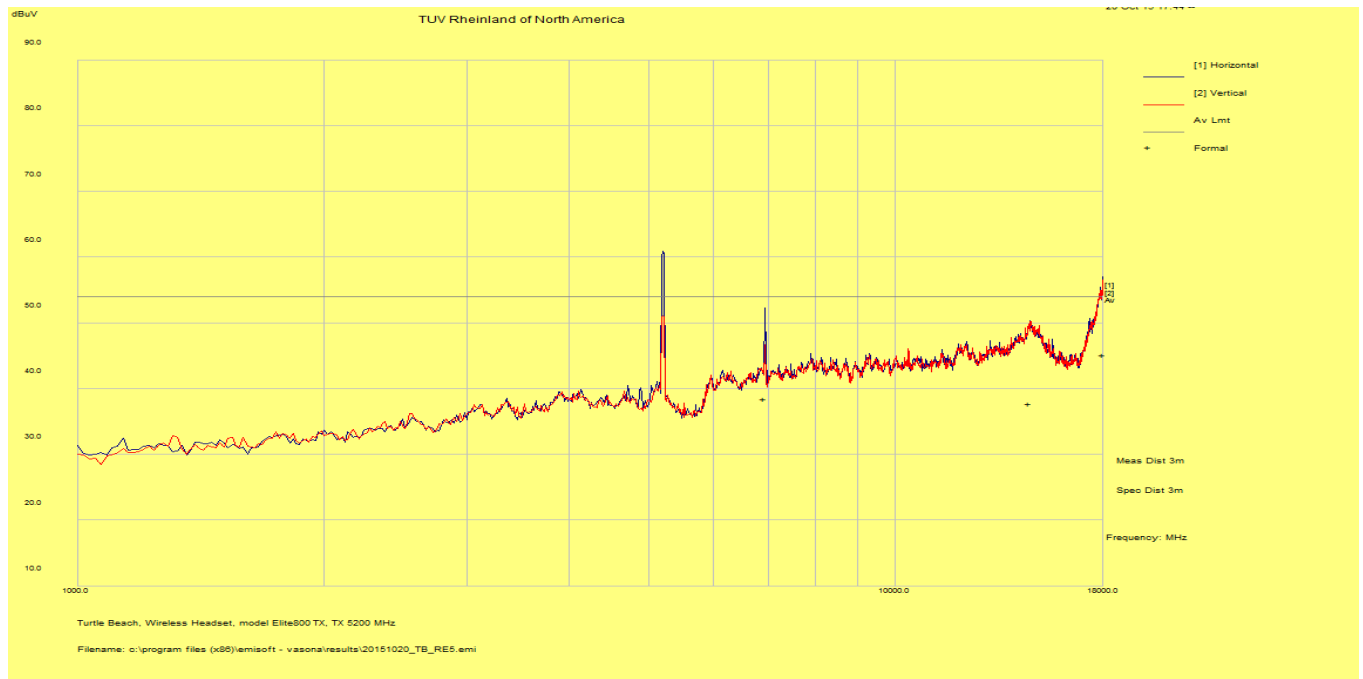

Spec Margin = Level - Limit, Level = Raw + Cbl + CF ± Uncertainty
 CF = Amp Gain + ANT Factor

Combined Standard Uncertainty $u_c(y) = \pm 4.52$ dB Expanded Uncertainty $U = k u_c(y)$ $k = 2$ for 95% confidence

Note: All emissions passed the spurious emission limit. No significant emission was observed from 1GHz to 40GHz. Emission above the limit is the Fundamental Frequency.

SOP 1 Radiated Emissions				Tracking # 31563518.001 Page 5 of 7			
EUT Name	Wireless Audio Transmitter			Date	October 23, 2015		
EUT Model	Elite 800 TX			Temp / Hum in	23° C / 35%rh		
EUT Serial	Q2391F3900063			Temp / Hum out	N/A		
EUT Config.	802.11a on Y-Axis			Line AC / Freq	5.0 VDC		
Standard	CFR47 Part 15 Subpart C, RSS-247, RSS-GEN			RBW / VBW	1 MHz/ 3 MHz		
Dist/Ant Used	3m / DRH-118 & 1m / AHA-840			Performed by	Kerwinn Corpuz		

18 – 40 GHz Transmit at 5200 MHz

Frequency	Raw	Cable Loss	AF	Level	Detector	Polarity	Height	Azimuth	Limit	Margin
MHz	dBuV/m	dB	dB	dBuV/m		H/V	cm	deg	dBuV/m	dB
34371.38	43.82	7.01	-12.44	38.39	Avg	H	146	332	54.00	-15.61
38594.50	45.78	7.55	-12.05	41.28	Avg	H	150	24	54.00	-12.72
39947.62	46.68	7.63	-13.52	40.79	Avg	V	172	178	54.00	-13.21

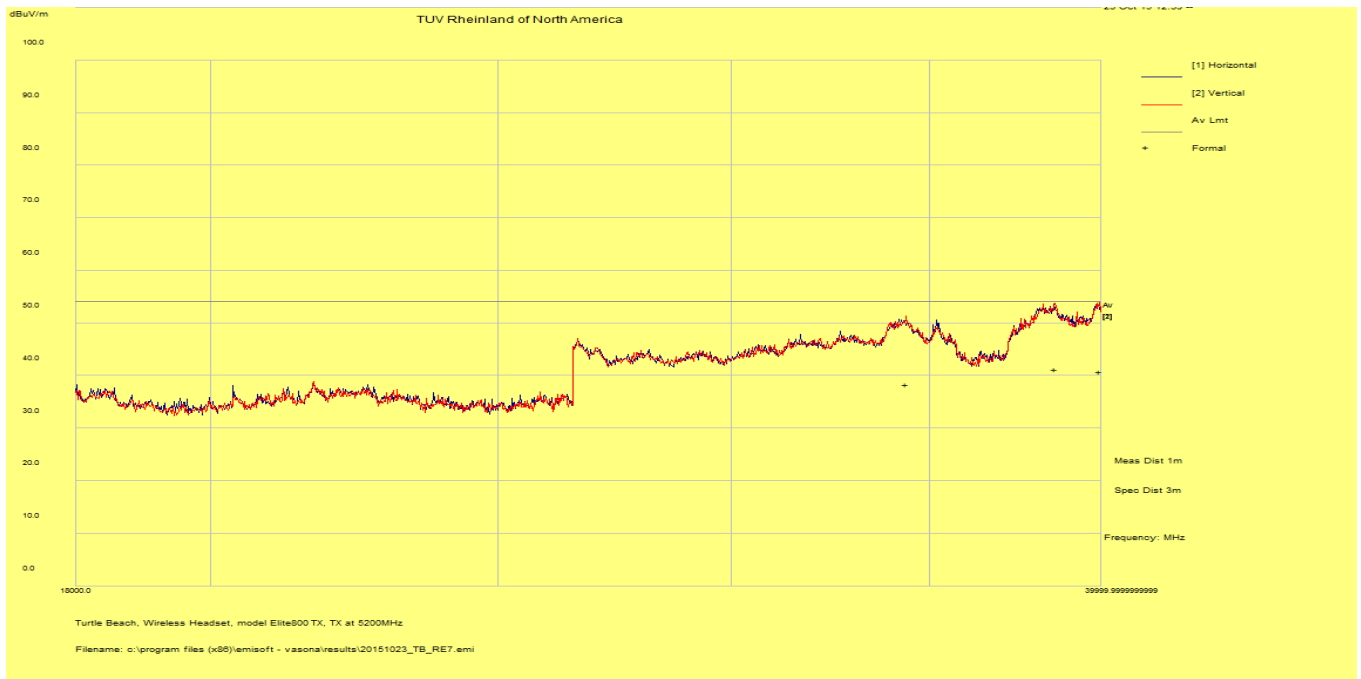

Spec Margin = Level - Limit, Level = Raw + Cbl + CF ± Uncertainty

CF = Amp Gain + ANT Factor

Combined Standard Uncertainty $u_c(y) = \pm 4.52$ dB Expanded Uncertainty $U = k u_c(y)$ $k = 2$ for 95% confidence

Note: All emissions passed the spurious emission limit. No significant emission was observed from 1GHz to 40GHz.

SOP 1 Radiated Emissions				Tracking # 31563518.001 Page 6 of 7			
EUT Name	Wireless Audio Transmitter			Date	October 20, 2015		
EUT Model	Elite 800 TX			Temp / Hum in	23° C / 37%rh		
EUT Serial	Q2391F3900063			Temp / Hum out	N/A		
EUT Config.	802.11a on Y-Axis			Line AC / Freq	5.0 VDC		
Standard	CFR47 Part 15 Subpart C, RSS-247, RSS-GEN			RBW / VBW	1 MHz/ 3 MHz		
Dist/Ant Used	3m / DRH-118 & 1m / AHA-840			Performed by	Kerwinn Corpuz		

1 – 18 GHz Transmit at 5240 MHz

Frequency	Raw	Cable Loss	AF	Level	Detector	Polarity	Height	Azimuth	Limit	Margin
MHz	dBuV/m	dB	dB	dBuV/m		H/V	cm	deg	dBuV/m	dB
6994.35	42.45	3.20	-11.50	34.16	Avg	H	121	334	54.00	-19.84
17981.06	38.07	5.03	2.02	45.12	Avg	H	199	260	54.00	-8.88
14727.46	40.28	4.38	-6.37	38.30	Avg	V	208	220	54.00	-15.70

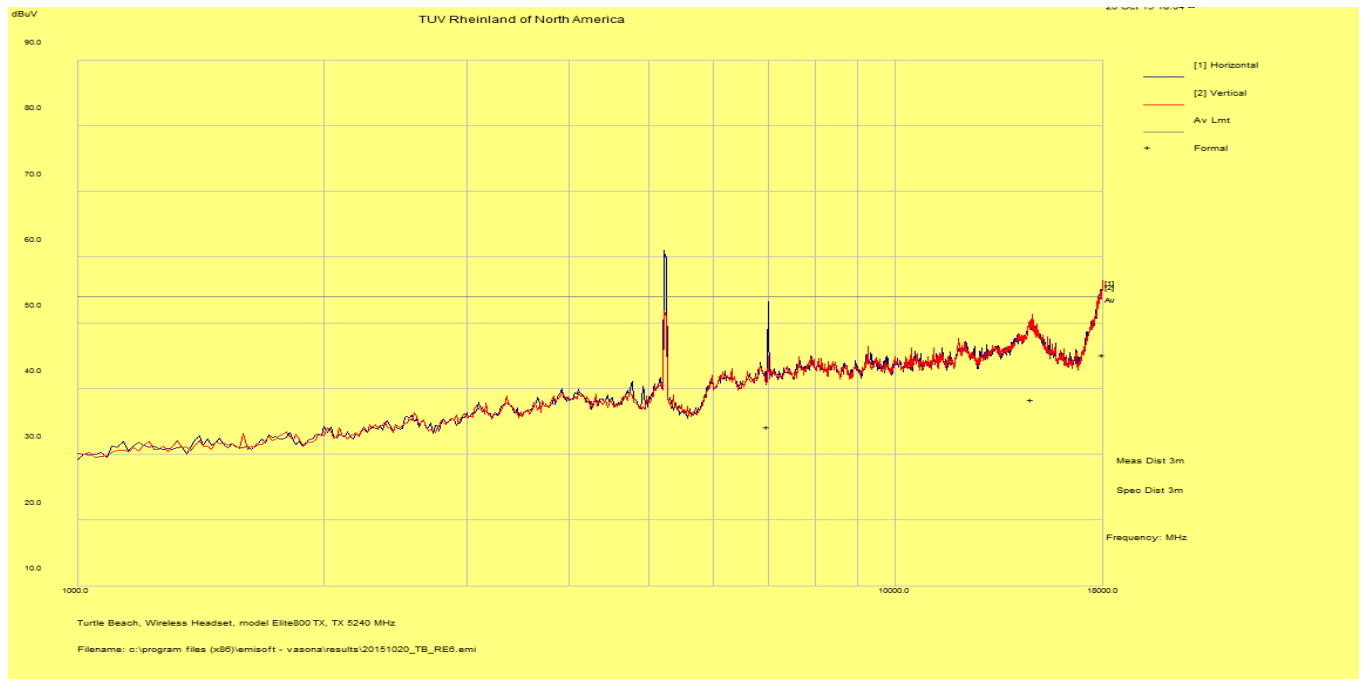

Spec Margin = Level - Limit, Level = Raw + Cbl + CF ± Uncertainty
 CF = Amp Gain + ANT Factor

Combined Standard Uncertainty $u_c(y) = \pm 4.52$ dB Expanded Uncertainty $U = k u_c(y)$ $k = 2$ for 95% confidence

Note: All emissions passed the spurious emission limit. No significant emission was observed from 1GHz to 40GHz. Emission above the limit is the Fundamental Frequency.

SOP 1 Radiated Emissions				Tracking # 31563518.001 Page 7 of 7			
EUT Name	Wireless Audio Transmitter			Date	October 23, 2015		
EUT Model	Elite 800 TX			Temp / Hum in	23° C / 35%rh		
EUT Serial	Q2391F3900063			Temp / Hum out	N/A		
EUT Config.	802.11a on Y-Axis			Line AC / Freq	5.0 VDC		
Standard	CFR47 Part 15 Subpart C, RSS-247, RSS-GEN			RBW / VBW	1 MHz/ 3 MHz		
Dist/Ant Used	3m / DRH-118 & 1m / AHA-840			Performed by	Kerwinn Corpuz		

18 – 40 GHz Transmit at 5240 MHz

Frequency	Raw	Cable Loss	AF	Level	Detector	Polarity	Height	Azimuth	Limit	Margin
MHz	dBuV/m	dB	dB	dBuV/m		H/V	cm	deg	dBuV/m	dB
38193.19	45.59	7.52	-12.00	41.11	Avg	H	148	106	54.00	-12.89
39890.53	47.18	7.63	-13.53	41.29	Avg	H	146	254	54.00	-12.71
34210.40	43.64	6.98	-12.43	38.19	Avg	V	171	92	54.00	-15.81

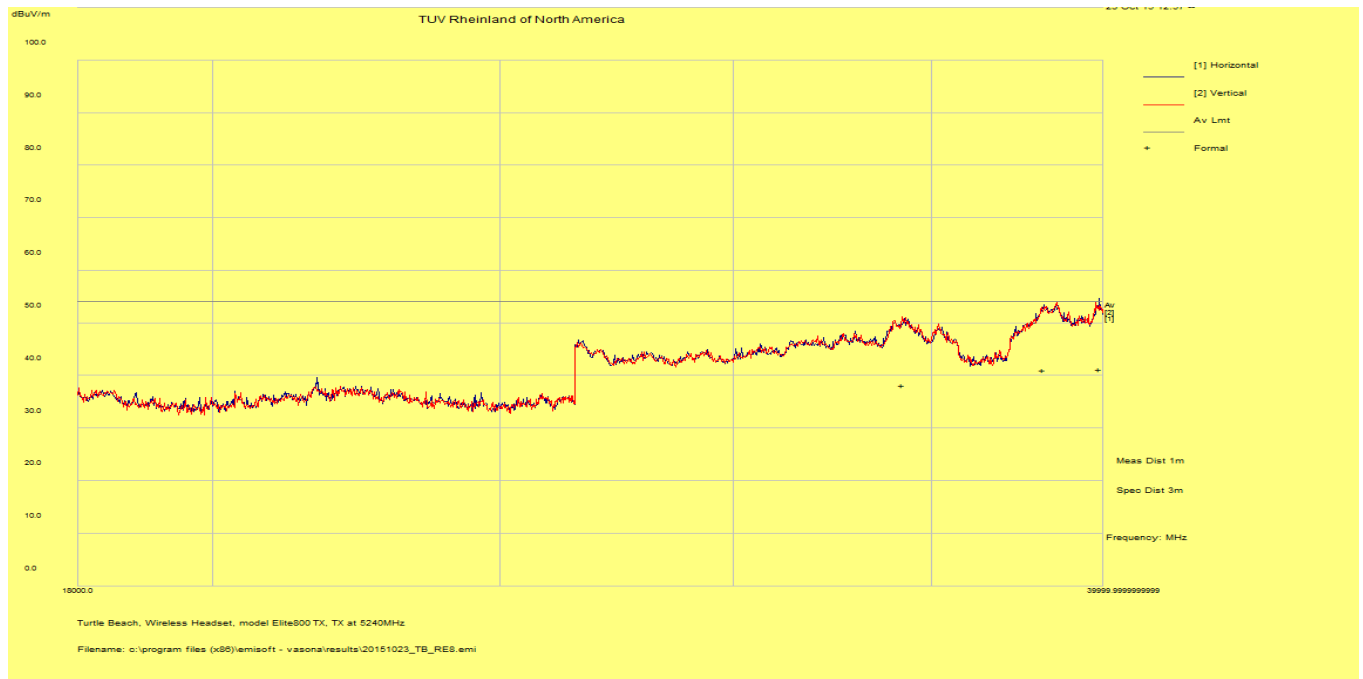

Spec Margin = Level - Limit, Level = Raw+ Cbl+ CF ± Uncertainty

CF= Amp Gain + ANT Factor

Combined Standard Uncertainty $u_c(y) = \pm 4.52$ dB Expanded Uncertainty $U = k u_c(y)$ $k = 2$ for 95% confidence

Note: All emissions passed the spurious emission limit. No significant emission was observed from 1GHz to 40GHz.

4.5.4 Sample Calculation

The field strength is calculated by subtracting the Amplifier Gain and adding the Cable Loss and Antenna Correction Factor to the measured reading. The basic equation is as follows:

$$\text{Level (dB}\mu\text{V/m)} = \text{Raw} - \text{AMP} + \text{CBL} + \text{ACF}$$

Where: Raw = Field Intensity Meter (dB μ V)
AMP = Amplifier Gain (dB)
CBL = Cable Loss (dB)
ACF = Antenna Correction Factor (dB/m)

$$\mu\text{V/m} = 10^{\frac{\text{dB}\mu\text{V} / \text{m}}{20}}$$

4.6 AC Conducted Emissions

Testing was performed in accordance with ANSI C63.4: 2014. These test methods are listed under the laboratory's A2LA Scope of Accreditation.

This test measures the levels emanating from the EUT's AC input port, thus evaluating the potential for the EUT to cause radio frequency interference to other electronic devices.

The AC conducted emissions of equipment under test shall not exceed the values in CFR47 Part 15.207: 2015 and RSS-GEN Sect. 8.8: 2014.

4.6.1 Test Methodology

A test program that controls instrumentation and data logging was used to automate the AC Power Line Conducted emission test procedure. The frequency range of interest was divided into sub-ranges such as to yield a frequency resolution of 9 kHz. Each phase and neutral of the AC power line were measured with respect to ground. Measurements were performed using a set of 50µH / 50Ω LISNs.

Testing is either performed in Lab 5. The setup photographs clearly identify which site was used. The vertical ground plane used in the semi-anechoic chamber is a 2m x 2m solid aluminum frame and panel, and it is bonded to the horizontal ground plane.

In the case of tabletop equipment, the EUT is placed on a 1.0m x 1.5m non-conductive table 80cm above the ground plane and 40cm from a vertical ground reference plane. The rear of the EUT was positioned flush with the backside of the table and directly over the LISNs. The power and I/O cables were routed over the edge of the table and bundled approximately 40cm from the ground plane. Support equipment was powered from a separate LISN.

4.6.1.1 Deviations

There were no deviations from this test methodology.

4.6.2 Test Results

As originally tested, the EUT was found to be compliant to the requirements of the test standard(s).

Table 7: AC Conducted Emissions – Test Results

Test Conditions: Conducted Emissions		Test Date: January 05, 2016
Antenna Type: Integrated		Power Setting: SPW 0
Antenna Gain: +3.5 dBi		Signal State: Modulated
Ambient Temp.: 22 °C		Relative Humidity: 35%
Configuration	Frequency Range	Test Result
Line 1 (Hot)	0.15 to 30 MHz	Pass
Line 2 (Neutral)	0.15 to 30 MHz	Pass

SOP 2 Conducted Emissions						Tracking # 31563518.001 Page 1 Of 4			
EUT Name		Wireless Audio Transmitter				Date		January 05, 2016	
EUT Model		Elite 800 TX				Temp / Hum in		22° C / 35% rh	
EUT Serial		Q2391F3900063				Temp / Hum out		N/A	
EUT Config.		802.11a on Y-Axis				Line AC / Freq		120Vac/60Hz	
Standard		CFR47 Part 15.207 and RSS Gen				RBW / VBW		9 kHz / 30 kHz	
Lab/LISN		Lab #5 /Com-Power, Line 1				Performed by		Kerwinn Corpuz	
Frequency	Raw	Limiter	Ins. Loss	Level	Detector	Line	Limit	Margin	Result
MHz	dBuV	dB	dB	dBuV		Line	dBuV	dB	
0.175	37.88	9.95	0.19	48.02	QP	Live	64.72	-16.70	Pass
0.175	34.57	9.95	0.19	44.71	Ave	Live	54.72	-10.01	Pass
0.190	36.73	9.95	0.18	46.86	QP	Live	64.02	-17.16	Pass
0.190	26.66	9.95	0.18	36.79	Ave	Live	54.02	-17.23	Pass
0.317	32.83	9.96	0.11	42.91	QP	Live	59.78	-16.88	Pass
0.317	31.89	9.96	0.11	41.97	Ave	Live	49.78	-7.82	Pass
0.588	29.28	9.98	0.08	39.34	QP	Live	56.00	-16.66	Pass
0.588	32.69	9.98	0.08	42.75	Ave	Live	46.00	-3.25	Pass
0.748	26.82	9.98	0.07	36.87	QP	Live	56.00	-19.13	Pass
0.748	18.99	9.98	0.07	29.04	Ave	Live	46.00	-16.96	Pass
0.806	26.03	9.98	0.07	36.08	QP	Live	56.00	-19.92	Pass
0.806	24.93	9.98	0.07	34.98	Ave	Live	46.00	-11.02	Pass
Spec Margin = QP./Ave. - Limit, ± Uncertainty									
Combined Standard Uncertainty $u_c(y) = \pm 1.2$ dB Expanded Uncertainty $U = k u_c(y)$ $k = 2$ for 95% confidence									
Notes: EUT was setup as table top equipment and transmitted at 5200 MHz in 802.11a. USB port on EUT connected to USB port on laptop and laptop powered with 120 Vac supply.									

SOP 2 Conducted Emissions

Tracking # 31563518.001 Page 2 of 4

EUT Name	Wireless Audio Transmitter	Date	January 05, 2016
EUT Model	Elite 800 TX	Temp / Hum in	22° C / 35% rh
EUT Serial	Q2391F3900063	Temp / Hum out	N/A
EUT Config.	802.11a on Y-Axis	Line AC	120Vac/60Hz
Standard	CFR47 Part 15.207 and RSS Gen	RBW / VBW	9 kHz / 30 kHz
Lab/LISN	Lab #5 /Com-Power, Line 1	Performed by	Kerwinn Corpuz

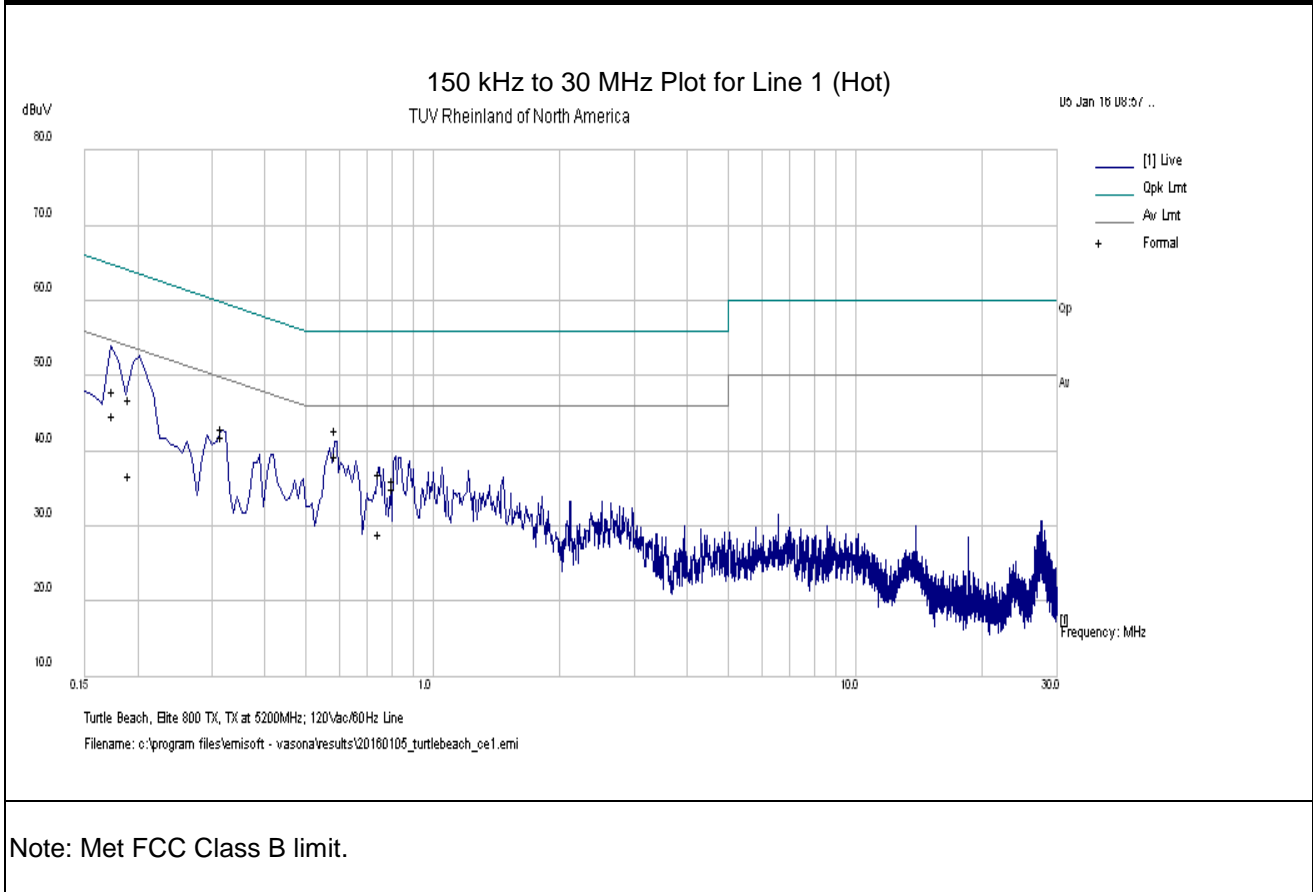

SOP 2 Conducted Emissions						Tracking # 31563518.001 Page 3 Of 4			
EUT Name		Wireless Audio Transmitter				Date		January 05, 2016	
EUT Model		Elite 800 TX				Temp / Hum in		22° C / 35% rh	
EUT Serial		Q2391F3900063				Temp / Hum out		N/A	
EUT Config.		802.11a on Y-Axis				Line AC / Freq		120Vac/60Hz	
Standard		CFR47 Part 15.207 and RSS Gen				RBW / VBW		9 kHz / 30 kHz	
Lab/LISN		Lab #5 /Com-Power, Line 2				Performed by		Kerwinn Corpuz	
Frequency	Raw	Limiter	Ins. Loss	Level	Detector	Line	Limit	Margin	Result
MHz	dBuV	dB	dB	dBuV		Line	dBuV	dB	
0.150	39.13	9.94	0.23	49.30	QP	Neutral	66.00	-16.70	Pass
0.150	27.72	9.94	0.23	37.89	Ave	Neutral	56.00	-18.11	Pass
0.197	40.86	9.95	0.17	50.98	QP	Neutral	63.73	-12.74	Pass
0.197	30.54	9.95	0.17	40.66	Ave	Neutral	53.73	-13.07	Pass
0.418	24.34	9.96	0.09	34.39	QP	Neutral	57.48	-23.09	Pass
0.418	14.65	9.96	0.09	24.71	Ave	Neutral	47.48	-22.77	Pass
0.563	28.21	9.98	0.08	38.27	QP	Neutral	56.00	-17.73	Pass
0.563	22.81	9.98	0.08	32.87	Ave	Neutral	46.00	-13.13	Pass
0.663	22.62	9.98	0.07	32.67	QP	Neutral	56.00	-23.33	Pass
0.663	16.83	9.98	0.07	26.88	Ave	Neutral	46.00	-19.12	Pass
0.834	21.21	9.98	0.07	31.26	QP	Neutral	56.00	-24.74	Pass
0.834	14.57	9.98	0.07	24.62	Ave	Neutral	46.00	-21.38	Pass
Spec Margin = QP./Ave. - Limit, ± Uncertainty									
Combined Standard Uncertainty $u_c(y) = \pm 1.2$ dB Expanded Uncertainty $U = k u_c(y)$ $k = 2$ for 95% confidence									
Notes: EUT was setup as table top equipment and transmitted at 5200 MHz in 802.11a. USB port on EUT connected to USB port on laptop and laptop powered with 120 Vac supply.									

SOP 2 Conducted Emissions

Tracking # 31563518.001 Page 4 of 4

EUT Name	Wireless Audio Transmitter	Date	January 05, 2016
EUT Model	Elite 800 TX	Temp / Hum in	22° C / 35% rh
EUT Serial	Q2391F3900063	Temp / Hum out	N/A
EUT Config.	802.11a on Y-Axis	Line AC	120Vac/60Hz
Standard	CFR47 Part 15.207 and RSS Gen	RBW / VBW	9 kHz / 30 kHz
Lab/LISN	Lab #5 /Com-Power, Line 2	Performed by	Kerwinn Corpuz

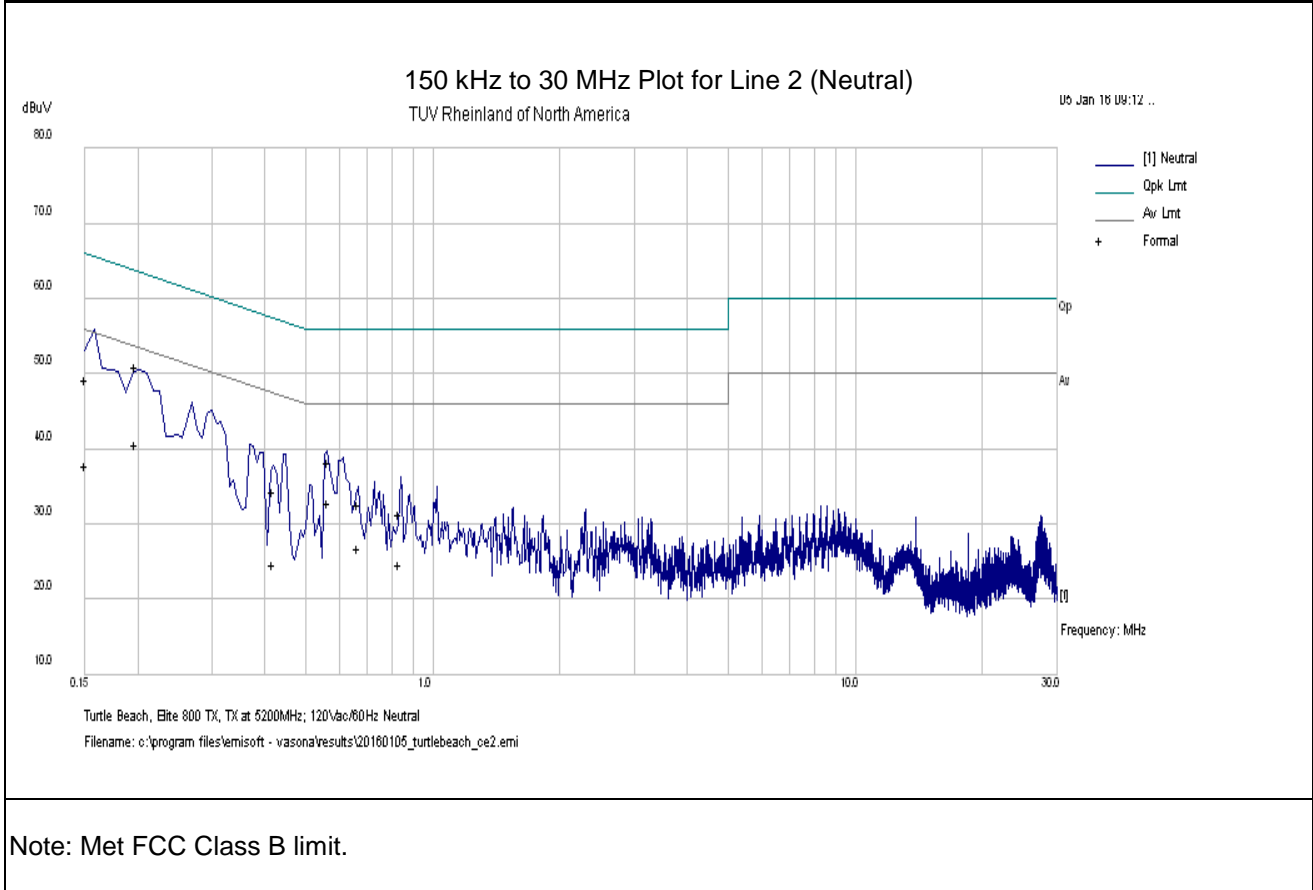

4.7 Frequency Stability

In accordance with 47 CFR Part 15.407(g) and RSS GEN Sect. 6.11 the frequency stability of U-NII devices must be such that an emission is maintained within the band of operation under all conditions of normal operation as specified in the user's manual. The Manufacturer calls out operating temperature ranges of +0° to +50° C

4.7.1 Test Methodology

The manufacturer of the equipment is responsible for ensuring that the frequency stability is such that emissions are always maintained within the band of operation under all conditions. This test performs according to ANSI C63.10-2013 Section 6.8

4.7.2 Manufacturer Declaration

The frequency stability of the reference oscillator sets the frequency stability of the RF transceiver signals. Therefore all of the RF signal should have ± 20 ppm stability.

This stability accounts for room temp tolerance of the crystal oscillator circuit, frequency variation across temperature, and crystal ageing.

Worst case:

5GHz - ± 20 ppm/103 kHz

± 20 ppm at 5 GHz translates to a maximum frequency shift of ± 103 kHz. As the edge of the channels are at least one MHz from either of the band edges, ± 103 kHz is more than sufficient to guarantee that the intentional emission will remain in the band over the entire operating range of the radio.

4.7.3 Limit

CFR47 Part 407(g) - Manufacturers of U-NII devices are responsible for ensuring frequency stability such that an emission is maintained within the band of operation under all conditions of normal operation as specified in the user's manual.

4.7.4 Test results

As originally tested, the EUT was found to be compliant to the requirements of the test standard(s) since the maximum frequency drift was 17.668 ppm.

Table 8: Frequency Stability – Test Results

Temperature	Time	PPM
0° C	Start	9.735577
	2 Min.	5.769231
	5 Min	11.17788
	10 min	10.09615
10° C	Start	6.850962
	2 Min.	8.653846
	5 Min	5.408654
	10 min	7.211538
20° C	Start	7.572115
	2 Min.	7.572115
	5 Min	5.408654
	10 min	0.721154
30° C	Start	4.6875
	2 Min.	8.293269
	5 Min	2.524038
	10 min	0.721154
40° C	Start	0.721154
	2 Min.	2.884615
	5 Min	14.42308
	10 min	17.66827
50° C	Start	2.524038
	2 Min.	1.081731
	5 Min	7.211538
	10 min	10.09615

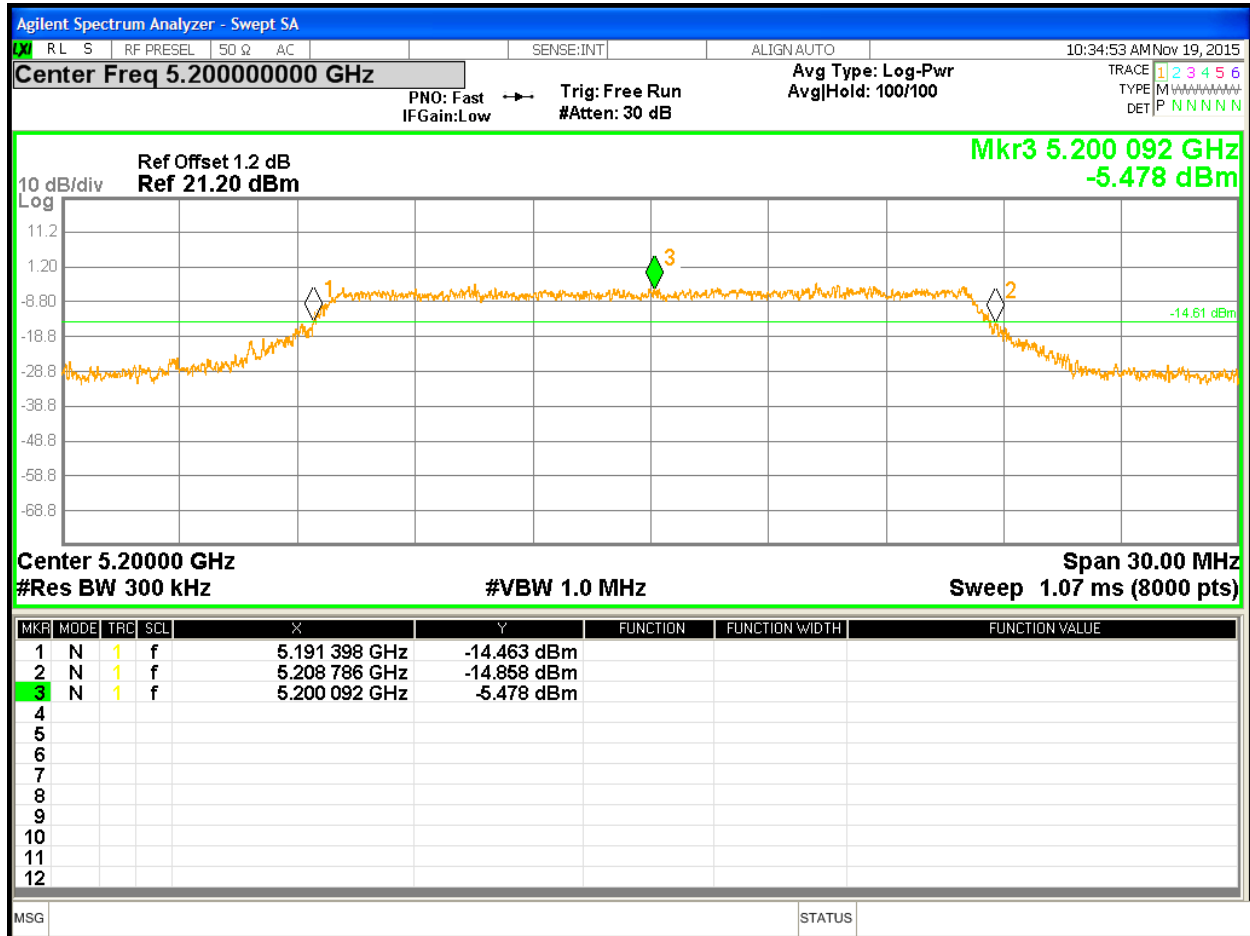

Figure 25: Frequency Stability – Worst Case

4.8 Voltage Variation

In accordance with 47 CFR Part 15.31 (e) intentional radiators, measurements of the variation of the input power or the radiated signal level of the fundamental frequency component of the emission, as appropriate, shall be performed with the supply voltage varied between 85% and 115% of the nominal rated supply voltage. For battery operated equipment, the equipment tests shall be performed using a new battery.

4.8.1 Test Methodology

The ac supply voltage was varied between 85% and 115% of the nominal rated supply voltage. The fundamental frequency was observed during the variation. The device was powered 5.0 Vdc by programmable power supply. The voltage was varied from 4.25 Vdc to 5.75 Vdc mean while the fundamental frequencies were observed and record for the maximum drift in ppm; part per millions.

4.8.2 Test results

As originally tested, the EUT was found to be compliant to the requirements of the test standard(s). The fundamental frequencies drifted less than ± 20 ppm.

Table 9: Voltage Variation – Test Results

Frequency MHz	Nominal (5.0Vdc) ppm	Lo Voltage (4.25Vdc) ppm	Hi Voltage (5.75Vdc) ppm	Max Drift ppm
5200	13.34135	15.86538	14.78365	15.86538

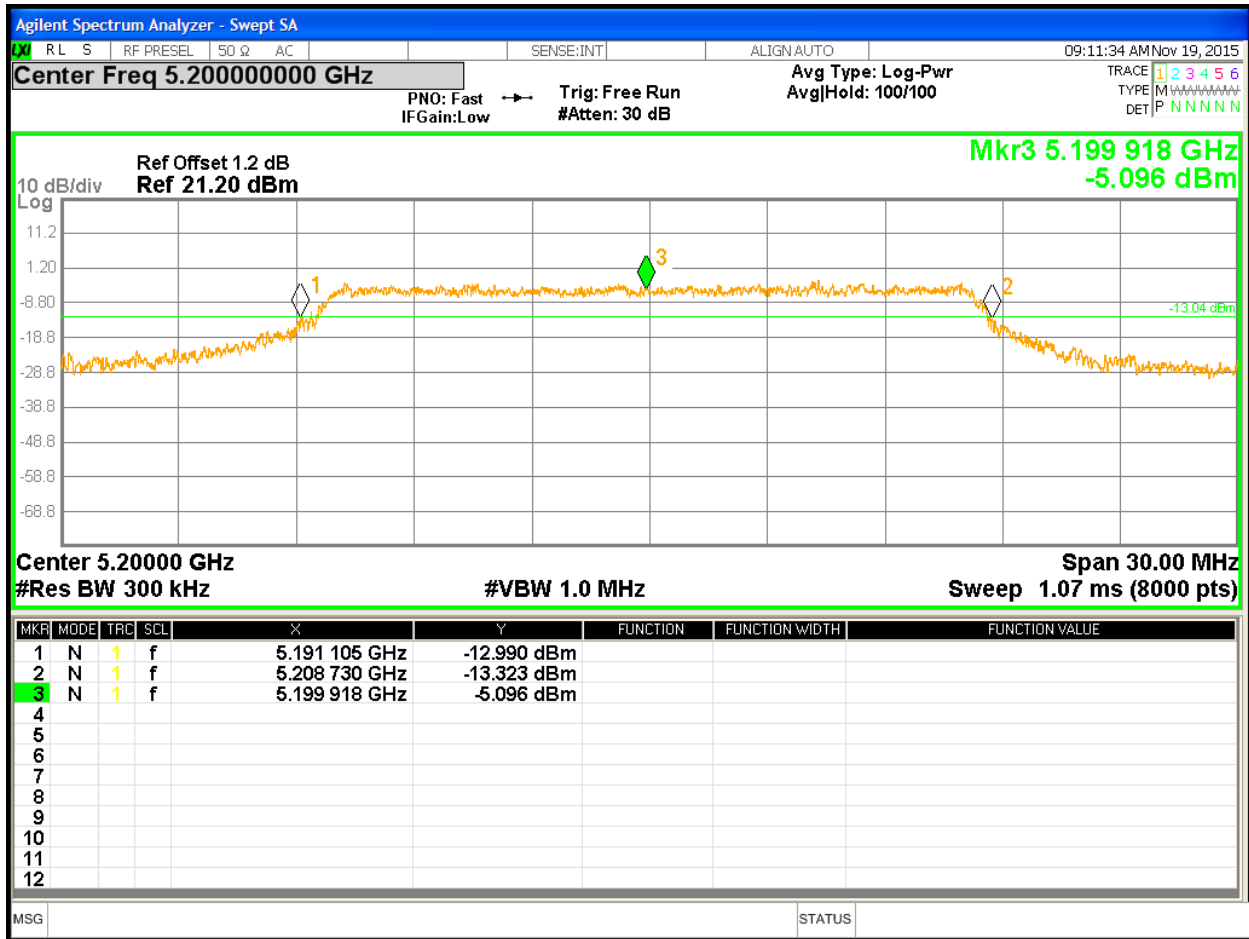

Figure 26: Voltage Variation – Worst Case

4.9 Maximum Permissible Exposure

4.9.1 Test Methodology

In this section, we try to prove the safety of radiation harmfulness to the human body for our product. The KDB 447498 D01 General RF Exposure Guidance is followed. The Gain of the antenna used in this calculation is declared by the manufacturer, and the maximum average power input to the antenna is measured. Using the general SAR test exclusion guidance in Section 4.3 of KDB 447498, we show the device meeting the SAR exclusion threshold.

4.9.2 FCC KDB 447498 D01 – General SAR Test Exclusion Guidance

The SAR exclusion threshold conditions are listed:

- 1) The 1-g and 10-g SAR test exclusion thresholds for 100 MHz to 6 GHz at test separation distances ≤ 50 mm are determined by:
[(max. power of channel, including tune-up tolerance, mW)/(min. test separation distance, mm)] · $[\sqrt{f(\text{GHz})}] \leq 3.0$ for 1-g SAR and ≤ 7.5 for 10-g extremity SAR,16 where
 - f(GHz) is the RF channel transmit frequency in GHz
 - Power and distance are rounded to the nearest mW and mm before calculation17
 - The result is rounded to one decimal place for comparison

The test exclusions are applicable only when the minimum test separation distance is ≤ 50 mm and for transmission frequencies between 100 MHz and 6 GHz. When the minimum test separation distance is < 5 mm, a distance of 5 mm is applied to determine SAR test exclusion.

- 2) At 100 MHz to 6 GHz and for test separation distances > 50 mm, the SAR test exclusion threshold is determined according to the following, and as illustrated in Appendix B:18
 - a) [Threshold at 50 mm in step 1) + (test separation distance - 50 mm) · (f(MHz)/150)] mW, at 100 MHz to 1500 MHz
 - b) [Threshold at 50 mm in step 1) + (test separation distance - 50 mm) · 10] mW at > 1500 MHz and ≤ 6 GHz
- 3) At frequencies below 100 MHz, the following may be considered for SAR test exclusion, and as illustrated in Appendix C:19
 - a) The threshold at the corresponding test separation distance at 100 MHz in step 2) is multiplied by $[1 + \log(100/f(\text{MHz}))]$ for test separation distances > 50 mm and < 200 mm
 - b) The threshold determined by the equation in a) for 50 mm and 100 MHz is multiplied by $\frac{1}{2}$ for test separation distances ≤ 50 mm
 - c) SAR measurement procedures are not established below 100 MHz. When SAR test exclusion cannot be applied, a KDB inquiry is required to determine SAR evaluation requirements for any test results to be acceptable.

4.9.3 EUT Operating Condition

The software provided by Manufacturer enabled the EUT to transmit data at lowest, middle and highest channel individually.

4.9.4 Classification

The antenna of the product, under normal use condition, is less than 20cm away from the body of the user. This device is classified as a **Portable Device**. It is intended to be with head wear device; extremity SAR limit is applied.

4.9.5 SAR Test Exclusion Threshold

4.9.5.1 Antenna Gain

The transmitting antenna was integrated. The 5 GHz antenna gain was +3.5 dBi or 2.24 (numeric).

4.9.5.2 SAR Exclusion Threshold Calculation

Mode	Max. Power (dBm)	EIRP (dBm)	Min. Separation Distance (cm)	Cal. Excl. Threshold	1-g SAR Limit	10-g extremity SAR Limit	Result
802.11A (5GHz)	8.85	12.35	20	1.968111	≤3.0	≤7.5	Exempted *
Note: 1. Per manufacture the separation between the transmitter antenna and user is less than 20cm. This separation distance was used for calculation per condition #1 of SAR Exclusion Threshold. 2. The maximum output power was taken from Table 2. 3. (*) The calculated threshold is less than 3.0; therefore, EUT is SAR exempted for head and body usage.							

5 Test Equipment Use List

5.1 Equipment List

Equipment	Manufacturer	Model #	Serial/Inst #	Last Cal mm/dd/yyyy	Next Cal mm/dd/yyyy
Bilog Antenna	Sunol Sciences	JB3	A102606	07/08/2014	07/08/2016
Horn Antenna	Sunol Sciences	DRH-118	A040806	02/10/2015	02/10/2016
Antenna (18-26GHz)	CMT	RA42-K-F-4B-C	020131-004	07/24/2014	07/24/2015
Antenna (18-40 GHz)	Com-Power	AHA-840	105005	07/08/2015	07/08/2016
Spectrum Analyzer	Rohde & Schwarz	FSL6	100169	01/13/2015	01/13/2016
Spectrum Analyzer	Agilent	N9038A	MY51210195	01/12/2015	01/12/2016
Spectrum Analyzer	Agilent	N9030A	MY51380689	01/19/2015	01/19/2016
Spectrum Analyzer	Rohde Schwarz	ESIB	832427/002	01/13/2015	01/13/2016
Spectrum Analyzer	Rohde Schwarz	FSV40	1321.3008K40	11/01/2015	11/01/2016
Amplifier	Sonoma Instruments	310	185516	01/13/2015	01/13/2016
Amplifier	Miteq	TTA1800-30-4G	1842452	01/13/2015	01/13/2016
Amplifier	Rohde & Schwarz	TS-PR26	100011	07/24/2014	07/24/2016
Amplifier	Rohde & Schwarz	TS-PR40	100012	02/21/2015	02/21/2016
Power Meter	Agilent	E4418B	MY45103902	01/15/2015	01/15/2016
Power Sensor	Hewlett Packard	8482A	US37295801	01/15/2015	01/15/2016
Thermo Chamber	Espec	BTZ-133	0613436	03/16/2015	03/16/2016
DC Power Supply	Agilent	E3634A	MY400004331	01/12/2015	01/12/2016
Notch Filter	Micro-Tronics	BRM50716	003	01/30/2015	01/30/2016
Signal Generator	Anritsu	MG3694A	42803	01/13/2015	01/13/2016
Signal Generator	Rohde & Schwarz	SMBV100A	1407.6004K02	12/04/2014	12/04/2015
Power Sensors	Rohde & Schwarz	OSP120	1520.9010.02	12/19/2014	12/14/2015

* Calibration of equipment past due for re-calibration will be performed expeditiously. If any equipment is found to be out of tolerance at that time, affected customers will be notified accordingly.

6 EMC Test Plan

6.1 Introduction

This section provides a description of the Equipment Under Test (EUT), configurations, operating conditions, and performance acceptance criteria. It is an overview of information provided by the manufacturer so that the test laboratory may perform the requested testing.

6.2 Customer

Table 10: Customer Information

Company Name	Voyetra Turtle Beach, Inc.
Address	100 Summit Lake Drive, Suite 100
City, State, Zip	Valhalla, New York 10595
Country	U.S.A.

Table 11: Technical Contact Information

Name	Tim Blaney
E-mail	tim@commcepts.net
Phone	(530) 277-3482

6.3 Equipment Under Test (EUT)

Table 12: EUT Specifications

EUT Specifications	
Package Dimensions	165mm (6.5”) x 106mm (4.18”) x 318mm (1.25”)
Input Voltage	5 Vdc (via host USB port)
Environment	Indoor
Operating Temperature Range:	0 to 50 degrees C
Multiple Feeds:	<input type="checkbox"/> Yes and how many <input checked="" type="checkbox"/> No
Hardware Version	PP V4.1 (FXCN China Factory Model)
Part Number	39EEE9 ES2
RF Software Version	NA
802.11a Radio	
Operating Mode	802.11a
Transmitter Frequency Band	5.15 GHz to 5.25 GHz
Operating Channel	5180 MHz, 5200 MHz, 5220 MHz, 5240 MHz
Max. Power Output	8.85 dBm
Power Setting @ Operating Channel	SPW 0
Antenna Type	(1) integrated PCB antenna
Antenna Gain	Ant1 = 3.5 dBi
Modulation Type	<input type="checkbox"/> AM <input type="checkbox"/> FM <input type="checkbox"/> DSSS <input checked="" type="checkbox"/> OFDM <input type="checkbox"/> Other describe:
Data Rate	6, 9, 12, 18, 24 Mbps
Type of Equipment	<input checked="" type="checkbox"/> Table Top <input type="checkbox"/> Wall-mount <input type="checkbox"/> Floor standing cabinet <input type="checkbox"/> Other:
Directional Gain Type	<input checked="" type="checkbox"/> Uncorrelated <input checked="" type="checkbox"/> Non-Beam Forming <input type="checkbox"/> Other describe:
Note: This report only documents the radio characteristics for 5150 – 5250 MHz bands.	

Table 13: Interface Specifications

Interface Type	Cabled with what type of cable?	Is the cable shielded?	Maximum potential length of the cable?	Metallic (M), Coax (C), Fiber (F), or Not Applicable?
USB	USB	<input checked="" type="checkbox"/> No	<input checked="" type="checkbox"/> Metric: 1 m	<input checked="" type="checkbox"/> M
Digital In	Optical	<input checked="" type="checkbox"/> No	<input checked="" type="checkbox"/> Metric: 2 m	<input checked="" type="checkbox"/> F
Digital Out	Optical	<input checked="" type="checkbox"/> No	<input checked="" type="checkbox"/> Metric: 2 m	<input checked="" type="checkbox"/> F

Table 14: Supported Equipment

Equipment	Manufacturer	Model	Serial	Used for
Laptop	Dell	Latitude D820	42166613629	Setup EUT operating channel
Interface Board	Turtle Beach	N.A	N.A	Access 5GHz radio chipset
Note: None.				

Table 15: Description of Sample used for Testing

Device	Serial	RF Connection	CFR47 Part 15.407
Elite 800 TX	Q2391F390 0063	Integrated Antenna	Radiated Emissions Conducted Emissions
	Q3391F380 0149	Direct via SMA Connection	Peak Transmit Power, Peak Power Spectral Density, Occupied Bandwidth, Spurious Emissions, Frequency Stability, Voltage Variation

Table 16: Description of Test Configuration used for Radiated Measurement.

Device	Antenna	Mode	Setup Photo (X-Axis)	Setup Photo (Y-Axis)	Setup Photo (Z-Axis)
Elite 800 TX	Integrated	Transmit	EUT laid flat	N/A	N/A
Note: The Elite 800 TX is designed and intended to be laid flat. All emission scans performed on the X-Axis.					

Table 17: Final Test Mode for 5150 - 5250 Bands

Test	802.11a
Occupied Bandwidth FCC Part 15.407(a), RSS-GEN Sect. 6.6	5180, 5200, 5240 MHz at 6Mbps
Output Power FCC Part 15.407(a)(1)(iv), RSS-247 Sect. 6.2.1.1	5180, 5200, 5240 MHz at 6Mbps
Peak Power Spectral Density FCC Part 15.407(a)(1)(iv), RSS-247 Sect. 6.2.1.1	5180, 5200, 5240 MHz at 6Mbps
Band-Edge (Radiated) FCC Part 15.205, 15.209, 15.407(b)	5180, 5240 MHz at 6Mbps
Transmitted Spurious Emission (30 MHz – 1GHz) FCC Part 15.205, 15.209, 15.407(b)	5200 MHz at 6 Mbps
Transmitted Spurious Emission (Above 1GHz) FCC Part 15.205, 15.209, 15.407(b)	5180, 5200, 5240 MHz at 6Mbps
Conducted Spurious Emission (antenna port). FCC Part 15.407 (b)	According to CFR47 15.407 (b) EIPR shall not exceed -27 dBm/MHz. This is equivalent to the field strength of 68.2dBuV/m at 3 meter distance. The EUT is satisfied the requirement by meeting the limit under CFR47 Part 15.209.
AC Conducted Emission FCC Part 15.207	EUT is powered by 5.0 VDC via host USB port.
Frequency Stability FCC Part 15.407 (g)	5200 MHz at 6 Mbps
Voltage Variation FCC Part 15.31 (e)	5200 MHz at 6 Mbps
Dynamic Frequency Selection FCC Part 15.407 (h)	5150 – 5250 MHz band does not support DFS.
Transmitted Spurious Emission (Above 1GHz) FCC Part 15.205, 15.209, 15.407(b)	5180, 5200, 5240 MHz at 6Mbps
<p>Note:</p> <ol style="list-style-type: none"> 1. Band 5150 MHz – 5250 MHz support only 802.11a. 2. All radiated emission performed on Y-Axis. 3. All tests were pre-scanned for worst case before final testing. 	

6.4 Test Specifications

Testing requirements

Table 18: Test Specifications

Emissions and Immunity	
Standard	Requirement
CFR 47 Part 15.407: 2015	All
RSS-247 Issue 1, 2015	All

END OF REPORT